

For Parts Call 606-678-9623 or 606-561-4983

rotary®

2014 CATALOG

- ✓ Over 9,000 quality parts
- ✓ 250 new items for 2014
- ✓ Photos & descriptions

your best source for
GUARANTEED QUALITY PARTSSM



OUTDOOR POWER EQUIPMENT PARTS, TOOLS & ACCESSORIES

www.mymowerparts.com

CONTENTS

Class	Page No.	Class	Page No.
	NEW ITEMS FOR 2014	26	Starters & Recoil Springs607-634 Starter Assemblies, Pinion Gears, Pulleys, etc.
01	Displays/Assortments	27	Trimmer/Brushcutter Accessories635-661 Trimmer Line, Blades, Shafts, Heads, Handles, Filters, etc.
02	Refills For Assortments	28	Grass Catchers & Accessories662-664
03	Throttle & Brake Controls	29	Tiller Parts665-668
	Throttle Controls, Brake & Clutch Controls Inner Wire, Conduit, Clips, Wire Stops	30	OEM Replacement669-1055 AYP, Ariens, Bolens, etc. (listed By Manufacturer)
04	Go-Kart/Mini Bike Accessories	31	Ignition
	Clutches, Brake Cables, Sprockets, etc.		Batteries, Points, Condensers, Coils, Solenoids, Switches, Keys, Flywheel Keys Solid State, Electronic, etc.
05	Drive Parts	32	Tools
	Disc, Roller, Sprockets, Shafts, Gears, Seals, Gaskets	33	Lawn and Garden Accessories
06	Wheels - Steel	34	Chain Saw Chain
07	Wheels - Plastic	35	Chain Saw Bars
08	Tires, Tubes & Hubs	36	Chain Saw Sprockets
09	Bearings & Bushings	37	Chain Saw Springs
	Ball, Roller Cage, Needle Bearings, Bushings, Bearing Retainers	38	Chain Saw Carburetion
10	Deck & Wheel Parts	39	Chain Saw Accessories
	Caster Yokes, Deck Springs, Steering Components, Handles/Grips & Brackets, Height Adj., Wheel Bolts & Bushings	41	Snow Blower Accessories
11	Roller Chain & Links	42	Transmissions & Accessories
12	Belts Universal & O.E.M. Replacement	48	Pressure Washer Parts
13	Pulleys	50	Sales Promotion & Service Aids
	"V" Idlers, Flat Idlers, Sprocket Idlers Steel, Cast Iron Pulleys		Cross Reference.....
14	Universal Lawnmower Blades		Aftermarket Cross Ref.....
15	O.E.M. Replacement Blades		Carb. Kit Application Guide
16	Edger Blades & Shafts		For Saws, Trimmers, Blowers, etc.
17	Blade Adaptors		OEM Belt Cross Ref.
	Blade hubs, Bolts, Washers, etc.		Spark Plug Cross Ref.
18	Mufflers		Blade Listing By Length
19	Air, Oil & Fuel Filters		Engine hp Ref. Guide
20	Fuel Line & Accessories		Quick Ref. Chart B&S
	Fuel Caps, Clamps, Fittings, etc.		Quick Ref. Chart Lawnboy
21	Seats		Quick Ref. Chart Kohler
	Seats and Seat Covers		Quick Ref. Chart Tecumseh
22	Small Engine Carburetion		Pricing/Page Ref
	Diaphragms, Carb. Kits, Gov. Springs		Index
23	Engine Parts		
	Tune-Up Kits, Overhaul Kits, Oil Seals Piston Rings, Piston Assemblies Conn. Rods, Valves, Gaskets, Gasket Sets Oil Plugs & Caps		
24	Spark Plugs & Accessories		
	Spark Plug Boots & Clips, etc.		
25	Starter Handles & Rope		

Code Explanation	
RC	= Rotary Cost
MIN	= Minimum Order Quantity
NET	= Net Priced/No Discount Allowed
CS	= Case Quantity



NEW ITEMS FOR 2014

NEW
NEW ITEMS

Choke Control Cable for CUB CADET

Conduit 61"
Inner Wire 63"
Wire Travel 2"



Order No. 03 - 14621

Choke control cable replaces Cub Cadet 746-04214, 946-04214. Fits RZT50/54 mowers.

Choke Control Cable for MTD

Conduit 37"
Inner Wire 39"
Wire Travel 1-3/4"



Order No. 03 - 14624

Choke control cable replaces MTD/Cub Cadet 746-1085A. Fits models 1170, 1180, 1212, 1800, LT1042, LT1045, LT1046 & LT1050.

Drive Cable for MTD

Cable Length 38-1/4"
Overall Length 43"



Order No. 05 - 5616

Clutch drive cable replaces MTD 946-0898, 746-0898. Fits 600 model series snow throwers built 1995-2002 and 700 model series built in 2003. Model 312-610000 (1992), 313-610E120 (1993), 314-616E131 (1994) snowthrowers.

Ring Rubber Wheel for AYP

ID 3-5/8"
OD 4-1/2"



Order No. 05 - 5620

Ring rubber wheel replaces AYP 179831 & Husqvarna 532-1798-31. Fits many units built since 2002.

Drive Control Cable for AYP

Conduit Length 56"
Inner Wire 59-3/4"



Order No. 05 - 14623

Drive control & cable replaces AYP 700615, 146323, 145755, 184588, 184596 & Husqvarna 5321463-23, 5321845-96. Fits 22" self-propelled mowers. Flexible innerwire with spring on end Z-bend on spring.

Shift Cable for JOHN DEERE

Conduit 43"
Inner Wire 46"
Wire Travel 3"



Order No. 05 - 14622

Shift cable replaces John Deere GC00578 and AM107139. Fits 21" walk behind mowers JA65, JE75, JX75 & JX85.

Traction Cable for TORO

Conduit Length 32-1/4"
Total Length 47-1/4"



Order No. 05 - 14620

Traction cable replaces Toro 106-8300. Fits super recycler mower.

Deck Engagement Cable for MTD

Conduit Length 25"
Total Length 43"



Order No. 05 - 13657

Deck engagement cable replaces MTD 946-04092 / 746-04092. Also replaces Toro. Outer casing 26" long.

Plastic Wheel for AYP

Order No. 07 - 13495

12" x 1-3/4" hub length, radial tire, 6 spoke rim 1/2" sealed ball bearings, replaces AYP 431880X460 / 194387X460. Also replaces Husqvarna 433499X460. Gray Plastic.



NEW ITEMS FOR 2014



NEW ITEMS

Deck Wheel for AYP



Order No. 07 - 14035

5" x 1-7/8" x 1/2" bore, deck wheel replaces AYP 188606. Also replaces Husqvarna 532188606.

Deck Wheel for CUB CADET



Order No. 07 - 14446

5" x 2-5/8" x 5/8" plastic bushing, deck wheel replaces Cub Cadet / MTD 634-3159. 2-7/8" centered hub

Deck Wheel for KUBOTA



Order No. 07 - 14473

Plastic deck wheel replaces Kubota K5668-42100. Fits models ZD321, ZD326 with 60" & 72" decks.

Plastic Wheel for TORO



Order No. 07 - 14424

8" x 1-3/4" x 1/2" bore, plastic wheel replaces Toro 105-1814. Radial Tread tire.

Super Turf Tread Tire from KENDA



Order No. 08 - 14233

20 x 10.50 - 8, 4-ply tubeless, K500 Super Turf tire. Replaces Scag 484057.

Super Turf Tread Tire from KENDA



Order No. 08 - 14542

24 x 12.00 - 12, 4-ply tubeless, K500 Super Turf tire. Used on Scag, Exmark, etc. Great for mowing on hill sides.

Super Turf Tread Tire from KENDA



Order No. 08 - 14556

23 x 9.50 - 12, 4-ply tubeless, K500 Super Turf tire. Replaces Scag 484466. Fits Cub, Cheetah & Freedom Z.

Auger Bearing for AYP

ID 3/4" (19mm)
Height 1-39/64" (25.4mm)



Order No. 09 - 5618

Auger bearing replaces AYP 187925 & Husqvarna 532-187925. 3-5/8" x 2" flange.

Tube Bearing for GRASSHOPPER

ID 3/8" (9.5mm)
OD 5/8" (15.8mm)
Length 3.44" (87.4mm)



Order No. 09 - 14060

Tube bearing replaces Grasshopper 942137.

Spacer Roller for GRASSHOPPER

ID 3/8" (9.5mm)
OD 5/8" (15.8mm)
Length 2.04" (51.8mm)



Order No. 09 - 14059

Spacer roller mount replaces Grasshopper 902284.



NEW
NEW ITEMS

Bearing Spacer for HUSTLER

ID 3/4" (19mm)
OD 1" (25.4mm)
Length 6-1/4" (152mm)



Order No. 09 - 14133

Bearing spacer replaces Hustler 782771. Used with our 09-11835 bearings.

Steering Shaft Bushing for JOHN DEERE

ID 5/8" (15.8mm)
OD .900" (22.8mm)
Height .870" (22.0mm)



Order No. 09 - 14557

Steering shaft bushing replaces John Deere GX21994. Fits L100 series, Sabre & Scotts models. Flange OD 1" MIN005

Flange Bearing for MTD

ID 3/4" (19mm)
OD .945" (24mm)
Height 1" (25.4mm)



Order No. 09 - 13468

Plastic flange bearing replaces MTD 741-0660A.

MIN010

Flange Bearing for MTD

ID 5/8" (15.8mm)
OD 15/16" (23.8mm)
Height 1" (25.4mm)



Order No. 09 - 13467

Plastic flange bearing replaces MTD 741-0659. Flange OD 1-1/4".

MIN010

Fan Bearing for MURRAY

ID 7/8" (22.2mm)
Height 47/64" (18.7mm)
Keyway 9/16" (14.3mm)



Order No. 09 - 5619

Fan bearing with flange replaces Murray 761507 & MJ761507 & 780048 bearing for snowthrower. Flange with cage measures: 3-3/4" L x 2-3/4" W. Bolt holes are on 3" centers.

Caster Bushing for WRIGHT STANDER

ID 1-1/4" (31.75mm)
OD 1-5/8" (41.3mm)
Height 1-3/8" (34.9mm)
Flange OD 2" (50.8mm)



Order No. 09 - 14322

Caster bushing replaces Wright Stander 14990003. For 1-1/4 pin.

Damper for CUB CADET



Order No. 10 - 14437

Damper replaces Cub Cadet 02003622. Fits Cub Cadet, MTD commercial turf.

Clevis Hitch Pin for VELKE



Order No. 10 - 14221

Clevis hitch pin replaces Velke VKPIN2-2. Similar to our 10-8671. OD 1/2" x 4-1/4" length.

Spindle Grease Seal for SCAG

Order No. 10 - 13524

Spindle grease seal replaces Scag 481024. Fits our 10-9153 spindle. OD 2" x 1-1/2" ID x .312".



NEW ITEMS FOR 2014



NEW ITEMS

Electric Clutch for ARIENS



Order No. 10 - 14495

Electric clutch replaces Ariens 09407700, Grasshopper 606242 & 388767, Snapper 35520, 58925, 7058925YP, Woods 73558, 74075. Warner 5218-58, 5218-26. 1-1/8" ID, 3-1/2" height, 1/2" belt, 4-7/8" pulley.

Electric Clutch for MTD



Order No. 10 - 14327

Electric clutch replaces MTD 917-04622 & 917-04183, 717-04183. Warner 5219-99. 1" ID, 4" height, 5-11/32" pulley.

Electric Clutch for ENCORE



Order No. 10 - 14189

Electric clutch replaces Encore 5203434, Shiver Country Clipper E-6444, Wright Mfg. 71410024. Warner 5218-218. Clutch brake, 200 lb torque. 1-1/8" ID, 3-1/4" height, 7-1/2" pulley.

Spindle Assembly for CASTLEGARDEN



Order No. 10 - 12966

Spindle assembly replaces Castlegarden 82207203/0, right hand fits TC92. Left hand threads fits 92CM decks. For Castlegarden Twin Cut TC102 + 122. (1,02m/40 + 1,22m/48)

Spindle Assembly for CUB CADET



Order No. 10 - 14328

Spindle assembly replaces Cub Cadet 918-04889A, 918-04822A, 618-04822A, 618-04950. Fits LTX1040 tractor (2010 & after), 13AX90AS010, 13RX90AS056, 13AX90AS009, 13WX90AS010, 13WX90AS009, 13AX90AS209, 13RX90AS256, 13WX90AS209. LTX1042 tractor (2010 & after), 13AX9124010 (2010), 13WX91AS010 (2010)

Spindle Assembly for CUB CADET



Order No. 10 - 14329

Spindle assembly replaces Cub Cadet 918-04825B, 918-05016, 618-04825, 618-05016. Fits LTX1050VT tractor (2010 & after), 13VR91AP010 (2010), 13WR91AP010 (2010), 13VR91AP009 (2010), 13WR91AP009 (2010). PULLEY DIA. 5.3". Uses our 13-11711 pulley.

Spindle Assembly for EXMARK



Order No. 10 - 13540

Spindle assembly replaces Exmark 109-2102. Fits 46", 48", 50", new style Triton Decks. Also fits Lazer Z hp.

Spindle Assembly for MTD



Order No. 10 - 13631

Spindle assembly replaces MTD 918-04474A, 618-04474. Also replaces Toro 112-6063, fits model 13AC762F052 & 13RC762F052. Pulley Dia. 5.75".

Spindle Housing for HUSTLER

Order No. 10 - 14036

Spindle housing replaces Hustler 034843. Fits our 10-12241 & 10-12459 spindle assembly.





NEW
NEW ITEMS

Spindle Assembly for GRAVELY



Order No. 10 - 14230

Spindle assembly replaces Gravelly 59202600. Fits models GR, HR, PM & ZT series. Center spindle. Includes mounting hardware.

Spindle Assembly for GRAVELY



Order No. 10 - 14252

Spindle assembly replaces Gravelly 59201000. Fits models GR, HR, PM series. Outer, left & right spindle. Includes mounting hardware.

Spindle Housing for TORO



Order No. 10 - 14132

Spindle housing with bearings and spacer replaces Toro 107-9161. Included in our **10-14121** & **10-14122**. Includes (2) Toro 100-1048 bearings our **09-7210**, spacer 62-3661 & 88-4510 housing only.

Spindle Assembly for WRIGHT STANDER



Order No. 10 - 14282

Spindle assembly replaces Wright Stander 71460022 (short). Fits 32", 36", 42" decks. Replaced by 95460018, old style, thru bolt design.

Spindle Assembly for WRIGHT STANDER

Order No. 10 - 14283

Spindle assembly replaces Wright Stander 71460007, 71460126 (long). Fits 48", 52", 61" decks. Old style, thru bolt design.



Belts for AYP



Order No.

Description

- 12 - 14513** **Snowthrower Belt.** Replaces AYP **428454**, & Husqvarna **532428454**. 1/2" (12.7 mm) x 29.44" (747.8 mm). Fits models 1827 EXLT, 1830 EXLT Snowthrowers. Wrapped molded, Aramid cord construction, single cover.
- 12 - 14512** **Snowthrower Belt.** Replaces AYP **408019**, & Husqvarna **532408019**. 5/8" (15.8 mm) x 38.97" (989.8 mm). Fits models 1130 SBE OV, 11524E, 14527E, 145270 Snowthrowers. Raw edge, Aramid cord construction.
- 12 - 14116** **Snowthrower Belt.** Replaces AYP **408007**, & Husqvarna **532408007**. 5/8" (15.8 mm) x 38" (965.2 mm). Fits models PP1150E27, PP208E24, PP208EPS24 Snowthrowers. Raw edge, Aramid cord construction.
- 12 - 14117** **Snowthrower Belt.** Replaces AYP **408010/183533**, & Husqvarna **532408010**. 5/8" (15.8 mm) x 37-3/4" (939.8 mm). Fits models 10527SB, 10527SBE, 10530SBE, 1130SBLS, 1130SBE, 5224STE, 924SB, 924SBE, 927SB Snowthrowers. Raw edge, Aramid cord construction.

NEW ITEMS FOR 2014



NEW ITEMS

Belts for EXMARK



Order No. **Description**

12 - 14638 **Deck Belt.** Replaces Exmark **103-2240**. 5/8" (15.87 mm) x 83-3/4" (2127.3 mm). Fits 52" Turf Tracer Hydro Wide area walk mowers. Wrapped molded, Aramid cord construction, double cover, white.

MTD

12 - 14118 **Snowthrower Belt.** Replaces MTD **954-04050 / 754-04050**. 1/2" (12.7 mm) x 35"(889 mm). Fits two stage snow thrower, 2005 -newer. Raw edge, cogged, aramid cord construction.

MURRAY

12 - 14120 **Snowthrower Belt.** Replaces Murray **585416MA**. 1/2" (12.7 mm) x 38-3/8" (965.2 mm). Fits Craftsman & Murray dual stage snow throwers & Snow Blizzard. Raw edge, Aramid cord.

SCAG

12 - 14593 **Deck Belt.** Replaces Scag **483741**. 5/8" (15.87 mm) x 137" (3479.8 mm). Fits models SCZ61V, SCZ72V Cheetah, SMT-72V, STT-28CAT-SS, STT61V Turf Tiger. Wrapped molded, Aramid cord construction, double cover, clutching brown.

TORO

12 - 14365 **Drive Belt.** Replaces Toro **88-6250**. 1/2" (12.7 mm) x 87-1/2" (1905 mm). Fits models 71193, 14-38HXL lawn tractor. Also replaces John Deere GX21986, M40223, M86996. Traction drive belt for 100 series with 54" deck. Wrapped molded, Aramid cord construction, double friction cover.

12 - 14319 **Pump Belt.** Replaces Toro **115-9613**. 1/2" (12.7 mm) x 75-3/8" (2222.5 mm). Fits models Titan & Exmark Quest (42", 48" & 52") Raw edge cogged belt.

12 - 14318 **Deck Belt.** Replaces Toro **115-4971**. 5/8" (15.87 mm) x 175-7/8" (4445 mm). Fits 54" ZX5400 Titan deck belt. Wrapped belt.

12 - 14130 **Deck Belt.** Replaces Toro **110-6871**. 1/2" (12.7 mm) x 112-1/8" (2844.8 mm). Fits Z4200 42" TimeCutter Z. Wrapped belt.

12 - 14129 **Drive Belt.** Replaces Toro **110-6774**. 1/2" (12.7 mm) x 62-1/2" (1587.5 mm). Hydro pump drive belt. Fits Time Cutter Z4200, Z4220, Z4235, Z5000, Z5020, Z5030, Z5035, Z5040, Z5060. Cogged belt.

12 - 14042 **Drive Belt.** Replaces Toro **91-2258**. 3/8" (9.5 mm) x 35" (889 mm). Fits Recycler and Super Recycler self-propelled belt for walk-behind mowers. Covered belt.

*Made with KEVLAR® or non-trade marked Aramid fiber.



NEW
NEW ITEMS

**Spindle Pulley for
CUB CADET**

ID 12 pt
OD 4"
Height 1"



Order No. 13 - 11711

Spindle pulley replaces Cub Cadet 756-04216. S9G-545 x 12 pt Hex Ch. Fits our 10-14329 spindle.

**Idler Pulley for
MTD**

ID 3/8"
OD 3-1/16"
Height 2"



Order No. 13 - 14326

Idler pulley replaces MTD 756-04325. V-Idler pulley.



Universal Blade

ORDER NO.	REPLACES O.E.M. NO.	LENGTH	CENTER HOLE DIAM.	OUTSIDE HOLE DIAM.	CENTER TO CENTER	WIDTH	STEEL THICK.	APPLICATION
 14 - 50288		19" 482.6mm	.472" 12mm			2-1/2" 63.5mm	.150" 3.8mm	Mulching Blade



AYP

 15 - 14459	187254 187256 532-187256	18-1/2" 401.3mm	5 point star			2-1/2" 63.5mm	.204" 5.2mm	High Lift Bagging Blade (3) blades for 54" cut
--	--------------------------------	--------------------	-----------------	--	--	------------------	----------------	---

ARIENS

 15 - 14540	04265400	14-7/8" 355.6mm	5/8" 15.8mm			2-1/4" 50.8mm	.187" 4.7mm	Fits ZT42, Zoom 42
 15 - 13177	03746500 03971900	17.35" 440.6mm	5/8" 15.8mm			2-1/4" 50.8mm	.187" 4.7mm	Fits ZT50, Zoom 50

DIXIE CHOPPER

 15 - 14442	30227-62X 30227-62T	21-3/8" 533.4mm	5/8" 15.8mm			2-1/2" 63.5mm	.240" 6.1mm	
 15 - 14467	30227-62X 30227-62T	21-3/8" 533.4mm	5/8" 15.8mm			2-1/2" 63.5mm	.240" 6.1mm	Mulching Blade PATENTED

NEW ITEMS FOR 2014



NEW ITEMS

Blades for EXMARK

ORDER NO.	REPLACES O.E.M. NO.	LENGTH	CENTER HOLE DIAM.	OUTSIDE HOLE DIAM.	CENTER TO CENTER	WIDTH	STEEL THICK.	APPLICATION
 15 - 14491	116-1037-S	22-1/4" 558.8mm	15/16" 23.8mm			2-1/2" 63.5mm	.187" 4.7mm	(2) blades for 44" cut Fits Quest mowers.

GRAVELY

 15 - 13624	09081200	20-1/2" 520.7mm	5/8" 15.8mm			2-1/2" 63.5mm	.240" 6.1mm	(3) blades for 60" cut
--	----------	---------------------------	-----------------------	--	--	-------------------------	-----------------------	------------------------

HONDA

 15 - 14657	72531-VK6-010	21" 538.4mm	1-3/4" 44.5mm	19/32" 15mm		2-5/8" 66.6mm	.134" 3.4mm	Fits 21" model HRC216K2 PDA upper blade. Used with our 15-12615 lower blade.
--	---------------	-----------------------	-------------------------	-----------------------	--	-------------------------	-----------------------	--

HUSQVARNA

 15 - 50293	505544601	14-1/8" 359mm	.472" 12mm			2.36" 60mm	.160" 4.06mm	Mulching Blade PATENTED (Export Only)
 15 - 50292	504190401	15-5/16" 390mm	.472" 12mm			2.36" 60mm	.160" 4.06mm	Mulching Blade PATENTED (Export Only)
 15 - 50297	544102701	16-1/2" 420mm	.472" 12mm			2.36" 60mm	.160" 4.06mm	Mulching Blade PATENTED (Export Only)
 15 - 50290	522449503	17" 430mm	.472" 12mm			2.36" 60mm	.134" 3.4mm	Mulching Blade PATENTED (Export Only)
 15 - 50287	535429401	17-7/8" 431.8mm	1/2" 12.7mm			2.36" 60mm	.204" 5.2mm	Mulching Blade (Export Only)
 15 - 50289	531211017	18" 457.2mm	.68" 17.3mm			2.25" 57.2mm	.125" 3.2mm	Mulching Blade PATENTED (Export Only)



Blades for
HUSQVARNA (CONT.)

NEW

NEW ITEMS

ORDER NO.	REPLACES O.E.M. NO.	LENGTH	CENTER HOLE DIAM.	OUTSIDE HOLE DIAM.	CENTER TO CENTER	WIDTH	STEEL THICK.	APPLICATION
 15 - 14391	521981501	18" 457.2mm	5 point star			2.50" 63.5mm	.204" 5.2mm	Mulching Blade PATENTED (3) blades for 54" cut
 15 - 50294	544175701	19-1/8" 482mm	.472" 12mm			2.36" 60mm	.240" 6.1mm	Mulching Blade (Export Only)
 15 - 14392	521981601	21" 533.4mm	5 point star			2.50" 63.5mm	.204" 5.2mm	Mulching Blade PATENTED (3) blades for 61" cut
 15 - 50291	544175801	22-3/16" 558.8mm	.489" 12.4mm			2.362" 60mm	.240" 6.1mm	Mulching Blade (Export Only)

JOHN DEERE

 15 - 14475	M144516	19" 482.6mm	.800" 20.3mm			2-1/2" 63.5mm	.240" 6.1mm	Mulching Blade PATENTED (3) blades for 54" cut
---	---------	-----------------------	-----------------	--	--	------------------	----------------	--

KUBOTA

 15 - 14096	K5576-34350	16-1/2" 419.1mm	.890" 22.6mm			2-1/2" 63.5mm	.250" 6.4mm	Fits model H30T, series GR, ZG200, ZD200. (3) blades for 48" cut
 15 - 14488	K5619-34350	18-5/8" 457.2mm	.890" 22.6mm			2-1/2" 63.5mm	.250" 6.4mm	Fits model H30T, series ZG & ZD models. K446 (3) blades for 54" cut.
 15 - 14483	K5351-34342	18-5/8" 457.2mm	.890" 22.6mm			2-1/2" 63.5mm	.250" 6.4mm	K424 (3) blades for 54" cut
 15 - 14095	K5617-34330	18-5/8" 457.2mm	.715" 18.1mm			2-1/2" 63.5mm	.250" 6.4mm	Fits model H30T, series 2G127,ZG23,GR2100/2110 BX-RCK54P models. K327 (3) blades for 54" cut.
 15 - 14481	K5371-34340	20-1/2" 520.7mm	.890" 22.6mm			2-1/2" 63.5mm	.250" 6.4mm	K472 (3) blades for 60" cut

NEW ITEMS FOR 2014



NEW ITEMS

Blades for KUBOTA (CONT.)

ORDER NO.	REPLACES O.E.M. NO.	LENGTH	CENTER HOLE DIAM.	OUTSIDE HOLE DIAM.	CENTER TO CENTER	WIDTH	STEEL THICK.	APPLICATION
15 - 14482	K5112-71940	20-1/2" 520.7mm	.715" 18.2mm			2-1/2" 63.5mm	.250" 6.4mm	K132 (3) blades for 60" cut
15 - 12995	K5677-34340	24-7/16" 609.6mm	1-1/8" 25.4mm			2-1/2" 63.5mm	.240" 6.1mm	Fits model H30T, series ZD28, ZD326, ZD331 ZTR RCK72P-28Z models. K462 (3) blades for 72" cut.

MURRAY

15 - 50255	881076YP	16" 406.4mm	13/32" 10.3mm	13/32" 10.3mm	1-7/8" 25.4mm	2-1/4" 50.8mm	.150" 3.8mm	(Export Only)
15 - 50254	880638YP	19" 482.6mm	13/32" 10.3mm	13/32" 10.3mm	1-7/8" 25.4mm	2-1/4" 50.8mm	.150" 3.8mm	(Export Only)

STIGA

15 - 50295	1134-9124-01	16-11/16" 406.4mm	3 lobed			2.362" 60mm	.134" 3.4mm	Mulching Blade (Export Only)
15 - 50296	1134-9125-01	18-1/8" 465mm	3 lobed			2.52" 64mm	.134" 3.4mm	Mulching Blade (Export Only)

Splined Blade Bushing for EXMARK

ID 1/2"
Flange OD 1-3/4"
Height 1"



Order No. 17 - 14440

Splined blade bushing replaces Exmark 103-3037. Bushing fits all Exmark blades with .94" center hole. Fits our 10-13005 & 10-13540 spindle assemblies.

Blade Bolt with Washer for AYP



Order No. 17 - 14457

Blade bolt with washer replaces AYP 193003, Husqvarna 532-1930-03. Fits our 10-11014, 10-11590 & 10-12734 spindle assemblies. 1-1/4" x 7/16"-20.



NEW
NEW ITEMS

Blade Adapter for MTD

Height 1-3/16"

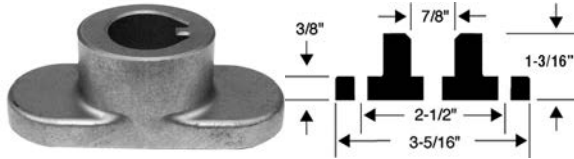

Order No. 17 - 14580

Blade adapter fits MTD walkbehind mowers. Fits our 15-6448, 15-12893, 15-6438, 15-6439, 15-6423, 15-6450, 15-6424, 15-6425 blades.

Blade Adapter for MTD

Height 2-1/8"

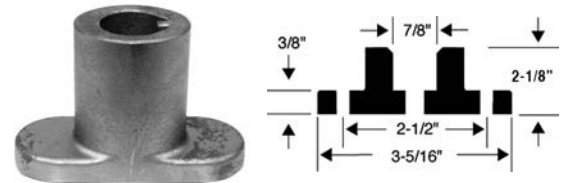

Order No. 17 - 14581

Blade adapter fits MTD walkbehind mowers. Fits our 15-6448, 15-12893, 15-6438, 15-6439, 15-6423, 15-6450, 15-6424, 15-6425 blades.

Muffler Pipe for HONDA



Order No. 18 - 14594

Muffler pipe replaces Honda 18330-ZH9-N00, 18330-ZE2-W00, code 3682036. Fits GX240, GX340, GX390 series engines. Included with our 18-14449 Muffler.

Muffler for HONDA



Order No. 18 - 14449

Muffler pipe replaces Honda 18310-ZE2-W61. Fits GX340, GX390, muffler (100 db) for 11 & 13 hp engines with heat shield.

Muffler for HONDA



Order No. 18 - 14450

Muffler replaces Honda 18310-ZMO-000. Fits GCV135 AND GVC160 series engines, shield not included. Fits models GSV190 (A1G7, A2G7, N1G7, N2G7). Also fits models GX100VEA, GX100UBE14.

Muffler Protector for HONDA



Order No. 18 - 14451

Muffler protector replaces Honda 18320-ZE2-W62, 18320-ZE2-W61. Fits engines GX340 & 390 KBN#35-11 & Honda 18320-ZE3-W01.

Muffler for MTD



Order No. 18 - 14456

Muffler replaces MTD 751-10448C, single cylinder B&S.

Air Filter for BRIGGS & STRATTON

OD 3"
ID 1-1/2"
Height 1-7/8"



Order No. 19 - 14089

Air filter replaces B&S 797819. Fits model 9 & 10, 4.50-6.00 ft-lbs gross torque, 450-600 series 3.0-5.0 gross HP/CV. Cartridge with gasket.

Air Filter for BRIGGS & STRATTON

OD 3"
ID 1/2"
Length 3-7/8"



Order No. 19 - 14158

Air filter replaces B&S 796032. Fits model series 219807-0664-B1. Uses our 19-14423 pre-filter

Air Filter for BRIGGS & STRATTON

Width 2-1/4"
Height 2-1/2"
Length 3-1/4"



Order No. 19 - 14206

Air filter replaces B&S 796970. Fits 083152-0151-B1 & 5.5 gross torque model: 83132-0036-B1. Pre-filter included.

NEW ITEMS FOR 2014



NEW ITEMS

**Air Filter for
BRIGGS & STRATTON**

Length 4-3/8"
Width 2-1/2"
Height 1-3/8"



Order No. 19 - 14364

Air filter replaces B&S 798452. Fits models 09P702 9/10 OHV 140 CC 500-550 E & EX series walks.

**Prefilter for
BRIGGS & STRATTON**



Order No. 19 - 14422

Prefilter replaces B&S 797704. Fits our 19-13644 filter.

**Prefilter for
BRIGGS & STRATTON**



Order No. 19 - 14423

Prefilter replaces B&S 798911. Fits our 19-14158 filter.

KOHLER Oil Filter



Order No. 19 - 1205001S

Kohler 1205001S OEM oil filter. For Command, AEGIS, Courage and TRIAD / OHV engines.

Carded KOHLER Oil Filter



Order No. 19 - 1205001S1

Kohler 1205001S1 OEM carded oil filter. For Command, AEGIS, Courage and TRIAD / OHV engines.

KOHLER Air Filter



Order No. 19 - 1208305S

Kohler 1208305S OEM air filter. For CV11-CV16.

KOHLER Pre Cleaner Filter



Order No. 19 - 1208308S

Kohler 1208308S OEM pre cleaner filter. For CV11-CV16.

KOHLER Air Filter



Order No. 19 - 1208310S

Kohler 1208310S OEM air filter. For Pro CV11-CV16 & CV460-CV493.

KOHLER Pre Cleaner Filter



Order No. 19 - 1208312S

Kohler 1208312S OEM pre cleaner filter. For Pro CV11-CV16 & CV460-CV493.

Carded KOHLER Air Filter



Order No. 19 - 1288305S1

Kohler 1288305S1 OEM carded air filter. For Command CV11-CV16 hp engines.



NEW
NEW ITEMS

Carded KOHLER Air Filter



Order No. 19 - 1288310S1

Kohler 1288310S1 OEM carded air filter. For Command Pro CV11-CV16 & CV460-493 engines.

KOHLER Air Filter

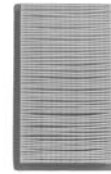

Order No. 19 - 1408301S

Kohler 1408301S OEM air filter. For Courage XT series.

Carded KOHLER Air Filter



Order No. 19 - 1408301S1

Kohler 1408301S1 OEM carded air filter. For Courage XT-6 & XT-7 series.

KOHLER Pre Cleaner Filter



Order No. 19 - 1408302S

Kohler 1408302S OEM pre cleaner filter. For Courage XT series.

KOHLER Air Filter



Order No. 19 - 1708307S

Kohler 1708307S OEM air filter. For Command Pro CH270.

KOHLER Pre Cleaner Filter



Order No. 19 - 1708312S

Kohler 1708312S OEM pre cleaner filter. For Command Pro CH270.

Carded KOHLER Air Filter



Order No. 19 - 1788303S1

Kohler 1788303S1 OEM carded air filter. For Command Pro CH395/440.

Carded KOHLER Air Filter



Order No. 19 - 1788307S1

Kohler 1788307S1 OEM carded air filter. For Command Pro CH270.

Carded KOHLER Air Filter



Order No. 19 - 1888301S1

Kohler 1888301S1 OEM carded air filter. For Courage SH265.

KOHLER Pre Cleaner Filter

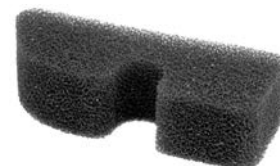

Order No. 19 - 2008304S

Kohler 2008304S OEM pre cleaner filter. For Courage single SV470-620.

NEW ITEMS FOR 2014



NEW ITEMS

KOHLER Air Filter



Order No. 19 - 2008306S

Kohler 2008306S OEM air filter. For Courage single SV470-SV620, 15-22 hp engines.

Carded KOHLER Air Filter



Order No. 19 - 2088306S1

Kohler 2088306S1 OEM carded air filter. For Courage single CV470-620, 15-22 hp engines.

KOHLER Air Filter



Order No. 19 - 231847S

Kohler 231847S OEM air filter. For K181.

KOHLER Air Filter



Order No. 19 - 235116S

Kohler 235116S OEM air filter. For K241-321, M8.

KOHLER Pre Cleaner Filter



Order No. 19 - 237421S

Kohler 237421S OEM pre cleaner filter. For K241-321.

KOHLER Pre Cleaner Filter



Order No. 19 - 2408302S

Kohler 2408302S OEM pre cleaner filter. For CV17-CV23, CV724-CV740, CH18-25, CH730-740.

KOHLER Air Filter



Order No. 19 - 2408303S

Kohler 2408303S OEM air filter. For CV18-CV25, CV675-CV740, CH18-25, CH730-750.

KOHLER Pre Cleaner Filter



Order No. 19 - 2408305S

Kohler 2408305S OEM pre cleaner filter. For CV18-CV25, CV675-CV740, CH18-25, CH730-750.

Carded KOHLER Air Filter

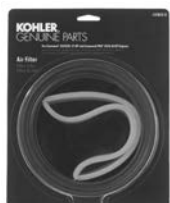

Order No. 19 - 2488303S1

Kohler 2488303S1 OEM carded air filter. For CV18-CV25, CV675-CV740, CH18-25, CH730-750.

KOHLER Air Filter



Order No. 19 - 2508301S

Kohler 2508301S OEM air filter. For CV18-750, CH18-750, LV625-680, LH640-775, C940-980.



NEW
NEW ITEMS

KOHLER Air Filter



Order No. 19 - 2508302S

Kohler 2508302S OEM air filter. For CV493, Triad OHC.

KOHLER Air Filter



Order No. 19 - 2508303S

Kohler 2508303S OEM air filter. For CV493, Triad OHC.

KOHLER Air Filter



Order No. 19 - 2508304S

Kohler 2508304S OEM air filter safety. For CV18-750, CH18-750, LV625-680, LH640-775, C940-980.

Carded KOHLER Air Filter



Order No. 19 - 2588303S1

Kohler 2588303S1 OEM carded air filter. For Magnum 8 hp and K241-K321, M8, 10-14 hp engines.

KOHLER Air Filter



Order No. 19 - 3208303S

Kohler 3208303S OEM air filter. For Courage twin SV710-740.

KOHLER Pre Cleaner Filter



Order No. 19 - 3208305S

Kohler 3208305S OEM pre cleaner filter. For Courage twin CV710-740.

Carded KOHLER Air Filter



Order No. 19 - 3288303S1

Kohler 3288303S1 OEM carded air filter. For Courage twin SV710-740.

KOHLER Pre Cleaner Filter



Order No. 19 - 3208308S

Kohler 3208308S OEM pre cleaner filter. For Courage Pro twin SV810-840.

KOHLER Air Filter



Order No. 19 - 3208306S

Kohler 3208306S OEM air filter. For Courage Pro twin SV810-840.

Carded KOHLER Air Filter



Order No. 19 - 3288306S1

Kohler 3288306S1 OEM carded air filter. For Courage Pro twin SV810-840.

NEW ITEMS FOR 2014



NEW ITEMS

KOHLER Pre Cleaner Filter



Order No. 19 - 4508301S

Kohler 4508301S OEM pre cleaner filter. For CV17-25, CV675-740, K341, M10-16, KT Dome Style.

KOHLER Air Filter



Order No. 19 - 4508302S

Kohler 4508302S OEM air filter. For CV17-25, CV675-740 and K341, M10-16, KT Dome Style.

Carded KOHLER Air Filter



Order No. 19 - 4588302S1

Kohler 4588302S1 OEM carded air filter. For Command Pro CV17-25, CV675-740 and K341, M10-16, KT Dome Style.

KOHLER Air Filter



Order No. 19 - 4708301S

Kohler 4708301S OEM air filter. For CH11-16 and KT series square style.

KOHLER Air Filter



Order No. 19 - 4708303S

Kohler 4708303S OEM air filter. For CV17-CV23, CV724-CV740, CH18-25, CH730-740.

KOHLER Pre Cleaner Filter



Order No. 19 - 5208301S

Kohler 5208301S OEM pre cleaner filter. For CH11-16 and KT series square style.

Carded KOHLER Air Filter



Order No. 19 - 4788303S1

Kohler 4788303S1 OEM carded air filter. For Command CH18-23 hp and CV17-23 hp engines, CV17-CV23, CV724-CV740, CH730-740.

Carded KOHLER Air Filter



Order No. 19 - 4788301S1

Kohler 4788301S1 OEM carded air filter. For Command CH11-16 hp and Magnum 18-20 hp & FT17-19 hp engines. KT series square style.

KOHLER Oil Filter



Order No. 19 - 277233S

Kohler 277233S OEM oil filter. For K482-582.

KOHLER Oil Filter



Order No. 19 - 5205002S

Kohler 5205002S OEM oil filter. For extra capacity oil filter.



NEW
NEW ITEMS

Carded KOHLER Oil Filter



Order No. 19 - 5205002S1

Kohler 5205002S1 OEM carded oil filter. For Command, Command Pro, extra capacity.

Air Filter for ROBIN / SUBARU

Width 3-5/16"
Height 2-3/4"
Length 5-3/4"



Order No. 19 - 14431

Air filter replaces Robin 279-32607-17 / 279-32607-07, Wacker 0156753. Fits Subaru / Robin EX27, 9 hp engines. Prefilter included.

Air Filter for ROBIN / SUBARU

OD 3-5/8"
ID 2-1/2"
Height 1-1/2"



Order No. 19 - 14464

Air filter replaces Robin 274-32603-07. Fits model EH-09, 4 cycle, 2.4 HP OHV. Used on Dirt Tampers: Mikasa, Wacker.

Air Filter for ROBIN

Width 2"
Height 1-7/8"
Length 4-1/2"



Order No. 19 - 14648

Air filter replaces Robin 277-32611-07, 252-32602-07, 277-32606-18, 20A-32636-00 & Wacker 01156759. Fits models Wacker WM130 & WM170, Robin EX13, EX17, EX21. For 4.5, 6 and 7 hp engine specifications.

KOHLER Fuel Filter



Order No. 20 - 2505022S

Kohler 2505022S OEM fuel filter. 51 micron with 1/4" fuel line ID.

Carded KOHLER Fuel Filter



Order No. 20 - 2505022S1

Kohler 2505022S1 OEM carded fuel filter. 51 micron with 1/4" fuel line ID.

KOHLER Fuel Filter



Order No. 20 - 2505021S

Kohler 2505021S OEM fuel filter. 75 micron with 3/16" & 1/4" fuel line ID.

Carded KOHLER Fuel Filter



Order No. 20 - 2505021S1

Kohler 2505021S1 OEM carded fuel filter. 75 micron with 3/16" & 1/4" fuel line ID.

KOHLER Fuel Filter



Order No. 20 - 2505007S

Kohler 2505007S OEM fuel filter. 75 micron with 3/16" & 1/4" fuel line ID.

Carded KOHLER Fuel Filter



Order No. 20 - 2505007S1

Kohler 2505007S1 OEM carded fuel filter. 75 micron with 3/16" & 1/4" fuel line ID.

NEW ITEMS FOR 2014



NEW ITEMS

KOHLER Fuel Filter



Order No. 20 - 2405013S

Kohler 2405013S OEM fuel filter. 15 micron with 1/4" fuel line ID.

Carded KOHLER Fuel Filter



Order No. 20 - 2405013S1

Kohler 2405013S1 OEM carded fuel filter. 15 micron with 1/4" fuel line ID.

Cut Lengths of TYGON Fuel Line



Order No. 20 - 14663

3 ft. .080" x .140" packaged Tygon F-4040A yellow fuel line.

Order No. 20 - 14665

3 ft. 3/32" x 3/16" packaged Tygon F-4040A yellow fuel line.

Order No. 20 - 14664

10 ft. .080" x .140" packaged Tygon F-4040A yellow fuel line.

Order No. 20 - 14666

10 ft. 3/32" x 3/16" packaged Tygon F-4040A yellow fuel line.

Tygon Fuel Line



Order No.	Dimensions ID x OD	Standard Package
20 - 14675	.080" x .140"	25 ft.
20 - 14676	3/32" x 3/16"	25 ft.
20 - 14629	.080" x .140"	200 ft.
20 - 14628	3/32" x 3/16"	200 ft.

Tygon Fuel and Lubricant Tubing for Petroleum and Petroleum/Alcohol blends. Gas and oil tubing for chain saws, small engines, snowmobiles, mowers, etc. Flexible and resists swelling and brittleness (Yellow). Temp. Range 35° below F to 165° F. F-4040A

KOHLER Carburetor Repair Kit

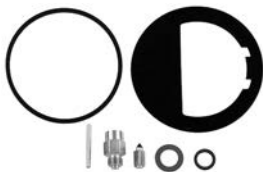

Order No. 22 - 2575701S

Kohler 2575701S OEM carburetor repair kit. For K91-301, M8-12.

KOHLER Carburetor Repair Kit

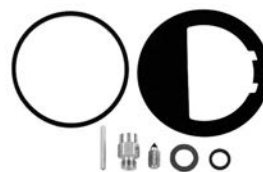

Order No. 22 - 2575702S

Kohler 2575702S OEM carburetor repair kit. For K301-582, M12-20.

Carburetor Repair Kit for HONDA

Order No. 22 - 14272

Carburetor repair kit replaces Honda 16010-ZE2-812. Only includes bowl gasket and O-rings. Fits Honda engine models GX340 and GX390.

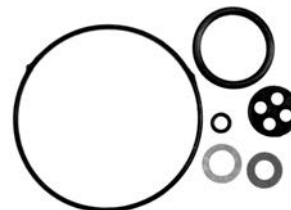



NEW

NEW ITEMS

Impulse Fuel Pump for WALBRO



Order No. 22 - 14655

Impulse fuel pump replaces Walbro FPC-1-1. With stainless steel screws.

Breather Tube Grommet for BRIGGS & STRATTON



Order No. 23 - 14299

Breather tube grommet replaces B&S 692189. 90 degree. MIN010

Gasket Set with Seals for BRIGGS & STRATTON

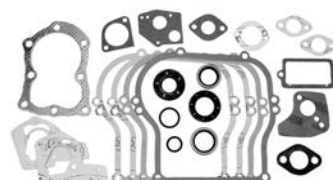

Order No. 23 - 14548

Gasket set with seals replaces B&S 495603. Fits 5 hp horizontal flathead engines.



Order No.		Description
24 - 14308	MIN004	RDZ4H Champion Replaces MTD 794-00043.
24 - 14492	MIN004	RA8HC Champion Replaces Autolite 4164, NGK DCPR7E & DR7EB, Torch TK9RTC Kohler 1413207S. Fits Toro XT149 & XT650.
24 - 14636	MIN004	XC12YC Champion Replaces Autolite 5503, Denso Q16PR-U, NGK BCPR5ES, BKR5E, CS6, Kohler 2513214S.
24 - 14637	MIN004	XC10YC Champion Replaces Kohler 6213204S. Fits Kohler CH940-1000.



THE HIGH PERFORMANCE PLUG
COPPER CORE SINCE 1958



Order No.		Description
24 - 14560	MIN010	BR4LM NGK Replaces Champion RJ17LM, Denso W14LMR-US.
24 - 14559	MIN004	BKR5E-11 NGK Replaces Champion RC12YC, Denso K16PR-U11.

NEW ITEMS FOR 2014



NEW ITEMS

**Starter Gear for
BRIGGS & STRATTON**



Order No. 26 - 13114

Starter gear replaces B&S 693713. Fits models 220700-252799, 210700-312799 series engines. Metal 14 tooth starter gear with plastic inner for some starter motors. Does not replace 16 tooth plastic gear, the tooth pitch is different. Fits our 26-12494, 26-12954 & 26-13096 starters.

**Starter Recoil Assembly for
ECHO**



Order No. 26 - 13609

Starter recoil assembly replaces Echo 17720055931. Fits models SMR-230, 231, PE-260, 2601.

**Starter Recoil Assembly for
ECHO**



Order No. 26 - 13610

Starter recoil assembly replaces Echo A051000201, USE A051000840. Fits PB-650T & PB-651H & PB-751.

**Starter Recoil Assembly for
HONDA**



Order No. 26 - 14643

Starter recoil assembly replaces Honda 28400-ZOL-V20ZA. Fits models GXV135 & GCV160. Similar to our 26-9985, but with 82" of rope. Black

**Starter Recoil Assembly for
RED MAX**



Order No. 26 - 14656

Starter recoil assembly replaces Red Max 521342701, Husqvarna 4810-75100. Fits models BCZ2500, 2600, 2601, 2610, 2650, 2660, EXZ2500, HBZ2500, 2600, 2601, 2610, HEZ2500, 2601, 2602, 2610, 2650, LRTZ2500, PSZ2500, RMNBZ2500, 2601, RMSZ2500, 2601.

**Starter Recoil Assembly for
STIHL**



Order No. 26 - 14340

Starter recoil assembly replaces Stihl 4137-190-4000. Fits FS75-FS85, BG, FC, FS, HL, HT, KM, 70, 75, 80, 85. Fits Stihl blowers, edger, string trimmer, hedge trimmer, pole pruner, Kombi & Harvester models.

KOHLER Electric Starter



Order No. 26 - 5209813S

Kohler 5209813S OEM electric starter, bendix drive. For Magnum Vertical.

KOHLER Electric Starter



Order No. 26 - 5209812S

Kohler 5209812S OEM electric starter, bendix drive. For KT series, Magnum twins.



NEW
NEW ITEMS

KOHLER Electric Starter



Order No. 26 - 5209811S

Kohler 5209811S OEM electric starter, bendix drive. For KT series.

KOHLER Electric Starter



Order No. 26 - 4809804S

Kohler 4809804S OEM electric starter, bendix drive. For K series, cast iron twins.

KOHLER Electric Starter



Order No. 26 - 4509810S

Kohler 4509810S OEM electric starter, bendix drive. For K series singles (low mount).

KOHLER Electric Starter



Order No. 26 - 4509809S

Kohler 4509809S OEM electric starter, bendix drive. For K series singles (high mount).

KOHLER Electric Starter



Order No. 26 - 4109808S

Kohler 4109808S OEM electric starter, bendix drive. For K series.

KOHLER Electric Starter



Order No. 26 - 4109806S

Kohler 4109806S OEM electric starter, bendix drive. For magnum series.

KOHLER Electric Starter



Order No. 26 - 3209804S

Kohler 3209804S OEM electric starter, bendix drive. For Courage twins.

KOHLER Electric Starter



Order No. 26 - 1209821S

Kohler 1209821S OEM electric starter, bendix drive. For Command single horizontal engines.

KOHLER Electric Starter



Order No. 26 - 1209822S

Kohler 1209822S OEM electric starter, bendix drive. For Command single vertical engines.

KOHLER Electric Starter



Order No. 26 - 2509807S

Kohler 2509807S OEM electric starter, bendix drive. For Command twin engines.

NEW ITEMS FOR 2014



NEW ITEMS

KOHLER Electric Starter



Order No. 26 - 2509811S

Kohler 2509811S OEM electric starter, solenoid shift. For Command Twin.

Electric Starter for KUBOTA



Order No. 26 - 14551

Electric starter replaces Kubota 1G069-63010. Fits models ZD28, ZD331, mowers. D1105 Diesel engines. Nippondenso style starter.

Electric Starter for TECUMSEH



Order No. 26 - 14511

Electric starter replaces Tecumseh 37284. Used on OV691EA, EP, TVT691, VTX691 engines, 12 volt.

Air Filter for ECHO

Length 6-3/4"
Width 4-7/16"
Height 1-1/8"

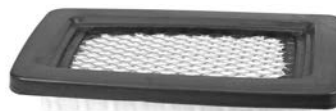

Order No. 27 - 12775

Air filter replaces Echo A226000410. Fits PB-770H & PB-770T, 63.3 cc backpack blower.

Air Filter for ECHO

Length 3-1/8"
Width 3-1/8"
Height 3/8"
ID 3/8"



Order No. 27 - 14163

Air filter replaces Echo A226000350 / A226000351 single layer. Fits PE-280, PB-251, PB-255, PB265, SRM280.

Air Filter for STIHL



Order No. 27 - 14258

Air filter replaces Stihl 4229-120-1800. Fits BG45, BG46, BG55, BG65, SH55, SH85 blowers.

Air Filter for STIHL



Order No. 27 - 13553

Air filter replaces Stihl 4140-124-2800. Fits string trimmers FS 38, 45, 46, 55 & KM55 edger, FC55 hedge trimmer HL45, HS45. Used on Stihl models FC55, FS38, FS45, FS45C, FS45L, FS46, FS46C, FS55, FS55C, FS55R, FS55RC, FS55T, HL45, HS45, KM55, KM55C, KM55R, KM44RC.

Air Filter for STIHL

Length 2-5/8"
Width 3"
Height 1/2"

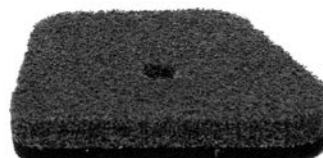

Order No. 27 - 14085

Air filter replaces Stihl 4180-120-1800B. For FE90, FS110, HT101. Air filter/pre-filter combo for trimmers with 4-mix engines FS, FC, KM, HT90, 100, 110, 130. Fits BG45, BG46, BG55, BG65, SH55, SH85 blowers. Woven fabric and foam.

Eyelet Sleeve for STIHL

Order No. 27 - 14577

Eyelet sleeve replaces Stihl 4003-713-8301. Fits model 25-2 Autocut Trimmer Head. MIN005





NEW

NEW ITEMS

Trimmer Head Base Cover for STIHL



Order No. 27 - 14501

Trimmer head base cover replaces Stihl 4002-713-9708. Fits Autocut 25-2 trimmer head. Fits models FS 44, 55, 80, 83, 85, 90, 100, 100RX, 110, 120, 130, 200, 250, KM 55, 85, 90, 110, 130, FS-KM.

Trimmer Head Spool for STIHL



Order No. 27 - 14500

Trimmer head spool replaces Stihl 4002-713-3017. Fits Autocut 25-2 trimmer head. Fits models FS 44, 55, 80, 83, 85, 90, 100, 100RX, 110, 120, 130, 200, 250, KM 55, 85, 90, 110, 130, FS-KM.

Ignition Coil for BRIGGS & STRATTON



Order No. 31 - 14561

Ignition coil replaces B&S 799651. Fits engine model series M21 / 31 / 33 / 40 / 44.

Ignition Coil for STIHL



Order No. 31 - 14041

Ignition coil replaces Stihl 1122-400-1314. Fits chainsaw models 046, 066, MS460, MS650 and MS660.

Ignition Module for POULAN



Order No. 31 - 14460

Ignition module replaces Poulan 530039218. 8 deg.

Voltage Regulator for JOHN DEERE



Order No. 31 - 14029

Voltage regulator replaces John Deere M97348, AM126304, M70121. This is the new style heavy duty regulator. The plug part number AM108848 is included. Fits models 240, 245, 260, 265, 285, 320, 425, 445, 455, 325, 335, 345, 355D, LX172, LX176, LX178, LX186, LX188, LX277, LX279, LX289, X475, X485, X495, X575, X585.

KOHLER Point Set



Order No. 31 - 4715003S

Kohler 4715003S OEM point set. For K91-361, KT series K532-582.

Solenoid for SCAG



Order No. 31 - 14427

Solenoid replaces Scag 483278.

Ignition Switch for SNAPPER



Order No. 31 - 12839

Ignition switch replaces Snapper 7072684YP, Scag 483472, Ariens 03277000, Bush Hog 50047912. Plastic snap bezel. 3 position 5 terminals.

Ignition Switch for TORO



Order No. 31 - 14454

Ignition switch replaces Toro 116-0050. Fits Z500 Z Master. Plastic snap in bezel. 3 position, 5 terminals. Keys not included. Uses our 31-2932 or 31-10794 keys.

NEW ITEMS FOR 2014



NEW

NEW ITEMS

Ignition Switch for TORO



Order No. 31 - 14652

Ignition switch replaces Toro 117-2221. Fits most Z Master 2010 and newer, TimeCutter ZS-SS, Titan zero turn mowers. Also fits Exmark Lazer Z S/N 920,000 & up; Lazer Z S/N 850,000 and up, Quest models. Plastic snap in bezel. 3 position, 6 terminals. Keys not included.

Ignition Switch for SIMPLICITY



Order No. 31 - 14672

Ignition switch replaces Simplicity 7017817YP, 1664804SM Scag 48609, Snapper 7017817, Troy Bilt GW1758145, MTD & Troy Bilt: 925-0873, Exmark 1-403121. 2 position, 2 terminals, 5/8" mounting stem. On/Off switch, includes hardware.

WALL RBG 712 Blade Sharpener/Grinder



Order No. 32 - 11706

Restore blades to a factory flat edge using our preset blade guide to maintain the proper angle for the best cut and edge life. By replacing traditional grinding wheels the RBG 712 will reduce your work time while eliminating grinding wheel dust and wheel dressing. The unique design will allow you to grind any length of cutting edge required for both standard right-hand and reverse left hand rotation flat blades. With the addition of the optional grit collector you can maintain a cleaner and safer shop while sharpening blades. 1/2 hp, 7" disc wheel.

WALL Grit Collector for RBG 712



Order No. 32 - 11707

Wall Grinder Grit Collector. Fits our 32-11706 Grinder.

WALL Disc Wheel for RBG 712

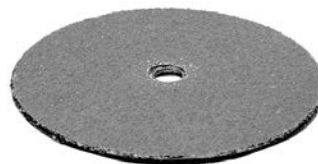

Order No. 32 - 11710

Wall 7" Disc Wheel. Fits our 32-11706 Grinder.

Piston Ring Assembly Tool for HUSQVARNA

Order No. 32 - 14626

Piston ring assembly tool kit. Replaces Husqvarna 502-50 70-01. Useful for assembling pistons and cylinders on chainsaws. 4 sizes of clamps. Give yourself a third hand with this kit. This kit will compress piston rings ranging from 30mm to 60mm in diameter. Includes a piston support block and piston stop.



Spring Motor Return for SUPER JOLLY



Order No. 32 - 14613

Spring motor return for Super Jolly. Fits our 32-14421.

Chain Stop for SUPER JOLLY



Order No. 32 - 14614

Chain stop for Super Jolly. Fits our 32-14421.



NEW

NEW ITEMS

Light Bulb for Grinders



Order No. 32 - 14607
Light bulb for grinders. Fits most Grinders

Vise Bottom for JOLLY STAR



Order No. 32 - 14612
Vise bottom for Jolly Star.

Pawl Kit for JOLLY STAR



Order No. 32 - 14611
Pawl kit for Jolly Star.

Vise Assembly for JOLLY STAR



Order No. 32 - 14610
Vise assembly for Jolly Star.

Swivel for Base for JOLLY STAR



Order No. 32 - 14609
Swivel for Base for Jolly Star.

Spring Motor Return for JOLLY STAR



Order No. 32 - 14608
Spring motor return for Jolly Star.

Tire Bead Lube

Order No. 32 - 12975

Tire bead lube. Delta first bead lube concentrate is probably the slipperiest in the industry. The turquoise colored concentrate can be mixed 3 to 1 with tap water to make an efficient and economical mounting lube. It's much slicker than mounting paste and allows tires to easily slide and get the bead properly mounted on the rim. Also contains a rust-inhibitor package that will not allow rust to form on the rim. Its entirely non-toxic, odorless, and environmentally friendly. 4 per case. Concentrate 1 gallon.



Fuel Test Swab from B3C Fuel Solutions



Order No. 32 - 14429
Fuel test swab from B3C fuel Solutions.

Insect Repelling Super Band



Order No. 33 - 14461

Insect repelling super band. Repels Mosquitoes, Biting Flies, Gnats, Sand Flies, Bees and many other annoying flying pest. The essential natural oils that are used are non-toxic and safe for children and pets and completely Deet Free. Once opened, the band is activated and keeps repelling insects for up to 200 hours. Counter display 50 pcs.

NEW ITEMS FOR 2014



NEW

Gasoline Tank Snake from B3C Fuel Solutions

Order No. 33 - 14642

Gasoline Tank Snake from B3C fuel solutions. Fuel tank water absorber plus stabilizer. Stabilizes up to 1 year. Turns blue when full of water, prevents repairs, leave in protection.



NEW ITEMS

Semi-Chisel Saw Chain Cut Loop from CARLTON

			CARLTON SAW CHAIN	
Pitch	Gauge	Drive Links	Order No.	Carlton No.
3/8" X .058				
Chisel (Guard Link)				
3/8"	.058	68	34 - 14635	A2EP-GL-068G



Fits our 34-13064 Combo.

Metering Diaphragm for ZAMA



Order No. 38 - 14083

Metering diaphragm replaces Zama A015010. Fits Zama C1U, MIN010

Gasket & Diaphragm Kit for STIHL

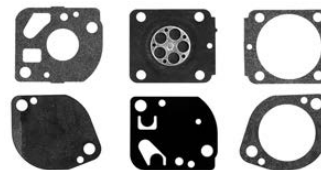

Order No. 38 - 14653

Gasket & diaphragm kit replaces Stihl 4180-007-1060. Fits C1 Q carburetors, Zama GND-91.

Gasket & Diaphragm Kit for STIHL

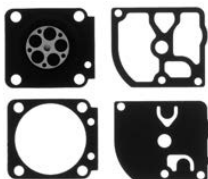

Order No. 38 - 14654

Gasket & diaphragm kit replaces Stihl 1129-007-1062. Fits C1 Q carburetors, Zama GND-98.

Fuel Line for STIHL



Order No. 38 - 14257

Fuel line replaces Stihl 1123-358-7701 / 7702. Fits models 021, 023, 025.

Fuel Hose for STIHL



Order No. 38 - 14277

Fuel hose replaces Stihl 1124-358-7700. Fits models MS 650, 066, MS640, MS880, 084, TS 700, 088, MS 780, TS 800, 064, MS660.

Fuel Hose for STIHL



Order No. 38 - 14278

Fuel hose replaces Stihl 1122-647-9400. Fits models 026, 034, 036, 064, 066, MS 260, 361.



Air Filter for ECHO



Width 3-1/2"
Height 3/8"
Length 3"

Order No. 39 - 13166

Air filter replaces Echo 13031039132. Fits models CS-300, CS301, CS305, CS306, CS341, CS346, CS3000, CS3400, CS3450.

Friction Rubber Wheel for MTD



OD 4-7/8"
Thick 1/2"
ID 3-7/8"

Order No. 41 - 5612

Friction rubber wheel replaces MTD 935-0243B, 735-0243. Rubber disc for walk behind snow blowers.

Rotary Low Profile Pink Cap



Order No. 50 - 14650

Rotary Low profile pink cap.

Rotary Low Profile Khaki Cap



Order No. 50 - 14651

Rotary Low profile khaki soft mesh cap.

Pro-Gear Differential



Order No. 42 - 14397

Pro-Gear differential replaces DR trimmer/mower 192301/19230. Fits DR field and brush mower 11.5, 13, 15, 17 and 18 hp walk behind models.

NEW

NEW ITEMS



DISPLAYS/ASSORTMENTS

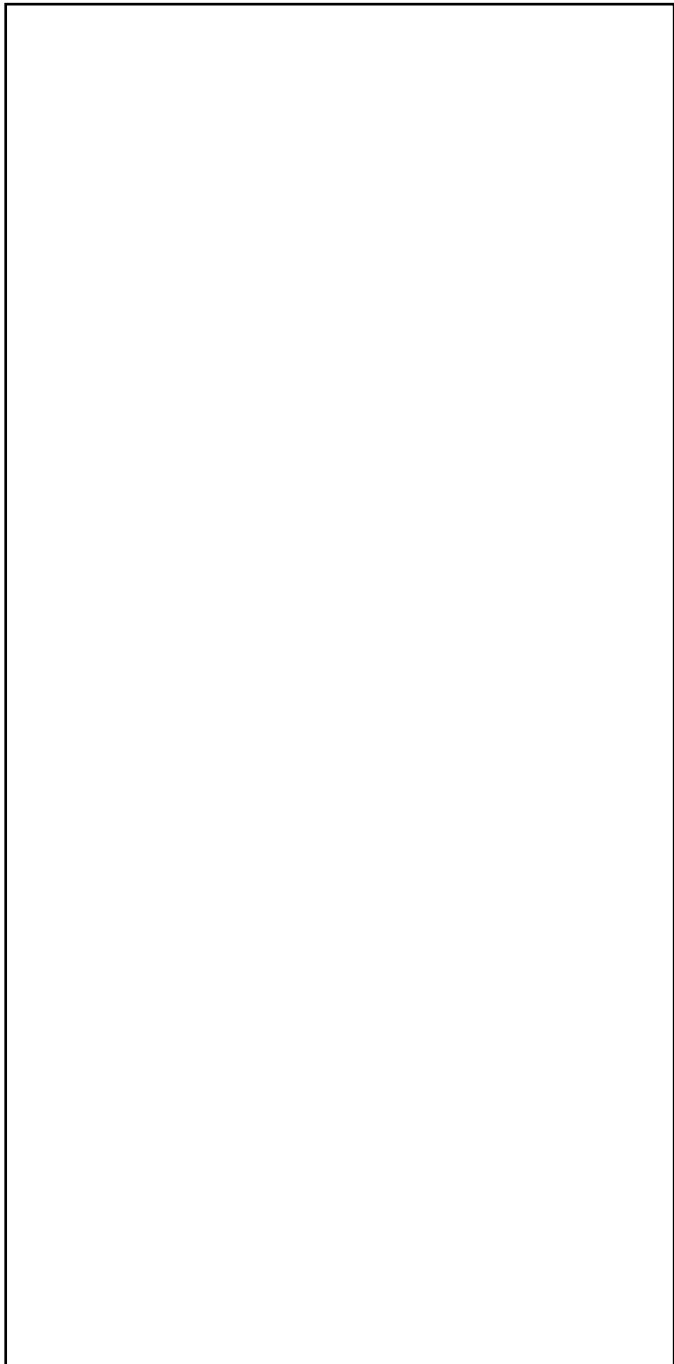
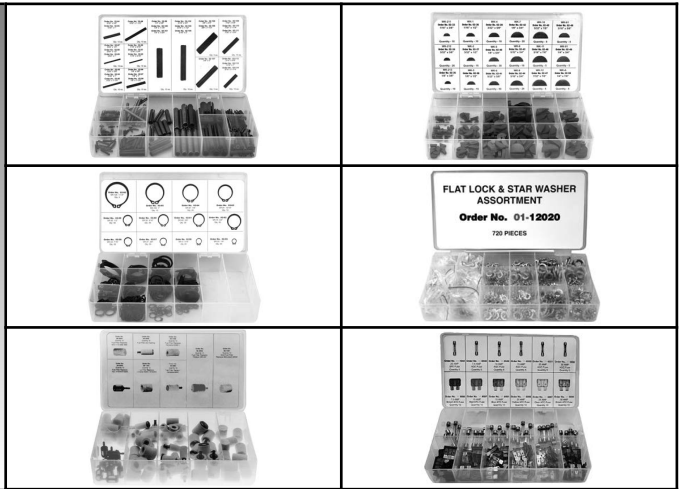

Quick-Glance

ASSORTMENTS/DISPLAYS	PG.
Displays	
Muffler	34
Assortments	
	33-54

01/02

Quick-Glance

DISPLAYS/ASSORTMENTS



Economy Blade Balancer Display



Order No. 33 - 827

Contains 24 inexpensive metal cone blade balancers. They are an accurate way to keep blades balanced and help curb engine vibration. For refills order **33-1756**.

01/02

ASSORTMENTS

Fuel Line and Fitting Assortment



Order No. 01 - 5

Assortment contains 45' of our most popular fuel line and 18 fuel line fittings.

CONTENTS

Order No.	Qty.	Description	
20 - 1354	25'	1/4" Clear Line	
20 - 1353	*10'	3/16" Clear Line	
20 - 1352	*10'	1/8" Clear Line	
20 - 1345	6	Str. Fitting	MIN010
20 - 1346	6	Elbow Fitting	MIN010
20 - 1347	6	Cut-off valves	MIN010

* Order numbers **20-1353** & **20-1352** are priced per 50', all refills will be in 50' rolls.

Muffler Display Assortment



CONTENTS

Qty.	Order No.	Description	
10	18 - 1272	Replaces B&S 298830	
6	18 - 1275	Replaces B&S 294599	
4	18 - 1270	Replaces B&S 89966	
20	18 - 1286	1/2" Muffler lock nut	MIN010
10	18 - 1287	3/4" Muffler lock nut	MIN010

Order No. 01 - 944

Display contains 20 popular mufflers and 30 muffler lock nuts. Double your muffler sales with this impulse buying display. Fits in a 16" x 10" space.



Composite Flat Idler Pulley Assortment Board



Order No. 01 - 10207

Flat Idler Assortment Board 24" x 38". (Composite) Board Only. Used with our 01-10125 Assortment.

Composite V-Idler Pulley Assortment Board



Order No. 01 - 10208

V-Idler Assortment Board 18" x 30". (Composite) Board Only. Used with our 01-10126 Assortment.

Idler Pulley Assortment Board



Order No. 01 - 2695

Idler Pulley Assortment Board. (Composite) Board Only. Used with our 01-717 Assortment.

01/02 ASSORTMENTS

DISPLAYS/ASSORTMENTS



Idler Assortment

Order No. 01 - 717

This assortment contains 24 Idlers with hooks and display board.



CONTENTS

Order

No.	Qty.	Desc.
13 - 718	2	IF-3011
13 - 719	1	IF-3612
13 - 720	1	IF-3616
13 - 721	2	IF-4414
13 - 722	1	IF-4812
13 - 723	2	IF-5212
13 - 724	1	IF-5216
13 - 725	1	IF-5220
13 - 726	1	IF-6412

Order

No.	Qty.	Desc.
13 - 728	2	IV39-A
13 - 729	2	IV40-0
13 - 730	1	IV42-B
13 - 731	1	IV48-A
13 - 732	1	IV48-0
13 - 733	1	IV64-A
13 - 734	2	IV64-B
13 - 714	1	IF-4424
13 - 727	1	IF-6416

For detailed measurements see Idlers in Section 13.

ASSORTMENTS 01/02

Composite V-Belt Idler Pulley Assortment

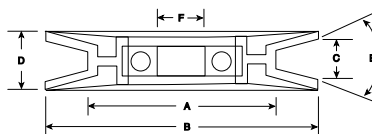

Order No. 13 - 10126

This assortment contains 20 V-Belt Idler Pulleys with hooks and display board. Used with our 01-7842 Bushing Asst.



Order No.	QTY	Description	A	B	C	D	E
13 - 10128	2	VIP2000-2.112	1-3/8"	2"	3/8"	5/8"	10 mm
13 - 10129	2	VIP2500-2.740	1-3/4"	2-1/2"	1/2"	3/4"	11/16"
13 - 10130	2	VIP2875-3.190	1-3/4"	2-7/8"	1/2"	3/4"	11/16"
13 - 10131	2	VIP3000-3.316	1.96"	3"	1/2"	11/16"	11/16"
13 - 10132	2	VIP3480-3.765	2-37/64"	3-31/64"	1/2"	11/16"	11/16"
13 - 10133	2	VIP3560-3.585	2-1/2"	3-9/16"	37/64"	25/32"	11/16"
13 - 10134	2	VIP4000-4.316	2-5/8"	4"	1/2"	7/8"	11/16"
13 - 10135	2	VIP3000-3.105	1-51/64"	3"	41/64"	13/16"	11/16"
13 - 10136	2	VIP3470-3.575	2-17/64"	3-37/64"	41/64"	13/16"	11/16"
13 - 10137	2	VIP4000-4.105	2-51/64"	4"	41/64"	13/16"	11/16"



Composite Flat Idler Pulley Assortment

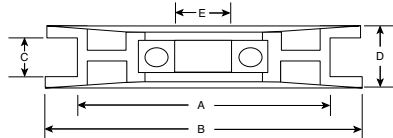

Order No. 01 - 10125

This assortment contains 40 Flat Idler Pulleys with hooks and display board. Used with our 01-7842 Bushing Asst.

Order No.	QTY	Description	A	B	C	D	E
13 - 10138	2	FIP1750-0.75	1-3/4"	2-7/32"	3/4"	15/16"	11/16"
13 - 10139	2	FIP1875-0.50	1-7/8"	2-1/8"	1/2"	45/64"	11/16"
13 - 10140	2	FIP1875-0.75	1-7/8"	2"	3/4"	31/32"	11/16"
13 - 10141	2	FIP2250-0.75	2-1/4"	2-23/32"	1/16"	15/16"	11/16"
13 - 10142	2	FIP2500-0.75	2-1/2"	2-31/32"	3/4"	1-3/16"	11/16"
13 - 10143	2	FIP2500-1.00	2-1/2"	2-31/32"	1"	1-3/16"	11/16"
13 - 10144	2	FIP2750-0.75	2-3/4"	3-7/32"	3/4"	15/16"	11/16"
13 - 10145	2	FIP2750-0.86	2-3/4"	3-3/16"	3/32"	1-1/16"	11/16"
13 - 10146	2	FIP2750-1.00	2-3/4"	3-7/32"	1"	1-3/16"	11/16"
13 - 10147	2	FIP3000-0.75	3"	3-1/2"	3/4"	1"	11/16"
13 - 10148	2	FIP3000-1.01	3"	3-31/64"	1"	1-3/16"	11/16"
13 - 10149	2	FIP3120-0.75	3-1/8"	4"	3/4"	1-1/8"	11/16"
13 - 10150	2	FIP3500-0.75	3-1/2"	4-1/8"	3/4"	1"	11/16"
13 - 10151	2	FIP3500-0.97	3-1/2"	3-31/32"	1"	15/32"	11/16"
13 - 10152	2	FIP4000-0.72	4"	4-39/64"	23/32"	1-1/16"	11/16"
13 - 10153	2	FIP4000-0.86	4"	4-3/4"	7/8"	1-11/32"	11/16"
13 - 10154	2	FIP4000-1.00	4"	4-5/8"	1"	1-3/16"	11/16"
13 - 10155	2	FIP4500-0.96	4-1/2"	4-31/32"	31/32"	1-1/8"	11/16"
13 - 10156	2	FIP5000-1.25	5"	5-1/2"	1-1/4"	1-1/2"	11/16"
13 - 10157	2	FIP6000-0.75	6"	6-1/2"	1"	1-9/32"	11/16"

01/02 ASSORTMENTS

DISPLAYS/ASSORTMENTS



Bushing Assortment for Idler Pulleys



Order No. 01 - 7842

This assortment contains 12 (total of 114) popular size reducer bushings used in most Idler pulley applications.

CONTENTS

Order No.	Qty.	Description	
13 - 10965	10	.313" ID x .390" OD x 12mm HT	MIN010
13 - 10966	10	.375" ID x .270" OD x 12mm HT	MIN010
13 - 7846	10	.375" ID x .310" OD x 12mm HT	MIN010
13 - 7847	10	.375" ID x .410" OD x 12mm HT	MIN010
13 - 7849	10	.375" ID x .460" OD x 12mm HT	MIN010
13 - 10967	10	.375" ID x .510" OD x 12mm HT	MIN010
13 - 10969	7	.375" ID x .590" OD x 12mm HT	MIN010
13 - 7850	10	.500" ID x .270" OD x 12mm HT	MIN010
13 - 7848	7	.500" ID x .760" OD x 12mm HT	MIN010
13 - 7851	10	.375" ID x 17mm OD x 12mm HT	MIN010
13 - 10964	10	12mm ID x 17mm OD x 12mm HT	MIN010
13 - 7852	10	.500" ID x 17mm OD x 12mm HT	MIN010

ASSORTMENTS 01/02

Snap Ring Assortment



Order No. 01 - 7

Assortment contains 300 pieces.

CONTENTS

Order No.	Qty.	Description/Size	
02 - 55	30	SR-25 1/4"	MIN010
02 - 56	20	SR-31 5/16"	MIN010
02 - 57	50	SR-37 3/8"	MIN010
02 - 58	20	SR-43 7/16"	MIN010
02 - 59	50	SR-50 1/2"	MIN010
02 - 60	20	SR-56 9/16"	MIN010
02 - 61	30	SR-62 5/8"	MIN010
02 - 62	35	SR-75 3/4"	MIN010
02 - 63	10	SR-81 13/16"	MIN010
02 - 64	20	SR-87 7/8"	MIN010
02 - 65	10	SR-100 1"	MIN010
02 - 66	5	SR-125 1-1/4"	MIN010



DISPLAYS/ASSORTMENTS

Shoulder Bolt Assortment

Order No.	Qty.	CONTENTS Shoulder Length	
10 - 311	4	1-5/16" Bolts	MIN010
10 - 312	12	1-3/8" Bolts	MIN010
10 - 313	4	1-7/16" Bolts	MIN010
10 - 314	12	1-1/2" Bolts	MIN010
10 - 316	12	1-5/8" Bolts	MIN010
10 - 317	12	1-3/4" Bolts	MIN010
10 - 318	4	1-7/8" Bolts	MIN010
10 - 319	4	2" Bolts	MIN010
10 - 320	4	2-1/4" Bolts	MIN010
10 - 321	68	3/8" Lock Nuts	MIN010



Order No. 01 - 1
Assortment contains 136 pieces.

Blade Bolt Assortment

Order No.	Qty.	CONTENTS Description	
17 - 1202	10	3/8" x 24 x 1-1/4" Bolts	MIN010
17 - 1203	20	3/8" x 24 x 1-1/2" Bolts	MIN010
17 - 1204	20	3/8" x 24 x 1-3/4" Bolts	MIN010
17 - 1205	10	3/8" x 24 x 2" Bolts	MIN010
17 - 1206	10	3/8" x 24 x 2-1/4" Bolts	MIN010
17 - 1207	10	3/8" x 24 x 2-1/2" Bolts	MIN010
17 - 1208	10	3/8" x 24 x 3" Bolts	MIN010
02 - 41	100	No. 6 Key	MIN010
17 - 141	100	3/8" Lock Washers	MIN010



Order No. 01 - 2
Assortment contains 290 pieces. No. 1035 Steel Heat Treated.

Blade Washer Assortment

Order No.	Qty.	CONTENTS Description	
17 - 1213	60	3/8" Fibre Washer	MIN010
17 - 1214	20	1/2" Fibre Washer	MIN010
17 - 1215	20	5/8" Fibre Washer	MIN010
17 - 1216	10	3/4" Fibre Washer	MIN010
17 - 1217	10	7/8" Fibre Washer	MIN010
17 - 1218	10	1" Fibre Washer	MIN010
17 - 1219	10	1-1/8" Fibre Washer	MIN010
17 - 1220	10	1-1/4" Fibre Washer	MIN010
17 - 1221	10	3" x 3/8" Fibre Washer	MIN010
17 - 1190	5	3" x 3/8" Steel Washer	MIN010
17 - 1188	10	2-1/4" x 3/8" St. Washer	MIN010
17 - 1187	10	3/8" Serrated Washer	MIN010

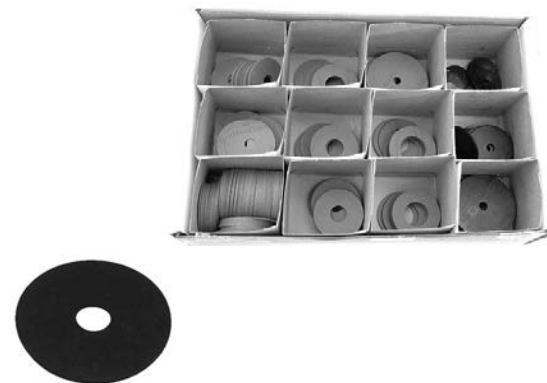

Order No. 01 - 3
Assortment contains 185 pieces.

Wheel Bearing Assortment

Order No.	Qty.	CONTENTS Description	
09 - 324	10	1/2" x 1-1/8" Ball Brg	
09 - 325	4	1/2" x 1-3/8" Ball Brg	
09 - 326	6	5/8" x 1-3/8" Ball Brg	
09 - 327	4	3/4" x 1-3/8" Ball Brg	
09 - 330	10	3/8" x 1/2" Bushing	MIN010
09 - 331	10	7/16" x 1/2" Bushing	MIN010
09 - 332	6	1/2" x 5/8" Bushing	MIN010
09 - 329	20	Nylon Bushing	MIN010



Order No. 01 - 4
Assortment contains 70 pieces.

01/02 ASSORTMENTS

DISPLAYS/ASSORTMENTS



Woodruff Key Assortment

CONTENTS

Order No.	Qty.	Description/Size	MINO10
02 - 33	10	WK-211 1/16" x 3/8"	MINO10
02 - 34	20	WK-212 3/32" x 3/8"	MINO10
02 - 35	10	WK-213 1/8" x 3/8"	MINO10
02 - 36	10	WK-1 1/16" x 1/2"	MINO10
02 - 37	15	WK-2 3/32" x 1/2"	MINO10
02 - 38	15	WK-3 1/8" x 1/2"	MINO10
02 - 39	10	WK-4 3/32" x 5/8"	MINO10
02 - 40	30	WK-5 1/8" x 5/8"	MINO10
02 - 41	50	WK-6 5/32" x 5/8"	MINO10
02 - 42	20	WK-7 1/8" x 3/4"	MINO10
02 - 43	10	WK-8 5/32" x 3/4"	MINO10
02 - 44	20	WK-9 3/16" x 3/4"	MINO10
02 - 45	5	WK-10 5/32" x 7/8"	MINO10
02 - 46	5	WK-11 3/16" x 7/8"	MINO10
02 - 47	5	WK-12 7/32" x 7/8"	MINO10
02 - 48	5	WK-61 3/16" x 5/8"	MINO10
02 - 49	5	WK-91 1/4" x 3/4"	MINO10
02 - 50	5	WK-A 1/4" x 7/8"	MINO10



Order No. 01 - 6

Assortment contains 250 pieces.

Note: Order No. 02-40 fits Foote Transmission. Order No. 02-41 is most popular. Replaces Briggs & Stratton 93065 and Murray 20062. Order No. 02-42 is for Tecumseh 7 & 8 hp.

ASSORTMENTS 01/02

Roll Pin Assortment

CONTENTS

Order No.	Qty.	Description	MINO10
02 - 84	10	5/32" x 5/8"	MINO10
02 - 85	10	5/32" x 1"	MINO10
02 - 86	10	5/32" x 1-1/2"	MINO10
02 - 87	10	5/64" x 1/4"	MINO10
02 - 88	10	5/64" x 1/2"	MINO10
02 - 89	10	5/64" x 1"	MINO10
02 - 90	10	1/16" x 3/16"	MINO10
02 - 91	10	1/16" x 3/4"	MINO10
02 - 92	10	1/16" x 5/16"	MINO10
02 - 93	10	3/32" x 5/8"	MINO10
02 - 94	10	3/32" x 1"	MINO10
02 - 95	10	3/32" x 1-1/4"	MINO10
02 - 96	15	1/8" x 5/8"	MINO10
02 - 97	15	1/8" x 1"	MINO10
02 - 98	15	1/8" x 1-1/4"	MINO10
02 - 99	10	1/4" x 5/8"	MINO10
02 - 100	10	1/4" x 1-1/4"	MINO10
02 - 101	10	1/4" x 1-3/4"	MINO10
02 - 102	10	5/16" x 3/4"	MINO10
02 - 103	10	5/16" x 1-1/2"	MINO10
02 - 104	10	5/16" x 2"	MINO10
02 - 105	5	3/8" x 3/4"	MINO10
02 - 106	5	3/8" x 1-1/2"	MINO10
02 - 107	5	3/8" x 2"	MINO10
02 - 108	10	7/32" x 5/8"	MINO10
02 - 110	10	7/32" x 1-1/4"	MINO10
02 - 111	10	7/32" x 1-3/4"	MINO10
02 - 112	15	3/16" x 5/8"	MINO10
02 - 113	15	3/16" x 1"	MINO10
02 - 114	15	3/16" x 1-1/4"	MINO10



Order No. 01 - 9

Assortment contains 315 pieces.

Note: Order No. 02-100 fits on Merry Tiller Gears.



DISPLAYS/ASSORTMENTS

Allen Set Screw Assortment

CONTENTS

Order No.	Qty.	Description/Dia./Lgth		
02 - 119	20	AS-1414-F 1/4" 1/4"	MIN010	
02 - 120	30	AS-1414-C 1/4" 1/4"	MIN010	
02 - 121	20	AS-51638-F 5/16" 3/8"	MIN010	
02 - 122	30	AS-51638-C 5/16" 3/8"	MIN010	
02 - 124	10	AS-3838-F 3/8" 3/8"	MIN010	
02 - 125	10	AS-3838-C 3/8" 3/8"	MIN010	
02 - 126	20	AS-51612-C 5/16" 1/2"	MIN010	
02 - 127	10	AS-18316-C 1/8" 3/16"	MIN010	
02 - 128	10	AS-31614-C 3/16" 1/4"	MIN010	
02 - 129	10	AS-3812-C 3/8" 1/2"	MIN010	
02 - 130	20	AS-1438-C 1/4" 3/8"	MIN010	

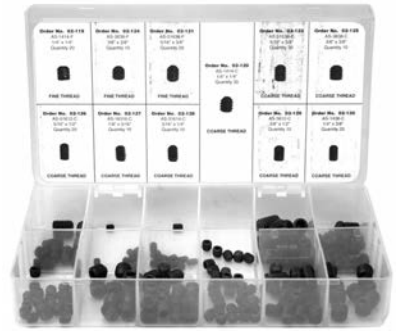

Order No. 01 - 10
Assortment contains 190 pieces.

C=Coarse Thread, F= Fine Thread

E-Clip Assortment

CONTENTS

Order No.	Qty.	Description/Size		
02 - 71	30	EC-116 1/16"	MIN010	
02 - 72	30	EC-18 1/8"	MIN010	
02 - 73	40	EC-316 3/16"	MIN010	
02 - 74	50	EC-14 1/4"	MIN010	
02 - 75	50	EC-38 3/8"	MIN010	
02 - 76	40	EC-12 1/2"	MIN010	
02 - 77	20	EC-58 5/8"	MIN010	
02 - 78	20	EC-34 3/4"	MIN010	
02 - 79	20	EC-78 7/8"	MIN010	



Order No. 01 - 8
Assortment contains 300 pieces.

Cotter Pin Assortment

CONTENTS

Order No.	Qty.	Description		
02 - 135	150	CP-101 1/16" x 1"	MIN010	
02 - 136	150	CP-102 3/32" x 1"	MIN010	
02 - 137	100	CP-103 3/32" x 1-3/4"	MIN010	
02 - 138	75	CP-104 1/8" x 1-1/4"	MIN010	
02 - 139	50	CP-105 1/8" x 2"	MIN010	
02 - 140	30	CP-106 5/32" x 2-1/2"	MIN010	

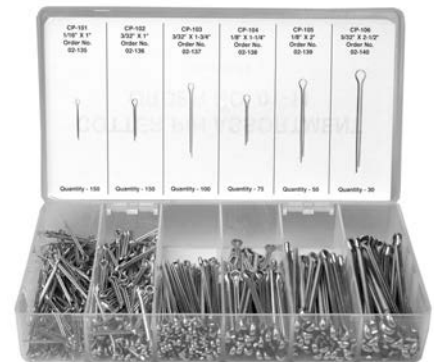

Order No. 01 - 11
Assortment contains 555 pieces.

Wing Nut Assortment

CONTENTS

Order No.	Qty.	Description		
02 - 190	45	Wing Nut 6-32	MIN010	
02 - 191	40	Wing Nut 8-32	MIN010	
02 - 192	30	Wing Nut 10-24	MIN010	
02 - 193	25	Wing Nut 1/4-20	MIN010	
02 - 194	20	Wing Nut 5/16-18	MIN010	
02 - 195	15	Wing Nut 3/8-16	MIN010	



Order No. 01 - 20
Assortment contains 175 pieces.

01/02 ASSORTMENTS

DISPLAYS/ASSORTMENTS



Governor Spring Assortment

CONTENTS

Order No.	Qty.	Replaces B&S No./Description	
22 - 7733	10	260871 Gov. Spring	MIN010
22 - 7735	10	262572 Gov. Spring	MIN010
22 - 7736	10	262505 Gov. Spring	MIN010
22 - 7737	10	262656 Gov. Spring	MIN010
22 - 7738	10	262664 Gov. Spring	MIN010
22 - 7739	20	262678 Gov. Spring	MIN010
22 - 7740	20	262759 Gov. Spring	MIN010
22 - 7741	10	262784 Gov. Spring	MIN010



Order No. 01 - 7743

Assortment contains 100 pieces of most popular governor spring used on 5, 14, 16, 18 hp Vanguard, 5 hp Quantum, 5 hp Europa, 3.75 Sprint and 12-1/2 hp IC B&S engines.

ASSORTMENTS 01/02

Governor Spring Assortment

CONTENTS

Order No.	Qty.	Replaces B&S No./Description-RPM	
22 - 172	10	260703 Gov. Spring	MIN010
22 - 171	10	260875 Gov. Spring	MIN010
		3400-3600 (260877)	
22 - 178	10	260545 Gov. Spring	MIN010
22 - 179	5	260591 Gov. Spr. 3400-3600	MIN010
22 - 176	10	260832 Gov. Spr. 4000-4200	MIN010
22 - 184	10	26925 Gov. Spring	MIN010
22 - 173	10	260599 Gov. Spr. 4000-4200	MIN010
22 - 177	5	26763 Gov. Spring	MIN010
22 - 180	5	260025 Gov. Spring	MIN010
22 - 175	5	260596 Gov. Spr. 4000-4200	MIN010
22 - 170	10	260878 Gov. Link	MIN010
22 - 174	10	260041 Gov. Spring	MIN010

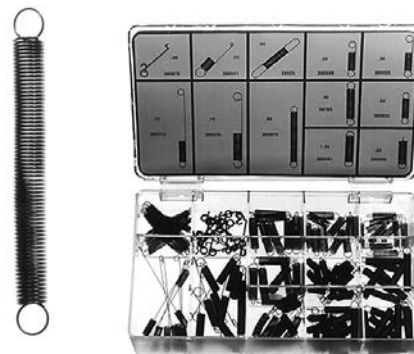

Order No. 01 - 13

Assortment contains 100 pieces.

See Section 22 for a complete listing of Governor Springs

Universal Spring Assortment

CONTENTS

Order No.	Qty.	Extension Item	Size	
02 - 2409	10	US-1009	1/4" x 7/8"	MIN010
02 - 2410	10	US-1010	7/32" x 1"	MIN010
02 - 2411	10	US-1011	3/16" x 1-3/4"	MIN010
02 - 2412	10	US-1012	5/16" x 1-1/8"	MIN010
02 - 2413	10	US-1013	5/16" x 1-1/4"	MIN010
02 - 2414	10	US-1015	9/32" x 1-1/2"	MIN010
02 - 2415	10	US-1016	11/32" x 1-7/16"	MIN010
02 - 2416	10	US-1017	.350" x 1-27/32"	MIN010
02 - 2417	10	US-1018	9/32" x 2-3/16"	MIN010
02 - 2418	10	US-1019	5/16" x 1-3/4"	MIN010
02 - 2419	10	US-1020	5/32" x 3-1/8"	MIN010
Compression				
02 - 2400	10	US-1001	9/32" x 1/2"	MIN010
02 - 2401	10	US-1002	1/4" x 13/32"	MIN010
02 - 2402	10	US-1003	7/32" x 11/16"	MIN010
02 - 2403	10	US-1004	3/8" x 5/8"	MIN010
02 - 2404	10	US-1005	3/8" x 3/4"	MIN010
02 - 2405	10	US-1006	7/32" x 1-1/2"	MIN010
02 - 2406	10	US-1007	23/64" x 1-3/8"	MIN010
02 - 2407	10	US-1014	9/32" x 3/4"	MIN010

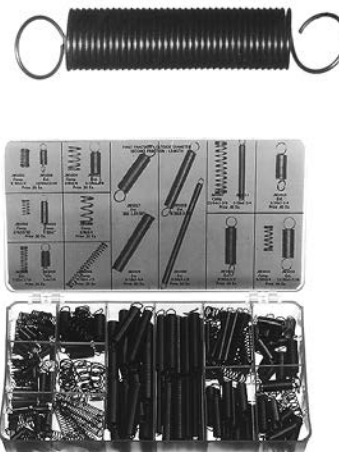

Order No. 01 - 14

Assortment contains 200 pieces.



DISPLAYS/ASSORTMENTS

Neoprene O-Ring Assortment

CONTENTS

Order No.	Qty.	Description	
02 - 145	20	006 1/8" x 1/4"	MIN010
02 - 146	20	007 5/32" x 9/32"	MIN010
02 - 147	20	008 3/16" x 5/16"	MIN010
02 - 148	15	009 7/32" x 11/32"	MIN010
02 - 149	15	010 1/4" x 3/8"	MIN010
02 - 150	15	011 5/16" x 7/16"	MIN010
02 - 151	10	012 3/8" x 1/2"	MIN010
02 - 152	10	110 3/8" x 9/16"	MIN010
02 - 153	10	111 7/16" x 5/8"	MIN010
02 - 154	10	112 1/2" x 11/16"	MIN010
02 - 155	10	113 9/16" x 3/4"	MIN010
02 - 156	10	114 5/8" x 13/16"	MIN010
02 - 157	10	115 11/16" x 7/8"	MIN010
02 - 158	10	116 3/4" x 15/16"	MIN010
02 - 159	10	210 3/4" x 1"	MIN010
02 - 160	10	211 13/16" x 1-1/16"	MIN010
02 - 161	10	212 7/8" x 1-1/8"	MIN010
02 - 162	10	213 15/16" x 1-3/16"	MIN010

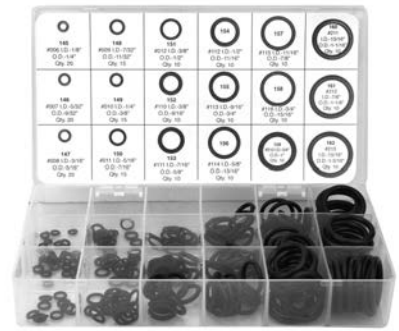

Order No. 01 - 12

Assortment contains 225 pieces.

Order No. 145-151 = .070 Thickness
 Order No. 152-158 = .100 Thickness
 Order No. 159-162 = .140 Thickness

Note: Order No. 23-158. Fits B&S 270349 Intake tubes, and Order No. 02-156. Replaces B&S 271485.

Master Shop Assortment

CONTENTS

Order No.	Qty.	Description	
02 - 41	50	WK-6 5/32" x 5/8"	MIN010
02 - 48	50	WK-61 3/16" x 5/8"	MIN010
02 - 61	40	SR-62 5/8"	MIN010
02 - 62	50	SR-75 3/4"	MIN010
02 - 77	50	EC-58 5/8"	MIN010
02 - 75	40	EC-38 3/8"	MIN010
02 - 104	25	Roll Pin 5/16" x 2"	MIN010
02 - 114	40	Roll Pin 3/16" x 1-1/4"	MIN010
02 - 119	40	AS1414F 1/4" x 1/4"	MIN010
02 - 122	40	AS51638C 5/16" x 3/8"	MIN010
02 - 149	50	OR-010 1/4" x 3/8"	MIN010
02 - 138	50	Cotter Pin 1/8" x 1-1/4"	MIN010
02 - 24	10	HPC-101 1/16" x 1-3/8"	MIN010
02 - 25	10	HPC-102 3/32" x 1-5/8"	MIN010
02 - 163	10	Grease Fitting 1/4" - 28	MIN010



Order No. 01 - 21

Assortment contains 555 pieces.

Hose Clamp Assortment



Order No. 01 - 7204

Hose Clamp Assortment contains 6 of the most popular sizes of hose clamps. Assortment contains 120 pieces.

CONTENTS

Order No.	Qty.	Description	
20 - 3450	20	Hose clamp, 7/32" to 5/8"	MIN010
20 - 3451	20	Hose clamp, 1/2" to 29/32"	MIN010
20 - 3452	20	Hose clamp, 9/16" to 1-1/16"	MIN010
20 - 5903	20	For our 3/16" clear fuel line	MIN010
20 - 5904	20	For our 1/4" clear & blk. tubing	MIN010
20 - 5905	20	For our 1/4" Nitrile tubing	MIN010

Note: For refills refer to above listings. Refills packaged in lots of 10.

DISPLAYS/ASSORTMENTS



Grease Fitting Assortment

CONTENTS

Order No.	Qty.	Description	
02 - 163	30	Straight 1/4" - 28	MIN010
02 - 164	20	45° Elbow 1/4" - 28	MIN010
02 - 165	20	90° Elbow 1/4" - 28	MIN010
02 - 166	30	Straight 1/8" Pipe	MIN010
02 - 167	20	45° Elbow 1/8" Pipe	MIN010
02 - 168	10	90° Elbow 1/8" Pipe	MIN010



Order No. 01 - 17

Assortment contains 130 pieces.

Metric Grease Fitting Assortment

CONTENTS

Order No.	Qty.	Description	
02 - 5910	20	Fitting (straight) 6 x 1	MIN010
02 - 5911	20	Fitting 45° 6 x 1	MIN010
02 - 5912	20	Fitting 90° 6 x 1	MIN010
02 - 5913	20	Fitting (straight) 8 x 1	MIN010
02 - 5914	20	Fitting (straight) 10 x 1	MIN010

Note: Order No. 02-5913 fits Maruyama.



Order No. 01 - 5897

Contains 5 sizes of the most popular metric grease fittings. Assortment contains 100 pieces.

Tine Pin Assortment

CONTENTS

Order No.	Qty.	Description	
02 - 67	10	Tine Pin 5/16" x 2"	MIN010
02 - 68	24	Tine Pin 3/8" x 2-1/4"	MIN010
02 - 69	5	Tine Pin 7/16" x 2-1/2"	MIN010
02 - 70	5	Tine Pin 1/2" x 2"	MIN010
02 - 24	10	HPC-101 1/16" x 1-3/8"	MIN010
02 - 25	29	HPC-102 3/32" x 1-5/8"	MIN010
02 - 27	5	HPC-104 1/8" x 1-7/8"	MIN010

ASSORTMENTS 01/02

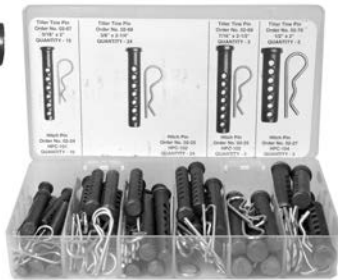
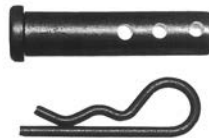

Order No. 01 - 18

Assortment contains 88 pieces.

Blade Reducer Assortment

CONTENTS

Order No.	Qty.	Description	
17 - 1195	10	3/8" Reducer	MIN010
17 - 1196	10	7/16" Reducer	MIN010
17 - 1197	10	1/2" Reducer	MIN010
17 - 1198	10	9/16" Reducer	MIN010
17 - 1199	10	5/8" Reducer	MIN010
17 - 1200	10	3/4" Reducer	MIN010
17 - 1201	10	7/8" Reducer	MIN010



Order No. 01 - 19

Assortment contains 70 pieces.

Hair Pin Cotter Assortment

CONTENTS

Order No.	Qty.	Description	
02 - 24	50	HPC-101 1/16" x 1-3/8"	MIN010
02 - 25	30	HPC-102 3/32" x 1-5/8"	MIN010
02 - 26	20	HPC-103 3/32" x 2-1/4"	MIN010
02 - 27	20	HPC-104 1/8" x 1-7/8"	MIN010
02 - 28	15	HPC-105 5/32" x 2-7/8"	MIN010
02 - 29	6	HPC-106 3/16" x 3-1/4"	MIN010



Order No. 01 - 16

Assortment contains 141 pieces.

Note: Order No. 02-24 replaces Snapper 76988. Order No. 02-26 replaces Toro 3290-355.



Solderless Terminals And Connectors

Order No.	Qty.	Description	Size	Color	Design
02 - 200	10	Spade	16-14	blue	MIN010
02 - 207	10	Spade	22-18	red	MIN010
02 - 209	10	Spade	12-10	yellow	MIN010
02 - 211	10	Spade 11/16"	12-10	yellow	MIN010
02 - 214	10	Spade 11/64"	22-18	red	MIN010
02 - 217	10	Spade 11/64"	16-14	blue	MIN010
02 - 203	10	Ring Connector	22-18	red	MIN010
02 - 206	10	Ring Connector	12-10	yellow	MIN010
02 - 208	10	Ring Connector	16-14	blue	MIN010
02 - 213	10	Ring 11/64"	16-14	blue	MIN010
02 - 216	10	Ring 9/64"	22-18	red	MIN010
02 - 218	10	Ring 11/64"	12-10	yellow	MIN010
02 - 202	10	Oval Butt Conn.	12-10	yellow	MIN010
02 - 204	10	Oval Butt Conn.	16-14	blue	MIN010
02 - 210	10	Oval Butt Conn.	22-18	red	MIN010
02 - 201	10	Female Slip-On	16-14	blue	MIN010
02 - 205	10	Male Slip-On	16-14	blue	MIN010
02 - 212	5	Wire Splice		blue	MIN010



Order No. 01 - 22
Assortment contains 175 pieces.

01/02 ASSORTMENTS

Wire Connectors



Order No. 31 - 6716
For 22 thru 14 AWG wire. (gray) MIN100

Order No. 31 - 6717
For 22 thru 14 AWG wire. (blue) MIN100

Electrical Wire Stripper/Crimper Tool



Order No. 32 - 6718
Electrical Stripper/Crimper Tool. The fast, easy and professional way to strip electrical wire. Used to strip primary wire.

Primary Wire (for L/M, Auto, & Marine) 25' Rolls



- Order No. 31 - 6711**
25' of 16 AWG primary wire. (red)
- Order No. 31 - 6712**
25' of 16 AWG primary wire. (black)
- Order No. 31 - 6713**
25' of 16 AWG primary wire. (white)
- Order No. 31 - 6714**
25' of 16 AWG primary wire. (blue)
- Order No. 31 - 6715**
25' of 16 AWG primary wire. (yellow)

Primary Wire (for L/M, Auto, & Marine) 100' Rolls



- Order No. 31 - 6815**
100' of 16 AWG primary wire. (red)
- Order No. 31 - 6816**
100' of 16 AWG primary wire. (black)
- Order No. 31 - 6817**
100' of 16 AWG primary wire. (white)
- Order No. 31 - 6818**
100' of 16 AWG primary wire. (blue)
- Order No. 31 - 6819**
100' of 16 AWG primary wire. (yellow)

DISPLAYS/ASSORTMENTS



Fuse Assortment



CONTENTS

Order No.	Qty.	Description	
31 - 1948	5	Fuse, 20 AMP SFE	MIN005
31 - 6548	5	Fuse, 7.5 AMP AGC	MIN005
31 - 6549	5	Fuse, 10 AMP AGC	MIN005
31 - 6550	5	Fuse, 15 AMP AGC	MIN005
31 - 6551	5	Fuse, 20 AMP AGC	MIN005
31 - 6552	5	Fuse, 30 AMP AGC	MIN005
31 - 8086	10	Fuse, 7.5 AMP ATC	MIN005
31 - 8087	10	Fuse, 10 AMP ATC	MIN005
31 - 8491	10	Fuse, 15 AMP ATC	MIN005
31 - 8088	10	Fuse, 20 AMP ATC	MIN005
31 - 8897	10	Fuse, 25 AMP ATC	MIN005
31 - 8089	10	Fuse, 30 AMP ATC	MIN005

Order No. 01 - 8900

Assortment contains 90 pieces.

ASSORTMENTS 01/02

ATC Fuse Assortment



CONTAINS

Order No.	Qty.	Description	
31 - 8086	10	7.5 AMP Brown	MIN005
31 - 8087	10	10 AMP Red	MIN005
31 - 8491	10	15 AMP Blue	MIN005
31 - 8088	10	20 AMP Yellow	MIN005
31 - 8089	10	30 AMP Green	MIN005
31 - 8897	10	25 AMP Clear	MIN005
31 - 8090	5	ATC Fuse Holder	MIN005
31 - 9931	5	ATC/AGO Fuse Holder	

Order No. 01 - 9930

ATC Fuse assortment contains 70 pieces.

Fuse Assortment



CONTENTS

Qty.	Description
20	5 Amp ATC Fuse
20	10 Amp ATC Fuse
20	15 Amp ATC Fuse
20	20 Amp ATC Fuse
20	25 Amp ATC Fuse
20	30 Amp ATC Fuse

Order No. 01 - 10843

ATC Fuse Assortment. This assortment contains 120 pieces of our popular ATC fuse.

Fuel Filter & Cut-Off Valve Assortment



CONTENTS

Order No.	Qty.	Description	
20 - 1349	10	Replaces B&S 394358	MIN010
20 - 6000	10	Replaces B&S 298090	MIN010
20 - 1357	10	Replaces Snapper 7014359	MIN010
20 - 5841	5	1/4" Univ. in-line cut-off valve	
20 - 5842	5	1/4" cut-off repl. B&S 399517	

Order No. 01 - 7205

Fuel Filter and Valve Assortment contains the most popular fuel filters and fuel valves for B&S equipped Snapper, Toro, etc. Assortment contains 40 pieces.



**Repair Parts Assortment for
WA & T WALBRO Carburetors**

CONTENTS

Order No.	Qty.	Walbro No./Description	
38 - 8101	20	95-526 WA Metering Diaphragm	MIN010
38 - 8102	20	92-251 WA Metering Gasket	MIN010
38 - 8103	10	95-72 WA Fuel Pump Dia.	MIN010
38 - 8104	10	WA Teflon Fuel Pump Dia.	MIN010
38 - 8105	10	92-188 WA Fuel Pump Gasket	MIN010
38 - 8106	10	92-214 WA Metering Gasket	MIN010
38 - 8107	10	95-83 WA Surge Chamber Gkt.	MIN010
38 - 8109	10	95-89 WA Teflon Fuel Pump Dia.	MIN010
38 - 8110	10	92-225 WA Fuel Pump Gasket	MIN010
38 - 8111	20	92-228 WA Fuel Pump Gasket	MIN010
38 - 3655	10	82-75 WA Needle	MIN010
38 - 8112	10	82-82 WA Needle	MIN010
38 - 8337	10	166-48 WA Lever	MIN010
38 - 8114	10	92-170 WA Gasket Plate	MIN010
38 - 8115	10	95-57 WA Diaphragm Plate	MIN010
38 - 8116	10	WA Teflon Dia. Plate	MIN010
38 - 8117	10	92-206 WA Gasket Plate	MIN010
38 - 8119	10	92-318 WA Gasket Plate	MIN010
38 - 8120	10	16-42 WA Circlip	MIN010
38 - 8121	10	140-70 WA Fuel Inlet Screen	MIN010
38 - 8122	10	140-69 WA Check Valve Screen	MIN010
38 - 8123	10	88-28 WA Welch Plug	MIN010
38 - 8124	10	88-89 WA Welch Plug	MIN010
38 - 8125	10	88-110 WA Welch Plug	MIN010

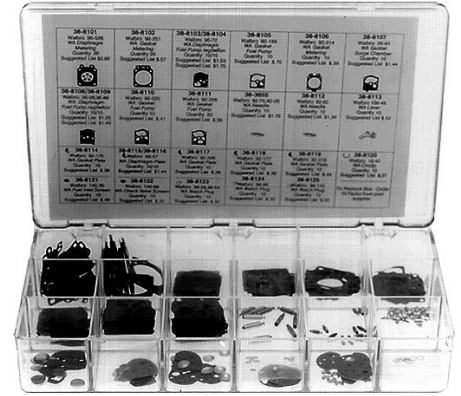

01/02 ASSORTMENTS

Order No. 01 - 6576

Repair Parts Assortment for WA & T Walbro Carburetors. Contains the diaphragms and gaskets for the Walbro WA, WT and WTA carburetors. Assortment contains 270 pieces.

**Metric Bolt Assortment
for Chain Saws**

CONTENTS

Order No.	Qty.	Description	
02 - 3151	10	M4x16 Socket Head	MIN010
02 - 3152	10	M4x20 Socket Head	MIN010
02 - 3154	10	M5x12 Socket Head	MIN010
02 - 3156	10	M5x16 Socket Head	MIN010
02 - 3157	10	M5x20 Socket Head	MIN010
02 - 3158	10	M5x25 Socket Head	MIN010
02 - 3164	10	M5x12 Cheese (PAN)	MIN010
02 - 3169	20	M5 Lock Nut	MIN010
02 - 3172	30	M4 Spring Washer	MIN010
02 - 3173	20	M5 Spring Washer	MIN010
02 - 3180	10	M6x20 Socket Head	MIN010
02 - 3190	10	M5x18 Pan Head	MIN010
02 - 3168	30	M5 Hex Nut	MIN010
02 - 3192	10	M6 Hex Nut	MIN010
02 - 3196	20	M4 Flat Washer	MIN010
02 - 3197	30	M5 Flat Washer	MIN010
02 - 3198	20	M4 Lock Washer	MIN010
02 - 3199	30	M5 Lock Washer	MIN010

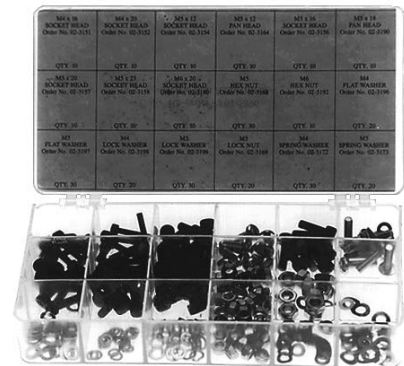

Order No. 01 - 5896

Assortment contains 300 pieces.

Contains a combination of the most popular metric bolts, nuts, washers, and screws for HUSQVARNA, STIHL.

DISPLAYS/ASSORTMENTS



Chain Saw Bolt Assortment

CONTENTS

Order No.	Qty.	Description	
02 - 3250	20	015204 10-24 x 1"	MIN010
02 - 3251	20	015037 10-24 x 7/8"	MIN010
02 - 3252	20	015062 1/4-20 x 1/2"	MIN010
02 - 3253	20	015074 1/4-20 x 5/8"	MIN010
02 - 3254	20	015122 1/4-20 x 1-1/4"	MIN010
02 - 3255	20	015163 1/4-20 x 1"	MIN010
02 - 3256	20	015201 10-24 x 5/8"	MIN010
02 - 3257	20	015229 10-24 x 3/4"	MIN010
02 - 3258	20	015329 8/32 x 1/2"	MIN010
02 - 3259	20	015385 10-24 x 1/2"	MIN010
02 - 3260	20	015653 1/4-20 x 3/4"	MIN010
		015064	
02 - 3261	20	015445 1/4-20 x 7/8	MIN010
		015205	

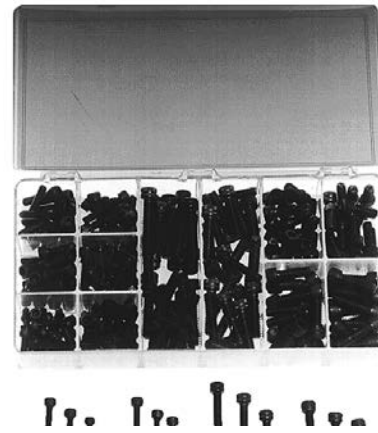

Order No. 01 - 1571

Virtually every standard size screw needed for popular American saws. All are guaranteed to equal quality as O.E.M. Assortment contains 240 pieces.

Round head socket cap screws for POULAN and HOMELITE.

ASSORTMENTS 01/02

Chain Saw & Trimmer Fuel Filter Assortment

Order No. 01 - 7203

Chain Saw Filter Assortment contains fuel filters for Stihl, Homelite, Tillotson, Tecumseh and McCulloch. Assortment contains 80 pieces.



CONTENTS

Order No.	Qty.	Description	
38 - 3904	10	Repl. Stihl 1110-358-1800	MIN010
38 - 3905	10	Filter, porous plastic & casting	MIN010
38 - 4995	10	Filter replaces Tec. 410263	MIN005
38 - 3902	10	Filter repl. Tillotson OW-497	MIN010
38 - 1399	10	Filter only for our 38-3902	MIN010
38 - 3903	10	Filter repl. Homelite 69923	MIN010
38 - 1400	10	Filter only for our 38-3903	MIN010
38 - 1391	10	Filter repl. McCulloch 63932	MIN010

Bar Stud Nut Assortment

CONTENTS

Order No.	Qty.	Size	
39 - 7768	10	3/8" - 16	MIN010
39 - 7769	10	8 x 1.25 (Flanged Smooth)	MIN010
39 - 4796	10	M8 x 1.25 (19mm Socket)	MIN010
39 - 4797	10	17mm - 9mm	MIN010
39 - 4795	10	5/16" - 24	MIN010
39 - 4791	10	5/16" x 18	MIN010
39 - 4792	10	3/8" x 16	MIN010
39 - 8324	10	1/4" x 28	MIN010
39 - 8323	10	M6.3 x 1.0	MIN010
39 - 4793	20	8 x 1.25 (Serrated)	MIN010
39 - 8612	10	5/16" x 18 x 1 (Bolt)	MIN010



Order No. 01 - 8607

Bar stud nut assortment contains nuts for Stihl, Echo, Husky, Partner, Homelite, McCulloch, Pioneer & Poulan. Assortment contains 120 pieces.



Chain Link Assortment



CONTENTS

Order No.	Qty.	Description	
11 - 412	10	COL-35 Offset Link	MIN025
11 - 413	10	COL-40 Offset Link	MIN025
11 - 414	10	COL-41 Offset Link	MIN025
11 - 416	10	COL-43 Offset Link	MIN025
11 - 420	5	COL-420 Offset Link	MIN025
11 - 400	15	CCL-35 Conn. Link	MIN025
11 - 401	15	CCL-40 Conn. Link	MIN025
11 - 402	15	CCL-41 Conn. Link	MIN025
11 - 404	10	CCL-43 Conn. Link	MIN025
11 - 408	10	CCL-420 Conn. Link	MIN025



Order No. 01 - 15
Assortment contains 110 pieces.

01/02 ASSORTMENTS

Chain Saw Parts Assortment for CARLTON

CONTENTS

Order No.	Qty.	Description	
34 - 10547	25	3/8" LP Plain Strap	MIN025
34 - 10548	25	.325" Plain Strap	MIN025
34 - 10549	25	3/8" Plain Strap Standard	MIN025
34 - 10551	25	3/8" LP Preset Strap	MIN025
34 - 10552	25	.325" Preset Strap	MIN025
34 - 10555	25	.325" Preset Strap .063	MIN025
34 - 10553	25	3/8" Preset Strap Standard	MIN025
34 - 10556	25	3/8" Preset Strap .063	MIN025

An assortment of chain parts, plain straps, and presets.



Order No. 01 - 10722
Assortment contains 200 pieces.

DISPLAYS/ASSORTMENTS



Intake Gasket Assortment

CONTENTS

Order No.	Qty.	OEM No./Description	
38 - 3662	10	16B-248 Till. HU Intake/Walbro WA	MIN010
38 - 8126	10	Walbro HDC Intake Gasket	MIN010
38 - 3656	10	16B-228 Tillotson HS Intake Gasket	MIN010
38 - 8127	10	Walbro WS Intake Gasket	MIN010
38 - 8129	10	16B-274 Tillotson HK Intake Gasket	MIN010
38 - 1555	10	16B-206 Tillotson HL Intake Gasket	MIN010
38 - 8130	5	Walbro MDC Intake Gasket	MIN010
38 - 8131	10	16B-216 Tillotson HL Intake Gasket	MIN010
38 - 8132	10	TK Intake Gkt. for Grn. Machine	MIN010
38 - 8133	10	16B-276 Tillotson HK Intake Gasket	MIN010
38 - 8134	10	Universal Intake Gasket	MIN010
38 - 6305	5	High Performance Intake Gasket Material	MIN010
38 - 6306	5	Tillotson HT Intake Gasket	MIN010
38 - 10267	2	Walbro WZ Intake Gasket	
38 - 10268	2	Walbro WZ Intake Gasket	



Order No. 01 - 6577

Intake Gasket Assortment. Contains 13 different intake gaskets for Walbro, Tillotson, Zama and TK. Assortment contains 139 pieces.

Repair Parts Assortment for ZAMA Carburetors

CONTENTS

Order No.	Qty.	OEM No./Description	
38 - 8135	5	A015005 C2 Metering Diaphragm	MIN010
38 - 8136	5	0016005 C2 Metering Gasket	MIN010
38 - 8137	5	0015004 C2 Fuel Pump Diaphragm	MIN010
38 - 8139	5	0037002 C2 Teflon Fuel Pump Dia.	MIN010
38 - 8140	5	0016001 C1 Fuel Pump Gasket	MIN010
38 - 8141	5	A015002 C1 Metering Diaphragm	MIN010
38 - 8142	5	0016003 C1 Metering Gasket	MIN010
38 - 8143	5	0015001 C1 Fuel Pump Diaphragm	MIN010
38 - 8144	5	C1 Teflon Fuel Pump Dia.	MIN010
38 - 8145	5	0015014 C1S Metering Diaphragm	MIN010
38 - 8146	5	0015006 C1S Metering Diaphragm	MIN010
38 - 8147	5	0016017 C1S Fuel Pump Gasket (thin)	MIN010
38 - 8148	5	0016015 C1S Fuel Pump Gasket	MIN010
38 - 8149	5	0016014 C1S Fuel Pump Gasket	MIN010
38 - 8150	5	0015015 C1S Fuel Pump Diaphragm	MIN010
38 - 8151	5	0015013 C1S Fuel Pump Diaphragm	MIN010
38 - 8152	5	0015018 C1S Fuel Pump Diaphragm	MIN010
38 - 8153	5	0037004 C1S Teflon Fuel Pump Dia.	MIN010



Order No. 01 - 6578

Repair Parts Assortment for Zama Carburetors. Contains the diaphragms and gaskets for the Zama C1, C1S and C2 carburetor series. Assortment contains 95 pieces.

Shrink Tube Assortment

CONTENTS

Order No.	Qty.	Description
32 - 11551	8	1/8" x 6"
32 - 11552	7	3/16" x 6"
32 - 11553	7	1/4" x 6"
32 - 11554	5	3/8" x 6"
32 - 10655	4	1/2" x 6"
32 - 10666	3	3/4" x 6"



Order No. 01 - 11550

Shrink Tube Assortment. This assortment contains 38 pieces of our popular sizes in a see through impact resistant box.

ASSORTMENTS 01/02



Repair Parts Assortment for TILLOTSON Carburetors

CONTENTS

Order No.	Qty.	OEM No./Description	
38 - 3654	10	237-653 HS Metering Diaphragm	MIN010
38 - 3657	10	16B-226 HS Metering Gasket	MIN010
38 - 3658	10	237-144 HS Fuel Pump Diaphragm	MIN010
38 - 3659	10	16B-227 HS Fuel Pump Gasket	MIN010
38 - 3656	10	16B-228 HS Intake Gasket	MIN010
38 - 8154	10	237-143 HS Fuel Pump Diaphragm	MIN010
38 - 8155	10	237-604 HU Metering Diaphragm	MIN010
38 - 3663	10	16B-246 HU Metering Gasket	MIN010
38 - 3661	10	237-153 HU Fuel Pump Diaphragm	MIN010
38 - 8156	10	HU Teflon Fuel Pump Dia.	MIN010
38 - 3664	10	16B-247 HU Fuel Pump Gasket	MIN010
38 - 3662	10	16B-248 HU Intake Gasket	MIN010
38 - 8157	100	179-62 HU Welch Plug	MIN010
38 - 3655	10	34-216 HS-HU Fuel Inlet Needle	MIN010
38 - 3668	10	155A-26 HS Fuel Lever	MIN010
38 - 8113	10	155A-29 HU Fuel Lever	MIN010
38 - 8159	100	95-177 HS-HU Screen	MIN010
38 - 8160	100	179-59 HS Welch Plug (large)	MIN010
38 - 8161	100	179-60 HS Welch Plug (small)	MIN010



01/02 ASSORTMENTS

Order No. 01 - 6579

Repair Parts Assortment for Tillotson Carburetors. Contains all the diaphragms and gaskets for the Tillotson HS & HU carburetors. Assortment contains 550 pieces.

2 Cycle Primer Bulb Assortment

CONTENTS

Order No.	Qty.	Replaces	
20 - 9948	5	Zama 0057004	MIN005
20 - 9479	5	Walbro 188-13	MIN005
20 - 9477	5	Walbro 188-11	MIN005
20 - 9478	5	Walbro 188-12	MIN005
20 - 11510	3	Walbro 188-512	
20 - 10392	1	Walbro 188-506	
20 - 10393	1	Walbro 188-508	
20 - 10394	1	Walbro 188-509	
20 - 10395	1	Walbro 188-511	



Order No. 01 - 12288

2 Cycle Primer Bulb Assortment. This assortment contains 27 pieces of our popular sizes in a see through impact resistant box.

4 Cycle Primer Bulb Assortment

CONTENTS

Order No.	Qty.	Replaces	
20 - 8958	10	B&S 494408	MIN010
20 - 8959	10	B&S 496115	MIN010
20 - 8751	10	Tecumseh 632047	
20 - 9289	10	Tecumseh 36045	MIN010
20 - 9807	10	Tecumseh 63269A	MIN010



Order No. 01 - 12287

4 Cycle Primer Bulb Assortment. This assortment contains 50 pieces of our popular sizes in a see through impact resistant box.

Note: For refills refer to above listings. Refills packaged in lots of 10.

DISPLAYS/ASSORTMENTS



Lock Washer Assortment



Order No. 01 - 12020

Lock washer Assortment. This assortment contains 720 pieces of all zinc plated washer. Assortment contains 3 different styles, flat, lock and star. Sizes included are #6, #8, #10, 1/4", 5/16", 3/8" ID.

ASSORTMENTS 01/02

Lock Nut Assortment

CONTENTS

Qty.	Description
25	#10 x 24
35	1/4" x 20
25	1/4" x 28
30	5/16" x 18
25	3/8" x 16
10	1/2" x 13



Order No. 01 - 12021

Lock Nut Assortment. This assortment contains 150 pieces of our popular sizes.

Hex Head Self-Tapping Screw



Order No. 02 - 9466

Hex head 5/16" - 18 x 3/4" self-tapping screw. Replaces MTD 710-04484. MIN010

Order No. 02 - 9467

Hex head 5/16" - 18 x 1" self-tapping screw. MIN010

Order No. 02 - 9468

Hex head 5/16" - 18 x 1-1/2" self-tapping screw. MIN010

Order No. 02 - 9469

Hex head 3/8" - 16 x 1" self-tapping screw. MIN010

Order No. 02 - 9470

Hex head 3/8" - 16 x 1-1/4" self-tapping screw. Replaces Murray 25X7MA. Used with our 10-2925. MIN010

Order No. 02 - 9471

Hex head 3/8" - 16 x 1-1/2" self-tapping screw. MIN010



DISPLAYS/ASSORTMENTS

**Mounting Bolt for
AYP**

Thread Size 3/8" - 16
Thread Length 3/4"



Order No. 02 - 9373

Hex head self-tapping screw replaces AYP 17490612, 17000612. Fits AYP, Roper, Sears quill assemblies. Used with our quill assemblies **10-8649, 10-8647, 10-1171, 10-6813, 10-2914**.
MIN010

**Mounting Bolt for
AYP**

Thread Size 5/16" - 18
Thread Length 1-1/4"



Order No. 02 - 9374

Hex head self-tapping screw replaces AYP 138776, 173984, 157722. Fits AYP, models PP 18hp, 44" 9540052-61 assembly. Mounting bolt for our **10-8479** quill assembly.
MIN010

**Klip Ring for
AYP**



Order No. 02 - 9372

Klip ring replaces AYP 12000029. Fits king pin on 16, 18 & 20 hp garden tractors from 1991 to present. Also used to retain steering bell crank assy on 16hp garden tractors and to retain sector on 18 & 20 hp models. Fits 3/4" Shafts.
MIN010

**Retaining Snap Ring for
SNAPPER**



Order No. 02 - 9492

Retaining ring/snap ring replaces Snapper 7010746. Fits Snapper front end mowers. Also included in our **10-8322** front end repair kit.
MIN010

**01/02
ASSORTMENTS**

**5/16" - 18 Thread Staked
Locknut**



Order No. 02 - 12222

5/16" - 18 Thread staked locknut. Used on our **41-8627, 41-8628 & 41-916** shear pin.



CONTROLS, THROTTLES & CABLES

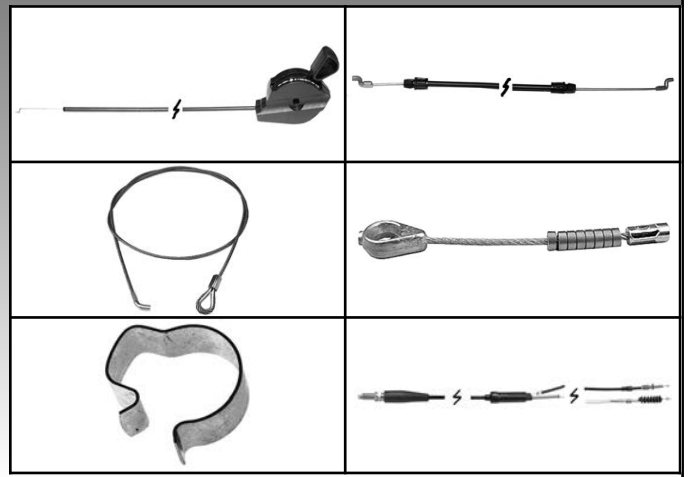
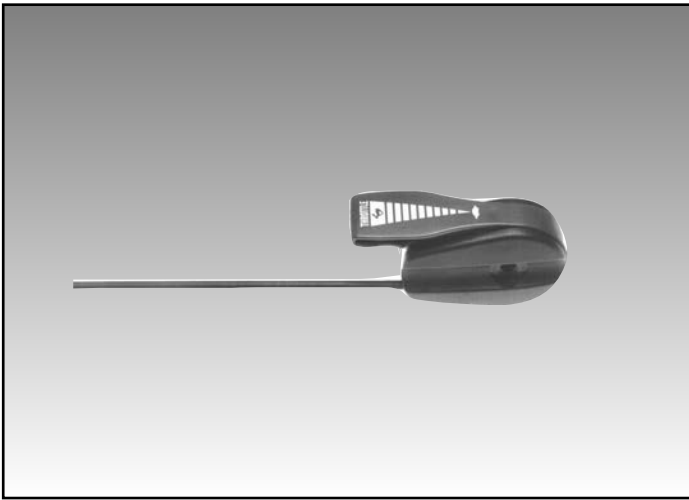

Quick-Glance

CONTROLS, THROTTLES & CABLES PG.

MOWER THROTTLE CONTROLS/CABLE

Throttle	56-66
Drive Control	67-70
Blade Stop Cable	68-69
Engine Stop Cable	68-71
Control Cable	68-69
Brake	69-70
Winch Cable	72
Engine Brake Cable	68-71
Transmission Cable	71-72
Steering Cable	72
Clutch Cable	72
Deck Engagement Cable	70-73
Deck Lift Cable	73
Lift Cable	73
Conduit Clips	74
Conduit	74
Inner Wire	74
Mounting Adaptor	74

TRIMMER/BRUSHCUTTER CABLE

Throttle	75-77
Drive	75-77

MINI BIKE/GO CART

Throttle	78
Brake	78

03

Quick-Glance

CONTROLS, THROTTLES & CABLES
UNIVERSAL



Conduit 53"
Inner Wire 56-1/2"
Wire Travel 1-1/4"

Order No. 03 - 235

This is a deluxe lever throttle with all the plus features. Screw in loom, all steel constructed, plated and a full 1-1/4" protected span. Uses our **04-11548** swivel.



Conduit 53"
Inner Wire 55-7/8"
Wire Travel 1-3/16"

Order No. 03 - 236

A throttle designed for use with the choke-o-matic type carburetor. Negative Action Control. Attractive black label and handle.

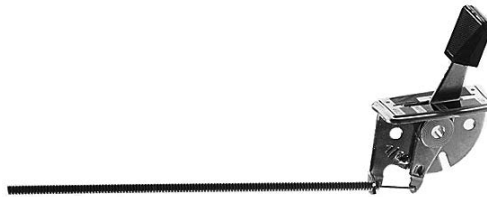

Order No. 03 - 223

Turn-To-Lock. This universal control is ideal for such applications as throttle controls on governor-equipped engines or wherever spring tension or vibration causes ordinary controls to creep. Positive action control.

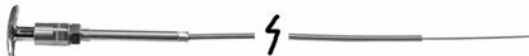

Conduit 120"
Inner Wire 126"
Wire Travel 3"

03
THROTTLE CABLES

Order No. 03 - 237

Push-Pull control for engine speed or choke control. Fits many types of equipment, including Bobcat. Positive action control.



Conduit 60"
Inner Wire 63"
Wire Travel 2-3/4"

Order No. 03 - 243

Positive action lever control. Replaces many models of Ariens, Atlas and AMF.

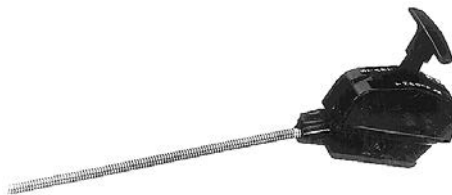

Conduit 48"
Inner Wire 51"
Wire Travel 1-3/16"

Order No. 03 - 6657

Negative action control. This universal control can be mounted between or on side of handle bar.



Conduit 43-1/2"
Inner Wire 47"
Wire Travel 1-5/8"

Order No. 03 - 6658

Negative action control. This universal control can be mounted between or on side of handle bar.



Conduit 66"
Inner Wire 71"
Wire Travel 1-5/8"



CONTROLS, THROTTLES & CABLES

Throttle Control for ARIENS

Order No. 03 - 9127

Throttle control replaces Ariens 69087. Fits rear engine riders with Tecumseh engines. Vinyl wrapped conduit.



Conduit 38-7/8"
Inner Wire 39-7/8"
Wire Travel 1-1/2"

Order No. 03 - 9128

Throttle control replaces Ariens 69076. Fits B&S powered rear engine riders from 1971-1979.



Conduit 50-7/8"
Inner Wire 52-7/8"
Wire Travel 1-1/2"

Order No. 03 - 9129

Throttle control replaces Ariens 69032. Fits snowblower models 10954, 10962, 10965, 10969, 10970. Negative action "F" to "S". Has bracket for side mounting.



Conduit 27-1/8"
Inner Wire 29"
Wire Travel 1-3/4"

Order No. 03 - 9679

Throttle control replaces AYP 851462.



Conduit 63"
Inner Wire 64-7/8"
Wire Travel 1-7/8"

Order No. 03 - 9680

Throttle control replaces AYP 700417. Fits 20" & 22" side and rear discharge mowers. Axial negative.



Conduit 47"
Inner Wire 49-1/4"
Wire Travel 2-1/4"

Throttle Control for BUNTON

Order No. 03 - 8766

Throttle control replaces Bunton PJ-5019-50. Fits Bunton midsize Commercial Hydro mower 36", 48", 52" & 60" cut. Used with our 03-8800 T-Knob.



Conduit 50"
Inner Wire 52-1/4"
Wire Travel 2-1/4"

Order No. 03 - 8800

T - Knob replaces Bunton PL4020. Fits our 03-8766 throttle control. Black



Choke Control Cable for CUB CADET

Order No. 03 - 14324

Choke control cable replaces Cub Cadet 746-04120. Push/Pull choke control. Fits models I1046, I1050, GT1222, GT1554, SLT1550, SLT1554, LT1018, LT1022, LT1024, LT1042, LT1045, LT1046 & LT1050.

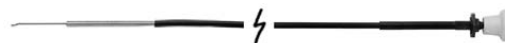

Conduit 40-1/2"
Inner Wire 42-1/2"
Wire Travel 2"

Order No. 03 - 14325

Choke control cable replaces Cub Cadet 746-04066. Fits models RZT 50/54 & GT1222.

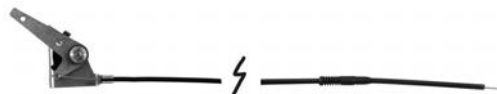

Conduit 34"
Inner Wire 36-1/4"
Wire Travel 1-1/2"

03 THROTTLE CABLES

CONTROLS, THROTTLES & CABLES



Choke Control Cable for CUB CADET



Conduit 61"
Inner Wire 63"
Wire Travel 2"

Order No. 03 - 14621

Choke control cable replaces Cub Cadet 746-04214, 946-04214. Fits RZT50/54 mowers.



Throttle Control for DIXIE CHOPPER

Conduit 42-1/2"
Inner Wire 45-1/4"
Wire Travel 2-3/4"

Order No. 03 - 10951

Throttle control replaces Dixie Chopper 68250. Cable has loop not a "Z"-Bend.



Order No. 03 - 12053

Throttle cable replaces Dixie Chopper 68249. Will not fit older style with loop.



Conduit 45"
Inner Wire 50"
Wire Travel 4-1/4"

Throttle Cable for ECHO

Conduit 13-1/2"
Inner Wire 15-1/2"
Wire Travel 2"

Order No. 03 - 9567

Throttle cable replaces Echo 178001-00761. Fits blower models PB400 & PB400E.

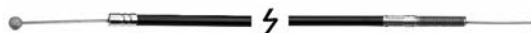

Order No. 03 - 9568

Throttle cable replaces Echo 178001-0963-0. Fits blower models GT140, 160, 160A, 160AE, 200, 200A, 200B, 200BE, 200CE, 1000 & 2100.



Conduit 12-1/2"
Inner Wire 15-3/4"
Wire Travel 3-1/4"

Throttle Control for ENCORE/FERRIS

Conduit 36-1/2"
Inner Wire 41-1/4"
Wire Travel 1-3/4"

Order No. 03 - 8626

Throttle control replaces Encore/Ferris 15E363268, 363203. Fits older style Encore/Ferris. Models BG36KA, BG48KA, BG52KA, GD36KA, GD8K.



Throttle Cable for EXMARK

Conduit 54"
Inner Wire 56-1/4"
Wire Travel 2-1/4"

Order No. 03 - 12218

Throttle cable replaces Exmark 1-633696. Fits Metro HP, Turf Tracer, Viking, Lazer & Turf Ranger models.



Choke Control Cable for EXMARK

Conduit 54"
Inner Wire 58-3/4"

Order No. 03 - 13014

Choke control cable replaces Exmark 1-603336. Fits models 52" & 60" Turf Tracer Hydro drive units with floating decks.



03

THROTTLE CABLES



CONTROLS, THROTTLES & CABLES

Throttle Control for HONDA

Order No. 03 - 8832

Throttle control replaces Honda 17910-VA4-800, code 1663483. Fits 21" mower.



Conduit 48-3/4"
Inner Wire 52"
Wire Travel 3"

Order No. 03 - 10118

Throttle cable replaces Honda 17910-VA3-003. Fits models HR194, HR215 & HR216.



Conduit 53"
Inner Wire 58"
Wire Travel 4-3/4"

Throttle Control for McLANE

Order No. 03 - 866

Replaces McLane 1013B. Negative action control. Used on Briggs & Stratton equipped edgers. Single lever control.



Conduit 40"
Inner Wire 42"
Wire Travel 1-5/8"

Order No. 03 - 10222

Throttle control replaces Mountfield RCL29004700. Fits Mountfield walkbehind mowers.



Conduit 36-3/4" 935MM
Length Extension 1-21/32" 42MM
Wire Travel 1-13/32" 36MM

Choke Control for MTD

Order No. 03 - 9683

Choke control replaces MTD 746-0616A. Total length 26".



Conduit 18-3/4"
Inner Wire 24-1/4"
Wire Travel 1-1/2"

Order No. 03 - 9682

Choke control replaces MTD 746-0614A. Fits mid size rear engine riders. Total length 41".



Conduit 34"
Inner Wire 39-1/4"
Wire Travel 1-1/2"

Order No. 03 - 9681

Choke control replaces MTD 746-0613A. Total length 49-1/2".



Conduit 42"
Inner Wire 48"
Wire Travel 2-1/4"

Order No. 03 - 11519

Choke cable replaces MTD 746-3021. Fits models 662-672 & 678. "Z" bend on end.

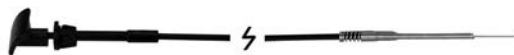

Conduit 29"
Inner Wire 32"
Wire Travel 1-1/2"

Order No. 03 - 14624

Choke control cable replaces MTD/Cub Cadet 746-1085A. Fits models 1170, 1180, 1212, 1800, LT1042, LT1045, LT1046 & LT1050.



Conduit 37"
Inner Wire 39"
Wire Travel 1-3/4"

03

THROTTLE CABLES

CONTROLS, THROTTLES & CABLES



Throttle Cable for MTD

Order No. 03 - 7717

Throttle control replaces MTD 731-0972, 931-0972. Fits 21" self propelled mower models 120-176, 120-178B, 120-466B, 120-468B, 120-476B and 120-478B.



Order No. 03 - 8417

Throttle control handle replaces MTD 831-0796A. Fits 36" cut model 132-431-E06, 38" cut models 132-657-F062, 139-652-352 & 46" cut model 140-848-H062. Also fits Lowes, Task Force, Master Cut and some Yardman.



Order No. 03 - 9569

Throttle cable replaces MTD 746-0776. Fits 95' - 98' MTD riders models 135 & 136 with B&S engines only.



Conduit 18-1/2"
Inner Wire 21-1/2"
Wire Travel 2-1/4"

Order No. 03 - 9130

Throttle cable replaces MTD 746-0632, 746-0474. "Z" bend on each end.

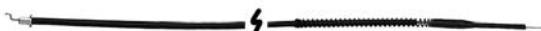

Inner Wire 56-3/8"
Spring Length 8-1/2"
Wire Travel 2-3/4"

Order No. 03 - 9131

Throttle cable replaces MTD 746-0672. Fits walkbehind and self-propelled walkbehinds that require a 58" yellow cable.

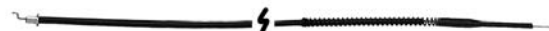

Inner Wire 60"
Spring Length 8-1/2"
Wire Travel 2-1/2"

Order No. 03 - 9132

Throttle cable replaces MTD 746-0845. Fits 1992 & later push & self-propelled mowers with Tecumseh engines models, 081, 085, 087, 232-238, 280-282, 413, 415, 423, 425, 460, 478, 500, 508, 516, 518. "Z" bends on each end.



Conduit 45"
Inner Wire 47-3/8"
Wire Travel 2-5/8"

Order No. 03 - 9133

Throttle cable replaces MTD 746-0842. Fits 1992 & later push mowers with B&S engines. Fits models 030-040, 050-063, 070-088, 092-098, 108, 206, 260-265, 280-282, 440, 442, 450, 452, 460, 479, 500-508, 570. "Z" bends at both ends.



Conduit 51-1/4"
Inner Wire 53-5/8"
Wire Travel 2-1/2"

Order No. 03 - 9134

Throttle cable replaces MTD 746-0843. Fits 1992 & later push & self-propelled mowers with B&S engines. Fits models 083, 088, 123-238, 246, 328, 338, 414, 416, 418, 424, 426, 428, 446, 448, 456, 458, 460-479, 488, 518, 528. "Z" bends at both ends.



Conduit 55-3/8"
Inner Wire 57-3/4"
Wire Travel 2-1/2"

03 THROTTLE CABLES



CONTROLS, THROTTLES & CABLES

Throttle Cable for MTD

Order No. 03 - 9840

Throttle cable replaces MTD 746-0801. Fits MTD models 019, 070, 072, 080, 082, 200, 202, 220, 222, 280 & 282. "Z" bend.

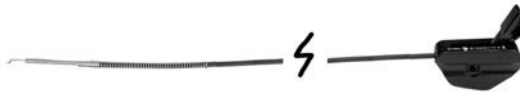

Conduit 51-3/4"
Inner Wire 52"
Wire Travel 1-11/32"

Order No. 03 - 9855

Throttle cable replaces MTD 746-0634A. Fits MTD models 600-609, 660-669, 670-679, 690-699, series tractors with twin cylinder engines. Also fits series 820-829 & 840-849 tractors.



Conduit 35"
Inner Wire 38"
Wire Travel 3"

Order No. 03 - 11516

Throttle cable replaces MTD 746-0841. Fits model series 370-389, 559, 959, 979, E979 & 999, 1997-2002 push and self propelled units. "Z" bend on end.



Conduit 60"
Inner Wire 62-1/2"
Wire Travel 2-1/2"

Order No. 03 - 11518

Throttle cable replaces MTD 746-0847 / 746-1115. Fits models 12A-998Q401, 11A-418Q118 & 12A-378Q118 Yardman. "Z" bend on end.



Conduit 42"
Inner Wire 44-1/2"
Wire Travel 2-1/2"

Order No. 03 - 11520

Throttle control assembly replaces MTD 746-1084.

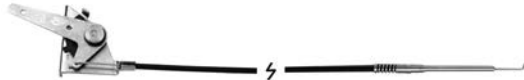

Conduit 25"
Inner Wire 28"
Wire Travel 1-5/8"

Order No. 03 - 10685

Throttle control replaces MTD 746-1086. Fits lawn tractor with B&S intek engines built from 1999 through 2002. Z bend on end.

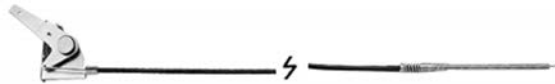

Conduit 42"
Inner Wire 45"

Order No. 03 - 10687

Throttle control replaces MTD 746-0630A. Fits walk-behind mowers. Z bend on each end.

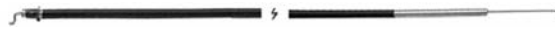

Conduit 37"
Inner Wire 42"

Order No. 03 - 10684

Drive cable replaces MTD 746-0713. Fits 21" walk-behind mowers.

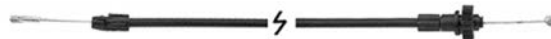

Conduit 53"
Inner Wire 57"

Order No. 03 - 10688

Engine stop cable replaces MTD 746-0550. Used on push mowers models: 040, 050, 060, 070, 080 & 090. Also used on self propelled models: 100, 200, 400, & 700. Z bend on each end.



Conduit 40"
Inner Wire 46-3/8"

03 THROTTLE CABLES

CONTROLS, THROTTLES & CABLES



Throttle Control for MURRAY

Order No. 03 - 9684

Throttle control replaces Murray 91989.



Conduit 21"
Inner Wire 23-1/2"
Wire Travel 7/8"

Order No. 03 - 9685

Throttle control replaces Murray 740194 & 7701016. Fits high wheel trimmers.



Conduit 44-1/2"
Inner Wire 47"
Wire Travel 1-7/8"

Order No. 03 - 228

Replaces Murray 21223PA. Positive action control. Has plastic covered conduit. Conduit size 3/16", Innerwire .058". With knob.



Conduit 60"
Inner Wire 64-1/2"
Wire Travel 1"

Order No. 03 - 229

Replaces Murray 21222PA. Positive action control. Conduit size 3/16", Innerwire .058". With knob.



Conduit 60"
Inner Wire 64-1/2"
Wire Travel 1"

Order No. 03 - 230

Replaces Murray 21540PA, 23332PA. Positive action control. 3/16" conduit, .058" Innerwire. Plastic conduit cover. With knob.



Conduit 13-7/8"
Inner Wire 17-5/8"
Wire Travel 1"

Order No. 03 - 242

Positive Action, slide control for automatic choke carburetor. Rear detent for stop position. One bolt mounting. Black case with red slider knob. Replaces Murray 20005SE, 42775, 42877, 42096, 42949, 42879. Fits 3/4" or 7/8" tubing, Loop or "T" handle.



Conduit 48-1/2"
Inner Wire 51-19/32"
Wire Travel 1-17/64"

Order No. 03 - 946

48" black plastic conduit control. Positive action. Used on Murray, Air Cap, MTD & Roper. Segmented detent. Smooth operating.



Conduit 48"
Inner Wire 49-7/8"
Wire Travel 1-11/32"

Order No. 03 - 7961

Throttle control fits Murray 42096, Air Cap, MTD and Roper. Positive action control.



Conduit 60-13/32"
Inner Wire 62-9/32"
Wire Travel 1-3/4"

Order No. 03 - 8530

Throttle control assembly replaces Murray 420005. Fits all Murray walk behind mowers for 1985 thru 1995. Assembly includes throttle control, nut, screw, 4" cable ties, mounting adapter & instructions. (carded)



Conduit 68"
Inner Wire 69-1/2"
Wire Travel 1-7/16"

03 THROTTLE CABLES



CONTROLS, THROTTLES & CABLES

Throttle Control for MURRAY (Cont.)

Order No. 03 - 7974

Throttle control replaces Murray 71180, 71157 on walk behind mowers. Plastic conduit converts from positive to negative action.

Order No. 03 - 8960

Heavy duty throttle control fits Murray walk behind mowers. Plastic conduit converts from positive to negative action. Same as our 03-7974 but is **Heavy Duty**.

Conduit 50"
Inner Wire 55"
Wire Travel 1-1/2"



Order No. 03 - 7975

Throttle control fits Murray walk behind mowers. Plastic conduit converts from positive to negative action.

Order No. 03 - 8961

Heavy duty throttle control fits Murray walk behind mowers. Plastic conduit converts from positive to negative action. Same as our 03-7975 but is **Heavy Duty**.

Conduit 71"
Inner Wire 76"
Wire Travel 1-1/2"



Order No. 03 - 8415

Engine stop cable replaces Murray 42569. 44-1/2" conduit length, 52-1/2" wire length. Plastic covered conduit with brackets.

Conduit 44-1/2"
Inner Wire 52-1/2"
Wire Travel 7-1/2"

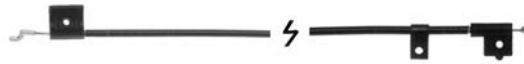

Order No. 03 - 8416

Engine stop cable replaces Murray 43749 & 42363. 45-1/2" conduit length, 54-1/2" wire length. Plastic covered conduit with brackets.

Conduit 45-1/2"
Inner Wire 54-1/2"
Wire Travel 7-3/8"

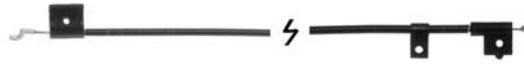

Order No. 03 - 10690

Engine stop cable replaces Murray 1101093. Fits 20" walkbehind mowers from 2000-2003. 3/16" Z bend on one end, 1/4" T on other end.

Conduit 44"
Inner Wire 50"

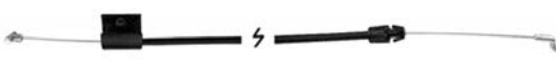

Order No. 03 - 10691

Engine stop cable replaces Murray 1101181. Fits 20" & 22" walkbehind mowers from 2001-2002. 3/16" Z bend on one end, 1/4" T on other end.

Conduit 45-1/4"
Inner Wire 52-1/4"

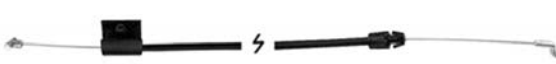

Order No. 03 - 10692

Engine stop cable replaces Murray 1101360. Fits 20" walkbehind mowers with rear bagger made from 2001-2003. 3/16" Z bend on one end, 1/4" T on other end.

Conduit 42-1/2"
Inner Wire 48-3/4"

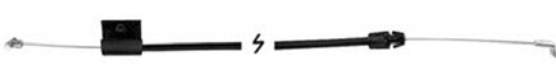

Order No. 03 - 10693

Engine stop cable replaces Murray 1101366. Fits 22" walkbehind mowers with Tecumseh engines made from 2000-2003. 3/16" Z bend on each end.

Conduit 52"
Inner Wire 59-1/4"

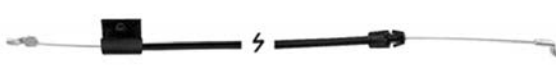

03 THROTTLE CABLES

CONTROLS, THROTTLES & CABLES



Throttle Control for MURRAY (Cont.)

Conduit 52-1/4"
Inner Wire 59-1/4"

Order No. 03 - 10694

Engine stop cable replaces Murray 672835. Fits walk-behind mowers with Tecumseh engines made from 2000-2003. 3/16" Z bend on one end, 1/4" T on other end.

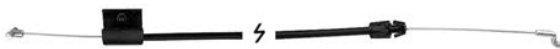

Order No. 03 - 10695

Engine stop cable replaces Murray 672840. Fits walk-behind mowers made from 2000-2003. 3/16" Z bend on one end, 1/4" T on other end.

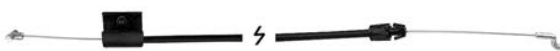

Conduit 42-1/2"
Inner Wire 50"

Order No. 03 - 10697

Engine stop cable replaces Murray 43828. Fits 22" walkbehind mowers, braided cable with die cast Z-bend on one end. Z bend on one end, T on other end.



Conduit 40"
Inner Wire 48-1/2"

Throttle /Choke Control for SCAG

Order No. 03 - 9693

Choke control replaces Scag 48780. Fits Scag push-pull design.



Conduit 51"
Inner Wire 57"
Wire Travel 2"

Order No. 03 - 10748

Choke control cable replaces Scag 482314. Fits 48" & 52" SW & SWZ walkbehind units.

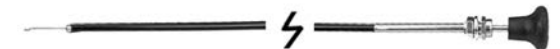

Conduit 33-1/8"
Inner Wire 35"
Wire Travel 1-1/2"

Order No. 03 - 11521

Throttle & Choke control replaces Scag 481544.

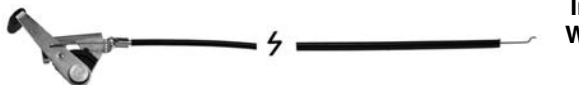

Conduit 37"
Inner Wire 40-1/2"
Wire Travel 1-5/8"

Order No. 03 - 11640

Throttle & Choke control replaces Scag 481662. .060 wire.

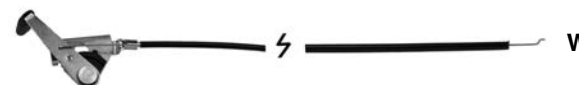

Conduit 66 -1/4"
Inner Wire 70"
Wire Travel 1-5/8"

Order No. 03 - 6992

Throttle control replaces Scag 48206. Fits models SW32-12B, SW36-8J, SW36-12B, SW36-13K, SW48-12B, SW48-13K, SW-13K, SW-18KH.



Conduit 38-1/4"
Inner Wire 40"
Wire Travel 1-9/32"

Order No. 03 - 9169

Throttle control replaces Scag 48394. Fits Scag model SW248 walk behind. Negative action control Z bend.



Conduit 41"
Inner Wire 43-1/2"
Wire Travel 1-1/4"

03 THROTTLE CABLES



CONTROLS, THROTTLES & CABLES

Order No. 03 - 5805

Replaces Snapper 7018889. Positive action control. Used on 8, 10, 11 and 12 hp Briggs & Stratton equipped riders. (Heavy Duty)



Conduit 13-1/2"
Inner Wire 15-5/8"
Wire Travel 1-1/2"

Order No. 03 - 231

Replaces Snapper 7018889. Negative action control. Used on Briggs & Stratton equipped riding mowers. Side mount.



Conduit 11-25/32"
Inner Wire 14-3/32"
Wire Travel 1-9/16"

Order No. 03 - 233

Replaces Snapper 7012061. Positive action control. Use on Tecumseh equipped Snapper riding mowers. Fits 8 hp Tecumseh and 5 hp Briggs & Stratton.



Conduit 56-3/16"
Inner Wire 59-1/2"
Wire Travel 1-11/16"

Order No. 03 - 234

Replaces Snapper 7011991. Positive action control. Used on Briggs & Stratton equipped Snapper riding mowers. Fits 8 hp Briggs & Stratton.



Conduit 59-3/16"
Inner Wire 62-5/8"
Wire Travel 1-5/8"

Order No. 03 - 867

Replaces Snapper 7018188. Positive action control. Used on Snapper commercial mowers equipped with 5 hp Briggs & Stratton.



Conduit 49"
Inner Wire 51-1/8"
Wire Travel 1-1/2"

Order No. 03 - 239

Positive action black control with red knob replaces Snapper 7018186. Rear detent for stop position. Used on automatic choke carburetor.



Conduit 48-3/4"
Inner Wire 52-3/16"
Wire Travel 1-1/8"

Order No. 03 - 241

Positive action lever control. Plastic knob with steel lever. Used on many models of Roper, Snapper, Yardman, Jacobsen and Southland mowers.



Conduit 71-1/4"
Inner Wire 74-1/8"
Wire Travel 1-5/8"

03

THROTTLE CABLES

CONTROLS, THROTTLES & CABLES



Throttle Control for SNAPPER (Cont.)

Conduit 48"
Inner Wire 50-5/16"
Wire Travel 1-7/32"

Order No. 03 - 244

Positive action lever control. Plastic knob with steel lever. Used on many models of Roper, Snapper, Yardman, Jacobsen and Southland mowers.



Conduit 45"
Inner Wire 47"
Wire Travel 1-1/2"

Order No. 03 - 6589

Throttle control. Repl. Snapper 7019254. Fits 1990 & 91 V-21 Snapper with 5 hp Quantum engines.



Conduit 45-1/2"
Inner Wire 47-3/4"
Wire Travel 1-1/2"

Order No. 03 - 7812

Throttle control replaces Snapper 7060916. Fits B&S 3-1/2 hp, 21" self propelled model T21357B. .070 wire.



Conduit 41"
Inner Wire 43"
Wire Travel 2"

Throttle Control for TORO/WHEELHORSE

Order No. 03 - 9135

Throttle control replaces Wheel Horse 102119. Locking push-pull cable. "T" marked for throttle. 9/16" mount hole.



Conduit 49-25/32"
Inner Wire 52-9/32"
Wire Travel 2-27/32"



Order No. 03 - 8765

Throttle control replaces Toro 70-1061. Fits old style 21" Toro rear bagger.

03 THROTTLE CABLES



CONTROLS, THROTTLES & CABLES

**Drive Control for
ATCO QUALCAST**

Conduit 43-1/2" 1105MM
Length Extension 6-3/4" 172MM

Order No. 03 - 10224

Drive control cable replaces ATCO Qualcast A58036. Fits Qualcast walkbehind mowers.



Order No. 03 - 10223

Drive control cable replaces ATCO Qualcast A58035. Fits Qualcast walkbehind mowers.

Conduit 30" 764MM
Length Extension 3-7/32" 82MM



**Drive Cable for
SNAPPER**

Cable Length 42"

Order No. 05 - 12075

Drive cable replaces Snapper 70034604. Fits 21" self propelled units. Eye & Z Bend endings.



**Drive Control Assembly for
MURRAY**

Order No. 05 - 10696

Drive control assembly replaces Murray 740193. Latching cable with control. **Inner Wire 59"**, **Conduit 55-1/4"**. Fits walkbehind string trimmers. "Z" bend on end.

Order No. 05 - 10689

Drive control assembly replaces Murray 1101344. **Inner Wire 61"**, **Conduit 59"**. Fits self propelled 22" walkbehind mowers.

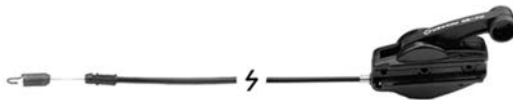

Order No. 03 - 10219

Drive control cable replaces Stiga NV 329-496-185-00. Fits Stiga NV walkbehind mowers.

Conduit 48-1/4" 1226MM
Length Extension 8-27/32" 225MM



Order No. 03 - 10220

Drive control cable replaces Stiga NV 329-496-187-00. Fits Stiga NV walkbehind mowers.

Conduit 52-1/4" 1326MM
Length Extension 11" 280MM



**03
THROTTLE CABLES**

CONTROLS, THROTTLES & CABLES



Blade Stop Cable for HONDA

Conduit 54"
Inner Wire 65"
Wire Travel 9"

Order No. 03 - 10122

Blade stop cable replaces Honda 54530-VA3-J03. Fits models HR215SXA, HXA, K1SXA, K1HXA, HRC215, K1SDKA, HRC216HXA, SXA, K1HXA and K1SXA



Conduit 45"
Inner Wire 54-3/4"
Wire Travel 9-1/4"

Order No. 03 - 10123

Blade stop cable replaces Honda 54530-VE0-003. Fits models HRB215XA, HRB215K15XR, HRB215K2HXA.



Conduit 53"
Inner Wire 65-1/2"
Wire Travel 10"

Order No. 03 - 10124

Blade stop cable replaces Honda 54530-VB3-802. Fits models HR214SXA, HRA214SXA.



Engine Stop Cable for AYP

Conduit 52"
Inner Wire 59-3/16"

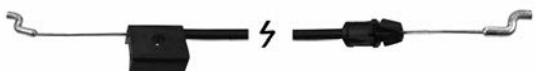

Order No. 03 - 9566

Engine stop cable replaces AYP 130861. Fits 22" walkbehind push mowers. Model PP751. Also fits YardPro & Husky mowers

Drive Control Cable for AYP

Conduit 59-3/4"
Inner Wire 63-1/2"

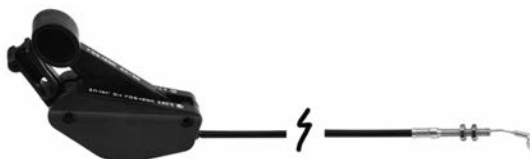

Order No. 05 - 13548

Drive control cable replaces AYP 87025, 133049.

Control Cable for AYP

Conduit 54"
Inner Wire 60"
Wire Travel 6"



Order No. 05 - 13350

Control cable replaces AYP 156581, 156577, 168552.

Drive Cable for AYP

Conduit Length 55"
Overall Length 67"

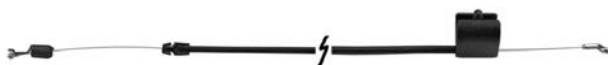

Order No. 05 - 14204

Drive cable replaces AYP 194653.

Drive Control Cable for AYP

Conduit Length 56"
Inner Wire 59-3/4"



Order No. 05 - 14623

Drive control & cable replaces AYP 700615, 146323, 145755, 184588, 184596 & Husqvarna 5321463-23, 5321845-96. Fits 22" self-propelled mowers. Flexible innerwire with spring on end Z-bend on spring.

Drive Cable for AYP/HUSQVARNA

Conduit 59-1/2"
Inner Wire 62-1/2"
Wire Travel 3"



Order No. 05 - 14023

Drive cable replaces AYP/HUSQVARNA 184588, 532184588, 145755. Fits self propelled walkbehind mowers.

03 THROTTLE CABLES



CONTROLS, THROTTLES & CABLES

**Control Cable for
LAWNBOY**

Conduit 55-1/4"
Inner Wire 64"
Wire Travel 8"

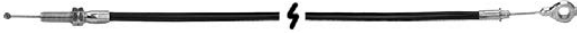

Order No. 05 - 9126

Control cable replaces Lawn-Boy 682685. Fits 21" cut self-propelled steel deck, rear discharge models.

**Variable Speed Drive
Cable for MTD**

Conduit 76"
Inner Wire 79-1/2"
Wire Travel 3-1/4"



Order No. 05 - 13416

Variable speed drive cable replaces MTD 946-04206A. Fits walk behind mowers.

**Control Cable for
MTD**

Conduit 36-7/8"
Inner Wire 43-1/8"



Order No. 05 - 10817

Control cable replaces MTD 746-0553. Fits 1991 and newer push mowers with B&S engine models 030-042, 030-416, 030-418, 030-424, 030-426, 030-428, 030-446, 030-448, 030-456, 030-458, 030-506, 030-508, 030-570, 030-580, Z bend on each end.

**Control Cable for
MTD**

Conduit 40"
Inner Wire 53"



Order No. 05 - 13264

Control cable replaces MTD 746-1130 / 946-1130. Fits 22" deck, series 038, 2003-2007. Z-bend on each end.

**Drive Cable for
MTD**

Cable Length 38-1/4"
Overall Length 43"



Order No. 05 - 5616

Clutch drive cable replaces MTD 946-0898, 746-0898. Fits 600 model series snow throwers built 1995-2002 and 700 model series built in 2003. Model 312-610000 (1992), 313-610E120 (1993), 314-616E131 (1994) snowthrowers.

**Control Cable for
MTD**

Conduit 37-3/8"
Inner Wire 51"
Wire Travel 12"



Order No. 05 - 13332

Control cable replaces MTD 746-1113 / 946-1113.

**Blade Control Cable
for MTD**

Conduit 40-3/4"
Inner Wire 54"
Wire Travel 12"



Order No. 05 - 14040

Blade control cable replaces MTD 946-1132, 746-1132. Fits walkbehind mowers.

**Brake Cable for
TORO**

Conduit Length 62"
Overall Length 67-1/2"
Wire Travel 4-1/2"

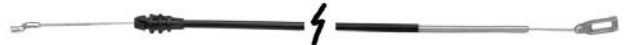

Order No. 05 - 14306

Brake cable replaces Toro 103-2683. Fits HD Recycler models 22162-22190.

**Blade Brake Cable for
TORO**

Conduit 62"
Inner Wire 68-3/8"
Wire Travel 8-7/8"



Order No. 05 - 13436

Blade brake cable replaces Toro 99-6291. Fits commercial Pro-Line mower.

**Drive Cable for
TORO**

Conduit 31-1/4"
Inner Wire 37-1/2"
Wire Travel 6-1/4"



Order No. 05 - 13430

Drive cable replaces Toro 84-9120 traction transmission. Fits commercial Pro-Line mower.

03 THROTTLE CABLES

CONTROLS, THROTTLES & CABLES



Drive Cable for TORO

Conduit 35-1/4"
Inner Wire 45-1/4"
Wire Travel 10"

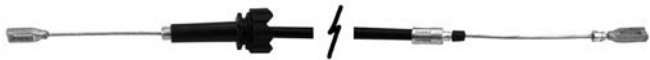

Order No. 05 - 13437

Drive cable replaces Toro 70-1080. Fits commercial Pro-Line mower.

Drive Cable for TORO

Conduit 34-5/8"
Inner Wire 43-1/2"
Wire Travel 8-7/8"



Order No. 05 - 13431

Drive cable replaces Toro 74-1791 traction transmission. Fits commercial Pro-Line mower.

Traction Cable for TORO

Conduit 32-1/4"
Total Length 47-1/4"



Order No. 05 - 14620

Traction cable replaces Toro 106-8300. Fits super recycler mower.

Brake Cable for SNAPPER



Order No. 05 - 8293

Brake cable. Replaces Snapper 15476. Fits Snapper rear engine riders with 28" & 30" decks and one brake/clutch pedal. Length 47".

Order No. 05 - 8294

Brake cable. Replaces Snapper 15477. Fits Snapper rear engine riders with 33" & 41" decks and one brake/clutch pedal. Length 50"

03 THROTTLE CABLES

Brake Cable for MTD

Length 5-3/4"



Order No. 05 - 10686

Brake cable replaces MTD 746-0970. Fits 42" deck mowers. 3/8" eyelets on each end.

Blade Brake Cable for MURRAY

Conduit 43"
Inner Wire 49-3/8"
Wire Travel 6"



Order No. 05 - 12969

Blade brake cable replaces Murray 1102094MA.

Deck Engagement Cable for AYP

Conduit 31"
Overall Length 44-7/8"



Order No. 05 - 13380

Deck engagement cable replaces AYP 193235, Poulan 532193235. Fits 38" decks. Conduit Length 29-3/4", Cable Length 45-1/8", Spring Length 6", Coil Length 5"

Deck Engagement Cable for AYP

Conduit 31"
Overall Length 45-1/8"



Order No. 05 - 10891

Deck engagement cable replaces AYP 175067/169676. Fits 42" riders.



CONTROLS, THROTTLES & CABLES

Deck Engagement Cable for MTD

Conduit 25"
Length 43"



Order No. 05 - 13657

Deck engagement cable replaces MTD 946-04092 / 746-04092. Also replaces Toro. Outer casing 26" long.

Shift Cable for JOHN DEERE

Conduit 43"
Inner Wire 46"
Wire Travel 3"



Order No. 05 - 14622

Shift cable replaces John Deere GC00578 and AM107139. Fits 21" walk behind mowers JA65, JE75, JX75 & JX85.

Engine Brake Cable for MTD

Conduit 43"
Inner Wire 49-1/2"
Wire Travel 5-1/2"



Order No. 05 - 11511

Engine brake cable replaces MTD 746-0551. Fits model 440, E466 and 469 series. "Z" bend on end.

Engine Brake Cable for MTD

Conduit 49"
Inner Wire 53-1/2"
Wire Travel 5-1/2"

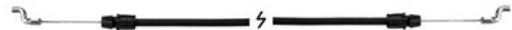

Order No. 05 - 11512

Engine brake cable replaces MTD 746-0552. Fits 1985 & up walk-behind model series 030, 040, 050, 060, 070, 080, 090, 100, 200, 400 & 700. For self-propelled model series 200, 400, & 700. Push in clip with heavy "Z" bend on each end.

Engine Brake Cable for MTD

Conduit 40-1/2"
Inner Wire 47"
Wire Travel 5-1/2"

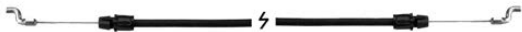

Order No. 05 - 11513

Engine brake cable replaces MTD 746-0554. Fits 1990-96 walkbehind model series 300, 400, & 500. For 1998 & up model series 070 & 100. For 1990 & up self propelled model series 300, 400, & 500. Die cast "Z-Bend" on each end.

Engine Brake Cable for MTD

Conduit 55"
Inner Wire 61-1/2"
Wire Travel 5-1/2"

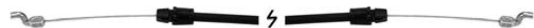

Order No. 05 - 11514

Engine brake cable replaces MTD 746-0555. For model 573, 20" deck, model 370-379, model 445, 21" rear-discharge. Die cast "Z" bend on each end.

Engine Brake Cable for MTD

Conduit 51"
Inner Wire 55-1/2"
Wire Travel 5-1/2"



Order No. 05 - 11515

Engine brake cable replaces MTD 746-0737. For 1994-1997 walkbehind model series 070, 080, 100, 200, 400, & 500. Die cast "Z" bends on each end.

Engine Brake Cable for MTD

Conduit 48-1/4"
Inner Wire 60-1/4"
Wire Travel 12-1/2"

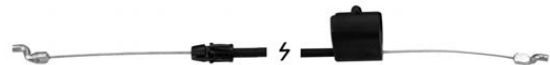

Order No. 05 - 11517

Engine brake cable replaces MTD 746-0946. Fits most side discharge mowers 1986 & prior. Snap fit to handle. "Z" bend on end.

Transmission Cable for HONDA



Order No. 05 - 8568

Transmission cable replaces Honda 54510-VB5-800, Code 2963627. Fits Honda 21" walk behind mowers, models HRA216 from 1988 to 1991, HRC216 from 1992 to present with a 2 speed transmission. **Conduit length 44-3/4", wire length 49-7/8".**

Transmission Cable for HONDA

Conduit 42-1/8"
Inner Wire 44-3/4"
Wire Travel 1-1/2"

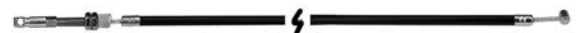

Order No. 03 - 10119

Transmission cable replaces Honda 54520-VA3-801. Fits model HR214 walkbehind mower.

03 THROTTLE CABLES

CONTROLS, THROTTLES & CABLES



Transmission Cable for HONDA

Conduit 42-3/4"
Inner Wire 47-5/8"
Wire Travel 3-1/2"



Order No. 03 - 10121

Transmission cable replaces Honda 54520-VB5-P00. Fits models HRC216R1HXA & HR216HXA walkbehind mowers.

Transmission Cable for HONDA

Conduit 42-1/2"
Inner Wire 47-1/2"
Wire Travel 3-3/4"



Order No. 03 - 10120

Transmission cable replaces Honda 54520-VA3-P03. Fits models HR1215HXA & HR215K1HXA .

Steering Cable for STIGA



Order No. 05 - 50215

Steering cable replaces Stiga 1134-9022-01. Fits Stiga Park 2002. Fittingmarked centerpoint. **Length 115" (2921 mm)**.

Order No. 05 - 50216

Steering cable replaces Stiga 1134-9023-01. Fits Stiga Villa 808E. Fittingmarked centerpoint. **Length 134.5" (3416.30 mm)**.

Winch Cable for SCAG

Length 52"



Order No. 03 - 9695

Winch cable replaces Scag 48045. Fits 61" & 72" riders, with front deck lift. Models STHM.

Steering Cable for HUSKY

Over all Length 42-1/2"



Order No. 05 - 8764

Steering cable replaces Husky 5065891-01.

Steering Cable for SCAG

Length 67-1/2"



Order No. 05 - 9694

Steering cable replaces Scag 48828. Fits 61" & 72" cut riders, models ST17KA & 19KH.

Clutch Cable for SNAPPER



Order No. 05 - 2700

Replaces Snapper 7012425 for 26", 28" and 30" rear engine riders. **Length 51-3/4"**. (yellow)

Order No. 05 - 2699

Replaces Snapper 7012605 for 33" rear engine riders. **Length 55"**. (black)

Clutch Cable for MTD

Total Length 48"
Conduit Length 37"



Order No. 05 - 8833

Clutch cable replaces MTD 746-0629. Fits all self propelled walk behind mowers with cog front wheels.

03 THROTTLE CABLES



CONTROLS, THROTTLES & CABLES

Deck Cable for MTD

Conduit Length 42-1/8"
Overall Length 59-1/2"

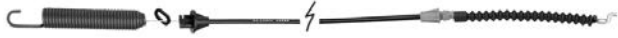

Order No. 05 - 14341

Deck cable replaces MTD 946-04618A, 746-04618A. Fits LTX1040 series 13AT, 13AX, 113WX, with 42" & 46" decks.

Lift Cables



Order No. 10 - 858

Murray Lift cable. Replaces 21913, length 21-1/8".

Deck Lift Cable for CASTELGARDEN

Total Length 32" (812.8 mm)

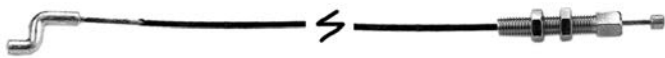

Order No. 10 - 50167

Deck Lift Cable replaces Castelgarden 82004600/0. Bolt Length 2" (50.8 mm), Z bend Length 1-1/4" (31.75 mm)

Deck Lift Cable for MTD



Order No. 10 - 12410

Deck lift cable replaces MTD 746-0968. Lanyard cable with swivel pins. Length 17".

Lift Cable for MURRAY

Total Length 28-1/4"



Order No. 05 - 9125

Lift cable replaces Murray 24470. Fits 38" & 39" cut models. 28-1/4" total length with molded rod end 5/16" x 18" rod.

Deck Engagement Cable for MTD



Order No. 05 - 12965

Deck engagement cable replaces MTD 746-04173B, 746-0417A, 746-04173, 946-04173B, 946-04173A, 946-04173.

Deck Lift Cable for SNAPPER



Order No. 10 - 10701

Deck lift cable replaces Snapper 7027427. 4-7/8" overall length, Fits 25" - 41" decks. For 8, 9, 10, & 11 series engine riders. Heavy duty "T" slug.

Order No. 10 - 10702

Deck lift cable replaces Snapper 7027429. 6-1/2" overall length, Fits 25" - 33" decks. For 14, 15, 16 & 18 series engine riders. Heavy duty "T" slug.



Order No. 10 - 10703

Deck lift cable replaces Snapper 7016844.5-5/8" overall length, Fits 33" - 42" decks model LT120-160. For 1 & 2 series lawn tractors. Heavy duty eyelet.



Order No. 10 - 10704

Deck lift cable replaces Snapper 7023180.6-1/2" overall length, Fits 33" - 42" decks model LT120-160. For 0, 1 & 2 series lawn tractors. Heavy duty eyelet. Threaded.

03 THROTTLE CABLES

CONTROLS, THROTTLES & CABLES



Inner Wire



Order No. 03 - 245

.058" Standard throttle wire, comes in 100' rolls only. Used with our 03-247 conduit.

Order No. 03 - 246

.072" Heavy duty clutch wire, comes in 100' rolls only. Used with our 03-248 conduit.

Conduit



Order No. 03 - 247

.188" Standard conduit, comes in 50' rolls only. Used with our 03-245 inner wire.

Order No. 03 - 248

.203" Heavy Duty Conduit, comes in 50' rolls only. Used with our 03-246 inner wire.

Premium Conduit



Order No. 03 - 9136

.188" Premium conduit, comes in 50' rolls only. Fits solid wire or standard cable. Black polyethylene outside wrap with clear polyethylene liner, reduces friction & provides weather seal.

Conduit Clips



Order No. 03 - 249

(For 3/16" cable) bolt on, Zinc plated.

MIN010

Order No. 03 - 2701

(For 7/32" cable) bolt on, Zinc plated. For newer plastic cables.

MIN010

Conduit Clips



Order No. 03 - 252

(For 7/8" tubing) clamp on, Zinc plated. For holding conduit to handle.

MIN010

Order No. 03 - 251

(For 3/4" tubing) clamp on, Zinc plated. For holding conduit to handle.

MIN010

Conduit Clip



Order No. 03 - 2702

(For 7/8" tubing) clamp on, Zinc plated. Holds two 1/4" cables to handle.

MIN010

Conduit Clip



Order No. 03 - 250

Bolt on. Used to clamp throttle cable to engine. Zinc plated. Complete with screw. Replaces Briggs & Stratton 22372 & 692179.

MIN010

Conduit Clip for HONDA



Order No. 03 - 10855

Conduit clip replaces Honda 16516-891-000. Fits GX 110, 120, 140, 160.

Mounting Adapter for MURRAY Control

Order No. 03 - 8506

Throttle control mounting adapter for Murray. Used with our 03-8530 throttle control assembly.

MIN010



03 THROTTLE CABLES



CONTROLS, THROTTLES & CABLES

**Universal BrushCutter
Throttle Control**



Order No. 27 - 7906

Universal brushcutter throttle control. Universal control body. Long brushcutter. (Long)

**Throttle Control for
MCCULLOCH**



Order No. 27 - 9049

Throttle control for McCulloch. Replaces Red Max 323814510 (RH) & 223814520 (LH). Fits models Mac 17, Mac 25 & Ryobi models RGH600 & RWH 900.

**Universal BrushCutter
Throttle Control**



Order No. 27 - 7905

Universal brushcutter throttle control. Universal control body. Short brushcutter. (Short)

**Throttle Lever for
TANAKA**



Order No. 27 - 7411

Throttle Lever (metal) replaces Tanaka 870-33341-900. Also fits Green Machine 4600LP and Weedeater 3000.

**Throttle Lever for
SHINDAIWA**



Order No. 27 - 8673

Throttle lever with trigger lock replaces Shindaiwa 72910-14320. Fits most Red Max, Green Machine & Shindaiwa trimmers. Fits 7/8 OD handles.

**Throttle Cable for
ECHO**

Conduit Length 13-1/4"
Cable Length 16-7/8"



Order No. 27 - 12505

Throttle cable replaces Echo 178001-0893-1.

**Throttle Cable for
ECHO**

Conduit Length 15-5/16"
Cable Length 17-5/8"

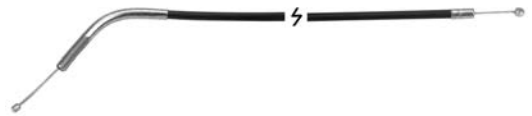

Order No. 27 - 12506

Throttle cable replaces Echo V430000140. Fits Echo trimmer models PR260 & SRM260.

**Throttle Cable for
ECHO**

Conduit Length 17-1/8"
Cable Length 19-5/16"



Order No. 27 - 12508

Throttle cable replaces Echo V430000730. Fits Echo trimmer models SRM230.

**Throttle Cable for
HOMELITE**

Conduit 12"
Inner Wire 16-3/4"
Wire Travel 3-3/4"



Order No. 27 - 9687

Throttle cable replaces Homelite 08832-02.

03

THROTTLE CABLES

CONTROLS, THROTTLES & CABLES



**Throttle Cable for
HOMELITE**

Conduit 11"
Inner Wire 18-1/2"
Wire Travel 7-1/2"



Order No. 27 - 9686

Throttle cable replaces Homelite 08832-01 & UP04117. Fits Bandit ST155 & 185 trimmers.

**Throttle Cable for
McCULLOCH**

Total Length 16"



Order No. 27 - 9496

Throttle cable replaces McCulloch 300149-01. Fits model Mac 2816 (Homeowners).

**Throttle Cable for
STIHL**

Conduit Length 34-3/4"
Cable Length 42-1/2"

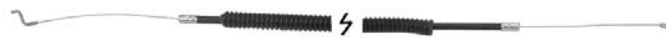

Order No. 27 - 12503

Throttle cable replaces Stihl 4137-180-1109. Fits Stihl line trimmer models FS75-FS85.

**Throttle Cable for
STIHL**

**Throttle Cable for
STIHL**

Conduit Length 33-1/4"
Cable Length 41-13/16"



Order No. 27 - 12501

Throttle cable replaces Stihl 4119-180-1101. Fits Stihl brush-cutter.



Order No. 27 - 12499

Throttle cable replaces Stihl 4180-180-1101. Fits Stihl line trimmers.

**Throttle Cable for
STIHL**

Conduit Length 33-15/32"
Cable Length 44-11/16"

**Throttle Cable for
STIHL**

Conduit Length 46-1/4"
Cable Length 51"



Order No. 27 - 12504

Throttle cable replaces Stihl 4137-180-1100. Fits Stihl line trimmers.



Order No. 27 - 12502

Throttle cable replaces Stihl 4282-180-1100. Fits Stihl blower models BR500, BR550, BR600.

**Throttle Cable for
STIHL**

Conduit Length 33-1/6"
Cable Length 38-5/16"

**Throttle Cable for
SHINDAIWA**

Conduit Length 39-11/32"
Cable Length 42-9/32"



Order No. 27 - 12500

Throttle cable replaces Stihl 4128-180-1104. Fits Stihl brushcutter models FS120, 120R, 200, 200R, 250, 250R.



Order No. 27 - 12509

Throttle cable replaces Shindaiwa 70105-83100. Fits Shindaiwa trimmer models C270 & T270.

03
THROTTLE CABLES



CONTROLS, THROTTLES & CABLES

Throttle Cable for SHINDAIWA

Conduit Length 13-3/4"
Cable Length 16-7/16"



Order No. 27 - 12507

Throttle cable replaces Shindaiwa 62074-83110. Fits Shindaiwa trimmer model T272.

Drive Cables for WEEDEATER

35" Overall length



Order No. 27 - 6926

Replaces Weedeater 93935. Fit models XR20, XR50 & 1400.

35-1/4" Overall length



Order No. 27 - 6927

Replaces Weedeater 93575. Fit models XR30 & 1500.

41-1/8" Overall length



Order No. 27 - 6928

Replaces Weedeater 93831. Fits model 1700.

Drive Shaft Cable for WEEDEATER

Length 37-3/8"



Order No. 27 - 8567

Drive shaft cable replaces Weedeater 530-094676. Fits GTI 15 & 16 trimmers.

Throttle Cables for SHINDAIWA



Order No. 27 - 8563

Throttle cable replaces Shindaiwa 70036-83110. Fits string trimmer models C-20 & C-25. Length 23-1/2".

Order No. 27 - 8564

Throttle cable replaces Shindaiwa 20000-83180. For T-20, T-25. Fits bull bar handle brushcutter models C-20 & C-25 string trimmers. Length 44".

Drive Cable for HOMELITE

Length 49"



Order No. 27 - 8566

Drive cable replaces Homelite 98816 & UP03031. Fits models ST175, ST145, ST155.

Length 55-1/8"



Order No. 27 - 8565

Drive cable replaces Homelite 98818. Fits model ST185.

03 THROTTLE CABLES

CONTROLS, THROTTLES & CABLES



Mini-Bike Throttle Controls

Order No. 04 - 257

(For 7/8" handle)

Order No. 04 - 258

(For 1" handle)



These are our deluxe throttle controls which come complete with twist grip and dummy grip. (metal).

Mini-Bike Throttle Cables



Order No. 04 - 261

48" innercable, 43" outercasing.

Order No. 04 - 262

53" innercable, 48" outercasing.

Order No. 04 - 263

60" innercable, 55" outercasing.

This cable comes complete with inner cable and housing. It also has a ball on one end, barrel on the other.

Mini-Bike Brake Cable



Order No. 04 - 264

This is a universal brake cable which has a 65" innercable and a 60" outercasing. Heavy duty long wear.

THROTTLE CABLES 03

Mini-Bike Brake Cable

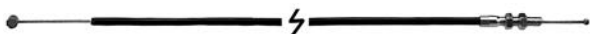

Order No. 04 - 266

These brake cables work on mini-bikes using disc brakes. Comes complete with spring and U-clamp. With 56" cable.

Throttle Cable - ATV



Order No. 04 - 269

Combination ball-barrel ends. For use on all terrain vehicles. 100" innercable and 90" outercasing.



GO CART/ MINI BIKE ACCESSORIES

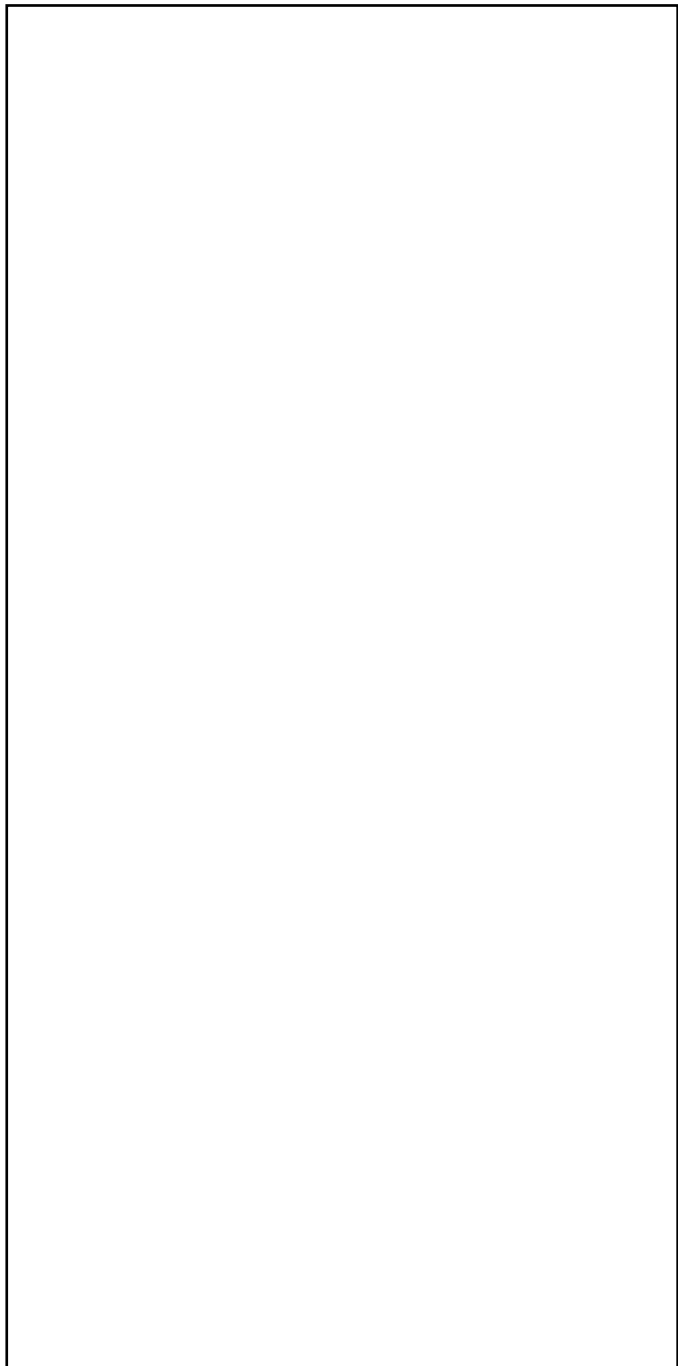
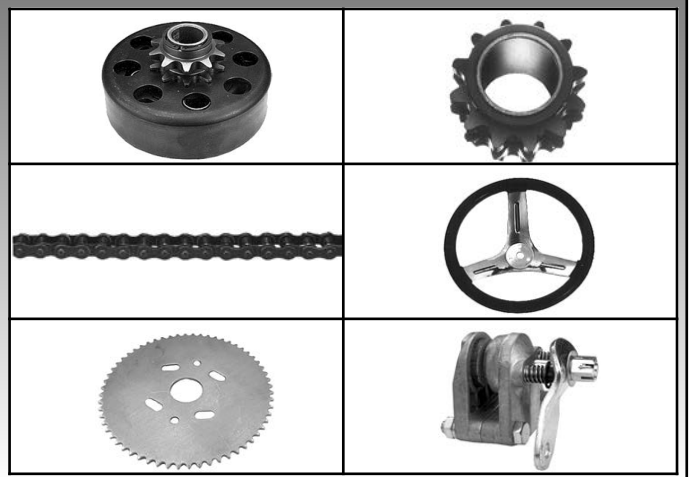

Quick-Glance

GO CART/ MINI BIKE	PG.
Accessories	
Clutch	80-81
Chain	81
Torg-a-verter	81
Sprockets	80-81
Steering Wheel	83
Brake Assembly	84

GO CART/ MINI BIKE ACCESSORIES



MAX LUBE CLUTCH SYSTEM

for 3/4" crankshafts (with 5/16" threaded in hole)

Max Clutch Lube System has revolutionized the standard centrifugal clutch by adding special features that will extend the life of ordinary centrifugal clutches.

- Grooved bushing for grease retention
- Ground sleeve with hole for grease
- Special 3/4" long zerk/bolt
- Built-in internal key
- No set screws required

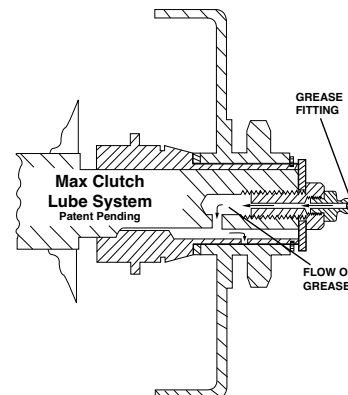

Order No. 04 - 7680

Bore 3/4", Chain type No. 35, No. of teeth 12.

Order No. 04 - 7681

Bore 3/4", Chain type No. 41, No. of teeth 10.

Zerk / Bolt Assembly for Brister Lube Clutch System

Order No. 04 - 8489

Zerk / Bolt assembly fits our 04-7680 & 04-7681 clutch.



HILLIARD'S EXTREME DUTY GO KART CLUTCH for 3/4" crankshafts

Hilliard's new patent pending Extreme Duty centrifugal clutch can handle higher temperatures to offer longer clutch life.

- Bi-Directional, can run clockwise & counter clockwise.
- Dissipates heat better, extending clutch life.
- Clutch is easily tuned for your specific need.
- Quick change spring and sprocket design.
- No special tools needed.
- Built in internal keyway.
- Must use crankshaft bolt.



Order No. 04 - 10389

Bore 3/4", Chain type No. 35, 12 Teeth.

Order No. 04 - 10390

Bore 3/4", Chain type No. 41, 10 Teeth.

Clutch Drive Sprockets from HILLIARD

Order No. 04 - 12466

Hilliard clutch drive sprocket 8444-47-007-B. 1-27/32" OD, 10 teeth, chain 40/41. For Ld4s-4 & Ld4s-4I series Go-Kart clutches. Fits our 04-10390 clutch.

Order No. 04 - 12468

Hilliard clutch drive sprocket #8444-47-023. 1-27/32" OD, 12 teeth, chain 35. Fits our 04-10389 clutch.



Clutch Bushing from HILLIARD



Order No. 04 - 12467

Hilliard clutch bushing 8444-15-003-B. 3/4" bore, 3/16" Keyway. Used with our 04-10389 & 04-10390 clutches that have a snap ring.

Centrifugal Clutch Key



Order No. 04 - 461

Centrifugal clutch key 3/16" x 3/4". Replaces MTD 914-0122 & 714-0122

MIN010

04

GO-KART PARTS



Max-Torque Clutches

All Max-Torque Clutches come complete with set screws.

Order No. 04 - 455

3/4" Bore, 35 Chain, 12 teeth.

Order No. 04 - 456

5/8" Bore, 35 Chain, 11 teeth.

Order No. 04 - 457

3/4" Bore, 40, 41 Chain, 10 teeth.

Order No. 04 - 458

5/8" Bore, 40, 41 Chain, 10 teeth.



Max-Torque Belt Drive Clutch

Order No. 04 - 864

Bore 3/4", For either A or B section belt. Pulley is 3.20" OD.

Order No. 04 - 865

Bore 5/8", For either A or B section belt. Pulley is 3.20" OD.



Max-Torque Torque Converter Driver Unit



Order No. 04 - 13988

Max-Torque TCDRS34 Torque Converter Driver Unit. Symmetrical, 3/4" shaft, 5" diameter. Includes a 5/16" - 24 x 1-3/4" bolt, lock washer and flat washer. Replaces Comet 219559. Uses 11/16" wide belt.

Max-Torque Torque Converter Driven Unit



Order No. 04 - 13989

Max-Torque TCDNS34-OUT Torque Converter Driven Unit. Symmetrical, 3/4" shaft, 7" diameter. Includes a 2.7" key. **Outboard** mount. Fits Yerfdog, Brister Thunder Karts, USA Industries, Bob's Kart Shop (BKS) all are Outboard driven which needed to float on the jackshaft to stay aligned with the driver. Uses 11/16" wide belt.

Set Screw for Max-Torque Clutch



Order No. 02 - 119

AS-1414-F 1/4" set screw.

MIN010

Order No. 04 - 13990

Max-Torque TCDNS34-IN Torque Converter Driven Unit. Symmetrical, 3/4" shaft, 7" diameter. Includes a 2.7" key. **Inboard** mount. Fits Carter Brothers and Brister Design, similar to Comets series 20. Uses 11/16" wide belt.

Chain



Order No.

Size

Length

11 - 9322	C-35	3/8" x 3/16" 3 Ft
11 - 9318	C-40	1/2" x 5/16" 3 Ft
11 - 9320	C-41	1/2" x 1/4" 3 Ft
11 - 9321	C-35	3/8" x 3/16" 4 Ft
11 - 9317	C-40	1/2" x 5/16" 4 Ft
11 - 9319	C-41	1/2" x 1/4" 4 Ft

Bronze Bushing Bearings



Order No. 04 - 465

For 3/4" clutch. (7/8" ID)

Order No. 04 - 466

For 5/8" clutch. (3/4" ID)

GO CART/ MINI BIKE ACCESSORIES



Key Stock

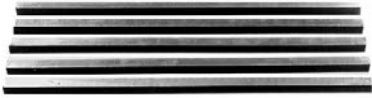

Order No. 04 - 5600

3/16" - 12" length. (green)

MIN005

Order No. 04 - 5601

1/4" - 12" length. (blue)

MIN005

Order No. 04 - 5602

5/16" - 12" length. (red)

MIN005

Order No. 04 - 5603

3/8" - 12" length. (yellow)

MIN005

Steel Plate Sprockets for 35 Chain



Order No. 04 - 9484

60 Tooth, 7-1/4" OD, 1-3/8" ID.

Order No. 04 - 9485

72 Tooth, 8-3/4" OD, 1-3/8" ID.

Drive Sprockets



Order No. 04 - 472

12 tooth for 35 chain.

Order No. 04 - 473

14 tooth for 35 chain.

Order No. 04 - 474

16 tooth for 35 chain.

Order No. 04 - 475

9 tooth for 41 chain.

Order No. 04 - 476

10 tooth for 41 chain.

Available for both 35 & 41 chain, with 5/8" bore, complete with set screw. 5/8" through center hole

Steel Plate Sprockets for 35 Chain



Order No. 04 - 469

60 Tooth, 7-1/4" OD.

Order No. 04 - 470

72 Tooth, 8-3/4" OD.

Order No. 04 - 471

66 Tooth, 8" OD.

These sprockets are made of heavy gauge steel for long lasting life. To be used on 35 chain with 2" center hole and has popular four bolt hole Indus pattern with mounting holes 2" apart.

Steel Plate Sprockets for 41 Chain



Order No. 04 - 8247

48 tooth, 41 chain Indus pattern and universal mounting holes 5/16" and 3/8". 8" OD, 2-1/8" ID.

Order No. 04 - 8248

54 tooth, 41 chain Indus pattern and universal mounting holes 5/16" and 3/8". 9" OD, 2-1/8" ID.

Order No. 04 - 8249

60 tooth, 41 chain Indus pattern and universal mounting holes 5/16" and 3/8". 10" OD, 2-1/8" ID.

Max-Torque Clutch



Order No. 04 - 12463

3/4" Bore, 41 chain, 14 teeth.

Jackshaft

Order No. 04 - 480

12" long. This is the popular 5/8" diameter jackshaft with a 3/16" keyway.



04

GO-KART PARTS



Heavy Duty Clutch Collars

Order No. 04 - 467

5/8" ID, 1/2" Height. Also replaces MTD 711-0169.

Order No. 04 - 468

3/4" ID, 9/16" Height.

Complete with set screws.



Split Locking Shaft Collar



Order No. 04 - 9266

3/4" Split Locking shaft collar. 1/2" height, 1-1/2" OD.

Order No. 04 - 9267

1" Split Locking shaft collar. 1/2" height, 1-3/4" OD.

Complete with set screws.

Locking Shaft Collar



Order No. 04 - 9263

7/8" Locking shaft collar. 9/16" height, 1-31/64" OD.

Order No. 04 - 7329

1" Lock Collar. 5/8" Height.

Order No. 04 - 9265

1-1/4" Locking shaft collar. 11/16" height, 2" OD.

Complete with set screws.

Steering Wheel for Go-Karts



Order No. 04 - 5890

10" diameter steering wheel. 1/2" center hole, (3) 1/4" mounting holes, 1-3/8" center to center.

Steering Wheel



Order No. 04 - 9396

12" diameter steering wheel. 1/2" center hole, (3) 1/4" mounting holes, 1-3/8" center to center.

Sprockets & Bearings



Order No. 04 - 462

3/4" ID for 5/8 clutch, 35 roller chain, 11 Tooth.

Order No. 04 - 463

7/8" ID for 3/4 clutch, 35 roller chain, 12 Tooth.

Order No. 04 - 464

7/8" ID for 3/4 clutch, 41 roller chain, 10 Tooth. Not interchangeable with Hillard.

Disc Brakes for MANCO



Order No. 04 - 10191

Brake replacement pucks for our 04-9306 disc brake. 2 pucks per bag. Size: 1.3" H x 1.6" W x .350" Th.

GO CART/ MINI BIKE ACCESSORIES



Rebuild Kit for Brake Caliper



Order No. 04 - 9576

Rebuild kit for our 04-9306 disc brake caliper. Kit includes (2) friction pads, (1) load shoe, (1) adjusting screw, (1) adjusting nut & (1) plunger.

Disc Brake Assembly

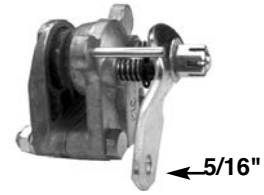

Order No. 04 - 488

This popular disc brake is used on many riding lawnmowers, minibikes, and snowmobiles. Uses our 04-490 pucks.

Disc Brake Assembly

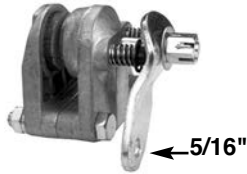

Order No. 04 - 9952

Disc brake assembly. Fits gasoline powered scooters. Uses our 04-490 replacement pucks.

Replacement Pucks



Brake Band



4" Dia.
Fits 4" drums

Order No. 04 - 486

Brake band and pin for our 04-485 brake drum.

Order No. 04 - 8200

Brake band pin only for our 04-486.

MIN010

Order No. 04 - 489

Round. 1-1/8" OD, 1/2" Height.

Order No. 04 - 490

Flat-End type, used on our 04-488.

These replacement pucks are the replacements for the most popular disc brakes. Sold only in pairs.

Brake Band for MANCO



Order No. 05 - 9195

4-3/16" Brake band with bracket replaces Manco 1036. Also fits other Go Carts. Same as our 05-486.

Order No. 04 - 10312

Brake band fits 4-3/4" Dia. brake drums on Carter Brothers go-karts.



04

GO-KART PARTS

Order No. 04 - 485

This 4" steel Brake Drum has the popular Indus pattern and universal mounting holes 5/16" and 3/8".

ID 2"
OD 3-31/32"
Height 1"



Twist Grip Ferrule



Order No. 04 - 268

This ferrule is used on many twist grips to hold the housing in place.

MIN010



GO CART/ MINI BIKE ACCESSORIES

Wire Stop



Order No. 04 - 219

Wire stop. Used for securing inner wire to engine.

MIN010

Mini-Bike Wire Swivel Stop



Order No. 04 - 267

This universal wire stop will work on 03-261, 03-269 and 03-263 throttles and 04-264 brake cables. It will also work as a wire swivel.

MIN010

Swivel Wire with Screw & Washer



Order No. 04 - 11548

Swivel wire with screw and washer.

MIN010

Kill Switches



Order No. 31 - 2946

Kill Switch with a 48" lead wire. Used on go-carts, ATV's, etc.



Order No. 31 - 8944

Deluxe toggle type kill switch with a 48" lead wire. Used on go-karts & ATV's. Fits 1" frame.



Order No. 31 - 7728

Toggle type kill switch with a 48" lead wire. Used on go-carts, ATV's, etc.

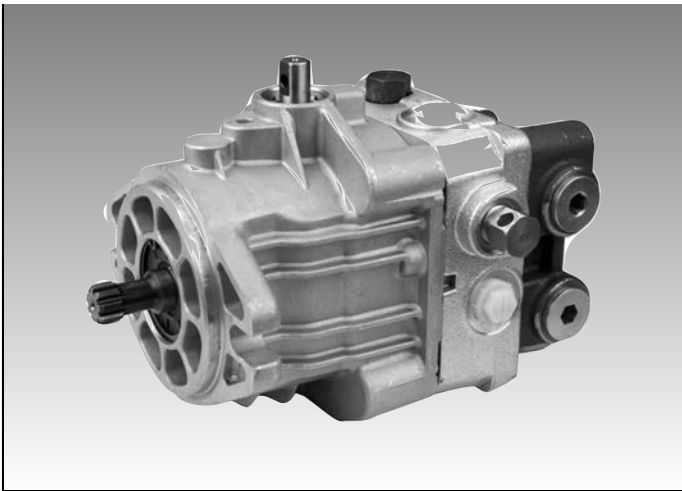

Quick-Glance

DRIVE PARTS	PG.
Sprockets	88
Drive Rollers	88-89
Drive Gear	89
Drive Shaft	89, 93
Swivel	90
Brake Bands	91-91
Brake Drum	91
Ratchet Holder	92
Drive Disc	92-93
Oil Seal	94
Trans Gasket	94
Hydrostatic Pumps	94

DRIVE PARTS



05

Sprockets & Assemblies

ID 2-1/8"
OD 6-1/2"



Order No. 05 - 255

Replaces MTD 09054. For 41 chain 40 tooth.

ID 1/2"
OD 1"
Height 3/4"



Order No. 05 - 478

Transmission sprocket 1/2" bore, 43 chain, 10 tooth. Replaces Murray 20411.

ID 1/2"
OD 13/16"
Height 13/16"
Keyway 3/32"



Order No. 05 - 3205

Replaces MTD 748-0852, 948-0852 and Foote B-1084. For 41 chain, 8 tooth.

ID 1/2"
OD 1"
Height 5/8"
Keyway 3/32"



Order No. 05 - 422

Replaces AYP - Sears/Roper 67486. For 43 chain, 9 tooth.

Drive Rollers

ID 1/2"
OD 2-1/4"
Width 1-7/8"



Order No. 05 - 3227

Replaces MTD 731-0393.

ID 5/8"
OD 2-3/4"
Width 1-7/8"



Order No. 05 - 308

Replaces Air Cap, Murray 20066, AYP 79951.

ID 5/8"
OD 3-1/8"
Width 2-5/16"



Order No. 05 - 309

Replaces MTD 10914.

ID 1/2"
OD 2-1/4"
Width 1-7/8"



Order No. 05 - 8309

Drive Roller replaces MTD 731-0908, 931-0908. Fits models after 1987 with splined shaft.



DRIVE PARTS

05

DRIVE PARTS



ID 1/2"
OD 7/8"
Width 2-1/4"

Order No. 05 - 2953

Replaces Lawn-Boy 607657, left drive roller.

Order No. 05 - 2958

Replaces Lawn-Boy 607658, right drive roller.



ID 1/2"
OD 1-1/8"
Width 2-1/4"

Order No. 05 - 3270

Replaces Lawn-Boy 610441. Left hand drive roller for 21" self-propelled high speed mower.

Order No. 05 - 3269

Replaces Lawn-Boy 610440. Right hand drive roller for 21" self-propelled high speed mower.

Wheel Drive Gear for TORO



Order No. 05 - 7920

Wheel drive gear replaces Toro 18-9690. Fits side discharge, front wheel drive self propelled models.

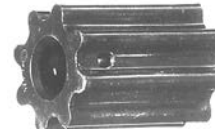

ID 5/8"
OD 1-1/2"
Width 2"

Order No. 05 - 307

Replaces MTD 07120. Western Auto, Penneys and Wards.

Wheel Drive Gear for TORO



Order No. 05 - 8207

Drive Gear replaces Toro 39-9160. Fits models 22020, 22030, 22035 and 20680 rear wheel drive models.

Key for TORO

.125" x .187" x .452"



Order No. 05 - 8770

Wheel drive key replaces Toro 39-9680. Fits Toro Proline 21" self propelled mowers. Used with our **05-8207** wheel drive gear. MIN010

Drive Shaft



Order No. 05 - 3271

Replaces Lawn-Boy 683129. Engine to gear box drive shaft assembly. For self-propelled mowers.

Drive Joint Assembly for HONDA



Order No. 05 - 12126

Drive joint assembly replaces Honda 22100-VB5-804. Fits models HRA216SXA, 215SXA & HRC216HXA.

Output Shaft for TORO



Order No. 05 - 13433

Output shaft replaces Toro 74-1890 & 66-7330, self propelled gear box. Fits commercial Proline 21" models 22166, 22167, 22168.

Drive Pulley Key for BRIGGS & STRATTON

3/16" x 1-1/2"



Order No. 05 - 8052

Drive pulley key replaces B&S 91539. Fits B&S models 2 thru 18 hp. MIN010

Square Key for TORO

1/8" x 2"



Order No. 05 - 7177

Square Key replaces Toro 39-7842. Fits 21" SP walk behind. Used on short shaft in gear case. MIN010

DRIVE PARTS



05

DRIVE PARTS

Swivel Rod for ENCORE

Thread Size 5/16"-18"
OD 5/16"
Shoulder Length 1/2"



Order No. 05 - 10811

Swivel rod replaces Encore 363029.

Short Swivel for EXMARK

Bore Size 11/32"
OD (Pin) 5/16"
Shoulder Length 1/2"
Total Length 1-7/32"



Order No. 05 - 10813

Short swivel replaces Exmark 603676.

Swivel for BOBCAT

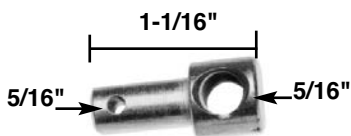

Order No. 05 - 8099

Control rod linkage swivel replaces Bobcat 33004A.

Swivel for BOBCAT

Thread Size 3/8"-18"
OD (Pin) 5/16"
Shoulder Length 1/2"



Order No. 05 - 10810

Swivel replaces Bobcat 33103.

Adjusting Nut for MURRAY

Length 1-5/16"



Order No. 05 - 8970

Adjusting nut replaces Murray 21920. Fits bolt size 3/8" - 16. Also fits Scag 43032.

Lower Swivel for HUSQVARNA

Thread Size 3/16"-24"
OD (Pin) 3/16"
Shoulder Length 7/16"
Total Length 1"



Order No. 05 - 10812

Lower swivel replaces Husqvarna 539-109334. Also fits Yazoo/Kees.

Brake Band for BOBCAT

Width 3/4"
Diameter 6"



Order No. 05 - 7788

Brake band. Replaces Bobcat 138008. For 36", 48", 54", 61" mid size mowers.

Brake Band for DIXIE CHOPPER



Order No. 05 - 11508

Brake band replaces Dixie Chopper 65244. Fits parking brake on all mowers.



Brake Band for EXMARK



Order No. 05 - 8266

Brake band. Replaces Exmark 1-302036. Fits 32" and 48" variable and 5 speed decks, removable brake bands. Used on our 05-8274 brake assembly (left side).



Order No. 05 - 10415

Brake band replaces Exmark 1-323262. Fits Metro walk-behind mowers. Width 3/4", Dia. 6-5/8".

Brake Band for SCAG

Width 3/4"
Diameter 7"



Order No. 05 - 7787

Brake band. Replaces Scag 48210. Also replaces Snapper 7017048, 7074810. For 36", 40", 48", 52", 61" mid size mowers. Also fits Exmark 1-513048, Encore 363176, and Jacobson 182222.

Brake Assembly for SNAPPER/KEES

ID 5-1/4"



Order No. 05 - 8276

Brake assembly. Replaces Snapper 7076340, Kees 322042. Fits 32", 36" and 48" variable and 5 speed mower decks (left side).

Brake Band for TORO



Order No. 05 - 8265

Brake band. Replaces Toro 51-4700. Fits 32" thru 61" deck walk behind mowers.

Brake Drum for TORO

ID 2-5/16"
OD 5"
Center to Center 2-3/4"



Order No. 05 - 8296

Brake drum. Replaces Toro 51-4180. Fits Proline Z models.

Brake Drum for EXMARK

ID 2-1/4"
OD 6"
Width 1-1/4"



Order No. 05 - 9752

Brake drum replaces Exmark 1-323261. Fits Metro units. Included in our 13-9751 assembly.

Brake Drum for GREAT DANE

ID 2-1/4"
OD 6"
Width 1-1/2"



Order No. 05 - 9757

Brake drum replaces Great Dane D48003. Also replaces Encore 363190, Scag 48209, Jacobsen JA18219-8. Included in our 13-9758 assembly. 2-5/8 bolt center.



DRIVE PARTS

05

Blade Brake Clutch Plate for HONDA



Order No. 05 - 10862

Blade brake clutch plate replaces Honda 75150-VA3-J01, 75150-VK6-000. Fits Honda walkbehind mowers.

Ratchet Holder for HONDA (right)



Order No. 05 - 13371

Ratchet holder **right** replaces Honda 23510-VB5-803. Used with our **05-12477** wheel ratchet holder. Fits mower models HRC215, HRC216, SXA and HXA, 21" cut decks commercial units.

Ratchet Holder for HONDA (left)



Order No. 05 - 13372

Ratchet holder **left** replaces Honda 23520-VB5-803. Used with our **05-12477** wheel ratchet holder. Fits mower models HRC215, HRC216, SXA and HXA, 21" cut decks commercial units.

Wheel Ratchet Holder for HONDA

Order No. 05 - 12477

Wheel ratchet holder replaces Honda 23511-VB3-801. Fits models HRC215, HRC216, SXA & HXA. For Honda 21" cut decks, commercial units. Code 2756716.



ID 1.409"
OD 1.978"

Drive Plate & Bushings for SNAPPER



Order No. 05 - 6930

Drive Plate and Bushings. Replaces Snapper 7061275, 7061275, 7060710. Used on Snapper self-propelled mowers.

Order No. 05 - 6931

Drive Plate Bushing Only. Replaces Snapper 7013893.

MIN010

Order No. 05 - 8603

Drive plate bushing replaces Snapper 7017696. Bushing for 1993 & later models. Used in our **05-6930** assembly.

MIN010

Drive Disc & Lining



ID 3"
OD 6"

Order No. 05 - 300

Replaces Snapper 7010765 and Ariens Disc 3003. Jacobsen 990152, 158458, Gilson 32222, John Deere 122115, Lawnboy 741316, Murray 35550. Also fits Sears Rider made by Murray.



Order No. 05 - 345

Lining only. Replaces liner in Snapper 7057423. Non-Asbestos.

MIN005

Ring Rubber Wheel for AYP

Order No. 05 - 5620

Ring rubber wheel replaces AYP 179831 & Husqvarna 532-1798-31. Fits many units built since 2002.



ID 3-5/8"
OD 4-1/2"





DRIVE PARTS

05

DRIVE PARTS

Driven Disc for AMERICAN YARD PRODUCTS



Order No. 05 - 7017

Driven Disc. Replaces AYP 750688. OD 4".

Driven Disc for NOMA

ID 2-1/4"
OD 4-7/16"



Order No. 05 - 7018

Driven Disc. Replaces Noma 1325, 53830 & 313883, John Deere AM123355, Murray 1501435. Also replaces Ariens 22013, 3240700/3248300, 82-90 models. Fits 21" SP mowers. 2-5/8" bolt center.

Disc with Liner for SNAPPER



Order No. 05 - 10169

Disc with liner replaces Snapper 7053103 & 7057423. Contains our 05-300 disc and 05-345 liner.

Driven Disc Assembly for SNAPPER



Order No. 05 - 6880

Driven Disc Assembly. Replaces Snapper 7053225, 7057444, 7053225. Used on Snapper self-propelled mowers. Uses our drive ring 05-301 and bearing 09-6573.

Drive Disc for MTD

Outside Holes 11/32"
ID 1-1/8"
OD 6"



Order No. 05 - 8898

Drive disc replaces MTD 05080A. Fits snowblower models 500, 510, 520 & 600.

Transfer Rod for SNAPPER



Order No. 05 - 14173

Transfer rod replaces Snapper 7023790. Fits 21" self propelled walk-behind mowers. Used with our 05-6880 & 05-14174.

Drive Disc for SNAPPER Snowblowers



Order No. 41 - 7678

Drive Disc. Replaces Snapper 17226. Fits Snapper 4, 5, and 8 hp Snow thrower models 4222, 5222, 5242, 7222, 7242 and 8264. Also replaces Toro 37-6570

Transfer Rod Connector for SNAPPER



Order No. 05 - 14174

Transfer rod connector replaces Snapper 7032831, 7031874, 7032831. Fits 21" self propelled walkbehind mowers. Used with our 05-6880 & 05-14173.

Driven Ring



ID 3"
OD 4"

Order No. 05 - 301

Replaces Snapper 7023364 & 7010927.

Thrust Washer for SNAPPER



Order No. 05 - 7255

Thrust washer. Replaces Snapper 7014523. Used on smooth clutch assembly between disc and plate. MIN010

Shim Washer for SNAPPER



ID 3/4"
OD 1"

Order No. 05 - 8816

Shim washer replaces Snapper 7010121. Fits Snapper 57444 driven disc assembly. Fits our 05-6880 Driven Disc Assembly. MIN010

Hex Shaft



Order No. 05 - 5803

Hex Shaft. Replaces Snapper 7023744, 7021745, 7072284. For Snapper 21" self propelled walk behind mowers. Length 8-1/4".

DRIVE PARTS



05

DRIVE PARTS

Chaincase Chain for SNAPPER



Order No. 11 - 8472

Chaincase chain replaces Snapper 7010941. Fits all 25", 26", 28", 30", & 33" rear engine riders. #35 chain, 23 drive links.

Transmission Gasket



Order No. 05 - 3247

Replaces Snapper 7011774. For all 21" self-propelled mowers. MIN010

ChainCase Gasket



Order No. 05 - 3246

Replaces Snapper 7018059, 7028761. MIN010

Transmission Case Gasket



Order No. 05 - 3245

Replaces Snapper 7018060. MIN010

Oil Seal for SNAPPER



Order No. 05 - 8632

Oil seal replaces Snapper 7011817. Rear axle oil seal for rear engine riders. ID 1-1/16", OD 1-13/16". MIN010

Insert Cup



Order No. 05 - 3244

Oil Fill and Check Plug. Replaces Snapper 7011024. MIN010

Order No. 05 - 8665

Oil seal replaces Snapper 7014662. Left rear wheel oil seal on 25", 26", 28", 30" & 33" cut rear engine riders. ID 11/16", OD 1-27/32". MIN010

Oil Seal Boot



Order No. 05 - 5951

Short Oil Seal Boot for Snapper Riders. Replaces Snapper 7017083, 7011011, 75115. Length 8-1/4".

Oil Seal Boot



Order No. 05 - 5952

Long Oil Seal Boot for Snapper Riders. Replaces Snapper 7017084, 7018555. Length 10-1/2".

Hydrostatic Pump for DIXIE CHOPPER

Left



Order No. 05 - 12093

Hydrostatic Pump replaces Dixie Chopper 65071. Also replaces Hydro-Gear BDP-10A-207 & 201 217.

Right



Order No. 05 - 12092

Hydrostatic Pump replaces Dixie Chopper 65070. Also replaces Hydro-Gear BDP-10A-313, 301, 302 & 308.



WHEELS



KENDA

CARLISLE

CST®

Quick-Glance

WHEELS	PG.
Wheels	
Steel	96-100
Plastic	101-107
Deck	103-107
Assemblies	108-115
Rims	116-117
Hubs	116-117
Valve Stems	117
Tires	
Pneumatic	118-119
Carlisle	120-122
 Tubes	
Tire Tubes	123-125
ATV	
Tires	126-127

06/08

Quick-Glance

WHEELS



Steel Wheels
(Diamond Tread)

1-3/8" Offset Hub



Steel Wheels
(Centered Hub)



Rib Tread With 1/2" bearings.

Order No. 06 - 274

6" x 1.50", Ball Bearing, 1/2" Bore. (painted white)

Order No. 06 - 276

7" x 1.50", Ball Bearing, 1/2" Bore. (painted white)

Order No. 06 - 278

8" x 1.75", Ball Bearing, 1/2" Bore. (painted white)

Load capacity, #274 = 50lbs, #276-277 = 55lbs, #278=60lbs.

Order No. 06 - 3459

6" x 1.50", 1-3/4" Hub. Repl. Echo 30241052630, model PE2400 trimmer/edger. (painted white)

Order No. 06 - 3460

7" x 1.50", 2" Hub. (painted white)

Order No. 06 - 3461

8" x 1.75", 2" Hub. (painted white)

Load capacity, #3459 = 55lbs, #3460-11492 = 60lbs.

Heavy Duty Wheels for
Rider Mowers



Order No. 06 - 287

8.25" x 2.75", Ball Bearing, 2-1/2" Offset Hub, 5/8" Bore, Diamond Tread. (painted white)

Order No. 06 - 288

8.25" x 2.75", Ball Bearing, 2-1/2" Offset Hub, 3/4" Bore, Diamond Tread. (painted white)



Order No. 06 - 273

5" x 1.25", Ball Bearing, 1/2" Bore, Rib Tread, 1-3/8" Hub. (painted white) 30lb load capacity

Order No. 06 - 275

6" x 1.75", Ball Bearing, 1/2" Bore, Rib Tread, 1-3/8" Hub. (painted white) 50lb load capacity

06/08

WHEELS



Heavy Duty Wheels for Rider Mowers (Cont.)



Order No. 06 - 279

8" x 1.75", Lug. Ball Bearing, 1/2" Bore, Lug Tread, 1-3/8" offset hub. (painted white)



Order No. 06 - 285

10" x 1.75", Tiller Wheel. Ball Bearing, 2" Center Hub Length, 1/2" Bore, Rib Tread. (painted white) 80 lbs cap.



Order No. 06 - 289

10" x 2.75", Ball Bearing, 2-1/2" Offset Hub, 5/8" Bore, Rib Tread. (painted white) 250 lb load capacity

Order No. 06 - 290

10" x 2.75", Ball Bearing, 2-1/2" Offset Hub 3/4" Bore, Rib Tread. (painted white) 250 lb load capacity

Steel Wheels for LAWN-BOY Commercial



Order No. 06 - 2976

8" Heavy Duty with zerk. Replaces Lawn-Boy 681980 & 678406. 8" x 1.75", 2" offset Hub, 1/2" Ball Bearing. (painted orange)

Order No. 06 - 2977

6" Heavy Duty with zerk. Replaces Lawn-Boy 681979 & 678513. 6" x 1.50", 2" offset Hub, 1/2" Ball Bearing. (painted orange)

Special Ball Bearing Wheel



Order No. 06 - 2989

8" x 1.75", 1-1/2" offset Hub, 1/2" Ball Bearing. For standard push and self-propelled mowers. Replaces Lawn-Boy 682972, 682974, 678637, 153800 and 678638. (painted white)



Order No. 06 - 2965

6" x 1.50", 1-1/2" offset Hub, 1/2" Oilite Bushing. Replaces Lawn-Boy 678636. (painted white)

Order No. 06 - 2980

8" x 1.75", 1-1/2" offset Hub, 1/2" Oilite Bushing. Replaces Lawn-Boy 682974 and 678637. (painted white)

Steel Wheel for JACOBSON



Order No. 06 - 7709

10.25 x 3.25, 3/4" bore and zerk fitting. Replaces Jacobson 122464. Fits 72" HR 15 Tractor Blitzer, Toro 72" Groundsmaster and 88" Tri-Flex Groundsmaster. (painted white) 3-1/4" centered

Order No. 06 - 2966

8" Self-Propelled Wheel, 1-1/2" offset Hub, 1/2" Oilite Bushing. Replaces Lawn-Boy 682972/678638 & 678637/682974. Soft Tire. (painted white)

Heavy Duty to Replace BOBCAT Steel Wheels



Order No. 06 - 2998

8" x 1.75" Heavy Duty Steel Wheel. 1/2" bearing, 2" offset hub length and zerk fitting. Replaces Ransomes/Bobcat 76167, 76096-01, Sensation 083-106. (painted red)

06/08

WHEELS

WHEELS



Order No. 06 - 2999

10" x 1.75" Heavy Duty Steel Wheel. 1/2" bearing, 2" offset hub length and zerk fitting. Replaces Ransomes/Bobcat 76168, 76096-2C, Lawnboy 153802, Sensation 083-107. (painted red)



Order No. 06 - 3239

6" x 2.00" Heavy Duty Solid Tire, Deckwheel. 5/8" roller bearing and zerk fitting. 2-1/4" centered hub length. Replaces Ransomes/Bobcat 38012N, Bunton PLO-642, Exmark 303201, Encore 323008, Kees 322008. Uses our **09-5848** Bearing Kit. (painted red)

06/08



Order No. 06 - 12484

10" x 1.75 x 1-1/2" hub length, steel wheel with rib tread. 1/2" bore, painted white. 80 lbs. load rating.

Steel Wheels for GRAVELY

(New style)



Order No. 06 - 5874

6" x 2.00" wheel assembly and zerk fitting. Replaces Gravelly 34426. New style for 40" and 50" decks. 1-3/4" offset hub, 3/4" ball bearing. (painted grey) Uses **09-327** bearing

WHEELS



Order No. 06 - 5915

Replaces Gravelly 11386. 6" x 2.00" wheel assembly and zerk fitting for 40" and 50" decks. 2-1/2" centered hub, 3/4" bushing. (painted grey)

Steel Wheel for POWER TRIM



Order No. 06 - 2997

7" x 1.50" edger wheel, 1-3/4" centered hub, 1/2" ball bearing. Replaces Power Trim 332. (painted orange)

Steel Wheels for McLANE



Order No. 06 - 2994

8" x 1.75", 1-3/4"- centered hub, 7/16" ball bearing 8" edger wheel. Replaces McLane 2016-8. Uses our **09-2703** bearing. (painted orange)

Order No. 06 - 2995

7" x 1.50", 1-3/4" centered hub, 7/16" ball bearing 7" edger wheel. Replaces McLane 2016-7. Uses our **09-2703** bearing. (painted orange)

Order No. 06 - 2996

6" x 1.50", 1-1/2" offset hub, 7/16" ball bearing 6" edger wheel. Replaces McLane 2016-6. (painted orange)

Self-Propelled Wheels for TORO/WHEEL HORSE



Order No. 06 - 2983

8" x 1.75", Self-propelled 42 teeth with **thin gear** (1/4") T-2 wheel. Replaces 11-1389, 11-1309, 26-2960, supersedes No. 26-2960. Rear bagger 1-3/8" offset hub, 1/2" ball bearing and zerk fitting. (painted white)

Order No. 06 - 2984

8" x 1.75", Self-propelled 42 teeth with **wide gear** (3/8") T-3 wheel. Replaces 38-2930. For side bagger. 1-5/8" offset hub, 1/2" ball bearing and zerk fitting. (painted white)

Order No. 06 - 2988

8" x 1.75", Self-propelled solid 42 teeth **wide gear** wheel. Replaces front drive wheels. 1-3/4" offset hub, 1/2" ball bearing and zerk fitting. (painted white)



Steel Wheel for SNAPPER

Order No. 06 - 9875

Steel wheel replaces Snapper 7035727, 7011802, 7011082. 8" x 1-3/4", ball bearing, 7/16" bore. Diamond tread (painted grey)



Steel Wheel Assembly for SNAPPER



Order No. 06 - 8962

10" x 1.75", 1-3/4" offset hub, double "D" diamond tread. Replaces Snapper 7044743. Fits self-propelled rear drive wheel on commercial models. (grey)

Steel Wheel for SNAPPER



Order No. 06 - 9612

Steel wheel replaces Snapper 7046678. 10 x 1.75, diamond tread. Fits 21" walkbehind mowers. 7/16" ball bearing, 1-5/8" offset hub. (painted grey)

Steel Wheels for SNAPPER



Order No. 06 - 271

8" x 1.75", 1-5/8" offset hub. Replaces Snapper 7011082. Has 7/16" bearing. Used as rear wheel on 21" models. (painted white)

Order No. 06 - 272

7" x 1.50", 1-5/8" offset hub. Replaces Snapper 7011083. Has 7/16" bearing. Used as front wheel on 21" models. (painted white)



Order No. 06 - 2985

7" x 1.75", 7/16" ball bearing, Replaces Snapper 7012347, 7011083, 7011083. 1-5/8" offset Hub. (front) (painted white)

Order No. 06 - 2986

9" x 1.75", 7/16" ball bearing, Replaces Snapper 7012603, 70146071, 7012603. 1-5/8" offset Hub. (rear) (painted white)

Solid Rubber



Order No. 06 - 286

9" x 1.95", 1-3/4" offset hub. 9/16" oblong center hole. Replaces Snapper 7012345. Fits self-propelled drive wheel on commercial models. (rear) (painted white)



Order No. 06 - 6709

9" x 2.00", 1-3/4" offset hub. 9/16" oblong center hole. Replaces Snapper 7019201/7019198. New "S" tread design tire. Fits self-propelled drive wheel on commercial models. (rear) (painted grey)

Steel Wheel for SNAPPER



Order No. 06 - 8262

8" x 1-5/8" offset hub, radial tread, 7/16" bearing. Replaces Snapper 7026182, Tru-Cut 52060. Fits 21" commercial CP model. Solid tire. (painted grey).

Steel Wheel for SNAPPER



Order No. 06 - 8263

9" x 1-5/8" offset hub, radial tread, 7/16" bearing. Replaces Snapper 7022800, Tru-Cut 52109. Fits 21" pushmower. (painted grey).

06/08

WHEELS



WHEELS

Steel Wheel for TORO



Order No. 06 - 13432

Steel wheel with gear replaces Toro 74-1720 & Exmark 100-2860. Fits rear commercial proline 21" mower model 22166, 22167, 22168. Exmark Metro 21" & Toro 21" Recycler. 3/8" bore, diamond tread, 8 x 2.00, 1-1/4" centered hub. Rear wheel (used with our front wheel **06-13403**)

Front Wheel Assembly for TORO



Order No. 06 - 13403

Front wheel assembly replaces Toro 100-2870. 8". Fits Toro commercial mowers (used with our rear wheel **06-13432**)

16" & 20" Steel Spoke Wheels



Order No. 06 - 13032

16" Steel spoke wheel. 2-3/4" Hub length, 1/2" x 1-3/8" ball bearings, Semi-pneumatic diamond tread tire.



Order No. 06 - 13033

20" Steel spoke wheel. 3-1/4" Hub length, 5/8" x 1-3/8" ball bearings, Semi-pneumatic diamond tread tire.

Order No. 06 - 3240

10.25" x 3.25" Wheel Assembly. Replaces MTD 734-0510, 5/8" center hole, 2-3/4" offset hub. (painted white) Load 50 lbs



Deck Wheel for TORO



Order No. 06 - 11956

Deck wheel replaces Toro 63-8400 & Cub Cadet 734-3195. 3/4" OCRB, centered white wheel 6-1/4" x 3.00, 3/4" bore, rib tread. Painted white.

Order No. 06 - 433

11" x 4" Front Wheel Assembly. Replaces MTD 734-0949, 5/8" plastic bushing, 2-5/8" offset hub. (painted white)



Deck Wheel for WHEEL HORSE



Order No. 06 - 5873

6" x 1.75" deck wheel, 1/2" grafoil bushing, 1-11/16" offset hub length. Replaces Wheel Horse 110506, Toro 5305 deck wheel. (painted red)

Steel Wheel for YAZOO



Order No. 06 - 6675

6" x 1.66" Replaces Yazoo 2302-023, 1/2" ball bearing, 1-3/8" offset hub. Fits 20", 22", 24" and 26" High Wheel Mowers. (painted yellow)

06/08

WHEELS



**Plastic Wheels
(Diamond Tread)**



Order No. 07 - 280

6" x 1.50", 1/2" C.H., 1-3/8" offset hub. Load 50 lbs

Order No. 07 - 281

7" x 1.50", 1/2" C.H., 1-3/8" offset hub. Load 55 lbs

Order No. 07 - 282

8" x 1.75", 1/2" C.H., 1-3/8" offset hub. Fits Toro 10-9680. Replaces AYP 103670X, MTD 54446 Load 60 lbs

**9" Plastic Wheel for
FLYMO**



Order No. 07 - 9676

9" Plastic wheel replaces Flymo 6823809. 9" wheel, 1-5/8" (41mm) hub, .475" (12.1mm) center hole. Black hub cover. Used with our inside white hub cover **07-9678**.

Order No. 07 - 9677

9" Plastic wheel replaces Flymo 6824900. 9" wheel, 1-5/8" (41mm) hub, .475" (12.1mm) center hole. Geared self propelled wheel. Black hub cover. Used with our inside white hub cover **07-9678**.

Order No. 07 - 9678

9" Plastic white hub cover replaces Flymo. Inside white hub cover for our **07-9676 & 07-9677**.

**Rear Wheel Assembly for
HONDA**



Order No. 07 - 13399

Rear wheel assembly replaces Honda 42700-VK6-020ZA / 42700-VK6-010ZA. Fits model HRC216. Uses our **08-13400** tire.



Order No. 07 - 283

8" x 1.75", 1/2" C.H., 1-3/8" offset hub, lug tread. Murray 20105, AYP 148436, Noma 56324.

**Plastic Wheel for
FLYMO**



Order No. 07 - 9671

7" Plastic wheel replaces Flymo 5138636-02. 7" wheel, 1-1/2" (38mm) hub, .475" (12.1mm) center hole. Geared self propelled wheel. Black hub cover. Used with our inside white hub cover **07-9672**.

Order No. 07 - 9672

7" Plastic white hub cover replaces Flymo 5127526-69. Inside white hub cover for our **07-9670 & 07-9671**.

Order No. 07 - 9673

8" Plastic wheel replaces Flymo 51275188. 8" wheel, 1-1/2" (38mm) hub, .475" (12.1mm) center hole. Black hub cover. Used with our inside white hub cover **07-9675**.

Order No. 07 - 9674

8" Plastic wheel replaces Flymo 5138640-02. 8" wheel, 1-1/2" (38mm) hub, .475" (12.1mm) center hole. Geared self propelled wheel. Black hub cover. Used with our inside white hub cover **07-9675**.

Order No. 07 - 9675

8" Plastic white hub cover replaces Flymo 5138644. Inside white hub cover for our **07-9673 & 07-9674**.

**Front Wheel Assembly for
HONDA**



Order No. 07 - 13398

Front wheel assembly replaces Honda 44700-VK6-010ZA. Fits model HRC216. Uses our **08-13400** tire.

06/08

WHEELS



WHEELS

Plastic Wheel for TORO



Order No. 07 - 13492

8" x 2.00", 1-3/4" hub length, 1/2" bore, radial tread, bushing, replaces Toro 105-1815. Front drive wheel, fits Toro self-propelled 22" recycler lawnmower models 20001, 20003, 20005, 20007, 20012, 20016, 20019, 20064, 20065, 20069, 20071, 20072, 20072A, 20086, 20087, 20094, 20110, 20111.

Plastic Wheel for TORO



Order No. 07 - 13491

12" x 2.00", 1-7/8" hub length, 1/2" bore, radial tread, ball bearings, replaces Toro 105-1816. Rear wheel, fits Toro self-propelled 22" recycler lawnmower models 20012, 20016, 20019.

Plastic Wheel for TORO



Order No. 07 - 14424

8" x 1-3/4" x 1/2" bore, plastic wheel replaces Toro 105-1814. Radial Tread tire.

Plastic Wheels for SNAPPER

(Diamond Tread)



Order No. 07 - 8928

7" x 1.50", 9/16" C.H., 1-5/8" hub. Replaces Snapper 7022795. Fits 21" walk behind mowers. (Gray) Load 55 lbs.

Order No. 07 - 8927

8" x 1.75", 9/16" C.H., 1-5/8" hub. Replaces Snapper 7022374. Fits 21" walk behind mowers. (Gray) Load 60 lbs.

Order No. 07 - 8929

9" x 1.75", 9/16" C.H., 1-5/8" hub. Replaces Snapper 7022796. Fits 21" walk behind mowers. (Gray) Load 60 lbs.

Order No. 07 - 8931

10" x 1.75", 9/16" C.H., 1-5/8" hub. Replaces Snapper 7035739. Fits 21" walk behind mowers. (Gray) Load 60 lbs.

Plastic Wheels for SNAPPER



Order No. 07 - 855

9" x 1.75", Snapper 7012579, 9/16" C.H. Rear wheels on steel and aluminum deck push mowers. 1-5/8" hub. (white) Load 60 lbs.

Order No. 07 - 2991

7" x 1.50", 9/16" center hole. Replaces Snapper 7018189. 1-5/8" hub. (front) (white) Load 55 lbs

Order No. 07 - 2992

8" x 1.75", 9/16" center hole. Replaces Snapper 7018190. 1-5/8" hub (rear). Also has 30 to 35 lbs. load rating. (white) Load 60 lbs.

Plastic Wheels for SNAPPER

(Diamond Tread)

Oblong CH 7/16" x 9/16"



Order No. 07 - 8930

9" x 1.75", spline drive bushing. Replaces Snapper 7022797. Fits 21" walk behind mowers. (Gray)

Order No. 07 - 8932

10" x 1.75", spline drive bushing. Replaces Snapper 7035740. Fits 21" walk behind mowers. (Gray)

Universal Plastic Wheel



Order No. 07 - 9156

16" x 1.75 Universal plastic gray spoke wheel. Replaces AYP 851801 & MTD 734-1842 & 734-1661. 2-1/2" centered hub, 1/2" bearings. 1/2" ID. (Gray)

Order No. 07 - 9078

Universal 14" x 1.75" wheel with 1/2" bearings. 2-1/2" centered hub, diamond tread. Uses our 09-324 bearing. (Gray)

Plastic Wheels for SNAPPER



Order No. 07 - 2990

9" x 1.75", 9/16" x 7/16", Oblong Hole. Replaces Snapper 7014604 and 7012496. For self-propelled. 1-3/4" Hub.

06/08

WHEELS



Plastic Wheel for AYP



Order No. 07 - 13495

12" x 1-3/4" hub length, radial tire, 6 spoke rim 1/2" sealed ball bearings, replaces AYP 431880X460 / 194387X460. Also replaces Husqvarna 433499X460. Gray Plastic.

Drive Wheel for AYP



Order No. 07 - 10758

Drive wheel replaces AYP 700953. 8" x 2" x 1/2" bore. lug gear tread, hub 1.60" offset. Fits self propelled mowers. 53 teeth.

Universal Plastic Wheels



Order No. 07 - 8988

Universal 20" plastic mag wheel without bearings. 1-3/8" OD bearing hub. Uses our **09-325**, **09-326**, **09-327** bearings. (Black) 2-1/4" Hub Pneumatic

Plastic Wheel for MURRAY



Order No. 07 - 11021

Plastic wheel replaces Murray 071133. Fits walkbehind mowers. Geared wheel drive for 20", 21" & 22" self propelled walk-behind mowers. 8" x 1-3/4" x 1/2" bore.

Plastic Wheels for YAZOO



Order No. 07 - 5900

16" Mag Wheel. Replaces Yazoo 2302-100. 13"OD

Order No. 07 - 5899

20" Mag Wheel. Replaces Yazoo 2302-099. 17"OD

Order No. 09 - 5901

Axle Kit for 16" & 20" Yazoo Mag Wheel.

Deck Wheel for AYP



Order No. 07 - 14035

5" x 1-7/8" x 1/2" bore, deck wheel replaces AYP 188606. Also replaces Husqvarna 532188606.

Deck Wheels



ID 5/8"
Width 2-3/4"
Height 5"

Order No. 07 - 6917

5" x 2-3/4" Deck Wheel. Replaces Bunton PL7540, Exmark 603299, Toro 68-2730, 1-603299, Lawnboy 68-2730 and Gilson 710138, Grasshopper 484230 and Yazoo 2302-127. 2-1/2" offset hub. Uses our **09-8586** bushing.

Deck Wheel for CUB CADET



Order No. 07 - 14446

5" x 2-5/8" x 5/8" plastic bushing, deck wheel replaces Cub Cadet / MTD 634-3159. 2-7/8" centered hub.

Deck Wheel for BOBCAT



ID 5/8"
Width 2-3/4"
Height 5"

Order No. 07 - 10715

Deck wheel replaces Bobcat 2721512 & Grasshopper 484230. 3-5/16" centered hub.



ID 5/8"
Width 2"
Height 6"

Order No. 07 - 6919

6" x 2" Deck Wheel. Replaces Ingersoll/Case C25682, Gilson 208736, Bolens 1737807 and Lawn-Boy 702804. 2-1/8" offset center hub.

06/08

WHEELS



WHEELS

Deck Wheel for CUB CADET



ID 1/2"
Width 2-3/8"
Height 5"

Order No. 07 - 12648

5" Deck wheel replaces Cub Cadet 734-04155. 5" x 2-5/8" ID, 1/2" offset hub. 2-1/2" length, smooth tread.

ID 5/8"
Width 3-1/4"
Height 5"



Order No. 07 - 12015

Deck wheel replaces Exmark 103-8415. Anti scalp roller. Fits Triton decks.

Wheel and Hardware Kit for EXMARK



ID 5/8"
Width 2-3/4"
Height 5"

Order No. 07 - 10301

Wheel and hardware kit replaces Exmark 103-3168. Contains our 07-6917 deck wheel and 10-10007 hardware kit.

Wheel and Hardware Kit for EXMARK



ID 5/8"
Width 3-1/4"
Height 5"

Order No. 07 - 12018

Wheel and hardware kit replaces Exmark 109-2098. Includes our 07-12015 wheel & 10-12016 hardware kit.

Deck Wheel for GRAVELY



ID 1/2"
Width 2-3/4"
Height 5"

Order No. 07 - 10714

Deck wheel replaces Gravely 92537. 3-5/16" centered hub.

Deck Roller for GRASSHOPPER



ID 5/8"
Width 2"

Order No. 07 - 13280

Deck roller replaces Grasshopper 426122. Fits 52", 61" & 72" decks.

Deck Roller for GRASSHOPPER



ID 5/8"
Width 6-1/8"

Order No. 07 - 13281

Deck roller replaces Grasshopper 603725.

Deck Roller for JOHN DEERE



ID 11/16"
Width 3"
OD 2-17/32"

Order No. 07 - 13279

Deck roller replaces John Deere M113955.

Deck Wheel for JOHN DEERE



ID 5/8" x 1.785"
Width 2"
Height 5"

Order No. 07 - 11819

Deck wheel replaces John Deere GX10168. Fits L100 & G100 series riders.



ID 1/2"
Width 1-3/8"
Height 6"

Order No. 07 - 6918

Deck Wheel. Replaces John Deere AM32639, Cub Cadet 734-3000, Noma 52204, Ingersoll/Case C25140 & C26737, Gilson 208919 and Lawn-Boy 705533. 1-1/2" centered hub.

06/08



WHEELS



ID 1/2"
Width 1-1/2"
Height 4"

Order No. 07 - 6914

4" x 1-1/2" Deck Wheel. Replaces John Deere M89339, Gilson 245946, Lawn-Boy 701756, Snapper 7026122 and Yazoo 2302-126. 1-1/2" offset hub.



ID 5/8"
Width 2"
Height 8"

Order No. 07 - 8216

Deck Wheel. Replaces John Deere AM107561. Used on 60" and 72" front cut and 50", 60" and 72" standard decks. 2-7/16" centered hub. Comes complete with roller bearing, 5/8" ID reducer bushing, spacers and zerk fitting.



ID 1/2"
Width 1-1/4"
Height 4"

Order No. 07 - 6913

Deck Wheel. Replaces John Deere M81716. 1-13/32" centered hub.



ID 1/2"
Width 1-3/8"
Height 5"

Order No. 07 - 6915

Deck Wheel. Replaces John Deere AM33718, Ingersoll/Case C25139 and C26736, Lawn-Boy 740280, Sears/Roper 105455X, Toro 61-9760, Bolens 1735583 and Gilson 210453, AYP 105455X, Husqvarna 5321054-55, Poulan 530-105455. 1-1/2" centered hub, steel bushing.



ID 5/8"
Width 3-7/8"
Height 3-13/16"

Order No. 07 - 8224

Deck Wheel. Replaces John Deere M115245. Used on all 48", 54" and 60" cut mid size walk behinds and tractors. 3-7/8" centered hub.

Wheel Kit for JOHN DEERE



ID 5/8"
Width 2"
Height 5"

Order No. 07 - 10250

Wheel kit replaces John Deere AM116299. Fits John Deere riders with 38" and 48" deck. Includes bushings and hardware.



ID 17/32"
Width 2"
Height 5"

Order No. 07 - 8214

Deck Wheel. Replaces John Deere AM104126. Used on 50", 60" and 72" front cut mowers. 2-7/16" centered hub. Comes complete with roller bearing, 17/32" ID reducer bushing, spacers and zerk fitting.



Width 2"
Height 5"

Order No. 07 - 10724

Deck wheel replaces John Deere M111489. Used in our 07-10250 wheel kit.



ID 9/16"
Width 1-1/2"
Height 6"

Order No. 07 - 8244

Deck Wheel. Replaces John Deere AM107560. Used on 48", 54", 60" and 72" mower decks. 1-7/8" centered hub. Comes complete with roller bearing, 9/16" ID reducer bushing, spacers and zerk fitting.



ID 5/8"
Width 2"
Height 6"

Order No. 07 - 8215

Deck Wheel. Replaces John Deere AM107558. Used on 60" and 72" front cut mowers. 2-7/16" centered hub. Comes complete with roller bearing, 5/8" ID reducer bushing, spacers and zerk fitting.

06/08

WHEELS

WHEELS



Deck Wheels (Cont.)



Order No. 07 - 14473

Plastic deck wheel replaces Kubota K5668-42100. Fits models ZD321, ZD326 with 60" & 72" decks.



ID 15/32"
Width 3-7/8"
Height 2-1/2"

Order No. 07 - 8299

Deck Wheel. Replaces Kubota 76505-46250. Used on 44", 48" and 54" decks, models G series, B1550, 1750 and 2350.



ID 15/32"
Width 3-13/16"
Height 3-3/4"

Order No. 07 - 8300

Deck Wheel. Replaces Kubota 76559-46250 & 76543-46250. Fits RC40G, G4200, G5200. 40", 44" & 48" decks.

Anti-Scalp Wheel from LAWN WHEEL



ID 3/8"
Width 2-3/4"
Height 5"

Order No. 07 - 12727

Black polypropylene anti-scalp wheel with hardware. Made of an extra strong polymer and a sealed bearing system making it the only wheel of its kind. 2-5/8" off set hub length.



ID 1/2"
Width 2-3/4"
Height 5"

Order No. 07 - 6916

Deck Wheel. Replaces Murray 92683, 092265, MTD & Cub Cadet 734-3058B, JD AM116299, M84690, Simplicity 17001840, Snapper 7029264, Hustler 031997, Toro 112-0677 Excel 031997, Ariens 34717, AYP 133957. 2-1/2" offset hub.



ID 13/32"
Width 1-1/2"
Height 3"

Order No. 07 - 8311

Deck wheel. Replaces Murray 23257.



ID 11/16"
Width 4-3/16"
Height 2-1/2"

Order No. 07 - 8310

Deck wheel. Replaces Murray 23203.



ID 1/2"
Width 2"
Height 5"

Order No. 07 - 10087

Deck wheel replaces Murray 92683. Fits units after the year 2000.



ID 5/8"
Width 1-3/8"
Height 5-3/4"

Order No. 07 - 8297

Deck wheel. Replaces MTD 734-0974, 1-3/8" offset hub.



ID 1/2"
Width 1-3/8"
Height 4-3/4"

Order No. 07 - 430

Deck Wheel. Replaces MTD 734-0973, Toro 112-0037, 1-1/2" offset hub.



ID 17/32"
Width 1-3/8"
Height 5-3/4"

Order No. 07 - 3320

Deck Wheel. Replaces Noma - (AMF/Dynamark) 302611, 52584, 52204, John Deere 32639, Cub Cadet 734-3000, Lawnboy 705533, 1-3/8" offset hub.

06/08

WHEELS



WHEELS

Deck Wheels (Cont.)



ID 1/2"
Width 1-11/16"
Height 5-3/4"

Order No. 07 - 8298

Deck wheel. Replaces Noma 302611, 39831, 52584. 1-3/8" offset hub.



ID 7/16"
Width 1-3/4"
Height 3"

Order No. 07 - 6909

Deck Wheel. Replaces Sear/Roper 109729X. 1-7/8" centered hub.

Deck Wheel for SCAG



ID 11/16"
Width 3-5/16"
Height 3"

Order No. 07 - 12245

Anti scalp deck wheel replaces Scag 482295. Fits Turf Tiger.



ID 3/8"
Width 3"
Height 4-1/2"

Order No. 07 - 10225

Anti-Scalp wheel replaces Scag 481632. Fits most Scag units including Turf Tiger. Includes bushings.

Deck Wheel for SNAPPER



ID 5/8"
Width 2-15/16"
Height 2-27/32"

Order No. 07 - 9559

Deck wheel replaces Snapper 7019190.

Deck Wheel for SIMPLICITY



ID 1/2"
Width 2"
OD 3-7/8"

Order No. 07 - 12060

Deck wheel replaces Simplicity 1714760. Fits 1998 and later Regent 38" & 44" decks.



Length 4"
C.H. 5/8"
Height 2-1/2"

Order No. 07 - 12999

Deck wheel replaces Simplicity 1668513. Fits 700 series, 3100, 4200, 5116, 5200, 5216, 6500, FC, FCH, GTH, LT, 5200, 6200, 6500, FCH and GTH 36", 42", 44" and 48" cut decks.



Length 1-11/16"
C.H. 5/8"
Height 3-1/2"

Order No. 07 - 13000

Deck wheel replaces Simplicity 1668487. Fits heavy duty 3100, 4211, 4212, 4108, 5200, LTG12 decks.

Deck Wheel for STIGA



ID 5/8" (15.87 mm)
OD 3-7/8" (98.43 mm)
Height 2" (50.80 mm)

Order No. 07 - 50222

Deck wheel. Fits Stiga Park and Stiga Villa.

Guard Roller for STIGA



Top ID 11/16" (16.50 mm)
Bottom ID 2-9/16" (65.15 mm)
Top OD 2-1/2" (63.50 mm)
Bottom OD 2-3/4" (69.85 mm)
Length 4-1/2" (114.3 mm)

Order No. 07 - 50221

Guard roller. Fits Stiga Park and Stiga Villa.

Order No. 07 - 8201

Deck wheel. Replaces Wheel Horse 108798, 94-1599. Used on 36", 42" and 48" decks. Deck models 300, 400 and 500 series. 3-1/2" centered hub.



ID 1/2"
Width 3-1/4"
Height 2-15/16"

06/08

WHEELS

WHEELS



Tire Dimensions & Sizes

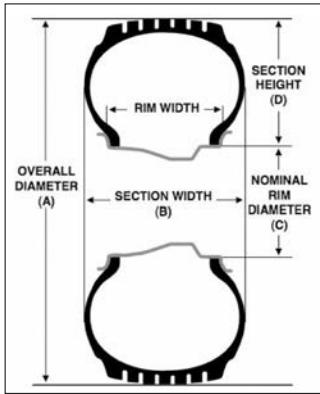

Size	Typical Use
(A) (B) (C) 16 x 6.50 - 8	Lawnmowers
(B) (D) (C) 4.10/3.50 - 4	Industrial; Go Karts
(A) (B) 20 x 2.125	High Wheel Mowers Bicycles

06/08

WHEELS

Caster Wheel for BOBCAT



Order No. 08 - 8098

9 x 350 x 4 smooth tread 4 ply tubeless tire, 3 piece rim, 4" centered hub with 5/8" open cage roller bearing and zerk fitting. Replaces Bobcat 38510, 483800, 603925, 903927, 603971, Scag 48307, 48006-1. Uses our 09-5812 bearing kit. (painted red)

Caster Wheel for BUNTON



Order No. 08 - 8196

410 x 350 x 5, 2 ply sawtooth tubeless tire. 2-15/16" centered hub, with 3/4" ID bearing and zerk fitting. Replaces Bunton PAL0942A, JD PT8639. Used on 36", 48", 52" and 61" Mulch and Turf decks. (painted yellow)

Caster Wheel for EXMARK



Order No. 08 - 9803

Caster wheel without bearings replaces Exmark 1-633582. 13 x 500 x 6, 4 ply smooth tread tubeless tire, 1 piece rim, 5-5/8" centered hub, with zerk fitting. (painted white). Fits Exmark Lazer Z. Uses our 09-813 bearings.

Caster Wheel for EXMARK



Order No. 08 - 9804

Caster wheel with bearings replaces Exmark 1-634662. 13 x 500 x 6, 4 ply smooth tread tubeless tire, 1 piece rim, 5-5/8" centered hub, with 3/4" bearings with zerk fitting. (painted white). Fits Exmark Lazer Z. Includes our 09-813 bearings. 440 lbs load.

Caster Wheel for GRASSHOPPER



Order No. 08 - 8552

Caster wheel replaces Grasshopper 603924, 483800, 603925, 903927, 603971, Scag 48006-1. 9 x 350 x 4, 4 ply smooth tread tubeless tire, 1 piece rim, 3-1/2" centered hub, with 5/8" semi-sealed bearing and zerk fitting. Fits 44", 52", 61" & 72" cut. Models 2144, 6144, 6152, 6161. (painted tan)

Caster Wheel for GRASSHOPPER



Order No. 08 - 8553

Caster wheel replaces Grasshopper 483861. 13 x 500 x 6, 4 ply rib tread tubeless tire, 3-3/4" centered hub, 1 piece rim with bead lock, semi sealed ball bearing and zerk fitting. Fits 44", 52", 61" & 72" cut models. Rear wheel on "ZERO TURN" mowers. (painted tan) 5/8" x 1-3/8"

Heavy Duty Solid Foam Tire/Flat Free

Order No. 08 - 8264

9 x 350 x 4 Solid foam tire is maintenance free, flat free, long lasting resists cracking, oil and chemical resistant. Constructed of micro-cellular polyurethane insures that it will never lose its form. Uses our 08-8376 rim.





WHEELS

Solid Foam Wheel Assembly for VELKE



Order No. 08 - 10816

Solid foam wheel assembly replaces Velke vkwheel. 9 x 350 x 4. 2-1/4" off set hub, 3 pce rim, with 1" roller cage bearings with zerk fitting. Fits 2 wheel Velke's.

Caster Wheel Assemblies for



Solid Foam Tire

- 9 x 350 x 4
- Smooth Tread
- Solid Foam Tire
- 3 Piece Rim
- use our 08-8264
- Flat Free

BOBCAT

Order No. 08 - 8581

4" centered hub with 5/8" open cage roller bearing and zerk fitting. Fits 32", 36", 48", 54" & 61" cut midsize walk behind mowers. (painted red)

GRAVELY

Order No. 08 - 8494

3-1/4" centered hub with 3/4" open cage roller bearing and zerk fitting. Fits standard Promaster 50" & 60" decks. (painted white) Uses our 08-8376 rim only

GRASSHOPPER

Order No. 08 - 8577

3-1/2" centered hub with 5/8" semi-sealed bearing and zerk fitting. Fits 44", 52", 61" & 72" cut, models 2144, 6144, 6152 & 6161. (painted tan)

JOHN DEERE

Order No. 08 - 8579

4" centered hub with 3/4" open cage roller bearing and zerk fitting. For 7001 series riders 48", 54" cut. Also fits mid-size walk behind mowers with 38", 48", 54" cut. Models F500, F700, FS510, FS525, F710, F725. Uses our 09-8668 Bearing Kit. (painted yellow)

SCAG

Order No. 08 - 8580

4" centered hub with 5/8" open cage roller bearing and zerk fitting. Fits 32", 36", 48", 52", 61" & 72" cut midsize walk behind mowers. (painted orange)

Wheel Assemblies for VELKE

- 3 Piece Rim
- Solid Foam Tire
- Flat Free



Order No. 08 - 8867

3-1/2" centered hub with 3/4" open cage roller bearing with zerk fitting. Fits all one wheel Velke's. Uses our 08-8865 tire & 09-8670 wheel bearing kit. (painted white)

Order No. 08 - 8865

9 x 350 x 4 Solid foam traction tread tire is maintenance free, flat free, long lasting resists cracking, oil and chemical resistant. Constructed of micro-cellular polyurethane insures that it will never lose its form. Used with our 08-8867 wheel assembly. **Tire only**

Wheel Assembly for TORO

- 3 Piece Rim
- Solid Foam Tire
- Flat Free



Order No. 08 - 8866

3-1/4" centered hub with 3/4" open cage roller bearing with zerk fitting. Fits Toro midsize units. Uses our 08-8864 tire & 09-8439 wheel bearing kit. (painted white) **Load 440.**

Order No. 08 - 8864

8 x 300 x 4 Solid foam tire is maintenance free, flat free, long lasting resists cracking, oil and chemical resistant. Constructed of micro-cellular polyurethane insures that it will never lose its form. Used with our 08-8866 wheel assembly. **Tire only.**

Puncture Proof Tire Wheel Assemblies

- 1 Piece Rim
- Flat Proof
- Smooth Tread
- 9 x 350 x 4
- Extraordinary Rubber Composition



Order No. 08 - 9899

4" centered hub with 3/4" open cage roller bearing and zerk fitting. Fits 32", 36", 48", 54" & 61" cut midsize walk behind mowers. Uses our 09-8668 bearing kit. (painted white)

Order No. 08 - 9898

4-1/2" centered hub with 3/4" open cage roller bearing and zerk fitting. Replaces Exmark 1031224. Uses our 09-8408 bearing kit. (painted white)

Order No. 08 - 9947

4" centered hub with 5/8" open cage roller bearing and zerk fitting. Replaces Snapper 7059065. Fits 32", 36", 48", 54" & 61" cut midsize walk behind mowers. Uses our 09-5812 bearing kit. (painted white)

06/08

WHEELS



WHEELS

Reliance Wheel Assemblies from CARLISLE



- 1 Piece Rim
- Flat Proof
- Semi Pneumatic

Order No. 08 - 10286

13 x 650-6 Reliance tire mounted on a 6 x 4.50" steel wheel. 7.25" centered hub with 3/4" cups pressed in for tapered roller bearings. Replaces Exmark 103-0065, Toro 633971 & Scag 482504. (Painted White) Uses our **09-813** bearing or our **09-9944** bearing kit. **No bearings Included.**

Order No. 08 - 10288

13 x 500-6 Reliance tire mounted on a 6 x 3.25" steel wheel. 5.625" centered hub with 3/4" cups pressed in for tapered roller bearings. Replaces Exmark 103-0064, Toro 633582 & Scag 482503, Wright 72460004, Ferris 22631S. (Painted White) Uses our **09-813** bearing or our **09-9944** bearing kit. **No Bearings Included.**

Order No. 08 - 10742

Wheel assembly replaces Toro 104-1170 & John Deere AM101589. 11x400-5 Reliance rib tread tire. 5" centered hub length, **3/4" roller bearings**. Includes grease zerk. Also fits Ariens 01588100, Dixon 1780. Painted white.

Order No. 08 - 11217

9 x 350 -4 Reliance smooth tread wheel assembly. Mounted on a flat base 4" x2.25" steel wheel painted white with 3.25" centered hub length and **3/4" roller bearings**. Replaces Gravely 52586 / 45205, Ariens 71301.

Order No. 08 - 11522

9 x350-4 Reliance tire mounted on 4 x 2.25" steel wheel painted white. 3.25" centered hub and **5/8" roller bearings**. Smooth tread tire. Replaces Grasshopper 483800, 603925, 603927 & 603971, Scag 48006-1.

Reliance Caster Wheel Assembly for DIXIE CHOPPER



Order No. 08 - 10915

Reliance Caster wheel assembly replaces Dixie Chopper 400130. 13 x 650 x 6, Painted silver. Uses our **09-9719** bearing kit. **No Bearings Included**

Order No. 08 - 11062

13 x 500 -6 Reliance smooth tread wheel assembly. Mounted on a 6" x 3.25" steel wheel painted silver with 3.75" centered hub length. Replaces Dixie Chopper 10202. **No Bearings Included.**

Order No. 08 - 11063

8 x 300 -4 Reliance rib tread wheel assembly. Mounted on a 4" x 2.25" steel wheel painted white with 3.5" centered hub length, and **5/8" roller bearings**. Replaces Swisher #4218, Walker 4815-4.

Wheel Assembly for BILLY GOAT



Order No. 08 - 14346

4.10/3.50 - 4, 2.25" Offset, 3/4" Semi-Precision ball bearings, Sawtooth tread tire, 10" wheel assembly. Replaces Billy Goat 440279. Fits walkbehind blowers. Solid foam semi-pneumatic, sawtooth tread Carefree tire. Gray Wheel.

Solid Wheel Assembly for EXMARK



Order No. 08 - 9809

Solid wheel assembly with bearings replaces Exmark 1-634662. 13 x 500 x 6, solid wheel, 1 piece rim, 5-5/8" centered hub, 3/4" bearings with zerk fitting. (painted white). Fits Exmark Lazer Z & Toro Master. **Includes our 09-813 bearings.**

Solid Wheel Assembly for DIXIE CHOPPER



Order No. 08 - 9501

Solid wheel assembly replaces Dixie Chopper 10202, Encore 363311. 13 x 500 x 6 rib tread solid wheel assembly. Fits units with 42", 50", 60" & 72" decks. Uses our **09-9719** bearing kit. **No Bearings Included.**

Wheel Assembly for DIXIE CHOPPER



Order No. 08 - 10789

Wheel assembly replaces Dixie Chopper 400053. 15 x 600 x 6, 4 ply tubeless rib tread tire, 3-1/2" centered hub, 1 pce rim with zerk fitting. (Silver). Uses our **09-9719** wheel bearing kit. **No Bearings Included.**

Reliance Caster Wheel Assembly for DIXIE CHOPPER



Order No. 08 - 11061

15 x 600 x 6, Reliance tire mounted on a 6" x 4.5" steel wheel painted silver with 3-3/4" centered hub length. Replaces Dixie Chopper 400053 / 400129. **No Bearings Included.**

06/08

WHEELS



Caster Wheel for EXMARK



Order No. 08 - 10075

Caster wheel with bearings replaces Exmark 1-644251. 13 x 650 x 6, 4 ply smooth tread tubeless tire, 1 piece rim, 7" centered hub, **3/4" bearings** with zerk fitting. Fits Lazer Z 52", 60" & 72" models. Uses **09-9944** Bearing kit. (painted white)

Caster Wheel for GRAVELY



Order No. 08 - 8197

9 x 350 x 4 smooth tread 4 ply tire with tube, 3 piece rim, 3-1/4" centered hub **with 3/4" open cage roller bearing** and zerk fitting. Replaces Gravelly 52586, 45205, fits standard Promaster 50 and 60 decks, Ariens 7130100. (painted white). Uses our 09-8439 bearing kit, **08-8376** rim.

Tire Skin for HONDA



Order No. 08 - 13400

Tire skin 9" **new style** replaces Honda 42751-VK6-010. Front and rear tire only fits models HRC216K2. Fits our **07-13399 & 07-13398** tire.



Order No. 08 - 13401

Tire skin 9" **old style** replaces Honda 42861-VB5-J00. Front and rear tire only fits models HRC216.

Caster Wheel for JOHN DEERE



Order No. 08 - 8550

Caster wheel replaces John Deere AM115510, Exmark 103-1224, Ariens 1588100. 9 x 350 x 4, 4 ply smooth tread tubeless tire, 1 piece rim, **3/4" open cage roller bearing** and zerk fitting. For 700 series riders with 48", 54" cut models. Also fits midsize walk behind mowers with 38", 48", 54" cut. Models F500, F700, FS510, FS525, F710, F725. 4" hub length. Uses our **09-8706** spanner bushing, **09-8668** bearings. (painted yellow)

Caster Wheel for JOHN DEERE



Order No. 08 - 8551

Caster wheel replaces John Deere AM101589 & Dixon 17080. 11 x 400 x 5, 2 ply smooth tread tubeless tire, 1 piece rim, 5" centered hub, **3/4" open cage roller bearing** and zerk fitting. For 900 series riders with front cut 50", 60", 72" cut. Uses our **09-8707** spanner bushing. (painted yellow)

Reliance Wheel Assembly for JOHN DEERE



Order No. 08 - 10461

11 x 400 x 5, Reliance wheel assembly replaces John Deere AM101589. Mounted on a 5 x 3.25 steel wheel with 5" centered hub length, **3/4" angular contact heavy duty ball bearings**. Fits 90 series riders with front cut 50", 60" & 72" decks. Also replaces Ariens 1588100, Dixon 17080. (White)

Wheel Assembly for LITTLE WONDER



Order No. 08 - 14302

4.10/3.50 - 4, 3.25" Centered, 5/8" Semi-Precision ball bearings, Sawtooth tread tire, 10" wheel assembly. Replaces Little Wonder 4164205. Fits walkbehind blowers. Solid foam semi-pneumatic, sawtooth tread Carefree tire. Gray Wheel.

06/08

WHEELS



WHEELS

Caster Wheel for SCAG



Order No. 08 - 9605

Caster wheel replaces Scag 481551. 13 x 500 x 6, 4 ply smooth tread tubeless tire, 1 piece rim, **5/8" open cage roller bearing** and zerk fitting. Uses our **08-8949** tire, **09-11720** bearings & our **09-9613** spanner bushing. (painted gold) Hub length 5-7/8"

Caster Wheel For Scag



Order No. 08 - 3276

9 x 350 x 4 smooth tread 4-ply tubeless tire. 4" centered 3-piece rim, zerk fitting and a **5/8" open cage roller bearing**. Scag 48006-01, 48307, Grasshopper 483800 & 603925, 603927, 603971, Bobcat 38264, 38510. Uses our **09-5812** and **09-7780** bearing kit. (painted orange)

06/08

Caster Wheel Assembly for SCAG

Order No. 08 - 10711

13 x 650 x 6, 4 ply smooth tread, tubeless tire, 1piece rim, Caster wheel assembly replaces Scag 482504. 7-1/4" centered hub **with 3/4" cups pressed in for tapered roller bearings** and zerk fittings. Uses our **09-813** bearing or our **09-9944** bearing kit. Fits Turf Tiger units. (Gold). With bearings.



Caster Wheel for VELKE



Order No. 08 - 8575

Caster wheel for Velke VKWHEEL. 9 x 350 x 4, 4 ply traction tread tire with tube, 3-1/2" centered hub, 3 piece rim, **3/4" open cage roller bearing** and zerk fitting. Fits all one wheel Velke's. Uses our replacement tire **08-8636**. With spanner bushing. (painted white)

Caster Wheel for VELKE



Order No. 08 - 9260

Caster wheel for Velke replaces VKXwheel. 9 x 350 x 4, 4 ply traction tread tire with tube. 2-1/4" off centered hub, 3 piece rim, **1" roller cage bearing** with zerk fitting. Fits all two wheel Velke's.

Drive Wheel Assembly



Order No. 08 - 905

13 x 650 x 6 Drive Wheel Assembly. 6-1/2" offset hub length, **7/8" roller bearing**, 4 ply tubeless. Replaces Ransomes/Bobcat 38096C, 36479, Bunton PAL 1075A, Snapper/Kees 7076409, Exmark 1-304173, 1-302016.

Wheel Assembly for DIXIE CHOPPER



Order No. 08 - 9763

Wheel assembly replaces Dixie Chopper 10202. 13 x 500 x 6, 4 ply tubeless rib tread tire, 3-1/2" centered hub, 1 pce rim with zerk fitting. Fits units with 42", 50", 60" & 72" decks. (Silver). Uses our **09-9719** wheel bearing kit. **No Bearings Included.**



**Wheel Assembly for
DIXIE CHOPPER**



Order No. 08 - 9573

Wheel assembly replaces Dixie Chopper 97166, 10202. 13 x 650 x 6, 4 ply rib tread tubeless tire, 3-3/4" centered hub, 1 pce rim. Fits Dixie Chopper "ZERO TURN" commercial mowers 1999 - later. (Silver). Uses our **09-9606** spanner bushing. **No Bearings Included.**

**Wheel Assembly for
ENCORE**



Order No. 08 - 8574

Wheel assembly replaces Encore 3633114. 10 x 350 x 4, 4 ply slick tread tire with tube, 3-1/4" offset hub, 3 piece rim, **3/4" open cage roller bearing** and zerk fitting. Fits 36", 48" & 60" cut models. (painted white)

06/08

**Wheel Assembly for
SCAG**



Order No. 08 - 8573

Wheel Assembly replaces Scag 48192. 13 x 650 x 6, 2 ply traction tread tubeless tire, 1 piece rim, 8-1/2" off set hub, **1" bearing**. Includes 8" pulleys & 6" brake drum. Fits 36", 48", 52", 61" & 72" cut midsize mowers with double belt drive. (painted gold)

WHEELS

**Wheel Assembly for
SCAG**



Order No. 08 - 10016

Wheel assembly replaces Scag 48537. 410 x 350 x 5, Sawtooth tread 4-ply tubeless tire. 4" centered, 1- piece rim, zerk fitting and a **5/8" open cage roller bearing**. (painted orange)

**Wheel Assembly for
SNAPPER**



Order No. 08 - 9151

Wheel assembly replaces Snapper 7052270/7050713. 16 x 650 x 8, 2 ply tubeless turf saver tread tire, one piece rim. Fits rear engine rider. 3 hole bolt pattern. (White) **No Bearings Included.**

**Wheel Assembly for
SNAPPER**



Order No. 08 - 9155

Wheel assembly replaces Snapper 7050294. 16 x 650 x 8, 2 ply tubeless turf saver tread tire, one piece rim. Fits rear engine rider. 4 hole bolt pattern. (White) **No Bearings Included.**



WHEELS

Wheel Assembly for SNAPPER



Order No. 08 - 8278

410 x 4, 2 ply stud tread tubeless tire, 3-1/4" offset hub with zerk fitting and 3/4" bearings. Replaces Snapper 7052268, 7052267, 7050618 and 7051449. One pc. rim. (painted white)

Front Wheel Assemblies for SNAPPER



Order No. 08 - 10106

11 x 400 x 4, 4 ply front wheel assembly. Replaces Snapper 7058943 & 7053304. One piece rim with 3/4" bearing, zerk fitting, tubeless turf tire. Fits rear engine riders. (Grey)

Wheel Assembly for SNAPPER



(1 piece rim)

Order No. 08 - 7285

410 x 350 x 4 Wheel Assembly. Replaces Snapper 7052267 and 7052305/7050618. One piece rim, zerk fitting, tubeless turf tread. For series 7 and up. Replacement tire **08-7328**. (painted gray). **Bearing Included.** 3-1/4" hub length. 10-1/2" Height.

Wheel Assembly for SNAPPER



Order No. 08 - 10892

Wheel assembly replaces Snapper 7052267. 410 x 4. One piece rim, zerk fitting, tubeless turf tread tire from Carlisle. Painted Gray. **Bearing Included.** 11" height.

Wheel Assembly for TORO



Order No. 08 - 12913

Wheel assembly replaces TORO 104-1170 & John Deere AM101589. 11x400-5, 4 ply tube type smooth tread tire. 5" centered hub length, 3/4" roller bearings. Includes grease zerk. Painted white, 1 piece rim.

Rear Wheel Assemblies for SNAPPER



Order No. 08 - 10112

Rear wheel assembly replaces Snapper 7058520. 20 x 1000 x 8, 4 ply tubeless turf tread tire, one piece rim. Fits front engine rider. 3/4" Keyway. (Grey) **No Bearing Included.**

Order No. 08 - 10111

Rear wheel assembly replaces Snapper 7058519. 18 x 950 x 8, 4 ply tubeless turf tread tire, one piece rim. Fits front engine rider. 3/4" Keyway. (Grey) **No Bearing Included.**

Order No. 08 - 10110

Rear wheel assembly replaces Snapper 7058518. 18 x 850 x 8, 4 ply tubeless turf tread tire, one piece rim. Fits front engine rider. 3/4" Keyway. (Grey) **No Bearing Included.**

Order No. 08 - 10107

Rear wheel assembly replaces Snapper 7058951. 16 x 650 x 8, 4 ply tubeless turf tread tire, one piece rim. Fits front engine rider. 3 hole bolt pattern. (Grey) **No Bearing Included.**

Order No. 08 - 10115

Rear wheel assembly replaces Snapper 7052270. 16 x 650 x 8, 4 ply tubeless turf tread tire, one piece rim. Fits rear engine rider. 3 hole bolt pattern. (Grey) **No Bearing Included.**

Order No. 08 - 10114

Rear wheel assembly replaces Snapper 7052671 / 7058951. 16 x 750 x 8, 2 ply tubeless turf tread tire, one piece rim. Fits rear engine rider. 3 hole bolt pattern. (Grey) **No Bearing Included.**

Wheel Assembly for TORO



Order No. 08 - 8684

Caster wheel assembly replaces Toro 68-8970. 8 x 300 x 4, 4 ply tube type turf tread tire, 3 piece rim, 3-1/4" centered hub with 3/4" open cage roller bearing and zerk fitting. Fits all Toro midsize units. (painted white). Uses our **08-8582** tire & our **08-8195** tube. Uses our bearing **09-8439**.

Tire Skin for Toro



Order No. 08 - 13402

Tire skin 8" new style replaces Toro 53-7740. Front and rear tire only for commercial mowers.

06/08

WHEELS



Wheel Assembly



Order No. 08 - 3277

280/250 x 4, 4 Ply Saw Tooth Tire and Tube mounted on a 3-1/4" centered 3 piece rim, **with 1" open cage roller bearing**. Replaces Bobcat 38209, Toro 54-8820, 12-1519 and Gravelly 37797. (painted red)

Wheel Assembly for WALKER



Order No. 08 - 10162

8 x 300 x 4, solid foam tire, 3-1/2" centered hub, zerk fitting **with 5/8" open cage roller bearing**. Replaces Walker 5715-3. Uses our **08-8864** solid foam tire. (painted white)

Order No. 08 - 8864

8 x 300 x 4, Solid foam tire is maintenance free, flat free, long lasting resists cracking, oil and chemical resistant. Used with our **08-10162** wheel assembly. Replaces Walker 5715-11. **Tire only.**

Wheelbarrow Tire & Wheel Assemblies



Order No. 08 - 871

6" centered hub, **5/8" x 1-3/8" bearing**. 400 x 6 Pneumatic tire. Uses our **09-326** bearing.

Order No. 08 - 872

6" centered hub, **5/8" x 1-3/8" bearing**. 480 x 400 x 8 Pneumatic tire. Uses our **09-326** bearing.

Caster Wheel Assembly for TORO



Order No. 08 - 13337

Front wheel and tire assembly replaces Toro 105-3471. 4.10/3.50-4 Sawtooth tread tubeless tire, 3/4" ID x 4-1/4" hub length with zerk fitting. Fits Time Cutter Z.



Order No. 08 - 13421

Front wheel and tire assembly replaces Toro 110-6785. 4.10/3.50-4 smooth tread tubeless tire, 3/4" ID x 4-1/4" hub length with zerk fitting. Fits Time Cutter Z.



Order No. 08 - 13422

Front wheel and tire assembly replaces Toro 117-7386. 4.10/3.50-4 ribbed tread tubeless tire, 3/4" ID x 4-1/4" hub length with zerk fitting. Fits Time Cutter Z, models 74360, 65, 66, 80, 81 & 74398, 42" & 50" units.

Wheel Assembly for WALKER



Order No. 08 - 7982

8 x 300 x 4, 4 ply smooth tread tire and tube, 3-1/2" centered hub, zerk fitting **with 5/8" open cage roller bearing**. (our **09-8319**). Replaces Walker 5715-4, front wheel on "ZERO TURN". (painted white). Replacement tire (solid 08-10092, Pneumatic 08-8194)

Wheelbarrow Tire & Wheel Assembly



Order No. 08 - 8945

6" centered hub, **5/8" bearing**. 480 x 400 x 8, 2 ply tubeless stud tread steel wheel with straight zerk fitting.

06/08
WHEELS

WHEELS



Demountable Wheel Assemblies

2" Center to Center



Order No. 08 - 371

4" Front wheel & hub assemblies, uses **09-8199** bearings.

Order No. 08 - 372

5" Front wheel & hub assemblies, uses **09-8199** bearings.

Order No. 08 - 373

6" Front wheel & hub assemblies, uses **09-8199** bearings.

Universal Wheels



Order No. 08 - 8983

4" diameter x 2-1/2" rim width x 2-1/8" centered hub length. 2 piece wheel without bearings. Uses our **09-325**, **09-326**, **09-327** bearings. (white)

Order No. 08 - 8981

5" diameter x 2-3/4" rim width x 2-1/4" centered hub length. 2 piece wheel without bearings. Uses our **09-325**, **09-326**, **09-327** bearings. (white)

Order No. 08 - 8982

6" diameter x 3-1/4" rim width x 2-5/8" centered hub length. 2 piece wheel without bearings. Uses our **09-325**, **09-326**, **09-327** bearings. (white) 6 bolt pattern

Wheel and Hub Assembly for GRAVELY



Order No. 08 - 8376

9 x 350 x 4 wheel and hub assembly for Gravelly. Used in our **08-8197** and our **08-8494** wheel assemblies. (painted white)

Demountable Wheel Assemblies

2" Center to Center
2" ID



Order No. 08 - 377

4" Rim-Pair.

Order No. 08 - 378

5" Rim-Pair.

Order No. 08 - 379

6" Rim-Pair.



Order No. 08 - 374

4" Rear wheel & hub assemblies, uses **09-8199** bearings.

Order No. 08 - 375

5" Rear wheel & hub assemblies, uses **09-8199** bearings.

Order No. 08 - 376

6" Rear wheel & hub assemblies, uses **09-8199** bearings.

Universal Wheels



Order No. 08 - 8377

4" diameter x 2-3/4" rim width x 2" hub length (1 pc.) Universal Wheel with a 2" offset hub. Fits 1-3/8" bearing. (painted white)

Order No. 08 - 8379

6" diameter x 4-1/2" rim width x 2-3/4" hub length (1 pc.) Universal Wheel with a 2-3/4" centered hub. Fits 1-3/8" bearing. (painted silver)

Rim for DIXIE CHOPPER



Order No. 08 - 10700

1 piece rim replaces Dixie Chopper 10239. 6" diameter, 3-1/4" rim width, 3-1/2" hub length. Fits 13x500-6 & 13x650-6 tires. Fits 1-3/8" bearings, Uses our 09-9719 bearing kit.

06/08

WHEELS



WHEELS

Front Hub Assembly

2-3/4" Over all Length
ID 1-3/8"



Order No. 08 - 10082

Front hub assembly without bearings. (offset). Used on go-carts, mini bikes and other applications.

Rear Hub Assembly

2-3/4" Over all Length
ID 1-3/8"



Order No. 08 - 10083

Rear hub assembly without bearings. (centered). Used on go-carts, mini bikes and other applications.



4" Over all Length

Order No. 08 - 370

Front hub assembly with 5/8" high speed bearings. Uses 09-8199 bearings.



5" Over all Length

Order No. 08 - 369

Rear hub assembly with 5/8" high speed bearings. Uses 09-8199 bearings.

Wheel Hub for SNAPPER (Right Hand)

1-1/8" ID
2-3/4" Height



Order No. 08 - 7744

Right hand wheel hub. Replaces Snapper 7040433. Used on Snapper 25"-41" rear engine riders.

Wheel Hub for SNAPPER (Left Hand)

3/4" ID
2-3/4" Height



Order No. 08 - 7745

Left hand wheel hub for Snapper 7040434. Used on Snapper 25"-41" rear engine riders.

06/08

WHEELS

High Speed Trailer Tires

Order No. 08 - 837

480 x 400 x 8 Sawtooth / 4 Ply Tubeless. Cheng Shin.

Order No. 08 - 838

570 x 500 x 8 Sawtooth / 4 Ply Tubeless. Cheng Shin.

Order No. 08 - 840

480 x 12 Sawtooth / 4 Ply Tubeless. Cheng Shin.

Order No. 08 - 841

530 x 12 Sawtooth / 4 Ply Tubeless. Cheng Shin.



Valve Stems

Order No. 08 - 368

Short valve stem 1-7/16", core and cap (TR-412). MIN010

Order No. 08 - 364

Long valve stem 1-13/16", core and cap (TR-413). MIN010



WHEELS



LAWNMOWER - Pneumatic Tires

























Order No.	Tread / Description	
08 - 302 08 - 303	20 x 2.125 Stud Tread - Heavy Duty. Cheng Shin. 16 x 2.125 Stud Tread - Heavy Duty. Cheng Shin.	
08 - 341 08 - 342 08 - 343 08 - 344 08 - 10428	410 x 350 x 4 Stud / 2 Ply Tube Type Fits Snapper 7010820. Cheng Shin. 410 x 350 x 5 Stud / 2 Ply Tube Type. Cheng Shin. 410 x 350 x 6 Stud / 2 Ply Tube Type. Cheng Shin. 480 x 400 x 8 Stud / 2 Ply Tube Type Fits Snapper 7010524. Cheng Shin. 200 x 50, knobby tread tire. 4" rim size, 8" H, 2" W Cheng Shin.	
08 - 7827 08 - 9325	20 x 8 x 10 Turf Tread / 4 Ply Tubeless. Cheng Shin. 20 x 10.00 x 10 Turf Tread / 4 Ply Tubeless. Cheng Shin.	
08 - 8925	16 x 800 x 7 Compass Stud Tread / 2 Ply Tubeless Cheng Shin.	
08 - 6594 08 - 9202 08 - 9324	145 x 70 x 6, 2 ply tubeless knobby tread tire. Cheng Shin. Fits on Go-Carts. Used with our tube 08-7143 . 18 x 950 x 8, 2 ply tubeless knobby tread tire. Cheng Shin. 530 x 450 x 6, 2 ply tube type knobby tread tire. Used on Go-Carts. Cheng Shin.	
08 - 8924	410 x 350 x 6, 4 ply tube type knobby tread tire. Cheng Shin.	
08 - 8582 08 - 8636 08 - 7328 08 - 828 08 - 883 08 - 6540 08 - 10756 08 - 347 08 - 8542 08 - 6541 08 - 3275 08 - 362 08 - 348 08 - 5891 08 - 13165	8 x 300 x 4 Turf Tread / 4 Ply Tube Type Fits Toro 68-8970. Cheng Shin. 9 x 350 x 4 Turf Tread / 4 Ply Tubeless Traction Tread Tire, Cheng Shin. Replacement tire for our 08-8575 410 x 350 x 4 Turf Tread / 2 Ply Tubeless, Cheng Shin. Fits Snapper 7052267 and 7010820 11 x 400 x 5 Turf Tread / 2 Ply Tubeless, Cheng Shin. 13 x 650 x 6 Turf Tread / 4 Ply Tubeless, Cheng Shin. 14 x 500 x 6 Turf Tread / 2 Ply Tubeless, Cheng Shin. 15 x 6.00 - 6, 4-ply tubeless Turf Tread tire. Cheng Shin. 16 x 650 x 8 Turf Tread / 2 Ply Tubeless, Cheng Shin. Fits Snapper 11097, 15968, Cheng Shin. 16 x 650 x 8 Turf Tread / 4 Ply Tubeless, Cheng Shin. 16 x 750 x 8 Turf Tread / 2 Ply Tubeless, Cheng Shin. 18 x 650 x 8 Turf Tread / 4 Ply Tubeless, Cheng Shin. 18 x 850 x 8 Turf Tread / 4 Ply Tubeless Kenda. 18 x 950 x 8 Turf Tread / 4 Ply Tubeless Cheng Shin. 20 x 1000 x 10 Turf Tread / 4 Ply Tubeless Kenda K367. Grasshopper. Kenda 24 x 12.00 x 12 Turf Tread / 4 Ply Tubeless Cheng Shin.	

06/08

WHEELS



LAWNMOWER - Pneumatic Tires (Cont.)

Order No.	Tread / Description	
08 - 921	23 x 850 x 12 Kenda Turf Boss / Turf Trac 4 Ply Tubeless	
08 - 913	23 x 1050 x 12 Kenda Turf Boss / Turf Trac 4 Ply Tubeless	
08 - 14233	✿ 20 x 10.50 x 8 Kenda Super Turf Tread /4 Ply Tubeless	
08 - 13662	22 x 10.00 x 10 Kenda Super Turf Tread 4 Ply Tubeless, Replaces Snapper 5100006X1	
08 - 14556	✿ 23 x 9.50 x 12 Kenda Super Turf Tread/ 4 Ply Tubeless	
08 - 14542	✿ 24 x 12.00 x 12 Kenda Super Turf Tread /4 Ply Tubeless	
08 - 829	13 x 500 x 6 Rib / 2 Ply Tubeless, Cheng Shin.	
08 - 830	15 x 600 x 6 Rib / 2 Ply Tubeless, Cheng Shin.	
08 - 833	16 x 650 x 8 Rib / 2 Ply Tubeless, Cheng Shin.	
08 - 8514	11 x 400 x 5 Rib / 4 Ply Tubeless, Cheng Shin.	
08 - 10098	15 x 600 x 6 Rib / 4 Ply Tubeless, Cheng Shin.	
08 - 10430	13 x 6.50 x 6, Rib / 4 Ply Tubeless, Cheng Shin.	
08 - 10809	10 x 3.00 x 4, Kenda Rib / 4-ply Tubless Tire.	
08 - 879	280 x 250 x 4 Kenda Saw Tooth / 2 Ply Tubeless	
08 - 8194	8 x 300 x 4 Smooth / 4 Ply Tube Type, Cheng Shin.	
08 - 908	9 x 350 x 4 Smooth / 4 Ply Tubeless (Replaces Scag 48307-02, 481774) Cheng Shin.	
08 - 349	410 x 350 x 4 Slick/Smooth / 4 Ply Tube Type Tire Cheng Shin.	
08 - 350	410 x 350 x 5 Slick/Smooth / 4 Ply Tube Type Tire Cheng Shin.	
08 - 351	410 x 350 x 6 Slick/Smooth / 4 Ply Tube Type Tire Cheng Shin.	
08 - 9323	12 x 600 x 6 Slick/Smooth / 2 Ply Tube Type Cheng Shin.	
08 - 8949	13 x 500 x 6 Smooth / 4 Ply Tubeless, Cheng Shin. (Replaces Walker 7035-1) Cheng Shin.	
08 - 9201	13 x 650 x 6 Smooth / 4 Ply Tubeless, Cheng Shin.	
08 - 11563	22 x 11.00 x 10 Kenda Bar Tread / 4 Ply Tubeless	
08 - 8941	18 x 850 x 8 Hole-In-One Tread / 4 Ply Tubeless Used on Yamaha golf carts. Kenda	

06/08

WHEELS





WHEELS



Carlisle Tires

06/08

WHEELS

Order No.	Size / Description	
08 - 8939	18 x 850 x 8 Links / 4 Ply Tubeless Tire	
08 - 8923	18 x 850 x 8 Fairway Pro / 4 Ply Tubeless Tire	
08 - 9711	13 x 650 x 6 Turf Master / 4 Ply Tubeless Tire	
08 - 9185	15 x 600 x 6 Turf Master / 4 Ply Tubeless Tire	
08 - 12478	15 x 650 x 8 Turf Master / 2 Ply Tubeless Tire Replaces John Deere M149202	
08 - 9186	16 x 650 x 8 Turf Master / 4 Ply Tubeless Tire	
08 - 9187	16 x 750 x 8 Turf Master / 4 Ply Tubeless Tire	
08 - 9888	18 x 650 x 8 Turf Master / 4 Ply Tubeless Tire	
08 - 9188	18 x 850 x 8 Turf Master / 4 Ply Tubeless Tire	
08 - 9966	18 x 950 x 8 Turf Master / 4 Ply Tubeless Tire	
08 - 9189	20 x 10.00 x 8 Turf Master / 4 Ply Tubeless Tire Replaces Grasshopper 482472	
08 - 10127	20 x 1000 x 10 Turf Master / 4 Ply Tubeless Tire	
08 - 13245	22 x 9.50 x 12 Turf Master / 4 ply Tubeless Tire	
08 - 14002	22 x 10.50 x 12 Turf Master / 4 ply Tubeless Tire	
08 - 11221	22 x 11.00 x 10 Turf Master / 4 ply Tubeless Tire	
08 - 12310	22 x 12.00 x 8 Field Trax Tread / 3 ply Tubeless Tire Replaces John Deere AM11820	
08 - 10214	23 x 8.50 x 12 Turf Master / 4 ply Tubeless Tire	
08 - 9744	23 x 950 x 12 Turf Master / 4 Ply Tubeless Tire	
08 - 9190	23 x 10.50 x 12 Turf Master / 4 Ply Tubeless Tire	
08 - 9283	24 x 12.00 x 12 Turf Master / 4 Ply Tubeless Tire	
08 - 12244	20 x 8 x 10 Turf Master / 4 Ply Tubeless Tire	
08 - 12524	24 x 9.50 x 12 Turf Master / 4 Ply Tubeless Tire	
08 - 5916	410 - 4 (410 x 350 x 4) Stud / 2 Ply Tubeless Tire	
08 - 5917	410 - 5 (410 x 350 x 5) Stud / 2 Ply Tubeless Tire	
08 - 5918	410 - 6 (410 x 350 x 6) Stud / 2 Ply Tubeless Tire	
08 - 5948	480 - 8 (480 x 400 x 8) Stud / 2 Ply Tubeless Tire	
08 - 8006	410 - 4 (410 x 4) Snow Hog / 2 Ply Tubeless Tire Replaces Ariens 71211	
08 - 8007	410 - 6 (410 x 6) Snow Hog / 2 Ply Tubeless Tire Replaces Ariens 71213. Fits models 932026, 932 27, 932 29 & early model 932022 smaller snowthrowers	
08 - 8915	13 x 500 x 6 Snow Hog / 2 Ply Tubeless Tire	
08 - 9549	15 x 500 x 6 Snow Hog / 2 Ply Tubeless Tire	
08 - 8918	16 x 650 x 8 Snow Hog / 2 Ply Tubeless Tire	
08 - 8919	480 x 8 Snow Hog / 2 Ply Tubeless Tire	



Carlisle Tires (Cont.)

Order No.	Size / Description	
08 - 7700 08 - 7699 08 - 8084	15 x 600 x 6 20 x 800 x 8 20 x 10 x 8	Turf Mate / 2 Ply Tubeless Tire Turf Mate / 2 Ply Tubeless Tire Turf Mate / 4 Ply Tubeless Tire
08 - 6832	22 x 11.00 x 8	Turf-CTR / 4 Ply Tubeless Tire
08 - 7022 08 - 8456 08 - 9500	13 x 500-6 13 x 500 x 6 13 x 650 x 6	Rib / 2 Ply Tubeless Tire Rib / 4 Ply Tubeless Tire Rib / 4 Ply Tubeless Tire. Fits Grasshopper wheel assembly 603975.
08 - 7026 08 - 7027	15 x 600-6 16 x 650-8	Rib / 4 Ply Tubeless Tire Rib / 4 Ply Tubeless Tire
08 - 903 08 - 361	400 x 6 Rib 480 - 8	Wheel Barrow / 2 Ply Tubeless Tire Wheel Barrow / 2 Ply Tubeless Tire
08 - 906 08 - 8917 08 - 8539	410 - 4 (410 x 350 x 4) 410 x 6 530 x 450 x 6	Sawtooth / 2 Ply Tubeless Tire Sawtooth / 4 Ply Tubeless Tire Sawtooth / 6 Ply Tubeless Tire
08 - 7023 08 - 9495 08 - 5894 08 - 8688	13 x 500-6 16 x 650 x 8 480 - 8 (480 x 400-8) 20 x 10.00 x 8	Super Lug / 2 Ply Tubeless Tire Super Lug / 4 Ply Tubeless Tire Super Lug / 2 Ply Tubeless Tire Super Lug / 4 Ply Tubeless Tire
08 - 8687 08 - 9154	23 x 10.50 x 12 23 x 850 x 12	Tru Power Tread / 4 Ply Tubeless Tire Tru Power Tread / 4 Ply Tubeless Tire
08 - 8896 08 - 10193 08 - 11809	21 x 11 x 8 21 x 11 x 10 24 x 12.00 x 12	AT 101 Tread / 4 Ply Tubeless Tire Titan/Chevron AT101/4 ply Tubeless Tire Chevron tread / 4 Ply belted Tubeless Tire

06/08
WHEELS



WHEELS



Carlisle Tires (Cont.)

06/08

WHEELS

Order No.	Size / Description	
08 - 8920	15 x 600 x 6	Turf Saver II / 2 Ply Tubeless Tire
08 - 8082	16 x 650 x 8	Turf Saver II / 2 Ply Tubeless Tire
08 - 8083	18 x 850 x 8	Turf Saver II / 2 Ply Tubeless Tire
08 - 9881	4.10 x 4	Turf Saver / 2 Ply Tubeless Tire
08 - 7694	11 x 400 x 4	Turf Saver / 2 Ply Tubeless Tire
08 - 8540	11 x 400 x 5	Turf Saver / 2 Ply Tubeless Tire
08 - 359	13 x 500 x 6	Turf Saver / 2 Ply Tubeless Tire
08 - 8457	13 x 500 x 6	Turf Saver / 4 Ply Tubeless Tire
08 - 5945	13 x 650 x 6	Turf Saver / 2 Ply Tubeless Tire
08 - 7025	13 x 650 x 6	Turf Saver / 4 Ply Tubeless Tire
08 - 346	15 x 600 x 6	Turf Saver / 2 Ply Tubeless Tire
08 - 5947	16 x 650 x 8	Turf Saver / 2 Ply Tubeless Tire
08 - 7028	16 x 650 x 8	Turf Saver / 4 Ply Tubeless Tire
08 - 8541	16 x 750 x 8	Turf Saver / 2 Ply Tubeless Tire
08 - 12671	18 x 7.50 x 8	Turf Saver / 4 Ply Tubeless Tire
08 - 7029	18 x 850 x 8	Turf Saver / 4 Ply Tubeless Tire
08 - 7030	18 x 950 x 8	Turf Saver / 4 Ply Tubeless Tire
08 - 7695	18 x 950 x 8	Turf Saver / 2 Ply Tubeless Tire
08 - 7201	20 x 8 x 8	Turf Saver / 2 Ply Tubeless Tire
08 - 7202	20 x 10 x 8	Turf Saver / 2 Ply Tubeless Tire
08 - 7031	20 x 10.00 x 10	Turf Saver / 4 Ply Tubeless Tire
08 - 10970	21 x 7 x 10	Turf Saver / 2 Ply Tubeless Tire
08 - 11059	22 x 950 x 12	Turf Saver / 2 Ply Tubeless Tire
08 - 7696	23 x 950 x 12	Turf Saver / 2 Ply Tubeless Tire
08 - 7033	23 x 10.50 x 12	Turf Saver / 4 Ply Tubeless Tire
08 - 9494	11 x 400 x 5	Smooth Tread / 4 Ply Tubeless Tire Fits our 08-8551 caster wheel.
08 - 8888	18 x 950 x 8	Smooth Tread / 4 Ply Tubeless Tire
08 - 10289	13 x 5.00 x 6	4 ply smooth Tubeless Tire
08 - 10290	13 x 6.50 x 6	4 ply smooth Tubeless Tire
08 - 12795	18 x 8.50 x 10	Multi-Trac / 4 Ply Tubeless Tire
08 - 7049	18 x 10.50 x 10	Multi-Trac / 4 Ply Tubeless Tire
08 - 11471	18 x 8 x 10	Multi-Trac / 4 Ply Tubeless Tire
08 - 12879	18 x 7 x 8	Multi-Trac / 4 Ply Tubeless Tire
08 - 10620	24 x 9.50 x 12	Multi-Trac / 4 Ply Tubeless Tire
08 - 11509	24 x 12 x 12	Multi-Trac / 4 Ply Tubeless Tire
08 - 11023	26 x 12 x 12	Multi-Trac / 4 Ply Tubeless Tire
08 - 10730	20 x 10 x 10	Multi-Trac / 4 Ply Tubeless Tire
08 - 12635	20 x 12.00 x 10	Turf-Trac RC / 4 Ply Tubeless Tire
08 - 11141	15 x 600 x 6	2 ply Tubeless Super Turf Tread Tire Replaces John Deere M123810.
08 - 12766	480-8	2 ply Tubeless X-Trac Tread Tire
08 - 12765	15 x 5.00 x 6	2 ply Tubeless X-Trac Tread Tire
08 - 12764	13 x 5.00 x 6	2 ply Tubeless X-Trac Tread Tire
08 - 12767	16 x 6.50 x 8	2 ply Tubeless X-Trac Tread Tire X-Trac for Snowblowers





Tubes



4" Tubes

Order No.	Size	Valve Type
08 - 9620	410 x 350 x 4	Straight Stem
08 - 8694	280 x 250 x 4	L Shaped Stem
08 - 8694	8 x 300 x 4	L Shaped Stem
08 - 8694	9 x 350 x 4	L Shaped Stem
08 - 352	410 x 350 x 4	L Shaped Stem Fits Snapper 10821
08 - 880	280 x 250 x 4	L Shaped Parallel To Rim
08 - 880	8x 300 x 4	L Shaped Parallel To Rim
08 - 3268	9 x 350 x 4	L Shaped Parallel To Rim
08 - 3266	410 x 350 x 4	L Shaped Parallel To Rim



06/08

5" Tubes

Order No.	Size	Valve Type
08 - 9619	11 x 400 x 5	Straight Stem
08 - 9619	410 x 350 x 5	Straight Stem
08 - 878	11 x 400 x 5	L Shaped Stem
08 - 353	410 x 350 x 5	L Shaped Stem
08 - 3267	410 x 350 x 5	L Shaped Parallel To Rim



WHEELS

6" Tubes

Order No.	Size	Valve Type
08 - 9618	12.5 x 450 x 6	Straight Stem
08 - 9621	13 x 500 x 6	Straight Stem
08 - 884	13 x 650 x 6	Straight Stem
08 - 7811	15 x 600 x 6	Straight Stem
08 - 7143	145 x 70 x 6	Straight Stem
08 - 904	400 x 6	Straight Stem
08 - 9618	410 x 350 x 6	Straight Stem
08 - 354	12.5 x 450 x 6	L-Shaped Stem
08 - 360	13 x 500 x 6	L-Shaped Stem
08 - 357	15 x 600 x 6	L-Shaped Stem
08 - 354	400 x 6	L-Shaped Stem
08 - 354	410 x 350 x 6	L-Shaped Stem



SLIME SMART Tube

Order No. 08 - 14344

410 x 350 x 6, Slime Smart Tube. Pre-injected with puncture neutralizing Slime, the Slime Smart Tube instantly seals punctures up to 1/8".



Order No. 08 - 14347

15 x 600 x 6, Slime Smart Tube. Pre-injected with puncture neutralizing Slime, the Slime Smart Tube instantly seals punctures up to 1/8".



WHEELS



7" Tubes

Order No.	Size	Valve Type
08 - 10795	350 x 400 x7	Straight Stem Fits Honda tillers.



8" Tubes

Order No.	Size	Valve Type
08 - 358	16 x 650 x 8	Straight Stem Fits Snapper 7010525.
08 - 358	16 x 750 x 8	Straight Stem
08 - 7146	18 x 650 x 8	Straight Stem
08 - 7146	18 x 750 x 8	Straight Stem
08 - 898	18 x 850 x 8	Straight Stem
08 - 898	18 x 950 x 8	Straight Stem
08 - 7260	20 x 10 x 8	Straight Stem
08 - 7261	20 x 700 x 8	Straight Stem
08 - 7261	20 x 8 x 8	Straight Stem
08 - 899	21 x 1200 x 8	Straight Stem
08 - 899	22 x 1100-8	Straight Stem
08 - 6571	300 x 8	Straight Stem
08 - 355	400 x 8	Straight Stem
08 - 355	480 x 400 x 8	Straight Stem Fits Snapper 7010525.
08 - 7145	570 x 500 x 8	Straight Stem



9" Tubes

Order No.	Size	Valve Type
08 - 7821	22 x 12 x 9	Straight Stem
08 - 900	25 x 1200-9	Straight Stem



L Shaped Stem
Parallel To Rim

10" Tubes

Order No.	Size	Valve Type
08 - 7828	19 x 800 x 10	Straight Stem
08 - 7828	20 x 8 x 10	Straight Stem
08 - 7147	20 x 1000 x 10	Straight Stem
08 - 7825	22 x 8 x 10	Straight Stem
08 - 7822	22 x 12 x 10	Straight Stem
08 - 7824	25 x 12.50 x 10	Straight Stem



L Shaped
Stem

SLIME SMART Tube

Order No. 08 - 14345

410 x 400 x 8, Slime Smart Tube. Pre-injected with puncture neutralizing Slime, the Slime Smart Tube instantly seals punctures up to 1/8".



06/08
WHEELS



11" Tubes

Order No.	Size	Valve Type
08 - 7826	23 x 8 x 11	Straight valve stem.
08 - 7823	24 x 9 x 11	Straight valve stem.

12" Tubes

Order No.	Size	Valve Type
08 - 3265	23 x 850/950 x 12	Straight Stem
08 - 3265	23 x 950 x 12	Straight Stem
08 - 3264	23 x 1050 x 12	Straight Stem
08 - 10101	24 x 12 x 12	Straight Stem
08 - 10959	26 x 12 x 12	Straight Stem
08 - 7144	480 x 400 x 12	Straight Stem
08 - 7144	480 x 12	Straight Stem
08 - 6627	530 x 450 x 12	Straight Stem
08 - 6627	530 x 12	Straight Stem

16" Tubes

Order No.	Size	Valve Type
08 - 6953	16 x 2.125	Straight Stem (Economy)
08 - 305	16 x 2.125	Straight Stem (Heavy Duty)

20" Tubes

Order No.	Size	Valve Type
08 - 6954	20 x 2.125	Straight Stem (Economy)
08 - 304	20 x 2.125	Straight Stem (Heavy Duty)

Misc. Tubes

Order No.	Size	Valve Type
08 - 10429	200 x 50	L-Shaped Stem Fits our 08-10428 tire.



06/08

WHEELS



Valve Stems

Order No. 08 - 368
Short valve stem 1-7/16", core and cap (TR-412). MIN010





Order No. 08 - 364
Long valve stem 1-13/16", core and cap (TR-413). MIN010









ATV Carlisle Tires

06/08
WHEELS

Order No.	Size / Description	
08 - 10728	25 x 1200 x 9	Stryker belted, 4 ply Tubeless Tire
08 - 10656	22 x 900 x 10	4 ply Tubeless Stryker I Tread ATV Fits NHS EZ-Go.
		
08 - 10660	22.5 x 10 x 8	3 ply Tubeless HD Field Trax Tire
08 - 10661	25 x 13 x 9	3 ply Tubeless HD Field Trax Tire
		
08 - 10647	22 x 7 x 10	2 ply tubeless Trial Wolf Tread Sport Front ATV Tire.
08 - 10649	25 x 8 x 12	2 ply tubeless Trial Wolf Tread Sport Utility Front ATV Tire.
08 - 10650	20 x 11 x 9	3 ply tubeless Trial Wolf Tread Popular Sport Rear ATV Tire.
08 - 10651	22 x 10 x 10	2 ply tubeless Trial Wolf Tread Entry Level Utility Rear ATV Tire.
08 - 10652	20 x 11 x 8	3 ply tubeless Trial Wolf Tread Popular Sport Rear ATV Tire.
08 - 10653	20 x 11 x 10	3 ply tubeless Trial Wolf Tread Popular Sport Rear ATV Tire.
08 - 10654	25 x 12 x 10	2 ply tubeless Trial Wolf Tread Utility Rear ATV Tire.
08 - 10671	25 x 10 x 12	2 ply tubeless Trial Wolf Tread Utility Rear ATV Tire.
		 08-10647
08 - 10658	18 x 9.50 x 8	2 ply tubeless Knobby Tread ATV Tire
08 - 10659	22 x 11 x 8	2 ply tubeless Knobby Tread ATV Tire
		
08 - 10725	24 x 9.50 x 10	4 ply tubeless All Trail II Tire. Used on John Deere Gators.
08 - 10726	24 x 10.50 x 10	4 ply tubeless All Trail II Tire. Used on John Deere Gators.
		



ATV Carlisle Tires (Cont.)

Order No.	Size / Description	
08 - 10731	25 x 1100 x 12 3 ply tubeless AT489 Tread Tire. Fits John Deere Gators.	
08 - 10732	24 x 9.50 x 10 4 ply tubeless AT489 Tread Tire. Fits John Deere Gators.	
08 - 10733	24 x 12.00 x 10 4 ply tubeless AT489 Tread Tire. Fits John Deere Gators.	
08 - 10760	22.5 x 10.00 x 8 2 ply tubeless Turf Trac Tread Tire, Fits John Deere Gators Front Tire	
08 - 10761	25 x 12.00 x 9 2 ply tubeless Turf Trac Tread Tire, Fits John Deere Gators Rear Tire.	
08 - 10657	23 x 10.50 x 12 4 ply Tubeless All Trail Tread ATV Fits NHS club car.	
08 - 10735	22.5 x 10.00 x 8 3 ply Tubeless Turf Tamer Tread Tire Used on John Deere Gators Front Tire.	
08 - 10736	25 x 12.00 x 9 3 ply Tubeless Turf Tamer Tread Tire Used on John Deere Gators Rear Tire.	

06/08

WHEELS



BEARINGS & BUSHINGS

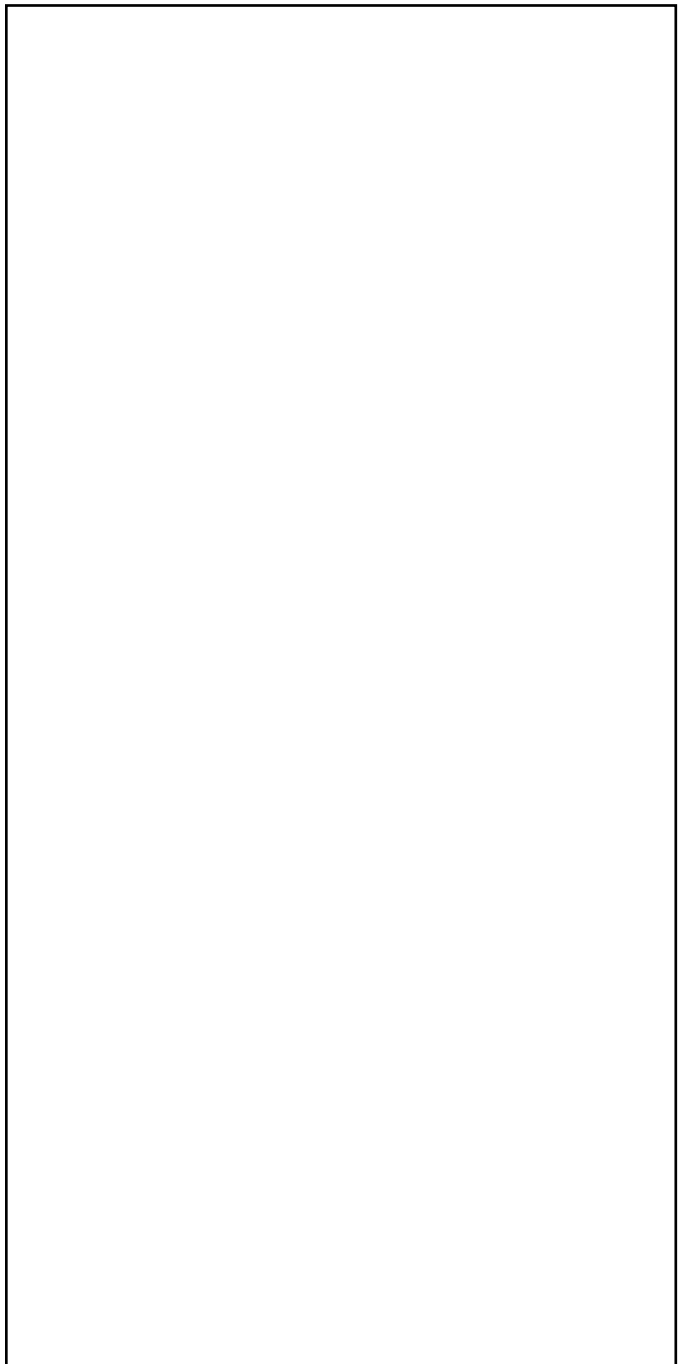

Quick-Glance

BEARINGS & BUSHINGS	PG.
Bearings	130-136
Bearing Kits	137-141
Wheel Bushings & Spacers	141-143
Bushings	143-148
Reference Chart	149-154



BEARINGS & BUSHINGS

Order No.	Description
09 - 324	1/2" ID (12.70 mm) x 1-1/8" OD (28.58 mm) Fits 5 x 1.50, 6 x 1.75, 7 x 1.50, 7.50 x 1.50, 8 x 1.75, 10 x 1.75. Fits Murray Plastic Wheels
09 - 325	1/2" ID (12.70 mm) x 1-3/8" OD (34.93 mm) Fits many universal wheels.
09 - 326	5/8" ID (15.88 mm) x 1-3/8" OD (34.93 mm) Fits 8 x 2.75, 10 x 2.75.
09 - 327	3/4" ID (19.05 mm) x 1-3/8" OD (34.93 mm) Replaces Snapper No. 7011807, Toro No. 110513, 251-210.
09 - 9892	3/8" ID (9.53 mm) x 1-1/8" OD (28.58 mm) Fits many universal wheels.



UNIVERSAL BEARINGS



Order No.	ID	OD	Height	Universal Bearing No.
09 - 50185	5/16" (8 mm)	55/64" (22 mm)	9/32" (7 mm)	608
09 - 50187	25/64" (10 mm)	1-3/16" (30 mm)	11/32" (9 mm)	6200
09 - 50188	15/32" (12 mm)	1-1/4" (32 mm)	25/64" (10 mm)	6201
09 - 50189	37/64" (15 mm)	1-3/8" (35 mm)	7/16" (11 mm)	6202
09 - 50180	43/64" (17 mm)	1-3/8" (35 mm)	25/64" (10 mm)	6003
09 - 50181	25/32" (20 mm)	1-21/32" (42 mm)	15/32" (12 mm)	6004
09 - 50190	63/64" (25 mm)	2-3/64" (52 mm)	19/32" (15 mm)	6205
09 - 50183	1-3/16" (30 mm)	2-3/16" (55 mm)	1/2" (13 mm)	6006
09 - 50191	1-3/16" (30 mm)	2-7/16" (62 mm)	5/8" (16 mm)	6206

****09-50191 Fits Bad Boy spindle 037-6023-00.****

Bearings

ID 3/8" (9.53 mm)
OD 1" (25.40 mm)
Height 5/16" (7.94 mm)



Order No. 09 - 3229

Replaces Snapper 7028014, 12304. Hex Shaft Bearing on 21" self-propelled mowers.

ID 7/16" (11.11 mm)
OD 1-1/8" (28.58 mm)
Height 13/16" (20.64 mm)



Order No. 09 - 2703

For Snapper Wheels 7011125. Back to Back bearings. (Also used in our McLane Wheels).

Bearing for MTD

ID 1/2" (12.7 mm)
OD 11/16" (17.5 mm)
Height 19/32" (19.05 mm)



Order No. 09 - 9326

Bearing replaces MTD 741-0324 941-0324. Flanged bearing fits self propelled mowers. (nylon)

ID 1/2" (12.70 mm)
OD 1-1/8" (28.58 mm)
Height 5/16" (7.94 mm)



Order No. 09 - 6625

Wheel bearing for Toro. Replaces Toro 52-2450. Used on 21" Toro Commercial Mowers. Bearing No. R8-2RS.

Bearing for ARIENS

ID 1/2" (12.70 mm)
OD 1-3/8" (34.93 mm)
Height 7/16" (11.11 mm)



Order No. 09 - 8869

Bearing replaces Ariens 54080. Fits 21" self propelled walk behind mowers with 5/8" axle. Also replaces John Deere AM122108, MTD 741-0133. Also fits model 824 snowblowers.

09

BEARINGS



BEARINGS & BUSHINGS

Bearing for EXMARK

Order No. 09 - 8351

Bearing replaces Exmark 1-631560 and 1-513009. Fits front caster wheels.



ID 1/2" (12.70 mm)
OD 1-3/8" (34.93 mm)
Height 1/2" (12.70 mm)



ID 9/16" (14.29 mm)
OD 1-3/8" (34.93 mm)
Height 7/16" (11.11 mm)

Order No. 09 - 3228

Commercial Bearing. Replaces Snapper 7018767, wheel arm assembly bearing. Bearing No. SC0265LUC3.

Bearing for BOBCAT



ID 1/2" (12.70 mm)
OD 1-3/8" (19.05 mm)
Height 1" (25.40 mm)

Order No. 09 - 8375

Bearing replaces Bobcat 78113. Bearing used in our 06-2998 & 06-2999 wheels.



Order No. 09 - 1264

9/16" ID (14.29 mm), 1-3/8" OD (34.93 mm), 7/16" thickness. Fits Sears, Western Tool. Bearing No. 1622-ZZ

Order No. 09 - 1266

.3939" ID (9.53 mm), 1.1811" OD (34.93 mm), .3543" thickness. Fits K&S, Trim-All. Bearing No. 6200ZZ



ID 15mm (15 mm)
OD 1-3/8" (34.93 mm)
Height 7/16" (11.11 mm)

Order No. 09 - 7312

High Speed Bearing fits Echo, RedMax, Green Machine and Shindaiwa, Kawasaki chain saws, trimmers and blowers. Bearing No. 6202, open both sides.

Wheel Bearing for HONDA



ID 15mm (15 mm)
OD 1-1/4" (31.75 mm)
Height 23/64" (9.13 mm)

Order No. 09 - 8525

Wheel bearing replaces Honda 96150-60020-10, code 0876904. Fits 21" commercial mowers. Sealed 2 sides. Bearing No. 6002-2RS.



ID 5/8" (15.88 mm)
OD 1-3/8" (34.93 mm)
Height 7/16" (11.11 mm)

Order No. 09 - 481

Premium High Speed Bearing, double sealed. Replaces Snapper 7010756 (chain case ball bearing), Murray, Hahn-Eclipse 326985. May be used with or without retaining clip. Fits McLane and Star Clipper Edgers. Bearing No. 99502H-2RS (NR)



ID 5/8" (15.88 mm)
OD 1-3/8" (34.93 mm)
Height 1/2" (11.11 mm)

Order No. 09 - 7950

Front wheel bearing replaces Grasshopper 120050, John Deere PT8894, Snapper 7035358. Also fits Walker 5037, Dixie Chopper 10205 & McLane 2036. Bearing No. 44F40P.

ID 5/8" (15.88 mm)
OD 1-3/8" (34.93 mm)
Height 7/16" (11.11 mm)



ID 5/8" (15.88 mm)
OD 1-3/8" (34.93 mm)
Height 7/16" (11.11 mm)

Order No. 09 - 8199

High speed bearing, double sealed replaces Snapper 7010756 (chain case bearing), Murray, Hahn-Eclipse 326985, Dixie Chopper 67205, Bobcat 38046N, Scag 48224. May be used with or without retaining clip. Fits McLane and Star Clipper edgers. Bearing No. 99502H-2RSNR.

Order No. 09 - 18199

High speed bearing. (carded)

MIN005



Order No. 09 - 8198

High speed edger bearing. Also fits Cooper, King-O-Lawn and Murray. Reduction gear bearing. Replaces Bunton PLO 678, Jacobsen 552234, Scag 48224, Snapper 7077324, Bobcat 3846N, Exmark 303051, FD Kees 363181, John Deere PT8891. Uses 5 bearings in our Gear Box Assembly 05-7097. Also fits Cooper, King-O-Lawn and Murray. Bearing No. 99502H-2RS.



BEARINGS & BUSHINGS

Spindle Bearing for MURRAY



ID 5/8" (15.88 mm)
OD 1-3/8" (34.93 mm)
Height 7/16" (11.11 mm)

Order No. 09 - 8831

Spindle bearing for Murray 92574 spindle assembly. Fits our 10-2925 Murray spindle assembly. Also used in our 10-8320 spindle repair kit. Lower bearing.

Flange Bearing for TORO



ID 5/8" (15.88 mm)
OD 2-1/2" (63.5 mm)
Height 3/4" (19.5 mm)

Order No. 09 - 12651

Flange bearing replaces Toro 51-4270. Also replaces Bobcat 38213 & Encore 363292. Fits mid-size models with Peerless Transmissions. Two 9/32" mounting holes, 2-1/2" center to center.



ID 5/8" (15.88 mm)
OD 1-9/16" (39.69 mm)
Height 15/32" (11.91 mm)

Order No. 09 - 483

Replaces Yazoo 204-019 and MTD 941-0524, 741-0524P. Used in many spindle shafts. Also fits Murray. Bearing No. 6203-2RS.

Universal Roller Cage Bearing



ID 5/8" (15.9 mm)
OD 1-3/8" (34.9 mm)
Height 1" (25.4 mm)

Order No. 09 - 9338

5/8" universal roller cage bearing.

Bearing for DIXON



ID 5/8" (15.88 mm)
OD 1-9/16" (40 mm)
Height 15/32" (11.91 mm)

Order No. 09 - 8437

Bearing replaces Dixon 5249, 539116898. Fits in transaxle on Dixon ZTR mowers. Models 4422, 4421, 3361, 3302, 2301. Bearing No. NTN6203LU. Sealed both sides.

Spindle Bearing for MURRAY



ID 5/8" (15.88 mm)
OD 1-9/16" (39.69 mm)
Height 15/32" (11.91 mm)

Order No. 09 - 8861

Spindle bearing for Murray 92574 spindle assembly. Fits our 10-2925 Murray spindle assembly. Also used in our 10-8320 spindle repair kit. Upper bearing.

Heavy Duty Angular Contact Ball Bearing



ID 3/4" (19.05 mm)
OD 1-3/8" (34.93 mm)
Height 1/2" (12.7 mm)

Order No. 09 - 13414

3/4" ID x 1-3/8" OD x 1/2" Height, heavy duty angular contact ball bearing. Fits our Reliance Wheel Assemblies.

Bearing for EXMARK



ID 5/8" (15.88 mm)
OD 1-9/16" (34.93 mm)
Height 7/8" (22.23 mm)

Order No. 09 - 8077

Output shaft support bracket bearing replaces Exmark 1-303067. Also fits Bobcat 35062B, used with our 10-8184 Flange.



ID 5/8" (15.88 mm)
OD 1-3/8" (34.93 mm)
Height 1/2" (12.7 mm)

Order No. 09 - 13418

5/8" ID x 1-3/8" OD x 1/2" Height, heavy duty angular contact ball bearing. Fits our Reliance Wheel Assemblies.



ID 21/32" (17 mm)
OD 1-9/16" (40 mm)
Height 15/32" (12 mm)

Order No. 09 - 7210

Spindle bearing replaces Toro/Wheel Horse 109966. Fits 42" & 48" decks. Bearing No. 6203-RS, sealed one side.



ID 21/32" (17 mm)
OD 1-9/16" (40 mm)
Height 15/32" (12 mm)

Order No. 09 - 8507

Bearing replaces AYP 110485X. Fits AYP 130794 quill assembly (top bearing). Also replaces Husky 532110485, MTD 741-0600. Homeowner models. Bearing No. 6203-2RS.



ID 21/32" (17 mm)
OD 1-9/16" (40 mm)
Height 15/32" (12 mm)

Order No. 09 - 7917

Bearing replaces Noma 49562 & Snapper 7026808. Fits Noma-AMF/Dynamark 32", 36" and 39" models 3210-5100, 3612-1500, 3612-1501, 3912-0500, 3912-0501. Used in 10-1172 quill assembly. Bearing No. 6203ZZ.

09
BEARINGS



BEARINGS & BUSHINGS



ID 21/32" (17 mm)
OD 1-9/16" (40 mm)
Height 31/64" (12.30 mm)

Order No. 09 - 6513

Replaces King-O-Lawn 7192. Also fits Trimmer and Tru-Cut reel mowers. Trimmer No. 20202, 25202 and Tru-Cut T11275. Bearing No. 6203Z.

Bearing Sleeve for MTD



ID 3/4" (19.05mm)
OD 1" (25.4mm)
Height 1" (25.4mm)

Order No. 09 - 9572

Bearing sleeve replaces MTD 741-0340, 941-0340. Fits 600 series models. Also fits 1985 - 1987 MTD rider models 135-137 with single speed transaxle only.

Axle Bearing for NOMA



ID 3/4" (19.05 mm)
OD 1-1/8" (28.6 mm)
Height 3/4" (19.05 mm)

Order No. 09 - 9303

Axle bearing replaces Noma 581730. Axle bearing for Noma snowblowers.

Bearing Collar for SNAPPER



ID 3/4" (19.05 mm)
OD 1-5/16" (33.34 mm)
Height 17/32" (13.50 mm)

Order No. 09 - 8726

Bearing collar with set screw replaces Snapper 14625. Fits 25", 26", 28", 30" & 33" cut rear engine riders.



ID 3/4" (19.05 mm)
OD 1-3/8" (34.93 mm)
Height 1/2" (12.70 mm)

Order No. 09 - 6573

Bearing replaces Snapper 7013680, 15474. Fits Driven Disc Assembly No. 57444 on self-propelled models. Heavy Duty - Removable back seal. Also replaces Gravely 11193, 37823, Toro 110513, 251-210, John Deere AM118315, AM35443.

Universal Roller Cage Bearing



ID 3/4" (19.05 mm)
OD 1-3/8" (34.93 mm)
Height 1-1/8" (28.58 mm)

Order No. 09 - 7869

Heavy duty universal roller cage bearing.



ID 3/4" (19.05 mm)
OD 1-3/4" (44.45 mm)
Height 1/2" (12.70 mm)

Order No. 09 - 487

Sealed high speed bearing. For Ariens 54063 Snowblowers. Bearing for LX172 John Deere. bearing No. SC0493LU



ID 3/4" (19.05 mm)
OD 1-3/8" (34.93 mm)
Height 17/32" (13.49 mm)

Order No. 09 - 328

Sealed one side. Fits Snapper 7026693, 7011807. Also fits Wheel Horse 110513.



ID 3/4" (19.05 mm)
OD 1-9/16" (39.69 mm)
Height 15/32" (11.91 mm)

Order No. 09 - 6535

Spindle Bearing. Replaces Toro 37-0200 and Tecumseh 780-119. Used on Toro front engine rider mulcher unit model 57380 & 57385. Bearing No. 6203-2RS. Not flanged.



ID 3/4" (19.05 mm)
OD 1-3/4" (44.45 mm)
Height 1-7/16" (36.51 mm)

Order No. 09 - 6536

Rear Axle Bearing. Replaces Snapper 7014624. Used on Snapper Extra Tough Rider. Left hand side (small bearing).



ID 3/4" (19.05 mm)
OD 1-25/32" (45.24 mm)
Height 19/32" (15.08 mm)

Order No. 09 - 484

Replaces Snapper 7013313 & 7010696 spindle bearing. Also replaces Allis Chalmers 536986, Ariens 54073 & 54120, Bolens 1185828, Gravely 35925 & 11641, Wheel Horse 109842, IHC 465003R-91, John Deere 9266 & 9296, MF 83341M-1, Simplicity 108202, Yazoo 204-060, Trail mate, E-Z Roll and Hogg 11109, Dixon 6011. Used on our 10-7154 Shaft. Bearing No. 9504-ZZ.



ID 3/4" (19.05 mm)
OD 1-25/32" (45.24 mm)
Height 21/32" (16.67 mm)

Order No. 09 - 813

Replaces Snapper 7012931, Ariens 54045 & 54055; Bolens 1185275 & 9401, Gilson 1044 & 1140, Ford 8A1216B & 8A1217B, IHC 651814R1 & 651815R91, JD 8188 & 8226, MF 831-054M1, 831-055M1, Roper 1553H, 1554H, Simplicity 154393, 154486 and Toro 254-78, 254-79. Also fits Power King (economy) Bearing No. LM11949, LM11910.

09 BEARINGS



BEARINGS & BUSHINGS

Shaft Bearing for BLUE BIRD



ID 3/4" (19.05 mm)
OD 1-27/32" (46.83 mm)
Height 27/32" (21.43 mm)

Order No. 09 - 8863

Shaft bearing with locking collar & set screw replaces Blue Bird 0315. Fits models F20 & F20B. Used with our 15-6324 flail bld set & our 10-8755 shaft set & our 10-8741 spacer set.

Auger Impeller Bearing for MTD



OD 1-55/64" (47.24 mm)
ID 3/4" (19.05 mm)
Height 27/32" (21.43 mm)

Order No. 09 - 10265

Auger impeller bearing replaces MTD 941-0309 without collar & 941-0310 with collar. Fits 22" and 40" MTD snowblowers. Bearing No. SA204-12. Insert bearing.



ID 3/4" (19.05 mm)
OD 2-3/64" (51.99 mm)
Height 1-1/16" (26.99 mm)

Order No. 09 - 3274

Replaces Toro 47-1490. For rear engine models 725, 832, 1132 and 1232. Bearing No. SB205-12. No set screws.

Wheel Bearing for HUSTLER



ID 3/4"(19.05 mm)
OD 1-3/4"(44.45 mm)
Height 1/2"(12.70 mm)

Order No. 09 - 11835

Flanged wheel bearing replaces Hustler 39677.



ID .787" (20 mm)
OD 1.85" (47 mm)
Height 9/16" (14.29 mm)

Order No. 09 - 442

Replaces Allis Chalmers 1652231, Ariens 54123, John Deere 7677R, MTD 741-0919, 941-0919, Toro 251-297, 251-318, Simplicity 118011, Snapper 7012828, Massey Ferguson 1568, Roof 476, AYP 129895. Fits our quill assembly 17-8479. Bearing No. 6204-2RS.

Auger Bearing for AYP



ID 3/4" (19mm)
Height 1-39/64" (25.4mm)



Order No. 09 - 5618

Auger bearing replaces AYP 187925 & Husqvarna 532-187925. 3-5/8" x 2" flange.



ID 63/64" (25 mm)
OD 2-3/64" (52 mm)
Height 19/32" (15.08 mm)

Order No. 09 - 7162

Bearing replaces Toro/Wheel Horse 113514. Fits Wheel Horse 50" & 60" cut ZTR 500 series mowers. Fits Grasshopper 33210. Also fits Snapper 19572, 79813, ZTR 42", 48" & 60" decks. Bearing No. 6205-RS, sealed one side.

Reel Bearing for TRU-CUT



ID .787" (20 mm)
OD 1.850" (47 mm)
Height 9/16" (14.29 mm)

Order No. 09 - 7166

Reel Bearing replaces Tru-Cut 11295-11536. Fits 27" reel mowers. Bearing No. 6204Z, sealed one side.



ID 63/64" (25.00 mm)
OD 2-7/16" (61.91 mm)
Height 21/32" (16.67 mm)

Order No. 09 - 3217

Sealed bearing. Replaces Bobcat 35008N, Bunton PL4611, PL4609, Exmark 1-303543, 1-303057, Snapper/Kees 19125, 76510, John Deere 9467. Also fits Scag. Bearing No. 6305-2RS.

Axle Bearing for MTD



OD 2-3/64" (51.99 mm)
ID 7/8" (22.22 mm)
Height 1" (25.4 mm)

Order No. 09 - 10264

Axle Bearing replaces MTD 941-0185. Fits 800 & 900 series snowthrowers.



ID 1" (25.40 mm)
OD 1-31/32" (50.01 mm)
Height 19/32" (15.08 mm)

Order No. 09 - 814

Replaces Dixie Chopper 10207, Gravely 38199 and Gilson 1045, 1046, Scag 48668 and Toro 468530. Fits Gravely 50" (3) blade deck and 40" (2) blade deck. Also fits Toro 36", 44", 52" front spindle bearing. Bearing No. L44610, L44643.

Spindle Bearing for SCAG



ID 63/64" (25.00 mm)
OD 2-7/16" (62 mm)
Height 21/32" (16.67 mm)

Order No. 09 - 7178

Spindle bearing replaces Scag 48101-02. Used on our spindle 10-5722. Bearing No. 6305-Z, sealed one side.

09
BEARINGS



BEARINGS & BUSHINGS



ID 1" (25.40 mm)
OD 2" (50.80 mm)
Height 9/16" (14.29 mm)

Order No. 09 - 6534

Wheel Bearing. Replaces Scag 48193-01 & 481858, Toro 251-299. Used on Scag midsize walk mowers.



ID 1" (25.40 mm)
OD 2.0472" (52 mm)
Height 27/32" (21.43 mm)

Order No. 09 - 8488

Bearing replaces Dixon 1701 & 539115279. Fits spindle assembly on 30", 42", 50" cut ZTR. Also fits wheel hubs on Dixon ZTR with chain drive, replaces Exmark 513016, John Deere 8597, Grasshopper 120081, Dixie Chopper 30218, Bobcat 38348-01, Woods 70006 & Hustler 077123. Bearing No. RA100RR.

Bearing for Dixie Chopper



ID 1.001" (25.42mm)
OD 2.0475" (52mm)
Height .590" (15mm)

Order No. 09 - 9937

Bearing replaces Dixie Chopper 30218.

Bearing for MTD



ID 1" (25.4 mm)
OD 1-1/2" (38.1 mm)
Height 3/4" (19.05 mm)

Order No. 09 - 9328

Bearing replaces MTD 741-0244. Flanged bearing for MTD. Flanged OD 1-3/4" (nylon)

Roller Bearing for DIXIE CHOPPER



ID 1.063" (27mm)
OD 1.980" (50.3mm)

Order No. 09 - 9951

Roller bearing replaces Dixie Chopper 97171. Fits caster yoke. Bearing No. LM44610 & LM44649.

Spindle Bearing for GRASSHOPPER



ID .9845" (25.0mm)
OD 2.0472" (52mm)
Height 19/32" (15mm)

Order No. 09 - 10303

Spindle bearing replaces Grasshopper 833210.

Roller Bearing for TROY BILT



ID 1-1/4" (31.75mm)
OD 2-21/64" (67.46mm)
Height 21/32" (16.67mm)

Order No. 09 - 10015

Roller bearing replaces Troy Built 11522 & 1715. Fits wheel shaft. Bearing No. LM67048 & LM67010.

Spindle Bearing for EXMARK



ID 1-1/8" (28.58mm)
OD 2-3/16" (55.5mm)
Height 1-1/4" (31.75mm)

Order No. 09 - 13259

Spindle bearing replaces Exmark 109-2064. Without O-ring. Fits Exmark Lazer Z Triton decks.

Needle Bearing for TORO



ID 33/64" (13.10 mm)
OD 11/16" (17.46 mm)
Height 1/2" (12.70 mm)

Order No. 09 - 7674

Needle bearing. Repl. Toro 48-2060. Fits 21" self-propelled commercial transmission and wheel bracket bearing.

Variator Bearing for MTD



ID 9/16" (14.29 mm)
OD 3/4" (19.05 mm)
Height 9/16" (14.29 mm)

Order No. 09 - 7241

Variator bearing. Replaces MTD 741-0404, 941-0404. For variable speed pulley. Fits models 600 & 659, also fits White, Master Cut & Yardman. Used on our 10-7281 shaft.

Needle Bearing for TECUMSEH



ID 5/8" (15.88 mm)
OD 13/16" (20.64 mm)
Height 1/2" (12.70 mm)

Order No. 09 - 8656

Needle bearing replaces Tecumseh 780086A. Fits on all 700 series transmission input shaft. Also fits 800 & 900 series transaxles.

ID 1/2" (12.70 mm)
OD 7/8" (22.23 mm)
Height 29/32" (23.02 mm)



Order No. 09 - 6542

Sleeve and Bearing Assembly. Replaces Lawn-Boy 681904. Used on Lawn-Boy self propelled mowers. MIN010

09 BEARINGS

BEARINGS & BUSHINGS



Jackshaft Spindle Bearing for EXMARK

ID 1" (25.40 mm)
OD 2" (50.8 mm)
Height 1-3/4" (44.45 mm)



Order No. 09 - 11060

Jackshaft spindle bearing replaces Exmark 1-513012. Includes locking collar and set screw.

Spindle Bearing for Exmark

ID 1" (25.40 mm)
OD 2.0475" (52 mm)
Height .708" (18 mm)



Order No. 09 - 12119

Spindle bearing replaces Exmark 103-2477.

Pillow Block Bearing for GRASSHOPPER

ID 1" (25.40 mm)
Length 5-1/2" (76.20 mm)
Overall Height 2-3/4" (69.85 mm)



Order No. 09 - 9160

Pillow block bearing replaces Grasshopper 122044. Fits series 700.

Wheel Bearing for JOHN DEERE

ID .9843" (25mm)
OD 2.0475" (52mm)
Height .590" (15mm)



Order No. 09 - 14279

Wheel bearing replaces John Deere AM102888, Gravely 05435700. 6205-2RSNR.

Roller Bearing for SCAG

ID 1.0625"
OD 1.99"
Height .578"



Order No. 09 - 13092

Tapered roller bearing replaces Scag 481022, replacement bearings for our 10-9153 spindle. Fits models MAG111, SCR, SM, SMST, STR, STT, SW, SWZ, SWLU, SWZU, Sabre Tooth Tiger and Turf Tiger; for 48A, 52A decks. Use 2 per spindle assembly. L44610 & L44649, cup & cone.

Fan Bearing for MURRAY

ID 7/8" (22.2mm)
Height 47/64" (18.7mm)
Keyway 9/16" (14.3mm)



Order No. 09 - 5619

Fan bearing with flange replaces Murray 761507 & MJ761507 & 780048 bearing for snowthrower. Flange with cage measures: 3-3/4" L x 2-3/4" W. Bolt holes are on 3" centers.

Flange Bearing for MTD

ID 3/4" (19mm)
OD .945" (24mm)
Height 1" (25.4mm)



Order No. 09 - 13468

Plastic flange bearing replaces MTD 741-0660A.

MIN010

Flange Bearing for MTD

ID 5/8" (15.8mm)
OD 15/16" (23.8mm)
Height 1" (25.4mm)



Order No. 09 - 13467

Plastic flange bearing replaces MTD 741-0659. Flange OD 1-1/4".

MIN010

Roller Cage Bearing for GRAVELY

ID 3/4" (19.05 mm)
OD 1-1/8" (28.58 mm)
Length 1" (24.5 mm)



Order No. 09 - 8971

Roller cage bearing replaces Gravely 54228. Used on Gravely 71352 wheel assembly. Fits Pro Master 200.

Roller Cage Bearing for SCAG

ID 5/8" (16.66mm)
OD 1-3/8" (34.93mm)
Length 15/16" (23.81mm)



Order No. 09 - 9463

Roller cage bearing replaces Scag 481846. Used with our 08-9605 wheel assembly.

09

BEARINGS



BEARINGS & BUSHINGS

Bearing End Cap for GRAVELY

ID 3/4" (19.05mm)
OD 1-1/2" (38.10mm)
Height 3/8" (9.53mm)



Order No. 09 - 9563

Bearing end cap replaces Gravelly 92027. Fits Gravelly Promaster 200 commercial walkbehind mower. Uses 2 per wheel. Used with our 09-8971 bearing.

Wheel Bearing for WALKER

Overall ID 5/8" (15.88 mm)
Overall OD 1-3/8" (34.93 mm)
Overall Length 3-7/16" (87.33 mm)



Order No. 09 - 8210

Wheel bearing replaces Walker 5714-5. Open cage roller bearing fits front wheel on 36", 42", 48" and 54" "ZERO TURN" machines. Bearing are 5/8" ID (15.88 mm) x 1-3/8" OD (34.93 mm), 2-5/8" length (66.68 mm), bushings are 5/8" ID (15.88 mm) x 1-3/8" OD (34.93 mm). Fits our 08-7982 wheel assembly.



Order No. 09 - 5901

3/8" x 5-5/16" Axle Kit for 16" & 20" Yazoo Mag Wheel.

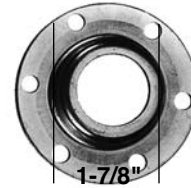

ID 1-5/8" (41.28 mm)
OD 3-9/16" (90.49 mm)

Order No. 09 - 367

Bearing Housing. Replaces MTD 08253B.

Overall ID 5/8" (15.88 mm)
Overall OD 1-3/8" (34.93 mm)
Overall Length 3-15/16" (100.01 mm)



Order No. 09 - 5812

Open cage roller bearing with flanged bushings for our Bobcat 38273 / 38274, Grasshopper and Scag Wheel Assembly 08-3276 . Replaces Scag 48006-06, 48006-07 Snapper 7022394, 7022395. Bearings are 5/8" ID (15.86 mm) x 1-3/8" OD (34.93 mm), 3-1/4" length (82.55 mm). Bushings are 5/8" ID (15.86 mm) x 1-3/8" OD (34.93 mm).

Wheel Bearing Kit for EXMARK

ID 3/4" (19.05 mm)
OD 1-25/32" (45.25mm)



Order No. 09 - 9944

Wheel bearing kit for Exmark. Includes (2) 09-813 bearings, (2) 10-10013 seals, (2) 08-10064 spacers. Fits Laser Z units. Used in our 08-9803, 08-9804 & 08-9809 wheel assembly.

Bearing Kit for SNAPPER



Order No. 09 - 8661

Right hand bearing kit replaces Snapper 7060278. Fits 26" thru 33" cut riding mowers. Kits includes our 09-6864 rear axle bearing, 20-3453 clamp, 10-7919 seal cap & 05-8632 oil seal.

Caster Wheel Bearing Kit



Order No. 09 - 7780

Replaces wheel bearing kit for our Bobcat, Grasshopper & Scag wheel assembly 08-3276. Comes with (2) 09-481 high speed 5/8" (15.88 mm) bearings, (2) 10-7779 21/32" (16.67 mm) x 1-1/8" (28.58 mm) washer and (1) 09-7262 5/8" OD (15.88 mm) x 4-1/16" (103.19 mm) bushing.

Front End Repair Kit for SNAPPER



Order No. 10 - 8322

Front end repair kit for Snapper rear engine riders.

Roller Cam Assembly for AYP



Order No. 09 - 9747

Roller cam assembly replaces AYP 155066. Assembly for AYP 42" Deck. Used with our 10-8830 shoulder bolt.

MIN005

BEARINGS & BUSHINGS



Wheel Bearing Kit for DIXIE CHOPPER

Order No. 09 - 9719

Wheel bearing kit for Dixie Chopper. Fits Dixie Chopper 10202 & 97166 wheel assemblies. Also fits our **08-9501** & **08-9573** wheel assemblies. Kit contains (2) **09-7950** bearings, and (2) **09-8198** bearings, and (1) **09-9709** wheel bushing.



Over all ID 5/8" (15.88mm)
Over all OD 1-3/8" (34.93mm)
Over all Length 4" (101.6mm)

Wheel Bearing Kit for BOBCAT

Order No. 09 - 8664

Wheel bearing kit replaces Bobcat 38058N (roller cage bearing) & 38025N (retainers). Fits Bobcat 38096C wheel assembly. Fits our **08-905** wheel assembly.

Order No. 09 - 9041

Roller cage bearing only for Bobcat. Replaces Bobcat 38058N. Used on our **08-905** wheel assembly. OD 1-3/8" (34.92 mm), ID 7/8" (22.22 mm), Length 2-1/2" (63.50 mm).

Order No. 09 - 9011

Retainer bushing only for Bobcat. Replaces Bobcat 38025N. Used on our **08-905** wheel assembly. OD 1-1/2" (38.10 mm), ID 7/8" (22.22 mm).

ID 7/8" (22.23 mm)
OD 1-3/8" (34.93 mm)
Overall Length 6-7/16" (163.51 mm)



Wheel Bearing Kit for BOBCAT

Order No. 09 - 5848

Open cage roller bearing with flanged bushings for our Bobcat Wheel Assembly **06-3239**. Bearing 38069N, Cap 38042N.

Order No. 09 - 9006

Roller cage bearing only for Bobcat. Used on our Bobcat **06-3239** wheel assembly. OD 1-21/64" (33.73 mm), ID 21/32" (16.66 mm), Length 1-7/16" (36.51 mm).

Order No. 09 - 9007

Retainer bushing only for Bobcat. Used on our Bobcat **06-3239** wheel assembly. OD 1-1/2" (38.10 mm), ID 5/8" (15.87 mm).

Overall ID 5/8" (15.88 mm)
Overall OD 1-13/32" (35.72 mm)
Overall Length 2-7/32" (56.36 mm)



Wheel Bearing Kit for DIXON

Order No. 09 - 8433

Roller cage bearing with retainer bushings replaces Dixon 8179, 539116801. Fits 42" & 50" cut Dixon ZTR with single arm caster wheel. Fits Dixon wheel 8178.

Order No. 09 - 9008

Roller cage bearing only for Dixon. Used on Dixon 8178, 539116800 wheel assembly. OD 1-3/8" (34.92 mm), ID 1" (25.40 mm), Length 2-1/2" (63.50 mm).

Order No. 09 - 9009

Retainer bushing only for Dixon. Used on Dixon 8180, 539116802 wheel assembly. OD 1-1/2" (38.10 mm), ID 1" (25.40 mm).

Overall ID 1" (25.40 mm)
Overall OD 1-3/8" (34.93 mm)
Overall Length 3-3/16" (80.96 mm)



09

BEARINGS



BEARINGS & BUSHINGS

Wheel Bearing Kit for SCAG

Overall ID 1/2" (12.70 mm)
Overall OD 1-3/8" (34.93 mm)
Overall Length 4-1/16" (103.19 mm)

Order No. 09 - 8318

Wheel bearing kit for Scag. Used on our Scag wheel assembly **09-3276**. Contains our **09-5812** open cage roller bearing and **09-7262** bushing. Fits our **08-3276, 08-8580** Wheels.

Order No. 09 - 8994

Roller cage bearing only for Scag. Used on our Scag wheel assembly **08-3276**. OD 1-3/8" (34.93 mm), ID 5/8" (15.86 mm), Length 3-1/4" (82.55 mm).

Order No. 09 - 8995

Retainer bushing only for Scag. Used on our Scag wheel assembly **08-3276**. OD 1-3/8" (34.93 mm), ID 5/8" (15.86 mm).



Wheel Bearing Kit for SCAG

Over all ID 21/32" (16.67mm)
Over all OD 1-3/8" (34.93mm)
Over all Length 6" (152.4mm)

Order No. 09 - 9701

Wheel bearing kit for Scag. Fits Scag 481551 front caster wheel assembly. Used on "ZERO TURN" Turf Tiger Model. Kit contains our **09-9702** roller cage bearing with retainer bushings and our **09-9613** spanner bushing.

Order No. 09 - 9702

Roller cage bearing with bushings only. Fits Scag 481551 front caster wheel assembly. Roller cage bearing OD 1-1/4" (31.75mm), ID 21/32" (16.66mm), Length 15/16" (23.81mm). Retainer bushings OD 1-3/8" (34.93mm), ID 5/8" (15.86mm), Height 1/2" (12.70mm)



Wheel Bearing Kit for SCAG

Over all ID 5/8" (15.88mm)
Over all OD 1-27/64" (36.12mm)
Over all Length 5-3/8" (136.53mm)

Order No. 09 - 11720

Wheel bearing kit for Scag. Fits our **08-9605** Wheel.



Wheel Bearing Kit for WALKER

Overall ID 3/8" (9.53 mm)
Overall OD 1-3/8" (34.93 mm)
Overall Length 3-9/16" (90.49 mm)

Order No. 09 - 8319

Wheel bearing kit for Walker. Fits front wheel on 36", 42", 48" and 54" "ZERO TURN" machines. Kit contains our **09-8210** bearing and **09-8076** spacer. Fits our **08-7982 & 08-10162** wheel assembly.

Order No. 09 - 8995

Retainer bushing only for Scag. Used on our Scag wheel assembly **08-3276**. OD 1-3/8" (34.93 mm), ID 5/8" (15.86 mm).

Order No. 09 - 8996

Roller cage bearing only for Walker. Replaces Walker 5714-5. Used on our Walker wheel assembly **08-7982**. OD 1-3/8" (34.93 mm), ID 5/8" (15.86 mm), Length 2-5/8" (66.68 mm).



09

BEARINGS



BEARINGS & BUSHINGS

Wheel Bearing Kit for EXMARK

Overall ID 1/2" (12.70 mm)
Overall OD 1-3/8" (34.93 mm)
Overall Length 4-21/32" (118.27 mm)

Order No. 09 - 8438

Wheel bearing kit for Exmark. Fits Exmark midsize mowers with 36", 48", 52", 60" decks. Fits Exmark wheel 1-322154. Fits Turf Ranger, Turf Tracer & Viking metro models from 80000 series and higher. Kit contains our **09-8408** roller cage bearing with retainer bushings and **09-8409** spanner bushing.



Order No. 09 - 8408

Roller cage bearing with retainer bushings only. Replaces Exmark 1-513809. Roller cage bearing OD 1-1/4" (31.75 mm), ID 49/64" (19.45 mm), Length 3-23/32" (94.46 mm). Retainer bushings OD 1-1/2" (38.10 mm), ID 3/4" (19.05 mm), Height 3/8" (9.53 mm).

Order No. 09 - 8999

Retainer bushing only for Exmark. Used on Exmark 1-3322154 wheel assembly & our **08-8197** wheel assembly for Gravelly. OD 1-1/2" (38.10 mm), ID 3/4" (19.05 mm).

Order No. 09 - 8998

Roller cage bearing only for Exmark. Replaces Exmark 1-513809. OD 1-1/4" (31.75 mm), ID 49/64" (19.45 mm), Length 3-23/32" (94.46 mm).

Order No. 09 - 8409

Spanner bushing only. Replaces Exmark 1-513547. OD 3/4" (19.05 mm), ID 1/2" (12.70 mm), Length 4-5/8" (117.48 mm).

Wheel Bearing Kit for TORO

Overall ID 1/2" (12.70 mm)
Overall OD 1-3/8" (34.93 mm)
Overall Length 3-11/32" (84.93 mm)

Order No. 09 - 8441

Wheel bearing kit for Toro. Fits Toro wheel 68-8970 front caster wheel assembly. Fits Toro mid size mower 36", 37", 44", 52" & 62" cut decks, models 30136, 30137, 30144, 30152, 30162. Kit contains our **09-8440** bearing, **09-9003** retainer bushings and **09-8420** spanner bushing.



Order No. 09 - 8440

Roller cage bearing with retainer bushings only. Replaces Toro bearing 62-5570 & bushing 62-5580. Roller cage bearing OD 1-1/4" (31.75 mm), ID 3/4" (19.05 mm), Length 1-11/16" (42.86 mm). Retainer bushings OD 1-3/8" (34.93 mm), ID 3/4" (19.05 mm), Height 5/8" (15.88 mm).

Order No. 09 - 9003

Retainer bushing only for Toro. Replaces Toro 62-5580. Used on Toro 68-8970 front caster wheel assembly. OD 1-3/8" (34.93 mm), ID 3/4" (19.05 mm).

Order No. 09 - 9002

Roller cage bearing only for Toro. Replaces Toro 62-5570. Used on Toro 68-8970 front caster wheel assembly. OD 1-1/2" (38.10 mm), ID 3/4" (19.05 mm), Length 1-11/16" (42.86 mm).

Order No. 09 - 8420

Spanner bushing only. Replaces Toro 68-8980. OD 3/4" (19.05 mm), ID 1/2" (12.70 mm), Length 3-11/32" (84.93 mm). Uses our bushing **09-8684**

Wheel Bearing Kit for GRAVELY

Overall ID 1/2" (12.70 mm)
Overall OD 1-3/8" (34.93 mm)
Overall Length 3-21/64" (84.53 mm)

Order No. 09 - 8439

Wheel bearing kit for Gravelly. Fits Gravelly 45205 front caster wheel assembly. Fits 40" & 50" cut mowers. Kit contains our **09-8404** roller cage bearing with retainer bushings and **09-8420** spanner bushing. Fits our **08-8197** wheel assembly.



Order No. 09 - 8404

Roller cage bearing with retainer bushings only for Gravelly 45205 front caster wheel assembly. Roller cage bearing OD 1-1/4" (31.75 mm), ID 3/4" (19.05 mm), Length 2-1/2" (63.50 mm). Retainer bushings OD 1-3/8" (34.93 mm), ID 3/4" (19.05 mm), Height 3/8" (9.53 mm).

Order No. 09 - 8999

Retainer bushing only for Exmark. Used on Exmark 3322154 wheel assembly & our **08-8197** wheel assembly for Gravelly. OD 1-1/2" (38.10 mm), ID 3/4" (19.05 mm).

Order No. 09 - 9000

Roller cage bearing only for Gravelly. Used on our Gravelly wheel assembly **08-8197**. OD 1-1/4" (31.75 mm), ID 3/4" (19.05 mm), Length 2-1/2" (63.50 mm).

Order No. 09 - 8420

Spanner bushing only. Replaces Gravelly 11950. OD 3/4" (19.05 mm), ID 1/2" (12.70 mm), Length 3-11/32" (84.93 mm).

09

BEARINGS



Wheel Bearing Kit for VELKE

Order No. 09 - 8670

Wheel bearing kit fits Velke "Sulky" VKBRGKIT midsize commercial mowers. Kit contains our **09-8434** spacer, **09-8668** roller bearing with (2) retainer bushings. Fits our **08-8575** wheel assembly.

Order No. 09 - 8668

Roller cage bearing with retainer bushings only. Roller cage bearing ID 25/32" (19.84 mm), OD 1-11/32" (34.13 mm), Length 2-15/16" (74.61 mm). Retainer bushings ID 49/64" (19.45 mm), OD 1-25/64" (35.32 mm), Height 3/8" (9.53 mm).

Order No. 09 - 9117

Roller cage bearing only for Velke. Replaces Velke VKRLBRG. Used on our **08-8575** wheel assembly. OD 1-11/32" (34.13 mm), ID 25/32" (19.84 mm), Length 2-15/16" (74.61 mm).

Order No. 09 - 8434

Spanner bushing only replaces Velke VKSPNNR. ID 1/2" (12.70 mm), OD 47/64" (18.65 mm), Length 4" (101.6 mm).



Wheel Bearing Kit for VELKE

Order No. 09 - 9276

Wheel bearing kit replaces Velke VKXGBRGKIT. Fits Velke (2) wheel mowers. Kit contains our **09-9275** roller cage bearing, **09-9009** retainers & **09-9274** spanner bushing. Fits our **08-9260** wheel assembly. Overall ID 3/4" (19.05 mm), OD 1-3/8" (34.93mm), Length 2.7" (68.58 mm).

Order No. 09 - 9275

Roller cage bearing only replaces Velke VKXRLBRG. Fits our **08-9260** wheel assembly. ID 1" (25.4 mm), OD 1-3/8" (34.93mm), Length 1-1/2" (38.1 mm).

Order No. 09 - 9274

Spanner bushing only replaces Velke VKXSPNNR. Fits our **08-9260** wheel assembly. ID 3/4" (19.05 mm), OD 1" (25.4 mm), Length 2-3/4" (44.4 mm).



Wheel Bushing for EXMARK

ID 3/8" (9.53 mm)
OD 5/8" (15.88 mm)
Length 2-13/16" (71.44 mm)
Flange OD 1" (25.40 mm)



Order No. 09 - 8586

Wheel bushing replaces Exmark 61-03602. Fits in wheel 603299 on Exmark commercial mowers. Models Turf Ranger, Turf Tracer Explorer.

Wheel Spacer for WALKER

ID 3/8" (9.53 mm)
OD 5/8" (15.88 mm)
Length 3-1/2" (88.90 mm)



Order No. 09 - 8076

Wheel spacer replaces Walker 5714-3. Used in our **09-8319** Wheel Bearing Kit. Fits our **08-7982** Wheel Assembly.

Tube Bearing for GRASSHOPPER

ID 3/8" (9.5mm)
OD 5/8" (15.8mm)
Length 3.44" (87.4mm)



Order No. 09 - 14060

Tube bearing replaces Grasshopper 942137.

Spacer Roller for GRASSHOPPER

ID 3/8" (9.5mm)
OD 5/8" (15.8mm)
Length 2.04" (51.8mm)



Order No. 09 - 14059

Spacer roller mount replaces Grasshopper 902284.

09

BEARINGS



BEARINGS & BUSHINGS

Spacer for EXMARK

ID 1/2" (12.70mm)
OD 3/4" (19.05mm)
Length 7-1/2" (190.50mm)



Order No. 09 - 9992

Spacer replaces Exmark 1-633959 & Scag 43583. Fits Exmark Laser Z 13 x 650 x 6 wheels. Used with our **08-10075** wheel.

Inner Wheel Spacer for DIXIE CHOPPER

ID 5/8" (15.8mm)
OD 7/8" (22.2mm)
Length 2" (50.8mm)



Order No. 09 - 9709

Inner wheel spacer replaces Dixie Chopper 67204. Fits Dixie Chopper wheel assembly models 10202 & 97166. Also used on our **08-9573** & **08-9501** wheel assemblies. Included in our **09-9719** wheel bearing kit.

Front Wheel Spacer for EXMARK

ID 3/4" (19.05mm)
OD 1-1/8" (28.58mm)
Width 5/8" (15.88mm)



Order No. 09 - 10064

Front wheel spacer replaces Exmark 1-633581 & Scag 43584. Fits Lazer Z units. Fits our **08-9803**, **08-9804** & **08-9809** wheels. Spacer for front wheel, bearing & seal.

Spacer for EXMARK

ID 1/2" (12.70mm)
OD 3/4" (19.05mm)
Length 5-7/8" (149.22mm)



Order No. 09 - 10017

Spacer replaces Exmark 1-633579, Scag 43581. Fits Exmark Laser Z 13 x 500 x 6 wheels. Used with our **08-9804** wheel.

Wheel Bushings for GRAVELY



Order No. 09 - 8485

Wheel bushing replaces Gravely 11387. Fits 40" commercial center mount mower models. Used on our **06-5915** Wheel Assembly. ID 1/2" (12.70 mm), OD 3/4" (19.05 mm), Length 2-5/8" (66.68 mm).

Wheel Bushing for SNAPPER

ID 7/16" (11.13 mm)
OD 9/16" (14.29 mm)
Length 1-5/8" (41.28 mm)



Order No. 09 - 2907

Replaces Snapper 7012309. Wheel Bushing for our **07-2991**, **07-2992** & **07-855**, **07-8927**, **07-8927**, **07-8928**, **07-8929**, **07-8931**.
MIN010

Wheel Bushing for SCAG

ID 1/2" (12.70 mm)
OD 5/8" (15.88 mm)
Height 4-1/16" (103.19 mm)



Order No. 09 - 7262

Wheel Bushing. Replaces Scag 43022 & Snapper 7022151. Also fits Bobcat 14380. Used in our wheel bearing assembly **09-5812**.

Steel Wheel Bushings



Order No. 09 - 330

3/8" (9.53 mm) ID x 1/2" (12.70 mm) OD sleeve, 2-3/16" (55.56 mm) Length. MIN010

Order No. 09 - 331

7/16" (11.11 mm) ID x 1/2" (12.70 mm) OD sleeve, 2-3/16" (55.56 mm) Length. MIN010

Order No. 09 - 332

1/2" (12.70 mm) ID x 5/8" (15.88 mm) OD sleeve, 3-1/4" (82.55 mm) Length. MIN010

09

BEARINGS



BEARINGS & BUSHINGS

Spanner Bushing for JOHN DEERE

ID 1/2" (12.70 mm)
OD 3/4" (19.05 mm)
Length 5-9/16" (141.28 mm)



Order No. 09 - 8707

Spanner bushing replaces John Deere M84516. Fits John Deere AM101589, 11 x 400 x 5 caster wheel. Spanner bushing for our 08-8551 wheel assembly. Fits our 08-10742.

ID 1/2" (12.70 mm)
OD 3/4" (19.05 mm)
Length 4-9/16" (115.89 mm)



Order No. 09 - 8706

Spanner bushing replaces John Deere M91080. Fits John Deere AM115510, 9 x 350 x 4 caster wheel. Spanner bushing for our 08-8550 wheel assembly. ID 1/2" (12.70 mm), OD 3/4" (19.05 mm), Length 4-9/16 (115.89 mm).

Spanner Bushing for SCAG

ID 1/2" (12.70 mm)
OD 5/8" (15.86 mm)
Length 6" (152.4 mm)



Order No. 09 - 9613

Spanner bushing replaces Scag 43430. Fits Scag turf tiger mowers. Used with our 08-9605 wheel assembly.

Spanner Bushing for DIXIE CHOPPER

ID 5/8" (15.86 mm)
OD 7/8" (22.23 mm)
Length 1" (25.4 mm)



Order No. 09 - 9606

Spanner bushing replaces Dixie Chopper 10203. Fits our 08-9573 wheel assembly.

Spanner Bushing for BOBCAT

ID 3/4" (19.05 mm)
OD 1" (25.40 mm)
Length 3-1/2" (88.90 mm)



Order No. 09 - 7839

Wheel bushing replaces Bobcat 43037A. Fits our 08-3277 and 06-3278 wheel assemblies.

Bearing Spacer for HUSTLER

ID 3/4" (19mm)
OD 1" (25.4mm)
Length 6-1/4" (152mm)



Order No. 09 - 14133

Bearing spacer replaces Hustler 782771. Used with our 09-11835 bearings.

Bushing for AYP

ID 3/8" (9.53 mm)
OD 1/2" (12.70 mm)
Height 3/8" (9.53 mm)
Flange OD 5/8" (15.88 mm)



Order No. 09 - 853

Tie Rod Bushing Snapper 13321, nylon.

MIN010

Bushing for AYP

ID 3/8" (9.53 mm)
OD 17/32" (13.49 mm)
Height 15/32" (11.91 mm)
Flange OD 11/16" (17.46 mm)



Order No. 09 - 7279

Draglink bushing for front engine riders. Replaces AYP 126847X. MIN004

Order No. 09 - 329

Wheel Bushing, nylon.

MIN010

ID 1/2" (12.70 mm)
OD 5/8" (15.88 mm)
Height 5/8" (15.88 mm)
Flange OD 3/4" (19.05 mm)



Order No. 09 - 382

Replaces MTD 748-0108 & 948-0108, bronze.

ID 1/2" (12.70 mm)
OD 3/4" (19.05 mm)
Height 19/32" (15.08 mm)
Flange OD 1" (25.40 mm)



09

BEARINGS

BEARINGS & BUSHINGS



ID 1/2" (12.70 mm)
OD 3/4" (19.05 mm)
Height 3/4" (19.05 mm)
Flange OD 15/16" (23.81 mm)

Order No. 09 - 3216

Replaces Air Cap / K&S T16276, 3999. Bronze bushing. Velke Sulky Wheel Bearing.



ID 1/2" (12.70 mm)
OD 3/4" (19.05 mm)
Height 1" (25.4 mm)
Flange OD 15/16" (23.81 mm)

Order No. 09 - 8654

Hitch bushing replaces Velke VHITCHBUSH. Fits Velke 9 x 350 x 4 caster wheel on all one wheel mowers.



ID 1/2" (12.70mm)
OD 1-1/8" (28.58mm)
Height 1/4" (6.35mm)

Order No. 09 - 9502

Engine mount bushing replaces MTD 922-0153. Fits 600 series riders. Nylon. MIN010



ID 5/8" (15.88 mm)
OD 11/16" (17.46 mm)
Height 5/8" (15.88 mm)
Flange OD 1" (22.40 mm)

Order No. 09 - 2939

Replaces Snapper 7010694. Steering Bushing (Bottom) nylon. MIN010



ID 5/8" (15.88 mm)
OD 3/4" (19.05 mm)
Height 3/4" (19.05 mm)
Flange OD 1" (25.40 mm)

Order No. 09 - 3213

Replaces MTD 748-0867 and Tecumseh 780105A. Fits all 700 series transmissions 3 & 5 speed output shaft. Also fits 800 & 900 series transaxles. Oil impregnated, bronze.



ID 5/8" (15.88 mm)
OD 3/4" (19.05 mm)
Height 3/4" (19.05 mm)
Flange OD 1-1/8" (28.58 mm)

Order No. 09 - 3201

Flange Bearing. Replaces MTD 748-0184, bronze.



ID 5/8" (15.88 mm)
OD 3/4" (19.05 mm)
Height 1" (25.40 mm)
Flange OD 1-1/4" (31.75 mm)

Order No. 09 - 3209

Flange Bearing. Replaces MTD 748-0855.



ID 5/8" (15.88 mm)
OD 13/16" (20.64 mm)
Height 1" (25.40 mm)

Order No. 09 - 7720

Nylon wheel bushing. Replaces MTD 741-0487A & 941-0487A. Fits MTD rider models 530-568 and 600-658. MIN010



ID 5/8" (15.88 mm)
OD 7/8" (22.23 mm)
Height 5/8" (15.88 mm)

Order No. 09 - 7836

King pin nylon bushing replaces MTD 941-0225. Fits 38" and 42" cut front engine riders. MIN010



ID 5/8" (15.88 mm)
OD 7/8" (22.23 mm)
Height 5/8" (15.88 mm)
Flange OD 1-1/8" (28.58 mm)

Order No. 09 - 293

Flange Bearing. Replaces MTD 748-0110 & 948-0110, bronze.



ID 5/8" (15.88 mm)
OD 1" (25.40 mm)
Height 5/8" (15.88 mm)

Order No. 09 - 11833

Deck pin bushing replaces Walker 5740-2. Fits 36", 42", 48" & 54" decks. Takes 4 per unit. MIN01004



ID 5/8" (15.88 mm)
OD 7/8" (22.23 mm)
Height 5/8" (15.88 mm)

Order No. 09 - 3202

Flange Bearing. Replaces MTD 748-0227A, 748-0227 & 948-0227A (Hex Nut), bronze.

09

BEARINGS



BEARINGS & BUSHINGS



ID 5/8" (15.88 mm)
OD 7/8" (22.23 mm)
Length 1-11/16" (15.88 mm)

Order No. 09 - 2892
Bushings only for our 10-2925.

Hex Steering Bushing for MTD



ID 5/8"
OD 7/8"
Height 1/4"

Order No. 09 - 13229
Hex steering bushing replaces MTD 741-0656, 941-0656A.



ID 5/8" (15.88 mm)
OD 1-1/8" (28.58 mm)
Height 3/4" (19.05 mm)
Flange OD 1-1/4" (31.75 mm)

Order No. 09 - 2936
Replaces Murray 24615. Also fits Roof front wheels. Graphite Impregnated.



ID .635" (16.13 mm)
OD .817" (20.75 mm)
Length 1" (25.4 mm)
Flange OD 1-1/4" (31.7 mm)

Order No. 09 - 12856
Wheel bushing replaces MTD 941-0706 & 741-0706, with grease fitting. MIN010

Flanged Wheel Bushing for MURRAY



ID 5/8" (15.88 mm)
OD 1-3/8" (34.93 mm)
Height 45/64" (17.86 mm)

Order No. 09 - 9044
Flanged wheel bushing replaces Murray 56105. Fits Murray riders. Nylon

Steering Shaft Bushing for JOHN DEERE



ID .625" (15.8mm)
OD .900" (22.8mm)
Height .870" (22.0mm)

Order No. 09 - 14557
Steering shaft bushing replaces John Deere GX21994. Fits L100 series, Sabre & Scotts models. Flange OD 1" MIN005



ID 3/4" (19.05 mm)
OD 13/16" (20.64 mm)
Height 9/16" (14.29 mm)
Flange OD 1-1/4" (31.75 mm)

Order No. 09 - 854
King Pin Bushing Snapper 10986, nylon. MIN010

Auger Bushing for NOMA



ID 43/64" (17.07 mm)
OD 1-7/8" (47.63 mm)
Length 3-3/4" (95.25 mm)

Order No. 09 - 9046
Auger bushing replaces Noma 54837. Fits Noma snow throwers.

Bushing for ARIENS



ID 3/4" (19.05 mm)
OD 7/8" (22.23 mm)
Height 21/32" (16.67 mm)
Flange OD 1-3/16" (30.16 mm)

Order No. 09 - 8783
Bushing replaces Ariens 55216. Fits newer snowblower models ST-524 & ST-724. Oil impregnated, iron.

King Pin Bushing for AYP



ID 3/4" (19.05mm)
OD 53/64" (21.83mm)
Height 25/32" (19.84mm)
Flange OD 1-1/8" (28.58mm)

Order No. 09 - 9745
King pin bushing replaces AYP 121922x. MIN010



ID 3/4" (19.05mm)
OD 1" (25.4mm)
Height 1" (25.4mm)

Order No. 09 - 9109
Front wheel bushing replaces Stiga 1134-1875-01. Bronze.

Bushing for MURRAY



ID 3/4" (19.05mm)
OD 7/8" (22.23mm)
Height 11/16" (17.46mm)
Flange OD 1-1/8" (28.58mm)

Order No. 09 - 9746
Flange bushing replaces Murray 90035. Fits front axle spindle bearing on Murray Pre-1991 tractors. MIN010

09

BEARINGS

BEARINGS & BUSHINGS



ID 3/4" (19.05 mm)
OD 1" (25.40 mm)
Height 5/8" (15.88 mm)

Order No. 09 - 8445

Snowblower axle bushing replaces Ariens 55039 & John Deere M127082. Fits older Ariens **snowblowers** model 1032. Oil impregnated, bronze.



ID 3/4" (19.05 mm)
OD 1" (25.4 mm)
Length 1-3/8"(34.9 mm)
Flange OD 1-1/16" (25.5 mm)

Order No. 09 - 12857

Wheel bushing replaces MTD 741-0990A, with grease fitting. MIN010



ID 3/4" (19.05 mm)
OD 1" (25.40 mm)
Height 3/4" (19.05 mm)
Flange OD 1-3/8" (34.93 mm)

Order No. 09 - 8306

Spindle bearing replaces AMF/Dynamark 52407. Used on 39" cut, 12 hp, front engine rider models 3912-081 & 082.



ID 3/4" (19.05 mm)
OD 1" (25.40 mm)
Height 3/4" (19.05 mm)
Flange OD 1-1/4" (31.75 mm)

Order No. 09 - 3211

Replaces MTD 741-0293 & 941-0293, nylon.



ID 3/4" (19.05 mm)
OD 1" (25.40 mm)
Height 1-15/16" (49.21 mm)
Flange OD 1-1/8" (28.58 mm)

Order No. 09 - 3222

Flange Bearing. Replaces MTD 748-0169 & 948-0169. Graphite Impregnated.



ID 3/4" (19.05 mm)
OD 1" (25.40 mm)
Height 1-3/16" (30.16 mm)

Order No. 09 - 5721

Replaces Ransomes/Bobcat 33050. Used on our support arm 10-2218.



ID 3/4" (19.05 mm)
OD 1-1/8" (28.58 mm)
Height 3/4" (19.05 mm)
Flange OD 1-1/4" (31.75 mm)

Order No. 09 - 2935

Replaces Murray 403010 & Bobcat 148048-01. Graphite Impregnated. Also replaces Gilson 24829.



ID 3/4"(19.05 mm)
OD 1-3/8"(34.90 mm)
Height 1" (25.40 mm)

Order No. 09 - 13359

Wheel bearing/bushing replaces AYP 9040H / 532009040.



ID 3/4" (19.05 mm)
OD 1-1/4" (31.75 mm)
Height 3/4" (19.05 mm)
Flange OD 1-3/8" (34.93 mm)

Order No. 09 - 3200

Replaces MTD 741-0199, nylon.



ID 3/4" (19.05 mm)
OD 1-3/8" (34.90 mm)
Height 1/2" (12.70 mm)
Flange OD 1-9/16" (39.69 mm)

Order No. 09 - 3303

Replaces AMF 54902. Flange Bearing. Graphite Impregnated.



ID 3/4" (19.05 mm)
OD 1-3/8" (34.93 mm)
Height 5/8" (15.88 mm)
Flange OD 1-1/2" (38.10 mm)

Order No. 09 - 339

Replaces AMF 39979. Also fits many Sears. Graphite Impregnated.



ID 3/4" (19.05 mm)
OD 1-3/8" (34.93 mm)
Height 3/4" (19.05 mm)
Flange OD 1-9/16" (39.69 mm)

Order No. 09 - 3305

Replaces AMF 40195. Spindle Bearing. Graphite Impregnated.



ID 3/4" (19.05 mm)
OD 1-3/8" (34.93 mm)
Height 1" (25.40 mm)

Order No. 09 - 7258

Front wheel bushing. Replaces Murray 91334 & 491334. Used on 36", 38" and 40" front engine rider. (Plastic)



ID 3/4" (19.05 mm)
OD 1-1/4" (31.75 mm)
Height 5/8" (15.88 mm)

Order No. 09 - 11834

Deck pin bushing replaces Walker 8740. Fits 52" & 62" decks. Takes 4 per unit. MIN004

09

BEARINGS



BEARINGS & BUSHINGS



ID 3/4" (19.05 mm)
 Top OD 1-3/4" (44.45 mm)
 Bottom OD 1-5/8" (41.26 mm)
 Top Height 1" (25.40 mm)
 Overall Height 1-3/4" (44.45 mm)

Order No. 09 - 6863

Left side Rear Axle Bushing with grease fitting. Replaces Snapper 7050918. For 26" thru 33" rear engine riders.



ID 7/8" (22.23 mm)
 OD 1" (25.40 mm)
 Height 5/8" (15.88 mm)
 Flange OD 1-1/4" (31.75 mm)

Axle Bushing for ARIENS

Order No. 09 - 8796

Axle bushing replaces Ariens 55030. Fits snowblower models 910 & 924. Bronze



ID 7/8" (22.23 mm)
 OD 1-1/8" (28.58 mm)
 Height 1" (25.40 mm)
 Flange OD 1-1/2" (88.10 mm)

Order No. 09 - 5713

Replaces Scag 48100-01 & Snapper 7076514. Used on our 10-8189, support arm, Scag 46082 support arm. Also fits Encore 363007, also replaces Velke VPIVOT pivot bushing.



ID 7/8" (22.23 mm)
 OD 1-1/8" (28.58 mm)
 Height 1-1/4" (31.75 mm)

Order No. 09 - 5703

Replaces Bunton PLO 928 used on Bunton support arm PAL-0937A, Exmark 1-303041 and Snapper/Kees 76515.



ID 7/8" (22.23 mm)
 OD 1-1/8" (28.58 mm)
 Height 1-1/4" (31.75 mm)
 Flange OD 1-1/2" (38.10 mm)

Order No. 09 - 8305

Caster yoke support arm bushing replaces Exmark 1-303514, 1-303044, Snapper 7076514, Kees 363194, Scag 48100-01.



ID 7/8" (22.23 mm)
 OD 1-3/8" (34.93 mm)
 Height 1" (25.40 mm)

Front Wheel Bushing for MURRAY

Order No. 09 - 7716

Front wheel bushing. Replaces Murray 93064. Fits 18 hp Murray lawn tractors. Nylon



ID 29/32" (23.02 mm)
 OD 31/32" (24.61 mm)
 Height 5/8" (15.88 mm)
 Flange OD 1-1/4" (31.75 mm)

Order No. 09 - 2940

Replaces Snapper 12617. Steering Bushing (Top) nylon. MIN010



ID 15/16" (23.81 mm)
 OD 1-1/4" (31.75 mm)
 Height 11/16" (17.46 mm)
 Flange OD 1-5/8" (41.28 mm)

Deck Support Bushing for EXMARK

Order No. 09 - 8984

Deck support bushing replaces Exmark 1-513336. Fits models Turf Ranger. (nylon) (black)



ID 1" (25.40 mm)
 OD 1-1/8" (28.58 mm)
 Height 5/8" (15.88 mm)

Order No. 09 - 8446

Snowblower auger bushing replaces Ariens 55035 & John Deere M124417. Fits all auger side bushings models 1960 to present. Oil impregnated, bronze.



ID 1" (25.4 mm)
 OD 1-1/4" (31.7 mm)
 Height 19/32" (15.0 mm)

King Pin Bushing for MTD

Order No. 09 - 9327

King pin bushing replaces MTD 741-0374. Fits MTD model 406 rear tine tiller. Lower chain case bearing on tiller. Flanged OD 1-1/2". (nylon)



ID 1" (25.40 mm)
 OD 1-1/4" (31.75 mm)
 Height 3/4" (19.05 mm)
 Flange OD 1-5/8" (41.26 mm)

Order No. 09 - 5707

Replaces Ransomes/Bobcat 48053-2A. Used on Bobcat support arm 46102C. Used on our 10-8181 & 10-6580 support arm. Fits Snapper 7023556, Pro 7. Also fits Ferris 20822. Bronze



ID .9845" (25 mm)
 OD 1-1/4" (31.75 mm)
 Height 1" (25.40 mm)
 Flange OD 1-3/4" (44.45 mm)

Order No. 09 - 8366

Bushing replaces John Deere M70808, M93523. Fits Gator riding commercial 900 series 316 thru 430, F510, F525, F915, F935 & Homeowner models. Also fits front mount mowers models F700 & F900 series. Steel

09 BEARINGS

BEARINGS & BUSHINGS



Yoke Bushing for GRAVELY



ID 1" (25.40 mm)
OD 1-3/8" (34.93 mm)
Height 3/4" (19.05 mm)
Flange OD 1-3/4" (44.45 mm)

Order No. 09 - 8522

Yoke bushing replaces Gravelly 18355. Yoke bushing on models Promaster, Pro 40, Pro 50, Pro 200, Pro 100, nylon.
MIN010

ID 1" (25.40 mm)
OD 1-1/4" (31.75 mm)
Height 1" (25.40 mm)
Flange OD 1-3/4" (44.45 mm)



Order No. 09 - 8240

Caster bushing replaces Bunton PJH 1060 & Bobcat 48053-2A, Snapper 7023556. Fits all mid size hydro and belt driven mowers. Also fits John Deere M83541.

Bushing for WALKER



ID 1" (25.40 mm)
OD 1-1/4" (31.75 mm)
Height 1-1/4" (31.75 mm)
Flange OD 1-1/2" (38.10 mm)

Order No. 09 - 8211

Caster bushing replaces Walker 5683. Fits all 36", 42", 48", 54" and 62" Walker "ZERO TURN" mowers. Metal

Caster Yoke Bushing for GRASSHOPPER



ID 1" (25.40 mm)
OD 1-1/4" (31.75 mm)
Height 3-1/16" (77.79 mm)
Flange OD 1-1/2" (38.10 mm)

Order No. 09 - 8513

Caster yoke bushing replaces Grasshopper 833260. Fits rider models 612, 616, 2144, 6144, 9044, 9148, 9048, 9052, 9061, 9244, 9252, 9261, 9372, 9272. Oil impregnated.



ID 1-1/8" (28.58 mm)
OD 1-5/8" (41.28 mm)
Height 1-1/2" (38.10 mm)
Flange OD 1/4" (6.35 mm)

Order No. 09 - 6864

Right side Rear Axle Bushing. Replaces Snapper 12296. For 26" thru 33" rear engine riders.



ID 1-1/8" (28.58 mm)
OD 1-3/8" (34.93 mm)
Height 1" (25.40 mm)

Order No. 09 - 8476

Yoke bushing replaces Toro 28-9290, Scag 48100-02. Fits Toro midsize mowers 36", 37", 44", 52", 62" cut. Deck models 30136, 30137, 30144, 30152, 30162.

Deck Mount Bushing for GRASSHOPPER



Length 1-5/8" (41.3 mm)
Width 3/4" (19.05 mm)
Height 1-1/4" (31.75 mm)

Order No. 10 - 12361

Deck mount bushing replaces Grasshopper 282575.

Caster Bushing for WRIGHT STANDER



ID 1-1/4" (31.75mm)
OD 1-5/8" (41.3mm)
Height 1-3/8" (34.9mm)
Flange OD 2" (50.8mm)

Order No. 09 - 14322

Caster bushing replaces Wright Stander 14990003. For 1-1/4 pin.

Pulley Spacer for MTD



Order No. 09 - 10240

Pulley spacer replaces MTD 950-0957. Spacer for our 13-10185 & 13-10186 engine pulleys.

Caster Yoke Grease Cap



OD 1.78" (45.2 mm)

Order No. 09 - 10790

Caster yoke grease cap for 3/4" bearings.

Caster Yoke Grease Cap for SCAG



OD 1.98" (50.3 mm)
ID 1-7/8"

Order No. 09 - 10665

Caster yoke grease cap replaces Scag 481559. Also fits Dixie Chopper 10220 dust cap for 1" ID bearings.

09

BEARINGS



BEARING AND BUSHING BY SIZE CHART

ID	OD	Height	Flange OD	Material	Bearing No	Part No
0.3939	1.1811	0.3543			6200ZZ	09-1266
5/16"	55/64"	9/32"			608	09-50185
3/8"	1/2"	2-3/16"				09-330
3/8"	1/2"	3/8"	5/8"	Nylon		09-853
3/8"	1"	5/16"				09-3229
3/8"	1-1/8"					09-9892
3/8"	1-3/8"	3-9/16"				09-8319
3/8"	17/32"	15/32"	11/16"			09-7279
3/8"	3/4"	2-5/8"				09-8486
3/8"	5/8"	2.04"				09-14059
3/8"	5/8"	2-13/16:	1"			09-8586
3/8"	5/8"	3-1/2"				09-9076
3/8"	5/8"	3.44"				09-14060
25/64"	1-3/16"	11/32"			6200	09-50187
27/64"	41/64"	19/32"				09-50220
7/16"	1/2"	2-3/16"				09-331
7/16"	1-1/8"	13/16"				09-2703
7/16"	29/32"	9/16"				09-2943
7/16"	9/16"	1-5/8"				09-2907
15/32"	1-1/4"	25/64"			6201	09-50188
1/2"	11/16"	19/32"				09-9326
1/2"	1-1/8"	1/4"		Nylon		09-9502
1/2"	1-1/8"	13/32"				09-8646
1/2"	1-1/8"	5/16"			R8-2RS	09-6625
1/2"	1-1/8"					09-324
1/2"	1-3/8"	1/2"				09-8351
1/2"	1-3/8"	1"				09-8375
1/2"	1-3/8"	3-11/32"				09-8441
1/2"	1-3/8"	3-21/64"				09-8439
1/2"	1-3/8"	4-1/16"				09-8318
1/2"	1-3/8"	4-21/32"				09-8438
1/2"	1-3/8"	7/16"				09-8869
1/2"	1-3/8"					09-325
1/2"	3/4"	1"	15/16"			09-8654
1/2"	3/4"	19/32"	1"	Bronze		09-382
1/2"	3/4"	2-5/8"				09-8485
1/2"	3/4"	3/4"	15/16"	Bronze		09-3216
1/2"	3/4"	3-11/32"				09-8420

09

BEARINGS

* NOTE: BEARING'S AND BUSHING'S ARE LISTED BY ID SIZE FROM SMALLEST TO LARGEST (left to right) 149

BEARINGS & BUSHINGS



BEARING AND BUSHING BY SIZE CHART

ID	OD	Height	Flange OD	Material	Bearing No	Part No
1/2"	3/4"	4-5/8"				09-8409
1/2"	3/4"	4-9/16"				09-8706
1/2"	3/4"	5-7/8"				09-10017
1/2"	3/4"	5-9/16"				09-8707
1/2"	3/4"	7-1/2"				09-9992
1/2"	47/64"	4"				09-8434
1/2"	5/8"	3-1/4"				09-332
1/2"	5/8"	4-1/16"				09-7262
1/2"	5/8"	5/8"	3/4"	Nylon		09-329
1/2"	5/8"	6"				09-9613
1/2"	7/8"	29/32"				09-6542
33/64"	11/16"	1/2"				09-7674
17/32"	3/4"	5-3/32"				09-8740
17/32"	3/4"	6-1/4"				09-8738
9/16"	1-3/8"	17/32"				09-2967
9/16"	1-3/8"	7/16"			SC0265LUC3	09-3228
9/16"	1-3/8"	7/16"			1622-ZZ	09-1264
9/16"	3/4"	3/4"				09-9290
9/16"	3/4"	9/16"				09-7241
37/64"	1-3/8"	7/16"			6202	09-50189
37/64"	1-1/4"	23/64"			6002-2RS	09-8525
37-64"	1-3/8"	7/16"			6202	09-7312
5/8"	11/16"	5/8"	1"	Nylon		09-2939
5/8"	15/16"	1"		Plastic		09-13467
5/8"	1-1/2"					09-9007
5/8"	1-1/8"	3/4"	1-1/4"			09-2936
5/8"	1-13/32"	2-7/32"				09-5848
5/8"	13/16"	1/2"				09-8656
5/8"	13/16"	1"		Nylon		09-7720
5/8"	1-3/8"	1"				09-9338
5/8"	1-3/8"	17/32"	1-1/2"			09-3206
5/8"	1-3/8"	2-5/8"				09-8996
5/8"	1-3/8"	3-1/4"				09-8994
5/8"	1-3/8"	3-15/16"				09-5812
5/8"	1-3/8"	3-7/16"				09-8210
5/8"	1-3/8"	4"				09-9719
5/8"	1-3/8"	45/64"				09-9044

09

BEARINGS



BEARING AND BUSHING BY SIZE CHART

ID	OD	Height	Flange OD	Material	Bearing No	Part No
5/8"	1-3/8"	7/16"			44F40P	09-7950
5/8"	1-3/8"	7/16"			99502H-2RS	09-8198
5/8"	1-3/8"	7/16"			99502H-2RSNR	09-8199
5/8"	1-3/8"	7/16"			99502H-2RS	09-1265
5/8"	1-3/8"	7/16"			99502H2RS(NR)	09-481
5/8"	1-3/8"	7/16"				09-8831
5/8"	1-3/8"	1/2"				09-13418
5/8"	1-3/8"					09-326
5/8"	1-3/8"					09-8995
5/8"	1-3/8"					09-8995
5/8"	1-9/16"	15/32"			6203-2RS	09-483
5/8"	1-9/16"	15/32"				09-8861
5/8"	1-9/16"	15/32"			NTN6203LU	09-8437
5/8"	1-9/16"	7/8"				09-8077
5/8"	3/4"	1"	1-1/4"			09-3209
5/8"	3/4"	3/4"	1"	Bronze		09-3213
5/8"	3/4"	3/4"	1-1/8"	Bronze		09-3201
5/8"	7/8"	1"				09-9606
5/8"	7/8"	1-11/16"		Bronze		09-3202
5/8"	7/8"	2"				09-9709
5/8"	7/8"	5/8"		Nylon		09-7836
5/8"	7/8"	5/8"	1-1/8"	Bronze		09-293
5/8"	7/8"	5/8"	1-1/8"			09-2892
5/8"	.90"	.87"		Nylon		09-14557
5/8"	1"			Nylon		09-11833
5/8"	2-1/2"	3/4"				09-12651
41/64"	13/16"	1"	1-1/4"			09-12856
21/32"	1-21/64"	1-7/16"				09-9006
21/32"	1-3/8"	6"				09-9701
21/32"	1-3/8"	7/16"				09-7683
21/32"	1-9/16"	15/32"			6203-RS	09-7210
21/32"	1-9/16"	15/32"			6203-2RS	09-8507
21/32"	1-9/16"	15/32"			6203ZZ	09-7917
21/32"	1-9/16"	31/64"			6203Z	09-6513
21/32"	7/8"	2-3/8"				09-8743
21-32"	1-1/4"	15/16"				09-9463
43/64"	1-3/8"	25/64"			6003	09-50180

09 BEARINGS

* NOTE: BEARING'S AND BUSHING'S ARE LISTED BY ID SIZE FROM SMALLEST TO LARGEST (left to right) 151

BEARINGS & BUSHINGS



BEARING AND BUSHING BY SIZE CHART

ID	OD	Height	Flange OD	Material	Bearing No	Part No
43/64"	1-7/8"	3-3/4"				09-9046
3/4"	.945"	1"		Plastic		09-13468
3/4"	1"	1"				09-9572
3/4"	1"	1"		Bronze		09-9109
3/4"	1"	1"				09-9116
3/4"	1"	1-1/8"				09-8971
3/4"	1"	1-15/16"	1-1/8"			09-3222
3/4"	1"	1-3/16"				09-5721
3/4"	1"	2-3/4"				09-9274
3/4"	1"	3/4"	1-1/4"	Nylon		09-3211
3/4"	1"	3/4"	1-3/8"			09-8306
3/4"		1-39/64"				09-5618
3/4"	1"	6-3/4"				09-14133
3/4"	1"	3-1/2"				09-7839
3/4"	1"	5/8"		Bronze		09-8445
3/4"	1"	1-3/8"	1-1/16"			09-12857
3/4"	1-1/2"	1-11/16"				09-9002
3/4"	1-1/2"	3/8"				09-9563
3/4"	1-1/2"					09-8999
3/4"	1-1/2"					09-8999
3/4"	1-1/4"	2-1/2"				09-9000
3/4"	1-1/4"	3/4"	1-3/8"	Nylon		09-3200
3/4"	1-1/4"			Nylon		09-11834
3/4"	1-1/8"	3/4"				09-9303
3/4"	1-1/8"	3/4"	1-1/4"			09-2935
3/4"	1-1/8"	5/8"				09-10064
3/4"	1-25/32"	19/32"			9504-ZZ	09-484
3/4"	1-25/32"	21/32"			LM11910	09-813
3/4"	1-25/32"					09-9944
3/4"	1-27/32"	27/32"				09-8863
3/4"	13/16"	9/16"	1-1/4"	Nylon		09-854
3/4"	1-3/4"	1/2"			SC0493LU	09-487
3/4"	1-3/4"	1/2"				09-13359
3/4"	1-3/4"	1/2"				09-11835
3/4"	1-3/4"	1-7/16"				09-6536
3/4"	1-3/4" / 1-5/8"	1-3/4"				09-6863
3/4"	1-3/8"	1/2"				09-6573

09

BEARINGS



BEARING AND BUSHING BY SIZE CHART

ID	OD	Height	Flange OD	Material	Bearing No	Part No
3/4"	1-3/8"	1/2"	1-9/16"			09-3303
3/4"	1-3/8"	1/2"				09-13414
3/4"	1-3/8"	1"				09-7258
3/4"	1-3/8"	1-1/8"				09-7869
3/4"	1-3/8"	1-1/8"				09-3300
3/4"	1-3/8"	17/32"				09-328
3/4"	1-3/8"	3/4"	1-9/16"			09-3305
3/4"	1-3/8"	5/8"	1-1/2"			09-339
3/4"	1-3/8"					09-327
3/4"	1-3/8"					09-9003
3/4"	1-5/16"	17/32"				09-8726
3/4"	1-9/16"	15/32"			6203-2RS	09-6535
1"	2"	1-3/4"				09-11060
3/4"	2-3/64"	1-1/16"			SB205-12	09-3274
3/4"	53/64"	25/32"	1-1/8"			09-9745
3/4"	7/8"	11/16"	1-1/8"			09-9746
3/4"	7/8"	21/32"	1-3/16"	Iron		09-8783
49/64"	1-1/4"	3-23/32"				09-8998
25/32"	1-21/32"	15/32"			6004	09-50181
25/32"	1-11/32"	2-45/64"				09-9117
25/32"	1-27/32"	9/16"			6204Z	09-7166
25/32"	1-27/32"	9/16"			6204-2RS	09-442
7/8"		47/64"				09-5619
7/8"	1"	5/8"	1-1/4"			09-8796
7/8"	1-1/2"					09-9011
7/8"	1-1/8"	1"	1-1/2"			09-5713
7/8"	1-1/8"	1-1/4"				09-5703
7/8"	1-1/8"	1-1/4"	1-1/2"			09-8305
7/8"	1-3/8"	1"				09-7716
7/8"	1-3/8"	2-1/2"				09-9041
29/32"	31/32"	5/8"	1-1/4"	Nylon		09-2940
15/16"	1-1/4"	11/16"	1-5/8"	Nylon		09-8984
63/64"	2-3/64"	19/32"			6205	09-50190
63/64"	2-3/64"	19/32"			6205-RS	09-7162
63/64"	2-7/16"	21/32"			6302-Z	09-7178
63/64"	2-7/16"	21/32"			6305-2RS	09-3217
1"	1-1/2"					09-9009

09 BEARINGS

* NOTE: BEARING'S AND BUSHING'S ARE LISTED BY ID SIZE FROM SMALLEST TO LARGEST (left to right) 153

BEARINGS & BUSHINGS



BEARING AND BUSHING BY SIZE CHART

ID	OD	Height	Flange OD	Material	Bearing No	Part No	
1"	1-1/4"	1"	1-3/4"	Nylon		09-8240	
1"	1-1/4"	1"	1-3/4"			09-8366	
1"	1-1/4"	1"	1-25/32"			09-8367	
1"	1-1/4"	1-1/4"	1-1/2"			09-8211	
1"	1-1/4"	19/32"				09-9327	
1"	1-1/4"	3/4"	1-5/8"	Bronze		09-5707	
1"	1-1/4"	3-1/16"	1-1/2"			09-8513	
1"	1-1/8"	5/8"				09-8446	
1"	1-2/1"	3/4"	1-3/4"			09-9328	
1"	1-3/4"	1-1/2"				09-9275	
1"	1-3/4"	2-1/4"		Nylon		09-9276	
1"	1-3/8"	2-1/2"				09-9008	
1"	1-3/8"	3/4"	1-3/4"			09-8522	
1"	1-3/8"	3-3/16"				09-8433	
1"	1-31/32"	19/32"				L44643	09-814
.9845"	2.0475"	19/32"		Nylon		09-10303	
1"	2.0475"	23/32"				09-12119	
1"	2"	27/32"				RA100RR	09-8488
1"	2"	7/8"				09-9937	
1"	2"	9/16"				09-6534	
1"	5-1/2"	2-3/4"		Nylon		09-9160	
1-1/8"	1-3/8"	1"				09-8476	
1-1/8"	1-5/8"	1-1/2"	1/4"			09-6864	
1-1/8"	2"	5/8"				LM44649	09-9951
1-1/8"	2-3/16"	1-1/4"				09-13259	
1-1/4"	1-5/8"	1-3/8"		Nylon		09-14322	
1-3/16"	2-3/16"	1/2"				6006	09-50183
1-3/16"	2-7/16"	5/8"				6206	09-50191
1-1/4"	2-21/64"	21/32"				LM67010	09-10015
3/4"	1-55/64"	27/32"				SA204-12	09-10265
2-3/64"	7/8"	1"				09-1064	

09

BEARINGS



WHEEL & DECK ACCESSORIES



**Electric PTO Clutch
Quick Look-Up**

WARNER No.	ROTARY No.	WARNER No.	ROTARY No.
5215-13	10-11857	5218-67	10-12114
5215-14	10-11858	5218-73	10-12262
5215-51	10-9910	5218-76	10-11133
5215-59	10-12227	5218-80	10-12261
5215-62	10-9913	5218-94	10-14009
5215-68	10-12230	5218-99	10-12403
5215-69	10-14045	5218-100	10-12981
5215-73	10-12309	5218-107	10-12835
5215-88	10-11070	5218-110	10-11445
5215-129	10-11828	5218-140	10-12835
5215-130	10-11829	5218-154	10-12454
5215-134	10-12980	5218-205	10-12517
5215-142	10-12247	5218-218	10-14189
5217-2	10-9912	5218-254	10-14353
5217-6	10-9911	5219-4	10-12658
5217-9	10-9911	5219-21	10-13469
5217-14	10-12231	5219-25	10-12424
5217-32	10-11859	5219-51	10-12621
5217-38	10-14316	5219-52	10-12899
5217-147	10-12114	5219-54	10-13554
5218-5	10-11444	5219-98	10-14229
5218-6	10-12228	5219-99	10-14327
5218-10	10-11071		
5218-14	10-11072		
5218-17	10-11073		
5218-27	10-11664		
5218-29	10-13973		
5218-33	10-11074		
5218-44	10-11075		
5218-54	10-11825		
5218-58	10-14495		
5218-65	10-11237		

Quick-Glance

WHEEL & DECK ACCESSORIES	PG.
Caster Yoke	156-157
Support Brackets	157-158
Damper	159
Plastic Grips	160
Knobs	160
Handle Bracket	161
Eyebolts	162
Quick Pin	162
Turn Buckle	162
Belt Guide	163
Springs	171-173
Ball Joints	173-174
Female/Male Rod Ends	173
Spacers	175-176
Washers	176-177
Nuts	177-178
Bolts	178-181
Spindle Shaft	182-183

Spindle / Quill Assembly	184-201
Electric PTO Clutch	164-170

WHEEL & DECK ACCESSORIES



Caster Yoke

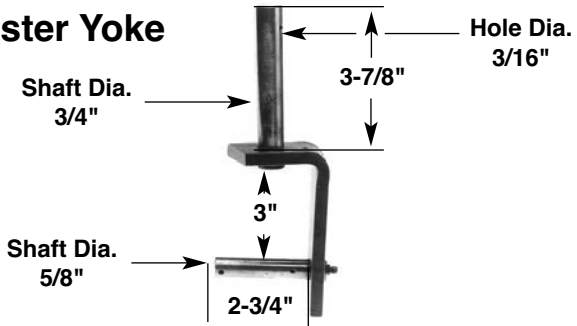

Order No. 10 - 2243

6" Caster Yoke. Replaces Bobcat 36306 & 36013A, Bunton PLO556, John Deere PT8670, Snapper 76400. Used with our support arm 10-2218.

4" Yoke for BOBCAT

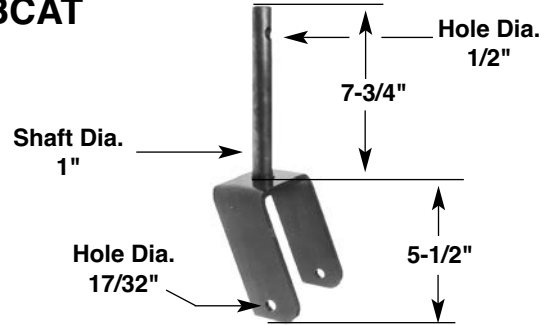

Order No. 10 - 6581

4" Yoke. Replaces Bobcat 36411/36526.

4-1/2" Yoke for EXMARK

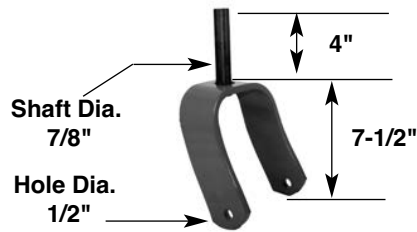

Order No. 10 - 8625

4-1/2" yoke replaces Exmark 1-522143-01. Fits models Turf Ranger & Turf Tracer 52" & 60" cut & Explorer 44" & 52" cut models. (Red)

Caster Yoke for EXMARK

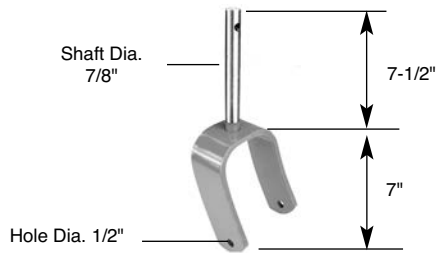

Order No. 10 - 10307

Caster yoke replaces Exmark 1-322145-01. Fits Metro and Viking walkbehinds with serial 102000 and higher.

6" Caster Yoke for EXMARK

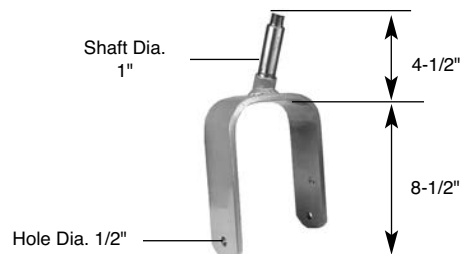

Order No. 10 - 10194

6" Caster yoke replaces Exmark 1-632511-01. Fits 13 x 5.00 - 6 wheel. Used on 52" Lazer Z HP. (Red). Uses our 10-11039 3/4" locknut, replaces Exmark #3296-51.

10
WHEEL/DECK ACC.



4-1/8" Yoke for SCAG

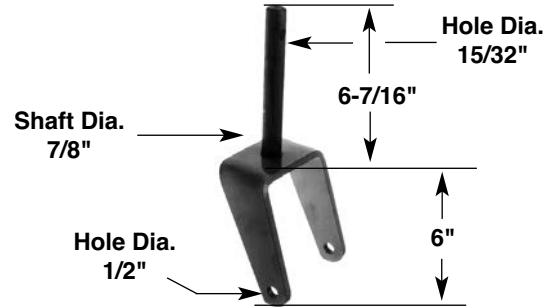

Order No. 10 - 7125

4-1/8" Caster Yoke. Replaces Scag 45006. Fits 36", 48" and 60" mowers. Used with our 10-8189 support arm.

Yoke Lift for SNAPPER



Order No. 10 - 7747

Yoke lift replaces Snapper 7047843. Used on all Snapper rear engine riders.

Support Arm



Order No. 10 - 2218

Caster Yoke Support Arm. Replaces Ransomes/Bobcat 36129, Bunton PLO457, John Deere PT8663, Exmark 302122. (Used with our cast yoke 10-2243). Comes complete with bushing and grease fitting. Uses our bushing 09-5721.

Support Arm for BOBCAT



Order No. 10 - 6580

Support Arm. Replaces Bobcat 36482. Comes complete with bushings and grease fitting. Uses our bushing 09-5707. Use with our 10-6582 & 10-6581 Yokes.

WHEEL & DECK ACCESSORIES



Bell Crank



Order No. 10 - 2221

Bell Crank. Replaces Ransomes/Bobcat 31007A. Left hand. (53 degree)



Order No. 10 - 2222

Bell Crank. Replaces Ransomes/Bobcat 31005A, 2306019. Variable speed. (90 degree)



Order No. 10 - 2223

Bell Crank. Replaces Ransomes/Bobcat 31006A. Right hand. (53 degree)

Stud Deck Lift for DIXIE CHOPPER



Order No. 10 - 13296

1/2" -13 Stud, replaces Dixie Chopper S-114.

Drag Link for JOHN DEERE



Order No. 10 - 13440

Drag link replaces John Deere GY21250, GY20770. **Left** hand steering Drag link, adjustable. Fits LA100, X100 series riders. Replaces non-adjustable drag links.



Order No. 10 - 13441

Drag link replaces John Deere GY21251, GY20771. **Right** hand steering Drag link, adjustable. Fits LA100, X100 series riders. Replaces non-adjustable drag links.

Deck Lift Link for AYP



Order No. 10 - 9718

Deck lift link replaces AYP 110448X. Total length 7-1/2"

Deck Link Lift for MTD

OD 1/2"
Width 1"
Over All Length 10-1/4"
Slot Length 2-3/4"



Order No. 10 - 9512

Deck link lift replaces MTD 14802A-0637. Fits 600 series on 30", 38" & 42" decks.

10
WHEEL/DECK ACC.



Damper Assembly for BOBCAT



Order No. 10 - 10757

Damper assembly replaces Bobcat 2721246. Fits Bobcat "ZERO TURN" rider mowers. Size 8 x 22. Extended length 10.08"

Damper for CUB CADET



Order No. 10 - 14437

Damper replaces Cub Cadet 02003622. Fits Cub Cadet, MTD commercial turf.

Damper for EXMARK

Open Length 9-1/2"
Closed Length 6-5/8"



Order No. 10 - 9972

Damper replaces Exmark 1-523027, 103-4079, 109-2339. Fits Lazer Z riders.

Damper for SCAG



Order No. 10 - 11954

Damper replaces Scag 482794.



Order No. 10 - 13664

Damper replaces Exmark 109-2339, 1-523027, 103-4079, 103-2913.

Open Length 12-3/4"
Closed Length 10-1/4"



Order No. 10 - 13470

Damper motion control replaces Exmark 116-0027. Fits Lazer Z & Toro Z Master.



Order No. 10 - 11562

Gas damper replaces Scag 461090. 5/16" - 18 ball studs

Damper for SNAPPER



Order No. 10 - 13665

Damper replaces Snapper 1727918, 1727918SM, shock absorber damper. Fits 150 Z & Craftsman ZTS 7500.

WHEEL & DECK ACCESSORIES



Foam Grip Handles



Order No.

Size

10 - 6891 7/8" Foam Grips

10 - 6892 1" Foam Grips

Used on Scag, Bobcat, Exmark, Snapper and other midsize mowers. **Sold and priced in pairs.**

Plastic Grips

ID 7/8"



Order No. 10 - 336

Plastic Grips (pair).

Fix-A-Handle



Order No. 10 - 8660

Fix-a-handle repairs broken mower handles. Restores worn sagging handles, fits most mower models, repair obsolete handles. Fast and easy installation.



Order No. 10 - 863

Knob & Bolt set for fold-down handles. Replaces Roper 53213195, 58714, 131950 (Bolt) & 63688 (Knob) & MTD 720-0241/710-1174, 710-0405 (Bolt) & 09966 (Knob).

Three Prong Clamping Knobs



Order No. 10 - 10354

1/4" - 20 Male thread clamping knob.

Order No. 10 - 10356

5/16" - 18 Male thread clamping knob.

Order No. 10 - 10358

3/8" - 16 Male thread clamping knob. Replaces Scag No. 481625-01.

Fluted Torque Knobs



Order No. 10 - 10355

1/4" - 20 Female thread clamping knob.

Order No. 10 - 10357

5/16" - 18 Female thread clamping knob. Replaces Snapper 7023735, Exmark 1323385

Order No. 10 - 10359

3/8" - 16 Female thread clamping knob.

Handle Knob for HONDA



Order No. 10 - 12749

Handle knob replaces Honda 53125-VA4-K10, code 3338076. 8mm 5-star. Fits walkbehind mowers.

Plastic Knob Assembly for MTD



Order No. 10 - 9565

Plastic knob assembly replaces MTD 920-0241. Fits 94' Montgomery Ward snowthrowers, MTD edgers from 95' - 98', MTD walkbehind mowers models 111-314 & MTD turf power walkbehind mowers. (Black).

WHEEL/DECK ACC. 10



WHEEL & DECK ACCESSORIES

Handle Bracket



Order No. 10 - 337

Snap-On Bracket. For easy removal of handle. Heavy gauge steel, cadmium plated. Fits 3/8" hole in handle. Sold in sets.

Shift Handle for SNAPPER

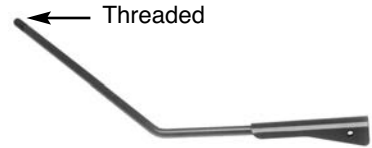

Order No. 10 - 8301

Shift handle replaces Snapper 7040284. Fits on rear engine riders.

Handle Bracket for MTD (Left hand)



Order No. 10 - 8314

Left hand handle bracket replaces MTD 17189 & 17189B-0637.

Handle Bracket for MTD (Right hand)



Order No. 10 - 8313

Right hand handle bracket replaces MTD 17188.

Clevis Hitch Pin for VELKE



OD 1/2"
Length 4-1/4"



Order No. 10 - 14221

Clevis hitch pin replaces Velke VKPIN2-2. Similar to our 10-8671.

OD 1/2"
Length 4-29/32"



Order No. 10 - 8671

Clevis pin replaces Velke VKPIN2-2. Attaches Velke to mower bracket. Fits all one wheel Velkes.

Traction Control Lever



Order No. 10 - 2219

Traction Control Lever. Replaces Ransomes/Bobcat 36068N, Bunton PLO371 and Snapper 7076405.

Clevis Pin

Over all Length 1-7/8"



Order No. 10 - 2910

Clevis Pin for Traction Control Handle. Comes complete with Cotter Pin. Replaces Bobcat 64188-21 & 64140-2.

MIN010

Rear Bumper



Order No. 10 - 3307

Rear bumper. Replaces Snapper 7030798. Made 2" longer. Bag Saver - raises bag to prevent wear on bag from dragging.

Hood Latch



Order No. 10 - 3242

Replaces MTD 723-0296.

10 WHEEL/DECK ACC.

WHEEL & DECK ACCESSORIES



Brake Pedal Pad



Order No. 10 - 2908

Replaces Snapper 7011747.

Clutch Pedal Pad



Order No. 10 - 2909

Replaces Snapper 7011815.

Eyebolts for SCAG

Size 5/16" - 18
Length 2-1/4"



Order No. 10 - 8689

Right hand thread eyebolt replaces Scag 04070-01. Fits right hand front deck on 32", 36", 48", 52" & 61" cut models.

MIN010

Order No. 10 - 8690

Left hand thread eyebolt replaces Scag 04070-02. Fits left hand front deck on 32", 36", 48", 52" & 61" cut models.

MIN010

Quick Pin



Order No. 10 - 2226

3/16" Quick Pin. Replaces Ransomes/Bobcat 64173-05, 64173-02, Exmark 809006.1-1/2" length.

Order No. 10 - 2225

5/16" Quick Pin. Replaces Snapper 7076967, Ransomes/Bobcat 64173-01. 1-5/8" length.

Click Pin



Order No. 10 - 9232

1/4" Click pin replaces MTD 714-0143, 914-0143. Length 1-3/4", Dia. 1/4".

Lynch Pin for SCAG



Diameter 7/16"

Order No. 10 - 7181

Lynch Pin replaces Scag 04066-01, Exmark 1-80920. Fits Scag 45006. 4-1/8" yoke our **10-7125**.

Seal Cap for SNAPPER



Order No. 10 - 7919

Seal cap replaces Snapper 7031732.

Length 5-1/4"



Order No. 10 - 8295

Brake band. Replaces MTD 761-0168A, 961-0168B. Fits 400 series shallow deck 38" cut. Fits 130-498 series tractors.

WHEEL/DECK ACC.

Turn Buckle for SCAG

Length 2-3/4"



Order No. 10 - 8985

Turn buckle replaces Scag 43025. Fits right hand front decks on 32", 36", 48", 52" & 61" cut mowers. 5/16"-18 RH & LH threads.

Idler Pulley Shield for SCAG

ID 3/8"
OD 2"



Order No. 10 - 12812

Idler pulley dust shield replaces Scag 424367. The benefit of using this is that it keeps dirt and debris away from the bearing to keep it running smoother for longer. This can be used to protect any idler that has an unprotected bearing. MIN005



WHEEL & DECK ACCESSORIES

Rear Pivot Arm Assembly for TORO



Order No. 10 - 13405

Rear pivot arm assembly replaces Toro 74-1851 / 74-1841. Fits commercial mowers.

Front Pivot Arm Assembly for TORO



Order No. 10 - 13404

Front pivot arm assembly replaces Toro 61-8300. Fits commercial mowers.

Front Spring Arm Assembly for TORO



Order No. 10 - 13406

Front spring arm assembly replaces Toro 66-7560. Fits commercial mowers.

Rear Pivot Arm Assembly for TORO



Order No. 10 - 13407

Rear pivot arm assembly replaces Toro 66-7561. Fits commercial mowers.

Belt Guides

Order No. 10 - 6670

Replaces Bobcat 32344. Used on all 36" & 48" cut gear drive units. Holds belt on engine pulley. (2 per unit)



Order No. 10 - 6671

Replaces Bobcat 32345-01. Used on all variable speed new models. Holds belt on engine pulley. (2 per unit)



Order No. 10 - 6672

Replaces Bobcat 32345-02. Used on older model single belt variable speed mowers. Uses 2 on engine pulley and 4 on wheel drive pulley. (6 per unit)

Wheel Height Adjuster for SNAPPER (Left & Right hand)



Order No. 10 - 8302

Left hand wheel height adjuster replaces Snapper 7051815 & 54225. Uses our 09-3228 bearing. (rear)

Order No. 10 - 8303

Right hand wheel height adjuster replaces Snapper 7051814. Uses our 09-3228 bearing. (rear)

Height Adjuster for SNAPPER

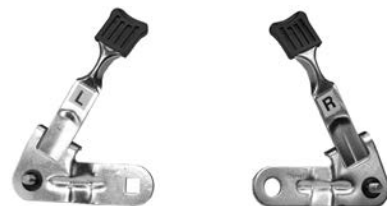

Order No. 10 - 9510

Height adjuster replaces Snapper 7051885 & 7052909. Fits 21" walkbehind mowers. Square hole, left hand. (front)

Order No. 10 - 9511

Height adjuster replaces Snapper 7051886 & 7052908. Fits 21" walkbehind mowers. Round hole, right hand. (front)

10

WHEEL/DECK ACC.



WHEEL & DECK ACCESSORIES

Warner Electric PTO Clutch



Order No. 10 - 9910

Electric PTO clutch replaces Cub Cadet 717-0949/917-0949 & 717-1434/917-1434. Also replaces AYP 137140, 108218X & 142600. 1" ID Keyed Hub, 5.304" Dia Pulley, 5/8" belt, Shaft size 1". Warner 5215-51.



Order No. 10 - 9912

Electric PTO clutch replaces Ariens 03601800, AYP 145028, Simplicity 1708536, 1686882. 1" x 3" Height, 5.375 Dia. Pulley. 1/2" Belt, shaft size 1". Warner 5217-2.



Order No. 10 - 9911

Electric PTO clutch replaces Ariens 03643100, Cub Cadet 717-1459/917-1459, AYP 160889, Dixon 3579 GardenWay 1772388, John Deere AM119683, MTD 717-1459, Snapper 7053740, 7653740, Swisher 688EC Warner 5217-9, 5217-6. 1" x 3" Height, 5.375" Pulley. 5/8" Belt, Shaft size 1".



Order No. 10 - 9913

Electric PTO clutch replaces Ariens 03090800, Cub Cadet WD-C38410, Grasshopper 388766/604182, Toro 93-3160. Double Pulley. 1-1/8" ID x 3-3/4" Height, 5" Dia. Pulley. 1/2" Belt, shaft size 1-1/8". Warner 5215-62.

Electric PTO Clutch for ARIENS



Order No. 10 - 11071

Electric PTO clutch replaces Ariens/Gravely 9225400, Country Clipper E-6247, Dixon 61516, 539128711, Toro 94-6136. 5.345" Dia. Pulley. 5/8" Belt, shaft size 1-1/8". Warner 5218-10.

Electric PTO Clutch for ARIENS



Order No. 10 - 14009

Electric PTO clutch replaces Ariens 09232700, Gravely 00389900, 09232700, Great Dane GDA10122, Wood Mizer P604, Warner 5218-94. 1-1/8" ID, 6" OD, for 5/8" belt.

Electric Clutch for ARIENS



Order No. 10 - 14495

Electric clutch replaces Ariens 09407700, Grasshopper 606242 & 388767, Snapper 35520, 58925, 7058925YP, Woods 73558, 74075. Warner 5218-58, 5218-26. 1-1/8" ID, 3-1/2" height, 1/2" belt, 4-7/8" pulley.

Electric PTO Clutch for AYP



Order No. 10 - 12980

Electric PTO clutch replaces AYP 174367, Husqvarna 532174367. 1" ID x 6" pulley, 1/2" or 5/8" belt. Warner 5215-134.

Order No. 10 - 12309

Electric PTO clutch replaces AYP 174509, 124648X, 140923, 150283, Cub Cadet 917-3375, 717-3384. 1.11" ID x 4.825" height, 5.31" pulley diameter, 1/2" Belt. Warner 5215-73. Clockwise direction.



10
WHEEL/DECK ACC.



WHEEL & DECK ACCESSORIES

Electric PTO Clutch for CUB CADET



Order No. 10 - 12228

Electric PTO clutch replaces Cub Cadet 917-3403. 1-1/8" ID x 6" pulley, uses type B belt. Warner 5218-6.



Order No. 10 - 12230

Electric PTO clutch replaces Cub Cadet 917-3389, 717-3384, 717-3389, 717-3375. 1" ID x 4.825" HT 6" pulley, uses type B belt. Warner 5215-68.



Order No. 10 - 12231

Electric PTO clutch replaces Cub Cadet 717-3385A. Fits 2000 series models 2130, 2135, 2146, 2150, 2155, 21665, 38" & 42" cut decks. 1" x 5.345" pulley, A/B belt. Warner 5217-14.



Order No. 10 - 12247

Electric PTO clutch replaces Cub Cadet 717-04080 / 917-04080. 1" x 6" pulley. Uses type B belt 5/8". Warner 5215-142.



Order No. 10 - 12227

Electric PTO clutch replaces Cub Cadet 917-3497. Also replaces Jacobsen 990947, Toro 99-8012, Simplicity 1703816, Snapper 16343. 1" ID x 5.345" Pulley, 5/8" belt. Warner 5215-59.



Order No. 10 - 12621

Electric PTO clutch replaces Cub Cadet 717-04174/917-04174. Warner 5219-51. Shaft size 1", 6" pulley diameter, 5/8" Belt. Fits models LT1045. LT1050.



Order No. 10 - 12899

Electric PTO clutch replaces Cub Cadet 917-04180. Fits GT2500 series & LT2042, GT2544, GT2550, GT2554. 1-1/8" x 6" pulley, 5/8" belt. Warner 5219-52.



Order No. 10 - 13973

Electric PTO clutch replaces Cub Cadet 917-3446 / 717-3446. Warner 5218-29. 6" Dia. Pulley, 5/8" Belt, shaft size 1". Fits models 2160, 2164, 2165, GT2521, LT2180 serial no. 326,006 and up. Mfg date B037G3 and after.



Order No. 10 - 11859

Electric PTO clutch replaces Cub Cadet 917-04163. 1" x 5.923" pulley, type A/B belt. Warner 5217-32.



Order No. 10 - 11072

Electric PTO clutch replaces Cub Cadet 01002108P. Fits Tank models. Also fits Lesco. 6" Dia. Pulley. 5/8" Belt, shaft size 1". Warner 5218-14.

WHEEL & DECK ACCESSORIES



Electric PTO Clutch for CUB CADET



Order No. 10 - 14229

Electric PTO clutch replaces Cub Cadet 917-04552A, 717-04552. Fits LTX1042, LTX1045, LTX1046, LTX1050, 2008 and newer RZT 50, FMZ50. Warner 5219-98. 1" ID, 6" pulley for 1/2" belt.



Order No. 10 - 14045

Electric PTO clutch replaces Cub Cadet 917-3390, 717-3390. Fits 2185 tractor. Also replaces Encore 523025 & 523370. Warner 5215-69. 1-1/8" ID 6" pulley, Direction: Counter Clockwise, 5/8" belt.

Electric PTO Clutch for CASTLE GARDEN



Order No. 10 - 14316

Electric PTO clutch replaces Castle Garden 19399060/0, 18399065/1, 1136-0837-01. TC 102/122. Warner 5217-38, 5217-20. 1" ID, 5.20" pulley for 5/8" belt.

Electric PTO Clutch for DIXIE CHOPPER



Order No. 10 - 14353

Electric PTO clutch replaces Dixie Chopper 500056. Fits Excalibur series & Classic series with 1-1/4" engine shafts. Warner 5218-254. 1-1/8" ID, 7-1/2" pulley for 5/8" belt.

Electric PTO Clutch for ENCORE



Order No. 10 - 11073

Electric PTO clutch replaces Encore 523370 & 523025. 6" Dia. Pulley. 5/8" Belt, shaft size 1-1/8". Warner 5218-17.



Order No. 10 - 13469

Electric PTO clutch replaces Encore 343084. Warner 5219-100 old Warner 5219-21. 5-15/16" Dia. Pulley, 5/8" Belt, shaft size 1". Fits Z34 model 34K350Z.

Electric Clutch for ENCORE



Order No. 10 - 14189

Electric clutch replaces Encore 5203434, Shiver Country Clipper E-6444, Wright Mfg. 71410024. Warner 5218-218. Clutch brake, 200 lb torque. 1-1/8" ID, 3-1/4" height, 7-1/2" pulley.

Electric PTO Clutch for EXMARK



Order No. 10 - 11857

Electric PTO clutch replaces Exmark 1-611223 & 603539. Fits Turf Tracer models. Also replaces Ferris 1521823, fits models SSZ & STHM, Snapper 7029678. 1" ID x 6" pulley, A/B belt. Warner 5215-13.

10 WHEEL/DECK ACC.



Electric PTO Clutch for EXMARK



Order No. 10 - 12977

Electric PTO clutch replaces Exmark 103-0665, 1-631732, 1-641300, 631732, 614300, Ferris 1521145, 5021145, Ogura GT2.5-MC04, MA-GTEXM14, Scag 461395, 461716, 481530. 6" Dia. Pulley, 5/8" Belt, shaft size 1-1/8". Fits Lazer Z.



Order No. 10 - 12981

Electric PTO clutch replaces Exmark 103-3245. 1" ID x 7-1/8" pulley, 5/8" belt. Warner 5218-243 w/pigtail, 5218-228 wo/pigtail, & Warner 5218-100.



Order No. 10 - 11237

Electric PTO clutch replaces Exmark 103-0665, 1-631732, 1-641300. Fits models 1600,000 & Higher. Fits Bad Boy 070-5035-00, Exmark/Toro 103-0501, Auburn 180265, Bobcat 2721337, Grasshopper 388740, Midmounts Excel 787366. For 25hp engines. 6.25" Dia. Pulley. 5/8" Belt, shaft size 1-1/8". Warner 5218-65 & 5218-213.



Order No. 10 - 11858

Electric PTO clutch replaces Exmark 1-551054, 1-543259, fits Turf Ranger Models. Also replaces Great Dane D18000, AYP 106316, 109550X, Bobcat 188019, Ferris 1521083, Husqvarna 917063, Snapper 7017063. 1" ID x 6" pulley, A/B Belt type. Warner 5215-14.



Order No. 10 - 11825

Electric PTO clutch replaces Exmark. Similar to our 10-11075 except with a 1-1/8" bore. Used on Exmarks with larger engines and crankshafts. 1-1/8" ID x 7.385" pulley, 5/8" Belt. Warner 5218-54.



Order No. 10 - 11133

Electric PTO clutch replaces Exmark 103-0661. Fits Lazer Z 18-23 hp Kohler units below 160,000 & 160,000 - 369,999. 6-5/16" pulley Diameter, 1" ID, Uses 5/8" belt. Warner 5218-76.



Order No. 10 - 11444

Electric PTO clutch replaces Exmark 103-0664. Also replaces Bobcat 2188151, Ferris 1522040, Husqvarna 102603. 6-5/16" Dia. Pulley. 5/8" Belt, shaft size 1-1/8". Warner 5218-5



Order No. 10 - 11075

Electric PTO clutch replaces Exmark 1653048 & 103-0690, Toro 105-3630. 7.345" Dia. Pulley. 5/8" Belt, shaft size 1". Warner 5218-44. Uses our 10-12923 pigtail.

WHEEL & DECK ACCESSORIES



Electric PTO Clutch for EXMARK



Order No. 10 - 12261

Electric PTO clutch replaces Exmark 103-0690, 1-653048, 1-653292. Fits Lazer Z hp. Serial numbers 260,000 and higher. 1" ID x 7-3/8" pulley, 5/8" belt. Warner 5218-80.



Order No. 10 - 12262

Electric PTO clutch replaces Exmark 103-0281 & 103-1364. 1-1/8" ID x 6.313" pulley, 5/8" belt. Warner 5218-73.



Order No. 10 - 12403

Electric PTO clutch replaces Exmark 103-3246, fits 27 & 30 hp Kohler Lazer Z units. Warner 5218-99. Shaft size 1-1/8", 7-11/32" pulley diameter, 5/8" Belt.



Order No. 10 - 12517

Electric PTO clutch replaces Exmark 109-9276/109-2916. Warner 5218-205. 200 lbs. torque. Shaft size 1", 7-1/8" pulley diameter, 5/8" Belt. Uses our 10-12923 pigtail.

Harness for Electric PTO Clutch



Order No. 10 - 12923

Electric clutch pigtail. Warner 5218-251-001. Does not have a diode like Hustler & Grasshopper use. Fits our 10-11075, 10-12517 & 10-12835 Electric Clutches.

Electric PTO Clutch for EXMARK & DIXIE CHOPPER



Order No. 10 - 12835

Electric PTO clutch replaces Exmark 109-927, Dixie Chopper 500012. Warner 5218-210. Replaces Warner 5218-140 & 5218-107. 200 lbs. torque. Shaft size 1-1/8", 7" pulley diameter, 5/8" Belt. Uses our 10-12923 pigtail.

Electric PTO Clutch for GRASSHOPPER



Order No. 10 - 12114

Electric PTO clutch replaces Grasshopper 606242 / 388769. Warner 5218-214. Replaces Warner 5218-67 & 5217-147. 200 lbs. torque. Shaft size 1-1/8", 4.875" pulley diameter, 2A Belt. Fits most 700 series mowers. Rotation cw-rev, Connector: integral.



Order No. 10 - 11664

Electric PTO clutch replaces Grasshopper 388762 & 604180. Fits model 618. Also replaces Ariens 55430 & Gravely 574100. 4-7/8" Dia. Pulley. 1/2" Belt, shaft size 1". Warner 5218-27.

10 WHEEL/DECK ACC.



Electric PTO Clutch for GREAT DANE



Order No. 10 - 12658

Electric PTO clutch replaces Great Dane GDA10017 & D38155. Warner 5219-4. Fits Chariot models. Shaft size 1", 6" pulley diameter, 5/8" Belt.

Electric PTO Clutch for HUSTLER



Order No. 10 - 12454

Electric PTO clutch replaces Hustler 601311. Warner 5218-154 & 5218-222. Shaft size 1-1/8", 6-5/16" pulley diameter, 5/8" Belt.



Order No. 10 - 11445

Electric PTO clutch replaces Hustler 781039K. 6-1/4" Dia. Pulley. 5/8" Belt, shaft size 1-1/8". Warner 5218-110.

Electric PTO Clutch for MTD



Order No. 10 - 11829

Electric PTO clutch replaces MTD 717-1709 & 917-1709. Fits model 809. 1" ID x 5.375" pulley, 1/2" belt. Warner 5215-130.



Order No. 10 - 11828

Electric PTO clutch replaces MTD 717-1708 & 917-1708. Also replaces Snapper 7014022. 1" ID x 5.395" pulley, 1/2" belt. Warner 5215-129.

Electric PTO Clutch for MTD



Order No. 10 - 12424

Electric PTO clutch replaces MTD 917-1774B, fits 50" Toro/Home Depot & 54" 800 series mowers. Warner 5219-25. Shaft size 1", 6" pulley diameter, 5/8" Belt.

Electric Clutch for MTD



Order No. 10 - 14327

Electric clutch replaces MTD 917-04622 & 917-04183, 717-04183. Warner 5219-99. 1" ID, 4" height, 5-11/32" pulley.

WHEEL & DECK ACCESSORIES



Electric PTO Clutch for TORO



Order No. 10 - 11074

Electric PTO clutch replaces Toro 94-4632 & 105-1671. Fits A320 - Z325. 4.875" Dia. Pulley. 1/2" Belt, shaft size 1-1/8". Warner 5218-33. Double pulley.



Order No. 10 - 11070

Electric PTO clutch replaces Toro 116277, Ariens 03450500, Dixie Chopper 50300, Snapper 7079197 & 79446. 5.345" Dia. Pulley. 5/8" Belt, shaft size 1". Warner 5215-88.

Electric PTO Clutch for WRIGHT MFG













Order No. 10 - 13554

Electric PTO clutch replaces Wright Mfg. 71410014, Warner 5219-54. Fits Wright Stander & Sentar Sport models. 7-1/8" Dia. Pulley, 5/8" Belt, shaft size 1".



Springs











Order No.		Description	Coil Dia.	Length Over All	Length of Coil	Thick-ness
10 - 6973		Clutch/Brake Spring. Replaces Snapper 7013885. Used on rear engine riders.	17/32"	5-1/8"	3-9/16"	1/16"
10 - 6974		Belt Clutch Spring. Replaces Scag 48051. Also replaces Encore 363117.	3/4"	3-1/2"	2-3/16"	3/32"
10 - 3301		Brake Spring. Replaces AMF 00782223, 35410.	5/8"	4-9/16"	2-7/8"	5/64"
10 - 50212		Spring replaces Stiga 1134-1242-02.	16.27mm 41/64"	79.77mm 3-9/64"	45.64mm 1-51/64"	3.18mm 1/8"
10 - 254		Replaces MTD 732-0157.	3/8"	3-3/8"	2"	1/16"
10 - 291		Replaces MTD 732-0433.	1/2"	2-13/16"	1-5/8"	5/64"
10 - 50213		Spring with loop replaces Stiga 1134-1322-01.	19.05mm 3/4"	228.60mm 9"	100.41mm 3-61/64"	19.05mm 7/64"
10 - 8504		Transmission Clutch lever Spring. Replaces Honda 54411VB3800, code 2456069. For S/P 21" walkbehind mowers.	1/2"	7"	1-1/4"	3/32"
10 - 8503		Steering Lever Spring. Replaces Walker 5223. Fits on all Walker "ZERO TURN" mowers.	5/6"	6-1/8"	5"	1/32"
10 - 3207		Blade Drive Spring. Replaces MTD 732-0153.	3/4"	9"	4-3/4"	7/64"

10
WHEEL/DECK ACC.

WHEEL & DECK ACCESSORIES





Springs

Order No.		Description	Coil Dia.	Length Over All	Length of Coil	Thickness
10 - 3221		Deck Spring. Replaces MTD 732-0307A.	1"	11-1/4"	6-3/4"	9/64"
10 - 2903		Idler Spring. Replaces Murray 165 x 3. (Old No. 20683)	3/4"	6"	4-3/4"	5/64"
10 - 2933		Blade Drive Spring. Replaces Murray 165 x 4. (Old No. 28604)	3/4"	5-3/4"	4-1/4"	3/32"
10 - 2934		Blade Drive Spring. Replaces Murray 165 x 58. (Old No. 20682)	5/8"	5"	3-1/2"	5/64"
10 - 3223		Wheel Drive Spring. Replaces Snapper 7029025 & 7017326.	3/8"	3-1/4"	1-1/2"	1/16"
10 - 9908		Idler Arm Spring. Replaces Dixie Chopper 10222.	7/8"	6-1/4"	4-1/8"	1/8"
10 - 3306		Clutch Spring. Replaces Snapper 7012122.	1/2"	5-7/8"	1-3/4"	5/64"
10 - 2224		Bell Crank Spring. Replaces Ransomes/ Bobcat 35010A, Snapper 7076439.	1/2"	4-7/16"	2-3/4"	3/32"
10 - 9295		Extension Spring. Replaces MTD 732-0815. Fits MTD 28" cut Yard Boy riding mower.	7/16"	4"	2-11/16"	3/64"
10 - 9268		Extension Spring. Replaces MTD 732-0429A, 932-0429A Fits variable speed model 18 hp tractors. Speed selector lever spring.	1/2"	4"	2-1/2"	1/16"
10 - 9404		Extension Spring. Replaces MTD 732-0814. Fits MTD 28" cut Yard Boy riding mower.	9/16"	5-3/4"	4-1/4"	1/16"

10
WHEEL/DECK ACC.



Springs

Order No.	Description	Coil Dia.	Length Over All	Length of Coil	Thick-ness
 10 - 9184	Extension Spring. Replaces MTD 732-0638. Used on Models 45 thru 47G-400 series.	7/8"	12-3/4"	7-3/4"	1/8"
 10 - 9716	Extension Spring. Replaces Murray 165X76SE	13/16"	11-1/2"	4-1/4"	1/8"
 10 - 9717	Extension Spring. Replaces MTD 932-0594A	29/32"	7-3/4"	5-11/16"	1/8"

Female Rod Ends



Order No. 10 - 2213
Rod end assembly. Female 5/16"-24.

Order No. 10 - 2214
Rod end assembly. Female 3/8"-24.

Order No. 10 - 9311
Rod end replaces Bobcat 128079. Female 1/4" - 28 rod end assembly. Also replaces Country Clipper H-1885.

Order No. 10 - 9307
Rod end replaces Gravely 44941. Female 1/2" - 20 rod end assembly. Right hand thread. Fits Gravely 18G & 20G. Also replaces John Deere AM103052.

Male Rod Ends



Order No. 10 - 2215
Rod end assembly. Male 5/16" - 24.

Order No. 10 - 2216
Rod end assembly. Male 3/8"-24.

Order No. 10 - 9309
Universal rod end assembly. Male 1/4" - 28.

Order No. 10 - 9308
Universal rod end assembly. Male 1/2" - 20.

Economy Female Rod Ends



Order No. 10 - 8682
3/8" - 24 Female right hand thread ball joint. Manco 1414, Flexible Flyer 00251, Ariens 36531, Carter Brothers G207, Murray 680070. Fits go-carts & wagons.

WHEEL & DECK ACCESSORIES



Ball Joints



Order No. 10 - 2208

Ball Joint Assembly. 1/4"-28. Right hand threads. Replaces Snapper 15753.

Order No. 10 - 2209

Ball Joint Assembly. 5/16"-24, replaces Grasshopper 265615. Right hand threads.

Order No. 10 - 2210

Ball Joint Assembly. 3/8"-24. Right hand threads. Replaces Snapper 10745, AYP 109850X, Murray 21031 and MTD 723-0156, 723-3018 & 923-3018. Fits most of Murray & MTD riders.

Order No. 10 - 2211

Ball Joint Assembly. 7/16"-20. Right hand threads.

Order No. 10 - 9159

Ball joint assembly replaces MTD 723-0448A & 923-0448A. Fits all MTD lawn and garden tractors from 1997 - present, except model 995. Used on new style draglink. Size 7/16" - 20 female x 3/8" - 24 male.

Order No. 10 - 2212

Ball Joint Assembly. 1/2"-20. Right hand threads.

Order No. 10 - 11031

Ball joint assembly replaces MTD 923-3018 / 723-3018. RH threads. Short male threads. Size 3/8" - 24.(Special)

Ball Joint Assembly for AYP



Order No. 10 - 9489

3/8" - 24 Left hand ball joint replaces AYP 109851X. Also replaces MTD 923-0351.

Universal Adjustable Yoke End



Order No. 10 - 9142

Universal adjustable yoke ends. 5/16" - 24 female, for 5/16" pin. Replaces Bobcat 38020, Exmark 1-303105, Grasshopper 265537 & Dixie Chopper 20214.

Order No. 10 - 9141

Universal adjustable yoke ends. 1/4" - 28 female, for 1/4" pin.

Order No. 10 - 9143

Universal adjustable yoke ends. 3/8" - 24 female, for 3/8" pin. Replaces Exmark 1-633131, John Deere M80373, Grasshopper 265545 & Noma 305530.

Order No. 10 - 9150

Universal adjustable yoke ends. 1/2" - 20 female, for 1/2" pin. Replaces John Deere T21158.

Ball Joint for GRASSHOPPER



Order No. 10 - 13451

Left hand ball joint replaces Grasshopper 265616. Plated steel, female 5/16" - 24 LH.

Ball Joint for JOHN DEERE



Order No. 10 - 13457

Left hand ball joint replaces John Deere AM100645. Also replaces AM32869. 1/2" - 20, Right hand, male thread ball joint with 1/2" - 20 LRH. Left hand threads on internal. Female threads.

Ball Joint for JOHN DEERE



Order No. 10 - 12450

1/2 -20 right hand female threads with 7/16 - 20 male stud. Ball joint replaces John Deere AM125418, AM39889. Fits 1990 thru 2007 all LX, GT and older 100, 200, and 300 series lawn tractors.

WHEEL/DECK ACC. 10



WHEEL & DECK ACCESSORIES

Caster Yoke Spacers



ID 7/8"
OD 1-1/2"
Thickness 1/2"

Order No. 10 - 8190

Caster yoke spacer replaces Scag 43037-01 and Exmark 303314. Used with our 10-8189 support arm.



ID 1"
OD 1-3/4"
Thickness 1/4"

Order No. 10 - 6885

Caster Yoke Spacers. Replaces Bobcat 64163-07.



ID 3/4"
OD 1-1/4"
Thickness 1/4"

Order No. 10 - 2238

Caster Yoke Spacers. Replaces Bobcat 64163-71, 64163-14. Also fits Bunton PL0417.



ID 1"
OD 1-11/16"
Thickness 1/2"

Order No. 10 - 6886

Caster Yoke Spacers. Replaces Bobcat 64163-22. Used on our 10-6581 & 10-6582 caster yoke.

Blade Spacer



ID 5/8"
OD 1"
Thickness 1/4"

Order No. 10 - 1191

Blade Spacer. Replaces Ransomes/Bobcat 64163-12, Bunton PLO617, Exmark 1-303164, Scag 43278, 43038, Snapper 7076436.

Blade Spacer



ID 5/8"
OD 1-1/2"
Thickness 1/4"

Order No. 10 - 8372

Blade Spacer. Replaces Scag 43278 & 43592. Fits all Scag commercial mowers blades.

Blade Spacer



ID 5/8"
OD 1"
Thickness 1/2"

Order No. 10 - 7249

1/2" Blade spacer used on Scag, Bobcat, Bunton, Snapper and Exmark.

Idler Arm Spacer for SCAG



ID 3/4"
OD 7/8"
Height 1/2"

Order No. 10 - 8304

Idler arm shaft spacer replaces Scag 48100-05. Fits 32", 36", 40", 48", 52", 61" and 72" decks. MIN010

Shaft Spacer for MURRAY



ID 5/8"
OD 7/8"
Height 11/16"

Order No. 10 - 8308

Shaft spacer replaces Murray 23213. Fits 42" Murray deck, center pulley spacer. Fits models 8-38222, 7-39004.

Spacer for SNAPPER



ID 3/4"
OD 1"
Length 7/8"

Order No. 10 - 9513

Left hand spacer replaces Snapper 7032114. Fits Snapper extra tough series. For 28", 30", 33" & 41" rear engine riders.

Shaft Spacer for STIGA



Order No. 10 - 9541

Shaft spacer replaces Stiga 1134-0051-05. 2" (50mm) length, 11/16" (17mm) OD.

Spindle Bearing Spacer for DIXIE CHOPPER



ID 1"
OD 1-1/4"
Length 2-3/4"

Order No. 10 - 10081

Spindle bearing spacer replaces Dixie Chopper 30219.

10
WHEEL/DECK ACC.



WHEEL & DECK ACCESSORIES

Wheel Spacer for TORO

OD 5/8"
Length 4-1/4"



Order No. 10 - 9874

Wheel spacer replaces Toro 99-2842. Fits Toro Z Master anti-scalp roller wheel bolt.

Rubber Space Set for BLUEBIRD



Order No. 10 - 8741

Rubber space set replaces Bluebird 5004. Fits lawn comber rotor, models F20 & F20B. Used with our 15-6324 flail blade set, 10-8755 shaft set & 09-8863 bearing. 48 pieces per set.

Snap Ring



Order No. 10 - 5706

Snap Ring. Replaces Bunton PLO410, Ransomes/Bobcat 64144-12. 1" Snap Ring. MIN010

Front Seal Wheel Bearing for EXMARK

ID 1-1/8"
OD 1-3/4"
Width 7/16"



Order No. 10 - 10013

Front seal wheel bearing replaces Exmark 633580. Fits Lazer Z units. MIN005

Caster Yoke Bearing Seal for EXMARK

ID 1-1/4"
OD 2"
Width 1/4"



Order No. 10 - 10014

Front caster yoke bearing seal replaces Exmark 543511.

Oil Seal for TORO

ID 1-1/2"
OD 2.125"
Height .312"



Order No. 10 - 12756

Oil seal replaces Toro 253-139. Fits Groundmaster 217 & 220 with 52" & 62" deck spindles. Double lip, spring loaded, metal outer. MIN005

Wheel Washer for SCAG

ID 21/32"
OD 1-1/8"
Thickness 1-1/16"



Order No. 10 - 7779

Wheel washer used in our wheel bearing kit 09-7780 and with our 06-3276 wheel assembly. MIN010

Wheel Washer for BUNTON

ID 3/4"
OD 1-1/4"
Thickness 3/32"



Order No. 10 - 8412

Wheel washer replaces Bunton Z35010. Fits Velke VKWHEEL 9 x 350 x 4 caster wheel assembly our 08-8575. Fits Bunton 36", 48", 52" & 61" cut midsize front cut riders. Fits Honda HRC 7013, 36" & 48" midsize. Also replaces Honda 4034054, 4034062, 4034112, 4033106. MIN010

10
WHEEL/DECK ACC.



WHEEL & DECK ACCESSORIES

Wheel Bolt Washers for LAWN-BOY



Order No. 10 - 440

Felt washer for wheel bolt. Replaces Lawn-Boy 605255.
MIN010

Spacer Washer for AYP



ID 43/64"
OD 1-1/8"
Thickness 5/32"

Order No. 10 - 11474

Spacer washer replaces AYP 187690. Used with our 10-8479, 10-8549, 10-9519, 10-9520, 10-9574 & 10-9575 mandrel assemblies and shafts.
MIN010

Belleville Washer for DIXIE CHOPPER



ID 1"
OD 2"
Thickness .120"

Order No. 10 - 10560

Belleville Washer replaces Dixie Chopper W-137. Used in Dixie Chopper 10161 & 10161L spindle assemblies. (2) per assembly, (6) per unit.
MIN010

Yoke Washer for TORO



ID 1-3/16"
OD 1-3/4"
Thickness 1/8"

Order No. 10 - 8418

Yoke washer replaces Toro 3-6781. Fits Toro midsize mowers 36", 37", 44", 52" & 62" cut decks. Models 30136, 30137, 30144, 30152, 30162. Used with our 10-8477 yoke. MIN010

Washer for SNAPPER



ID 3/4"
OD 1-1/8"
Thickness 1/16"

Order No. 10 - 8493

Washer replaces Snapper 7010935. Fits 25", 26", 28", 30" & 33" rear engine riders. Used in our 10-8322 front end repair kit.
MIN010

Hex Nut for DIXIE CHOPPER



ID 1"
OD 1-1/2"

Order No. 10 - 10559

Hex nut replaces Dixie Chopper N-167. Used in Dixie Chopper 10161 & 10161L spindle assemblies. (1) per assembly, (3) per unit.
MIN005

Jackshaft Lock Nut for MURRAY

Size 1/2" - 20



Order No. 10 - 9296

Jackshaft locknut replaces Murray 15x72. Locknut for our 10-2925 spindle assembly & 10-8320 spindle repair kit.
MIN010

Jackshaft Nut for MURRAY

Size 9/16" - 18



Order No. 10 - 9329

Jackshaft nut replaces Murray 15x100. Fits Murray splined shafts. Hex head.
MIN010

10
WHEEL/DECK ACC.

WHEEL & DECK ACCESSORIES



Wheel Nut for TORO



Size 1/2" - 13

Order No. 10 - 8447

Wheel bolt nut replaces Toro 32153-5. Also replaces Exmark 804509. Fits our wheel bolt **10-8411** & **10-8419**. MIN010

Hex Nut



Size 5/8" - 18

Order No. 10 - 5705

Hex Nut. Replaces Bunton Z32008.

Lock Nut for SNAPPER



Size 5/16" - 24

Order No. 10 - 8448

Hub bolt lock nut replaces Snapper 11201. Lock nut for our hub bolts **10-7885** & **10-7886**. (Lock nut). MIN010

Lock Nuts



Order No. 10 - 321

Lock Nuts only 3/8" coarse.

MIN010

Hex Nut for SCAG



Size 1/2"-13

Order No. 10 - 11076

Hex nut replaces Scag 0421-07. Used on our **10-11040** & **10-11041** wheel bolts. MIN010

3/4" Locknut for EXMARK



Size 3/4"-10

Order No. 10 - 11039

Locknut replaces Exmark 3296-51. 3/4" -10. Used with our **10-10194** Yoke. MIN005

Flanged Nut for MTD



Size 5/8"-18

Order No. 10 - 10228

Flanged nut replaces MTD 712-0417 and 912-0417A. 5/8" thread. Blade spindle nut used on our **9285**, **9284**, **9286**, **9287**, **9516**, **9515**, **9518**, **9288** and **9517**.

Blade Bolt Nut for SCAG



Size 5/8"-11

Order No. 10 - 11565

Blade bolt nut replaces Scag 04020-09. 5/8" x 11 thread. Used with our **10-8343** blade bolt. MIN010

Blade Bolt for Bunton



Order No. 10 - 5704

Blade Bolt. Replaces Bunton PLO815. 5/8" x 9" Overall length.

Screw/Blade Bolt for EXMARK



Order No. 10 - 12633

Screw/Blade bolt replaces Exmark 3213-6. 1/2" -20 x 2-1/4", Grade 8. Fits Triton blades. MIN010

Order No. 10 - 13240

Screw/Blade bolt replaces Exmark 3213-5. 1/2" -20 x 2", Grade 8. MIN010

Order No. 10 - 13504

Screw/Blade bolt replaces Exmark 103-1026. 5/8" - 11 x 1", Grade 8. MIN010

Blade Bolt for CUB CADET



Order No. 10 - 12622

Blade bolt replaces Cub Cadet 710-04226. Fits LT 1000 series riders and Cub Cadet 618-04123B spindle assembly. For 38", 42", 46" & 50" decks. Size 3/4" - 16 x 5.85"

10
WHEEL/DECK ACC.



Blade Bolt for EXMARK

Order No. 10 - 11566

Blade bolt replaces Exmark 103-0862. 5/8" -18 thread x 2-3/4", cap screw, yellow zinc. MIN010



Blade Bolt for Scag

Thread Size 5/8"
Length 9-1/2"



Order No. 10 - 8343

Blade Bolt. Replaces Scag 04001-41. Fits Scag midsize mower 32", 40", 48", 52", 61", 72" cut. 1/2" x 9-7/8" Overall length

Blade Bar Bolt for SNAPPER

Size 1/2" - 20 x 1-1/4"



Order No. 17 - 12268

Blade bar bolt replaces Snapper 7090491. Used with our 17-5847 blade bar. MIN010

Universal Wheel Bolt



Order No. 10 - 310

Consists of Bolt, Spacer and Nut. Fits all 1/2" hubs. Adjustable length from 1-1/4" to 2" plated. MIN010

Order No. 10 - 10310

Universal Wheel Bolt. (carded) 2 per card. MIN005

Wheel Bolts



3/8"-16



Order No.	Shoulder Length	Packaged Qty.	
10 - 311	1-5/16"	10	MIN010
10 - 312	1-3/8"	10	MIN010
10 - 313	1-7/16"	10	MIN010
10 - 314	1-1/2"	10	MIN010
10 - 315	1-9/16"	10	MIN010
10 - 316	1-5/8"	10	MIN010
10 - 317	1-3/4"	10	MIN010
10 - 318	1-7/8"	10	MIN010
10 - 319	2"	10	MIN010
10 - 320	2-1/4"	10	MIN010
10 - 7115	2-1/2"	10	MIN010
10 - 7116	2-3/4"	10	MIN010
10 - 7117	3"	10	MIN010
10 - 7118	3-1/4"	10	MIN010
10 - 7212	4"	10	MIN010

Shoulder Bolt for AYP

Overall 3-5/8"

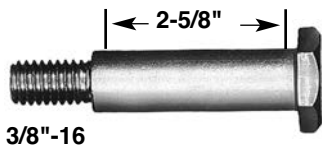

3/8"-16

Order No. 10 - 11142

Shoulder bolt replaces AYP 184219 / 137644, 193406, Cub Cadet 938-3056, John Deere 193406. Fits deck wheels on riders 2003 & up. MIN010

Note: **Order No. 10 - 313** Fits our standard plastic wheels.

Order No. 10 - 312 Fits our standard steel wheels.

Wheel Bolt for EXMARK

Thread Size 1/2"
Length 6"



Order No. 10 - 8411

Wheel bolt replaces Exmark 1-800334. Fits Exmark midsize mowers with 36", 48", 52" & 60" decks. For models Turf Ranger, Turf Tractor, Viking & Metro models from 80000 series and higher. Used with our 10-8447 wheel bolt nut.

Anti Scalp Wheel Axle for EXMARK



Order No. 10 - 12017

Anti scalp wheel axle replaces Exmark 103-5364. Included in our 07-12018 wheel kit and our 10-12016 hardware kit.

10 WHEEL/DECK ACC.

WHEEL & DECK ACCESSORIES



Wheel Bolt

Thread Size 3/8"
Length 1-9/16"



Order No. 10 - 2964

Replaces Lawn-Boy 603441. Thread Run 3/8"-16. MIN010

Wheel Bolt

Size 3/4"-10 x 5



Order No. 10 - 5708

Replaces Ransomes/Bobcat 64123-86. For 8" Caster Wheel.

Wheel Bolt for SCAG

Size 1/2"-7-1/2"



Order No. 10 - 11040

Wheel bolt replaces Scag 04001-134, Exmark 325-36. Fits midsize mowers. Turf Tiger & Turf Cubs. Uses our 10-11076 nut.

Wheel Bolt for SCAG

Size 1/2"-9-1/2"



Order No. 10 - 11041

Wheel bolt replaces Scag 04001-167. Fits midsize mowers. Turf Tiger & Turf Cubs. Uses our 10-11076 nut.

Hub Bolt for SNAPPER (long)



Order No. 10 - 7886

Hub bolt replaces Snapper 7011013. For right hand side, used with our 08-7744 wheel hub. Fits 25" thru 33" Snapper rear engine riders. MIN010

Hub Bolt for SNAPPER (short)



Order No. 10 - 7885

Hub bolt replaces Snapper 7011035. For left hand side, used with our 08-7745 wheel hub. Fits 25" thru 33" Snapper rear engine riders. MIN010

Wheel Bolt Kit for VELKE

Size 1/2" - 20
Over all Length 4-29/32"



Order No. 10 - 8651

Wheel bolt kit replaces Velke VKAXLE2-2. Fits 9 x 350 x 4 cast-er wheel on all one wheel Velkes. Kits includes our 10-8412 washers, 10-8652 wheel bolt, 10-8653 lock nut.

Order No. 10 - 8652

Wheel bolt only for Velke. Fits 9 x 350 x 4 caster wheel on all one wheel Velkes. 1/2" - 20 x 4-29/32"

Order No. 10 - 8653

Lock nut only for Velke. Fits 9 x 350 x 4 caster wheel on all one wheel Velkes. Nylon insert lock nut, zinc plated. 1/2" - 20 MIN010

Wheel Bolt for TORO

Thread Size 1/2"
Length 5-1/4"



Order No. 10 - 8419

Wheel bolt replaces Toro 325-19 & Exmark 800334. Fits Toro commercial mid size 36", 37", 44", 52", 62" cut deck, models 30136, 30137, 30144, 30152, 30162. Fits Toro wheel 68-8970.

Steering Sector Gear for MURRAY



Order No. 10 - 13208

Steering sector gear replaces Murray 094121MA. Used on lawn tractors since 1997.

Steering Sector for SEARS

ID 1/2"



Order No. 10 - 6887

Steering Sector replaces Sears 102787X.

10
WHEEL/DECK ACC.



WHEEL & DECK ACCESSORIES

Mounting Bolt for AYP

Thread Size 5/16" - 18
Thread Length 1-1/4"



Order No. 02 - 9374

Hex head self-tapping screw replaces AYP 138776. Fits AYP, models PP 18hp, 44" 9540052-61 quill assembly. Mounting bolt for our 10-8479 quill assembly. MIN010

Mounting Bolt for AYP

Thread Size 3/8" - 16
Thread Length 3/4"



Order No. 02 - 9373

Hex head self-tapping screw replaces AYP 17490612. Fits AYP, Roper, Sears quill assemblies. Used with our quill assemblies 10-8649, 10-8647, 10-1171, 10-6813, 10-2914. MIN010

Shoulder Bolt for AYP



Order No. 10 - 8830

Shoulder bolt replaces AYP 131340. Fits 42" AYP vented decks. Used with our 09-9747. MIN010

Axle Nut & Screw for EXMARK



Order No. 10 - 12565

Axle nut replaces Exmark 3296-39. 3/8" - 16 nylock. Used in our 10-12016 & 10-12018 deck wheel kits. MIN010

Order No. 10 - 12564

Axle screw replaces Exmark 3211-46. 3/8" - 24 x 2. Used in our 10-12016 & 10-12018 deck wheel kits. Grade 8 MIN010

Anti-Scalp Roller Kit Hardware for EXMARK



Order No. 10 - 10007

Replaces Exmark 603602 bushing, 98-5961 bolt, 3290-357 nut, 373034 pivot washer & 98-5975 spring washer. Consist of 1 each of the above items. Used with our 07-6917 deck wheel.

Deck Wheel Hardware Kit for EXMARK



Order No. 10 - 12016

Deck wheel hardware kit for Exmark. Included in our 07-12018 wheel kit.

Carded Front End Repair Kit for SNAPPER



Order No. 10 - 8322

Front end repair kit for Snapper rear engine riders.

Deck Wheel Hardware Kit for JOHN DEERE



Order No. 10 - 10908

Deck wheel hardware kit fits John Deere. Used with our 08-10724 deck wheel. Includes bushings and hardware.

Front Axle Steering Arm for MTD



Order No. 10 - 8950

Front axle steering arm replaces MTD 683-0055 & 983-0055. Fits front engine rider models 620-689, 700-739, 1986 and after.

Shaft Support for AYP



Order No. 10 - 13225

Shaft support replaces AYP 160395/124035X. Fits Sears model 917.257360.

10 WHEEL/DECK ACC.



WHEEL & DECK ACCESSORIES

Steering Pinion for AYP

23" Length



Order No. 10 - 7782

Steering pinion replaces AYP 102817X. Fits front engine rider models L0815AR, L0814AR, L0794BR, L0815BR, L0794AR, L0784AR and L0774AR. Used with our **10-6887** steering sector.

Steering Gear Kit for MURRAY



Order No. 10 - 11996

Steering gear kit replaces Murray 402075. Fits many 1996 & later lawn tractors.

Spur Gear



ID 1/2"
OD 1-5/32"
Height 1-1/4"

Order No. 10 - 3215

Spur Gear. Replaces MTD 748-0203, 948-0203.

Steering Pinion Gear for MTD



Order No. 10 - 13360

Steering pinion gear replaces MTD 717-1554. Used with our **09-13229** bushing. Used on riders since 1999. 11 tooth splined bore.

Shaft for BLUEBIRD

Order No. 10 - 8755

Shaft with clip set replaces Bluebird 5002. Fits Bluebird Thatchers. **4 shafts and 8 clips per set.** Used with our **15-6324** flail blade set, **10-8741** spacer set & **09-8863** bearing.



Spline Shaft for MURRAY

Length 7"
OD 5/8"



Order No. 10 - 9906

Splined shaft replaces Murray 774091/94129. Fits Murray /Scotts 42" & 46" front engine riders. Uses our **8901** nut

Spline Shaft for MURRAY

OD 5/8"
Length 7-3/4"



Order No. 10 - 6890

Spline Shaft replaces Murray 91922 & 491922. Fits Murray riders with 38" decks & 42" decks. Uses our **8901** nut

Shaft for MURRAY

OD 5/8"
Length 6-1/4"



Order No. 10 - 7282

Replaces Murray 91921 & 491921. Fits 38" Murray front engine riders. Uses our **8901** nut

Variator Shaft for MTD

OD 9/16"
Length 3-13/16"



Order No. 10 - 7281

Variator Shaft replaces MTD 738-0569, 938-0569. Fits White models 666 and 686. Also fits Yardman. Uses our **09-7241** bearing.

Spindle Shaft for WHEEL HORSE

Bearing OD 1-1/2"
Shaft OD 3/4"
Over all Length 4-17/32"

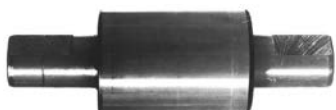

Order No. 10 - 3309

Replaces Wheel Horse 103119.

Spindle Shaft for SNAPPER



Order No. 10 - 7154

Spindle Shaft replaces Snapper 7021742, 7044785. Fits 25", 26", 28", 30" and 33" deck rear engine riders. Uses our **09-484** bearing. 1" OD, 10-1/16" length.

WHEEL/DECK ACC. 10



Spindle Shaft for MTD

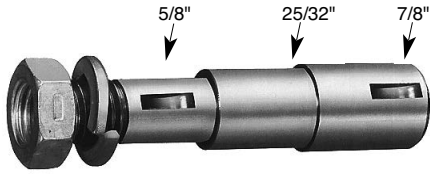

Order No. 10 - 3218

Spindle Shaft. Replaces MTD 738-0197. Length 3-15/16".

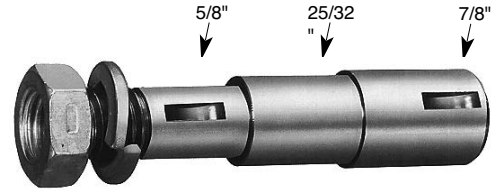

Order No. 10 - 3220

Spindle Shaft. Replaces MTD 738-0196/711-0255. Length 4".

Jackshaft for MURRAY



Order No. 10 - 2937

Jackshaft for Murray riders. Replaces 24578. 5-3/4" length, 5/8" OD has (2) 5/32" keyways.



Order No. 10 - 7284

Replaces Murray 23180. Center shaft for 42" mowers. Fits models 9-38219, 9-38211, 9-38222, 9-38004. 5/8" OD, 6-1/8" length.



Order No. 10 - 2931

Replaces Murray 21024, 20616. 6-7/16" length, 5/8" OD has (3) 5/32" keyways.



Order No. 10 - 7283

Replaces Murray 55272. 6" length, 5/8" OD, 1/2"-20 threads. Keyway 5/32".

Order No. 10 - 2904

Replaces Murray 20616. 5-1/4" length, 5/8" OD has (2) 5/32" keyways.

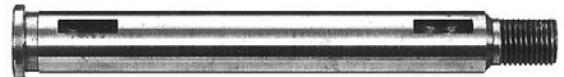

Jackshaft for MURRAY

Order No. 10 - 13605

Jackshaft replaces Murray 092849MA. Fits 38"-42" decks. Length 7.92"





WHEEL & DECK ACCESSORIES

Mandrel Assembly, Housing & Shaft for AYP/HUSQVARNA

Order No. 10 - 8479

Complete Mandrel assembly replaces AYP 130794. Fits 36", 38", & 42" AYP/Sears/Roper with ventilated decks using 5 point star center hole blades. Uses our **09-442** & **09-8507** bearings.

Order No. 10 - 8549

Mandrel shaft replaces AYP 137646. Fits 36", 38" & 42" Sears AYP mowers with ventilated decks. 3/4" OD shaft, 7" long. Comes with our **09-442** bearing. Shaft for our **10-8479** quill assembly.

Order No. 10 - 8548

Mandrel housing replaces AYP 128774. Housing only for our **10-8479** quill assembly.

Order No. 10 - 8901

Pulley lock nut replaces AYP 137266 & 139729, 178342, 4002434. Fits our **10-8479** Spindle Assembly. Size 9/16" - 18. Also replaces Murray 15x140

Order No. 10 - 12723

Spindle assembly replaces AYP 130794. Six Pack.

MIN006

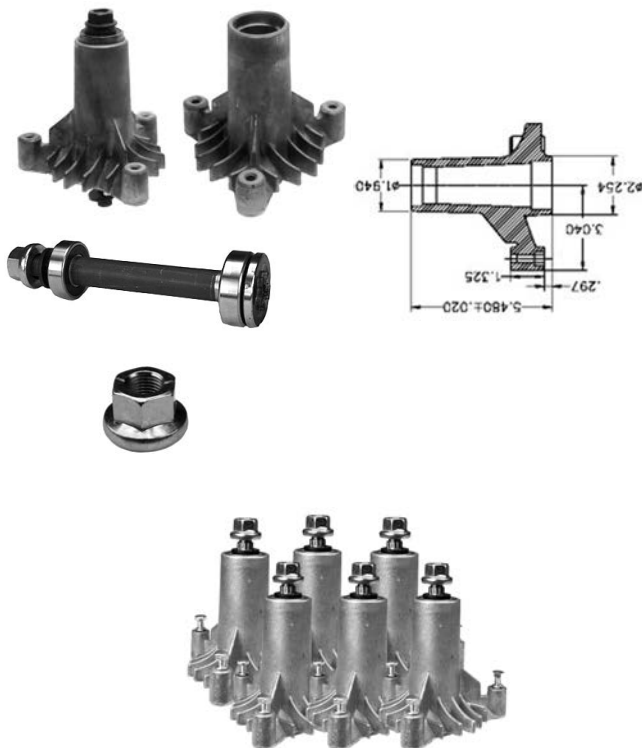

Spindle Assembly, Housing & Shaft for AYP/HUSQVARNA

Order No. 10 - 9519

Spindle assembly replaces AYP 143651. Fits 44", 46" & 50" decks with star center hole blade.

Order No. 10 - 9520

Spindle shaft only replaces AYP 137553. Used with our **10-9521** housing. Includes our **09-442** bearing. Double hex external spline for pulley. For top bearing use our **09-8507**.

Order No. 10 - 9521

Housing only replaces AYP 137152. Used with our **10-9520** spindle shaft. Cast aluminum housing. 3 bolt mounting.

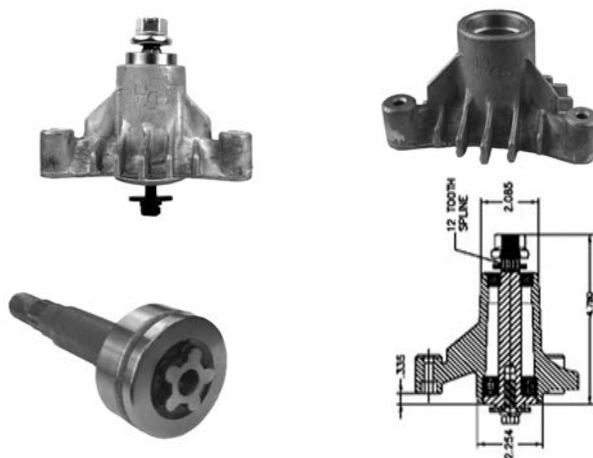

10

WHEEL/DECK ACC.

Spindle Assembly & Mandrel Shaft for AYP/HUSQVARNA

Order No. 10 - 9574

Spindle assembly replaces AYP 165579. Fits 36" rear discharge mowers. Assembly includes our **10-9575** shaft, **10-8548** housing & **10-8901** pulley lock nut. Uses our **17-9586** blade bolt. 6 pt star, L/H treads.

Order No. 10 - 9575

Mandrel shaft with bearings replaces AYP 165482. Mandrel shaft for our **10-9574** spindle assembly. Includes 1 bearing, 2 washers. Uses our **17-9586** blade bolt.





Spindle Assembly for AYP

Order No. 10 - 11014

Spindle assembly replaces AYP 174356. Spindle shaft fits 48" decks built after 2001. Also replaces Husky 532-174356.

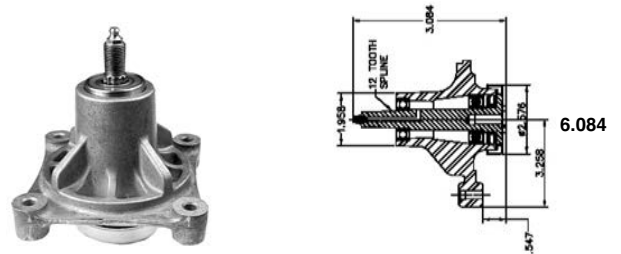

Spindle Assembly for AYP

Order No. 10 - 11590

Spindle assembly replaces AYP 187292, 192870. 4 hole mount. Taller version of our 10-11014 spindle assembly. Fits (2) blade 46" deck.

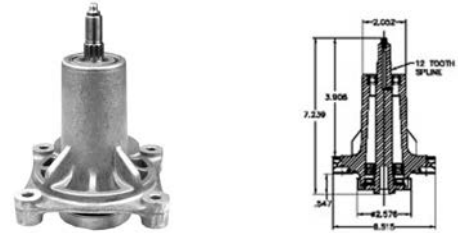

Order No. 10 - 11591

Spindle Housing only replaces AYP 187281. 4 hole mount. Fits our 10-11590 spindle assembly.



Order No. 10 - 11592

Spindle Shaft only replaces AYP 187291. Shaft with bearing with grass shield & zerk. Fits our 10-11590 spindle assembly.



Order No. 10 - 12734

Spindle assembly replaces AYP 187292. Six Pack.

MIN006



Spindle Housing for AYP



Order No. 10 - 12307

Spindle housing replaces AYP 174358. Housing only for our 10-11014 spindle assembly.

Spindle Shaft for AYP



Order No. 10 - 12308

Spindle shaft replaces AYP 174360. Spindle only for our 10-11014 spindle assembly.

WHEEL & DECK ACCESSORIES



Spindle Assembly for BAD BOY



Order No. 10 - 13090

Spindle assembly replaces Bad Boy 037-6016-00. Long shaft, fits models 2004 and Up.



Order No. 10 - 13089

Spindle assembly replaces Bad Boy 037-6015-00 / 037-6015-50. Old style, fits CZT models 2010-2012.

Spindle Assembly & Shaft for BOBCAT



Length 6-1/4"
OD 1"

Order No. 10 - 1227

Spindle Assembly 6-1/4". Replaces Ransomes/Bobcat 36082N, Exmark 1-402006, Snapper 7059964 & 7076645. For 48" Deck. (long shaft)

Spindle Assembly



Order No. 10 - 9375

Spindle assembly replaces Bobcat 36567. Fits 36" & 48" XM series mowers.

Spindle Assembly



Order No. 10 - 1226

Spindle assembly 5-1/8". Replaces Ransomes/Bobcat 36006N, Snapper 70362024, 7059759 & 7076379, 70101455. Exmark 1-302030, Jacobson 552188. For 32" and 36" decks. (short shaft)

Spindle Assembly & Shaft for BUNTON



Length 6-1/2"

Order No. 10 - 8187

Spindle Assembly Dia. 25mm. Replaces Bunton PL6140A, PL4606A, PAL0806A, John Deere AM-106236, PT8633. Fits 36", 40", 48", 52" and 61" cut. (6-1/2" spindle shaft).

Order No. 10 - 8188

Spindle shaft only. Replaces Bunton PL4607. Shaft only for our 10-8187 assembly. Length 6-1/2".

Spindle Assembly & Shaft for CASTELGARDEN



Order No. 10 - 50256

Spindle assembly replaces Castelgarden 82207200/0. Left hand spindle. For models TC102 & TC122.

Spindle Assembly & Shaft for CASTELGARDEN

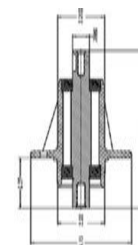

Order No. 10 - 50257

Spindle assembly replaces Castelgarden 82207201/0. Right hand spindle. For model TC92.

WHEEL/DECK ACC. 10



Spindle Assembly for CASTLEGARDEN



Order No. 10 - 12706

Spindle assembly replaces Castlegarden 82207202/0. Fits TC92, left hand threads. 92CM Decks. For model TC92.

Spindle Assembly for CASTLEGARDEN



Order No. 10 - 12966

Spindle assembly replaces Castlegarden 82207203/0, right hand fits TC92. Left hand threads fits 92CM decks. For Castlegarden Twin Cut TC102 + 122. (1,02m/40 + 1,22m/48)

Spindle Assembly for CUB CADET



Order No. 10 - 11963

Spindle assembly replaces Cub Cadet 618-04129B, 918-04129B. Fits 54" decks models LT1024, LT1050, SLT 1554. With grease fitting and tapered bearings. Uses our 10-11961 housing.

Order No. 10 - 11962

Spindle assembly replaces Cub Cadet 618-04126. Fits some 50" cut decks. Fits series 1000. Model LT1050.

Spindle Assembly for CUB CADET



Order No. 10 - 14328

Spindle assembly replaces Cub Cadet 918-04889A, 918-04822A, 618-04822A, 618-04950. Fits LTX1040 tractor (2010 & after), 13AX90AS010, 13RX90AS056, 13AX90AS009, 13WX90AS010, 13WX90AS009, 13AX90AS209, 13RX90AS256, 13WX90AS209. LTX1042 tractor (2010 & after), 13AX9124010 (2010), 13WX91AS010 (2010).

Order No. 10 - 11961

Spindle assembly replaces Cub Cadet 618-3129C, 918-04129B. Fits series models 2130, 2146, 2155, 2164 & 2166, for 38", 42" & 44" cut decks. Includes upper and lower tapered roller bearings and seals, spacer & housing. 3/4" bore. Uses our 09-813 bearings. Fits our 10-11963 spindle assembly.



Spindle Assembly for CUB CADET



Order No. 10 - 14329

Spindle assembly replaces Cub Cadet 918-04825B, 918-05016, 618-04825, 618-05016. Fits LTX1050VT tractor (2010 & after), 13VR91AP010 (2010), 13WR91AP010 (2010), 13VR91AP009 (2010), 13WR91AP009 (2010). PULLEY DIA. 5.3". Uses our 13-11711 pulley.

ID 1-1/4"
OD 1.874"
Height .25"



Order No. 10 - 12535

Oil seal replaces Cub Cadet 921-3018A / 721-3018A. Fits our 10-11961 spindle. MIN005

WHEEL & DECK ACCESSORIES



Spindle Housing for CUB CADET



Order No. 10 - 12871

Spindle housing replaces Cub Cadet 619-04183A / 619-04199 Fits LTX1042 Timed Deck & LTX1045 46" standard deck. Fits 2009-Up 46" decks with 2 blades. Fits our **10-13029** Spindle Assembly.

Spindle Assembly for CUB CADET



Order No. 10 - 13029

Spindle assembly replaces Cub Cadet 918-04865A, 918-04636, 618-04636. Fits 2009-up models LTX1045 series 46" decks with 2 blades. New style 6 pt star. Pulley Dia 6-1/2".

Spindle Assembly for CUB CADET



Order No. 10 - 12883

Spindle assembly replaces Cub Cadet 618-0427C, 918-0427C. Fits models 1170, 1600, 1800 and RZT mowers with 42" decks using star hole blades. Uses Cub Cadet 756-1188 & 618-0324, 918-04197, 618-04197 5-9/16" pulley.



Order No. 10 - 12973

Spindle assembly replaces Cub Cadet 918-0659, 618-0659. Fits models LT1040, LT1042 & RTZ mowers with 42" decks using star hole blades.



Order No. 10 - 13001

Spindle assembly replaces Cub Cadet 918-04124A, 718-04124A. Fits models LT series mowers with 42" decks using round hole blades.

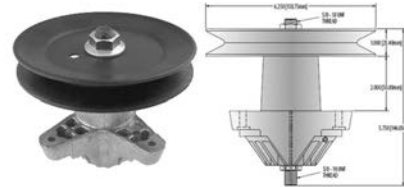

Order No. 10 - 13131

Spindle assembly replaces Cub Cadet 918-04461, 618-04461. Fits models LT series mowers with 42" decks using star hole blades.

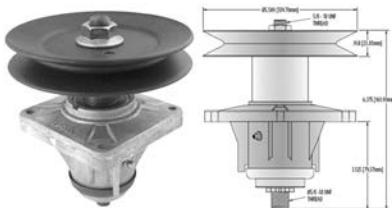

Order No. 10 - 12967

Spindle assembly replaces Cub Cadet 918-0660, 618-0660. Fits models LT1045, LT1046 and I1046 series mowers with 46" decks using star hole blades.



Order No. 10 - 12236

Spindle assembly replaces Cub Cadet 918-04123B, 618-04123B. Fits models LT series mowers with 46" decks using round hole blades.

10

WHEEL/DECK ACC.



**Spindle Assembly for
CUB CADET**



Order No. 10 - 12660

Spindle assembly replaces Cub Cadet 918-0429, 618-0429, 618-0269, 918-0269. Fits mowers with 50" decks.



Order No. 10 - 12659

Spindle assembly replaces Cub Cadet 918-0428A, 918-0268, 618-0428, 618-0428A, 618-0268, 618-0268A. Fits mowers with 50" decks.



Order No. 10 - 12972

Spindle assembly replaces Cub Cadet 618-0595A, 618-0595B, 918-0595B, 918-0595A. Fits later model 46" deck - 800 series. Double pulley. Fits star hole blades.

**Spindle Shaft for
DIXIE CHOPPER
(Short Shaft)**

Length 8"
OD 1"



Order No. 10 - 9949

Spindle shaft only. Replaces Dixie Chopper 30217.

**Spindle Shaft for
DIXIE CHOPPER
(Long Shaft)**

Length 9-1/2"
OD 1"



Order No. 10 - 9950

Spindle shaft only. Replaces Dixie Chopper 30217-L.

**Spindle Assembly for
DIXIE CHOPPER
(Long Shaft)**



Order No. 10 - 12808

Spindle assembly replaces Dixie Chopper 300442. Spindle housing with bearings, seals, long shaft.

**Spindle Housing for
DIXIE CHOPPER**

Order No. 10 - 12806

Spindle housing replaces Dixie Chopper 300440. Spindle housing with bearings, seals. Housing for our 10-12808 & 10-12807 spindle assembly.



**Spindle Assembly for
DIXIE CHOPPER
(Short Shaft)**

Order No. 10 - 12807

Spindle assembly replaces Dixie Chopper 300441. Spindle housing with bearings, seals, short shaft.





WHEEL & DECK ACCESSORIES

Spindle Assembly for EXMARK



Order No. 10 - 13007

Spindle assembly replaces Exmark 103-8323 & 103-3206. Fits 72" decks on Laser Z, XP series models. Serial number 252,000 and up.

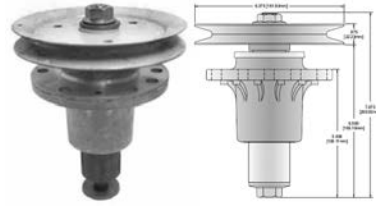

Order No. 10 - 13130

Spindle assembly replaces Exmark 103-1140. Fits 48" decks on Laser Z, HP models.

Spindle Assembly for EXMARK



Order No. 10 - 13540

Spindle assembly replaces Exmark 109-2102. Fits 46", 48", 50", new style Triton Decks. Also fits Lazer Z hp.



Spindle Assembly for GRAVELY



Order No. 10 - 14230

Spindle assembly replaces Gravely 59202600. Fits models GR, HR, PM & ZT series. Center spindle. Includes mounting hardware.

Spindle Assembly for GRAVELY



Order No. 10 - 14252

Spindle assembly replaces Gravely 59201000. Fits models GR, HR, PM series. Outer, left & right spindle. Includes mounting hardware.

Spindle Assembly for GREAT DANE



Order No. 10 - 12778

Spindle assembly replaces Great Dane 200262 & D18030. Fits latest models. New heavy duty style with mounting studs.

Spindle Shaft for GREAT DANE



Order No. 10 - 12383

Spindle shaft replaces Great Dane D18048 old style. Fits our 10-9754 spindle which has been discontinued.

10 WHEEL/DECK ACC.

WHEEL & DECK ACCESSORIES



Spindle Assembly for HUSQVARNA

Order No. 10 - 13091

Spindle assembly replaces Husqvarna 966956101. Also replaces Husqvarna/Yazoo Kees Spindle Assembly 966956101, 539114820/539131383. Fits 52" & 61" decks. Also fits Dixon Kodiak models.



Spindle Assembly for HUSTLER



Order No. 10 - 12459

Spindle assembly replaces Hustler 796235. Fits Super Z with 52", 66" & 72" decks. Cast iron housing. Uses our **10-12491** replacement shaft.



Order No. 10 - 12491

Spindle shaft replaces Hustler 796227. Fits Super Z with 52", 60" & 72" decks. Fits our **10-12459** spindle assembly.

Spindle Assembly for HUSTLER



Order No. 10 - 12241

Spindle assembly replaces Hustler 350595. Fits Super Z with 52", 60" & 72" decks. Cast iron housing.



Order No. 10 - 12833

Spindle shaft replaces Hustler 788547. Fits Super Z with 52", 60" & 72" decks. Fits our **10-12241** spindle assembly.

WHEEL/DECK ACC. 10

Spindle Housing for HUSTLER



Order No. 10 - 14036

Spindle housing replaces Hustler 034843. Fits our **10-12241** & **10-12459** spindle assembly.

Spindle Assembly for HUSTLER



Order No. 10 - 11452

Spindle assembly replaces Excel/Hustler 783506. Fits Fast Trak, Mini Z & Super Mini Z models.



Spindle Assembly for JOHN DEERE



Order No. 10 - 11274

Spindle assembly replaces John Deere AM108925 with pulley. Fits 38" deck on LX and GT series tractors.

Spindle Assembly for JOHN DEERE

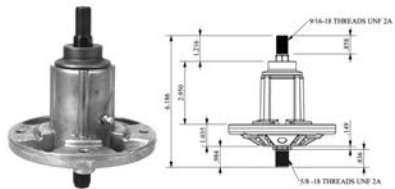

Order No. 10 - 12495

Spindle assembly replaces John Deere GY21099 & GY20867. Fits LA150 & LA175, G110, 190C mowers with 54" decks. 7 point spline.



Order No. 10 - 13234

Spindle assembly replaces John Deere AM136733. Fits EX-TRAK models X300, X300R, X304, Z225 & Z245.



Order No. 10 - 12910

Spindle assembly replaces John Deere GY21098, GY20454, GY20962. Fits LA100-LA165 series mowers since 2006. 7 point spline. Used on 42", 48" & 54" decks.



Order No. 10 - 13385

Spindle assembly replaces John Deere TCA17517. Fits Z-Trak mowers.

Spindle Assembly with Pulley for JOHN DEERE



Order No. 10 - 11278

Spindle assembly with pulley replaces John Deere AM121342. Fits 48" & 54" deck on some LX & GT series tractors. Pulley included.

Spindle Assembly for JOHN DEERE



Order No. 10 - 11964

Spindle assembly replaces John Deere GY20454. Fits 100 series riders since 2006. 7 point star. Used on 42", 48" & 54" decks.

10 WHEEL/DECK ACC.

WHEEL & DECK ACCESSORIES



Spindle Assembly for JOHN DEERE

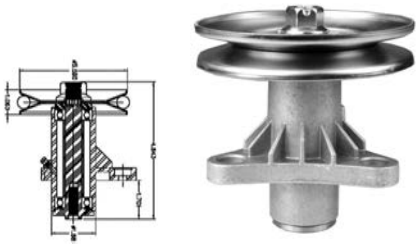

Order No. 10 - 11037

Spindle assembly replaces John Deere AM126226. Fits 1438GS & 1438HS Sabre, 1438GS Europro lawn tractors, 15.538GS, 15.538HS Sabre & 1538GS lawn tractors, 1542GS, 1542HS, 15.542HS Sabre & 1542GS Europro lawn tractors, 1642HS, 1642V-Twin H, 1642V-Twin G Sabre & 1642H Europro Lawn tractors, S16642 & S1742 lawn tractors, 1742GS & 1742HS Sabre lawn tractors, 97-14HS Sabo lawn tractor, 107-17HS Sabo lawn tractor, LT160 & LT180 lawn tractors.

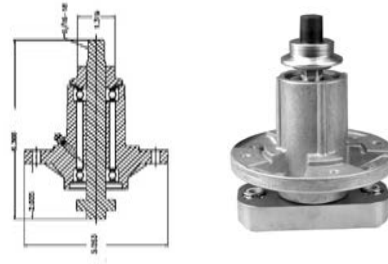

Order No. 10 - 11206

Spindle assembly replaces John Deere GY20050/GY20785. Fits L-100, L110, L120 & L130 models with 42" & 48" decks. Fits current Home Depot models.

Order No. 10 - 14168

Spindle assembly replaces John Deere TCA13807. Fits 48" & 60" mower decks for F620, F680 and F687 Z-Trak mowers. F687 48" & 54" decks for 1420, 1435, 1445, 1545, 1565. F725, F735, 777, 797 - 60" & 72" decks. 737, 757 - 54" & 60" decks. 717A, 727A, 48" & 54" decks.



Pulley Brake Disc for MTD

Order No. 10 - 9145

Pulley brake disc replaces MTD 09322. Fits 38" & 42" cut, model series 600, 805, 800, 739, 750-769. Spindle brake disc for drive pulley.



ID 5/8"
OD 4-7/8"

10
WHEEL/DECK ACC.

Shaft for MTD



Order No. 10 - 13974

Spindle shaft only for our 10-9288 Spindle.

Spindle Housing for MTD



Order No. 10 - 13604

Spindle housing only replaces MTD. Fits MTD 38" & 42" decks, 600 series, 1997 and newer. Fits our 10-9288, 10-11962, 10-12219, 10-12066, 10-12883 & 10-13131 spindles.



WHEEL & DECK ACCESSORIES

Spindle Assembly for MTD



Order No. 10 - 12448

Spindle assembly replaces MTD 618-0431 / 918-0431. Fits 46" decks. Used with our 10-9286 spindle assembly. 5" pulley dia., overall length 6-3/4", left side spindle.

Spindle Assembly for MTD

Over all Length 5-1/2"

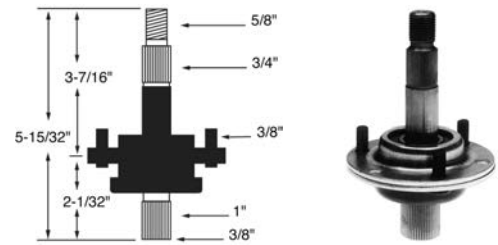

Order No. 10 - 7156

Spindle Assembly replaces MTD 717-0900A. Fits 36" decks. Uses (2) of our 09-442 bearings.

Spindle Assembly & Shaft for MTD



Order No. 10 - 9286

Spindle assembly replaces MTD 918-0240, 918-0430A. Without pulley. Fits 46" cut, star hole blades from 1998-2000. Uses single pulley. Right/Center assembly.

Order No. 10 - 9518

Spindle shaft only for our 10-9286 spindle assembly for MTD. Length 5-3/16", OD .785", Blade Nut & Pulley Nut Thread 5/8" - 18.

Spindle Assembly for MTD



Order No. 10 - 12219

Spindle assembly replaces MTD 618-0624 / 918-0624. Fits most 2005-2006, 42" riding mowers. Also replaces Toro model LX420 or 13ZX60RG544, part number 112-0460. Comes complete with our 13-12682 pulley. Pulley dia. 6-5/16, spindle height 6-3/8".

Order No. 10 - 12926

Spindle shaft replaces MTD 738-1010A & Toro 112-0884. Fits 42" & 50" decks. Fits our 10-12219 spindle assemblies. 6-3/8" long.

Spindle Assembly for MTD



Order No. 10 - 13220

Spindle assembly replaces MTD 918-3167 / 618-3167 (2013), Troy Bilt 14115, 38" decks (GW-6183167). Also fits Cub Cadet model 250.

Spindle Assembly for MTD



Order No. 10 - 12612

Spindle assembly replaces MTD 918-0671B / 618-0671. Fits 54" decks, 800 series with star hole blades. Includes pulley. 5.39" pulley dia. x .5625 width.

Spindle Assembly for MTD

Order No. 10 - 13631

Spindle assembly replaces MTD 918-04474A, 618-04474. Also replaces Toro 112-6063, fits model 13AC762F052 & 13RC762F052. Pulley Dia. 5.75".



10 WHEEL/DECK ACC.

WHEEL & DECK ACCESSORIES



Spindle Assembly for MTD

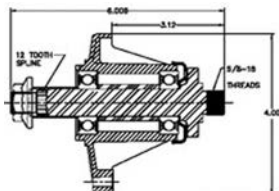

Order No. 10 - 9287

Spindle assembly replaces MTD 918-0241, 918-0431. Without pulley. Fits 46" cut, star hole blades from 1998-2000. Uses double pulley. Left assembly. Uses our **10-9517** shaft.

Spindle Assembly for MTD

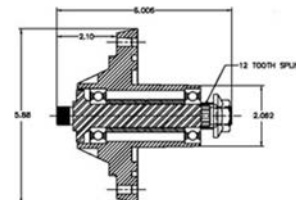

Order No. 10 - 9288

Spindle assembly replaces MTD 918-0138. Without pulley. Fits 38" & 42" cut, star hole blades. New style "X" housing. Uses our **09-442** bearing & **10-10228** nut.

Spindle Shaft for MTD



Order No. 10 - 12379

Spindle shaft replaces MTD. Fits later model 42" deck - 600 series. Fits our **10-12066** spindle assembly. 4-7/8" shaft length.

Spindle Assembly for MTD



Order No. 10 - 12066

Spindle assembly replaces MTD 918-0574/618-0574 & 918-0565/618-0565 with grease fitting. Fits later model 42" deck 600 series. Uses our **10-12379** replacement shaft.

Spindle Shaft for MTD



Order No. 10 - 9517

Spindle shaft only for our **10-9287** spindle assembly for MTD 738-0933. Length 6". Uses our **10-10228** nut.

Spindle Assembly for MTD



Order No. 10 - 9285

Spindle assembly replaces MTD 918-0117. Without pulley. Fits 46" cut, star hole blades from 1994-1997. Uses double pulley. Left assembly. Uses our **10-9516** Shaft.

Spindle Shaft for MTD



Order No. 10 - 9516

Spindle shaft only for our **10-9285** spindle assembly for MTD. Length 5-1/2", OD .785", Bolt Threads 7/16" - 20, Poly Nut Threads 5/8" - 18.

10 WHEEL/DECK ACC.



Spindle Assembly for MTD



Order No. 10 - 9284

Spindle assembly replaces MTD 918-0116. Without pulley. Fits 46" cut, star hole blades from 1994-1997. Uses single pulley. Right/Center assembly. Uses our **10-9515** Shaft. Uses our 09-442 bearing.

Spindle Shaft for MTD



Order No. 10 - 9515

Spindle shaft only for our **10-9284** spindle assembly for MTD. Length 4-5/8", OD .785", Bolt Threads 7/16" - 20, Poly Nut Threads 5/8" - 18.

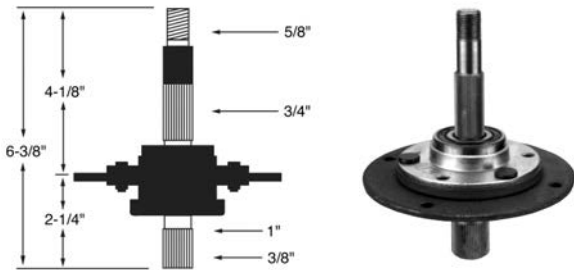

Order No. 10 - 8968

Spindle assembly replaces MTD 917-0913. Fits model 806 series, 46" cut. Left hand side quill for deck "H". Splined shaft. Used with our **09-442** bearing.

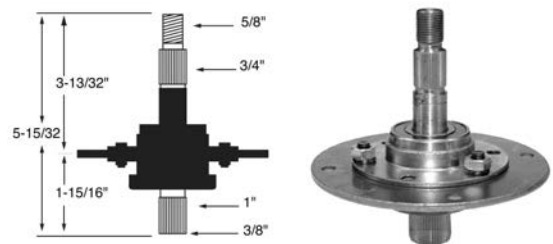

Order No. 10 - 7155

Spindle Assembly replaces MTD 917-0906A/717-0906A. Fits 38" and 42" "F" deck model 600 series. Used with our **09-442** bearing. Uses our **10-10228** nut.

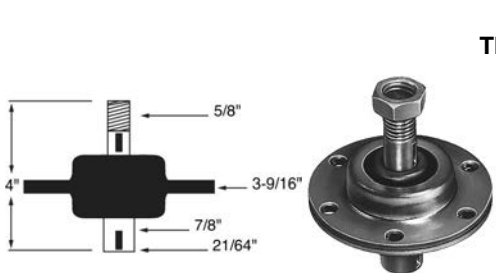

Order No. 10 - 856

Blade Spindle Assembly. MTD 09321. Uses our **09-442** bearing

Length 4"
Thread Dia. 5/8"
Shaft Dia. 7/8"
ID 21/64"
Mount 3-9/16"

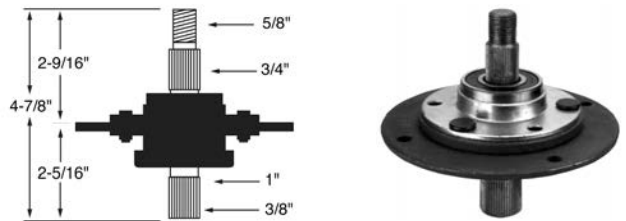

Order No. 10 - 8967

Spindle assembly replaces MTD 917-0912. Fits model 806 series, 46" cut. Right hand and center quill for deck "H". Splined shaft. Used with our **09-442** bearing.

Jackshaft Housing Assembly for MURRAY

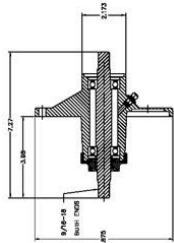

OD 6-7/8"
Height 7-1/4"

Order No. 10 - 10189

Jackshaft Housing Assembly replaces Murray 1001200 & MTD 1001046. Fits 2001 models and up riding mowers. Includes shaft with grease zerk and nut. Uses our **10-8901** nut. Uses our **09-6513** bearing.

Quill Assembly for MURRAY



Order No. 10 - 7765

Quill assembly replaces Murray 55962 & 455962. Also replaces MTD 55962E701. Used on 30" cut rear engine rider model 30502.

WHEEL & DECK ACCESSORIES



Spindle Assembly for MURRAY

ID 5/8"
OD 6-7/8"
Height 2-37/64"

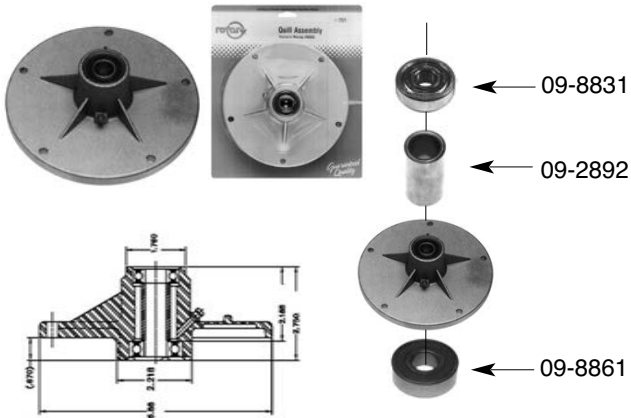

Order No. 10 - 2925

Complete Spindle Assembly replaces Murray Blade Housing 92574, 492574 and Sears made by Murray. Uses **09-8831** bearing, **09-8861** bearing, **09-2892** bushing and **01-163** zerk.

Order No. 10 - 12925

Spindle Assembly. (carded) MIN005



Order No. 10 - 12724

Spindle assembly replaces Murray 492574. Six Pack. MIN006

Spindle Repair Kit for MURRAY



Order No. 10 - 8320

Spindle repair kit for our **10-2925** Murray spindle assembly fits 1983 and newer models. Comes with (1) **09-8831** 5/8" x 1-3/8" OD bearing, (1) **09-8861** 5/8" x 1-9/16" OD bearing, (1) **09-2892** 7/8" OD x 1-11/16" bushing, (1) 1/2 x 20 nut.

Spindle Repair Kit for MURRAY



Order No. 10 - 8321

Spindle repair kit for Murray spindle assembly. Comes with (2) **09-1265** 5/8" bearings, bearing, (1) **09-2892** 7/8" OD x 1-11/16" bushing, (1) 1/2 x 20 nut.

Spindle Assembly & Shaft

Length 7-3/16"
OD 25mm



Order No. 10 - 5722

Spindle assembly 7-3/16". Replaces Scag 46400, 48926 & 46020. Also replaces Ferris 1530301 & Wright Stander 7146007.

Order No. 10 - 5999

Spindle shaft only. Replaces Scag 43001-02. Fits our **10-5722**.

10 WHEEL/DECK ACC.

Spindle Assembly for SCAG



Order No. 10 - 9153

Spindle Assembly 7-3/16". Replaces Scag 46631, 46400, 46020. Fits on models 1995 - present. New style with taper roller bearings. Cast iron assembly. Uses our **09-13092** roller bearing.

Spindle Grease Seal for SCAG



Order No. 10 - 13524

Spindle grease seal replaces Scag 481024. Fits our **10-9153** spindle. OD 2" x 1-1/2" ID x .312".



Spindle Assembly for SNAPPER



Order No. 10 - 14226

Spindle assembly replaces Snapper 1735326. Includes housing 1735573, bearings (2) 1735399, Spacers (2) 1735328, Shaft 1735326, Shield (2)1735323, Locking Ring (2) 1967066.

Outer Spindle Housing for STIGA



Order No. 10 - 9722

Outer spindle housing replaces Stiga 1134-3841-02. Uses our 10-9696 outer shaft.

Outer Shaft for STIGA



Order No. 10 - 9696

Outer shaft replaces Stiga 1134-3767-01. Used with our 10-9722 outer spindle housing. 6-3/8" (162mm) length, 11/16" (17mm) OD.

Center Shaft for STIGA



Order No. 10 - 9721

Center shaft replaces Stiga 1134-3767-02. 7-1/4" (180mm) length, 11/16" (17mm) OD.

Spindle Assembly for TORO



Order No. 10 - 14122

Spindle assembly replaces Toro 117-1192. Fits Time Cutter Z. Models 74330-74399 & 74820. Z5060 & ZX5000. Short shaft. Replaces Toro 88-4510 housing, 117-1192 with shaft (110-6866 old PN), 80-4380 spacer & 80-4360 shield.

Spindle Assembly for TORO



Order No. 10 - 14121

Spindle assembly replaces Toro 80-4341. Fits Time Cutter Z. Models 71180-71428 & 74301-74403. Long shaft. Includes 88-4510 housing with bearings, 80-4341 shaft, 80-4380 spacer.

Spindle Housing for TORO



Order No. 10 - 14132

Spindle housing with bearings and spacer replaces Toro 107-9161. Included in our 10-14121 & 10-14122. Includes (2) Toro 100-1048 bearings our 09-7210, spacer 62-3661 & 88-4510 housing only.

WHEEL & DECK ACCESSORIES



Spindle Assembly for TORO



Order No. 10 - 13621

Spindle assembly replaces Toro 99-4640. Used with our 10-13620 spindle assembly. Fits Toro 62 Z right hand & left hand spindle.

Spindle Assembly for TORO



Order No. 10 - 13620

Spindle assembly replaces Toro 105-1688. Used with our 10-13621 spindle assembly. Fits Toro 62 Z center spindle.

Spindle Assembly for TORO

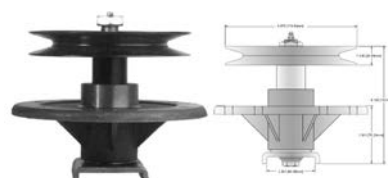

Order No. 10 - 13009

Spindle assembly replaces Toro 100-3976. Fits Z-Master with 52" deck.

Spindle Assembly for WRIGHT STANDER



Order No. 10 - 14283

Spindle assembly replaces Wright Stander 71460007, 71460126 (long). Fits 48", 52", 61" decks. Old style, thru bolt design.

Spindle Assembly for WRIGHT STANDER



Order No. 10 - 14282

Spindle assembly replaces Wright Stander 71460022 (short). Fits 32", 36", 42" decks. Replaced by 95460018, old style, thru bolt design.

10 WHEEL/DECK ACC.

Quill Assembly for AYP

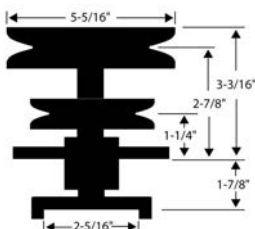

Order No. 10 - 8649

Quill assembly replaces AYP 121657X. Primary center quill on 20 hp 50" cut models. Fits models 4200-14, 951940, 8208A29 & TS2050A.

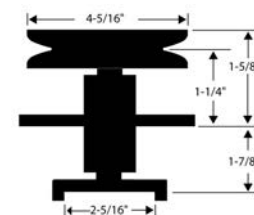

Order No. 10 - 8648

Quill assembly replaces AYP 136819. Fits 44" cut garden tractor, secondary, center & left side. Fits models GT2500BR, GT2500CR, RL1844B, PC1844A. Also fits 20 hp 50" cut models 4200-14, 951940.



Quill Assembly for AYP

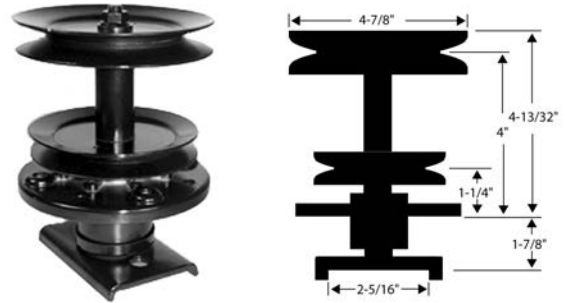

Order No. 10 - 8647

Quill assembly replaces AYP 121705X. Primary quill on 44" cut models GT2500BR, GT2500CR, RL1844B & PC18144A.

Quill Assembly for NOMA/AMF

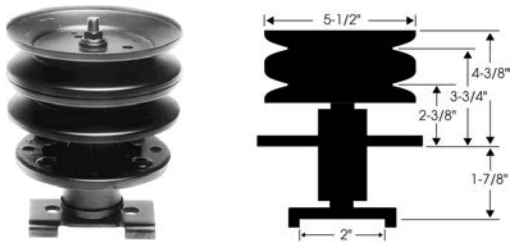

Order No. 10 - 7251

Center quill assembly. Replaces Noma 779058, 310-675 & 304-076. Fits 45" cut front engine rider models 4158-00, 03, 04, 06 and 11.

Quill Assembly for SEARS

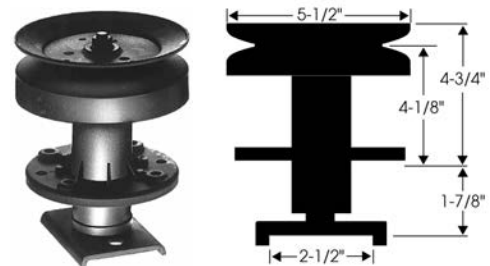

Order No. 10 - 1171

Replaces Sears 677A14, 101477X, 677A233, Husqvarna 5321014-77. Weight is 3 lb. 14.5 oz. Pulley 5-1/2", Height 6-7/8", OD of Saddle is 3", ID of Saddle is 2-1/2", Clearance 1-7/8".

Order No. 10 - 6813

Quill Assembly replaces Sears 121676X, 121687X, 105891X. Also replaces Husqvarna 5321216-87. Fits 38" & 44" decks.

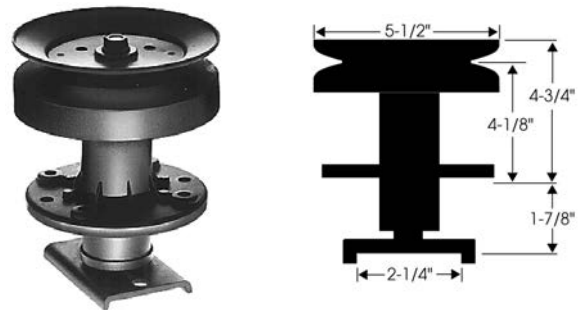

Quill Assembly for NOMA/AMF

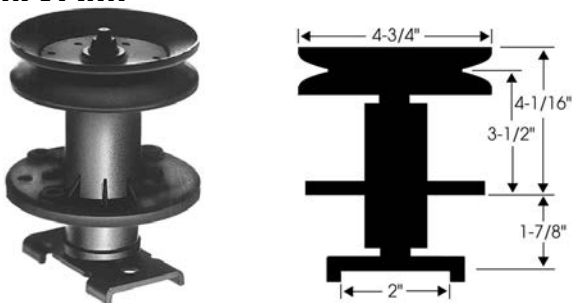

Order No. 10 - 1170

Replaces Noma/AMF 779057, 50334, 50335, 50630, 51438, 313907, 310240, 56283. Weight is 3 lb. 5 oz. Fits 32" and 42" decks.



Order No. 10 - 1172

Replaces Noma/AMF 327519, 50632, 56424, 307534, 39493, 51450 and Lawn Chief 015891, model 1239. Weight is 3 lb. 9.5 oz. Fits 36" decks.

ROLLER CHAIN



11

ROLLER CHAIN

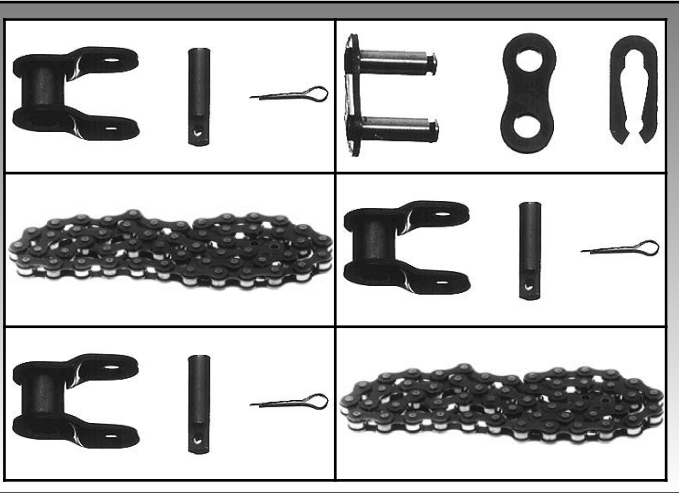
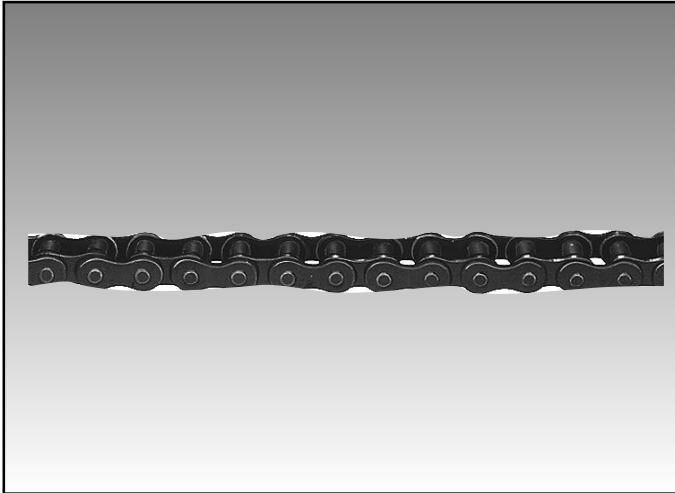

Quick-Glance

ROLLER CHAIN	PG.
Chain	203
Connecting Links	203
Offset Links	203
OEM	
Chain	203



Chain



11
ROLLER CHAIN

Order No.	Size	Length	Order No.	Size	Length
11 - 9322	C-35 3/8" x 3/16"	3 Ft	11 - 387	C-42, 415 1/2" x 3/16"	10 Ft.
11 - 9318	C-40 1/2" x 5/16"	3 Ft	11 - 388	C-43, 410 1/2" x 1/8"	10 Ft.
11 - 9320	C-41 1/2" x 1/4"	3 Ft	11 - 389	C-50 5/8" x 3/8"	10 Ft.
11 - 9321	C-35 3/8" x 3/16"	4 Ft	11 - 390	C-60 3/4" x 1/2"	10 Ft.
11 - 9317	C-40 1/2" x 5/16"	4 Ft	11 - 392	C-420 1/2" x 1/4"	10 Ft.
11 - 9319	C-41 1/2" x 1/4"	4 Ft	11 - 393	C-428 1/2" x 5/16"	10 Ft.
11 - 383	C-25 1/4" x 1/8"	10 Ft	11 - 394	C-35 3/8" x 3/16"	100 Ft.
11 - 384	C-35 3/8" x 3/16"	10 Ft	11 - 395	C-41 1/2" x 1/4"	100 Ft.
11 - 385	C-40 1/2" x 5/16"	10 Ft.	11 - 5811	C-40 1/2" x 5/16"	100 Ft.
11 - 386	C-41 1/2" x 1/4"	10 Ft.	11 - 9867	C-420 1/2" x 1/4"	100 Ft.

Note: Priced by the box, in 10 ft. and in 100 ft. rolls. Complete with connecting link.

**Connecting Links
(Box of 25)**



Order No.	Size/Quantity	Order No.	Size/Quantity
11 - 399	CCL-25 25 Pcs. Per Box MIN025	11 - 404	CCL-43, 410 25 Pcs. Per Box MIN025
11 - 400	CCL-35 25 Pcs. Per Box MIN025	11 - 405	CCL-50 25 Pcs. Per Box MIN025
11 - 401	CCL-40 25 Pcs. Per Box MIN025	11 - 406	CCL-60 25 Pcs. Per Box MIN025
11 - 402	CCL-41 25 Pcs. Per Box MIN025	11 - 408	CCL-420 25 Pcs. Per Box MIN025
11 - 403	CCL-42, 415 25 Pcs. Per Box MIN025	11 - 409	CCL-428 25 Pcs. Per Box MIN025

**Offset Links
(Box of 25)**



Order No.	Size/Quantity	Order No.	Size/Quantity
11 - 411	COL-25 25 Pcs. Per Box MIN025	11 - 416	COL-43 25 Pcs. Per Box MIN025
11 - 412	COL-35 25 Pcs. Per Box MIN025	11 - 417	COL-50 25 Pcs. Per Box MIN025
11 - 413	COL-40 25 Pcs. Per Box MIN025	11 - 418	COL-60 25 Pcs. Per Box MIN025
11 - 414	COL-41 25 Pcs. Per Box MIN025	11 - 420	COL-420 25 Pcs. Per Box MIN025
11 - 415	COL-42 25 Pcs. Per Box MIN025	11 - 421	COL-428 25 Pcs. Per Box MIN025

MURRAY Replacement Chain

Order No. 11 - 2905

Replaces Murray 23468. C-41 Chain, 80 links with connecting link. 40" length.



Order No. 11 - 8472

Chaincase chain replaces Snapper 10941. Fits all 25", 26", 28", 30", & 33" rear engine riders. #35 chain, 23 drive links.





BELTS

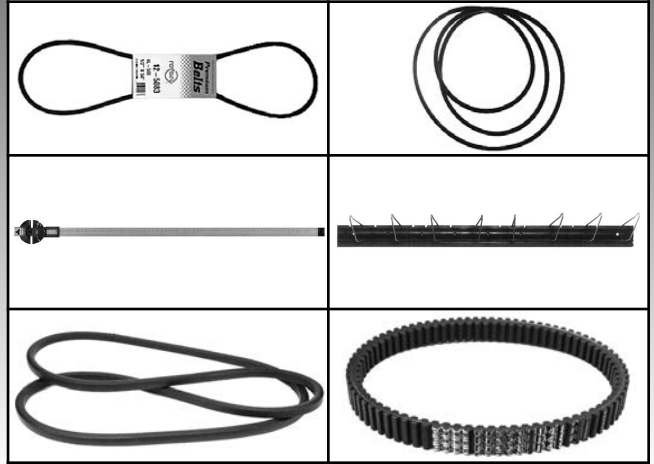
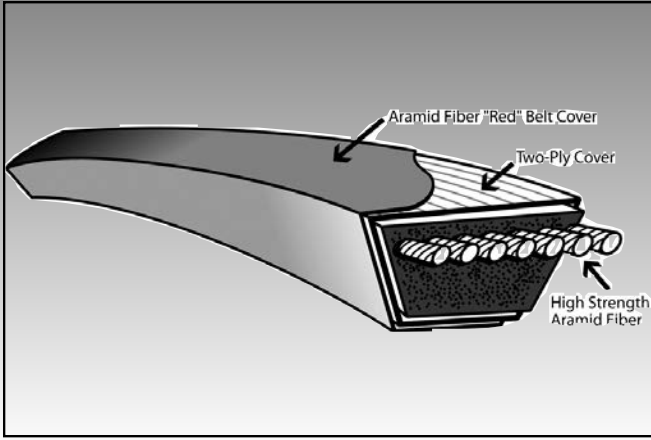

Quick-Glance

BELTS	PG.
OEM Belt Quick Reference	206-210
Accessories	
Belt Measurer	211
Belt Rack	211
Belts	
Premium 3/8", 1/2", 5/8"	211-213
Aramid Fiber 3/8", 1/2", 5/8"	214-216
Quick Look-Up	217-220
OEM	221-241
Commercial OEM	242-260
Snowblower	261

12

Quick-Glance

BELTS



O.E.M. REPLACEMENT BELTS BY LENGTH

12

BELTS

Length	Width	Order No.	Page No.
19-1/2" (495.30mm)	1/2" (12.70mm)	12 - 8761	232
21-3/4" (552.45mm)	1/2" (12.70mm)	12 - 10821	241
22" (558.8mm)	3/8" (9.53mm)	12 - 869	240
22-1/4" (565.15mm)	1/2" (12.70mm)	12 - 10822	241
23-59/64" (607.62mm)	1/2" (12.70mm)	12 - 8887	241
24-1/2" (622.30mm)	3/8" (9.53mm)	12 - 11677	257
24-1/2" (622.30mm)	3/8" (9.53mm)	12 - 669	240
24-1/2" (622.30mm)	1/2" (12.70mm)	12 - 8780	232
25" (635mm)	45/64" (17.86mm)	12 - 10256	245
25" (635mm)	3/8" (9.53mm)	12 - 670	240
27" (685.8mm)	1/4" (6.35mm)	12 - 13284	221
27" (685.8mm)	3/8" (9.53mm)	12 - 13567	233
27-1/8" (688.98mm)	1/4" (6.35mm)	12 - 8762	221
27-23/64" (694.93mm)	3/4" (19.05mm)	12 - 13048	225
27-3/8" (695.33mm)	3/4" (19.05mm)	12 - 8487	226
27-13/32" (696.12mm)	5/8" (15.88mm)	12 - 13241	225
27-1/2" (698.50mm)	1/2" (12.70mm)	12 - 4999	240
28" (711.2mm)	3/8" (9.53mm)	12 - 8819	260
28-21/64" (719.53mm)	3/4" (19.05mm)	12 - 13053	226
28-17/32" (724.69mm)	9/16" (14.29mm)	12 - 10321	260
29-1/16" (738.19mm)	11/16" (17.46mm)	12 - 9346	232
29-7/32" (742.16mm)	3/8" (9.53mm)	12 - 12687	241
29-9/32" (743.74mm)	3/4" (19.05mm)	12 - 10052	226
29-9/32" (743.74mm)	3/4" (19.05mm)	12 - 13054	225
29-11/32" (745.33mm)	25/32" (19.84mm)	12 - 11029	239
29-3/8" (746.13mm)	11/16" (17.46mm)	12 - 9792	232
29-7/16" (747.71mm)	1/2" (12.70mm)	12 - 14513	225
30" (762mm)	1/2" (12.70mm)	12 - 10210	258
30-3/16" (766.76mm)	1/2" (12.70mm)	12 - 7245	238
30-1/4" (768.35mm)	3/4" (19.05mm)	12 - 13047	225
30-1/4" (768.35mm)	3/4" (19.05mm)	12 - 13243	226
31-15/64" (793.35mm)	3/4" (19.05mm)	12 - 13050	226
31-15/64" (793.35mm)	3/4" (19.05mm)	12 - 13242	226
31-1/4" (793.75mm)	3/8" (9.53mm)	12 - 11137	237
31-1/2" (800.10mm)	7/16" (11.11mm)	12 - 13117	257
31-1/2" (800.10mm)	7/8" (22.23mm)	12 - 14237	232
31-11/16" (804.86mm)	3/8" (9.53mm)	12 - 13653	235
31-57/64" (810.02mm)	9/16" (14.29mm)	12 - 13118	251
31-29/32" (810.42mm)	7/8" (22.23mm)	12 - 13627	226
31-15/16" (811.21mm)	3/8" (9.53mm)	12 - 13247	258
32" (812.8mm)	3/8" (9.53mm)	12 - 12480	224
32-3/16" (817.56mm)	3/8" (9.53mm)	12 - 10306	223
32-13/64" (817.96mm)	3/4" (19.05mm)	12 - 13052	226
32-1/2" (825.50mm)	3/8" (9.53mm)	12 - 9848	223
32-29/32" (835.82mm)	7/8" (22.23mm)	12 - 13592	226
33" (838.2mm)	3/32" (2.38mm)	12 - 7952	241
33" (838.2mm)	3/8" (9.53mm)	12 - 8429	221
33-25/32" (858.04mm)	3/4" (19.05mm)	12 - 13059	226
33-13/16" (858.84mm)	5/8" (15.88mm)	12 - 14215	235
33-7/8" (860.43mm)	7/8" (22.23mm)	12 - 13057	226
34" (863.6mm)	1/2" (12.70mm)	12 - 10410	255
34" (863.6mm)	25/32" (19.84mm)	12 - 11030	239
34" (863.6mm)	3/8" (9.53mm)	12 - 8430	221
34" (863.6mm)	9/16" (14.29mm)	12 - 9861	241

Length	Width	Order No.	Page No.
34-13/32" (873.92mm)	3/8" (9.53mm)	12 - 13288	233
34-1/2" (876.30mm)	3/8" (9.53mm)	12 - 10090	241
34-1/2" (876.30mm)	1/2" (12.70mm)	12 - 8425	221
34-37/64" (878.28mm)	11/16" (17.46mm)	12 - 12462	239
34-3/4" (882.65mm)	3/8" (9.53mm)	12 - 10486	230
34-7/8" (885.83mm)	1/2" (12.70mm)	12 - 13509	221
35" (889mm)	1/2" (12.70mm)	12 - 10089	233
35" (889mm)	3/8" (9.53mm)	12 - 12429	235
35" (889mm)	3/8" (9.53mm)	12 - 14042	241
35" (889mm)	1/2" (12.70mm)	12 - 14118	234
35-9/64" (892.57mm)	3/4" (19.05mm)	12 - 13058	226
35-1/4" (895.35mm)	5/8" (15.88mm)	12 - 6906	233
35-3/8" (898.53mm)	3/4" (19.05mm)	12 - 10042	239
35-13/32" (899.32mm)	1/2" (12.70mm)	12 - 13505	221
35-1/2" (901.70mm)	3/8" (9.53mm)	12 - 8432	221
35-1/2" (901.70mm)	3/8" (9.53mm)	12 - 8820	260
35-39/64" (904.48mm)	5/8" (15.88mm)	12 - 5242	242
35-5/8" (904.88mm)	3/8" (9.53mm)	12 - 13232	233
36" (914.4mm)	3/8" (9.53mm)	12 - 8426	221
36" (914.4mm)	1/2" (12.70mm)	12 - 8733	248
36-5/64" (916.38mm)	5/8" (15.88mm)	12 - 12405	247
36-1/8" (917.58mm)	1/2" (12.70mm)	12 - 8811	242
36-1/4" (920.75mm)	5/8" (15.88mm)	12 - 9480	236
36-25/32" (934.24mm)	1/4" (6.35mm)	12 - 8747	238
37" (939.8mm)	1/2" (12.70mm)	12 - 8428	221
37-7/64" (942.58mm)	1/2" (12.70mm)	12 - 13508	221
37-1/2" (952.50mm)	3/8" (9.53mm)	12 - 12246	260
37-37/64" (954.48mm)	1/2" (12.70mm)	12 - 13506	221
37-5/8" (955.68mm)	1/2" (12.70mm)	12 - 10901	228
37-5/8" (955.68mm)	1/2" (12.70mm)	12 - 8760	250
37-3/4" (958.85mm)	1/2" (12.70mm)	12 - 10167	248
37-3/4" (958.85mm)	3/8" (9.53mm)	12 - 11811	230
37-3/4" (958.85mm)	5/8" (15.88mm)	12 - 14117	225
37-63/64" (964.80mm)	1/2" (12.70mm)	12 - 13507	221
38" (965.2mm)	1-1/4" (31.75mm)	12 - 10320	260
38" (965.2mm)	5/8" (15.88mm)	12 - 13254	245
38" (965.2mm)	5/8" (15.88mm)	12 - 14116	225
38-5/32" (969.17mm)	3/8" (9.53mm)	12 - 11135	236
38-3/16" (969.96mm)	5/8" (15.88mm)	12 - 6907	235
38-3/8" (974.73mm)	1/2" (12.70mm)	12 - 14120	237
38-1/2" (977.90mm)	1/2" (12.70mm)	12 - 10039	248
38-31/32" (989.81mm)	5/8" (15.88mm)	12 - 14512	225
39" (990.6mm)	1/2" (12.70mm)	12 - 8427	221
39" (990.6mm)	3/8" (9.53mm)	12 - 9901	235
39-1/16" (992.19mm)	3/8" (9.53mm)	12 - 10485	230
39-1/4" (996.95mm)	3/8" (9.53mm)	12 - 11132	236
39-5/16" (998.54mm)	1-1/4" (31.75mm)	12 - 10746	258
39-13/32" (1000.92mm)	1/2" (12.70mm)	12 - 10717	248
39-5/8" (1006.48mm)	1/2" (12.70mm)	12 - 8812	246
39-13/16" (1011.24mm)	1/2" (12.70mm)	12 - 7791	254
39-7/8" (1012.83mm)	5/8" (15.88mm)	12 - 5238	242
40" (1016mm)	1/2" (12.70mm)	12 - 8431	221
40-5/16" (1023.94mm)		12 - 6503	237
40-13/32" (1026.32mm)	1/2" (12.70mm)	12 - 10716	245



O.E.M. REPLACEMENT BELTS BY LENGTH

Length	Width	Order No.	Page No.	Length	Width	Order No.	Page No.
40-7/16" (1027.11mm)	1-1/4" (31.75mm)	12 - 10323	260	53" (1346.2mm)	5/8" (15.88mm)	12 - 6839	233
40-29/32" (1039.02mm)	21/32" (16.67mm)	12 - 10023	243	53-1/4" (1352.55mm)	7/8" (22.23mm)	12 - 9570	233
41-1/2" (1054.10mm)	5/8" (15.88mm)	12 - 11483	236	53-11/16" (1363.66mm)		12 - 6507	238
41-1/2" (1054.10mm)	1/2" (12.70mm)	12 - 9769	222	54" (1371.6mm)	1/2" (12.70mm)	12 - 8810	242
41-3/4" (1060.45mm)	1/2" (12.70mm)	12 - 10409	255	54-1/2" (1384.30mm)	43/64" (17.07mm)	12 - 12070	257
42-1/4" (1073.15mm)	1/2" (12.70mm)	12 - 13157	231	54-15/16" (1395.41mm)	1/2" (12.70mm)	12 - 6876	237
42-13/16" (1087.44mm)	21/32" (16.67mm)	12 - 10024	243	55" (1397mm)	21/32" (16.67mm)	12 - 10049	256
43" (1092.2mm)	5/8" (15.88mm)	12 - 10317	255	55-31/32" (1421.61mm)	1/2" (12.70mm)	12 - 6969	242
43-13/16" (1112.84mm)	21/32" (16.67mm)	12 - 10025	243	57" (1447.8mm)	17/32" (13.49mm)	12 - 10402	255
43-7/8" (1114.43mm)	1/2" (12.70mm)	12 - 10832	239	57-3/16" (1452.56mm)	11/16" (17.46mm)	12 - 12916	259
44" (1117.6mm)	5/8" (15.88mm)	12 - 5233	257	57-13/64" (1452.96mm)	5/8" (15.88mm)	12 - 9863	248
44-1/8" (1120.78mm)	5/8" (15.88mm)	12 - 5241	242	57-3/8" (1457.33mm)	1/2" (12.70mm)	12 - 10848	252
44-7/32" (1123.16mm)	5/8" (15.88mm)	12 - 6840	233	57-15/32" (1459.71mm)	5/8" (15.88mm)	12 - 13477	229
44-45/64" (1135.46mm)	1-1/8" (28.58mm)	12 - 6836	242	57-45/64" (1465.66mm)	1/2" (12.70mm)	12 - 12382	235
44-25/32" (1137.44mm)	25/32" (19.84mm)	12 - 10913	239	58" (1473.2mm)	3/4" (19.05mm)	12 - 10257	247
44-13/16" (1138.24mm)	21/32" (16.67mm)	12 - 10026	243	58" (1473.2mm)	1/2" (12.70mm)	12 - 10884	247
44-7/8" (1139.83mm)		12 - 5865	246	59" (1498.6mm)	1/2" (12.70mm)	12 - 10914	255
45" (1143mm)	7/16" (11.11mm)	12 - 10911	239	59-29/32" (1521.62mm)	5/8" (15.88mm)	12 - 11223	243
45" (1143mm)	5/8" (15.88mm)	12 - 9932	234	59-15/16" (1522.41mm)	1/2" (12.70mm)	12 - 10949	260
45-13/32" (1153.32mm)		12 - 7913	242	60" (1524mm)	1/2" (12.70mm)	12 - 10050	256
46-5/8" (1184.28mm)	1/2" (12.70mm)	12 - 8717	250	60" (1524mm)	1/2" (12.70mm)	12 - 10783	228
46-15/16" (1192.21mm)	1/2" (12.70mm)	12 - 13573	259	60" (1524mm)	5/8" (15.88mm)	12 - 9119	234
47" (1193.8mm)	9/16" (14.29mm)	12 - 10322	260	60-1/16" (1525.59mm)	1/2" (12.70mm)	12 - 11019	236
47" (1193.8mm)	21/32" (16.67mm)	12 - 12239	243	60-1/2" (1536.70mm)	1/2" (12.70mm)	12 - 10563	228
47-1/16" (1195.39mm)	1/2" (12.70mm)	12 - 8798	260	60-1/2" (1536.70mm)	5/8" (15.88mm)	12 - 12094	248
47-1/10" (1196.34mm)	1/2" (12.70mm)	12 - 8444	238	60-55/64" (1545.83mm)	1/2" (12.70mm)	12 - 10043	255
47-3/8" (1203.33mm)	1/2" (12.70mm)	12 - 12688	252	61-5/8" (1565.28mm)	1/2" (12.70mm)	12 - 10319	256
47-1/2" (1206.50mm)	1/2" (12.70mm)	12 - 5820	241	62" (1574.8mm)	1/2" (12.70mm)	12 - 10782	228
48" (1219.2mm)	5/8" (15.88mm)	12 - 6908	235	62-1/10" (1577.34mm)	1/2" (12.70mm)	12 - 6504	237
48-13/16" (1239.84mm)	1-1/8" (28.58mm)	12 - 9257	246	62-1/4" (1581.15mm)	1/2" (12.70mm)	12 - 10844	251
48-53/64" (1240.23mm)	5/8" (15.88mm)	12 - 13108	246	62-1/2" (1587.50mm)	1/2" (12.70mm)	12 - 14129	259
49-7/8" (1266.83mm)	1/2" (12.70mm)	12 - 5237	242	63" (1600.2mm)	1" (25.4mm)	12 - 10781	228
50" (1270mm)	21/32" (16.67mm)	12 - 10047	256	63" (1600.2mm)	1/2" (12.70mm)	12 - 12413	252
50" (1270mm)	43/64" (17.07mm)	12 - 12069	256	63" (1600.2mm)	1/2" (12.70mm)	12 - 8808	242
50" (1270mm)	7/8" (22.23mm)	12 - 9482	235	64" (1625.6mm)	1/2" (12.70mm)	12 - 12414	252
50-1/8" (1273.18mm)	1/2" (12.70mm)	12 - 12693	252	64" (1625.6mm)	5/8" (15.88mm)	12 - 6844	233
50-3/8" (1279.53mm)	1/2" (12.70mm)	12 - 5231	258	64" (1625.6mm)	5/8" (15.88mm)	12 - 8731	248
50-25/64" (1279.92mm)	1" (25.4mm)	12 - 11027	254	64-1/4" (1631.95mm)	9/16" (14.29mm)	12 - 10388	230
50-1/2" (1282.70mm)	1/2" (12.70mm)	12 - 10887	247	64-1/4" (1631.95mm)	1/2" (12.70mm)	12 - 10835	229
50-1/2" (1282.70mm)	5/8" (15.88mm)	12 - 11028	254	64-1/2" (1638.30mm)	5/8" (15.88mm)	12 - 12078	231
50-1/2" (1282.70mm)	1/2" (12.70mm)	12 - 12049	254	64-1/2" (1638.30mm)	1/2" (12.70mm)	12 - 13366	243
51-13/64" (1300.56mm)	1/2" (12.70mm)	12 - 12850	228	65" (1651mm)	43/64" (17.07mm)	12 - 12067	256
51-3/8" (1304.93mm)	1/2" (12.70mm)	12 - 10253	248	65-3/32" (1653.38mm)	5/8" (15.88mm)	12 - 12695	252
51-3/4" (1314.45mm)	1/2" (12.70mm)	12 - 13551	237	65-1/2" (1663.70mm)	1/2" (12.70mm)	12 - 5821	241
51-29/32" (1318.42mm)	5/8" (15.88mm)	12 - 8092	246	65-5/8" (1666.88mm)	43/64" (17.07mm)	12 - 12068	256
52" (1320.8mm)	1/2" (12.70mm)	12 - 10045	256	65-3/4" (1670.05mm)	5/8" (15.88mm)	12 - 10743	248
52" (1320.8mm)	1/2" (12.70mm)	12 - 9713	239	66-3/8" (1685.93mm)	1/2" (12.70mm)	12 - 12694	253
52" (1320.8mm)	1/2" (12.70mm)	12 - 9765	222	66-29/32" (1699.42mm)	21/32" (16.67mm)	12 - 11503	243
52-3/16" (1325.56mm)		12 - 7169	233	67" (1701.8mm)	5/8" (15.88mm)	12 - 10100	236
52-1/4" (1327.15mm)	1/2" (12.70mm)	12 - 10252	248	67" (1701.8mm)	1" (25.4mm)	12 - 10369	237
52-1/4" (1327.15mm)	1/2" (12.70mm)	12 - 13408	259	67" (1701.8mm)	1/2" (12.70mm)	12 - 10784	228
52-3/8" (1330.33mm)	1-1/8" (28.58mm)	12 - 5235	254	67" (1701.8mm)	1/2" (12.70mm)	12 - 6949	235
52-13/16" (1341.44mm)	1/2" (12.70mm)	12 - 8711	250	67-1/2" (1714.50mm)	11/16" (17.46mm)	12 - 10912	239
52-29/32" (1343.82mm)	5/8" (15.88mm)	12 - 7789	254	67-3/4" (1720.85mm)	21/32" (16.67mm)	12 - 8809	242

12 BELTS

BELTS



O.E.M. REPLACEMENT BELTS BY LENGTH

BELTS

Length	Width	Order No.	Page No.	Length	Width	Order No.	Page No.
68" (1727.2mm)		12 - 673	240	82" (2082.8mm)	1/2" (12.70mm)	12 - 6970	240
68-1/4" (1733.55mm)	5/8" (15.88mm)	12 - 11840	227	82-3/32" (2085.18mm)	1/2" (12.70mm)	12 - 4998	237
68-1/2" (1739.90mm)	1/2" (12.70mm)	12 - 10893	250	82-11/32" (2091.53mm)	5/8" (15.88mm)	12 - 8091	246
68-51/64" (1747.44mm)	45/64" (17.86mm)	12 - 12799	245	82-1/2" (2095.50mm)	1/2" (12.70mm)	12 - 10078	223
69" (1752.6mm)	1/2" (12.70mm)	12 - 8512	222	82-1/2" (2095.50mm)	1/2" (12.70mm)	12 - 8464	223
69-3/16" (1757.36mm)	5/8" (15.88mm)	12 - 10831	235	82-39/64" (2098.28mm)	5/8" (15.88mm)	12 - 13109	246
69-9/32" (1759.74mm)	5/8" (15.88mm)	12 - 6842	236	82-29/32" (2105.82mm)	21/32" (16.67mm)	12 - 10029	243
69-1/2" (1765.30mm)	1/2" (12.70mm)	12 - 8510	222	83" (2108.2mm)		12 - 11129	224
70-1/2" (1790.70mm)	1/2" (12.70mm)	12 - 12689	251	83" (2108.2mm)	5/8" (15.88mm)	12 - 9935	234
70-5/8" (1793.88mm)	1/2" (12.70mm)	12 - 11026	254	83-1/10" (2110.74mm)	1/2" (12.70mm)	12 - 6509	238
70-3/4" (1797.05mm)	17/32" (13.49mm)	12 - 10255	245	83-13/32" (2118.52mm)	1/2" (12.70mm)	12 - 12708	228
71" (1803.4mm)	5/8" (15.88mm)	12 - 6972	258	83-1/2" (2120.90mm)	1/2" (12.70mm)	12 - 9367	222
72" (1828.8mm)	1/2" (12.70mm)	12 - 14359	228	83-1/2" (2120.90mm)	1/2" (12.70mm)	12 - 9368	223
73" (1854.2mm)		12 - 675	237	83-5/8" (2124.08mm)	1/2" (12.70mm)	12 - 9312	223
73" (1854.2mm)		12 - 7838	241	83-3/4" (2127.25mm)	5/8" (15.88mm)	12 - 14638	245
73-3/4" (1873.25mm)	1/2" (12.70mm)	12 - 10851	251	83-3/4" (2127.25mm)	1/2" (12.70mm)	12 - 9337	223
73-3/4" (1873.25mm)	5/8" (15.88mm)	12 - 6872	240	83-13/16" (2128.84mm)	21/32" (16.67mm)	12 - 10030	243
73-3/4" (1873.25mm)		12 - 9483	241	84" (2133.6mm)	1/2" (12.70mm)	12 - 9712	238
74" (1879.6mm)	1/2" (12.70mm)	12 - 6841	233	84-7/64" (2136.38mm)	1/2" (12.70mm)	12 - 13301	234
74" (1879.6mm)	5/8" (15.88mm)	12 - 6845	235	84-1/2" (2146.30mm)	1/2" (12.70mm)	12 - 8781	223
75-1/8" (1908.18mm)	5/8" (15.88mm)	12 - 8767	257	84-1/2" (2146.30mm)	1/2" (12.70mm)	12 - 9964	224
75-3/8" (1914.53mm)	1/2" (12.70mm)	12 - 14319	259	84-13/16" (2154.24mm)	21/32" (16.67mm)	12 - 10031	243
75-25/64" (1914.92mm)	1/2" (12.70mm)	12 - 12426	245	85-7/32" (2164.56mm)	1/2" (12.70mm)	12 - 6838	233
76" (1930.4mm)	1/2" (12.70mm)	12 - 10628	250	85-3/8" (2168.53mm)	1/2" (12.70mm)	12 - 13541	239
76" (1930.4mm)	1/2" (12.70mm)	12 - 9847	234	85-3/8" (2168.53mm)	5/8" (15.88mm)	12 - 9698	223
77-1/2" (1968.50mm)	5/8" (15.88mm)	12 - 10623	250	85-15/16" (2182.81mm)	1/2" (12.70mm)	12 - 6904	238
77-11/16" (1973.26mm)	1/2" (12.70mm)	12 - 7672	238	86" (2184.4mm)	5/8" (15.88mm)	12 - 7631	216
77-3/4" (1974.85mm)	1/2" (12.70mm)	12 - 11846	227	86-1/4" (2190.75mm)	1/2" (12.70mm)	12 - 9994	238
77-3/4" (1974.85mm)	5/8" (15.88mm)	12 - 7128	240	86-19/64" (2191.94mm)	5/8" (15.88mm)	12 - 12417	252
78" (1981.2mm)	5/8" (15.88mm)	12 - 8509	245	86-25/64" (2194.32mm)	1/2" (12.70mm)	12 - 12898	231
78-21/64" (1989.53mm)	5/8" (15.88mm)	12 - 13571	259	86-29/32" (2207.42mm)	5/8" (15.88mm)	12 - 10814	243
78-1/2" (1993.90mm)	1/2" (12.70mm)	12 - 8463	222	87" (2209.8mm)		12 - 11130	224
78-1/2" (1993.90mm)	1/2" (12.70mm)	12 - 9903	236	87" (2209.8mm)	1/2" (12.70mm)	12 - 9313	239
79" (2006.6mm)	1/2" (12.70mm)	12 - 9767	223	87-1/2" (2222.50mm)	1/2" (12.70mm)	12 - 14365	241
79-3/32" (2008.98mm)	1/2" (12.70mm)	12 - 6843	233	87-41/64" (2226.07mm)	1/2" (12.70mm)	12 - 12892	224
79-7/64" (2009.38mm)	1/2" (12.70mm)	12 - 6901	222	87-13/16" (2230.44mm)	21/32" (16.67mm)	12 - 10032	244
79-1/4" (2012.95mm)	1/2" (12.70mm)	12 - 11849	227	87-15/16" (2233.61mm)	5/8" (15.88mm)	12 - 8805	246
79-19/64" (2014.14mm)	1/2" (12.70mm)	12 - 12770	234	88-1/4" (2241.55mm)	1/2" (12.70mm)	12 - 9715	239
79-13/16" (2027.24mm)	1/2" (12.70mm)	12 - 10318	256	88-5/16" (2243.14mm)	1/2" (12.70mm)	12 - 6502	237
80" (2032mm)	5/8" (15.88mm)	12 - 12085	255	88-3/8" (2244.73mm)	1/2" (12.70mm)	12 - 8516	223
80" (2032mm)	1/2" (12.70mm)	12 - 6900	222	88-5/8" (2251.08mm)	17/32" (13.49mm)	12 - 10434	230
80-1/8" (2035.18mm)	1/2" (12.70mm)	12 - 7894	260	88-3/4" (2254.25mm)	5/8" (15.88mm)	12 - 10625	250
80-5/16" (2039.94mm)	1/2" (12.70mm)	12 - 8443	238	89" (2260.6mm)	5/8" (15.88mm)	12 - 10077	224
80-49/64" (2051.45mm)	1/2" (12.70mm)	12 - 13257	257	89" (2260.6mm)	1/2" (12.70mm)	12 - 10910	239
80-29/32" (2055.02mm)	21/32" (16.67mm)	12 - 10027	243	89" (2260.6mm)	5/8" (15.88mm)	12 - 12751	244
80-61/64" (2056.21mm)	5/8" (15.88mm)	12 - 13110	246	89-1/4" (2266.95mm)	1/2" (12.70mm)	12 - 12873	227
81-1/16" (2058.99mm)	1/2" (12.70mm)	12 - 9336	223	89-1/2" (2273.30mm)	1/2" (12.70mm)	12 - 8972	238
81-1/4" (2063.75mm)	5/8" (15.88mm)	12 - 10885	247	89-39/64" (2276.08mm)	5/8" (15.88mm)	12 - 7790	254
81-1/2" (2070.10mm)	1/2" (12.70mm)	12 - 10830	226	89-29/32" (2283.62mm)		12 - 9581	234
81-3/4" (2076.45mm)	5/8" (15.88mm)	12 - 13569	258	90" (2286mm)	5/8" (15.88mm)	12 - 10076	224
81-3/4" (2076.45mm)	1/2" (12.70mm)	12 - 9481	238	90" (2286mm)	1/2" (12.70mm)	12 - 6898	240
82" (2082.8mm)	1/2" (12.70mm)	12 - 10008	223	90" (2286mm)	1/2" (12.70mm)	12 - 6902	222
82" (2082.8mm)	5/8" (15.88mm)	12 - 5236	254	90-1/4" (2292.35mm)	1/2" (12.70mm)	12 - 11848	234
82" (2082.8mm)	1/2" (12.70mm)	12 - 6896	240	90-1/4" (2292.35mm)	1/2" (12.70mm)	12 - 11861	224



O.E.M. REPLACEMENT BELTS BY LENGTH

Length	Width	Order No.	Page No.	Length	Width	Order No.	Page No.
90-1/2" (2298.70mm)	5/8" (15.88mm)	12 - 11482	236	105" (2667mm)	1/2" (12.70mm)	12 - 10750	230
90-1/2" (2298.70mm)		12 - 6505	237	105" (2667mm)	1/2" (12.70mm)	12 - 11850	227
90-29/32" (2309.02mm)	21/32" (16.67mm)	12 - 11502	244	105" (2667mm)		12 - 870	224
91" (2311.4mm)	5/8" (15.88mm)	12 - 12983	244	105-19/64" (2674.54mm)	1/2" (12.70mm)	12 - 13572	259
91-1/4" (2317.75mm)	1/2" (12.70mm)	12 - 7673	238	105-3/4" (2686.05mm)	1/2" (12.70mm)	12 - 12286	225
91-5/16" (2319.34mm)	1/2" (12.70mm)	12 - 10035	243	105-13/16" (2687.64mm)	21/32" (16.67mm)	12 - 10036	244
91-13/32" (2321.72mm)	1/2" (12.70mm)	12 - 12489	234	106-29/32" (2715.42mm)	1/2" (12.70mm)	12 - 10005	224
91-13/16" (2332.04mm)	17/32" (13.49mm)	12 - 10435	230	108-1/4" (2749.55mm)	5/8" (15.88mm)	12 - 10627	250
91-7/8" (2333.63mm)	1/2" (12.70mm)	12 - 13035	231	109" (2768.6mm)	5/8" (15.88mm)	12 - 9714	239
92-1/2" (2349.50mm)	1/2" (12.70mm)	12 - 8511	222	109-7/64" (2771.38mm)	1/2" (12.70mm)	12 - 11845	227
93" (2362.2mm)	5/8" (15.88mm)	12 - 5823	242	110" (2794mm)	1/2" (12.70mm)	12 - 13499	228
94" (2387.6mm)	5/8" (15.88mm)	12 - 8370	246	110-1/4" (2800.35mm)	5/8" (15.88mm)	12 - 8768	257
94-29/32" (2410.62mm)	5/8" (15.88mm)	12 - 11225	244	110-1/2" (2806.70mm)	5/8" (15.88mm)	12 - 12098	249
95" (2413mm)	1/2" (12.70mm)	12 - 6508	238	110-29/32" (2817.02mm)	5/8" (15.88mm)	12 - 11820	228
95" (2413mm)	1/2" (12.70mm)	12 - 9764	222	111" (2819.4mm)	1/2" (12.70mm)	12 - 13570	258
95" (2413mm)	1/2" (12.70mm)	12 - 9768	223	111-13/64" (2824.56mm)	5/8" (15.88mm)	12 - 12610	234
95-1/4" (2419.35mm)	1/2" (12.70mm)	12 - 8784	222	111-3/8" (2828.93mm)	5/8" (15.88mm)	12 - 12077	230
95-1/2" (2425.70mm)	1/2" (12.70mm)	12 - 9697	223	111-11/25" (2830.58mm)	5/8" (15.88mm)	12 - 9014	247
95-11/16" (2430.46mm)	1/2" (12.70mm)	12 - 12398	225	112-1/8" (2847.98mm)	1/2" (12.70mm)	12 - 14130	259
95-3/4" (2432.05mm)	1/2" (12.70mm)	12 - 10749	231	112-1/4" (2851.15mm)	5/8" (15.88mm)	12 - 13474	229
96-13/32" (2448.72mm)	1/2" (12.70mm)	12 - 13501	228	112-1/2" (2857.50mm)	1/2" (12.70mm)	12 - 10886	247
96-1/2" (2451.10mm)	1/2" (12.70mm)	12 - 11660	236	112-1/2" (2857.50mm)	5/8" (15.88mm)	12 - 11997	227
96-7/8" (2460.63mm)	1/2" (12.70mm)	12 - 12052	224	112-1/2" (2857.50mm)	5/8" (15.88mm)	12 - 12095	248
96-29/32" (2461.42mm)	5/8" (15.88mm)	12 - 11226	244	114" (2895.6mm)	1/2" (12.70mm)	12 - 12318	251
97" (2463.8mm)	5/8" (15.88mm)	12 - 10009	235	114" (2895.6mm)	1/2" (12.70mm)	12 - 12423	225
97" (2463.8mm)	1/2" (12.70mm)	12 - 13036	231	114-1/2" (2908.30mm)	1/2" (12.70mm)	12 - 12373	231
97" (2463.8mm)	1/2" (12.70mm)	12 - 9995	238	114-13/16" (2916.24mm)	21/32" (16.67mm)	12 - 10033	244
97-13/32" (2474.12mm)	21/32" (16.67mm)	12 - 10232	224	115" (2921mm)	11/16" (17.46mm)	12 - 10403	255
97-13/32" (2474.12mm)	1/2" (12.70mm)	12 - 11862	224	115-1/4" (2927.35mm)	1/2" (12.70mm)	12 - 12678	231
97-2/3" (2480.73mm)	5/8" (15.88mm)	12 - 11017	237	115-9/32" (2928.14mm)	5/8" (15.88mm)	12 - 13454	247
98-1/4" (2495.55mm)	1/2" (12.70mm)	12 - 8462	222	116" (2946.4mm)	1/2" (12.70mm)	12 - 12415	252
98-5/16" (2497.14mm)	1/2" (12.70mm)	12 - 10022	243	116-1/8" (2949.58mm)	5/8" (15.88mm)	12 - 12237	245
99" (2514.6mm)	1/2" (12.70mm)	12 - 6903	237	116-3/4" (2965.45mm)	21/32" (16.67mm)	12 - 10046	256
99" (2514.6mm)	1/2" (12.70mm)	12 - 8465	222	117" (2971.8mm)	5/8" (15.88mm)	12 - 12759	232
99" (2514.6mm)	1/2" (12.70mm)	12 - 9120	234	117" (2971.8mm)	1/2" (12.70mm)	12 - 9900	235
100" (2540mm)	5/8" (15.88mm)	12 - 10260	236	117-1/2" (2984.50mm)	5/8" (15.88mm)	12 - 12071	257
100" (2540mm)	5/8" (15.88mm)	12 - 10261	236	117-1/2" (2984.50mm)	5/8" (15.88mm)	12 - 8714	255
100" (2540mm)	5/8" (15.88mm)	12 - 13219	244	118-1/4" (3003.55mm)	1/2" (12.70mm)	12 - 11843	227
101" (2565.4mm)	5/8" (15.88mm)	12 - 11468	243	118-3/4" (3016.25mm)	5/8" (15.88mm)	12 - 12783	245
101" (2565.4mm)	1/2" (12.70mm)	12 - 11867	224	120" (3048mm)	21/32" (16.67mm)	12 - 10048	256
101" (2565.4mm)	5/8" (15.88mm)	12 - 12442	244	120-19/64" (3055.54mm)	5/8" (15.88mm)	12 - 10629	250
101-1/4" (2571.75mm)	1/2" (12.70mm)	12 - 12256	247	120-5/16" (3055.94mm)	17/32" (13.49mm)	12 - 10254	245
101-13/32" (2575.72mm)	1/2" (12.70mm)	12 - 13251	225	120-3/8" (3057.53mm)	21/32" (16.67mm)	12 - 10404	255
101-11/16" (2582.86mm)	1/2" (12.70mm)	12 - 8442	238	120-1/2" (3060.70mm)	5/8" (15.88mm)	12 - 12096	248
102" (2590.8mm)	1/2" (12.70mm)	12 - 10751	231	122" (3098.8mm)	1/2" (12.70mm)	12 - 12769	227
102" (2590.8mm)	21/32" (16.67mm)	12 - 12238	244	122-1/8" (3101.98mm)	1/2" (12.70mm)	12 - 10387	258
102-7/8" (2613.03mm)	5/8" (15.88mm)	12 - 13456	244	122-1/2" (3111.50mm)	1/2" (12.70mm)	12 - 12609	227
103" (2616.2mm)	1/2" (12.70mm)	12 - 12051	228	123" (3124.2mm)	5/8" (15.88mm)	12 - 13255	245
103" (2616.2mm)	1/2" (12.70mm)	12 - 7171	241	123-21/64" (3132.53mm)	5/8" (15.88mm)	12 - 13476	229
103-3/32" (2618.58mm)	1/2" (12.70mm)	12 - 7129	240	123-15/16" (3148.01mm)	21/32" (16.67mm)	12 - 10411	255
103-1/4" (2622.55mm)	1/2" (12.70mm)	12 - 12790	234	125-1/2" (3187.70mm)	5/8" (15.88mm)	12 - 12072	257
103-1/2" (2628.90mm)		12 - 6837	258	126-3/16" (3205.16mm)	1/2" (12.70mm)	12 - 6874	240
103-3/4" (2635.25mm)	1/2" (12.70mm)	12 - 10436	230	126-55/64" (3222.23mm)	5/8" (15.88mm)	12 - 13442	229
103-7/8" (2638.43mm)	5/8" (15.88mm)	12 - 11504	247	127-7/64" (3228.58mm)	1/2" (12.70mm)	12 - 7837	250

12 BELTS

BELTS



O.E.M. REPLACEMENT BELTS BY LENGTH

12 BELTS

Length	Width	Order No.	Page No.	Length	Width	Order No.	Page No.
127-19/64" (3233.34mm)	1/2" (12.70mm)	12 - 12416	253	148-1/2" (3771.90mm)	5/8" (15.88mm)	12 - 10849	252
128-13/32" (3261.52mm)	21/32" (16.67mm)	12 - 10407	255	150" (3810mm)	5/8" (15.88mm)	12 - 12108	249
128-3/4" (3270.25mm)	5/8" (15.88mm)	12 - 14390	231	150-13/64" (3815.16mm)	5/8" (15.88mm)	12 - 11024	254
130-13/16" (3322.64mm)	21/32" (16.67mm)	12 - 10011	244	151-1/2" (3848.10mm)	5/8" (15.88mm)	12 - 12109	249
131-7/64" (3330.18mm)	5/8" (15.88mm)	12 - 12667	233	152" (3860.8mm)	5/8" (15.88mm)	12 - 12320	252
131-1/2" (3340.10mm)	5/8" (15.88mm)	12 - 12814	232	152-7/64" (3863.58mm)	5/8" (15.88mm)	12 - 11032	260
132" (3352.8mm)	1/2" (12.70mm)	12 - 12264	251	152-1/4" (3867.15mm)	1/2" (12.70mm)	12 - 13158	232
132-3/4" (3371.85mm)	5/8" (15.88mm)	12 - 11853	242	153-1/2" (3898.90mm)	5/8" (15.88mm)	12 - 12100	249
132-13/16" (3373.44mm)	21/32" (16.67mm)	12 - 10034	244	154" (3911.6mm)	21/32" (16.67mm)	12 - 10040	248
133-45/64" (3396.06mm)	5/8" (15.88mm)	12 - 11847	227	154-7/8" (3933.83mm)	5/8" (15.88mm)	12 - 12371	256
134" (3403.6mm)	1/2" (12.70mm)	12 - 11844	227	154-7/8" (3933.83mm)	5/8" (15.88mm)	12 - 14209	246
134-1/4" (3409.95mm)	1/2" (12.70mm)	12 - 10038	247	157-9/32" (3994.94mm)	5/8" (15.88mm)	12 - 11025	254
134-5/16" (3411.54mm)	5/8" (15.88mm)	12 - 10626	250	158" (4013.2mm)	5/8" (15.88mm)	12 - 12106	249
135" (3429mm)	5/8" (15.88mm)	12 - 13443	229	158" (4013.2mm)	5/8" (15.88mm)	12 - 13256	245
135-1/2" (3441.70mm)	21/32" (16.67mm)	12 - 10405	255	158" (4013.2mm)	1/2" (12.70mm)	12 - 14166	257
135-1/2" (3441.70mm)	5/8" (15.88mm)	12 - 12073	257	159-5/64" (4040.58mm)	5/8" (15.88mm)	12 - 12653	229
135-1/2" (3441.70mm)	5/8" (15.88mm)	12 - 12097	249	160-13/64" (4069.16mm)	5/8" (15.88mm)	12 - 12321	253
135-1/2" (3441.70mm)	5/8" (15.88mm)	12 - 12399	240	161-13/32" (4099.72mm)	5/8" (15.88mm)	12 - 14243	230
136-41/64" (3470.67mm)	5/8" (15.88mm)	12 - 10037	247	162-1/8" (4117.98mm)	7/8" (22.23mm)	12 - 10815	244
137" (3479.8mm)	5/8" (15.88mm)	12 - 14593	257	162-1/2" (4127.50mm)	5/8" (15.88mm)	12 - 12233	255
137-1/2" (3492.50mm)	5/8" (15.88mm)	12 - 10744	249	162-51/64" (4135.04mm)	21/32" (16.67mm)	12 - 12452	244
137-29/32" (3502.82mm)	5/8" (15.88mm)	12 - 11661	237	162-29/32" (4137.82mm)	1/2" (12.70mm)	12 - 12791	234
138-1/4" (3511.55mm)	5/8" (15.88mm)	12 - 10861	252	163" (4140.2mm)	5/8" (15.88mm)	12 - 12107	249
138-3/4" (3524.25mm)	5/8" (15.88mm)	12 - 11864	224	163-1/2" (4152.90mm)	5/8" (15.88mm)	12 - 10823	260
138-7/8" (3527.43mm)	17/32" (13.49mm)	12 - 10437	230	164-13/16" (4186.24mm)	21/32" (16.67mm)	12 - 10010	244
139" (3530.6mm)	1/2" (12.70mm)	12 - 8075	241	165-1/2" (4203.70mm)	5/8" (15.88mm)	12 - 10847	251
139-61/64" (3554.81mm)	5/8" (15.88mm)	12 - 10044	255	169-15/32" (4304.51mm)	5/8" (15.88mm)	12 - 10041	248
140" (3556mm)	5/8" (15.88mm)	12 - 10850	252	171-1/4" (4349.75mm)	5/8" (15.88mm)	12 - 14000	251
140-7/64" (3558.78mm)	1/2" (12.70mm)	12 - 12672	259	175-3/4" (4464.05mm)	5/8" (15.88mm)	12 - 14217	246
140-3/4" (3575.05mm)	5/8" (15.88mm)	12 - 12718	257	175-7/8" (4467.23mm)	5/8" (15.88mm)	12 - 14318	259
141" (3581.4mm)	5/8" (15.88mm)	12 - 12099	249	175-29/32" (4468.02mm)	5/8" (15.88mm)	12 - 12824	256
141-7/64" (3584.18mm)	1/2" (12.70mm)	12 - 12461	230	176" (4470.4mm)	5/8" (15.88mm)	12 - 12867	258
141-47/64" (3600.05mm)	5/8" (15.88mm)	12 - 12760	232	176-51/64" (4490.64mm)	5/8" (15.88mm)	12 - 12322	253
142-7/64" (3609.58mm)	21/32" (16.67mm)	12 - 10051	258	180" (4572mm)	5/8" (15.88mm)	12 - 10845	251
142-37/64" (3621.48mm)	5/8" (15.88mm)	12 - 11034	224	183-3/8" (4657.73mm)	5/8" (15.88mm)	12 - 10824	260
143" (3632.2mm)	5/8" (15.88mm)	12 - 12319	252	184-51/64" (4693.84mm)	5/8" (15.88mm)	12 - 12323	253
143" (3632.2mm)	5/8" (15.88mm)	12 - 12768	227	186" (4724.4mm)	5/8" (15.88mm)	12 - 14165	245
143-5/32" (3636.17mm)	5/8" (15.88mm)	12 - 10251	247	195" (4953mm)	5/8" (15.88mm)	12 - 10846	251
143-1/4" (3638.55mm)	5/8" (15.88mm)	12 - 13475	229	198-1/2" (5041.90mm)	5/8" (15.88mm)	12 - 10825	260
143-5/16" (3640.14mm)	1/2" (12.70mm)	12 - 10630	230	198-3/4" (5048.25mm)	5/8" (15.88mm)	12 - 14167	246
143-1/2" (3644.90mm)	5/8" (15.88mm)	12 - 10834	229	204-1/2" (5194.30mm)	5/8" (15.88mm)	12 - 12690	251
143-1/2" (3644.90mm)	1/2" (12.70mm)	12 - 12559	232	213-1/2" (5422.90mm)	5/8" (15.88mm)	12 - 12691	253
143-1/2" (3644.90mm)	5/8" (15.88mm)	12 - 13444	229	226" (5740.4mm)	5/8" (15.88mm)	12 - 12805	258
145" (3683mm)	5/8" (15.88mm)	12 - 12401	240	228-23/32" (5809.46mm)	5/8" (15.88mm)	12 - 12692	253
145-3/8" (3692.53mm)	5/8" (15.88mm)	12 - 10852	251	242" (6146.8mm)	5/8" (15.88mm)	12 - 12729	258
145-1/2" (3695.70mm)	5/8" (15.88mm)	12 - 14363	249	264" (6705.6mm)	5/8" (15.88mm)	12 - 12730	258
146-7/64" (3711.18mm)	1/2" (12.70mm)	12 - 12425	246				
146-3/16" (3713.16mm)	5/8" (15.88mm)	12 - 9016	247				
146-1/4" (3714.75mm)	1/2" (12.70mm)	12 - 12560	232				
147" (3733.8mm)	5/8" (15.88mm)	12 - 12443	244				
147-1/2" (3746.50mm)	5/8" (15.88mm)	12 - 10745	249				
148" (3759.2mm)	21/32" (16.67mm)	12 - 10365	256				
148" (3759.2mm)	5/8" (15.88mm)	12 - 11863	224				
148-1/4" (3765.55mm)	5/8" (15.88mm)	12 - 12719	257				



Belt Measurer



Order No. 32 - 9108

Belt Measurer. Measures 3/8", 1/2", and 5/8". Fractional horsepower belts as well as A and B section Industrial Belts up to 110".

Belt Rack

(30 feet)



Order No. 50 - 12250

Belt Rack. High impact plastic base with pre-drilled mounting holes and 8 adjustable wire hangers per section. Comes boxed 10 sections per box each sections is 3' in length. One box will display up to 80 rows of belts.

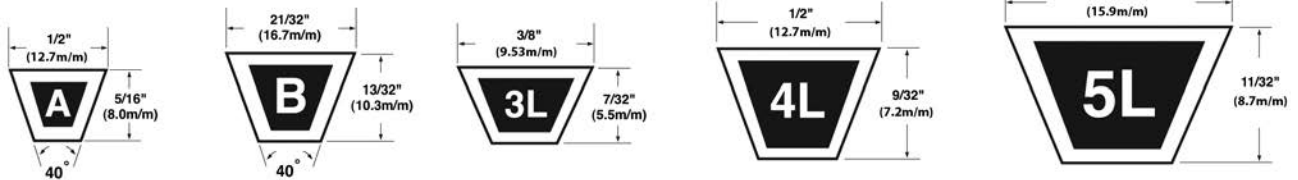

Premium Belts



These Premium Belts meet our rigid specifications and are oil and heat resistant. The protective cover is made of a synthetic rubber compound having excellent resistance to heat, oil and abrasion. Available in 3L-3/8", 4L-1/2" and 5L-5/8" widths. Sample of codes: 4L310=1/2" width, 31" length.

3/8" (9.53 mm) SECTION

Order No.	Length	Milli-meters	Belt No.	Order No.	Length	Milli-meters	Belt No.
12 - 5000	17"	431.80	3L170	12 - 5016	33"	838.20	3L330
12 - 5001	18"	457.20	3L180	12 - 5017	34"	863.60	3L340
12 - 5002	19"	482.20	3L190	12 - 5018	35"	889.00	3L350
12 - 5003	20"	508.00	3L200	12 - 5019	36"	914.40	3L360
12 - 5004	21"	533.40	3L210	12 - 5020	37"	939.80	3L370
12 - 5005	22"	558.80	3L220	12 - 5021	38"	965.20	3L380
12 - 5006	23"	584.20	3L230	12 - 5022	39"	990.60	3L390
12 - 5007	24"	609.60	3L240	12 - 5023	40"	1016.00	3L400
12 - 5008	25"	635.00	3L250	12 - 5024	41"	1041.40	3L410
12 - 5009	26"	660.40	3L260	12 - 5025	42"	1066.80	3L420
12 - 5010	27"	685.80	3L270	12 - 5026	43"	1092.20	3L430
12 - 5011	28"	711.20	3L280	12 - 5027	44"	1117.60	3L440
12 - 5012	29"	736.60	3L290	12 - 5028	45"	1143.00	3L450
12 - 5013	30"	762.00	3L300	12 - 5029	46"	1168.40	3L460
12 - 5014	31"	787.40	3L310	12 - 5030	47"	1193.80	3L470
12 - 5015	32"	812.80	3L320	12 - 5031	48"	1219.20	3L480

12

BELTS

BELTS



Premium Belts (Cont.)



1/2" (12.70 mm) SECTION

BELTS

Order No.	Length	Milli-meters	Belt No.	Order No.	Length	Milli-meters	Belt No.
12 - 5050	17"	431.80	4L170	12 - 5099	66"	1676.40	4L660
12 - 5051	18"	457.20	4L180	12 - 5100	67"	1701.80	4L670
12 - 5052	19"	482.20	4L190	12 - 5101	68"	1727.20	4L680
12 - 5053	20"	508.00	4L200	12 - 5102	69"	1752.60	4L690
12 - 5054	21"	533.40	4L210	12 - 5103	70"	1778.00	4L700
12 - 5055	22"	558.80	4L220	12 - 5104	71"	1803.40	4L710
12 - 5056	23"	584.20	4L230	12 - 5105	72"	1828.80	4L720
12 - 5057	24"	609.60	4L240	12 - 5106	73"	1854.20	4L730
12 - 5058	25"	635.00	4L250	12 - 5107	74"	1879.60	4L740
12 - 5059	26"	660.40	4L260	12 - 5108	75"	1905.00	4L750
12 - 5060	27"	685.80	4L270	12 - 5109	76"	1930.40	4L760
12 - 5061	28"	711.20	4L280	12 - 5110	77"	1955.80	4L770
12 - 5062	29"	736.60	4L290	12 - 5111	78"	1981.20	4L780
12 - 5063	30"	762.00	4L300	12 - 5112	79"	2006.60	4L790
12 - 5064	31"	787.40	4L310	12 - 5113	80"	2032.00	4L800
12 - 5065	32"	812.80	4L320	12 - 5114	81"	2057.40	4L810
12 - 5066	33"	838.20	4L330	12 - 5115	82"	2082.80	4L820
12 - 5067	34"	868.60	4L340	12 - 5116	83"	2108.20	4L830
12 - 5068	35"	889.00	4L350	12 - 5117	84"	2133.60	4L840
12 - 5069	36"	914.40	4L360	12 - 5118	85"	2159.00	4L850
12 - 5070	37"	939.80	4L370	12 - 5119	86"	2184.40	4L860
12 - 5071	38"	965.20	4L380	12 - 5120	87"	2209.80	4L870
12 - 5072	39"	990.60	4L390	12 - 5121	88"	2235.20	4L880
12 - 5073	40"	1016.00	4L400	12 - 5122	89"	2260.60	4L890
12 - 5074	41"	1041.40	4L410	12 - 5123	90"	2286.00	4L900
12 - 5075	42"	1066.80	4L420	12 - 5124	91"	2311.40	4L910
12 - 5076	43"	1092.20	4L430	12 - 5125	92"	2336.80	4L920
12 - 5077	44"	1117.60	4L440	12 - 5126	93"	2362.20	4L930
12 - 5078	45"	1143.00	4L450	12 - 5127	94"	2387.60	4L940
12 - 5079	46"	1168.40	4L460	12 - 5128	95"	2413.00	4L950
12 - 5080	47"	1193.80	4L470	12 - 5129	96"	2438.40	4L960
12 - 5081	48"	1219.20	4L480	12 - 5130	97"	2463.80	4L970
12 - 5082	49"	1244.60	4L490	12 - 5131	98"	2489.20	4L980
12 - 5083	50"	1270.00	4L500	12 - 5132	99"	2514.60	4L990
12 - 5084	51"	1295.40	4L510	12 - 5133	100"	2540.00	4L1000
12 - 5085	52"	1320.80	4L520	12 - 6629	101"	2565.40	4L1010
12 - 5086	53"	1346.20	4L530	12 - 6630	102"	2590.80	4L1020
12 - 5087	54"	1371.60	4L540	12 - 6631	103"	2616.20	4L1030
12 - 5088	55"	1397.00	4L550	12 - 6632	104"	2641.60	4L1040
12 - 5089	56"	1422.40	4L560	12 - 6633	105"	2667.00	4L1050
12 - 5090	57"	1447.80	4L570	12 - 6634	106"	2692.40	4L1060
12 - 5091	58"	1473.20	4L580	12 - 6635	107"	2717.80	4L1070
12 - 5092	59"	1498.60	4L590	12 - 6636	108"	2743.20	4L1080
12 - 5093	60"	1524.00	4L600	12 - 6637	109"	2768.60	4L1090
12 - 5094	61"	1549.40	4L610	12 - 6638	110"	2794.00	4L1100
12 - 5095	62"	1574.80	4L620	12 - 6639	111"	2819.40	4L1110
12 - 5096	63"	1600.20	4L630	12 - 6640	112"	2844.80	4L1120
12 - 5097	64"	1625.60	4L640	12 - 6641	113"	2870.20	4L1130
12 - 5098	65"	1651.00	4L650	12 - 6642	114"	2895.60	4L1140



Premium Belts (Cont.)



5/8" (15.88 mm) SECTION

Order No.	Length	Milli-meters	Belt No.	Order No.	Length	Milli-meters	Belt No.
12 - 5150	23"	584.20	5L230	12 - 5196	69"	1752.60	5L690
12 - 5151	24"	609.60	5L240	12 - 5197	70"	1778.00	5L700
12 - 5152	25"	635.00	5L250	12 - 5198	71"	1803.40	5L710
12 - 5153	26"	660.40	5L260	12 - 5199	72"	1828.80	5L720
12 - 5154	27"	685.80	5L270	12 - 5200	73"	1854.20	5L730
12 - 5155	28"	711.20	5L280	12 - 5201	74"	1879.60	5L740
12 - 5156	29"	736.60	5L290	12 - 5202	75"	1905.00	5L750
12 - 5157	30"	762.00	5L300	12 - 5203	76"	1930.40	5L760
12 - 5158	31"	787.40	5L310	12 - 5204	77"	1955.80	5L770
12 - 5159	32"	812.80	5L320	12 - 5205	78"	1981.20	5L780
12 - 5160	33"	838.20	5L330	12 - 5206	79"	2006.60	5L790
12 - 5161	34"	863.60	5L340	12 - 5207	80"	2032.00	5L800
12 - 5162	35"	889.00	5L350	12 - 5208	81"	2057.40	5L810
12 - 5163	36"	914.40	5L360	12 - 5209	82"	2082.80	5L820
12 - 5164	37"	939.80	5L370	12 - 5210	83"	2108.20	5L830
12 - 5165	38"	965.20	5L380	12 - 5211	84"	2133.60	5L840
12 - 5166	39"	990.60	5L390	12 - 5212	85"	2159.00	5L850
12 - 5167	40"	1016.00	5L400	12 - 5213	86"	2184.40	5L860
12 - 5168	41"	1041.40	5L410	12 - 5214	87"	2209.80	5L870
12 - 5169	42"	1066.80	5L420	12 - 5215	88"	2235.20	5L880
12 - 5170	43"	1092.20	5L430	12 - 5216	89"	2260.60	5L890
12 - 5171	44"	1117.60	5L440	12 - 5217	90"	2286.00	5L900
12 - 5172	45"	1143.00	5L450	12 - 5218	91"	2311.40	5L910
12 - 5173	46"	1168.40	5L460	12 - 5219	92"	2336.80	5L920
12 - 5174	47"	1193.80	5L470	12 - 5220	93"	2362.20	5L930
12 - 5175	48"	1219.20	5L480	12 - 5221	94"	2387.60	5L940
12 - 5176	49"	1244.60	5L490	12 - 5222	95"	2413.00	5L950
12 - 5177	50"	1270.00	5L500	12 - 5223	96"	2438.40	5L960
12 - 5178	51"	1295.40	5L510	12 - 5224	97"	2463.80	5L970
12 - 5179	52"	1320.80	5L520	12 - 5225	98"	2489.20	5L980
12 - 5180	53"	1346.20	5L530	12 - 5226	99"	2514.60	5L990
12 - 5181	54"	1371.60	5L540	12 - 5227	100"	2540.00	5L1000
12 - 5182	55"	1397.00	5L550	12 - 6643	101"	2565.40	5L1010
12 - 5183	56"	1422.40	5L560	12 - 6644	102"	2590.80	5L1020
12 - 5184	57"	1447.80	5L570	12 - 6645	103"	2616.20	5L1030
12 - 5185	58"	1473.20	5L580	12 - 6646	104"	2641.60	5L1040
12 - 5186	59"	1498.60	5L590	12 - 6647	105"	2667.00	5L1050
12 - 5187	60"	1524.00	5L600	12 - 6648	106"	2692.40	5L1060
12 - 5188	61"	1549.40	5L610	12 - 6649	107"	2717.80	5L1070
12 - 5189	62"	1574.80	5L620	12 - 6650	108"	2743.20	5L1080
12 - 5190	63"	1600.20	5L630	12 - 6651	109"	2768.60	5L1090
12 - 5191	64"	1625.60	5L640	12 - 6652	110"	2794.00	5L1100
12 - 5192	65"	1651.00	5L650	12 - 6653	111"	2819.40	5L1110
12 - 5193	66"	1676.40	5L660	12 - 6654	112"	2844.80	5L1120
12 - 5194	67"	1701.80	5L670	12 - 6655	113"	2870.20	5L1130
12 - 5195	68"	1727.20	5L680	12 - 6656	114"	2895.60	5L1140

BELTS



**Heavy Duty Belts
Reinforced with
Aramid Fiber**



Our Belts are made with high-strength Aramid fiber cords for heavy duty applications and severe duty cycles. These belts have a "drier" cover fabric that was designed to increase flexibility and withstand severe clutching action, bending or twisting, heavy loads and back-side idler applications. Oil and heat resistant. Individually sleeved with dimensions in inches and millimeters. Available in 3/8", 1/2" and 5/8" widths.

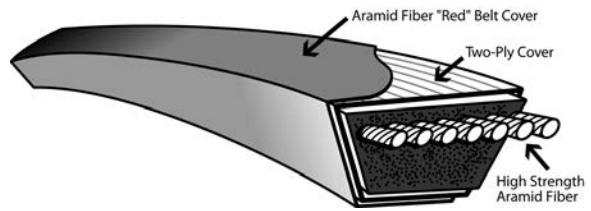

3/8" (9.53 mm) SECTION

12

BELTS

Order No.	Length	Milli-meters	Order No.	Length	Milli-meters
12 - 7429	24"	609.60	12 - 7443	38"	965.20
12 - 7430	25"	635.00	12 - 7444	39"	990.60
12 - 7431	26"	660.40	12 - 7445	40"	1016.00
12 - 7432	27"	685.80	12 - 7446	41"	1041.40
12 - 7433	28"	711.20	12 - 7447	42"	1066.80
12 - 7434	29"	736.60	12 - 7448	43"	1092.20
12 - 7435	30"	762.00	12 - 7449	44"	1117.60
12 - 7436	31"	787.40	12 - 7450	45"	1143.00
12 - 7437	32"	812.80	12 - 7451	46"	1168.40
12 - 7438	33"	838.20	12 - 7452	47"	1193.80
12 - 7439	34"	863.60	12 - 7453	48"	1219.20
12 - 7440	35"	889.00	12 - 7454	49"	1244.60
12 - 7441	36"	914.40	12 - 7455	50"	1270.00
12 - 7442	37"	939.80			



Aramid Fiber Belts (Cont.)



1/2" (12.70 mm) SECTION

Order No.	Length	Milli-Meters	"A" Series	Order No.	Length	Milli-Meters	"A" Series
12 - 7466	23"	584.20	A021	12 - 7512	69"	1752.60	A067
12 - 7467	24"	609.60	A022	12 - 7513	70"	1778.00	A068
12 - 7468	25"	635.00	A023	12 - 7514	71"	1803.40	A069
12 - 7469	26"	660.40	A024	12 - 7515	72"	1828.80	A070
12 - 7470	27"	685.80	A025	12 - 7516	73"	1854.20	A071
12 - 7471	28"	711.20	A026	12 - 7517	74"	1879.60	A072
12 - 7472	29"	736.60	A027	12 - 7518	75"	1905.00	A073
12 - 7473	30"	762.00	A028	12 - 7519	76"	1930.40	A074
12 - 7474	31"	787.40	A029	12 - 7520	77"	1955.80	A075
12 - 7475	32"	812.80	A030	12 - 7521	78"	1981.20	A076
12 - 7476	33"	838.20	A031	12 - 7522	79"	2006.60	A077
12 - 7477	34"	863.60	A032	12 - 7523	80"	2032.00	A078
12 - 7478	35"	889.00	A033	12 - 7524	81"	2057.40	A079
12 - 7479	36"	914.40	A034	12 - 7525	82"	2082.80	A080
12 - 7480	37"	939.80	A035	12 - 7526	83"	2108.20	A081
12 - 7481	38"	965.20	A036	12 - 7527	84"	2133.60	A082
12 - 7482	39"	990.60	A037	12 - 7528	85"	2159.00	A083
12 - 7483	40"	1016.00	A038	12 - 7529	86"	2184.40	A084
12 - 7484	41"	1041.40	A039	12 - 7530	87"	2209.80	A085
12 - 7485	42"	1066.80	A040	12 - 7531	88"	2235.20	A086
12 - 7486	43"	1092.20	A041	12 - 7532	89"	2260.60	A087
12 - 7487	44"	1117.60	A042	12 - 7533	90"	2286.00	A088
12 - 7488	45"	1143.00	A043	12 - 7534	91"	2311.40	A089
12 - 7489	46"	1168.40	A044	12 - 7535	92"	2336.80	A090
12 - 7490	47"	1193.80	A045	12 - 7536	93"	2362.20	A091
12 - 7491	48"	1219.20	A046	12 - 7537	94"	2387.60	A092
12 - 7492	49"	1244.60	A047	12 - 7538	95"	2413.00	A093
12 - 7493	50"	1270.00	A048	12 - 7539	96"	2438.40	A094
12 - 7494	51"	1295.40	A049	12 - 7540	97"	2463.80	A095
12 - 7495	52"	1320.80	A050	12 - 7541	98"	2489.20	A096
12 - 7496	53"	1346.20	A051	12 - 7542	99"	2514.60	A097
12 - 7497	54"	1371.60	A052	12 - 7543	100"	2540.00	A098
12 - 7498	55"	1397.00	A053	12 - 7544	101"	2565.40	A099
12 - 7499	56"	1422.40	A054	12 - 7545	102"	2590.80	A0100
12 - 7500	57"	1447.80	A055	12 - 7546	103"	2616.20	A0101
12 - 7501	58"	1473.20	A056	12 - 7547	104"	2641.60	A0102
12 - 7502	59"	1498.60	A057	12 - 7548	105"	2667.00	A0103
12 - 7503	60"	1524.00	A058	12 - 7549	106"	2692.40	A0104
12 - 7504	61"	1549.40	A059	12 - 7550	107"	2717.80	A0105
12 - 7505	62"	1574.80	A060	12 - 7551	108"	2743.20	A0106
12 - 7506	63"	1600.20	A061	12 - 7552	109"	2768.60	A0107
12 - 7507	64"	1625.60	A062	12 - 7553	110"	2794.00	A0108
12 - 7508	65"	1651.00	A063	12 - 7554	111"	2819.40	A0109
12 - 7509	66"	1676.40	A064	12 - 7555	112"	2844.80	A0110
12 - 7510	67"	1701.80	A065	12 - 7556	113"	2870.20	A0111
12 - 7511	68"	1727.20	A066	12 - 7557	114"	2895.60	A0112

12 BELTS

BELTS



Aramid Fiber Belts (Cont.)



5/8" (15.88 mm) SECTION

BELTS

Order No.	Length	Milli-Meters	"B" Series	Order No.	Length	Milli-Meters	"B" Series
12 - 7570	25"	635.00	B022	12 - 7615	70"	1778.00	B067
12 - 7571	26"	660.40	B023	12 - 7616	71"	1803.40	B068
12 - 7572	27"	685.80	B024	12 - 7617	72"	1828.80	B069
12 - 7573	28"	711.20	B025	12 - 7618	73"	1854.20	B070
12 - 7574	29"	736.60	B026	12 - 7619	74"	1879.60	B071
12 - 7575	30"	762.00	B027	12 - 7620	75"	1905.00	B072
12 - 7576	31"	787.40	B028	12 - 7621	76"	1930.40	B073
12 - 7577	32"	812.80	B029	12 - 7622	77"	1955.80	B074
12 - 7578	33"	838.20	B030	12 - 7623	78"	1981.20	B075
12 - 7579	34"	863.60	B031	12 - 7624	79"	2006.60	B076
12 - 7580	35"	889.00	B032	12 - 7625	80"	2032.00	B077
12 - 7581	36"	914.40	B033	12 - 7626	81"	2057.40	B078
12 - 7582	37"	939.80	B034	12 - 7627	82"	2082.80	B079
12 - 7583	38"	965.20	B035	12 - 7628	83"	2108.20	B080
12 - 7584	39"	990.60	B036	12 - 7629	84"	2133.60	B081
12 - 7585	40"	1016.00	B037	12 - 7630	85"	2159.00	B082
12 - 7586	41"	1041.40	B038	12 - 7631	86"	2184.40	B083
12 - 7587	42"	1066.80	B039	12 - 7632	87"	2209.80	B084
12 - 7588	43"	1092.20	B040	12 - 7633	88"	2235.20	B085
12 - 7589	44"	1117.60	B041	12 - 7634	89"	2260.60	B086
12 - 7590	45"	1143.00	B042	12 - 7635	90"	2286.00	B087
12 - 7591	46"	1168.40	B043	12 - 7636	91"	2311.40	B088
12 - 7592	47"	1193.80	B044	12 - 7637	92"	2336.80	B089
12 - 7593	48"	1219.20	B045	12 - 7638	93"	2362.20	B090
12 - 7594	49"	1244.60	B046	12 - 7639	94"	2387.60	B091
12 - 7595	50"	1270.00	B047	12 - 7640	95"	2413.00	B092
12 - 7596	51"	1295.40	B048	12 - 7641	96"	2438.40	B093
12 - 7597	52"	1320.80	B049	12 - 7642	97"	2463.80	B094
12 - 7598	53"	1346.20	B050	12 - 7643	98"	2489.20	B095
12 - 7599	54"	1371.60	B051	12 - 7644	99"	2514.60	B096
12 - 7600	55"	1397.00	B052	12 - 7645	100"	2540.00	B097
12 - 7601	56"	1422.40	B053	12 - 7646	101"	2565.40	B098
12 - 7602	57"	1447.80	B054	12 - 7647	102"	2590.80	B099
12 - 7603	58"	1473.20	B055	12 - 7648	103"	2616.20	B0100
12 - 7604	59"	1498.60	B056	12 - 7649	104"	2641.60	B0101
12 - 7605	60"	1524.00	B057	12 - 7650	105"	2667.00	B0102
12 - 7606	61"	1549.40	B058	12 - 7651	106"	2692.40	B0103
12 - 7607	62"	1574.80	B059	12 - 7652	107"	2717.80	B0104
12 - 7608	63"	1600.20	B060	12 - 7653	108"	2743.20	B0105
12 - 7609	64"	1625.60	B061	12 - 7654	109"	2768.65	B0106
12 - 7610	65"	1651.00	B062	12 - 7655	110"	2794.00	B0107
12 - 7611	66"	1676.40	B063	12 - 7656	111"	2819.40	B0108
12 - 7612	67"	1701.80	B064	12 - 7657	112"	2844.80	B0109
12 - 7613	68"	1727.20	B065	12 - 7658	113"	2870.20	B0110
12 - 7614	69"	1752.60	B066	12 - 7659	114"	2895.60	B0111



**OEM BELT QUICK LOOK-UP
SEE OEM BELT PAGES FOR DETAILED DESCRIPTION**

Replaces OEM No.	Rotary Order No.	Replaces OEM No.	Rotary Order No.	Replaces OEM No.	Rotary Order No.
ARIENS		AYP (CONT.)		CUB CADET (CONT.)	
72023	8762	191273	11034	754-04045	11845
72047	8432	193214	11861	754-04062	11846
72066	8430	194346	11862	754-04064	11840
72086	8431	196103	11863	754-04077	11847
72098	8429	197242	11864	754-0640	11849
72108	8428	197253	11867	754-04138	12768
72114	8425	401603	12398	754-04153	12769
72130	8427	402009	12423	754-0641	11850
72131	8426	405143	12286	754-3055A	11997
		408007	14116	754-3068	11820
AYP		408010	14117	754-3084	10901
9180R	9769	408019	14512	954-04077	11847
62828	8510	428454	14513	954-0460	11820
106085X	6901			954-0640	11849
106412X	8512	BUNTON		954-0641	11850
110883X	8465	PLO619	7915	954-0644	10783
110884X	9945	PLO619	5241	954-0645	10784
119612	12052	PLO643	5327	954-3036	10781
124293X	6900	PLO848	5238	954-3038	10563
126907X	6902	PL4275	7913	954-3039	12051
130801	9764			954-3073	10782
131290	7184	BOBCAT		954-3084	10901
132801	9765	38016N	5242	954-04118	12609
137078	10306	38017N	5241	01007015	12850
137153	9367	38030N	5823	02000154	12708
138255	8784	38212	6969		
138399	9766	38249	6836	DIXIE CHOPPER	
139573	9368	38440	8803	2006B44R	12239
140067	8464	38442	8809	2006B87R	12751
140218	8781	38523	8810	2006B88	11502
140294	9336	128003	11853	2006B98	12442
141416	9337	128099	8811	2006B99W	12238
144200	8516	2188134	11468	2006B160R	12452
144959	9697	2188128	8808	2006B144R	12443
146527	9848			2008B89	12983
148763	9698	COMET		2008B97	13219
156971	10008	200393	13241	9907A96	10022
157769	10306	203578A	13048	9907B41	10025
158818	9312	203580A	13054	9907B57	11223
161597	10078	203581A	13047	9907B84	10814
161741	9767	203582	13242	9907B85	10032
163817	9768	203583A	13052	9907B92	11225
165555	870	203584A	13088	9907B94	11226
174368	10076	203585A	13059	9907B112	10033
174883	10232	203586A	13058	9907B130	10034
174978	9964	203590A	13053	97345B40	10024
175436	12480	203592	13243	97346C158	10815
178138	12892	203593	13050	20256B38	10023
180214	11130	203785A	13057	30203B103	10036
180216	11129			30204B78	10027
180217	10005	CUB CADET		30236-0B128	10011
180808	10077	490489	10830	63203A89	10035
183533	14117	754-04033	11843	63204B42	10026
187283	11304	754-04044	11844	65080B80	10029

BELTS



**OEM BELT QUICK LOOK-UP
SEE OEM BELT PAGES FOR DETAILED DESCRIPTION**

Replaces OEM No.	Rotary Order No.
DIXIE CHOPPER (CONT.)	
68081B81	10030
68082B82	10031
68162B162	10010
20000B64	11503
DIXON	
2412	8508
6111	8509
7650	8469
EXMARK	
413093	10037
523175	10038
633569	9863
643052	10041
653368	10040
653438	10717
103-0866	10716
103-0881	10254
103-0882	10255
103-1297	10256
103-2240	14638
103-4014	12237
103-4761	12641
103-6506	12783
109-3388	12426
109-4994	14165
109-5364	12425
109-7582	12799
109-8070	14217
109-8073	14167
116-3455	14209
1-303080	5867
1-323051	5865
1-323280	8812
1-323288	9257
1-323299	8091
1-323300	8805
1-323344	13108
1-323733	13109
1-323734	13110
1-403024	8370
1-403025	8092
1-413094	11504
1-413095	10887
1-413096	12405
1-413308	10251
1-603045	10886
1-603306	10885
1-603576	12256
1-613271	10884
1-633127	9016
1-633162	10257
1-633173	9014

Replaces OEM No.	Rotary Order No.
EXMARK (CONT.)	
1-633366	9862
1-653163	10252
1-653332	10167
1-653333	10039
1-653416	1025
GRASSHOPPER	
381914	8733
382034	12094
382035	10743
382037	8731
382080	12095
382082	12096
382084	12097
382085	10744
382086	12098
382090	12099
382093	14363
382095	10745
382097	12100
382098	12106
382099	12107
382110	12108
382111	12109
GRAVELY	
49029	8717
72224	8717
72250	8760
72258	8711
72266	7837
7225800	8711
GREAT DANE	
D118348	10894
D18005	10624
D18007	10625
D18087	10623
D18303	10893
D28028	10626
D28029	10627
D28030	10628
D28031	10629
HUSQVARNA	
506-29-67-02	13118
510-201201	12653
532-408007	14116
532-408010	14117
532-408019	14512
532-408381	13501
532-428454	14513
532-429532	13499

Replaces OEM No.	Rotary Order No.
HUSQVARNA (CONT.)	
532-441597	14359
539-103241	10949
539-103687	11032
539-107709	10834
539-107710	10835
539-110410	12686
544-90-84-02	13118
HUSTLER	
600726	12318
600734	12264
600979	12689
601015	12690
602988	14000
781443	10844
782292	10847
784207	10846
784231	10851
784249	10852
784322	10861
786483	10849
786491	10850
786533	10848
7781310	10845
788711	12688
788729	12695
788737	12693
788745	12417
788794	12414
789388	12320
791335	12319
793828	12415
793836	12413
793893	12416
795781	12691
797167	12692
797514	12694
797720	12322
797928	12321
797936	12323
JOHN DEERE	
GC00073	10485
GC00081	10486
GX10176	10630
GX20006	10434
GX20072	10436
GX20241	10435
GX20305	10437
GX21395	14243
GX21833	12461
GX22819	11811
GY20570	10436

12 BELTS



**OEM BELT QUICK LOOK-UP
SEE OEM BELT PAGES FOR DETAILED DESCRIPTION**

Replaces OEM No.	Rotary Order No.	Replaces OEM No.	Rotary Order No.	Replaces OEM No.	Rotary Order No.
JOHN DEERE (CONT.)		MTD (CONT.)		MURRAY	
GY20571	10437	954-0370	6908	37X11	6501
GY20572	10388	754-0371A	6845	37X12	6876
M110312	10388	954-0371A	6845	37X22	6903
M110313	12077	754-04041	12610	37X26	6502
M110978	10751	954-04041	12610	37X33	6505
M111534	14390	754-04043	12382	37X35	6505
M1118685	13217	954-04043	12382	37X38	6503
M122106	11026	754-04048	12667	37X40	6504
M122107	11027	954-04048	12667	37X43	4998
M122907	11028	754-04122	11848	37X45	6505
M124895	12678	754-04142	12489	37X49	6506
M125218	10749	954-04142	12489	37X57	6507
M126009	12898	954-04265	14215	37X61	6508
M126536	12373	754-04265	14215	37X62	6904
M143019	12078	954-0430	12429	37X63	6509
M154601	12559	754-0430	12429	37X64	8747
M154621	12560	754-0433	6842	37X65	7245
M74747	10750	954-0433	6842	37X66	8444
TCU13195	12759	754-0439	9119	37X68	8442
TCU13198	12760	954-0439	9119	37X69	8443
TCU16026	14237	754-0440	9120	37X70	7672
TCU16092	11024	954-0440	9120	37X75	7673
TCU16093	11025	754-0441	9847	37X80	9994
		754-0446	9932	37X83	9481
		754-04050	14118	37X86	9712
MTD		954-04050	14118	37X87MA	9995
754-0101A	10089	954-0453	9480	37X88	8972
954-0101A	10089	754-04060B	11660	37X89	9313
954-0197	9900	954-04060B	11660	37X92	9713
754-0240	6907	954-0461	9903	37X93	9714
954-0240	6907	754-0467	11482	37X96	9715
754-0241	6906	954-0467	11482	37X98	10042
954-0241	6906	754-0468	11483	37X106	10910
754-0264	7169	954-0468	11483	37X110	10832
754-0266	6838	754-0472	9935	37X111	10911
954-0266	6838	954-0474	10261	37X112	10912
954-0271	9901	954-0476	10260	37X113	10913
754-0280	6839	754-0483	11135	37X114	11029
954-0280	6839	954-0483	11135	37X115	11030
754-0281	6840	754-0485	10009	37X125	12462
754-0293	6841	954-0485	10009	1001223	675
954-0293	6841	954-0486A	10100	585416MA	14120
754-0329A	6842	754-0497	11019		
954-0329A	6842	954-0497	11019	POULAN	
754-0346	6950	954-0498	10369	539-109243	12399
954-0346	6950	754-0637A	11137	539-110411	12400
754-0349	6843	954-0637A	11137	539-110832	12401
954-0349	6843	754-0642	11661		
754-0350	6844	954-0642	11661	NOMA	
954-0350	6844	954-04001	10831	48044	6970
754-0355	6949	754-04002	10833	54758	6896
954-0355	6949	954-04002	10833	57214	6952
754-0358	9570	754-0460	11132	58170	7183
954-0362	9482	954-0460	11132		
754-0370	6908				

12 BELTS

BELTS



**OEM BELT QUICK LOOK-UP
SEE OEM BELT PAGES FOR DETAILED DESCRIPTION**

Replaces OEM No.	Rotary Order No.
NOMA (CONT.)	
300142	6894
300680	7128
302289	6872
303241	6898
305148	6899
308701	6871
SCAG	
48087	7789
48089	7790
48202	5235
48203	7791
48204	5236
48207	7631
48553	12049
48587	10402
48752	10404
48799	10403
48912	8714
48996	10405
481001	10407
481460	10317
481461	10043
481498	10409
481499	10410
481557	10411
481558	10044
481749	10914
481980	12233
482009	10045
48202A	5235
482137	10046
482138	10047
482139	10048
482140	10049
482171	10050
482529	10365
482530	12371
482641	10318
482652	12824
482716	10319
482873	12248
482876	12249
483157	12067
483165	12085
483172	12068
483239	12069
483240	12070
483241	12071
483242	12072
483243	12073
483325	12718
483326	12719
483741	14593

Replaces OEM No.	Rotary Order No.
SIMPLICITY	
1665368	6874
1703466	6874
1713549	8510
SNAPPER	
10749	673
11887	669
12058	669
12353	670
12354	869
14525	870
14799	7129
14800	8075
18236	675
22252	675
22252	7838
28619	8767
28784	8768
43844	9483
44637	8767
76496	5232
76497	5233
46784	11677
7103789	14166
STIHL	
9490-000-7900	13117
TORO	
102742	7171
25-6430	7952
26-9671	10746
26-9672	10210
27-1160	6837
42-0884	8887
44-6260	10387
47-1410	5820
47-1420	5821
51-4290	5231
55-7660	6972
55-9300	9861
71-5381	10090
75-9010	12687
88-6250	14365
91-2258	14042
99-4647	10051
105-7790	12805
105-8783	12729
106-7350	12730
106-7369	12867
110-6774	14129
110-6871	14130
110-6892	12672

Replaces OEM No.	Rotary Order No.
TORO (CONT.)	
112-5800	11845
115-4971	14318
115-9613	14319
1-663749	12916
WALKER	
6231	8820
6250	12246
7230	10320
7234	8819
7235	8798
7248	10322
8230	10323
7234-1	10321
YAZOO	
103241	10949
104335	10823
104336	10824
105477	10825
205-505	7894

12 BELTS



Belts for ARIENS

Order No.	Description
12 - 8762	Snowblower Belt. Replaces Ariens 72023 . 1/4" (6.35 mm) x 27.153" (689.69 mm). Fits models 1975-1978 & Sno-Tro model. Drive belt 4 & 5 hp, 1969-1974 models 922018, 922019, 922020 & 922021. Raw edge, traction drive belt. This belt sold in matching pairs.
12 - 8432	Snowblower Belt. Replaces Ariens 72047 . 3/8" (9.53 mm) x 35-1/2" length (901.70 mm), wrapped belt. Fits older model Ariens with single belt.
12 - 8430	Snowblower Belt. Replaces Ariens 72066 . 3/8" (9.53 mm) x 34" length (863.60 mm), raw edge belt. Fits models 924080, 924082, 924084, 924085, 924086, 924087, 8-12 hp engines.
12 - 8431	Snowblower Belt. Replaces Ariens 72086 . 1/2" (12.70 mm) x 40" length (1016.00 mm), raw edge belt. Fits models 924082, 8 hp engines.
12 - 8429	Snowblower Belt. Replaces Ariens 72098 . 3/8" (9.53 mm) x 33" length (838.20 mm), raw edge belt. Fits 92400 series. Models 00026, 27, 32, 33, 36, 38, 39, 46, 48, 49 & some 51, 52.
12 - 8428	Snowblower Belt. Replaces Ariens 72108 . 1/2" (12.70 mm) x 37" length (939.80 mm), raw edge belt. Fits models 924084, 924086, 10 hp engines.
12 - 8425	Snowblower Belt. Replaces Ariens 72114 . 1/2" (12.70 mm) x 34-1/2" length (876.30 mm), raw edge belt.
12 - 8427	Snowblower Belt. Replaces Ariens 72130 . 1/2" (12.70 mm) x 39" length (990.60 mm), raw edge belt. Fits models 924085, 924087, 924091 & 924092, 10 hp engines.
12 - 8426	Snowblower Belt. Replaces Ariens 72131 . 3/8" (9.53 mm) x 36" length (914.40 mm), raw edge belt. Fits models 924085, 924087, 924091 & 924092, 12 hp engines.
12 - 13505	Snowblower Belt. Replaces Ariens 7200004 . 1/2" (12.7 mm) x 35.4" (899 mm). Fits 924 series Snow Thrower models. Laminated, Aramid cord construction..
12 - 13509	Snowblower Belt. Replaces Ariens 7200007 . 1/2" (12.7 mm) x 34-7/8" (886 mm). Auger Drive belt fits 932 series Snow Thrower models. Laminated, Aramid cord construction.
12 - 13508	Snowblower Belt. Replaces Ariens 7200020 . 1/2" (12.7 mm) x 37-1/8" (943 mm). Auger Drive belt fits 926 series Snow Thrower models. Laminated, Aramid cord construction.
12 - 13507	Snowblower Belt. Replaces Ariens 7200021 . 1/2" (12.7 mm) x 38" (965.2 mm). Auger Drive belt fits 926 series Snow Thrower models. Laminated, Aramid cord construction.
12 - 13284	Snowblower Belt. Replaces Ariens 7207400 . 1/4" (6.35 mm) x 27" (685.8 mm). Fits 6 HP Sno-Thro models. Traction Drive. Set of (2) matched belts.
12 - 13506	Snowblower Belt. Replaces Ariens 7236200 . 1/2" (12.7 mm) x 37-1/2" (952.5 mm). Auger Drive belt fits 924 series Snow Thrower models. Laminated, Aramid cord construction.

12 BELTS

BELTS



Belts for AMF (See NOMA)

Order No. Description
AYP - SEARS/ROPER

- 12 - 9769** **V Belt.** Replaces AYP **9180R**. 1/2" (12.7 mm) x 41-1/2" (1054 mm). Polyester cord construction.
- 12 - 8510** **Blade Belt.** Replaces AYP **62828**. 1/2" (12.70 mm) x 69-1/2" length (1765.30 mm). Fits 8 hp 36" cut models L1252AR, L8212AR, front engine riders. Covered.
- 12 - 6901** **Blade Drive Belt.** Replaces Sears/Roper **106085X**. 79.10" (2006.60 mm) x 17/32" (13.49 mm). Fits 18 hp rider tractors with elect. clutch. Also fits 36", 38" & 44".
- 12 - 8512** **Transmission Belt.** Replaces AYP **106412X**. 1/2" (12.70 mm) x 69" length (1752.60 mm). Fits 11 hp 36" cut model L0815AR, front engine rider. Covered.
- 12 - 8465** **Drive Belt.** Replaces AYP **110883X**. 1/2" (12.70 mm) x 99" length (2514.60 mm). Fits 20 hp 50" cut model 951940, front engine rider. Covered.
- 12 - 9945** **Deck Belt.** Replaces AYP **110884X**. 1/2" (12.7 mm) x 93-1/2" (2375 mm). Fits AYP models XEG11082HAR & PP2050 Poulan Pro PTO. *Aramid fiber.
- 12 - 6900** **Belt.** Replaces Sears/Roper **124293X**. 80" length (2032 mm) x 1/2" (12.70 mm). Covered.
- 12 - 6902** **Transmission Belt.** Replaces Sears/Roper **125907X, 126907X**. 1/2" (12.70 mm) x 90" length (2286 mm). Fits 38" cut model YT14. Covered.
- 12 - 9764** **Engine to Transmission Belt.** Replaces AYP **130801, 138255, 160855**. 1/2" (12.7 mm) x 95" (2413 mm). Polyester cord construction.
- 12 - 8511** **Deck Belt.** Replaces AYP **130969**. 1/2" (12.70 mm) x 92-1/2" length (2349.50 mm) Fits 12, 12.5, & 14 hp 42" cut models RL1242A, WP12542A, Y1442A, front engine riders. Covered.
- 12 - 8462** **Drive Belt.** Replaces AYP **131006**. 1/2" (12.70 mm) x 98-1/4" length (2495.55 mm). Fits 18 hp 42" cut model RY1842A, WP1842A, front engine riders. Covered.
- 12 - 8463** **Deck Belt.** Replaces AYP **131264**. 1/2" (12.70 mm) x 78-1/2" length (1993.90 mm). Fits 10 hp 36" cut model WP1036A & 11 hp 36" cut model T1136B. Front engine riders. Covered.
- 12 - 7184** **Blade Belt.** Replaces AYP **131290X**. 1/2" (12.70 mm) x 88" length (2235.20 mm). Fits 38" front engine rider model 7122A29. Also fits Husky/Poulan. Covered.
- 12 - 9765** **V Belt.** Replaces AYP **132801**. 1/2" (12.7 mm) x 52" (1320.8 mm). *Aramid fiber.
- 12 - 9367** **Drive Belt.** Replaces AYP **137153**. 1/2" (12.7 mm) x 83-1/2" (2120.9 mm) Fits 50" cut, 16 hp engines. Model 8209B89. *Aramid fiber. White cover.
- 12 - 8784** **Deck Belt.** Replaces AYP **138255**. 1/2" (12.70 mm) x 95.25" (2419.4 mm). Secondary deck drive belt for 50" cut. *Aramid fiber. Covered.



**Belts for
AYP - SEARS/ROPER (Cont.)**

Order No.	Description
12 - 9368	Primary Deck Belt. Replaces AYP 139573 . 1/2" (12.7 mm) x 83-1/2" (2120.9 mm) Fits 46" & 50" cut, 16, 19, 20, 22 & 24 hp engines. Deck models YGT, YPT & PP. *Aramid fiber. Black cover.
12 - 8464	Blade Belt. Replaces AYP 140067 . 1/2" (12.70 mm) x 82-1/2" length (2095.50 mm). Fits 8 hp 36" cut model L1252AR, front engine rider. Covered.
12 - 8781	Drive Belt. Replaces AYP 140218 . 1/2" (12.70 mm) x 84.5" (2146.3 mm). Fits Western Auto 50" cut, model 8228A49 with 20 hp Kohler engine. *Aramid fiber. Covered.
12 - 9336	Hydro Belt. Replaces AYP 140294 . 1/2" (12.7 mm) x 82" (2082.8 mm) Fits 42" & 44" cut, 18 & 18.5 hp engines. Models WE185H42F & Y18H44D. *Aramid fiber. 2 ply white. Covered.
12 - 9337	Hydro Belt. Replaces AYP 141416 . 1/2" (12.7 mm) x 83-3/4" (2127.3 mm) Fits 42" cut, 14.5 & 16 hp engines. Model 9169A99. Neoprene. *Aramid fiber. Clutching cover. Covered.
12 - 8516	Deck Belt. Replaces AYP 144200 . 1/2" (12.70 mm) x 88-3/8" length (2244.73 mm). Fits 42" cut decks with double idler pulleys. Covered. Fits 54" mowers. Wrapped molded, neoprene, polyester cord construction. Clutching cover.
12 - 9697	Drive Belt. Replaces AYP 144959 . 1/2" (12.7 mm) x 95-1/2" (2425.4 mm). Fits model 24H4B3A & 8209A99. Fits 46" & 50" cut. 16, 22 & 24 hp engines. *Aramid fiber. Covered. Fits Poulan Pro 12012
12 - 9848	Drive Belt. Replaces AYP 146527 . 3/8" (9.5mm) x 32-1/2" (825.5 mm). Polyester cord construction.
12 - 9698	Primary Drive Belt. Replaces AYP 148763 . 5/8" (15.88 mm) x 85-3/8" (2168.5 mm). Tractor to mower for AYP 46" with 18 & 20 hp Kohler engines, model year '95 & '97. General purpose, polyester cord construction. Covered.
12 - 10008	Ground Drive Belt. Replaces AYP 156971 . 1/2" (12.7 mm) x 82" (2096 mm). Fits 42" AYP riders. *Aramid fiber.
12 - 10306	Drive Belt. Replaces AYP 157769, 137078 . 3/8" (9.52 mm) x 32.3/16" (817.8 mm). Fits self propelled walkbehind mowers. Fiberglass cord construction.
12 - 9312	Deck Belt. Replaces AYP 158818 . 1/2" (12.7 mm) x 83-5/8" (2124.1 mm) Fits 46" cut models. *Aramid fiber. Clutching cover. Covered.
12 - 10078	Ground Drive Belt. Replaces AYP 161597 . 1/2" (12.7 mm) x 82-1/2" (2096 mm). *Aramid fiber. Fits 48" & 54". AYP riders & Poulan Pro units.
12 - 9767	Drive Belt. Replaces AYP 161741 . 1/2" (12.7 mm) x 79" (2006.6 mm). Fits 10 & 11 HP, 36" cut front engine riders. *Aramid fiber.
12 - 9768	Drive Belt. Replaces AYP 163817 . 1/2" (12.7 mm) x 95" (2413 mm). *Aramid fiber.

12 BELTS

BELTS







**Belts for
AYP - SEARS/ROPER (Cont.)**

Order No.	Description
12 - 870	Blade Belt. Replaces AYP 165555 & 170037 hexagonal belt. AA-105. Fits 36" rear discharge tractor models. Double V.
12 - 10076	Primary Deck Belt. Replaces AYP 174368 . 5/8" (15.88 mm) x 90" (2286 mm). Fits 48" riders. Polyester cord construction.
12 - 10232	Blade Drive Belt. Replaces AYP 174883 . 21/32" (16.69 mm) x 97.4" (2473.96 mm). Secondary Drive Belt for 42" cut. Wrapped molded. General purpose, polyester cord construction, clutch cover.
12 - 9964	Deck Belt. Replaces AYP 174978 . 1/2" (12.7 mm) x 84-1/2" (2146 mm). Fits 36" side discharge models. *Aramid fiber.
12 - 12480	Deck Drive Belt. Replaces AYP 175436 . 3/8" (9.5 mm) x 32" (812.8 mm). Fits 21" rear bagger, self propelled mower. General purpose, Aramid cord construction, double clutching cover.
12 - 12892	Deck Drive Belt. Replaces AYP 178138 . 1/2" (12.7 mm) x 87.64" (2226.1 mm). Fits 42" mower drive belt. Wrapped molded, Aramid cord construction, double clutching cover, color brown.
12 - 11130	Belt. Replaces AYP 180214 . 1/2" (12.70 mm) x 87" (2209.8 mm). Fits 12 hp 38" cut. Wrapped 2 ply aramid cord construction.
12 - 11129	Belt. Replaces AYP 180216 . 1/2" (12.70 mm) x 83" (2108.2 mm). Fits 11 hp 36" cut. Wrapped 2 ply aramid cord construction.
12 - 10005	Deck Belt. Replaces AYP 180217 , 165555 . 1/2" (12.7 mm) x 106.9" (2715 mm). Fits 36" rear discharge lawn tractors. *Aramid fiber. Double "V"
12 - 10077	Secondary Deck Belt. Replaces AYP 180808 . 5/8" (15.88 mm) x 89" (2261 mm). Fits AYP & Poulan Pro units. Polyester cord construction.
12 - 11034	Deck Belt. Replaces AYP 191273 , 187283 . 5/8" (15.88 mm) x 142.57" (3621.27 mm).
12 - 11861	Deck Drive Belt. Replaces AYP 193214 . 1/2" (12.7 mm) x 90.2" (2291.08 mm). Fits new 38" rider. General purpose, Aramid cord construction, double clutching cover.
12 - 11862	Drive Belt. Replaces AYP 194346 . 1/2" (12.7 mm) x 97.4" (2473.9 mm). Wrapped-molded, Aramid cord construction, double cover, clutching, brown color.
12 - 11863	Deck Drive Belt. Replaces AYP 196103 . 5/8" (15.875 mm) x 148" (3759.2 mm). Fits 54" rider. Neoprene, polyester cord, double cover.
12 - 11864	Deck Drive Belt. Replaces AYP 197242 . 5/8" (15.875 mm) x 138.75" (3524.25 mm). Fits 48" rider. Polyester cord, double cover.
12 - 11867	Deck to Spindle Belt. Replaces AYP 197253 . 1/2" (12.7 mm) x 100.97" (2564.68 mm). Polyester cord, double cover.
12 - 12052	Transmission Belt. Replaces AYP 199612 . 1/2" (12.7 mm) x 96.7/8" (2460.6 mm). Fits AYP 48" decks. Wrapped-molded, Aramid cord construction.



**Belts for
AYP - SEARS/ROPER (Cont.)**

Order No.	Description
12 - 12398	Deck Belt. Replaces AYP 401603 . 1/2" (12.7 mm) x 95.68" (2430.5 mm). General purpose, fiberglass cord construction, Double cover, cltuching.
12 - 12423	Deck Drive Belt. Replaces AYP 402009/169178 . 1/2" (12.7 mm) x 114" (2395.6 mm). Fits new 42" rear discharge. (AA x 114") General purpose, Aramid cord construction, double clutching cover.
12 - 12286	Deck Drive Belt. Replaces AYP 405143 . 1/2" (12.7 mm) x 105-3/4" (2686.1 mm). Fits 2007 models with 46" twin blade decks. Double cover, Aramid cord construction.
12 - 14116 	Snowthrower Belt. Replaces AYP 408007 , & Husqvarna 532408007 . 5/8" (15.8 mm) x 38" (965.2 mm). Fits models PP1150E27, PP208E24, PP208EPS24 Snowthrowers. Raw edge, Aramid cord construction.
12 - 14117 	Snowthrower Belt. Replaces AYP 408010/183533 , & Husqvarna 532408010 . 5/8" (15.8 mm) x 37-3/4" (939.8 mm). Fits models 10527SB, 10527SBE, 10530SBE, 1130SBLS, 1130SBE, 5224STE, 924SB, 924SBE, 927SB Snowthrowers. Raw edge, Aramid cord construction.
12 - 14512 	Snowthrower Belt. Replaces AYP 408019 , & Husqvarna 532408019 . 5/8" (15.8 mm) x 38.97" (989.8 mm). Fits models 1130 SBE OV, 11524E, 14527E, 145270 Snowthrowers. Raw edge, Aramid cord construction.
12 - 14513 	Snowthrower Belt. Replaces AYP 428454 , & Husqvarna 532428454 . 1/2" (12.7 mm) x 29.44" (747.8 mm). Fits models 1827 EXLT, 1830 EXLT Snowthrowers. Wrapped molded, Aramid cord construction, single cover.
12 - 13251	Deck Belt. Replaces AYP 429636 . 1/2" (12.7 mm) x 101.4" (2575.5 mm). Fits 2010 model 42" decks. Wrapped-molded, aramid cord construction, double cover, clutching, white.

CASTLEGARDEN

12 - 12370	Deck Belt. Replaces Castlegarden 35065460/0 , 1800RPP8m24. 199612. 8 mm x 225 teeth, 24 mm wide. Fits twin cut (1m22) TC122.
-------------------	--

COMET

12 - 13241	Torque Convert Belt. Replaces Comet 200393 & Manco 1154 . 5/8" (15.875 mm)x 27.397" (695.9 mm).
12 - 13048	Torque Convert Belt. Replaces Comet 203578A . 3/4" (19.05 mm)x 27.36" (694.9 mm).
12 - 13054	Torque Convert Belt. Replaces Comet 203580A & Manco 4292 . 3/4" (19.05 mm)x 29.28" (743.7 mm).
12 - 13047	Torque Convert Belt. Replaces Comet 203581A . 3/4" (19.05 mm)x 30.25" (768.4 mm).

BELTS



**Belts for
COMET**

Order No.

Description

- 12 - 13242** **Torque Convert Belt.** Replaces Comet **203582**.
3/4" (19.05 mm)x 31.23" (793.2 mm). Also fits Bristers rear mount.
- 12 - 13052** **Torque Convert Belt.** Replaces Comet **203583A**.
3/4" (19.05 mm)x 32.23" (793.2 mm). Also replaces G776 Belt S20
884-95F, fits Carter Bros.
- 12 - 13088** **Torque Convert Belt.** Replaces Comet **203584A, 884-100**.
3/4" (19.05 mm)x 33.187" (842.9 mm).
- 12 - 13088** **Torque Convert Belt.** Replaces Comet **203584A, 884-100**.
3/4" (19.05 mm)x 33.187" (842.9 mm).
- 12 - 13059** **Torque Convert Belt.** Replaces Comet **203585A**.
3/4" (19.05 mm)x 33.78" (858.0 mm). Fits 340 series clutches.
- 12 - 13058** **Torque Convert Belt.** Replaces Comet **203586A**.
3/4" (19.05 mm)x 35.14" (892.6 mm). Fits 340 series clutches.
- 12 - 8487** **Torque Convert Belt.** Replaces Comet **203589A**. Fits our **04-8382**
Torq-A-Verter. 3/4" (1905 mm) x 27-3/8" length (695.33 mm). Cogged.
- 12 - 13053** **Torque Convert Belt.** Replaces Comet **203590A & Manco 6959, 9655**.
3/4" (19.05 mm)x 28.32" (719.3 mm).
- 12 - 10052** **Torque Convert Belt.** Replaces Comet **203591**.
3/4" (19.05 mm) x 29.28" (744 mm). Belt for Torque Converter. Fits Manco,
Carter Brothers and many other Go-Carts.
- 12 - 13243** **Torque Convert Belt.** Replaces Comet **203592**.
3/4" (19.05 mm)x 30.25" (768.4 mm).
- 12 - 13050** **Torque Convert Belt.** Replaces Comet **203593A**.
3/4" (19.05 mm)x 31.23" (793.2 mm).
- 12 - 13627** **Torque Converter Belt.** Replaces Comet **203783A**. .875" (22.2 mm)
x 31.9" (810.4 mm). Fits Manco 2433. Aramid cord construction.
- 12 - 13592** **Drive Belt.** Replaces Comet **203784**. .875" (22.2 mm) x 32.9" (835.8 mm).
Fits Manco 6814 & 40-80 for Comet 40/44 series torque Converter.
Raw edge, cog, aramid cord construction.
- 12 - 13057** **Torque Convert Belt.** Replaces Comet **203785A & Manco 12346**, .
Carter Bros. G721. 7/8" (22.23 mm)x 33.87" (860.3 mm).

CUB CADET

- 12 - 10830** **PTO Deck Drive Belt.** Replaces Cub Cadet **490489-R2**. 1/2" (12.7 mm) x
81-1/2" (2070.1 mm). Fits 38", 42", & 48" cut on models 70, 86, 123 & 169.
Wrapped polyester cord construction.



**Belts for
CUB CADET**
Order No.

Description

- 12 - 11843** **Deck Drive Belt.** Replaces Cub Cadet **754-04033**. 1/2" (12.70 mm) x 118-1/4" (3003.5 mm). Fits 46" deck LT1045 & LT1046 models.
- 12 - 11844** **Deck Drive Belt.** Replaces Cub Cadet **754-04044**. 1/2" (12.70 mm) x 134" (3149.6 mm). Fits 50" deck models. Aramid, double cover, clutching belt.
- 12 - 11845** **Deck Drive Belt.** Replaces Cub Cadet **754-04045** & Toro 112-5800. 1/2" (12.7 mm) x 109.10" (2771.14 mm). Fits 42" decks. Wrapped molded general purpose, aramid cord, double clutching cover.
- 12 - 11846** **Blade Drive Belt.** Replaces Cub Cadet **754-04062**. 1/2" (12.7 mm) x 77-3/4" (1974.85 mm). Fits most 2005-2006 38" riding mowers. Aramid, double cover.
- 12 - 11840** **PTO Belt.** Replaces Cub Cadet **754-04064**. 5/8" (15.875 mm) x 68-1/4" (1733.5 mm). Fits 600 series riding mowers. Aramid Cord, Double wrapped clutching cover.
- 12 - 11847** **Blade Drive Belt.** Replaces Cub Cadet **754-04077/954-04077** . 5/8" (15.875 mm) x 133.7" (3395.98 mm) Fits LT1050 50" riding mowers. Aramid, double clutching cover.
- 12 - 12609** **Deck Belt.** Replaces Cub Cadet **754-04118 / 954-04118**. 1/2" (12.7 mm) x 122-1/2" (3111.5 mm). Fits new 46" deck, model L1046, LT1045 & LT1046. Wrapped molded, aramid cord construction, double cover clutching, color white.
- 12 - 12768** **Deck Belt.** Replaces Cub Cadet **754-04138**. 5/8" (15.875 mm) x 143" (3632.2 mm). RTZ54. General purpose, aramid cord construction.
- 12 - 12769** **Deck Belt.** Replaces Cub Cadet **754-04153**. 1/2" (12.7 mm) x 122" (3098.8 mm). Fits LT1045 & LT1046. General purpose, aramid cord construction.
- 12 - 12873** **PTO V-Belt.** Replaces Cub Cadet **754-04185**. 1/2" (12.7 mm) x 89.24" (2266.6 mm). Fits Craftsman Revolution tractor model 247.28933. Also fits. Cub Cadet i series zero turn tractors. MTD model 17AK9TKR099. Raw edge belt.
- 12 - 11849** **Blade Drive Belt.** Replaces Cub Cadet **754-0640 / 954-0640**. 1/2" (12.7 mm) x 79.24" (2012.69 mm) Fits 1500 series riding mowers, with 46" deck. Drive belt fits LT1000 series. Aramid, double cover.
- 12 - 11850** **Deck Drive Belt.** Replaces Cub Cadet **754-0641/954-0641**. 1/2" (12.7 mm) x 105" (2667 mm). Fits 1500 series lawn tractors with 38" deck. Aramid, double clutching cover.
- 12 - 11997** **Deck Drive Belt.** Replaces Cub Cadet **754-3055A**. 5/8" (15.875 mm) x 112-1/2" (2857.5 mm). Fits 38" & 42" decks on Cub Cadet 2000 series. Wrapped molded general purpose, polyester cord construction, double cover.

12 BELTS

BELTS



Belts for

CUB CADET (CONT.)

Order No.

Description

12 - 11820 **Deck Drive Belt.** Replaces Cub Cadet **754-3068**. 5/8" (15.875 mm) x 110.9" (2816.8 mm). Fits 44" deck, 2500 series models.

12 - 10783 **Deck Belt.** Replaces Cub Cadet **954-0644**. 1/2" (12.7 mm) x 60" (1524 mm). Fits 42" decks.. Wrapped molded, aramid cord construction.

12 - 10784 **Deck Belt.** Replaces Cub Cadet **954-0645**. 1/2" (12.7 mm) x 67" (1721.9 mm). Fits 42" decks.. Wrapped molded, aramid cord construction.

12 - 10781 **Spindle Drive Belt.** Replaces Cub Cadet **954-3036**. 1/2" (12.7 mm) x 63" (1600.2 mm). Fits model 190-331, 38" ,manual PTO mower decks.. Wrapped molded, aramid cord construction.

12 - 10563 **V Belt.** Replaces Cub Cadet **954-3038**. 1/2" (12.7 mm) x 60-1/2" (1536.7 mm). Fits 1000 series, 38"decks. Wrapped molded, aramid cord construction.

12 - 12051 **Blade Drive Belt.** Replaces Cub Cadet **954-3039**. 1/2" (12.7 mm) x 103" (2616.2 mm). Fits 2000 series with 46" deck & 2000 series with 48" deck. Aramid, double cover.

12 - 10782 **Deck Belt.** Replaces Cub Cadet **954-3073**. 1/2" (12.7 mm) x 62" (1574.8 mm). Fits 2000 series, model 190-142, 42" deck A62 spindle. Wrapped molded, aramid cord construction.

12 - 10901 **PTO Belt.** Replaces Cub Cadet **754-3084 / 954-3084**. 1/2" (12.7 mm) x 37-5/8" (955.7 mm). Fits 3000 series. **Matched set of 2 belts. Sold as set.** Aramid, double cover.

12 - 12850 **Transmission PTO Belt.** Replaces Cub Cadet **01007015**. 1/2" (12.7mm) x 51.2"(1300.5 mm). Fits models M48-M72. Aramid cord clutching cover, white.

12 - 12708 **Deck Belt.** Replaces Cub Cadet **02000154**. 1/2" (12.7 mm) x 83.4" (2118.36 mm). General purpose, aramid cord construction.

HUSQVARNA

12 - 13501 **Deck Belt.** Replaces Husqvarna **532-408381**. 1/2" (12.7 mm) x 96.4" (2448.56 mm). Fits 38" side discharge models LT19538, LTH2038. Wrapped molded HA x 96.4" Aramid cord construction, double cover, clutching-white color.

12 - 13499 **Deck Belt.** Replaces Husqvarna **532-429532**. 1/2" (12.7 mm) x 110" (2794 mm). Fits 38" rear discharge models CTH2038, CTH2238. Wrapped molded HAA x 110.0" Aramid cord construction, double cover, clutching-salt /pepper color.

12 - 14359 **Deck Belt.** Replaces Husqvarna **532-441597**. 1/2" (12.7 mm) x 72" (1828.8 mm). Fits 30" models PB30 & WELRVBA (532-44-15-97). Aramid cord, dry cover.

12

BELTS



Belts for

HUSQVARNA (CONT.)

Order No.

Description

- 12 - 12653** **Drive Belt.** Replaces Husqvarna **510-201201 & 106884**. 5/8" (15.875mm) x 159.08" (4040.6 mm). Fits 52" deck models. Raw edge, Aramid cord construction, laminated.
- 12 - 13477** **Pump Drive Rib Belt.** Replaces Husqvarna **539-102442**. 5/8" (15.87 mm) x 57-15/32" (1459.7 mm). Fits models ZTH5223A, ZTH5225A, ZTH6125A. "K" section, 5 ribs, Neoprene, Polyester cord construction.
- 12 - 13474** **Mule Drive Belt.** Replaces Husqvarna **539-102548**. 5/8" (15.87 mm) x 112-1/4" (2851 mm). Fits ZTH5223A, ZTH5225A, ZTH6125A. V-Belt. Aramid cord construction, laminated.
- 12 - 13475** **Blade Belt.** Replaces Husqvarna **539-102549**. 5/8" (15.87 mm) x 143-1/4" (3638.5 mm). Fits 61" Deck, model ZTH6125A. Aramid cord construction, double cover. clutching, color white.
- 12 - 13476** **Blade Belt.** Replaces Husqvarna **539-102903**. 5/8" (15.87 mm) x 123-21/64" (3132.5 mm). Fits 52" Deck, model ZTH5223A, ZTH5225A. Aramid cord construction, double cover. clutching, color white.
- 12 - 10834** **Deck Belt.** Replaces Husqvarna **539-107709**. 5/8" (15.8 mm) x 143-1/2" (3644.9 mm). Fits 48" model CZ 4817. Raw edge, laminated, aramid cord construction.
- 12 - 10835** **Transmission Belt.** Replaces Husqvarna **539-107710**. 1/2" (12.7 mm) x 64-1/4" (1657.4 mm). Fits 48" model CZ4817. Raw edge, laminated, aramid cord construction.
- 12 - 12686** **Drive Belt.** Replaces Husqvarna **539-110410**. 1/2" (12.7mm) x 105.1" (2669.5 mm). Aramid cord construction, double cover, semi-dry.
- 12 - 13442** **Deck Belt.** Replaces Husqvarna **574845601**. 5/8" (15.87 mm) x 126.85" (3221.4 mm). Fits model YTH2242 & YTH23V42LS, 42" fabricated deck. Wrapped-molded, aramid cord construction, double cover, clutching, white color.
- 12 - 13443** **Deck Belt.** Replaces Husqvarna **574845602**. 5/8" (15.87 mm) x 135" (3429 mm). Fits model YTH2648 & YTH24V48LS, 48" fabricated deck. Wrapped-molded, aramid cord construction, double cover, clutching, white color.
- 12 - 13444** **Deck Belt.** Replaces Husqvarna **574845603**. 5/8" (15.87 mm) x 143-1/2" (3645 mm). Fits model GTH27V52LS, 52" fabricated deck. Wrapped-molded, aramid cord construction, double cover, clutching, white color.

12

BELTS

BELTS



Belts for



JOHN DEERE

Order No.

Description

- 12 - 10485** **V Belt.** Replaces John Deere **GC00073**. 3/8" (9.53 mm) x 39-1/16"(992.2 mm). Fits walkbehind mower models JS60, JS61, JS63, JS63C, JS63E. Also fits Sabre mower model M21 & Scotts mower model SP6211. Raw edge polyester cord construction, laminated.
- 12 - 10486** **V Belt.** Replaces John Deere **GC00081**. 3/8" (9.53 mm) x 34-3/4"(882.7 mm). Fits walkbehind mower models JS63, Also fits Sabre mower model M23 & Scotts mower model SP6213. Raw edge polyester cord construction, laminated.
- 12 - 10630** **V Belt.** Replaces John Deere **GX10176**. 1/2" (12.7 mm) x 143-5/16" (3640.1 mm). Fits model S2046, 46" cut Scotts. Wrapped molded, aramid cord construction, clutching cover.
- 12 - 10434** **Drive Belt.** Replaces John Deere **GX20006**. 17/32" (13.5 mm) x 88-5/8" (2251.1 mm). Fits models 1542G, 15.542G, 1743GS, 17.542HS. Wrapped fiberglass cord construction.
- 12 - 10436** **Deck Belt.** Replaces John Deere **GX20072, GY20570**. 1/2" (12.7 mm) x 103-3/4" (2635.3 mm). Fits model 14.542GS. Wrapped polyester cord construction.
- 12 - 10435** **Drive Belt.** Replaces John Deere **GX20241**. 17/32" (13.5 mm) x 91-13/16" (2332 mm). Fits model L-100 14.542GS. Wrapped polyester cord construction.
- 12 - 10437** **Drive Belt.** Replaces John Deere **GX20305, GY20571**. 17/32" (13.5 mm) x 138-7/8" (3527.4 mm). Fits model L2048. Wrapped fiberglass cord construction.
- 12 - 14243** **V Belt.** Replaces John Deere **GX21395**. 5/8" (15.87 mm) x 161.41" (4099.8 mm). Fits 54" deck models LA150, LA175, G110 & 190C. Wrapped molded, aramid cord construction, double cover, clutching, brown.
- 12 - 12461** **PTO Drive Belt.** Replaces John Deere **GX21833**. 1/2" (12.7mm) x 141.1" (3562.35 mm). Fits models 145 & 155C. Aramid cord construction, double cover.
- 12 - 11811** **Drive Belt.** Replaces John Deere **GX22819**. 3/8" (9.5 mm) x 37-3/4" (958.85 mm). Fits 21" JD25-45 series & Snapper Easy Line series self propelled mowers. Also replaces Snapper 7100058. Wrapped molded, general purpose, aramid cord construction, double cover.
- 12 - 10750** **Drive Belt.** Replaces John Deere **M74747**. 1/2" (12.7 mm) x 105" (2667 mm). Fits model STX38. Wrapped molded, aramid cord construction, clutching cover.
- 12 - 10388** **Primary Belt.** Replaces John Deere **M110312/GY20572**. 9/16" (14.3 mm) x 64-1/4"(1332 mm). Fits models 1842GV, 1848GV, 1948GV. Raw edge polyester cord construction, laminated.
- 12 - 12077** **Secondary Deck Belt.** Replaces John Deere **M110313**. 5/8" (15.875 mm) x 111-3/8" (2828.9 mm). Fits 48" deck, LX & GT series models. Wrapped molded, general purpose, aramid cord construction, double cover. Also fits SCOTTS model S2048.

12

BELTS



Belts for



JOHN DEERE (Cont.)

Order No.

Description

- 12 - 10751** **Drive Belt.** Replaces John Deere **M110978**. 1/2" (12.7 mm) x 102" (2590.8 mm). Fits models LX176, LX178, LX186 & LX188. Wrapped molded, aramid cord construction, clutching cover.
- 12 - 14390** **Double V- Belt.** Replaces John Deere **M111534**. 5/8" (15.87 mm) x 128-3/4" (3270.25 mm). Fits F110, F225, F735, 54" deck Homeowner Zero turn mowers. Aramid cord construction, laminated.
- 12 - 13217** **V Belt.** Replaces John Deere **M1118685**. 5/8" (15.875mm) x 120" (3048 mm). Fits Sabre Lawn Tractors: 2254HV, 2354HV, 2554HV all 54" deck only. Scotts Lawn Tractors: GT2554, S2554 all with 54" deck only. John Deere Lawn Tractors: 325, 335, 345, 355D, G100, GT225, GT235, GT235E, GT245, GX325, GX335, GX345, GX355, LX255, LX266. Aramid cord construction, double cover, clutching, white.
- 12 - 12678** **Drive Belt.** Replaces John Deere **M124895**. 1/2" (12.7mm) x 115-1/4" (2927.35 mm). Aramid cord construction, double cover, wrapped, clutching-white.
- 12 - 10749** **Deck Belt.** Replaces John Deere **M125218, GX10065, GX10851**. 9/16" (14.29 mm) x 96-1/2" (2451.10 mm). Fits 38" black mower deck on model STX38 lawn tractor. Serial number 210001 & higher. Raw edge aramid cord construction.
- 12 - 12898** **Drive Belt.** Replaces John Deere **M126009**, . 1/2" (12.7mm) x 86.39" (2194.3 mm). Aramid clutching cover, white.
- 12 - 12373** **DeckDrive Belt.** Replaces John Deere **M126536**. 1/2" (12.7 mm) x 114-1/2" (2908.3 mm). Fits LT133, LT155, LT166 series 38" models. Wrapped molded, general purpose, aramid cord construction, double cover.
- 12 - 12078** **Primary Deck Belt.** Replaces John Deere **M143019 & M144677**. 5/8" (15.875 mm) x 63-3/8" (1609.7 mm). Fits models LX255, LX277, LX279, LX288, LX277AWS, LX280, LX289 all using 42C 48" and 52" decks. Also fits GT242, GT262, GT275 with 48" decks. Also fits GT225, GT235, GT255, GX255, 325, 335, 345. Raw edge double cog, polyester cord construction.
- 12 - 13035** **Traction Drive V-Belt.** Replaces John Deere **M144044**. 1/2" (12.7 mm) x 91-7/8" (2333.6mm). Fits LT150-LT190 & X300-X320 riders. Wrapped molded, polyester cord construction, double cover.
- 12 - 13036** **Traction Drive V-Belt.** Replaces John Deere **M144570**. 1/2" (12.7 mm) x 97" (2463.8mm). Fits LT150. Wrapped molded, Aramid cord construction, double cover, clutching, color white.
- 12 - 13157** **Hydro Drive Belt.** Replaces John Deere **M154157**. 1/2" (12.7 mm) x 42-1/4" (1073.1mm). Fits EZ-Trak model Z425, Z445, Z465. Wrapped molded Polyester cord construction, double cover.

12 BELTS

BELTS



Belts for



JOHN DEERE (Cont.)

Order No. Description

- 12 - 12559** Deck Belt. Replaces John Deere **M154601**. 1/2" (12.7mm) x 143.5" (3594 mm). Fits 38" mower deck belt. Aramid cord construction, double cover.
- 12 - 12560** Deck Belt. Replaces John Deere **M154621**. 1/2" (12.7mm) x 146" (3663.9 mm). Fits 42" mower deck belt. Aramid cord construction, double cover.
- 12 - 13158** Deck V-Belt. Replaces John Deere **M158131, M154296**. 1/2" (12.7 mm) x 152-1/4" (3867.1mm). Fits EZ-Trak model Z425, Z445, Z465. Raw edge Aramid cord construction.
- 12 - 12759** PTO Engine to Deck Belt. Replaces John Deere **TCU13195**. 5/8" (15.875mm) x 117" (2971.8 mm). Fits Z-Trak 737, 757, & 797, 60" & 72" decks. Aramid cord construction, double cover.
- 12 - 12814** PTO Engine to Deck V-Belt. Replaces John Deere **TCU13196**. 5/8" (15.8 mm) x 131-1/2" (3340.1mm). Fits Z-Trak 737, 757, 797, 54" decks. Wrapped molded, aramid cord construction, double cover, friction.
- 12 - 12760** Deck Belt. Replaces John Deere **TCU13198**. 5/8" (15.875mm) x 141.73" (3600 mm). Fits Z-Trak 737, 757, & 797, 60" decks. Aramid cord construction, double cover.
- 12 - 14237** Pump Drive Belt. Replaces John Deere **TCU16026**. 7/8" (22.22 mm) x 31.5" (800.1 mm). Fits models 737, 757, 777 and 797, Z-Trak. 6 rib, "K" section Aramid cord, Fabric back.

MAX-TORQUE

- 12 - 9346** Torque Converter Belt. Replaces Max Torque **MXT97**. Used on several Go Karts that have a Max-Torque LTD torque converter. 11/16" (17.46 mm) x 29-1/16" (738.18 mm).
- 12 - 9792** Torque Converter Belt. Replaces Max Torque **MXT98**. Used on several Go Karts that have a Max-Torque LTD torque converter. 11/16" (17.46 mm) x 29-3/8" (746.12 mm).

MCLANE

- 12 - 8761** Engine Belt. Replaces McLane **1060**. 1/2" (12.70 mm) x 19.5" length (494.92mm). Fits 1991-present, front throw reel mowers. Covered.
- 12 - 8780** Drive Belt. Replaces McLane **7102**. 1/2" (12.70 mm) x 24.5" length (622.3 mm). Fits 21" self propelled rotary mower. Polyester cord construction. Covered.



Belts for



MTD

Order No.

Description

- 12 - 10089** **Snowthrower Belt.** Replaces MTD **754-0101A & 954-0101A.** 1/2" (12.7 mm) x 35" (889 mm). Fits snowthrower model 721. *Aramid fiber.
- 12 - 6906** **Variable Speed Belt.** Replaces MTD **754-0241A.** 5/8" section belt (15.88 mm), 35-1/4" length (895.35 mm). Covered.
- 12 - 7169** **Blade Belt.** Replaces MTD **754-0264.** 1/2" (12.70mm) x 52.18" (1325.56 mm). Fits 30" cut rear engine rider models 139-501 thru 508 and 139-511 thru 514. Covered.
- 12 - 6838** **Engine/Transmission Belt.** Replaces MTD **754-0266.** "A" section belt, 85.2" length (2164.08 mm). Fits 4 speed transaxle engines to transmission. Covered.
- 12 - 6839** **Engine/Variable Speed Belt.** Replaces MTD **754-0280.** 5/8" section belt (15.88 mm), 53" length (1346.20 mm). Fits 600 series variable speed unit engines. Also fits 38", 40" & 42" older units. Covered.
- 12 - 6840** **Variable Speed Belt.** Replaces MTD **754-0281.** 5/8" section belt (15.88 mm), 44-7/32" length (1123.16 mm). Fits 600 series variable speed unit to rear end. Also fits 38", 40" & 42" older units. Covered.
- 12 - 6841** **Blade to Blade Belt.** Replaces MTD **754-0293.** 1/2" section belt (12.70 mm), 74" length (1879.60 mm). Fits 44" cut, side discharge, 935 series decks. Covered.
- 12 - 6950** **Drive Belt.** Replaces MTD **754-0346,** 30" (761.42 mm). Fits 462R & 479R series self-propelled mowers. Covered.
- 12 - 6843** **Deck Drive Belt.** Replaces MTD **754-0349.** "A" section belt, 79-3/32" length (2008.98 mm). Fits 820 thru 849 series tractors with 46" cut side discharge "H" decks. Covered.
- 12 - 6844** **Engine to Deck Belt.** Replaces MTD **754-0350.** "B" section belt, 64" length (1625.60 mm). Fits 46" cut lawn tractors 800 series. *Aramid fiber. Covered.
- 12 - 9570** **Transmission Drive Belt.** Replaces MTD **754-0358.** .930" (23.62 mm) x 54.625" (1387 mm). Fits 800 series 2-speed garden tractors, 1996 & prior. General purpose. *Aramid fiber. Clutching cover. Covered.
- 12 - 13288** **Snow Blower Drive Belt.** Replaces MTD **754-0367, 954-0367.** 3/8" (9.5 mm) x 34.4" (873.7mm). Neoprene, aramid cord construction, single clutching cover salt-pepper color.
- 12 - 13567** **Snow Blower Auger V-Belt.** Replaces MTD **754-04014.** 3/8" (9.5 mm) x 27" (685.8mm). Fits 300 series compact two-stage snow blowers 2004-up. Raw edge, cogged.
- 12 - 13232** **V-Belt.** Replaces MTD **754-04032.** 3/8" (9.52 mm) x 35-5/8" (904.8mm). Fits MTD models 400, 500, 550 series self propelled walkbehind, 1998 and older, also fits 550 series edgers. Neoprene, polyester cord construction single cover, clutching white.
- 12 - 12667** **Deck Drive Belt.** Replaces MTD **754-04048 / 954-04048.** 5/8" (15.875mm) x 131.1" (3329.9 mm). Fits models LT1024, 50" decks. Aramid cord construction, double cover.

12 BELTS

BELTS



**Belts for
MTD (Cont.)**

Order No.

Description

12 - 12610

PTO Belt. Replaces MTD **754-04041 / 954-04041**. 5/8" (15.875mm) x 111.2" (2824.48 mm). Fits models L 1046, LT1045 & LT1046. Aramid cord construction, double cover.

12 - 14118



Snowthrower Belt. Replaces MTD **754-04050 / 954-04050**. 1/2" (12.7 mm) x 35"(889 mm). Fits two stage snow thrower, 2005 -newer. Raw edge, cogged, aramid cord construction.

12 - 11848

PTO to Spindle Belt. Replaces MTD **754-04122**. 1/2" (12.7 mm) x 90-1/4" (2292.4 mm). Fits 46" deck models. Also replaces Cub Cadet, Troybilt, Bolens Yard Machines, Husky, Yardman.

12 - 12489

Deck Belt. Replaces MTD **754-04142 / 954-04142**. 1/2" (12.7mm) x 91.4" (2321.6 mm). Fits 46" decks, Step-Thru frame lawn tractors. Aramid cord construction, double cover.

12 - 12770

V-Belt. Replaces MTD **754-04207**. 1/2" (12.5 mm) x 79.3" (2014.2mm). Fits MTD models LTX Drive Belt. Polyester cord construction.

12 - 12790

V-Belt. Replaces MTD **754-04219**. 1/2" (12.5 mm) x 103.24" (2622.5mm). Fits MTD models LTX 46" Deck Belt. Polyester cord construction.

12 - 12791

V-Belt. Replaces MTD **754-04240 & 954-04240**. 1/2" (12.5 mm) x 162.9" (4137.6mm). Fits MTD models LTX 52" decks. Polyester cord construction.

12 - 13301

V-Belt. Replaces MTD **754-04252**. 1/2" (12.5 mm) x 84.17" (2137.6mm). Fits MTD models LTX 52" decks. Polyester cord construction.

12 - 9119

Deck Belt. Replaces MTD **754-0439**. 5/8" (15.875 mm) x 60" (1524.0 mm) Fits 600 series tractors. Wrap molded. *Aramid fiber. Clutching cover.

12 - 9120

Deck Belt. Replaces MTD **754-0440**. 1/2" (12.7 mm) x 99" (2514.60 mm) Fits 600 series tractors. Wrap molded, general purpose, polyester cord construction. Covered.

12 - 9847

V-Belt. Replaces MTD **754-0441**. 1/2" (12.7 mm) x 76" (1930.4 mm). General purpose, polyester cord construction.

12 - 9581

Deck Belt. Replaces MTD **754-0443A**. HAA Hex Profile x 89.9" (2283 mm) Fits European rear discharge mowers. 2 Ply cover, double V, *Aramid fiber.

12 - 9932

Drive Belt. Replaces MTD **754-0446**. 5/8" (15.88 mm) x 45" (1143 mm) Fits 800 series 2 speed garden tractors 1997 and after. General purpose, polyester cord construction.

12 - 9935

Deck Belt . Replaces MTD **754-0472**. 5/8" (15.88 mm) x 83" (2108.20 mm). Fits auto drive, step through frame 42" lawn and garden tractors 1999 & after. General purpose, polyester cord construction.

12

BELTS



Belts for



MTD (Cont.)

Order No.	Description
12 - 10009	PTO Belt. Replaces MTD 754-0485 & 954-0485 . 5/8" (15.88 mm) x 97" (2463 mm). Fits 42" deck with manual PTO, for 2000 and later units. *Aramid fiber.
12 - 9900	Deck Belt. Replaces MTD 954-0197 . 1/2" (12.7 mm) x 117" (2971.8 mm). Fits 50" deck 990 series garden tractors. General purpose, polyester cord construction.
12 - 6907	Belt. Replaces MTD 954-0240 , 754-0240 . 5/8" section belt (15.88 mm), 38-3/16" length (969.96 mm). *Aramid fiber. Covered.
12 - 9901	Engine Pulley to Drive Pulley Belt. Replaces MTD 954-0271 . 3/8" (9.53 mm) x 39" (990.6 mm). Fits front wheel drive self-propelled rear discharge mowers. General purpose, polyester cord construction.
12 - 6949	Blade to Blade Belt. Replaces MTD 954-0355 , 754-0355 . 1/2" (12.70 mm) x 67" (1701.80 mm). Fits 32" cut "D" decks. Covered.
12 - 9482	Variable Speed To Transmission Belt. Replaces MTD 954-0362 . 7/8" (22.22 mm) x 50" (1270 mm). Fits models 820 - 849. Wrap molded, *Aramid fiber, clutching cover. Covered.
12 - 6908	Variable Speed Belt. Replaces MTD 954-0370 , 754-0370 . 5/8" (15.87 mm), 48" length (1219.20 mm), 600 series. Fits 42" cut mowers. *Aramid fiber. Covered.
12 - 6845	Blade to Blade Belt. Replaces MTD 954-0371A , 754-0371A . "5/8" section belt, 74" length (1879.60 mm). *Aramid fiber. Fits Riders with 42" cut side discharge "G" decks. Covered.
12 - 10831	Variable Speed Belt. Replaces MTD 954-04001 . 5/8" (15.8 mm) x 69-3/16" (1757.36 mm). Raw edge, laminated, polyester cord construction.
12 - 10833	Variable Speed Belt. Replaces MTD 954-04002 . 5/8" (15.875 mm) x 31-3/4" (806.5 mm). Fits models 660 thru 688. For 2001 and up.
12 - 12382	Drive Belt. Replaces MTD 954-04043 . 1/2" (12.7 mm) x 57.7" (1465.6 mm). Raw edge. Laminated, Aramid cord construction.
12 - 13653	Transmission V-Belt. Replaces MTD 954-04082A . 3/8" (9.5 mm) x 31.68" (804.9mm). Transmission belt for self propelled walkbehind mower, front wheel drive, 2008 and after. 12AG & 12AV series. Polyester cord construction, wrapped molded, single cover.
12 - 14215	V-Belt. Replaces MTD 954-04265 . 5/8" (15.87 mm) x 33.8" (858.52 mm). Fits 2010 - up Craftsman, Tractor Supply Huskee, Walmart Yard Man. Wrapped-molded, polyester cord construction, single cover, clutching brown.
12 - 12429	Drive Belt. Replaces MTD 954-0430/754-0430 . 3/8" (9.5 mm) x 35" (889 mm). Fits Snow Thrower models from 1992-2002. Raw edge. Laminated, Aramid cord construction. Sold in Matching Pairs.

12 BELTS

BELTS



MTD (Cont.)

Order No.

Description

12 - 6842

Blade to Blade Belt. Replaces MTD **954-0433, 754-0433.**
"B" section belt, 69-9/32" length (1759.74 mm). Fits 600 series lawn tractors with 38" side discharge, 805 series decks. Covered.

12 - 9480

V-Belt. Replaces MTD **954-0453.** 5/8" (15.88 mm) x 36-1/4" (920.75 mm).
General purpose, polyester cord construction. Covered.

12 - 11660

Deck Drive Belt. Replaces MTD **954-04060B.** 1/2" (12.7 mm) x 96-1/2" (2451 mm). Fits 42" 2005 and newer LT-5 design frames. Wrapped Molded general purpose, aramid cord construction, double clutching cover.

12 - 11132

V Belt. Replaces MTD **954-0460.** 3/8" (9.53 mm) x 39-1/4" (996.95 mm)
Fits rear wheel drive, rear discharge mowers 1997 & after. Models 959C, 979C, E979E & 999C.

12 - 9903

Transmission to Engine Belt . Replaces MTD **954-0461.** 1/2" (12.7 mm) x 78-1/2" (1993.9 mm). Fits 800 series hydrostatic garden tractors 1997 and after. General purpose, polyester cord construction.

12 - 11482

Primary Drive Belt. Replaces MTD **954-0467.** 5/8" (15.875 mm) x 90-1/2" (2324.1 mm). Fits auto drive step thru frame Lawn & Garden Tractors 1999 and newer.

12 - 11483

Secondary Drive Belt. Replaces MTD **954-0468.** 5/8" (15.875 mm) x 41-1/2" (1054.1 mm). Fits auto drive step thru frame Lawn & Garden Tractors.

12 - 10261

Deck Drive Belt. Replaces MTD **954-0474.** 5/8" (15.88 mm) x 100.20" (2545 mm). Fits auto drive step through Garden Tractors with 46" decks (1999 & older). *Aramid fiber, wrap molded, clutching cover.

12 - 10260

Engine to Deck Belt. Replaces MTD **954-0476.** 5/8" (15.88 mm) x 101.20" (2570 mm). Fits auto drive step through Garden Tractors with 46" decks with Electric PTO. *Aramid fiber.

12 - 11135

Drive Belt. Replaces MTD **954-0483.** 3/8" (9.53 mm) x 38.16" (965.2 mm)
Fits self propelled front wheel drive models 263, 264, 525, 528 & 529 mowers 2000 & after.

12 - 10100

Engine to Deck Belt. Replaces MTD **954-0486A.** 5/8" (15.88 mm) x 67" (1701.8 mm)
Fits auto drive, step through frame 46" lawn and garden tractors 1999 & after with manual PTO. General purpose, polyester cord construction.

12 - 11019

Engine to Deck Belt. Replaces MTD **954-0497.** 1/2" (12.7 mm) x 60.06" (1525.5 mm). Fits auto step through tractors 1999 and newer. Wrapped aramid cord clutching cover.

12

BELTS



**Belts for
MTD (Cont.)
Order No.**

Description

- 12 - 10369** **Deck Belt.** Replaces MTD **954-0498**. 1/2" (12.7 mm) x 67" (1701.8 mm). Fits 42" step thru frame 2001 and after. Also fits Troy Bilt. Wrapped molded, general purpose, aramid cord construction, clutching cover.
- 12 - 11137** **Drive Belt.** Replaces MTD **954-0637A** . 3/8" (9.53 mm) x 31-1/4" (793.75 mm) Fits self propelled walk behind mowers.
- 12 - 11661** **Deck Drive Belt.** Replaces MTD **954-0642**. 5/8" (15.875 mm) x137.9" (3502.6 mm). Fits 54" auto drive model with electric PTO. Wrapped Molded general purpose, aramid cord construction, double clutching cover.
- 12 - 13551** **Drive Belt.** Replaces MTD **01000151**. 1/2" (12.5 mm) x 51-3/4" (1314.5mm). Wheel drive belt for MTD Pro G1336, 36" walk behind, Craftsman Model 247.889360. Cogged, Aramid cord construction.

MURRAY

- 12 - 11017** **Deck Belt.** Replaces Murray **321205**. 5/8" (15.88 mm) x 97.23" (2469.6mm) Raw edge, laminated, aramid cord construction.
- 12 - 675** **Deck Belt.** Replaces Murray **1001223**. AA x 73" length (1854.20 mm), 6 sided. Oil and heat resistant. Double V.
- 12 - 14120**  **Snowthrower Belt.** Replaces Murray **585416MA**. 1/2" (12.7 mm) x 38-3/8" (965.2 mm). Fits Craftsman & Murray dual stage snow throwers & Snow Blizzard. Raw edge, Aramid cord.
- 12 - 6876** **Blade Belt.** Replaces Murray **37 x 12**. Fits 30" rear engine rider 8 hp. Also fits 36" cut front engine riders 8, 10 and 11 hp. "A" section belt, 54.937" length (1395.40 mm). Covered.
- 12 - 6903** **Blade Cross Drive Belt.** Replaces Murray **37 x 22**. "A" section belt, 99" length (2514.60 mm). Fits 42" cut 11, 14, 16 and 18 hp engines. Covered.
- 12 - 6502** **Drive Belt.** Replaces Murray **37 x 26**, 88.3" length (2242.82 mm) . Fits 39", 40" and 42" decks. *Aramid fiber, with bare back cover. Covered.
- 12 - 6503** **Transmission Belt.** Replaces Murray **37 x 38**, 40.3" length (1023.62 mm) . Fits 25" & 30" decks. Glass cord construction with bare back cover. Covered.
- 12 - 6504** **Blade Belt.** Replaces Murray **37 x 40**, 62.1" length (1577.34 mm) . Fits 39", 40" and 42" cut. *Aramid fiber, with bare back cover. Covered.
- 12 - 4998** **Blade Belt.** Replaces Murray **37 x 43**, 1/2" (12.70 mm) x 82.1 length (2085.34 mm). Fits 36" deck with rear and side discharge. Covered.
- 12 - 6505** **Drive Belt.** Replaces Murray **37x45, 37x33, 37x35**; 90.5" length (2298.70 mm). Fits 39", 40" and 42" cut. Dacron cord construction with bare back cover.

12 BELTS

BELTS



**Belts for
MURRAY
Order No.**

Description

- 12 - 6507** **Blade Belt.** Replaces Murray **37 x 57**, 53.68" length (1363.47 mm) . Fits 30" cut. *Aramid fiber, with bare back cover. Covered.
- 12 - 6508** **Motion Drive Belt.** Replaces Murray **37 x 61**, 95" length (2413 mm).Fits 39", 40" and 42" cut. *Aramid fiber, with bare back cover. Covered.
- 12 - 6904** **Blade Belt.** Replaces Murray **37 x 62**. "A" section belt, 85.94" length (2182.88 mm). Fits 39", 40" and 42" cut. Covered.
- 12 - 6509** **Blade Belt.** Replaces Murray **37 x 63**, 83.1" length (2110.74 mm). Fits 38" cut, 12 hp. Glass cord construction with bare back cover. Covered.
- 12 - 8747** **Motion Drive Belt.** Replaces Murray **37 x 64**. 1/4" (6.35 mm) x 36.78" (934.21 mm). Fits Aerovac 21", 5-5.5 hp walk behind. V-belt, raw edge. *Aramid fiber.
- 12 - 7245** **Drive Belt.** Replaces Murray **37 x 65**. 1/2" (12.70 mm) x 30-3/16" length (766.76 mm). Motor to transaxle belt. Fits 25" and 30" rear engine rider with transaxle. Models 25515B and 305351B. Covered.
- 12 - 8444** **Blade to Blade Belt.** Replaces Murray **37 x 66** . 1/2" (12.70 mm) x 47.1" length (1196.34 mm) V belt. Fits Murray & Ultra Lawn Tractors 18 hp, 46300 series, 46" cut models. Covered.
- 12 - 8442** **Motion Drive Belt.** Replaces Murray **37 x 68** . 1/2" (12.70 mm) x 101.68" length (2582.67 mm) V belt. Fits Murray & Ultra Lawn Tractors 18 hp, 46300 series, 46" cut models. Covered.
- 12 - 8443** **Engine to Deck Belt.** Replaces Murray **37 x 69** . 1/2" (12.70 mm) x 80.3" length (2039.62 mm). Fits Murray & Ultra Lawn Tractors 18 hp, 46300 series, 46" cut models. Covered.
- 12 - 7672** **Blade Belt.** Replaces Murray **37 x 70**. 77-11/16" length (1973.26 mm) x 1/2" (12.70 mm). Fits 46" cut 14-18 hp, 1990-1994 models. Covered.
- 12 - 7673** **Blade Belt.** Replaces Murray **37 x 75**. 90-5/8" length (2301.88 mm) x 1/2" (12.70 mm). Fits 42" cut 12-18 hp, 1990-1994 models. Covered.
- 12 - 9994** **Deck Belt.** Replaces Murray **37x80**. 1/2" (12.7 mm) x 86-1/4" (2191 mm) Fits 40", 42" & 43" deck lawn tractors. Polyester cord construction.
- 12 - 9481** **Motion Drive Belt.** Replaces Murray **37 x 83**. 1/2" (12.7 mm) x 81-3/4" (2076.45 mm). Fits Murray riders. General purpose, polyester cord construction. Covered.
- 12 - 9712** **V-Belt.** Replaces Murray **37 x 86**. 1/2" (12.7 mm) x 84" (2133.6 mm). Fits 38" Murray riders. Polyester cord construction. Covered.
- 12 - 9995** **Drive Belt.** Replaces Murray **37 x 87MA**. 1/2" (12.7 mm) x 97" (2464 mm) Fits 38" deck lawn tractors. Polyester cord construction.
- 12 - 8972** **V-Belt.** Replaces Murray **37 x 88**. 88.24" (2241.3 mm) length x 1/2" (12.7 mm). Fits 42" Hydro tractor. *Aramid fiber, wrapped belt.



Belts for MURRAY (Cont.)

Order No.	Description
12 - 9313	Primary Belt. Replaces Murray 37 x 89 . 1/2" (12.7 mm) x 87" (2209.8 mm) Fits 46" cut mowers. *Aramid fiber, wrapped belt. Covered.
12 - 9713	Secondary Blade Drive Belt. Replaces Murray 37 x 92 . 1/2" (12.7 mm) x 52" (1320.8 mm). Fits 50" Murray riders. Polyester cord construction. Covered.
12 - 9714	Primary Blade Drive Belt. Replaces Murray 37 x 93 . 5/8" (15.8 mm) x 109" (2768.6 mm). Fits 52" Murray riders. *Aramid fiber. Covered.
12 - 9715	Primary Blade Drive Belt. Replaces Murray 37 x 96 . 1/2" (12.7 mm) x 88-1/4" (2241.55 mm). Fits 46" Murray riders. *Aramid fiber. Covered.
12 - 10042	Drive Belt. Replaces Murray 37x98 . 3/4" (19.05 mm) x 35.37" (898 mm). Fits Murray Go-Carts. *Aramid fiber.
12 - 10910	Motion Drive Belt. Replaces Murray 37 x 106 . 1/2" (12.7mm) x 89" (2260.6mm). Fits 38", 40", 42" & 46" decks with Hydro transmission. 2000 and after. 1 ply polyester cord construction.
12 - 10832	Motion Drive Belt. Replaces Murray 37x110 . 1/2" (12.7 mm) x 43-7/8" (1114.4 mm). Fits 30" rear engine rider model 309304X8A. Wrapped, polyester cord construction.
12 - 10911	Blade Drive Belt. Replaces Murray 37x111 . 7/16" (11.11 mm) x 45" (1143 mm). Covered, general purpose polyester cord construction.
12 - 10912	Drive Belt. Replaces Murray 37x112 . 11/16" (17.5 mm) x 66" (1676.4 mm) Fits 42" & 46" decks. Wrapped belt, 2 ply polyester cord construction.
12 - 10913	Secondary Drive Belt. Replaces Murray 37x113 . 25/32" (19.8 mm) x 44-25/32" (1137.4 mm). Wrapped, polyester cord construction.
12 - 11029	Primary Drive Belt. Replaces Murray 37x114 . 25/32" (19.8 mm) x 29-11/32" (745.3 mm). Wrapped, polyester cord construction.
12 - 11030	Secondary Drive Belt. Replaces Murray 37x115 . 25/32" (19.8 mm) x 34" (863.6 mm). Wrapped, polyester cord construction.
12 - 12462	Torque Converter Belt. Replaces Murray 37x125 . 11/16" (17.5 mm) x 34.57" (878 mm) Torque converter belt for Go-Karts. Aramid cord construction.
12 - 13541	Trans Drive V-Belt. Replaces Murray 7035500YP . 1/2" (12.7 mm) x 85-3/8" (2168.5mm). Trans drive belt, dual spindle brake. Fits 7800000 model series riders. Double cover, Aramid cord construction.

12 BELTS

BELTS



**Belts for
NOMA (AMF / DYNAMARK)**

Order No.	Description
12 - 6970	Cutter Deck Belt. Replaces Noma 48044 . 5/8" section belt (15.88 mm), 82" length (2082.80 mm). *Aramid fiber. Raw Edge.
12 - 6896	Belt. Replaces Noma 54758 . 1/2" section belt (12.70 mm),
12 - 7128	Deck Drive Belt. Replaces Noma 300680 . 5/8" section (15.88 mm), 77-3/4" length (1974.85 mm). Fits Noma Eagle Star. Raw Edge.
12 - 6872	Cutter Deck Belt. Replaces Noma 302289 . 5/8" section belt (15.88 mm), 73.75" length (1873.25 mm). Raw Edge.
12 - 6898	Belt. Replaces Noma 303241 . 1/2" (12.70 mm) x 90" length (2286.00 mm). Covered.
12 - 6871	Cutter Deck Belt. Replaces Noma 308701 . 5/8" section belt (15.88 mm), 80" length (2032 mm). Raw Edge.

12

BELTS

POULAN

12 - 12399	Deck Belt. Replaces Poulan 539-109243 . 5/8" (15.87 mm) x 135.5" (3441.7 mm). Fits 48" Decks, General Purpose, Aramid cord construction, double cover, clutching.
12400]	Deck Belt. Replaces Poulan 539-110411 . 1/2" (12.7 mm) x 56" (1422.4 mm). Laminated, Aramid cord construction.
12 - 12401	Deck Belt. Replaces Poulan 539-110832 . 5/8" (15.87 mm) x 145" (3683 mm). Fits models Husqvarna EZ4819 48", Z5426 54" decks, Poulan Pro ZTR, IZ4217 42". Laminated, Aramid cord construction.

POWER TRIM

12 - 4999	Belt. Replaces Power Trim 339 . 27-1/2" length (698.50 mm). Covered.
------------------	--

SEARS/ROPER (See AYP)

SIMPLICITY

12 - 6874	Drive Belt. Replaces Simplicity 1703466/1665638 . "A" section belt, 126.14" length (3203.96 mm). Covered.
------------------	---

SNAPPER (also see commercial belts)



12 - 673	Belt. Replaces AA68 Snapper 7010749 . For 25", 26", 28" and 30" cut mowers 1991 & older. 68" length (1727.20 mm), 6 sided. Oil and heat resistant. Double V.
12 - 669	Belt. Replaces Snapper 7012508 and 7011887 . Used on V-21's. Section 3/8" (9.53 mm) 24-1/2" length (622.30 mm). For 3-1/2 - 4 hp mowers. Raw Edge.
12 - 670	Belt. Replaces Snapper 7012353 . Fits 5 hp commercial. Cogged.
12 - 869	Belt. Replaces Snapper 7012354 . Transmission Belt. Poly grooved belt. Multi Ribbed. 22-3/8 (568.32 mm) length
12 - 870	Belt. Replaces Snapper 7014525 (For 48" Deck 1992 & older). AA-105. Double V.
12 - 7129	Blade Belt. Replaces Snapper 7014799 . 103-3/32" length (2618.58 mm). Fits series 1 & 2, models LT11, LT16, YT12D, YT18H, GT180H. Covered.



Belts for SNAPPER (also see commercial belts)

Order No.	Description
12 - 8075	Deck Belt. Replaces Snapper 7014800 . 1/2" section belt (12.70 mm), 139" length (3530.60 mm). Fits series 1 & 2, models LT, YT, YT12D, YT16D, YT18H, GT180H. Covered.
12 - 675	Belt. Replaces AA73 Snapper 7022252, 7018236 . For 25", 26", 28", 30" & 33" cut decks 1991 & newer. 73" length (1854.20 mm), 6 sided. Oil and heat resistant. Double V.
12 - 7838	Engine to Blade Belt. Replaces Snapper 7022252 . AA section belt, 73" length (1854.20 mm), fits 26" thru 33" cut models 7-9 series, Snapper rear engine riders. *Aramid fiber. Double V.
12 - 9483	Blade Drive Belt. Replaces Snapper 7043844 . "AA" x 73-3/4" (1390.65 mm). Fits 28", 30" & 33" cut rear engine riders, series 16. General purpose, *Aramid fiber. Clutching cover. Double V.

TORO/WHEEL HORSE (also see commercial belts)

12 - 7171	Engine to Deck Belt. Replaces Toro/Wheel Horse 102742 . 1/2" (12.7 mm) x 103" length (2616.20 mm), Polyester cord construction. Fits 42" and 48" cut side discharge. Rear engine riders. (older Wheel Horse models.) Covered.
12 - 7952	Snowblower Belt. Replaces Toro 25-6430 . 3/32" section belt (2.38 mm), 33" length (838.20 mm), poly "V" belt, fits Snowmaster S200, & S620. Multi Ribbed.
12 - 8887	Blade Brake Belt. Replaces Toro 42-0884 . 1/2" section belt (12.7 mm), 23.92" length (607.57 mm). Fits Toro Homeowner models 20624, 20684, 20695. Raw edge, cogged. *Aramid fiber. Cogged.
12 - 5820	Transmission Belt. Replaces Toro 47-1410 . "A" Section Belt, 47-1/2" length (1206.50 mm). For 32" rear engine rider. Covered.
12 - 5821	Deck Belt. Replaces Toro 47-1420 . "A" section belt, 65.54" length (1664.72 mm). For 32" rear engine rider. Covered.
12 - 9861	Snowthrower Belt. Replaces Toro 55-9300 . 9/16" (14.3 mm) x 34" (863.6 mm). Fits model CCR2000. Poly -ribbed belt.
12 - 10090	Snowthrower Belt. Replaces Toro 71-5381 . 3/8" (9.53 mm) x 34-1/2" (876.3 mm). Fits model CCR1000. Raw edge. *Aramid fiber.
12 - 12687	Snowthrower Auger Belt. Replaces Toro 75-9010 . 3/8" (9.5mm) x 29.218" (742.1 mm). Fits Power Life Snowthrowers 1997-2010. Raw edge, laminated, aramid cord construction.
12 - 14365 	Drive Belt. Replaces Toro 88-6250 . 1/2" (12.7 mm) x 87-1/2" (1905 mm). Fits models 71193, 14-38HXL lawn tractor. Also replaces John Deere GX21986, M40223, M86996. Traction drive belt for 100 series with 54" deck. Wrapped molded, Aramid cord construction, double friction cover.
12 - 14042 	Drive Belt. Replaces Toro 91-2258 . 3/8" (9.5 mm) x 35" (889 mm). Fits Recycler and Super Recycler self-propelled belt for walk-behind mowers. Covered belt.

TROY BILT

12 - 10821	Tiller Belt. Replaces Troy Bilt 1128-1 . 1/2" (12.7 mm) x 21-3/4" (552.5 mm). Fits Horse tiller models. Raw edge, laminated, fiberglass cord construction.
12 - 10822	Drive Belt. Replaces Troy Bilt 9245 . 1/2" (12.7 mm) x 22-1/4" (565.2 mm). Fits 4 speed Horse models. Type 2. Raw edge, laminated, aramid cord construction.



BELTS

Commercial Mower Belts

Belts for



BUNTON

Order No.

Description

- 12 - 5241** **Drive Belt.** Replaces Bunton **PL0619**. "B" section belt, 44.125" length (1120.76 mm), fits 36" & 48" deck. Cogged.
- 12 - 5237** **Blade to Blade Belt.** Replaces Bunton **PL0643**. "A" Section Belt, 49.875" length (1266.83 mm). For 36" deck. Covered.
- 12 - 5238** **Variable Speed Belt.** Replaces Bunton **PL0848**. "B" Section Belt, 39.875" length (1012.83 mm), cogged. For 36", 48" & 52" decks.
- 12 - 7913** **Wheel Drive Belt.** Replaces Bunton **PL 4275**. Double belt, 45-13/32" length (1153.32 mm), fits 36", 48" and 52" cut mid size. Banded.

12

BELTS

RANSOMES/BOBCAT

- 12 - 5242** **Variable Speed Belt.** Replaces Ransomes/Bobcat **38016N**. "B" Section Belt, 35.6" length (904.24 mm). 32" and 36" decks. Raw Edge.
- 12 - 5241** **Wheel Drive Belt.** Replaces Ransomes/Bobcat **38017N**. "B" Section Belt, 44.125" length (1120.76 mm), cogged. 36" and 48" decks.
- 12 - 5823** **Engine to Blade Belt.** Replaces Ransomes/Bobcat **38030N**. "B" Section Belt, 93" length (2362.2 mm). For 48" deck. Covered.
- 12 - 6969** **Gear Drive Belt.** Replaces Bobcat **38212**. Double "A" section 1-1/8" (28.57 mm) x, 55.95" length (1421.13 mm). Raw Edge.
- 12 - 6836** **Variable Speed Wheel Drive Belt.** Replaces Bobcat **38249**. Double "A" 1-1/8" width section 1, 44.700". Banded
- 12 - 8803** **Deck Belt.** Replaces Bobcat **38440**. 21/32" (16.66 mm) x 85.3" (2166.6 mm). Fits new style 48" deck, Hydro mowers. Wrap molded. *Aramid fiber.
- 12 - 8809** **Engine to Center Spindle Belt.** Replaces Bobcat **38442**. 21/32" (16.67 mm) x 67.75" (1720.85 mm). Fits new style 48" cut models. Engine to center spindle for gear drive units. Wrap molded. *Aramid fiber.
- 12 - 8810** **Gear Drive Belt.** Replaces Bobcat **38523**. 1-1/8" (28.57 mm) x 54" (1371.6 mm). Cogged belt for all 94, 95, 96 Bobcats. Raw edge, cogged, *Aramid fiber construction. 2 rib band belt.
- 12 - 11853** **Cutter Deck Belt.** Replaces Bobcat **128003**. 5/8" (15.88 mm) x 132-3/4" (3353.55 mm).
- 12 - 8811** **Transmission Belt.** Replaces Bobcat **128099**. 1/2" (12.70 mm) x 36.12" (917.45 mm). Transmission belt on newer gear drive machines. Raw edge, *Aramid fiber.
- 12 - 8808** **Engine to Hydro Pump Belt.** Replaces Bobcat **2188128**. 1/2" (12.70 mm) x 63" (1600.2 mm). Fits 61"cut "O" turn models. Raw edge. *Aramid fiber.



Commercial Mower Belts



Belts for

RANSOMES/BOBCAT (CONT.)

Order No. Description

12 - 11468 Engine to Deck Belt. Replaces Bobcat **2188134**. 5/8" (15.8 mm) x 101" (2565.4 mm). Fits 61" ZTR rider. Laminated, aramid cord construction.

DIXIE CHOPPER

- 12 - 10035** Deck Belt. Replaces Dixie Chopper 63203 (**A89**). 1/2" (12.7 mm) x 91.3" (2319 mm). Raw edge, Polyester cord construction.
- 12 - 10022** Deck Belt. Replaces Dixie Chopper 9907A96 (**A96**). 1/2" (12.7 mm) x 98.3" (2497 mm). Raw edge, Polyester cord construction.
- 12 - 13366** Engine -Transmission V-Belt. Replaces Dixie Chopper **2006A62R**. 1/2" (12.7 mm) x 64-1/2" (1638.3 mm). Fits Iron Eagle 2350 model. Raw edge belt.
- 12 - 10023** Engine to Transmission Belt. Replaces Dixie Chopper 20256 (**B38**). 21/32" (16.67 mm) x 40.9" (1039 mm). Raw edge, Polyester cord construction.
- 12 - 10024** Engine to Transmission Belt. Replaces Dixie Chopper 97345 (**B40**). 21/32" (16.67 mm) x 42.8" (1087 mm). Raw edge, Polyester cord construction.
- 12 - 10025** Engine to Transmission Belt. Replaces Dixie Chopper 9907B41(**B41**). 21/32" (16.67 mm) x 43.8" (1113 mm). Raw edge, Polyester cord construction.
- 12 - 10026** Engine to Transmission Belt. Replaces Dixie Chopper 63204 (**B42**). 21/32" (16.67 mm) x 44.8" (1138 mm). Raw edge, Polyester cord construction.
- 12 - 12239** Engine to Transmission Belt. Replaces Dixie Chopper 2006B44R (**B44**). 5/8" (15.87mm) x 47" (1193.8 mm). Fits 74" Xcaliber model.
- 12 - 11223** Pump to Engine Belt. Replaces Dixie Chopper 9907B57 (**B57**). 5/8" (15.8 mm) x 59.9" (1521.5 mm). Fits models LT36 & 44. Raw edge, laminated, polyester cord construction.
- 12 - 11503** Engine to Transmission Belt. Replaces Dixie Chopper 20000**B64**. 5/8" (15.8 mm) x 66.9" (1699 mm). Fits 2006 series LT2000-50D, LT2500-50D & LT2700-60D. Raw edge, Laminated, polyester cord construction.
- 12 - 10027** Engine to Deck Belt. Replaces Dixie Chopper 30204 (**B78**). 21/32" (16.67 mm) x 80.9" (2052 mm). Raw edge, Polyester cord construction.
- 12 - 10029** Deck Belt. Replaces Dixie Chopper 65080 **2006(B80)**. 21/32" (16.67 mm) x 82.9" (2106 mm). Fits 34",50" & 60" cut models. Raw edge, Polyester cord construction.
- 12 - 10030** Engine Belt. Replaces Dixie Chopper 68081 (**B81**). 21/32" (16.67 mm) x 83.8" (2129 mm). Raw edge, Polyester cord construction.
- 12 - 10031** Engine to Deck Belt. Replaces Dixie Chopper 68082 (**B82**). 21/32" (16.67 mm) x 84.8" (2154 mm). Raw edge, Polyester cord construction.
- 12 - 10814** Engine to Deck Drive Belt Replaces Dixie Chopper 9907B84.(**B84**) 5/8" (15.8 mm) x 86.9"(2286 mm). Raw edge, polyester cord construction.

12 BELTS

BELTS



Commercial Mower Belts

Belts for



DIXIE CHOPPER (CONT.)

Order No. **Description**

- 12 - 10032 Engine to Deck Belt.** Replaces Dixie Chopper 9907B85 (**B85**).
21/32" (16.67 mm) x 87.8" (2230 mm). Raw edge, Polyester cord construction.
- 12 - 12751 Engine to Deck Belt.** Replaces Dixie Chopper 2006**B87R** & 2008**B87W**.
(Super II B87) 5/8" (15.875 mm) x 89.8" (2280.9 mm). Fits 72" models.
Raw edge, laminated, aramid cord construction.
- 12 - 11502 Engine to Deck Belt.** Replaces Dixie Chopper 2006**B88**.
5/8" (15.8 mm) x 90.9" (1308.8 mm). Fits 2006 models X2703-60, XG2703-60,
XWF2700-60, XFG2700-60, SP2800-60, XT3300-060, LP3000-60,
XXG2703-72 & XT3300-72. Raw edge, Laminated, polyester cord construction.
- 12 - 12983 Engine to Deck Belt.** Replaces Dixie Chopper **2008B89**.
5/8" (15.875mm) x 91.9"(2334.2 mm). Fits Extreme 3372.
Raw Edge Belt.
- 12 - 11225 Engine to Deck Belt.** Replaces Dixie Chopper 9907B92 (**B92**). 5/8" (15.8 mm) x 94.9"
(2410.5 mm). Fits models LT44. Raw edge, laminated, polyester cord construction.
- 12 - 11226 Deck Belt.** Replaces Dixie Chopper 9907B94 (**B94**). 5/8" (15.8 mm) x 96.9"
(2461.3 mm). Fits models LT44. Raw edge, laminated, polyester cord construction.
- 12 - 13219 Engine to Deck Drive Belt.** Replaces Dixie Chopper **2008B97R**.
5/8" (15.875mm) x 100"(2540 mm).
- 12 - 12442 Deck Belt.** Replaces Dixie Chopper 2006B98R (**B98**).
5/8" (15.87mm) x 101" (2565.4 mm). Fits 66" Xcaliber model.
- 12 - 12238 Engine to Deck Belt.** Replaces Dixie Chopper 2006B99W (**B99**).
5/8" (15.87mm) x 102" (2590.8 mm). Fits 74" Xcaliber model.
- 12 - 13456 Deck Belt.** Replaces Dixie Chopper **2008B100R**. 5/8" (15.87 mm) x 102-7/8"
(2613 mm). Fits Iron Eagle. Belt- Engine -Deck 44" 60" decks (B100).
Raw edge belt.
- 12 - 10036 Deck Belt.** Replaces Dixie Chopper 30203 (**B103**).
21/32" (16.67 mm) x 105.8" (2687 mm). Raw edge, Polyester cord construction.
- 12 - 10033 Deck Belt.** Replaces Dixie Chopper 9907B112 (**B112**).
21/32" (16.67 mm) x 114.8" (2916 mm). Raw edge, Polyester cord construction.
- 12 - 10034 Deck Belt.** Replaces Dixie Chopper 9907B130 (**B130**).
21/32" (16.67 mm) x 132.8" (3373 mm). Raw edge, Polyester cord construction.
- 12 - 10011 Deck Belt .** Replaces Dixie Chopper 30236-0 (**B128**). 21/32" (16.7 mm)
x 130.8" (3323 mm). Fits 60" Mowers. Raw edge, Polyester cord construction.
- 12 - 12443 Deck Belt.** Replaces Dixie Chopper 2006B144R (**B144**).
5/8" (15.87mm) x 146-1/4" (3657.6 mm). Fits 66" Xcaliber model.
- 12 - 10815 Mule Drive Belt** Replaces Dixie Chopper 97346C158. (**C158**) 7/8" (22.2 mm)
x 162-1/8"(4118 mm). Fits 72" cut with Yanmar diesel engines Polyester cord construction.
- 12 - 12452 Engine to Deck Belt.** Replaces Dixie Chopper 2006**B160R**. 5/8" (15.875 mm) x
162.8"(4135.12 mm). Fits 72" models. Raw edge, laminated, aramid cord construction.
- 12 - 10010 Deck Belt .** Replaces Dixie Chopper 68162 (**B162**). 21/32" (16.7 mm)
x 164.8" (4185.84 mm). Fits 72" Mowers. Raw edge, Polyester cord construction.

12

BELTS



Commercial Mower Belts

**Belts for
DIXON
Order No.**



Description

12 - 8509 **Drive Belt.** Replaces Dixon **6111 & 539116200**. 5/8" (15.88 mm) x 78" length (1981.20 mm). Fits 42" & 50" deck, models 501, 503 & 542. Covered.

EXMARK

12 - 10716 **Blower Belt.** Replaces Exmark **103-0866**. 1/2" (12.7 mm) x 40-13/32" (1026.32 mm). Wrapped-molded, general purpose, polyester cord construction.

12 - 10254 **Mule Drive Belt.** Replaces Exmark **103-0881**. 17/32" (13.49 mm) x 120-5/16" (3055.93 mm). Fits Lazer XP.

12 - 10255 **Pump Drive Belt.** Replaces Exmark **103-0882**. 17/32" (13.49 mm) x 70-3/4" (1797.05 mm). Fits Lazer ZXP.

12 - 10256 **Pump Drive Belt.** Replaces Exmark **103-1297**. .700" (17.46 mm) x 25" (635 mm). Fits Lazer ZXP. Poly groove belt.

12 - 14638  **Deck Belt.** Replaces Exmark **103-2240**. 5/8" (15.87 mm) x 83-3/4" (2127.3 mm). Fits 52" Turf Tracer Hydro Wide area walk mowers. Wrapped molded, Aramid cord construction, double cover, white.

12 - 12237 **Mule Drive Belt.** Replaces Exmark **103-4014**. 5/8" (15.87mm) x 116-1/8" (3000.4 mm). Fits 60" & 72" Lazer Z mule drive. Wrapped molded, laminated aramid cord construction.

12 - 12641 **Pump Drive Belt.** Replaces Exmark **103-4761**. 1/2" (12.7mm) x 52-3/4" (1339.8 mm). Raw edge cogged belt.

12 - 13254 **Drive V-Belt.** Replaces Exmark **103-6317**. 5/8" (15.87 mm) x 38" (965.2 mm). Fits Metro HP & Turf Tracer Blade Clutch. Aramid cord construction, double cover, clutching, white color.

12 - 12783 **Deck Belt.** Replaces Exmark **103-6506**. 5/8" (15.875 mm) x 118-3/4" (3016.25 mm). Fits Lazer Z XS, 66" deck. Raw edge, laminated, aramid cord construction.

12 - 12799 **Pump Belt.** Replaces Exmark **109-7582**. 5K ribbed x 68.8" (1747.52 mm). Raw edge, laminated, aramid cord construction.

12 - 12426 **Pump Drive Belt.** Replaces Exmark **109-3388**. 1/2" (12.7mm) x 75.392" (1914.9 mm). Fits models Exmark Quest & Toro Titan. Aramid cord, construction, double cover, clutching-brown.

12 - 13255 **Drive V-Belt.** Replaces Exmark **109-4199**. 5/8" (15.87 mm) x 123" (3124.2 mm). Fits male drive diesel units. Aramid cord construction, double cover, clutching, white color.

12 - 14165 **Deck Belt.** Replaces Exmark **109-4994**. 5/8" (15.87 mm) x 186.00" (4724.4 mm). Fits Lazer Z 52" decks. Wrapped molded, Aramid cord construction, double cover, clutching, brown.

12 - 13256 **Drive V-Belt.** Replaces Exmark **109-5018**. 5/8" (15.87 mm) x 158" (4013.2 mm). Fits 66" Lazer Z-XS deck drive. Aramid cord construction, laminated.

12 BELTS

BELTS



Commercial Mower Belts



**Belts for
EXMARK
Order No.**

Description

- 12 - 12425** **Blade Drive Belt.** Replaces Exmark **109-5364**. 1/2" (12.7mm) x 146.1" (3710.9 mm). Fits models Exmark Quest & Toro Titan. Aramid cord, construction, double cover, clutching-white.
- 12 - 12799** **Pump Belt.** Replaces Exmark **109-7582**. 5K ribbed x 68.8" (1747.52 mm). Raw edge, laminated, aramid cord construction.
- 12 - 14217** **Deck Belt.** Replaces Exmark **109-8070**. 5/8" (15.87 mm) x 175.75" (4464.05 mm). Fits Lazer Z 48" decks. Wrapped molded, Aramid cord construction, double cover, clutching, brown.
- 12 - 14167** **Deck Belt.** Replaces Exmark **109-8073**. 5/8" (15.87 mm) x 198.75" (5048.25 mm). Fits Lazer Z 60" decks. Wrapped molded, Aramid cord construction, double cover, clutching, brown.
- 12 - 14209** **Deck Belt.** Replaces Exmark **116-3455**. 5/8" (15.87 mm) x 154.875" (3933.82 mm). Fits 48" decks. Wrapped molded, Aramid cord construction, double cover, clutching, brown.
- 12 - 5867** **Blade Drive Belt.** Replaces Exmark **1-303080**. 5/8" width (15.8) x 88.8" length (2255.5 mm) For 36" front cut mowers, 14000 series and higher. Covered.
- 12 - 5865** **Wheel Drive Belt.** Replaces Exmark **1-323051**. 5/8" width (15.8) x 44-7/8" length (1139.83 mm), cogged. For 32" decks, 5 speed transmission 10000 series and higher.
- 12 - 8812** **Engine to Gear Box Belt.** Replaces Exmark **1-323280**. 1/2" (12.7 mm) x 39.64" (1006.86 mm). Fits Exmark 32", 36", 48" & 52" metro units. Raw edge, *Aramid fiber.
- 12 - 9257** **Wheel Drive Belt.** Replaces Exmark **1-323288**. Double "A" section 1/2" (12.7 mm) x 48-13/16"(1239.8 mm), top width 1-1/8. Fits 36", 48" & 52" cut mowers. Raw edge. *Aramid fiber.
- 12 - 8091** **Engine to Blade Belt.** Replaces Exmark **1-323299**. "B" Section Belt, 82-11/32" length (2091.53 mm), fits 5 speed and variable speed with 48" decks. Raw Edge.
- 12 - 8805** **Engine to Blade Belt.** Replaces Exmark **1-323300**. 5/8" (15.88 mm) x 87.92" (2233.17 mm). Fits Exmark 48" cut metro units. Raw edge. *Aramid fiber.
- 12 - 13108** **Drive Belt.** Replaces Exmark **1-323344**. 5/8" (15.875mm) x 48.83" (1240.3 mm). Fits 32" Metro walkbehind. Cogged, raw edge, polyester cord construction.
- 12 - 13109** **Engine to Blade Belt.** Replaces Exmark **1-323733**. 5/8" (15.875mm) x 82.6"(2098 mm). Fits 36" Metro walkbehind. Wrapped molded, aramid cord construction, double cover, white.
- 12 - 13110** **Engine to Blade Belt.** Replaces Exmark **1-323734**. 5/8" (15.875mm) x 80.95"(2056 mm). Fits 32" Metro walkbehind. Wrapped molded, aramid cord construction, double cover, white.
- 12 - 8370** **Engine to Blade Belt.** Replaces Exmark **1-403024**. 5/8" width (15.88 mm) x 93.9" length (1993.90 mm). For 48" deck models. *Aramid fiber. Raw Edge.
- 12 - 8092** **Blade to Blade Belt.** Replaces Exmark **1-403025**. 5/8" Section Belt, 51-29/32" length (1318.42 mm), fits 5 speed and variable speed with 36" decks. Raw Edge.

12

BELTS



Commercial Mower Belts



Belts for EXMARK (CONT.)

Order No.	Description
12 - 13454	Drive V-Belt. Replaces Exmark 1-403174 . 5/8" (15.87 mm) x 115-9/32" (2928 mm). Fits main deck model Metro 48". Wrapped-molded, aramid cord construction, double cover, clutching, salt/pepper color.
12 - 10037	Blade Belt. Replaces Exmark 1-413093 . 5/8" (15.9 mm) x 136.64" (3471 mm). *Aramid fiber. Fits 48" Turf Tracer units.
12 - 11504	Deck Drive Belt. Replaces Exmark 1-413094 . 5/8" (15.8 mm) x 103-7/8" (2638.4 mm). Fits 36" Turf Ranger mid range units.
12 - 10887	Pump Drive Belt. Replaces Exmark 1-413095 . 1/2" (12.7 mm) x 50-1/2" (1282.7 mm). Fits Turf Tracer & Viking units. Raw edge, laminated, aramid cord construction.
12 - 12405	Deck Belt. Replaces Exmark 1-413096 . 5/8" (15.87mm) x 36.081" (916.4 mm). Neoprene, Aramid cord construction, double-cover, clutching.
12 - 10251	Blade Drive Belt. Replaces Exmark 1-413308 . 5/8" (15.9 mm) x 143.15" (3636.0 mm). Fits 52" Turf Tracer and 48" Lazer HP.
12 - 10038	Deck Belt. Replaces Exmark 1-523175 . 1/2" (12.7 mm) x 134-1/4" (3410 mm). *Aramid fiber. Fits 60" deck Lazer Z.
12 - 10886	Blade Drive Belt. Replaces Exmark 1-603045 . 1/2" (12.7 mm) x 112-1/2" (2857.5 mm). Fits 60" deck Turf Tracer. Raw edge, laminated, aramid cord construction.
12 - 10885	Drive Belt. Replaces Exmark 1-603306 . 5/8" (15.8 mm) x 81-1/4" (2063.8 mm). Fits 52" & 60" Turf Tracer serial numbers 84,000 and above. Wrapped, aramid cord construction.
12 - 12256	Deck Drive Belt. Replaces Exmark 1-603576 . 1/2" (12.7mm) x 101-1/4" (2571.8 mm). Fits Turf Tracer & Turf Ranger models. Raw edge laminated aramid cord construction.
12 - 10884	Pump Drive Belt. Replaces Exmark 1-613271 . 1/2" (12.7 mm) x 58" (1473.2 mm). Fits Turf Tracer. Raw edge, laminated, aramid cord construction.
12 - 9016	Blade Belt. Replaces Exmark 1-633127 . 5/8" (15.88 mm) x 146.17" (3712.72 mm). Fits 60" deck, Lazer models. Raw edge. *Aramid fiber.
12 - 10257	Pump Drive Belt. Replaces Exmark 1-633162 . 3/4" (19.05 mm) x 58" (1473.2 mm). Fits Lazer Z. 8 rib.
12 - 9014	Drive Belt. Replaces Exmark 1-633173 . 5/8" (15.88 mm) x 111.44" (2830.58 mm). Fits 52" & 60" deck, Lazer models. Wrap molded. *Aramid fiber.
12 - 9862	Blade Drive Belt. Replaces Exmark 1-633366 . 5/8" (15.9 mm) x 128-13/16" (3271.8 mm). Fits 52" Lazer Z. Raw Edge, *Aramid fiber.

12

BELTS



BELTS

Commercial Mower Belts



Belts for EXMARK (CONT.)

Order No.	Description
12 - 9863	Pump Drive Belt. Replaces Exmark 1-633569 . 5/8" (15.9 mm) x 57.19 (1452.6 mm) Fits Exmark Lazer mowers. 5 Rib, general purpose, polyester cord construction.
12 - 10041	Deck Belt. Replaces Exmark 1-643052 . 5/8" (15.88 mm) x 169.46" (4304 mm). Deck belt for 72" Lazer Z units. *Aramid fiber.
12 - 10252	Pump Drive Belt. Replaces Exmark 1-653163, 103-4760 . 1/2" (12.7 mm) x 52-1/4" (1327.2 mm). Fits 44" & 48 " Lazer ZHP. Raw edge, cogged.
12 - 10167	Blower Belt. Replaces Exmark 1-653332 . 1/2" (12.7 mm) x 37-3/4" (958.8 mm). Polyester cord construction. Fits 44" mowers.
12 - 10039	Blower Belt. Replaces Exmark 1-653333 . 1/2" (12.7 mm) x 38-1/2" (977.9 mm). Polyester cord construction. Fits 48" mowers.
12 - 10040	Mule Drive Belt. Replaces Exmark 1-653368 . 21/32" (16.67 mm) x 154" (3912 mm). *Aramid fiber. Fits Lazer Z
12 - 10253	Pump Drive Belt. Replaces Exmark 1-653416 . 1/2" (12.7 mm) x 51-3/8" (1304.9 mm). Fits 52" Lazer HP.
12 - 10717	Blower Belt. Replaces Exmark 1-653438 . 1/2" (12.7 mm) x 39-13/32" (1000.92 mm). Wrapped-molded, general purpose, polyester cord construction.

GRASSHOPPER

12 - 8733	Drive Belt. Replaces Grasshopper 381914 . 1/2" (12.70 mm) x 36" (914.4 mm). Fits P.T.O. Belt models 720, 721, 721D & 725. "A" section, Cog V-belt, raw edge and Dacron cord construction.
12 - 12094	Hydro Belt. Replaces Grasshopper 382034 . 5/8" (15.875 mm) x 60-1/2" (1536.7 mm). Fits Kohler mid mount mowers. Models 218, 220, 223, 225, 227. Raw edge, aramid cord construction.
12 - 10743	V Belt. Replaces Grasshopper 382035 . 5/8 (15.8 mm) x 65-3/4" (1670 mm). Fits 61" mid mount deck, diesel engine. Wrapped molded polyester cord construction,
12 - 8731	Drive Belt. Replaces Grasshopper 382037 . 5/8" (15.88 mm) x 64" (1625.6 mm). Fits 52" decks. Cog V-belt, raw edge. *Aramid fiber.
12 - 12095	Deck Belt. Replaces Grasshopper 382080 . 5/8" (15.875 mm) x 112-1/2" (2857.5 mm). Fits M148 deck (2003 and earlier). Wrapped, aramid cord construction.
12 - 12096	Deck Belt. Replaces Grasshopper 382082 . 5/8" (15.875 mm) x 120-1/2" (3060.7 mm). Fits M152 deck. Wrapped, aramid cord construction.



Commercial Mower Belts

Belts for



GRASSHOPPER (CONT.)

Order No.	Description
12 - 12097	Deck Belt. Replaces Grasshopper 382084 . 5/8" (15.875 mm) x 135-1/2" (3441.7 mm). Fits 3452 & 9852. Wrapped, aramid cord construction.
12 - 10744	Mule Drive & Deck Belt. Replaces Grasshopper 382085 . 5/8 (15.8 mm) x 137-1/2" (3492.5 mm). Fits 61" mid mount deck, diesel engine. Wrapped molded, aramid cord construction, clutching cover.
12 - 12098	Mule Drive Belt. Replaces Grasshopper 382086 . 5/8" (15.875 mm) x 110-1/2" (2806.7 mm). Fits 428D diesel. Wrapped, aramid cord construction.
12 - 12099	Deck Belt. Replaces Grasshopper 382090 . 5/8" (15.875 mm) x 141" (3581.4 mm). Fits 3461 & 9861. Wrapped, aramid cord construction.
12 - 14363	Deck Belt. Replaces Grasshopper 382093 . 5/8" (15.87 mm) x 145.5" (3695.7 mm). Fits 124-52 Mule Drive for 329B & 335B. Wrapped-molded, aramid cord construction, double cover, clutching, Brown.
12 - 10745	Mule Drive Belt. Replaces Grasshopper 382095 . 5/8 (15.8 mm) x 147-1/2" (3746.5 mm). Fits 61" mid mount deck, diesel engine. Wrapped molded, aramid cord construction, clutching cover.
12 - 12100	Mule Drive Belt. Replaces Grasshopper 382097 . 5/8" (15.875 mm) x 153-1/2" (3898.9 mm). Fits 428 diesel. Wrapped, aramid cord construction.
12 - 12106	Deck Belt. Replaces Grasshopper 382098 . 5/8" (15.875 mm) x 158" (4013.2 mm). Fits M172 deck and Mule Drive Belt 321D & 325 models (2005 and earlier). Wrapped, aramid cord construction.
12 - 12107	Mule Drive Belt. Replaces Grasshopper 382099 . 5/8" (15.875 mm) x 163" (4140.2 mm). Fits 428D diesel. Wrapped, aramid cord construction.
12 - 12108	Mule Drive Belt. Replaces Grasshopper 382110 . 5/8" (15.875 mm) x 150" (3810 mm). Fits 322D diesel. Wrapped, aramid cord construction.
12 - 12109	Mule Drive Belt. Replaces Grasshopper 382111 . 5/8" (15.875 mm) x 151-1/2" (3848.1 mm). Fits 329 models. Wrapped, aramid cord construction.

12

BELTS

BELTS



Commercial Mower Belts



Belts for GRAVELY

Order No.

Description

- 12 - 8717** **Drive Belt.** Replaces Gravelly **72224 & 49029.** 1/2" (12.70 mm) x 46.6" (1183.64 mm). Fits 2 per wheel on all Pro series walk behind. "A" section, Cogged. *Aramid fiber. **This belt sold in matching pairs.**
- 12 - 8760** **PTO Belt.** Replaces Gravelly **72250.** 1/2" (12.70 mm) x 37.6" (955.04 mm). Fits Pro Master 100, 200 & Pro 200, 300. Also fits 36", 38", 40" & 50" cut models. V-belt, raw edge, cogged. *Aramid fiber.
- 12 - 8711** **Wheel Drive Belt.** Replaces Gravelly **72258, 7225800.** 1/2" (12.70 mm) x 52.8" (1341.44 mm). For Pro 150 series. Cogged. **This belt sold in matching pairs.**
- 12 - 7837** **Cutter Deck Belt.** Replaces Gravelly **72266, 51213, 11216.** "A" Section Belt, 126.75" length (3219.45 mm), cogged. For 50" deck.

12

BELTS

GREAT DANE

- 12 - 10624** **Blade Drive Belt.** Replaces Great Dane **D18005.** 5/8" (15.8 mm) x 82-1/4" (2089.2 mm). Fits 52" Surfer. Raw edge, laminated, aramid cord construction.
- 12 - 10625** **Blade Drive Belt.** Replaces Great Dane **D18007.** 5/8" (15.8 mm) x 88-3/4" (2254.3 mm). Fits 61" Surfer. Raw edge, laminated, aramid cord construction.
- 12 - 10623** **Blade Drive Belt.** Replaces Great Dane **D18087.** 5/8" (15.8 mm) x 77-1/2" (1968.5 mm). Fits 48" Surfer. Raw edge, laminated, aramid cord construction.
- 12 - 10893** **Engine Pump Belt.** Replaces Great Dane **D18303.** 1/2" (12.7 mm) x 68-1/2" (1739.9mm). Fits Super Surfer. Raw edge, aramid cord construction.
- 12 - 10627** **Blade Drive Belt.** Replaces Great Dane **D28029.** 5/8" (15.8 mm) x 108-1/4" (2749.6 mm). Fits Chariot. Raw edge, laminated, aramid cord construction.
- 12 - 10626** **Blade to Blade Belt.** Replaces Great Dane **D28028.** 5/8" (15.8 mm) x 134-5/16" (3411.5 mm). Fits 61" Chariot. Wrap molded, general purpose, aramid cord construction.
- 12 - 10628** **Hydro Pump Drive Belt.** Replaces Great Dane **D28030.** 1/2" (12.7 mm) x 76" (1930.4mm). Fits Chariot. Raw edge, laminated, aramid cord construction.
- 12 - 10629** **Blade to Blade Belt.** Replaces Great Dane **D28031.** 5/8" (15.8 mm) x 120.3" (3055.6 mm). Fits 52" Chariot. Wrap molded, general purpose, aramid cord construction. Double "V" or Hex or BB Belt.
- 12 - 10894** **Engine Blade Belt.** Replaces Great Dane **D118348.** 5/8" (15.8 mm) x 108" (2743 mm). Fits 48" Super Surfer. Raw edge, aramid cord construction.



Commercial Mower Belts



Belts for HUSQVARNA

Order No.

Description

12 - 13118 **Drive Belt.** Replaces Husqvarna & Partner **544 90 84-02 & 506 29 67-02.** Fits K750 cut off saws. Also replaces Shindaiwa **38010-64131** & fits models EC7500, EC7600. 9/16" (14.28mm) x 31.898" (810.2 mm). 6 rib, polyester cord construction.

HUSTLER

- 12 - 12318** **Deck Belt.** Replaces Hustler **600726.** 1/2" (12.7 mm) x 114.3" (2903.2 mm). General purpose, Aramid cord construction, double cover, clutching.
- 12 - 12264** **Deck Belt.** Replaces Hustler **600734.** 1/2" (12.7 mm) x 132" (3352.8 mm). Fits 42" Mini Z model 928200. General purpose, Aramid cord construction, double cover, clutching.
- 12 - 12689** **Pump Belt.** Replaces Hustler **600979.** 1/2" (12.7mm) x 70.5" (1790.7 mm). Fits FasTrak Hydro pump belt for 48" & 54" decks. Aramid cord construction.
- 12 - 12690** **Deck Belt.** Replaces Hustler **601015.** 5/8" (15.875mm) x 204.5" (5194.3 mm). Fits rear discharge Z and Super Z, 54" decks. Aramid cord construction.
- 12 - 14000** **Deck Belt.** Replaces Hustler **602988.** 5/8" (15.87 mm) x 171-1/4" (4349.75 mm). Fits 60" X-One models. Wrapped molded, Aramid cord construction, double cover, clutching white.
- 12 - 10845** **Deck Belt.** Replaces Hustler **781310.** 5/8" (15.8 mm) x 180" (4572 mm). Fits Z and Super Z 60" deck. Wrapped, aramid cord construction.
- 12 - 10844** **Hydro Pump Belt.** Replaces Hustler **781443.** 1/2" (12.7 mm) x 62-1/4" (1581.2 mm). Fits Z and Super Z. Wrapped, polyester cord construction.
- 12 - 10847** **Deck Belt.** Replaces Hustler **782292.** 5/8" (15.8 mm) x 165-1/2" (4203.7 mm). Fits Z and Super Z 52" deck. Wrapped, aramid cord construction.
- 12 - 10846** **Deck Belt.** Replaces Hustler **784207.** 5/8" (15.8 mm) x 195" (4953 mm). Fits Z and Super Z 72" deck. Wrapped, aramid cord construction.
- 12 - 10851** **Hydro Pump Belt.** Replaces Hustler **784231.** 1/2" (12.7mm) x 73-3/4" (1873.3 mm). Fits hydraulic for Fast Track models. Wrapped, aramid cord construction.
- 12 - 10852** **Deck Belt.** Replaces Hustler **784249.** 5/8" (15.8mm) x 145-3/8" (3692.5 mm). Fits 52" Fast Track models. Wrapped, aramid cord construction.

12 BELTS

BELTS



Commercial Mower Belts



Belts for HUSTLER (CONT.)

Order No.

Description

- 12 - 10861** **Deck Belt.** Replaces Hustler **784322**. 5/8" (15.8mm) x 138-1/4" (3511.6 mm). Fits 44" Fast Track models. Wrapped, aramid cord construction.
- 12 - 10850** **Deck Belt.** Replaces Hustler **786491**. 5/8" (15.8 mm) x 140" (3556 mm). Fits Mini Z and Super Z 44" & 48" deck. Wrapped, aramid cord construction.
- 12 - 10849** **Deck Belt.** Replaces Hustler **786483**. 5/8" (15.8 mm) x 148-1/2" (3771.9mm). Fits Mini Z and Super Z 52" deck. Wrapped, aramid cord construction.
- 12 - 10848** **Hydro Pump Belt.** Replaces Hustler **786533**. 1/2" (12.7 mm) x 57-3/8" (1457.3 mm). Fits Mini Z and Super Z 52" deck. Wrapped, aramid cord construction.
- 12 - 12688** **Pump Belt.** Replaces Hustler **788711**. 1/2" (12.7mm) x 47.382" (1203.5 mm). Fits Tristar walkbehind mowers. Aramid cord construction.
- 12 - 12695** **Deck Drive Belt.** Replaces Hustler **788729**. 5/8" (15.875mm) x 65.08" (1653 mm). Fits TriStar 48" deck drive walkbehind mower. Aramid cord construction.
- 12 - 12693** **Deck Belt.** Replaces Hustler **788737**. 1/2" (12.7mm) x 50.125" (1273.2 mm). Fits Tristar 36" walkbehind mowers. Aramid cord construction.
- 12 - 12417** **Hydro Pump Belt.** Replaces Hustler **788745**. 5/8" (15.875 mm) x 86.306" (2192.2 mm). Fits 48" deck Trimstar Hydro walkbehind models. General purpose, Aramid cord construction, double cover, clutching.
- 12 - 12414** **Hydro Pump Belt.** Replaces Hustler **788794**. 1/2" (12.7 mm) x 64" (1625.6 mm). Fits MINI Z 36" & 42" units. Laminated, Aramid cord construction.
- 12 - 12320** **Deck Belt.** Replaces Hustler **789388**. 5/8" (15.875 mm) x 152" (3860.8 mm). General purpose, Aramid cord construction, double cover, clutching.
- 12 - 12319** **Deck Belt.** Replaces Hustler **791335**. 5/8" (15.875 mm) x 143" (3632.2 mm). General purpose, Aramid cord construction, double cover, clutching.
- 12 - 12415** **Deck Belt.** Replaces Hustler **793828**. 1/2" (12.7 mm) x 116" (2946.4 mm). Fits 36" deck Mini Fastrack models. General purpose, Aramid cord construction, double cover, clutching.
- 12 - 12413** **Hydro Pump Belt.** Replaces Hustler **793836**. 1/2" (12.7 mm) x 63" (1600.2 mm). Fits MINI FASTTRAK models. General purpose, Aramid cord construction, double cover.

12 BELTS



Commercial Mower Belts

Belts for HUSTLER (CONT.)



Order No.

Description

- 12 - 12416** **Deck Belt.** Replaces Hustler 793893. 1/2" (12.7 mm) x 127.3" (3233.4 mm). Fits 42" deck Mini Fastrack models. General purpose, Aramid cord construction, double cover, clutching.
- 12 - 12691** **Deck Belt.** Replaces Hustler **795781**. 5/8" (15.875mm) x 213.5" (5422.9 mm). Fits rear discharge Z and Super Z, 60" decks. Aramid cord construction.
- 12 - 12692** **Deck Belt.** Replaces Hustler **797167**. 5/8" (15.875mm) x 228.71" (5809.2 mm). Fits rear discharge Super Z only. Aramid cord construction.
- 12 - 12694** **Deck Drive Belt.** Replaces Hustler **797514**. 1/2" (12.7mm) x 66.378" (1686 mm). Fits TriStar 36" deck drive walkbehind mower. Aramid cord construction.
- 12 - 12322** **Deck Belt.** Replaces Hustler **797720**. 5/8" (15.875 mm) x 176.79" (4490.5 mm). General purpose, Aramid cord construction, double cover, clutching.
- 12 - 12321** **Deck Belt.** Replaces Hustler **797928**. 5/8" (15.875 mm) x 160.2" (4069.1 mm). General purpose, Aramid cord construction, double cover, clutching.
- 12 - 12323** **Deck Belt.** Replaces Hustler **797936**. 5/8" (15.875 mm) x 184.79" (4693.6 mm). General purpose, Aramid cord construction, double cover, clutching.

12

BELTS

BELTS



Commercial Mower Belts



**Belts for
JOHN DEERE**

Order No. **Description**

- 12 - 11026** **Primary Belt.** Replaces John Deere **M122106**. 1/2" (12.7 mm) x 70.62" (1793.74 mm). Fits models GS25, GS30, GS45 & GS75 commercial walkbehind mowers with 36" deck. Also fits G15 commercial walkbehind mowers. Wrapped molded, general purpose, aramid cord construction, clutching cover.
- 12 - 11027** **Secondary Drive Belt.** Replaces John Deere **M122107**. 1" (25.4 mm) x 50.394" (1280 mm). Fits models GS25, GS30, GS45 & GS75 commercial walkbehind mowers. Fits HD45 and HD75 Hydrostatic commercial walk behind mowers. Fits G15 commercial walk-behind mowers. Synchronous timing belt.
- 12 - 11028** **Drive Belt.** Replaces John Deere **M122907**. 5/8" (15.875 mm) x 50.49" (1282.4 mm). Fits models GS25, GS30, GS45 & GS75 commercial walkbehind mowers. Fits G15 commercial walk-behind mowers. Raw edge, cogged, aramid cord construction.
- 12 - 11024** **Drive Belt.** Replaces John Deere **TCU16092**. 5/8" (15.875 mm) x 150.2" (3815.08 mm). Fits models 717 front mount mowers, zero turns with 48" decks. Fits Great Dane Chariot / Chariot LX. Wrapped molded, laminated neoprene, aramid cord, clutch cover.
- 12 - 11025** **Drive Belt.** Replaces John Deere **TCU16093**. 5/8" (15.875 mm) x 157.28" (3994.91 mm). Fits models 727 mini frame Z-trak, front mount mowers, zero turn with 54" decks. Fits Great Dane Chariot / Chariot LX 54" cut. Wrapped molded, laminated, neoprene, aramid cord, clutch cover.

SCAG

- 12 - 7789** **Blade Belt.** Replaces Scag **48087**. 5/8" (15.88 mm) x 52.9" (1343.66 mm). *Aramid fiber. Used on Scag 48" cut mid size mowers. Covered.
- 12 - 7790** **Engine to Blade.** Replaces Scag **48089**. "B" section belt, 89.6" (2275.84 mm). *Aramid fiber. Used on Scag 48" cut mid size mowers. Covered.
- 12 - 5235** **Wheel Drive Belt.** Replaces Scag **48202A, 48202**. Double "A" 1-1/8" Section Banded Belt, 51.5" length (1308.10 mm). (Fits Belt Drive Walk Behind). Raw Edge.
- 12 - 7791** **Transmission Drive Belt.** Replaces Scag **48203**. 1/2" (12.70 mm) x 39.8" (1010.92 mm). *Aramid fiber. Used on Scag 32", 36", 48", 52" and 61" cut mid size mowers. Raw Edge..
- 12 - 5236** **Cutter Deck Belt.** Replaces Scag **48204**. "B" Section Belt, 82" length (2082.80 mm). (Fits Belt Drive Walk Behind 36" cut). Covered.
- 12 - 7631** **Blade Drive Belt.** Replaces Scag **48207**. 86-1/8" (2187.58 mm) x 5/8" (15.88 mm). For 48" and 60" decks. Covered.
- 12 - 12049** **Pump Drive Belt.** Replaces Scag **48553**. 1/2" (12.7 mm) x 50-1/2" (1282.7 mm). Fits SWZ. Raw edge, laminated, aramid cord construction.



Commercial Mower Belts



Belts for SCAG (CONT.)

Order No.	Description
12 - 10402	Pump Drive Belt. Replaces Scag 48587 . 17/32" (13.5 mm) x 57" (1447.8 mm). Fits models SWZ-52 & 61. *Aramid cord construction, raw edge belt.
12 - 10404	Blade Drive Belt. Replaces Scag 48752 . 21/32" (16.7 mm) x 120-3/8" (3057.5 mm). Fits models SMTZ-61. *Aramid cord construction, wrapped belt.
12 - 10403	Blade Drive Belt. Replaces Scag 48799 . 11/16" (17.5 mm) x 115" (2921 mm). Fits models SWZ-48. *Aramid cord construction, raw edge belt.
12 - 8714	Drive Belt. Replaces Scag 48912 . 5/8" (15.88 mm) x 117.5" length (2984.5 mm). Fits models STHM with CV20 & CV22 hp. For 1994 & newer 61" cut models. Covered.
12 - 10405	Blade Drive Belt. Replaces Scag 48996 . 21/32" (16.6 mm) x 135-1/2" (3441.7 mm). Fits model SMZ-61. Wrapped, *Aramid cord construction.
12 - 10407	Blade Drive Belt. Replaces Scag 481001 . 21/32" (16.6 mm) x 128-13/32" (3267.9 mm). Fits model SMZ-52. Wrapped, *Aramid cord construction.
12 - 12085	Pump Drive Belt. Replaces Scag 483165 . 5/8" (15.875 mm) x 80" (2032 mm). Fits Turf Tiger. Raw edge, cogged, aramid cord construction.
12 - 10317	Deck Drive Belt. Replaces Scag 481460 . 5/8" (15.87 mm) x 43" (1092 mm). Fits Turf Tiger 52" & 61" decks. *Aramid Cord, cogged, raw edge belt.
12 - 10043	Pump Drive Belt. Replaces Scag 481461 . 1/2" (12.7 mm) x 60.86" (1546 mm). Deck belt fits 52" & 61" Turf Tiger units. *Aramid fiber.
12 - 10409	LH Transmission Drive Belt. Replaces Scag 481498 . 1/2" (12.7 mm) x 41-3/4" (1060.5 mm). Fits model STR. Raw edge, *Aramid cord construction.
12 - 10410	RH Transmission Drive Belt. Replaces Scag 481499 . 1/2" (12.7 mm) x 34 (863.6 mm). Fits model STR. Raw edge, *Aramid cord construction.
12 - 10411	Blade Drive Belt. Replaces Scag 481557 . 21/32" (16.6 mm) x 123-15/16" (3148 mm). Fits model STT-52. Raw edge, *Aramid cord construction.
12 - 10044	Deck Drive Belt. Replaces Scag 481558 . 5/8" (15.9 mm) x 139.95" (3555 mm). Deck drive belt fits 61" Turf Tiger units. *Aramid fiber.
12 - 10914	Pump Drive Belt. Replaces Scag 481749 . 1/2" (12.7 mm) x 59" (1498.6 mm). Fits Turf Tiger models. Raw edge, laminated, aramid cord construction.
12 - 12233	Deck Drive Belt. Replaces Scag 481980 . 5/8" (15.875 mm) x 162-1/2" (4127.5 mm). Fits 72" Turf Tiger. Wrapped molded, aramid cord construction.

12 BELTS

BELTS



Commercial Mower Belts



Belts for SCAG (CONT.)

Order No.	Description
12 - 10045	Transmission Drive Belt. Replaces Scag 482009 . 1/2" (12.7 mm) x 52" (1321 mm). Transmission drive belt fits 40", 48" & 52" Turf Tiger units. *Aramid fiber.
12 - 10046	Deck Drive Belt. Replaces Scag 482137 . 21/32" (16.67 mm) x 116.75" (2965 mm). Deck drive belt for 48" Turf Tiger units. *Aramid fiber.
12 - 10047	Deck Drive Belt. Replaces Scag 482138 . 21/32" (16.67 mm) x 50" (1270 mm). Deck drive belt for 48" RH cutter deck Turf Tiger units. *Aramid fiber.
12 - 10048	Deck Drive Belt. Replaces Scag 482139 . 21/32" (16.67 mm) x 120" (3048 mm). Deck drive belt for 52" Turf Tiger units. *Aramid fiber.
12 - 10049	Deck Drive Belt. Replaces Scag 482140 . 21/32" (16.67 mm) x 55" (1397 mm). Deck drive belt for 52" RH cutter deck Turf Tiger units. *Aramid fiber.
12 - 10050	Pump Drive Belt. Replaces Scag 482171 . 1/2" (12.7 mm) x 60" (524 mm). Fits Scag 52" & 61" cut Turf Tiger.
12 - 10365	Cutter Deck Belt. Replaces Scag 482529 . 21/32" (16.6 mm) x 148" (3759.2 mm). Fits 48" Tiger Cub. *Aramid Cord, wrapped clutching cover.
12 - 12371	Deck Belt. Replaces Scag 482530 . 5/8" (15.875 mm) x 154-7/8" (3765.6 mm). Fits 52" up to 2005. Fits models SMTC-52' cut Tiger Cub. Raw edge, laminated, aramid cord construction.
12 - 10318	Pump Drive Belt. Replaces Scag 482641 . 1/2" (12.70 mm) x 79-13/16" (2027 mm). Fits Turf Tiger. *Aramid Cord, laminated, raw edge belt.
12 - 12824	Deck Belt. Replaces Scag 482652 , Ferris 5022061 5/8" (15.87 mm) x 175-29/32" (4468.1 mm). Fits Scag Tiger Cub SMTC-61, Wildcat 61" deck. Also fits Ferris ISZ Zero turn 61" deck. Wrapped-molded, aramid cord construction, double cover, clutching, salt/pepper color.
12 - 10319	Pump Drive Belt. Replaces Scag 482716 . 1/2" (12.70 mm) x 61.5/8" (1565 mm). Fits Tiger Cub. *Aramid Cord, laminated, raw edge belt.
12 - 12248	Pump Drive Belt. Replaces Scag 482873 . 1/2" (12.7 mm) x 79-1/2" (2019.3 mm). Fits 52" Turf Tiger. Raw edge, laminated, aramid cord construction.
12 - 12249	Deck Drive Belt. Replaces Scag 482876 . 5/8" (15.875 mm) x 43-3/4" (1111.25 mm). Fits Turf Tiger. Raw edge, cogged, aramid cord construction.
12 - 12067	Pump Drive Belt. Replaces Scag 483157 . 43/64" (17.06 mm) x 65" (1651 mm). Fits STC. Raw edge, cogged, aramid cord construction.
12 - 12068	Pump Drive Belt. Replaces Scag 483172 . 43/64" (17.06 mm) x 65-5/8" (1666.87 mm). Fits STC. Raw edge, cogged, aramid cord construction.
12 - 12069	Deck Drive Belt. Replaces Scag 483239 . 43/64" (17.06 mm) x 50" (1270 mm). Fits SMTC 48V. Raw edge, cogged, aramid cord construction.



Commercial Mower Belts



Belts for SCAG (CONT.)

Order No.	Description
12 - 12070	Deck Drive Belt. Replaces Scag 483240 . 43/64" (17.06 mm) x 54-1/2" (1384.3 mm). Fits SMWC 52V. Raw edge, cogged, aramid cord construction.
12 - 12071	Deck Drive Belt. Replaces Scag 483241 . 5/8" (15.875 mm) x 117-1/2" (2984.5 mm). Fits STC 48V. Wrapped, aramid cord construction.
12 - 12072	Deck Drive Belt. Replaces Scag 483242 . 5/8" (15.875 mm) x 125-1/2" (3187.7 mm). Fits STC & STWC 52V. Wrapped, aramid cord construction.
12 - 12073	Deck Drive Belt. Replaces Scag 483243 . 5/8" (15.875 mm) x 135-1/2" (3441.7 mm). Fits STWC 61V. Wrapped, aramid cord construction.
12 - 13257	Pump Drive Belt. Replaces Scag 483314 . 1/2" (12.7 mm) x 80.755" (2051.2mm). Laminated, Aramid cord construction.
12 - 12719	Deck Belt. Replaces Scag 483326 . 5/8" (15.875mm) x 148.255" (3765.7 mm). Fits model Freedom Z 52" deck. Wrapped-molded, neoprene, aramid cord construction, double cover, wrapped, clutching-white.
12 - 12718	Deck Belt. Replaces Scag 483325 . 5/8" (15.875mm) x 140.755" (3575.2 mm). Fits model Freedom Z 48" deck. Wrapped-molded, neoprene, aramid cord construction, double cover, wrapped, clutching-white.
12 - 14593 	Deck Belt. Replaces Scag 483741 . 5/8" (15.87 mm) x 137" (3479.8 mm). Fits models SCZ61V, SCZ72V Cheetah, SMT-72V, STT-28CAT-SS, STT61V Turf Tiger. Wrapped molded, Aramid cord construction, double cover, clutching brown.

SNAPPER

12 - 8768	Blade Belt. Replaces Snapper 7028784 . 5/8" (15.86 mm) x 110.28" (2801.11 mm). Fits 42" rear engine riders. V-belt. *Aramid fiber. Covered.
12 - 8767	Spindle Belt. Replaces Snapper 7044637,70 28619 . 5/8" (15.86 mm) x 75-1/8" (1909.57 mm). Fits 28", 30" & 33" rear engine riders. V-belt. *Aramid fiber. Covered.
12 - 5233	Wheel Drive Belt. Replaces Snapper/Kees 7076497 . "B" Section Belt, 44" length (1117.60 mm), cogged.
12 - 11677	Drive Belt. Replaces Snapper 7046784 . 3/8" Hex (9.5 mm) x 24-1/2" (622.3 mm). General Purpose, Aramid cord construction, double cover, clutching.
12 - 14166	Deck Belt. Replaces Snapper 7103789 . 1/2" (12.7 mm) x 158.0" (4013.2 mm). Fits Snapper model RZT 52". Wrapped-molded, aramid cord construction, double cover, clutching, brown color.

STIHL

12 - 13117	Drive Belt. Replaces Stihl 9490 000 7900 . 7/16" (11.11mm) x 31.5" (800.1 mm). Fits Stihl model TS420 Cutquik cut off saws. 5 ribs, polyester cord construction.
-------------------	--

BELTS



Commercial Mower Belts



Belts for TORO

Order No.

Description

- 12 - 10746** **V Belt.** Replaces Toro **26-9671**. 1/2" (12.7 mm) x 39-5/16" (998.53 mm). Raw edge, laminated, aramid cord construction.
- 12 - 10210** **Drive Belt.** Replaces Toro **26-9672**. 1/2" (12.70 mm) x 30" (762 mm). Fits most 2 stage snowthrowers. Raw edge, polyester cord construction.
- 12 - 6837** **Blade to Blade Belt.** Replaces Toro **27-1160**. "AA" section belt, 103.5" length (2628.90 mm). Fits 44" & 52" midsize decks. Double V.
- 12 - 10387** **Deck Belt.** Replaces Toro **44-6260**. 1/2" (12.7 mm) x 122-1/8" (3101.9 mm). Fits Toro Groundmaster 62" ("AA") belt. Wrapped polyester cord construction.
- 12 - 5231** **Wheel Drive Belt.** Replaces Toro **51-4290**. Double "A" Section Belt, 50.375" length (1279.53 mm). For 32", 36", 44" & 52". Raw Edge.
- 12 - 6972** **Engine to Blade Belt.** Replaces Toro **55-7660**. Fits 52" midsize decks. 71" (1803.4 mm) length. Covered.
- 12 - 13247** **V Belt.** Replaces Toro **93-0232**. 3/8" (9.5 mm) x 31.939" (811.2mm). Fits 21" Recycler. Fiberglass cord construction, single cover, clutching white.
- 12 - 10051** **Engine to Deck Belt.** Replaces Toro **99-4647**. 21/32" (16.67 mm) x 142.10" (3609 mm). Fits 62" Z-Master. *Aramid fiber.
- 12 - 12805** **Drive Belt.** Replaces Toro **105-7790**. 5/8" (15.875mm) x 226" (5740.4 mm). Fits model Z587, 60" deck. Wrapped-molded, aramid cord construction, double cover, wrapped.
- 12 - 12867** **V Belt.** Replaces Toro **106-7369**. 5/8" (15.875mm) x 176" (4470.4mm) Fits Z-Master Z400 series. Aramid double clutching cover, white.
- 12 - 12729** **Engine PTO to Deck Belt.** Replaces Toro **105-8783**. 5/8" (15.875mm) x 242" (6146.8 mm). Fits model Z500 Z-Master 60" deck. Wrapped-molded, aramid cord construction, double cover, wrapped.
- 12 - 12730** **Engine PTO to Deck Belt.** Replaces Toro **106-7350**. 5/8" (15.875mm) x 264" (6705.6 mm). Fits model Z500 Z-Master 72" deck. Wrapped-molded, aramid cord construction, double cover, wrapped.
- 12 - 13570** **Spindle Drive Belt.** Replaces Toro **108-2694**. 1/2" (12.7 mm) x 111" (2819.4mm). Fits 30000 series commercial walk behind with 52" deck. Wrap molded, Aramid cord construction, double cover, semi-dry black.
- 12 - 13569** **PTO/Deck Drive Belt.** Replaces Toro **108-2693**. 1/2" (12.7 mm) x 81-3/4" (2076.4mm). Fits 30000 series commercial walk behind with 52" deck. Wrap molded, Aramid cord construction, double cover, clutching white.



Commercial Mower Belts







Belts for

TORO

Order No.

Description

- 12 - 13571** **PTO/Deck Drive Belt.** Replaces Toro **108-2715**. 5/8" (15.8 mm) x 78-21/64" (1989.5mm). Fits 30000 series commercial walk behind with 48" deck. Wrap molded, Aramid cord construction, double cover, friction.
- 12 - 13572** **Spindle Drive Belt.** Replaces Toro **108-2716**. 1/2" (12.7 mm) x 105-19/64" (2674.5mm). Fits 30000 series commercial walk behind with 48" deck. Wrap molded, Aramid cord construction, double cover, friction.
- 12 - 13573** **Pump Drive Belt.** Replaces Toro **110-5049**. 1/2" (12.7 mm) x 46-15/16" (1192.2mm). Fits 30000 series commercial walk behind. Wrap molded, Aramid cord construction, double cover, friction.
- 12 - 14129**  **Drive Belt.** Replaces Toro **110-6774**. 1/2" (12.7 mm) x 62-1/2" (1587.5 mm). Hydro pump drive belt. Fits Time Cutter Z4200, Z4220, Z4235, Z5000, Z5020, Z5030, Z5035, Z5040, Z5060. Cogged belt.
- 12 - 14130**  **Deck Belt.** Replaces Toro **110-6871**. 1/2" (12.7 mm) x 112-1/8" (2844.8 mm). Fits Z4200 42" TimeCutter Z. Wrapped belt.
- 12 - 12672** **V Belt.** Replaces Toro **110-6892**. 1/2" (12.7mm) x 140.1" (3558.5mm) Fits Timecutter Z5000-Z5040. Wrapped molded Aramid cord construction double cover, clutching, white.
- 12 - 11845** **Deck Drive Belt.** Replaces Toro **112-5800**. 1/2" (12.7 mm) x 109.10" (2771.14 mm). Wrapped molded general purpose, aramid cord, double clutching cover.
- 12 - 14318**  **Deck Belt.** Replaces Toro **115-4971**. 5/8" (15.87 mm) x 175-7/8" (4445 mm). Fits 54" ZX5400 Titan deck belt. Wrapped belt.
- 12 - 14319**  **Pump Belt.** Replaces Toro **115-9613**. 1/2" (12.7 mm) x 75-3/8" (2222.5 mm). Fits models Titan & Exmark Quest (42", 48" & 52") Raw edge cogged belt.
- 12 - 12916** **Pump Belt.** Replaces Toro **1-633749**. .687" (17.5mm) x 57.19" (1452.6mm). Accessory drive, pump belt, used on Z-Master. 5 rib belt.
- 12 - 13408** **Pump Belt.** Replaces Toro **1-653283**. 1/2" (12.7 mm) x 52-1/4" (1327.2mm). Fits models 74170, Z147 Z Master. Raw edge, Aramid cord construction.

12

BELTS

BELTS



Commercial Mower Belts



Belts for WALKER

Order No.

Description

- 12 - 8820** **PTO Belt.** Replaces Walker **6231**. 3/8" (9.53 mm) x 35.5" (901.7 mm). Fits model T. Cogged belt, Polyester cord construction.
- 12 - 12246** **PTO Drive Belt.** Replaces Walker **6250**. 3/8" (9.53 mm) x 37-1/2" (952.5 mm). Raw edge cog, polyester cord construction.
- 12 - 10320** **PTO Triple Belt.** Replaces Walker **7230**. 1-1/4" (31.75mm) x 38" (965.2 mm). Fits Diesel units. *Aramid Cord, wrapped clutching cover.
- 12 - 10321** **Blower Belt.** Replaces Walker **7234-1**. 9/16" (14.3mm) x 28-17/32" (724.7 mm). Fits new style blowers. 4 Rib poly, *Aramid Cord.
- 12 - 8819** **Blower Belt.** Replaces Walker **7234**. 3/8" (9.53 mm) x 28" (711.2 mm). Fits model T blower. Cogged belt, Polyester cord construction.
- 12 - 8798** **Ground Drive Belt.** Replaces Walker **7235**. 1/2" (12.70 mm) x 47.08" (1195.83 mm). Fits Hydro Pro model T. V-belt, double cogged, Dacron cord construction.
- 12 - 10322** **Ground Drive Belt.** Replaces Walker **7248**. 9/16" (14.3mm) x 47" (1193.8 mm). Fits hydros after 1996. 4 Rib poly-belt, polyester cord.
- 12 - 10323** **PTO Drive Belt.** Replaces Walker **8230**. 1-1/4" (31.75mm) x 40-7/16" (1031 mm). Triple belt fits T models. Laminated Aramid cord construction.

YAZOO/KEES/HUSQVARNA

- 12 - 10823** **Deck Belt.** Replaces Yazoo/Kees **104335**. 5/8" (15.9 mm) x 163-1/2" (4152.9 mm). Fits 52" Max 2 series "ZERO TURN" also replaces Husqvarna 539-104335 XP large frame mowers. Raw edge, laminated, aramid cord construction.
- 12 - 10824** **Deck Belt.** Replaces Yazoo/Kees **104336, 510201301**. 5/8" (15.9 mm) x 183-3/8" (4657.7 mm). Fits 61" Max 2 series "ZERO TURN" & Husqvarna 539-104336 XP large frame mowers. Raw edge, laminated, aramid cord construction.
- 12 - 10825** **Deck Belt.** Replaces Yazoo/Kees **105477**. 5/8" (15.9 mm) x 198-1/2" (5041.9 mm). Fits 72" Max 2 series "ZERO TURN" & Husqvarna 539-105477 large frame mowers. Raw edge, laminated, aramid cord construction.
- 12 - 7894** **Engine to Blade Belt.** Replaces Yazoo **205-505**. "AA" section belt, 80-1/8" length (2035.18 mm). Fits 30" Red Rider rear engine rider. *Aramid fiber. Double V.
- 12 - 10949** **Pump Belt.** Replaces Husqvarna **539-103241**. 1/2" (12.7mm) x 59-15/16" (1522.4 mm). Fits 48" zero turn riders. Also replaces Yazoo/Kees 103241. Raw edge, laminated, aramid cord construction.
- 12 - 11032** **Deck Belt.** Replaces Husqvarna **539-103687, 539-111949**. 5/8" (15.875mm) x 152.1" (3863.6 mm). Fits 48" zero turn riders. Raw edge, laminated, aramid cord construction.

MOST POPULAR "V" BELTS FOR SNOWBLOWERS



Order No.	Description
12 - 8762	Replaces Ariens 72023 , 1/4" (6.35 mm) x 27-5/32" (689.69 mm).
12 - 8432	Replaces Ariens 72047 . 3/8" (9.53 mm) width x 35-1/2" (901.70 mm) length, wrapped belt.
12 - 5065	Replaces Ariens 72056 (5 hp). 1/2" (12.70 mm) x 32" (812.8 mm).
12 - 5017	Replaces Ariens 72066 (8 hp), 3/8" (9.53 mm) x 34" (863.6 mm) Simplicity 118494 (5 & 8 hp).
12 - 8430	Replaces Ariens 72066 . 3/8" (9.53 mm) width x 34" (863.60 mm) length, (8-12 hp) raw edge belt.
12 - 8431	Replaces Ariens 72086 . 1/2" (12.70 mm) width x 40" (1016.00 mm) length, (8 hp) raw edge belt.
12 - 5016	Replaces Ariens 72098 (8 hp), 3/8" (9.53 mm) x 33" (838.2 mm).
12 - 8429	Replaces Ariens 72098 . 3/8" (9.53 mm) width x 33" (838.20 mm) length, raw edge belt.
12 - 5020	Replaces Ariens 72106 5 hp and Gilson 6163. 3/8" (9.53 mm) x 37" (939.8 mm).
12 - 8428	Replaces Ariens 72108 . 1/2" (12.70 mm) width x 37" (939.80 mm) length, (10 hp) raw edge belt.
12 - 8425	Replaces Ariens 72114 . 1/2" (12.70 mm) width x 34-1/2" (876.30 mm) length, raw edge belt.
12 - 8427	Replaces Ariens 72130 . 1/2" (12.70 mm) width x 39" (990.60 mm) length, (10 hp) raw edge belt.
12 - 8426	Replaces Ariens 72131 . 3/8" (9.53 mm) width x 36" (914.40 mm) length, (12 hp) raw edge belt.
12 - 5067	Replaces Bolens 1725253 . 1/2" (12.70 mm) x 34" (863.6 mm)
12 - 5018	Replaces Bolens 1894272 . 3/8" (9.53 mm) x 35" (889 mm)
12 - 5071	Replaces Gilson 14790 and 37230 , 1/2" (12.70 mm) x 38" (965.2 mm)
12 - 5070	Replaces Gilson 16366 (5 hp) 1/2" (12.70 mm) x 37" (939.8 mm)
12 - 5076	Replaces Gilson 17569 (8 & 11 hp), 1/2" (12.70 mm) x 43" (1092.2 mm)
12 - 12429	Replaces MTD 954-0430, 754-0430 . Fits models from 1992-2002. 3/8" (9.53 mm) x 35" (889 mm).
12 - 5069	Replaces Simplicity 1657806 . (4 hp), 1/2" (12.70 mm) x 36" (914.4 mm)
12 - 5074	Replaces Simplicity 1664457 (5 & 8 hp), 1/2" (12.70 mm) x 41" (1041.4 mm)
12 - 5073	Replaces Toro 16-9670, 23-9080 (Mod. 524-724-824-826-1132) and Gilson 35545, 16386, 1/2" (12.70 mm) x 40" (1016 mm)
12 - 5077	Replaces Toro 17-6540 (Mod. 826, x 1132), 1/2" (12.70 mm) x 44" (1117.6 mm)
12 - 5072	Replaces Toro 20-1820 (Mod. 524-724-824) and Simplicity 8021077 (4 hp), 1/2" (12.70 mm) x 39" (990.6 mm)
12 - 7952	Replaces Toro 25-6430 . Fits snowmaster S200 & S620. 3/32" (2.388 mm) x 33" (838.2 mm)
12 - 9861	Replaces Toro 55-9300 . Fits model CCR2000. 3/8" (9.53 mm) x 34" (863.6 mm)
12 - 10090	Replaces Toro 71-5381 . Fits model CCR1000. 3/8" (9.53 mm) x 34-1/2" (876.3 mm)

PULLEYS



Quick-Glance

PULLEYS	PG.
Idler / Pulley's	263-293
Idler Pulley Bushings	268
Idler Application Chart	294-296



V Belt Idlers

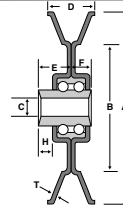

Order No.		A	B	C	D	E	F	H	T	
13 - 729	S	IV-40	2-5/8"	1-3/4"	3/8"	19/32"	1/2"	11/32"	3/16"	.050"
13 - 2918	S*	IV-80M	3"	2-1/16"	1/2"	1/2"	.240"	.240"	N/A	.050"
13 - 7127	P*		3"	1-31/32"	1/2"	11/16"	1/4"	1/4"	N/A	.086"
13 - 730	S	IV-42	3-1/16"	2"	3/8"	3/4"	1/2"	11/32"	3/32"	.060"
13 - 728	S	IV-39A	3-1/16"	2"	3/8"	11/16"	1/2"	11/32"	1/8"	.060"
13 - 731	S	IV-48A	3-1/16"	2"	3/8"	5/8"	1/2"	11/32"	5/32"	.060"
13 - 732	S	IV-48	3-1/8"	2-1/8"	3/8"	3/8"	1/2"	11/32"	3/16"	.060"
13 - 2182	S		3-1/2"	2-1/16"	3/8"	3/4"	1/2"	11/32"	1/8"	.060"
13 - 2919	S*	IV-81M	3-3/4"	2-9/16"	1/2"	5/8"	.240"	.240"	N/A	.075"
13 - 733	S	IV-64A	4"	3"	3/8"	21/32"	1/2"	11/32"	3/16"	.060"
13 - 734	S*	IV-64B	4"	2-3/4"	3/8"	13/16"	1/2"	11/32"	3/32"	.060"
13 - 5869	S*		4"	2-5/8"	3/8"	1"			3/16"	.074"
13 - 2183	S		4-1/2"	3"	3/8"	3/4"	7/32"		7/32"	.075"
13 - 5870	S*		4-1/2"	3-7/32"	3/8"	3/4"	17/32"			.074"
13 - 7918	S		4-15/16"	N/A	3/8"	15/16"	21/32"	1/4"	11/32"	.075"
13 - 10158	P*	VIP5000-5.403	5"	4.79"	17mm	0.87"		11/16"		
13 - 10159	P*	VIP6000-6.403	6"	5"	17mm	1.15"		11/16"		

(*) After Order Number Denotes Heavy Duty Bearing S=Steel Idler P=Plastic Idler

Flat Idlers

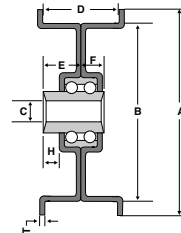

Order No.		A	B	C	D	E	F	H	T	
13 - 718	S	IF-3011	2"	1-7/8"	3/8"	3/4"	1/2"	11/32"	1/16"	.050"
13 - 715	S	IF-3008-A	2-1/8"	1-7/8"	3/8"	1/2"	1/2"	11/32"	1/16"	.050"
13 - 8478	S		2-1/4"	1-7/8"	1/4"	1/2"	1/2"	11/32"	1/2"	.050"
13 - 719	S	IF-3612	2-15/32"	2-1/4"	3/8"	3/4"	1/2"	11/32"	1/16"	.050"
13 - 720	P	IF-3616	2-15/32"	2-1/4"	3/8"	1"	5/8"	11/32"	1/16"	.050"
13 - 2181	S*		2-1/2"	2"	5/16"	13/16"	3/4"		3/32"	.040"
13 - 2175	S*		2-1/2"	2"	3/8"	13/16"	3/4"	11/32"	3/16"	.050"
13 - 738	S*		2-1/2"	2"	5/8"	5/8"	7/32"	7/32"	N/A	.040"
13 - 2188	S*		3-1/32"	2-3/4"	3/8"	7/8"	11/16"	9/32"	1/8"	.047"
13 - 2176	S	IF-4412	3-1/8"	2-3/4"	3/8"	3/4"	1/2"	11/32"	1/16"	.050"
13 - 2916	S*	IF-8002-M	3-3/16"	2-3/4"	1/2"	7/8"	.230"	.230"	N/A	.050"
13 - 722	S	IF-4812	3-7/32"	3"	3/8"	3/4"	1/2"	11/32"	1/16"	.050"
13 - 714	S	IF-4424-2	3-1/4"	2-3/4"	3/8"	1-1/4"	7/8"	11/32"	3/32"	.050"
13 - 721	S	IF-4414	3-1/4"	2-3/4"	3/8"	7/8"	5/8"	11/32"	1/8"	.050"
13 - 7978	N		3-23/64"	2-3/4"	1/2"	7/8"	1/4"	1/4"	N/A	.090"
13 - 7983	N		3-7/16"	3"	3/8"	3/4"	11/16"	15/64"	7/16"	.090"
13 - 8005	S		3-1/2"	2-3/4"	3/8"	1-1/4"	7/8"	3/8"	9/16"	.074"
13 - 724	S	IF-5216	3-9/16"	3-1/4"	3/8"	1"	5/8"	11/32"	1/16"	.060"
13 - 725	S	IF-5220	3-5/8"	3-1/4"	3/8"	1-1/4"	3/4"	11/32"	1/16"	.060"
13 - 723	S	IF-5212	3-3/4"	3-1/4"	3/8"	3/4"	1/2"	11/32"	1/16"	.060"
13 - 2915	S*	IF-8001-M	4"	3-3/8"	1/2"	15/16"	.230"	.230"	N/A	.050"

(*) After Order Number Denotes Heavy Duty Bearing

NOTE: 13-7978, 13-7983, are composite : glass filled nylon S=Steel Idler P=Plastic Idler

PULLEYS



Flat Idlers (Cont.)

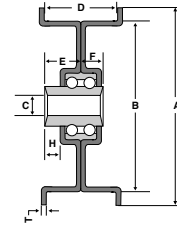

Order No.		A	B	C	D	E	F	H	T
13 - 8588	S	4"	3-1/8"	3/8"	3/4"	3/4"	11/32"	31/64"	.060"
13 - 8373	S	4-1/8"	3-15/32"	3/4"	25/32"	N/A	N/A	N/A	.075"
13 - 8602	N	4-1/8"	3-1/2"	3/8"	7/8"	5/8"	1/4"	17/64"	.125"
13 - 8245	S	4-1/8"	3-1/4"	3/8"	1-1/4"	1-3/8"	1/4"	1-5/64"	.060"
13 - 7157	S*	4-1/4"	3-3/4"	3/8"	1"	3/4"	N/A	3/32"	.060"
13 - 726	S IF-6412	4-1/2"	4"	3/8"	3/4"	1/2"	11/32"	1/16"	.040"
13 - 727	S IF-6416	4-1/2"	4"	3/8"	1"	5/8"	11/32"	1/16"	.040"
13 - 2189	S*	4-1/2"	4"	3/8"	2"	1-1/4"	5/16"	1/8"	.059"
13 - 2917	S* IF-8003-M	4-9/16"	4"	1/2"	7/8"	.240"	11/32"	3/16"	.074"
13 - 7937	N	4-19/32"	4"	1/2"	23/32"	1/4"	1/4"	N/A	.090"
13 - 7861	N	4-19/32"	4"	3/8"	23/32"	21/32"	1/4"	9/16"	.090"
13 - 5714	S*	4-5/8"	4"	3/8"	11/16"	11/16"	5/16"	1/8"	.074"
13 - 7182	N*	4-3/4"	4"	3/8"	7/8"	3/4"	5/16"	1/16"	.090"
13 - 3236	S*	4-3/4"	4"	1/2"	27/32"	.230"	.230"	N/A	.050"
13 - 7126	N	4-3/4"	4"	1/2"	1-3/8"	1/4"	1/4"	N/A	.125"
13 - 777	S	4-7/8"	4-1/16"	3/8"	3/4"	5/8"	.236"	1/16"	.075"
13 - 5712	S*	5-3/16"	5"	3/8"	1-3/16"	1"	5/16"	3/16"	.074"
13 - 6572	S*	5-15/16"	5"	3/8"	1-1/4"	3/4"	9/32"	1/16"	.074"
13 - 7176	S	6-3/4"	6"	1/2"	3/4"	7/16"	7/16"	N/A	.074"

(* After Order Number Denotes Heavy Duty Bearing

NOTE: 13-7937, 13-8602, 13-7861, 13-7126, 13-7182 are composite : glass filled nylon

13

Flat Idler without Flanges

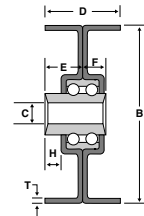

Order No.		B	C	D	E	F	H	T
13 - 2190	IP-3620	2-1/4"	3/8"	1-1/4"	3/4"	11/32"	1/8"	.050"
13 - 2191	IP-4420	2-3/4"	3/8"	1-3/16"	3/4"	11/32"	1/8"	.050"
13 - 2192	IP-5222	3-1/4"	3/8"	1-5/16"	3/4"	11/32"	1/8"	.060"
13 - 2193	IP-3015-2	1-7/8"	3/8"	15/16"	3/8"	11/32"	1/8"	.050"
13 - 5711*		5"	1/2"	1-3/16"	1/2"	1/2"		.074"
13 - 7813		4"	3/8"	1-9/16"	3/4"	13/16"	7/16"	.060"

Replaces: Hahn, Huffman Mfg. Wheel Horse, Huffman Mfg. Bobcat 38184-2, FMC Corp. MTD, Toro 25-5880, Toro 51-4480 and Scag 48198.

(* After Order Number Denotes Heavy Duty Bearing

Sprocket Idlers

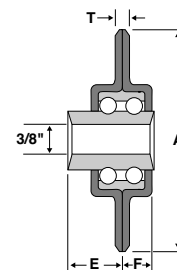

Order No.		A	E	F	No. of Teeth	T	Chain Size
13 - 735	IS-618	2.35	1/2"	11/32"	18	1/8"	35
13 - 736	IS-810	1.84	1/2"	11/32"	10	1/8"	40, 41
13 - 737	IS-814	2.49	1/2"	11/32"	14	1/8"	40, 41

PULLEYS



Composite Flat Idler Pulley Assortment

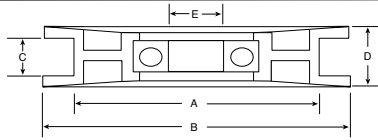

Order No. 01 - 10125

This assortment contains 40 Flat Idler Pulleys with hooks and display board. Used with our **01-7842** Bushing Asst.

Order No. 01 - 10207

Flat Idler Assortment Board 24" x 38". (Composite) Board Only. Used with our **01-10125** Assortment. **(Board Only)**



Order No.	QTY	Description	A	B	C	D	E
13 - 10138	2	FIP1750-0.75	1-3/4"	2-7/32"	3/4"	15/16"	11/16"
13 - 10139	2	FIP1875-0.50	1-7/8"	2-1/8"	1/2"	45/64"	11/16"
13 - 10140	2	FIP1875-0.75	1-7/8"	2"	3/4"	31/32"	11/16"
13 - 10141	2	FIP2250-0.75	2-1/4"	2-23/32"	3/4"	15/16"	11/16"
13 - 10142	2	FIP2500-0.75	2-1/2"	2-31/32"	1"	1-3/16"	11/16"
13 - 10143	2	FIP2500-1.00	2-1/2"	2-31/32"	1"	1-3/16"	11/16"
13 - 10144	2	FIP2750-0.75	2-3/4"	3-7/32"	3/4"	15/16"	11/16"
13 - 10145	2	FIP2750-0.86	2-3/4"	3-3/16"	23/32"	1-1/16"	11/16"
13 - 10146	2	FIP2750-1.00	2-3/4"	3-7/32"	1"	1-3/16"	11/16"
13 - 10147	2	FIP3000-0.75	3"	3-1/2"	3/4"	1"	11/16"
13 - 10148	2	FIP3000-1.01	3"	3-31/64"	1"	1-3/16"	11/16"
13 - 10149	2	FIP3120-0.75	3-1/8"	4"	3/4"	1-1/8"	11/16"
13 - 10150	2	FIP3500-0.75	3-1/2"	4-1/8"	3/4"	1"	11/16"
13 - 10151	2	FIP3500-0.97	3-1/2"	3-31/32"	1"	15/32"	11/16"
13 - 10152	2	FIP4000-0.72	4"	4-39/64"	23/32"	1-1/16"	11/16"
13 - 10153	2	FIP4000-0.86	4"	4-3/4"	7/8"	1-11/32"	11/16"
13 - 10154	2	FIP4000-1.00	4"	4-5/8"	1"	1-3/16"	11/16"
13 - 10155	2	FIP4500-0.96	4-1/2"	4-31/32"	31/32"	1-1/8"	11/16"
13 - 10156	2	FIP5000-1.25	5"	5-1/2"	1-1/4"	1-1/2"	11/16"
13 - 10157	2	FIP6000-0.75	6"	6-1/2"	1"	1-9/32"	11/16"

Composite V-Belt Idler Pulley Assortment

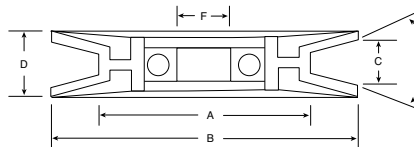

Order No. 13 - 10126

This assortment contains 20 V-Belt Idler Pulleys with hooks and display board. Used with our **01-7842** Bushing Asst.

Order No. 01 - 10208

V-Idler Assortment Board 18" x 30". (Composite) Board Only. Used with our **01-10126** Assortment. **(Board Only)**



Order No.	QTY	Description	A	B	C	D	F
13 - 10128	2	VIP2000-2.112	1-3/8"	2"	3/8"	5/8"	10 mm
13 - 10129	2	VIP2500-2.740	1-3/4"	2-1/2"	1/2"	3/4"	17 mm
13 - 10130	2	VIP2875-3.190	1-3/4"	2-7/8"	1/2"	3/4"	17 mm
13 - 10131	2	VIP3000-3.316	1.96"	3"	1/2"	11/16"	17 mm
13 - 10132	2	VIP3480-3.765	2-37/64"	3-31/64"	1/2"	11/16"	17 mm
13 - 10133	2	VIP3560-3.585	2-1/2"	3-9/16"	37/64"	25/32"	17 mm
13 - 10134	2	VIP4000-4.316	2-5/8"	4"	1/2"	7/8"	17 mm
13 - 10135	2	VIP3000-3.105	1-51/64"	3"	41/64"	13/16"	17 mm
13 - 10136	2	VIP3470-3.575	2-17/64"	3-37/64"	41/64"	13/16"	17 mm
13 - 10137	2	VIP4000-4.105	2-51/64"	4"	41/64"	13/16"	17 mm

13

PULLEYS

PULLEYS



Steel V Belt Pulleys



*Replacement for K&S No. 5230 Lawn Edger Trim-All.

- Designed for 1/2" Section V Belts
- Lightweight - more strength per pound
- Machined steel hubs
- Precision broached for true running performance
- Standard keyway - 1/8" or 3/16" according to size

Order No.	OD	ID	Keyway
13 - 750 *	2-1/4"	3/8"	1/8"
13 - 751	2"	1/2"	1/8"
13 - 752	2"	5/8"	3/16"
13 - 753	2-1/4"	1/2"	1/8"
13 - 754	2-1/4"	5/8"	3/16"
13 - 755	2-1/2"	1/2"	1/8"
13 - 756	2-1/2"	5/8"	3/16"
13 - 757	3"	1/2"	1/8"
13 - 758	3"	5/8"	3/16"
13 - 759	3"	3/4"	3/16"
13 - 760	3-1/4"	1/2"	1/8"
13 - 761	3-1/4"	5/8"	3/16"
13 - 762	3-1/4"	3/4"	3/16"

Order No.	OD	ID	Keyway
13 - 763	3-1/2"	1/2"	1/8"
13 - 764	3-1/2"	5/8"	3/16"
13 - 765	3-1/2"	3/4"	3/16"
13 - 766	4"	1/2"	1/8"
13 - 767	4"	5/8"	3/16"
13 - 768	4"	3/4"	3/16"
13 - 769	3"	7/8"	3/16"
13 - 770	3-1/2"	7/8"	3/16"
13 - 771	4"	7/8"	3/16"
13 - 772	3"	1"	1/4"
13 - 773	3-1/2"	1"	1/4"
13 - 774	4"	1"	1/4"

Edger Pulley



Order No.	Sec.	OD	Pitch ID	Diam.
13 - 1261	Grove	2"	3/4"	1.85

Idler Assortment



Order No. 01 - 717

This assortment contains 24 Idlers with hooks and display board. For a complete listing see Section 01/02.

13 PULLEYS



Heavy Duty Cast Iron Pulleys



Order No.	Desc.	Key-way	Order No.	Desc.	Key-way
13 - 5961	2" OD x 1/2" ID	1/8"	13 - 5979	3" OD x 7/8" ID	3/16"
13 - 5962	2" OD x 5/8" ID	3/16"	13 - 5879	3" OD x 3/4" ID	3/16"
13 - 5963	2" OD x 3/4" ID	3/16"	13 - 5880	3" OD x 1" ID	1/4"
13 - 5964	2-1/4" OD x 1/2" ID	1/8"	13 - 5980	3-1/2" OD x 1/2" ID	1/8"
13 - 5965	2-1/4" OD x 5/8" ID	3/16"	13 - 2186	3-1/2" OD x 5/8" ID	3/16"
13 - 5966	2-1/4" OD x 3/4" ID	3/16"	13 - 5982	3-1/2" OD x 3/4" ID	3/16"
13 - 5967	2-1/4" OD x 7/8" ID	3/16"	13 - 5983	3-1/2" OD x 7/8" ID	3/16"
13 - 5968	2-1/2" OD x 1/2" ID	1/8"	13 - 5984	3-1/2" OD x 1" ID	1/4"
13 - 5969	2-1/2" OD x 5/8" ID	3/16"	13 - 5985	4" OD x 1/2" ID	1/8"
13 - 5970	2-1/2" OD x 3/4" ID	3/16"	13 - 5881	4" OD x 5/8" ID	3/16"
13 - 5971	2-1/2" OD x 7/8" ID	3/16"	13 - 5882	4" OD x 3/4" ID	3/16"
13 - 5973	2-3/4" OD x 5/8" ID	3/16"	13 - 5986	4" OD x 7/8" ID	3/16"
13 - 5974	2-3/4" OD x 3/4" ID	3/16"	13 - 5883	4" OD x 1" ID	1/4"
13 - 5975	2-3/4" OD x 7/8" ID	3/16"	13 - 5884	5" OD x 3/4" ID	3/16"
13 - 5976	2-3/4" OD x 1" ID	1/4"	13 - 5885	5" OD x 1" ID	1/4"
13 - 5977	3" OD x 1/2" ID	1/8"	13 - 5886	5-3/4" OD x 5/8" ID	3/16"
13 - 5978	3" OD x 5/8" ID	3/16"	13 - 5887	5-3/4" OD x 3/4" ID	3/16"
			13 - 5997	6" OD x 1" ID	1/4"

Replacement Idlers for MURRAY (With Heavy Duty Bearings)



Order No.	Part No.	OD	ID	Belt Groove	Type
13 - 2915	23339	4"	1/2"	7/8"	Flange
13 - 2916	21409	3-1/4"	1/2"	7/8"	Flange
13 - 2917	23238	4-9/16"	1/2"	3/4"	Flange
13 - 2918	20613	3"	1/2"	3/8"	V
13 - 2919	23211	3-3/4"	1/2"	1/2"	V
13 - 3236	90118	4-3/4"	1/2"	7/8"	Flange

PULLEYS



Bushing Assortment for Idler Pulleys



Order No. 01 - 7842

This assortment contains 12 (total of 114) popular size reducer bushings used in most Idler pulley applications.

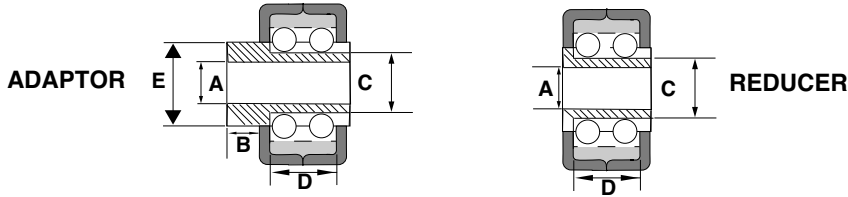

CONTENTS

Order No.	Qty.	Description	A	B	C	D	E	
13 - 10965	10	Adaptor	0.313	.39	17mm	12mm	.81	MIN010
13 - 10966	10	Adaptor	0.375	.27	17mm	12mm	.81	MIN010
13 - 7846	10	Adaptor	0.375	.31	17mm	12mm	.81	MIN010
13 - 7847	10	Adaptor	0.375	.41	17mm	12mm	.81	MIN010
13 - 7849	10	Adaptor	0.375	.46	17mm	12mm	.81	MIN010
13 - 10967	10	Adaptor	0.375	.51	17mm	12mm	.81	MIN010
13 - 10969	7	Adaptor	0.375	.59	17mm	12mm	.81	MIN010
13 - 7850	10	Adaptor	0.50	.27	17mm	12mm	.81	MIN010
13 - 7848	7	Adaptor	0.50	.76	17mm	12mm	.81	MIN010
13 - 7851	10	Reducer	0.375	N/A	17mm	12mm	N/A	MIN010
13 - 10964	10	Reducer	12mm	N/A	17mm	12mm	N/A	MIN010
13 - 7852	10	Reducer	0.50	N/A	17mm	12mm	N/A	MIN010

PULLEYS

Idler Pulley Bushings



Order No. 13 - 10964
Idler pulley bushing, ID 12mm, OD 17mm, HT 12mm.
MIN010



Order No. 13 - 10966
Idler pulley bushing, ID .375", Shoulder Height .270", fits 17mm bearing.
MIN010



Order No. 13 - 10967
Idler pulley bushing, ID .375", Shoulder Height .510", fits 17mm bearing.
MIN010



Order No. 13 - 10965
Idler pulley bushing, ID .313", Should Height .39", fits 17mm bearing.
MIN010



Order No. 13 - 10969
Idler pulley bushing, ID .375", Shoulder Height .59", fits 17mm bearing.
MIN010



PULLEYS

Idler Pulley for AYP



ID 3/8"
OD 3-1/2"
Height 1-1/2"

Order No. 13 - 13179

Idler pulley replaces AYP 194327. Composite Plastic.

Idler Pulley for AYP



ID 3/8"
OD 3-1/2"
Height 1-5/16"

Order No. 13 - 13178

Idler pulley replaces AYP 194326. Composite Plastic.

Idler Pulley for AYP



ID 3/8"
OD 5-3/8"
Height 1-5/8"

Order No. 13 - 13175

Idler pulley replaces AYP 196106. Painted version of AYP 197379.

Idler Pulley for AYP



ID 3/8"
OD 3-7/8"
Height 3/4"

Order No. 13 - 9376

Deck Idler pulley replaces AYP 131494. Fits AYP, Sears, Roper.

Idler Pulley for AYP



ID 3/8"
OD 4-1/4"
Height 1"

Order No. 13 - 7157

Idler Pulley. Replaces AYP 105313X. Fits 36" and 42" decks.

Flat Idler Pulley for AYP



ID 3/8"
OD 4-5/8"
Height 7/8"

Order No. 13 - 9377

Flat Idler pulley replaces AYP 102403x. Includes high speed bearing with double seals. For heavy load applications.

Idler Pulley for AYP



ID 3/8"
OD 3-1/2"
Height 1-1/8"

Order No. 13 - 9849

Heavy duty Deck Belt V-Idler pulley replaces AYP 139245. Fits AYP & Husqvarna riding mowers.

Idler Pulley for AYP



ID 3/8"
OD 2"
Height 3/8"

Order No. 13 - 10128

Idler pulley replaces AYP 166042. Belt idler for self-propelled walk behind mowers. Composite: glass filled nylon.

Idler Pulley for AYP



ID 3/8"
OD 3"
Height 1-1/8"

Order No. 13 - 10396

Deck Belt V-Idler pulley replaces AYP 139123. Fits AYP riding mowers.

Idler Pulley for AYP



ID 1/2"
OD 1-7/8"
Height 5/8"

Order No. 13 - 9846

Idler pulley replaces AYP 166043. Composite: glass filled nylon.

Idler Pulley for AYP



ID 3/8"
OD 3-7/8"
Height 1-1/4"

Order No. 13 - 11632

Idler pulley replaces AYP 173437. Fits 42" Decks from 2000-up.

Idler Pulley for AYP



ID 3/8"
OD 4-1/2"
Height 1-1/16"

Order No. 13 - 11633

Idler pulley replaces AYP 175820. Fits 48" Decks from 2000-up.

13

PULLEYS

PULLEYS



Idler Pulley for AYP



ID 3/8"
OD 4-3/8"
Height 1-29/64"

Order No. 13 - 12661

Idler pulley replaces AYP 173901 & 156493. Fits 46" decks.

Idler Pulley for AYP



ID 3/8"
OD 3-1/2"
Height 2-1/8"

Order No. 13 - 12644

Idler pulley replaces AYP 179114.

Idler Pulley for AYP



ID 3/8"
OD 4-1/4"
Height 11/16"

Order No. 13 - 12620

Idler pulley replaces AYP 146763. Fits 46" decks.

Idler Pulley for AYP



ID 3/8"
OD 4-1/2"
Height 1-3/16"

Order No. 13 - 11635

V-Idler pulley replaces AYP 189993. Fits 48" Decks from 2005-up.

Idler Pulley for AYP



ID 3/8"
OD 3-7/8"
Height 1-9/16"

Order No. 13 - 11634

Idler pulley replaces AYP 177968. Fits 48" Decks from 2001-up.

Idler Pulley for AYP



ID 3/8"
OD 2-1/2"
Height 1"

Order No. 13 - 13622

Idler pulley replaces AYP 165626, Husqvarna 532165626, Grasshopper 393312. Fits Grasshopper models 718, 720, 725, 725K and 928D. Composite plastic Idler pulley. Belt groove 1/2".

Splined Pulley for AYP



ID 5/8" splined
OD 4-5/8"
Height 7/8"

Order No. 13 - 9121

Splined pulley replaces AYP 153531. Fits 36" & 46" cut mowers. Double Hex ID.

Idler Pulley for AYP



ID 3/8"
OD 5-1/2"
Height 1-9/16"

Order No. 13 - 12061

Idler pulley replaces AYP 187284.

Splined Pulley for AYP



Splined ID 5/8"
OD 4-7/8"
Height 1-3/8"

Order No. 13 - 12513

Splined pulley replaces AYP 174375. Fits 48" decks.

Splined Pulley for AYP



Splined ID 5/8"
OD 5-1/2"
Height 59/64"

Order No. 13 - 12456

Splined pulley replaces AYP 198145. Fits Ayp, Craftsman, Dixon.

13

PULLEYS



PULLEYS

Idler Pulley for AYP



ID 5/16"
OD 2-1/2"
Height 1/2"

Order No. 13 - 12385

Idler pulley replaces AYP 199532 & 179050. Export Only.

Spindle Pulley for AYP



ID 5/8" splined
OD 4"
Height 1-1/2"

Order No. 13 - 12428

Spindle pulley replaces AYP 144917. Fits spindles on 46" decks.

Spindle Pulley for AYP



ID 5/8" splined
OD 6-1/4"
Height 7/8"

Order No. 13 - 12378

Spindle pulley replaces AYP 195945. Fits newer 42" & 46" decks.

Engine Pulley for AYP



ID 1" step down to 3/4"
Top OD 3-1/2"
Bottom OD 5-1/2"
Height 5-3/8"

Order No. 13 - 12271

Engine pulley replaces AYP 140186 & 532140186.

Spindle Pulley for AYP



ID 5/8" splined
OD 5-3/16"
Height 7/8"

Order No. 13 - 7180

Spindle Pulley. Replaces AYP 153535, 129861, 173436, 177865. Fits 42" deck models 7147A29, 7167A29 and 7147B29.

Deck Pulley for AYP



ID 41/64" splined
OD 4-13/16"
Height 31/32"

Order No. 13 - 9148

Steel deck pulley replaces AYP 153532 & 129206. Fits 38" cut mowers. Double Hex ID.

Idler Pulley for BAD BOY



ID 1/2"
OD 5-3/4"
Height 2-23/64"

Order No. 13 - 12722

Idler pulley replaces Bad Boy 033-5001-00.

Idler Pulley for BAD BOY



ID 1/2"
OD 4-3/4"
Height 1-1/4"

Order No. 13 - 9891

Idler pulley replaces Bad Boy 033-6001-00. Heavy Duty.

Idler Pulley for BOBCAT



ID 3/8"
OD 4"
Height 1-9/16"

Order No. 13 - 7813

Idler Pulley. Replaces Bobcat 38184-2. Idler for double "V" drive wheel pulley to gear and positive drive. Fits 36", 48", 54" and 61" midsize.

Deck Idler for BOBCAT



ID 3/8"
OD 4-5/8"
Height 11/16"

Order No. 13 - 5714

Mower Blade Deck Idler. Replaces Bobcat 2306005 and 380101A, Exmark 403009, Gravely 21060, Scag 48068 Belt Guide Idler. Also replaces Snapper 7076688 & 7076500.

13

PULLEYS

PULLEYS



Idler Pulley for BOBCAT



ID 3/8"
OD 3-1/32"
Height 7/8"

Order No. 13 - 2188

Flat Idler. Replaces Bobcat 38010-2A, Bunton PALO368A, John Deere PT 8649, Snapper/Kees 76520. See Flat Idler Section for measurements.

Pulley for BOBCAT



ID 2-5/16"
OD 8-7/8"
Height 1/2"

Order No. 13 - 6997

Pulley. Replaces Bobcat 36271.

Spindle Pulley for BOBCAT



ID 1"
OD 5-3/4"
Height 1-5/8"
Keyway 1/4"

Order No. 13 - 2185

Spindle Pulley. Replaces Bobcat 31011B, Snapper 7076398, Exmark 303073, Kees 976398.

Jackshaft Pulley for BOBCAT



ID 5/8"
OD 3-1/2"
Height 1-5/16"
Keyway 3/16"

Order No. 13 - 2186

Jackshaft Pulley. Replaces Ransomes/Bobcat 38456, 38018N, Bunton PLO 636, Snapper 7057582 & 7077285.

Transmission Pulley for BOBCAT



ID 5/8"
OD 5"
Height 1-5/16"
Keyway 3/16"

Order No. 13 - 2187

Transmission Pulley. Replaces Bobcat 38022B.

Engine and Spindle Pulley for BOBCAT



ID 1"
OD 5-3/4"
Height 1-3/16"
Keyway 1/4"

Order No. 13 - 5991

Replaces Bobcat 31012A, 31008B. Engine pulley without set screws and 31008B Spindle Pulley with (2) set screws.

Double Pulley for BOBCAT



ID 5/8"
OD 3-7/16"
Height 1-1/4"
Keyway 3/16"

Order No. 13 - 6607

Double pulley. Replaces Bobcat 38232. Fits 36" mid-size. Transmission to wheel.

Double Pulley for BOBCAT



ID 5/8"
OD 3-7/16"
Height 1-13/16"
Keyway 3/16"

Order No. 13 - 6608

Double pulley. Replaces Bobcat 38183. Fits 48" mid-size. Transmission to wheel.

Variable Speed Pulley for BOBCAT



ID 1" to 1/2"
OD 5"
Height 3-1/2"
Keyway 1/4"

Order No. 13 - 2184

Variable Speed Pulley. Replaces Ransomes/Bobcat 38140 & 38089N.

Idler Pulley for BUNTON



ID 3/8"
OD 3-1/2"
Height 1-1/2"

Order No. 13 - 8005

Idler pulley replaces Bunton PL 4274. Fits Bunton, Goodall, Exmark and Bobcat mid size commercial mowers with double wide drive belt.

13

PULLEYS



PULLEYS



ID 3/8"
OD 4"
Height 1"

Order No. 13 - 5869

Replaces Bunton PLO 786, John Deere AM106564, PT-8761 and MTD 756-0293. Used on 32", 36", 40", 48" and 52" decks. See V-Belt Idlers for measurements.



ID 3/8"
OD 4-1/2"
Height 1-5/32"

Order No. 13 - 7861

Blade Belt Idler replaces Bunton PL 8036A. Fits 48" and 52" mid size hydro and BHC front engine riders.



ID 3/8"
OD 4-7/8"
Height 1-5/32"

Order No. 13 - 7918

Idler pulley replaces Bunton PL 8540A. Fits Bunton 61" & 71" cut Hydro Rider Commercial Machine models.

Idler Pulley for CUB CADET



ID 3/8"
OD 4.88"
Height 1"

Order No. 13 - 12277

Idler pulley replaces Cub Cadet 01004101.

Idler Pulley for CUB CADET



ID 3/8"
OD 5"
Height 1-1/8"

Order No. 13 - 12275

Idler pulley replaces Cub Cadet 756-3045.

Spindle Pulley for CUB CADET



ID 12 point Hex"
OD 5-9/16"
Height 5/8"

Order No. 13 - 12884

Spindle pulley replaces Cub Cadet 756-1188. Fits our 10-12883 Spindle.

Idler Pulley for CUB CADET



ID 3/8"
OD 4-1/4"
Height 3/4"

Order No. 13 - 12276

Idler pulley replaces Cub Cadet 01004081.

Spindle Pulley for CUB CADET



ID 5/8"
OD 6-5/16"
Height 5/8"

Order No. 13 - 12682

Idler pulley replaces Cub Cadet 756-1227. Fits 42" decks on models LT1000 series 2007 and after. Fits Cub Cadet 618-0624 spindle.

Idler Pulley for CUB CADET



ID 3/8"
OD 4-29/32"
Height 1-13/64"

Order No. 13 - 13409

Idler pulley replaces Cub Cadet 756-1229. Also replaces 2005077 & 1004081. Fits LT series and RZT series decks.

Spindle Pulley for CUB CADET



ID 12 pt
OD 4"
Height 1"



Order No. 13 - 11711

Spindle pulley replaces Cub Cadet 756-04216. S9G-545 x 12 pt Hex Ch. Fits our 10-14329 spindle.

13

PULLEYS

PULLEYS



**Idler Pulley for
DIXIE CHOPPER**

ID 1/2"
OD 4-3/4"
Height 1-1/4"



Order No. 13 - 9891

Idler pulley replaces Dixie Chopper 30224. Heavy Duty.

**Idler Pulley for
DIXIE CHOPPER**

ID 5/8"
OD 4-3/8"
Height 1"



Order No. 13 - 9895

V-Belt Idler pulley replaces Dixie Chopper 30234, Toro 65-5940. Heavy duty riveted pulley.

**Deck Pulley for
DIXIE CHOPPER**

ID 1"
OD 6"
Height 1-1/8"



Order No. 13 - 13426

Deck pulley replaces Dixie Chopper 300037.

**Idler Pulley for
DIXIE CHOPPER**

ID 5/8"
OD 5-1/4"
Height 1-1/4"



Order No. 13 - 13502

Idler pulley replaces Dixie Chopper 97319. Deck drive tensioner/stationary Idler, c-section v-Idler pulley. Fits XWD series diesel units.

**Deck Pulley for
DIXIE CHOPPER**

ID 1"
OD 5-1/4"
Height 1-13/32"



Order No. 13 - 13427

Deck pulley replaces Dixie Chopper 9907525X100S. Fits 60" decks.

**Idler Pulley for
DIXIE CHOPPER**

ID 23/32"
OD 4"
Height 41/64"



Order No. 13 - 13413

Deck pulley replaces Dixie Chopper 300401.

**Pump Pulley for
DIXIE CHOPPER**

ID 19/32"
OD 5-3/4"
Height 1-3/4"



Order No. 13 - 13423

Pump pulley replaces Dixie Chopper 200031. Fits LT models.

**Idler Pulley for
DIXIE CHOPPER**

ID 5/8"
OD 3-3/4"
Height 1"



Order No. 13 - 13424

Idler pulley replaces Dixie Chopper 200238. Fits Iron Eagle 2044, 2350, 2560.

**Idler Pulley for
DIXIE CHOPPER**

ID 1/2"
OD 3-3/4"
Height 1-1/4"



Order No. 13 - 13425

Idler pulley replaces Dixie Chopper 200239. Fits LT models.

13

PULLEYS



PULLEYS

Idler Pulley for DIXON



ID 1/2"
OD 4-1/2"
Height 1"

Order No. 13 - 9378

Flat idler pulley replaces Dixon 1687, 539115278. Main drive pulley on Dixon mowers.

Idler Pulley for DIXON



ID 1/2"
OD 2"
Height 1"

Order No. 13 - 9379

Chain idler pulley replaces Dixon 1713, 539124278. Used on Dixon cone drive models. Plastic

Idler Pulley for EXMARK



ID 11/16"
OD 3-1/8"
Height 3/4"

Order No. 13 - 12301

Idler pulley replaces Exmark 109-3397. Fits Quest models.

Idler Pulley for EXMARK



ID 3/8"
OD 2-3/4"
Height 1"

Order No. 13 - 12300

Idler pulley replaces Exmark 109-4076. Fits Laser Z & Frontrunner models.

Idler Pulley for EXMARK



ID 11/16"
OD 4"
Height 3/4"

Order No. 13 - 12302

Idler pulley replaces Exmark 109-4077. Fits Quest models.

Idler Pulley for EXMARK



ID 21/32"
OD 6-3/4"
Height 1-3/16"

Order No. 13 - 9864

Idler pulley replaces Exmark 1-633109. Fits 52", 60" & 72" deck belts on Lazer Z units.

Idler Pulley for EXMARK



ID 3/8"
OD 2-3/4"
Height 1-3/8"

Order No. 13 - 9753

Idler pulley replaces Exmark 1-323285. Also replaces Yazoo Kees 639-19087.

Idler Pulley for EXMARK



ID 11/16"
OD 5-3/4"
Height 2-1/2"

Order No. 13 - 11815

Idler pulley replaces Exmark 1-413099.

Spindle Pulley for EXMARK



Order No. 13 - 12793

Spindle pulley replaces Exmark 1-653386. Fits Lazer Z CT 52" spindles. ID .985", OD 6-3/4", Height 1".

Order No. 13 - 12715

Spindle pulley replaces Exmark 1-653099. Fits Lazer Z CT 44" spindles. ID .985", OD 6", Height 1".

Order No. 13 - 12317

Spindle pulley replaces Exmark 1-413424. Fits Lazer Z CT 48" spindles. ID .985", OD 6-1/4", Height 1".

V-Idler Pulley for EXMARK



ID 3/8"
OD 3-15/16"
Height 29/32"

Order No. 13 - 13013

V-Idler pulley replaces Exmark 1-303516.

Idler Pulley for EXMARK



ID 11/16"
OD 4-7/8"
Height 3/4"

Order No. 13 - 11658

Idler pulley replaces Exmark 1-603843. Fits 32-48" Viking Hydros. Heavy Duty.

13

PULLEYS

PULLEYS



Flat Idler Pulley for EXMARK

ID 11/16"
OD 5-1/2"
Height 1-1/8"



Order No. 13 - 10397

Flat idler pulley replaces Exmark 1-613098. Fits floating deck walkbehind units.

Idler Pulley for EXMARK

ID 11/16"
OD 6"
Height 1-1/8"



Order No. 13 - 9793

Idler pulley replaces Exmark 1-633166. Idler pulley replaces Husqvarna 539102657. Fits mid mount "ZERO TURN" commercial riders. Also replaces Yazoo/Kees 102657.

Idler Pulley for EXMARK

ID 3/8"
OD 3-1/8"
Height 1-3/16"



Order No. 13 - 9794

Idler pulley replaces Exmark 1-633167. Pump drive belt idler for Lazer Z model.

Spindle Pulley for EXMARK

ID 7/8"
OD 6-1/2"
Height 1-1/4"



Order No. 13 - 10960

Spindle pulley replaces Exmark 1633701. Fits Lazer Z model numbers 150000 thru 259999. Fits our 10-10353 spindle assembly.

Wheel Drive Pulley for EXMARK

ID 1-21/32"
OD 9"
Height 13/16"



Order No. 13 - 7711

Wheel drive pulley. Replaces Exmark 1-303464. Fits Exmark 48" mid size.

Idler Pulley for EXMARK

ID 11/16"
OD 5"
Height 1-1/8"



Order No. 13 - 9772

Idler pulley replaces Exmark 1-603805. Deep V idler pulley fits Lazer Z.

Transmission Pulley for EXMARK

ID 1"
OD 2-3/4"
Height 1-1/8"
Keyway 1/4"



Order No. 13 - 9771

Transmission pulley replaces Exmark 1-323256. Fits 36" & 48" commercial walkbehind mowers. Uses a 1/2" belt. 1 set screw.

Transmission Drive Pulley for EXMARK

ID 1"
OD 4-1/2"
Height 1-1/4"
Keyway 1/4"



Order No. 13 - 9262

Transmission drive pulley replaces Exmark 1-323070. Fits 36, 48 & 52" cut, 5 speed Viking & Metro series, commercial mid-size walkbehind mowers. Cast iron pulley.

13

PULLEYS



PULLEYS

Engine Pulley for EXMARK

ID 1"
OD 6-1/4"
Height 1-1/4"
Keyway 1/4"



Order No. 13 - 9770

Engine pulley replaces Exmark 1-303498. Fits 36" commercial walkbehind mowers. Uses a 5/8" belt. 2 set screws.

Idler Pulley for GRASSHOPPER

ID 3/8"
OD 5"
Height 1-1/8"



Order No. 13 - 13417

Idler pulley replaces Grasshopper 393376.

Idler Pulley for FERRIS

ID 1/2"
OD 6-3/4"
Height 1-1/2"



Order No. 13 - 12472

Idler pulley replaces Ferris 5021976.

Idler Pulley for GRASSHOPPER

ID 1/2"
OD 4-5/8"
Height 31/32"



Order No. 13 - 7937

Idler pulley replaces Grasshopper 393225. Fits models from 1984 thru 1994, 44", 48" and 52" decks (2 per deck). Composite: glass filled nylon.

PTO Pulley for GRASSHOPPER

ID 1"
OD 5-1/2"
Height 1-29/32"
Keyway 1/4"



Order No. 13 - 8093

PTO pulley replaces Grasshopper 415650. Fits models 718, 720, 721 and 725. Cast Iron 1/4" keyway.

Flat Idler Pulley for GRAVELY

ID 3/8"
OD 4-1/2"
Height 2"



Order No. 13 - 2189

Flat Idler. Replaces Gravelly 34286. See Flat Idler Section for measurements.

Idler Pulley for GRAVELY

ID 3/8"
OD 4-3/4"
Height 2"



Order No. 13 - 12411

Idler pulley replaces Gravelly 073278.

Deck Idler for GRAVELY

ID 1/2"
OD 6-3/4"
Height 3/4"



Order No. 13 - 7176

Deck Idler. Replaces Gravelly 22063. Fits Pro Master 60" cut mowers.

Idler Pulley for GREAT DANE

ID 3/8"
OD 5-7/8"
Height 1-25/32"



Order No. 13 - 13127

Idler pulley replaces Great Dane D18032.

Idler Pulley for GREAT DANE

ID 3/8"
OD 5-1/16"
Height 3/4"



Order No. 13 - 9755

Idler pulley replaces Great Dane D18044, D18048.

Idler Pulley for GREAT DANE

ID 3/8"
OD 4"
Height 1-3/8"



Order No. 13 - 9756

Idler pulley replaces Great Dane D18314.

13

PULLEYS

PULLEYS



Spindle Pulley for GREAT DANE



ID 7/8" splined
OD 5-3/4"
Height 1-1/8"

Order No. 13 - 10079

Spindle pulley replaces Great Dane D18084. Long hub. 12 splined.

Idler Pulley for GREAT DANE



ID 3/8"
OD 5"
Height 7/8"

Order No. 13 - 10160

Idler pulley replaces Great Dane D18031 and Scag 482217. Fits Surfer, C hariot & Scamper models.

Idler Pulley for GREAT DANE



ID 3/8"
OD 5-7/8"
Height 3-1/8"

Order No. 13 - 10168

Blade drive idler pulley replaces Great Dane D28105. Fits Chariot models.

Spindle Pulley for GREAT DANE



ID 7/8" splined
OD 5-3/4"
Height 3/4"

Order No. 13 - 10161

Drive pulley replaces Great Dane D18083. Short hub. 12 splined

Idler Pulley for HUSQVARNA



ID 17 mm
OD 5"
Height 1-1/4"

Order No. 13 - 9868

Idler pulley replaces Husqvarna 539102652. Fits mid mount "ZERO TURN" commercial riders. Also replaces Yazoo/Kees 102652.

Idler Pulley for HUSQVARNA



ID 5/8"
OD 5-3/4"
Height 1-3/4"

Order No. 13 - 12473

Idler pulley replaces Husqvarna 539-103257.

Idler Pulley for HUSQVARNA



ID 5/8"
OD 5-3/4"
Height 2"

Order No. 13 - 12474

Idler pulley replaces Husqvarna 539-103258.

Idler Pulley for HUSTLER



ID 11/16"
OD 3-1/8"
Height 3/4"

Order No. 13 - 12299

Idler pulley replaces Hustler 794404. Fits Mini FasTrak & Mini Z.

Idler Pulley for HUSTLER



ID 11/16"
OD 5"
Height 1-1/4"

Order No. 13 - 12297

Idler pulley replaces Hustler 784504. Fits FasTrak & Mini FasTrak.

Deck Drive Pulley for HUSTLER



Splined ID 15/16"
OD 5-13/16"
Pulley Width 7/8"

Order No. 13 - 11446

Deck drive pulley replaces Hustler 783571.

Idler Pulley for HUSTLER



ID 11/16"
OD 4"
Height 3/4"

Order No. 13 - 12298

Idler pulley replaces Hustler 784827. Fits FasTrak & Mini

13

PULLEYS



PULLEYS

Deck Drive Pulley for HUSTLER

Splined ID 15/16"
OD 5-3/4"
Pulley Width 1-3/16"



Order No. 13 - 11447

Deck drive pulley replaces Hustler 486889.

Idler Pulley for HUSTLER

ID 11/16"
OD 6-3/4"
Height 1-1/2"



Order No. 13 - 10226

Flat idler pulley replaces Hustler 781385. Fits 52", 60" & 72" Super Z deck assembly.

Idler Pulley for HUSTLER

ID 11/16"
OD 5-1/2"
Height 1-5/16"



Order No. 13 - 10227

Flat idler pulley replaces Hustler 781856. Fits 52", 60" & 72" Super Z drive units.

Idler Pulley for HUSTLER

ID 11/16"
OD 5-3/4"
Height 1-5/16"



Order No. 13 - 12696

Idler pulley replaces Hustler 781856. New style, replaces our 13-10227 pulley.

Idler Pulley for JOHN DEERE

ID 21/32"
OD 3-11/32"
Height 1"



Order No. 13 - 9544

Idler pulley replaces John Deere GX20287. Fits L120 series 20 hp 48" deck & L130 series 23 hp 48" deck.

Idler Pulley for JOHN DEERE

ID 11/16"
OD 3-5/8"
Height 1-3/16"



Order No. 13 - 10741

Idler pulley replaces John Deere GY20067. Also fits Sabre models: 14542GS, 1642HS, 1742HS, 17542HS lawn tractors. Scotts models: L1742, L17542, L2048 & L2548 lawn tractors.

Idler Pulley for JOHN DEERE

ID 43/64"
OD 5-7/32"
Height 1-23/32"



Order No. 13 - 11207

Idler pulley replaces John Deere GY20629. Fits L120, L130 lawn tractors. Fits G110 Garden Tractor.

Idler Pulley for JOHN DEERE

ID 11/16"
OD 5"
Height 1"



Order No. 13 - 12419

Idler pulley replaces John Deere AM106627.

Idler Pulley for JOHN DEERE

ID 11/16"
OD 4"
Height 11/16"



Order No. 13 - 12427

Idler pulley replaces John Deere AM37249.

Idler Pulley for JOHN DEERE

ID 11/16"
OD 5-1/4"
Height 1-9/16"



Order No. 13 - 10737

Idler pulley replaces John Deere GY20110. Fits S100-S130 series 42" & 48" deck. Also fits Sabre models: 14542GS, 1642HS, 1742HS, 17542HS lawn tractors. Scotts models: L1742, L17542, L2048 & L2548 lawn tractors.

Idler Pulley for JOHN DEERE

ID 13/32"
OD 3-1/2"
Height 1-1/32"



Order No. 13 - 14241

Idler pulley replaces John Deere AM115459. Fits series LX, GX and Sabre models. Composite. 3/4" belt groove.

13

PULLEYS

PULLEYS



Idler Pulley for JOHN DEERE

ID 21/32"
OD 2-7/8"
Height 29/32"



Order No. 13 - 14240

Idler pulley replaces John Deere AM115460. Fits EZ Trak, LX, GT, X300R and others. Composite. 3/8" belt groove.

Idler Pulley for JOHN DEERE

ID 21/32"
OD 5-1/4"
Height 1-1/4"



Order No. 13 - 14242

Idler pulley replaces John Deere AM135526. Fits X300 series.

Idler Pulley for JOHN DEERE

ID 13/32"
OD 3-27/32"
Height 1-3/8"



Order No. 13 - 14255

Idler pulley replaces John Deere AM135773. Fits X Series, LA Series, L Series, 105, 115, 145, and 155C models.

Spindle Pulley for JOHN DEERE

ID 19/32"
OD 7"
Height 7/8"



Order No. 13 - 11449

Spindle pulley replaces John Deere GX20367. Fits models 14,442GS, 1642GS, 1642HS, 1742HS, 17.542HS Sabre Lawn Tractors. Models L1742, L17542 Scott Tractors, Models 108-17HS, 108-14.5 SABO Lawn Tractors, and L100, L111, L105, L107, L118, L111 and L108 Lawn Tractors.

V-Belt Idler Pulley for JOHN DEERE

ID 11/16"
OD 2-7/8"
Height 21/32"



Order No. 13 - 10738

V-Belt idler pulley replaces John Deere GX20286. Also fits Sabre models: 14542GS, 1642HS, 1742HS, 17542HS lawn tractors. Scotts models: L1742, L17542, L2048 & L2548 lawn tractors.

Idler Pulley for MTD

ID 3/8"
OD 3-1/16"
Height 2"



Order No. 13 - 14326

Idler pulley replaces MTD 756-04325. V-Idler pulley.

Idler Pulley for MTD/CUB CADET

ID 3/8"
OD 5"
Height 1-7/16"



Order No. 13 - 14090

Idler pulley replaces MTD/Cub Cadet 756-3062. Fits RZT 22 models.

Idler Pulley for MTD/CUB CADET

ID 3/8"
OD 4"
Height 1-3/8"



Order No. 13 - 14091

Idler pulley replaces MTD/Cub Cadet 756-0542. Fits Cub Cadet Z-Force models with 42" decks.

Idler Pulley for MTD

ID 3/8"
OD 4-1/8"
Height 1-3/64"



Order No. 13 - 11144

Idler pulley replaces MTD 956-0365. Fits 46" deck & 44" rear discharge deck series 600, 700 & 800. Fits Deck H, used 1985 - 1994. (steel)

Idler Pulley for MTD

ID 3/8"
OD 4"
Height 1-1/8"



Order No. 13 - 8602

Idler pulley replaces MTD 756-0627. Fits 46" cut front engine rider. Blade idler models 144P820H000 thru 144P849H000. Composite: glass filled nylon.

13

PULLEYS



PULLEYS

Flat Idler Pulley for MTD



ID 3/8"
OD 4"
Height 1-7/32"

Order No. 13 - 8588

Flat idler pulley replaces MTD 756-0437, 956-0437. Fits MTD series 600 tractor.

Idler Pulley for MTD



ID 3/8"
OD 1-1/2"
Height 1/2"

Order No. 13 - 10672

Idler pulley replaces MTD 753-0518. Fits self propelled walk-behind mowers. Includes hex bolt and bearing.

Deck Pulley for MTD



ID 1-9/16"
OD 5"
Height 3-1/4"

Order No. 13 - 9708

Deck pulley (double pulley) replaces MTD 756-0638. Fits yard machines model series 690-699 hydrostatic lawn tractors. Uses our 09-483 bearing.

Transmission Pulley for MTD



Splined ID 5/8"
OD 7-1/4"
Height 5/8"

Order No. 13 - 12810

Transmission pulley replaces MTD 756-04002. Fits 13A, B & C series riders. Spun steel, 6 slot star ID.

Deck Pulley for MTD



ID 12 point spline
OD 5-3/4"
Height 1"

Order No. 13 - 9587

Deck pulley replaces MTD 756-0980. Fits 600 series mowers.

Deck Pulley for MTD



ID 12 point spline
OD 5"
Height 1"

Order No. 13 - 9588

Deck pulley replaces MTD 756-0969. Fits 600 series mowers.

Idler Pulley for MTD



ID 3/8"
OD 5-3/4"
Height 1-3/8"

Order No. 13 - 12613

Idler pulley replaces MTD 756-3105 / 956-3105. Fits 54" cut decks.

Idler Pulley for MTD



ID 3/8"
OD 3-1/8"
Height 1"

Order No. 13 - 12891

Idler pulley replaces MTD 756-04224, 756-0981.

Blade Spindle Pulley for MTD



ID 3/4" splined
OD 5"
Height 2-1/2"

Order No. 13 - 8657

Blade spindle pulley replaces MTD 756-0486. Fits 38" & 36" MTD F Deck 600 series tractor. Used on our 10-7156.

Idler Pulley for MTD



ID 3/8"
OD 4-1/4"
Height 1-1/8"

Order No. 13 - 12675

Idler pulley replaces MTD 756-04129.

13

PULLEYS

PULLEYS



Spindle Pulley for MTD

ID 3/4" splined
OD 5-1/2"
Height 2-1/2"



Order No. 13 - 8965

Blade spindle pulley replaces MTD 756-0556. Fits 42" "G" series deck. Used on our 10-7155 spindle assembly.

Double Engine Pulley for MTD

Top ID 1"
Bottom ID 1"
Top OD 3-1/2"
Bottom OD 5-1/2"
Height 4-5/8"



Order No. 13 - 10186

Double engine pulley replaces MTD 756-0983B. Fits model 690-699 riding mowers. Without spacer.

Engine Pulley for MTD

ID 1"
Bottom OD 6"
Height 5-7/16"
Keyway 1/4"
Top OD 3-25/64"



Order No. 13 - 12853

Engine pulley replaces MTD 756-04064A/956-04064.

Double Engine Pulley for MTD

Top ID 1"
Bottom ID 1"
Top OD 3-1/2"
Bottom OD 5-1/2"
Height 4-7/8"



Order No. 13 - 10185

Double engine pulley replaces MTD 756-0982B, 753-0635 and 756-0488. Fits model 660-679 riding mowers. Without spacer.

Engine Pulley for MTD

ID 1"
Bottom OD 6"
Height 5-7/8"
Keyway 1/4"
Top OD 3-25/64"



Order No. 13 - 12855

Engine pulley replaces MTD 756-04196A.

Double Engine Pulley for MTD

Top ID 1"
Bottom ID 1-1/4"
Top OD 3-1/2"
Bottom OD 5"
Height 6-1/4"



Order No. 13 - 9590

Double engine pulley replaces MTD 756-0658. Fits 600 series mowers.

Drive Pulley for MTD

ID 12 point spline
OD 5"
Height 2-3/4"



Order No. 13 - 9589

Deck pulley replaces MTD 756-0603. Fits 600 series mowers. Double pulley.

Engine Pulley for MTD

ID 1"
Bottom OD 6"
Height 5-7/16"
Keyway 1/4"
Top OD 3-9/16"



Order No. 13 - 12854

Engine pulley replaces MTD 756-04067A/956-04067A/756-04195.

13

PULLEYS



PULLEYS

Idler Pulley for MURRAY



ID 3/8"
OD 2-5/8"
Height 5/8"

Order No. 13 - 10164

Idler pulley replaces Murray 056526. Drive belt idler on rear engine 25" & 30" riders.

Idler Pulley for MURRAY



ID 3/8"
OD 6"
Height 1-1/4"

Order No. 13 - 9865

Idler pulley replaces Murray 95068, 95272.

Idler Pulley for MURRAY



ID 1/2"
OD 3"
Height 11/16"

Order No. 13 - 7127

Idler Pulley. Replaces Murray 91178 & 4206130. Fits 25", 30", 36" and 46" rear engine riders model 7-35500, 7-30502 and 7-25501. Composite: glass filled nylon.

Idler Pulley for MURRAY



ID 1/2"
OD 3-11/32"
Height 1-1/16"

Order No. 13 - 7978

Flat Idler pulley replaces Murray 91179 & 421409. Engine to transmission idler, fits 38" cut 12 hp lawn tractor 1987-1993. Composite: glass filled nylon.

Pulley for MURRAY

ID 5/8" splined
OD 5-1/4"
Height 1"



Order No. 13 - 7417

Pulley replaces Murray 91943, 91769. Fits 1989 and up, 40" deck, 40600 series. Used with our 10-6890 splined shaft.

Idler Pulley Reducer for MURRAY/NOMA



ID 1/2"
OD 11/16"
Height 15/32"

Order No. 13 - 9546

Idler pulley reducer bushing replaces Murray 690369.

Idler Pulley for MURRAY/NOMA



Order No. 13 - 9542

Idler pulley replaces Murray 690387. ID 11/16", OD 4-11/16", Height 1-3/8".

Order No. 13 - 9543

Idler pulley replaces Murray 690549. ID 11/16", OD 4-5/8", Height 1".

Idler Pulley for MURRAY/NOMA



Order No. 13 - 9544

Idler pulley replaces Murray 690409 7 690407. ID 21/32", OD 3-11/32", Height 1".

Idler Pulley for MURRAY



Order No. 13 - 10131

Idler pulley replaces Murray 690410. ID 11/16", OD 3", Height 1".

13

PULLEYS

PULLEYS



Replacement Pulleys for MURRAY

Order No.	Murray No.	OD	ID	Key-way
13 - 2926	20615	4-1/2"	5/8"	5/32"
13 - 2928	21022	3-1/4"	5/8"	5/32"
13 - 2929	21096	3-3/4"	5/8"	5/32"
13 - 3317	23739	5"	5/8"	5/32"



Spindle Pulley for MURRAY

ID 9/16" splined
OD 5"
Height 2-9/16"



Order No. 13 - 7994

Blade spindle pulley (center pulley) replaces Murray 92128. Fits 46" front engine rider 14 and 18 hp models 46620B, 46620X15A and 46621X92B.

Spindle Pulley for MURRAY

ID 9/16" splined
OD 5"
Height 1-27/64"



Order No. 13 - 7993

Blade spindle pulley (right and left) replaces Murray 92127. Fits 46" front engine rider 14 and 18 hp models 46620B, 46620X15A and 46621X92B.

13

Spindle Pulley for MURRAY

ID 9/16" splined
OD 6-1/4"
Height 1-13/32"



Order No. 13 - 7995

Blade spindle pulley replaces Murray 92425. Fits 42" front engine rider 18 hp model 42170X9A.

Spindle Pulley for MURRAY

ID 9/16" splined
OD 7-1/2"
Height 1-3/8"



Order No. 13 - 7986

Blade spindle pulley replaces Murray 91951 & 774090. Fits 30" rear engine rider 11 hp models 3059X1A, 30594X1A and 30595X1A.

PULLEYS

Spindle Pulley for MURRAY

ID 9/16" splined
OD 5-1/4"
Height 1-13/32"



Order No. 13 - 7991

Blade spindle pulley replaces Murray 91769, 91943. Fits 38" front engine rider 12 hp models 38617X5A, 38618X92A and 38608X12D.

Jackshaft Pulley for MURRAY

ID 9/16"
OD 5-3/8"
Height 1/2"



Order No. 13 - 10820

Jackshaft pulley replaces Murray 494199. Fits 42" cut, splined shafts.



PULLEYS

Jackshaft Pulley for MURRAY

ID 5/8" splined
OD 5"
Height 1"



Order No. 13 - 9514

Jackshaft pulley replaces Murray 094592. Fits 46" cut mowers. Models 46560x91A, 46560X192A, 46561X8, 46562X7 & 46562X8. Takes 4 pulleys per unit.

Idler Pulley for NOMA



ID 3/8"
OD 4-3/4"
Height 1-3/8"

Order No. 13 - 7182

Idler Pulley. Replaces Noma 310-326. Fits 38", 39", 40", 42", 43" & 46" front engine rider models B3812-160, C3912-090, B4013-030, B4213-010, B4314-040, B4618-021. Composite: glass filled nylon.

Trans Axle Pulley for MURRAY

ID 5/8"
OD 7"
Height 1-17/64"
Keyway 3/16"



Order No. 13 - 7981

Trans axle pulley replaces Murray 55101. Fits 30" rear engine rider, 8 hp, models 8-35500 & 7-30502.

Edger Head Pulley for Power Trim



ID 5/8"
OD 2"
Height 1"
Keyway 3/16"

Order No. 13 - 3316

Replaces Power Trim 307. Has 2 set screws.

Engine Pulleys for Power Trim

OD 2-1/2"
Width 5/8"
Height 5/8"
Keyway 3/16"



Order No. 13 - 1262

5/8" ID Replaces Power Trim 334, McLane 1063, JD M4-7161, Gates 7800-22. Used on 2.2 hp Honda and Briggs 2 and 3 hp. Has key and set screw.

Order No. 13 - 1263

3/4" ID Replaces Power Trim 334-1, McLane 1063-A. Has key and set screw. Used on 3-1/2 hp Honda.

Idler Pulley for SCAG



ID 3/8"
OD 3-1/4"
Height 1"

Order No. 13 - 8587

Heavy duty idler pulley replaces Scag 481048. Fits 36", 46" & 52" gear drive commercial mowers.

Idler Pulley for SCAG



ID 3/8"
OD 3-7/16"
Height 1-3/16"

Order No. 13 - 7983

Idler pulley replaces Scag 481048 & 48201. Fits 36", 46" and 52" gear drive commercial mowers.

13

PULLEYS

PULLEYS



Idler Pulley for SCAG

ID 3/8"
OD 5"
Height 2-1/2"



Order No. 13 - 11464

Idler pulley replaces Scag 483210. Fits 2006 models. Replaces our 13-10171.

Idler Pulley for SCAG

ID 3/8"
OD 5"
Height 1-3/4"



Order No. 13 - 11657

Idler pulley replaces Scag 483215 & 482416. Fits 2006 models. Replaces our 13-10058.

Idler Pulley for SCAG

ID 3/8"
OD 5-15/16"
Height 1-1/4"



Order No. 13 - 6572

Idler Pulley. Replaces Scag 48269 & 482416. Deck Idler on 40" and 48" decks. See Flat Idler Section for measurements.

Idler Pulley for SCAG

ID 3/8"
OD 4-1/2"
Height 1-1/4"



Order No. 13 - 9844

Idler pulley replaces Scag 48473 & 482306. Composite: glass filled nylon.

Idler Pulley for SCAG

ID 3/8"
OD 5-3/16"
Height 1-3/16"



Order No. 13 - 5712

Idler Pulley. Replaces Scag 48198, 48269. See Flat Idlers Section for measurements.

Spindle Pulley for SCAG

ID 1-5/8"
OD 5-3/4"
Height 7/8"



Order No. 13 - 11228

Spindle pulley replaces Scag 482744, 48924, 48127. Fits STHM, SW & SWZU models. Uses our 13-9600 hub. Also replaces Encore 363216 & Ferris 1520814.

Idler Pulley for SCAG

ID 3/8"
OD 3-3/4"
Height 1-5/8"



Order No. 13 - 12712

Idler pulley replaces Scag 483415.

Idler Pulley for SCAG

ID 1-9/16"
OD 5-3/4"
Height 7/8"



Order No. 13 - 10412

Idler pulley replaces Scag 48062. Deck idler pulley fits 48" & 61" decks, 1999 and older STHM models.

Idler Pulley for SCAG

ID 3/8"
OD 3-3/4"
Height 1-1/4"



Order No. 13 - 12930

Idler pulley replaces Scag 483173.

13

PULLEYS



PULLEYS

Idler Pulley for SCAG

ID 1-9/16"
OD 4"
Height 41/64"



Order No. 13 - 10413

Idler pulley replaces Scag 48065. Engine deck idler pulley fits OST & STHM models.

Idler Pulley for SCAG

ID 3/8"
OD 4-1/4"
Height 1-1/4"
Flat Width 3/4"



Order No. 13 - 13615

Idler pulley replaces Scag 483214, 482655. Fits LT models.

Idler Pulley for SCAG

ID 3/8"
OD 3-5/16"
Height 1-1/4"
Flat Width 3/4"



Order No. 13 - 13614

Idler pulley replaces Scag 483208, 481048 & Encore 363169.

Engine Pump Pulley for SCAG

ID 1"
OD 5-9/16"
Height 7/8"
Keyway 1/4"



Order No. 13 - 10418

Engine pump pulley replaces Scag 48792. Fits 61" & 72" deck models STC & STHM.

V-Idler Pulley for SCAG

ID 3/8"
OD 4"
Height 15/16"



Order No. 13 - 10417

V-Idler pulley replaces Scag 482062. Fits units with the built on blower system for grass catchers.

Wheel Drive Pulley for SCAG

ID 5/8"
OD 7-1/2"
Height 21/32"
Keyway 3/16"



Order No. 13 - 7786

Input shaft pulley. Replaces Scag 48197. Fits 13 to 18 hp Kawasaki, Briggs and Kohler engines for 36", 48", 52" and 61" cut.

Pump Pulley for SCAG

ID 9/16"
OD 5-1/2"
Height 1-1/2"
Keyway 3/16"



Order No. 13 - 10764

Pump pulley replaces Scag 48586. Fits SWZ, Turf Tiger, Cougar mowers.

13

PULLEYS

PULLEYS



Engine Pulley for SCAG

ID 1"
OD 2-3/4"
Height 1-1/2"
Keyway 1/4"



Order No. 13 - 10768

Engine pulley replaces Scag 481666. Fits models SW & SWU walkbehinds.

Blower Pulley Housing for SCAG

ID 1"
OD 4-3/4"
Height 1-3/8"
Keyway 1/4"



Order No. 13 - 10769

Blower housing and grass catcher pulley replaces Scag 482298. Fits models GC-STC & GC-SST.

Spindle Pulley for SCAG ID tapered 1-19/32" to 1-19/32"
OD 6-1/4"
Height 7/8"



Order No. 13 - 9601

Spindle pulley replaces Scag 48753. Fits Turf Tiger spindles. Used with our 10-9153 spindle assembly & our 13-9600 tapered hub. Fits left hand spindle.

Spindle Pulley for SCAG ID tapered 1-19/32" to 1-19/32"
OD 7"
Height 7/8"



Order No. 13 - 9602

Spindle pulley replaces Scag 48967. Fits Turf Tiger spindles. Used with our 10-9153 spindle assembly & our 13-9600 tapered hub. Fits right hand spindle.

Tapered Hub for SCAG

ID 1-1/8"
OD 2-15/32"
Height 1-1/4"
Keyway 1/4"



Order No. 13 - 9600

Tapered hub replaces Scag 48926. Fits Turf Tiger spindles. Used with our 10-9153 spindle assembly & our 13-9601 & 13-9602 spindle pulleys.

Pump Drive Idler Pulley for SCAG ID 3/8"
OD 5"
Height 7/8"



Order No. 13 - 10414

Pump drive idler pulley replaces Scag 48181. Fits models SSZ, SWZ & Turf Tiger. 5/16" offset reducer bushing. Also replaces AYP 101344L, Bunton PL8540A & Encore 483025.

Pump Shaft Pulley for SCAG ID 1-5/8"
OD 5-29/64"
Height 7/8"



Order No. 13 - 11208

Pump shaft pulley replaces Scag 482649. Fits 2005 SWZ walkbehinds, 2005 SCZ zero turn riders 36" & 42" cut & SWZU walkbehind 36" thru 61" cut models.

13

PULLEYS



PULLEYS

Spindle Pulley for SCAG

Order No. 13 - 11209

Spindle pulley replaces Scag 482745. Fits 2005 SWZ walkbehinds, & 2005 Turf Tiger model #31BSD.



ID 1-5/8"
OD 6-11/32"
Height 7/8"

Spindle Pulley for SCAG

Order No. 13 - 11211

Spindle pulley replaces Scag 482747. Fits 2005 Turf Tiger model 31BSD.



ID 1-5/8"
OD 6-61/64"
Height 7/8"

Spindle Pulley for SCAG

Order No. 13 - 11212

Spindle pulley replaces Scag 482748. Double groove pulley. Fits 2005 SWZ walkbehinds.



ID 1-5/8"
OD 5-3/4"
Height 2"

Deck Drive Pulley for SCAG

Order No. 13 - 11213

Deck drive pulley replaces Scag 482752. Fits 2005 Turf Tiger model 31BSD.



ID 1-5/8"
OD 6-1/4"
Height 7/8"

Deck Drive Pulley for SCAG

Order No. 13 - 11214

Deck drive pulley replaces Scag 482754. Fits 2005 SWZU walkbehind 36" thru 61" cuts.



ID 1"
OD 4"
Height 1-3/4"
Keyway 1/4"

Pump Drive Engine Pulley for SCAG

Order No. 13 - 11215

Pump drive engine pulley replaces Scag 482755. Fits 2005 SWZ walkbehinds.



ID 1"
OD 4"
Height 1-3/4"
Keyway 1/4"

Deck Drive Pulley for SCAG

Order No. 13 - 11216

Deck drive pulley replaces Scag 482791. Fits 2005 Turf Tiger model 31BSD.



ID 1-1/8"
OD 5-1/2"
Height 1-43/64"
Keyway 1/4"

13

PULLEYS

PULLEYS



Double Pulley for SCAG



ID 5/8"
OD 3-1/4"
Height 1-3/4"
Keyway 3/16"

Order No. 13 - 7124

Double Pulley. Replaces Scag 48199. Fits 36", 48", 60" and 72" mid size mowers.

Pulley & Brake Drum for SCAG



ID 2-1/4"
OD 8"
Height 1/2"

Order No. 13 - 9758

Pulley and brake drum assembly replaces Scag 48992. Includes our 05-9757 brake drum & 2 pulleys.

Spindle Pulley for SCAG (with Taper Hub)



ID 1"
OD 5-3/4"
Height 1-3/16"

Order No. 13 - 5989

Spindle Pulley with taper hub. Replaces Scag 48141, 48924 & 48127.

Spindle Pulley for SCAG (Pulley Only)



ID taper 1-9/16" to 1-5/8"
OD 5-3/4"
Height 7/8"

Order No. 13 - 5988

Pulley only. Replaces Scag 48924, 48127-01. Used with our 13-6532 Taper Hub.

Taper Hub Only for SCAG



ID 1-1/16"
OD 2-1/2"
Height 1-3/16"
Keyway 1/4"

Order No. 13 - 6532

Taper Hub only. Replaces Scag 48141. Used with our 13-5988.

Tapered Hub for SCAG



ID 15mm
OD 2"
Height 1-1/4"
Keyway 3/16"

Order No. 13 - 10773

Tapered hub replaces Scag 482085. Includes 2 screws.

Tapered Hub for SCAG



ID 17mm
OD 2-1/2"
Height 1-1/4"
Keyway 3/16"

Order No. 13 - 10774

Tapered hub replaces Scag 481884. Includes 2 screws.

Tapered Hub for SCAG



ID 1"
OD 3-3/16"
Height 1-5/16"
Keyway 1/4"

Order No. 13 - 10775

Tapered hub replaces Scag 481536.

Idler Pulley for SNAPPER



ID 3/8"
OD 4-1/8"
Thickness 27/32"

Order No. 13 - 9856

Idler pulley replaces Snapper 7018574.

Idler Pulley for SNAPPER



ID 1/4"
OD 2-1/4"
Thickness 27/32"

Order No. 13 - 8478

Idler pulley replaces Snapper 7012124. Fits self propelled 21" commercial series mowers.

Idler Pulley for SNAPPER



ID 3/8"
OD 4-1/8"
Height 1-11/16"

Order No. 13 - 8245

Flat idler pulley replaces Snapper 7024725. Tension idler for 12 and 14 hp front engine riders with 38" decks.

Idler for SNAPPER



ID 3/8"
OD 4-1/2"
Height 3/4"

Order No. 13 - 5870

Replaces Snapper 7018651. Mule drive assembly Idler used on Snapper LT11, 12 and 16 series tractors with 41" decks (2 per deck). Also used on 48" decks (2 per deck). See V-Belt Idlers for measurements.

13

PULLEYS



PULLEYS

Crankshaft Pulley for SNAPPER



ID 7/8"
OD 1-7/8"
Height 7/8"
Keyway 5/32"

Order No. 13 - 8547

Crankshaft pulley replaces Snapper 7021707. Fits self propelled walk behind mowers.

Engine Pulley for SNAPPER with Honda engines



ID 7/8"
OD 2-1/8"
Height 7/8"
Keyway 5/32"

Order No. 13 - 8193

Engine pulley replaces Snapper 7021764.

Crankshaft Pulley for SNAPPER



ID 7/8"
OD 2-1/4"
Height 7/8"
Keyway 5/32"

Order No. 13 - 5950

7/8" Crankshaft Pulley. Replaces Snapper 7024596, 7022044. Used on Wisconsin equipped Snapper walk behind mowers for greater ground speed. 5/16" course set screw.

Crankshaft Pulleys for SNAPPER



ID 1"
OD 2-1/4"
Height 7/8"
Keyway 5/32"

Order No. 13 - 5949

1" Crankshaft Pulley. Replaces Snapper 7022043. Used on B&S equipped Snapper walk behind mowers for greater ground speed.

Crankshaft Pulley for SNAPPER



ID 1"
OD 2-1/8"
Height 7/8"
Keyway 5/32"

Order No. 13 - 9787

Crankshaft pulley replaces Snapper 7021759. Fits 21" self-propelled mowers.

Crankshaft Pulley for SNAPPER



ID 25mm
OD 2-1/8"
Height 7/8"
Keyway 1/4"

Order No. 13 - 9806

25 mm crankshaft pulley replaces Snapper 7022106. Fits 21" self-propelled mowers.

Drive Pulley for SNAPPER



ID 3/8"
OD 2"
Height 1-1/4"

Order No. 13 - 9508

Drive pulley replaces Snapper 7024521, 7012140. Fits 21" self-propelled Snapper walk behind mowers. Die cast aluminum material.

Spindle Pulley for SNAPPER



ID 3/4"
OD 6-7/8"
Height 1-27/64"

Order No. 13 - 436

Deck Spindle Pulley. Replaces Snapper 7018781.

Spindle Pulley for SNAPPER



ID 3/4"
OD 5-3/4"
Height 1-5/16"

Order No. 13 - 776

Deck Spindle Pulley. Replaces Snapper 7014397.

Engine Pulley for SNAPPER



ID 1-1/2" x 1-1/4" (Sq. "D")
OD 5"
Height 1-1/16"

Order No. 13 - 438

Engine Pulley. Replaces Snapper 7010987.

13

PULLEYS

PULLEYS



Idler Pulley for STIGA

ID 21/32"
OD 4-1/2"
Height 1"



Order No. 13 - 10152

Idler pulley replaces Stiga 1134-3053-01. Composite idler pulley with precision bearing with no insert.

Idler Pulley for STIGA

Insert ID 13/32"
OD 3-1/2"
Height 1-1/2"



Order No. 13 - 50261

Idler pulley replaces Stiga 1134-3043-01. Composite idler pulley with precision bearing with insert.

Idler Pulley for TORO

ID 1/2"
OD 5"
Height 1-3/16"



Order No. 13 - 5711

Idler Pulley. Replaces Toro 51-4480. See Flat Idlers without flange for measurements.

Idler Pulley for TORO

ID 3/4"
OD 4"
Height 1-1/8"



Order No. 13 - 8373

Flat Idler pulley. Replaces Toro/Wheelhorse 104975. Fits garden Tractors 300, 400, and 500.

Idler Pulley for TORO

ID 15/32"
OD 2-7/8"
Height 27/32"



Order No. 13 - 7278

Idler Pulley. Replaces Toro 46-5650. Fits all 21" BBC models.

V-Idler Pulley for TORO

ID 3/4"
OD 4-1/4"
Height 13/16"



Order No. 13 - 8829

V-Idler pulley replaces Toro 92-7103 & 104974. Fits garden tractor models 300, 400 & 500.

Double Pulley for TORO

ID 5/8"
OD 2-3/4"
Height 1-11/16"
Keyway 3/16"



Order No. 13 - 9805

Double pulley replaces Toro 74-0480/99-5878. Fits belt drive for commercial midsize walkbehind units.

Drive Wheel Pulley for TORO

ID 2-1/4"
OD 8"
Height 1/2"
Mounting Holes 11/32"



Order No. 13 - 9397

Drive wheel pulley replaces Toro 51-4160 & Scag 48200. Fits our 08-8241 & 08-8573 wheel assembly. Fits Scag/Encore rear wheel drive 36", 48", 52" & 61" cut mowers.

Idler Pulley for TORO

ID 3/8"
OD 4-1/8"
Height 1-1/2"



Order No. 13 - 12901

Idler pulley replaces Toro 106-2175.

Idler Pulley for WALKER

ID 3/8"
OD 3-1/4"
Height 7/8"



Order No. 13 - 9537

Idler pulley replaces Walker 5245. Fits model MT.

13

PULLEYS



Transmission Pulley for TORO

ID 7/16"
OD 2-5/8"
Height 1"



Order No. 13 - 13434

Transmission gear case pulley replaces Toro 39-6740. Fits Commercial Proline 21" model 22166, 22167, 22168.

Spindle Pulley for TORO

ID 2"
OD 7-5/8"
Height 1"



Order No. 13 - 13639

Spindle pulley replaces Toro 105-7734. Fits Z Master models 74238, 24244, 74245, 74246, 74249, 74250, 74251, 74253, 74255, 74262, 74265, 74267, 74268, 74272, 74283, 74292, 74915, 74925, 74935, 74945.



IDLER APPLICATION CHART

OEM No.	Order No.	Part No.	OEM No.	Order No.	Part No.	OEM No.	Order No.	Part No.
HABEN			KEE			92127	13-7993	
30412	13-2916		483036	13-2917	IF-8003-M	MURRAY (Cont.)		
HAHN			363150	13-2916	IF-8002-M	92128	13-7994	
451179	13-2176	IF-4412	MASSEY-FERGUSON			92425	13-7995	
451182	13-719	IF-3612	1023-556-M91	13-729		92851	13-12490	
451293	13-722	IF-4812	1024-515-M1	13-2916	IV-40-O	95068	13-9865	
HUFFMAN			1040-013-M1	13-728	IV-39-A	95272	13-9791	
10890	13-718	IF-3011	1040-014-M1	13-2917	IF-8003-M	056526	13-10164	
24392	13-2176	IF-4412	MASSEY-FERGUSON (Cont.)			094592	13-9514	
HUFFY			3020-047-M1	13-2918	IV-80M	494199	13-10820	
9992	13-729	IV-40-O	1030-049-M1	13-2176	IF-4412	690369	13-9546	
10890	13-718	IF-3011	511450-M1	13-726	IF-6412	690387	13-9542	
13078	13-716	IF-3010	834336-M1	13-731	IV-48-A	690409	13-9544	
24392	13-2176	IF-4412	MTD			690410	13-9545	
HUSQVARNA			753-0518	13-10672		690549	13-9543	
539102652	13-9868		756-0116	13-728	IV-39-A	NOMA - AMF/DYNAMARK		
HUSTLER			756-0117	13-720	IF-3616	13469	13-724	IF-5216
781385	13-10226		756-0137	13-719	IF-3612	27332	13-719	IF-3612
781385	13-10227		756-0166	13-729	IV-40-O	35374	13-731	IV-48-A
784504	13-12297		756-0178	13-2191		39498	13-714	IF-4424-2
784827	13-12298		756-0183	13-725		40223	13-721	IF-4414
794404	13-12299		756-0199	13-718	IF-3011	40501	13-2915	IF-8001-M
INTERNATIONAL HARVESTER			756-0218	13-2192		44098	13-3311	
491395-R1	13-723	IF-5212	756-0225	13-2176	IF-4412	40501	13-2915	IF-8001-M
542520-R91	13-726	IF-6412	756-0240	13-722	IF-4812	44257	13-726	IF-6412
JACOBSEN			756-0240	13-722	IF-4812	44280	13-734	IV-64-B
317726	13-2916	IV-40-O	756-0313	13-715		45074	13-728	IV-39-A
325267	13-729	IV-40	756-04325	13-14326		45651	13-730	IV-42-B
JOHN DEERE			756-0437	13-8588		46993	13-718	IF-3011
AM-32672	13-728	IV-39-A	756-0486	13-8657		47781	13-729	IF-40
AM-33574	13-734	IV-64-B	756-0492	13-732		47782	13-715	IF-3008-A
AM-35585	13-725	IF-52220	756-0499	13-2182		53243	13-729	IF-40
AM-35590	13-727	IF-6416	756-0515	13-723		53244	13-2182	
AM-331126	13-715	IF-3008-A	756-0556	13-8965		51448	13-722	IF-4812
AM-102323	13-721	IF-4414	756-0603	13-9589		57736	13-726	IF-6412
AM-102322	13-728	IV-39-A	756-0627	13-8602		91943	13-7417	
AM-106627	13-12419		756-0638	13-9708		310-326	13-7182	
AM-32705	13-721	IF-4414	756-0658	13-9590		POLORON		
AM-32369	13-2183		756-0980	13-9587		965273	13-763	IS-810
AM-32196	13-724	IF-5216	756-0969	13-9588		SEARS/ROPER (See AYP)		
AM-37249	13-12427		756-0635A	13-9280		RUGG		
AM-41647	13-723	IF-5212	956-0365	13-11144		10858	13-729	IV-40-O
GX20286	13-10738		MURRAY			21101	13-2176	IF-4412
GX20287	13-10740		20613	13-2918	IV-80M	SCAG		
GX20335	13-11448		21409	13-2916	IF-8002M	48062	13-10412	
GX20367	13-11449		23052	13-7996		48065	13-10413	
GY20067	13-10741		23211	13-2919	IV-81M	48068	13-5714	
GY20110	13-10737		23238	13-2917	IF-8003M	48181	13-10414	
PT-8649	13-2188		23339	13-2915	IF-8001M	48197	13-7786	
PT-8761	13-5869		55101	13-7981		48198	13-5714	
			55450	13-7985		48199	13-7124	
			56562	13-7987		48200	13-9397	
			75073	13-7988		48201	13-7983	
			90118	13-3236		48473	13-9844	
			91178	13-7127		48586	13-10764	
			91179	13-7978		48753	13-9601	
			91769	13-7991		48792	13-10418	
			91951	13-7986		48923	13-10767	
			91801	13-7126				
			91807	13-7992				

13

PULLEYS

PULLEYS



IDLER APPLICATION CHART

OEM No.	Order No.	Part No.	OEM No.	Order No.	Part No.	OEM No.	Order No.	Part No.
SCAG (Cont.)			SNAPPER (CONT.)					
48926	13-9600		24521	13-9508				
48967	13-9602		24725	13-8245				
48992	13-9758		76500	13-5714				
481048	13-8587		76520	13-2188				
481048	13-13614		77285	13-2189				
481435	13-10765		STIGA					
481536	13-10775		1134-3043-01	13-50261				
481666	13-17068		1134-3053-01	13-50260				
481883	13-10762		TORO/WHEEL HORSE					
481884	13-10774		5942	13-2190				
482062	13-10417		6719	13-723	IF-5212			
482085	13-10773		7434	13-722	IF-4812			
482298	13-10769		7451	13-734	IV-46-B			
482416	13-10058		8205	13-728	IV-39-A			
482650	13-10763		8510	13-2182				
482655	13-13615		104974	13-8829				
482670	13-10766		104975	13-8373				
483208	13-13614		105874	13-721	IF-4414			
483214	13-13615		106144	13-726	IF-6416			
SIMPLICITY			110370	13-729	IV-40			
101096	13-2183		112425	13-723	IF-5212			
108386	13-723	IF-5212	112426	13-722	IF-4812			
117414	13-715	IF-3008A	112895	13-727	IF-6416			
118414	13-718	IF-3011	MW-8821	13-719	IF-3612			
154534	13-721	IF-4414	3-4243	13-728	IV-39-A			
156124	13-721	IF-4414	3-4244	13-719	IF-3612			
668827	13-731	IV-48A	7-0056	13-718	IF-3011			
1603515	13-721	IF-4414	7-0431	13-733	IV-64-A			
1610191	13-721	IF-4414	7-0823	13-731	IV-48-A			
164268	13-724	IF-5216	11-1560	13-2176	IF-4412			
1657827	13-2175		12-5820	13-729	IV-40-O			
1668477	13-720	IF-3616	12-6700	13-2175				
SNAPPER			25-5880	13-2193	IP-3015-2			
10948	13-718	IF-3011	36-3220	13-731				
11029	13-734	IV-64-B	46-5650	13-7278				
12109	13-9509		51-4160	13-9397				
12124	13-8478		51-4480	13-5711				
12140	13-9508		55-8260	13-727	IF-6416			
13850	13-719	IF-3612	74-0480	13-9805				
14153	13-721	IF-4414	92-7101	13-723				
14208	13-729	IV-40	92-7103	13-8829				
14340	13-2175		93-1622	13-727				
18288	13-731	IV-48-A	99-5878	13-9805				
18574	13-9856		143-1040	13-724	IF-5216			
18585	13-777		244-63	13-722	IF-4812			
18651	13-5870		WALKER					
18724	13-2919	IV-81M	5245	13-9537				
19213	13-9509		WHEEL HORSE					
21707	13-8547		(See TORO/WHEEL HORSE)					
21759	13-9787							
21764	13-8193							
22106	13-9806							

13

PULLEYS

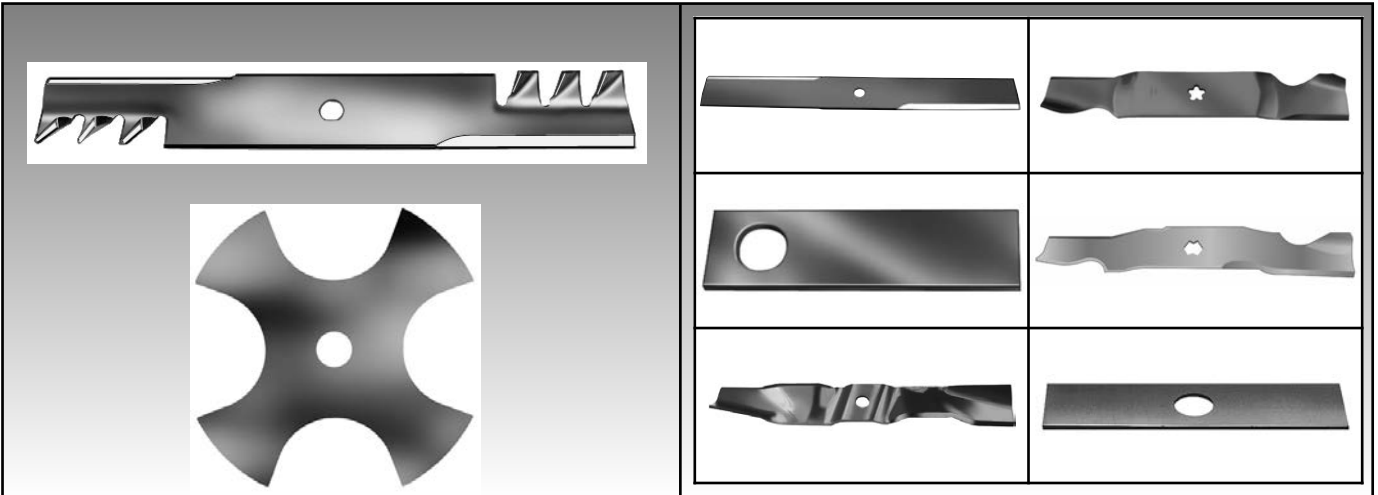

Quick-Glance

BLADES	PG.
OEM Blade Quick Reference	298-313
Universal Blades	314-316
Lawnmower Safety	317
Flat Blades	318
Low-Lift Blades	319
Commercial Mulching Blades	320-326
O.E.M. Blades	327-418
Air Lifts	419
Edger Blades	421-424
Edger Shafts	424
Brushcutter Blades	425-426

BLADES



O.E.M. REPLACEMENT BLADES BY LENGTH

Length	Center Hole	Outside Hole	Center to Center	Width	Steel Thickness	Order No.	Page No.
3-7/16"	17/32"			1"	.125"	15 - 6278	358
3-17/32"	17/32"			1"	.125"	15 - 11643	335
3-17/32"	17/32"			1"	.125"	15 - 11645	335
3-17/32"	17/32"			1"	.125"	15 - 8720	335
4" 1/2"				1"	.125"	15 - 10968	335
4" 17/32"				1"	.125"	15 - 11644	335
4" 1/2"				1"	.125"	15 - 6324	335
4-1/4"	17/32"			1"	.117"	15 - 11647	347
4-1/4"	17/32"			1"	.117"	15 - 6279	347
4-11/16"	29/64"			1-1/4"	.095"	15 - 9173	369
5-1/2"	5/16"			2"		15 - 50150	405
6-3/8"	3/8"			1-1/2"	.095"	15 - 3408	381
6-7/16"	29/64"			1-1/4"	.095"	15 - 9172	369
6-39/64"	21/64"					15 - 14172	405
7" 1/2"				2-1/2"	.160"	15 - 6834	348
9-5/8"	3/8"			2"	.134"	15 - 6031	393
10-1/2"	5/8"			2-1/2"	.134"	15 - 6137	407
11"	3/4"			2-1/2"	.204"	15 - 6075	340
11-9/16"	1-3/8"	3/8"		2-1/2"	.150"	15 - 1116	399
11-7/8"	13/32"	21/64"		2"	.150"	15 - 6093	365
11-7/8"				2-1/2"	.187"	15 - 6466	365
12-1/4"				2"	.150"	15 - 50027	405
12-3/8"	1-1/2"	7/16"		3-3/4"	.117"	15 - 6128	381
12-11/16"	3/4"			1-9/16"	.095"	15 - 50247	405
13"	1-3/8"	3/8"		2-1/2"	.150"	15 - 1117	399
13-3/4"	5/8"			2-1/2"	.204"	15 - 11810	369
13-3/4"	5/8"			2-1/2"	.204"	15 - 11870	369
13-3/4"				2"	.150"	15 - 50111	365
13-7/8"	5/8"			2"	.204"	15 - 1065	360
13-7/8"	3/4"			2"	.187"	15 - 2000	407
14"		1/4"		2"	.187"	15 - 1108	407
14"	11/16"			2"	.187"	15 - 1126	372
14-1/16"	11/16"			2-1/2"	.204"	15 - 6193	372
14-1/8"	3/8"			2"	.160"	15 - 13333	365
14-1/8"					.160"	15 - 50293	365
14-3/8"	11/16"			2"	.187"	15 - 1100	345
14-7/16"	45/64"			2-1/2"	.187"	15 - 6312	321
14-1/2"	3/4"	13/32"		2"	.150"	15 - 2083	399
14-1/2"				2"	.150"	15 - 50007	405
14-1/2"				2"	.150"	15 - 50026	405
14-1/2"	5/8"			2-1/2"	.203"	15 - 6020	343
14-1/2"	11/16"			2-1/2"	.187"	15 - 6086	345
14-1/2"	11/16"			2-1/2"	.187"	15 - 6087	345
14-1/2"	3/4"			2-1/2"	.187"	15 - 6267	407
14-1/2"	11/16"			2-1/2"	.204"	15 - 6316	321
14-1/2"	3/4"			2"	.204"	15 - 851	407

14/16
BLADES



O.E.M. REPLACEMENT BLADES BY LENGTH

Length	Center Hole	Outside Hole	Center to Center	Width	Steel Thickness	Order No.	Page No.
14-9/16"	5/8"			2-3/4"	.187"	15 - 6131	363
14-19/32"	1-1/8"	25/64"		2-1/2"	.134"	15 - 2030	358
14-5/8"				2-1/2"	.204"	15 - 12122	365
14-3/4"	13/32"	5/16"		3"	.150"	15 - 6019	381
14-13/16"		5/16"		3"	.125"	15 - 1022	385
14-13/16"		3/8"		2-1/2"	.150"	15 - 1030	340
14-13/16"		21/64"		3"	.125"	15 - 1038	385
14-7/8"	3/4"			2-1/2"	.204"	15 - 11476	340
14-7/8"	5/8"			2-1/4"	.187"	15 - 14540	328
14-7/8"	7/16"	1/2"		2"	.150"	15 - 3346	372
14-7/8"	5/8"			2-1/2"	.204"	15 - 7010	365
15"	3/4"			3"	.204"	15 - 11805	340
15"	5/8"			2-1/2"	.250"	15 - 12868	357
15"	1/2"			2"	.204"	15 - 3377	359
15"	1/2"			2"	.204"	15 - 3378	359
15"	13/32"	11/32"	3-9/32"	2"	.150"	15 - 50061	405
15"	1/2"			2-1/2"	.240"	15 - 6330	359
15"	1/2"			2-1/2"	.204"	15 - 6415	321
15-1/32"				2-1/4"	.150"	15 - 844	389
15-1/8"	3/4"			2-1/2"	.204"	15 - 6081	340
15-3/16"				2-1/4"	.150"	15 - 1122	389
15-3/16"	25/32"			2-3/4"	.125"	15 - 50123	379
15-1/4"	5/8"			2-1/2"	.204"	15 - 10420	348
15-1/4"	15/16"			2-1/2"	.204"	15 - 11243	348
15-1/4"	15/16"			2-1/2"	.204"	15 - 11269	348
15-1/4"	15/16"			2-1/2"	.204"	15 - 11500	348
15-1/4"	3/8"			2"	.160"	15 - 13334	365
15-1/4"	5/8"			2-1/2"	.204"	15 - 6820	348
15-5/16"	3/8"	5/16"		2"	.150"	15 - 1077	381
15-5/16"	3/4"	13/32"		2"	.150"	15 - 2081	399
15-5/16"	11/16"	11/32"		2"	.204"	15 - 3386	377
15-5/16"						15 - 50292	365
15-5/16"	3/8"	3/8"		2"	.204"	15 - 6066	338
15-5/16"	5/8"			2-1/2"	.204"	15 - 6821	348
15-5/16"	5/8"			2-1/2"	.204"	15 - 9884	321
15-3/8"	3/8"			2-1/4"	.187"	15 - 2162	329
15-3/8"				2-1/4"	.160"	15 - 6205	329
15-3/8"				2-1/4"	.187"	15 - 6263	329
15-1/2"	5/8"			2-1/2"	.187"	15 - 3393	407
15-1/2"	5/8"			2-1/2"	.187"	15 - 3441	407
15-1/2"	5/8"			2-1/2"	.187"	15 - 6326	408
15-1/2"				2-1/4"	.160"	15 - 6437	329
15-1/2"				2-1/4"	.160"	15 - 6495	329
15-1/2"	5/8"			2-1/2"	.187"	15 - 9885	321
15-9/16"	1-1/4"	7/16"		2-1/2"	.187"	15 - 3332	339
15-9/16"				2-1/4"	.187"	15 - 9170	329

14/16

BLADES

BLADES



O.E.M. REPLACEMENT BLADES BY LENGTH

Length	Center Hole	Outside Hole	Center to Center	Width	Steel Thickness	Order No.	Page No.
15-9/16"				2-1/2"	.000"	15 - 9970	321
15-5/8"	5/8"			2-1/2"	.204"	15 - 10371	369
15-5/8"	5/8"			2-1/2"	.204"	15 - 10973	369
15-11/16"	27/32"			2-1/4"	.134"	15 - 6161	389
15-11/16"	7/8"			2-1/4"	.134"	15 - 6408	389
15-3/4"	27/32"			2-1/4"	.134"	15 - 6113	389
15-3/4"	27/32"			2-1/2"	.150"	15 - 6491	321
15-3/4"	27/32"			2-1/4"	.187"	15 - 9896	389
16"	3/4"	5/16"	2-1/2"	2-1/2"	.204"	15 - 10636	341
16"	11/16"			2"	.187"	15 - 1127	372
16"	3/4"			2"	.187"	15 - 2001	408
16"	5/8"			2-1/2"	.204"	15 - 3373	338
16"	11/16"			2"	.187"	15 - 6496	321
16-5/64"	47/64"	23/64"		2-13/64"	.125"	15 - 50146	339
16-3/32"				2-1/2"	.204"	15 - 13481	400
16-1/8"	3/4"			2"	.203"	15 - 10095	399
16-1/8"	3/8"			1-15/16"	.134"	15 - 6021	393
16-9/64"	3/4"			2"	.203"	15 - 10093	399
16-3/16"	31/32"			2"	.150"	15 - 6489	366
16-1/4"	5/8"			2-1/2"	.150"	15 - 1009	336
16-1/4"	5/8"			2-1/2"	.204"	15 - 10172	318
16-1/4"		5/16"		3"	.125"	15 - 1021	385
16-1/4"		3/8"		2-1/2"	.000"	15 - 1029	385
16-1/4"		21/64"		3"		15 - 1037	385
16-1/4"	5/8"			2-1/2"	.204"	15 - 10419	349
16-1/4"	5/8"			2-1/2"	.204"	15 - 10718	348
16-1/4"	3/8"			2"	.150"	15 - 1093	393
16-1/4"	15/16"			2-1/2"	.204"	15 - 11231	349
16-1/4"	15/16"			2-1/2"	.204"	15 - 11240	349
16-1/4"	15/16"			2-1/2"	.204"	15 - 11279	349
16-1/4"	3/4"			2-1/2"	.204"	15 - 11478	341
16-1/4"	15/16"			2-1/2"	.204"	15 - 11493	349
16-1/4"	15/16"			2-1/2"	.204"	15 - 11494	349
16-1/4"	15/16"			3"	.204"	15 - 11769	350
16-1/4"	15/16"			3"	.204"	15 - 11770	350
16-1/4"	15/16"			3"	.204"	15 - 11771	350
16-1/4"	15/16"			3"	.204"	15 - 11772	322
16-1/4"	15/16"			3"	.204"	15 - 12002	350
16-1/4"				2-1/2"	.204"	15 - 12123	366
16-1/4"	5/8"	11/32"		2-1/2"	.240"	15 - 2172	334
16-1/4"	5/8"			2-1/2"	.204"	15 - 3400	336
16-1/4"	13/32"	5/16"		3"	.150"	15 - 6003	382
16-1/4"	5/8"			2-1/2"	.160"	15 - 6175	349
16-1/4"	5/8"			2-1/2"	.204"	15 - 6296	322
16-1/4"	5/8"			2-1/2"	.204"	15 - 6500	366
16-1/4"	5/8"			2-1/2"	.204"	15 - 9487	349

BLADES 14/16



O.E.M. REPLACEMENT BLADES BY LENGTH

Length	Center Hole	Outside Hole	Center to Center	Width	Steel Thickness	Order No.	Page No.
16-1/4"	5/8"			2"	.240"	15 - 9967	319
16-1/4"	5/8"			2-1/2"	.204"	15 - 9988	349
16-17/64"	13/32"		2-9/16"	2-13/64"	.160"	15 - 10199	381
16-1/2"	3/4"			3"	.000"	15 - 11564	341
16-1/2"	9/16"			2-1/4"	.204"	15 - 12251	347
16-1/2"	3/8"			2"	.160"	15 - 13335	366
16-1/2"	5/8"			2-1/2"	.204"	15 - 13975	416
16-1/2"	57/64"			2-1/2"	.250"	15 - 14096	377
16-1/2"	3/8"			2-3/4"	.160"	15 - 2169	400
16-1/2"	5/8"			2-1/2"	.204"	15 - 3403	347
16-1/2"	1-3/32"			2-1/4"	.095"	15 - 50102	363
16-1/2"					.160"	15 - 50297	366
16-1/2"	5/8"			3"	.204"	15 - 6009	379
16-1/2"	5/8"			2-1/2"	.204"	15 - 6115	338
16-1/2"	5/8"			2-1/2"	.204"	15 - 6116	338
16-1/2"	5/8"			2-1/2"	.204"	15 - 6222	372
16-1/2"	3/4"	5/16"		2-1/2"	.204"	15 - 6240	341
16-1/2"	5/8"			2-1/2"	.204"	15 - 6300	322
16-1/2"	5/8"			2-1/2"	.204"	15 - 6472	400
16-1/2"	3/4"			2-1/4"	.187"	15 - 825	346
16-5/8"				2-1/2"	.204"	15 - 10377	329
16-5/8"				2-1/2"	.204"	15 - 12475	322
16-5/8"	3/4"			2-1/2"	.180"	15 - 3326	328
16-5/8"	11/16"	11/32"		2"	.204"	15 - 3387	377
16-5/8"	3/4"			2-1/2"	.204"	15 - 6060	328
16-5/8"	13/16"			2-1/2"	.204"	15 - 6206	373
16-5/8"	23/32"			2"	.204"	15 - 6208	377
16-5/8"	13/16"			2-1/2"	.204"	15 - 6223	373
16-5/8"	13/16"			2-1/2"	.204"	15 - 6314	322
16-5/8"	13/16"			2-1/2"	.204"	15 - 6420	322
16-11/16"	3/4"	13/32"		2"	.150"	15 - 2082	399
16-11/16"					.204"	15 - 50295	406
16-3/4"				2-1/2"	.204"	15 - 9907	330
16-13/16"	1/2"			2-1/2"	.204"	15 - 6185	400
16-27/32"				2"	.150"	15 - 50063	371
16-7/8"	21/32"			2-1/2"	.125"	15 - 6187	408
16-31/32"	1/2"			2-1/2"	.204"	15 - 6436	369
17"				2-1/2"	.240"	15 - 10284	373
17"				2-1/2"	.204"	15 - 10291	373
17"	3/4"			3"	.204"	15 - 10361	341
17"				2-1/2"	.150"	15 - 10634	373
17"	5/8"			2"	.204"	15 - 1066	345
17"	7"			2-3/4"	.160"	15 - 11595	373
17"	7"			2-3/4"	.160"	15 - 11596	373
17"				2-1/2"	.204"	15 - 12821	373
17"				2-1/2"	.160"	15 - 12920	373

BLADES



O.E.M. REPLACEMENT BLADES BY LENGTH

Length	Center Hole	Outside Hole	Center to Center	Width	Steel Thickness	Order No.	Page No.
17"	5/8"			2"	.204"	15 - 3372	343
17"	5/8"			2"	.240"	15 - 6013	319
17"	1/2"			2-1/2"	.204"	15 - 6035	401
17"	3/8"	3/8"		2"	.204"	15 - 6068	338
17"	5/8"			2-1/2"	.187"	15 - 6088	345
17"	5/8"			2-1/2"	.240"	15 - 6181	360
17"	5/8"			2-1/2"	.240"	15 - 6204	361
17"	5/8"			2-1/2"	.240"	15 - 6214	360
17"	5/8"			2-1/2"	.204"	15 - 6224	343
17"	5/8"			2-1/2"	.204"	15 - 6298	322
17"	1/2"			2-1/2"	.204"	15 - 6426	322
17"	5/8"			3"	.240"	15 - 6442	343
17"	11/16"			2-1/2"	.187"	15 - 6766	345
17"	11/16"			2-1/2"	.187"	15 - 6782	345
17"	11/16"			2-1/2"	.204"	15 - 6785	322
17"	5/8"			2-1/2"	.240"	15 - 6790	343
17-3/16"	11/16"			2-1/2"	.204"	15 - 6012	373
17-3/16"	3/4"			2-1/2"	.204"	15 - 6082	341
17-1/4"	3/8"	5/16"		2-1/2"	.204"	15 - 3356	382
17-1/4"	3/8"	5/16"		2"	.150"	15 - 997	382
17-5/16"		21/64"		2-1/2"	.187"	15 - 1034	385
17-11/32"	5/8"			2-1/4"	.187"	15 - 13177	328
17-3/8"	3/8"			2-1/4"	.187"	15 - 6195	330
17-3/8"				2-1/4"	.160"	15 - 6196	330
17-3/8"				2-1/4"	.187"	15 - 6264	330
17-1/2"	15/16"			3"	.204"	15 - 11773	350
17-1/2"	15/16"			3"	.204"	15 - 11774	350
17-1/2"	15/16"			3"	.204"	15 - 11775	350
17-1/2"	15/16"			3"	.204"	15 - 11776	322
17-1/2"	15/16"			3"	.204"	15 - 12003	350
17-1/2"	5/8"			2-1/4"	.160"	15 - 12273	408
17-1/2"	5/8"			2-1/4"	.187"	15 - 12362	408
17-41/64"				2-1/4"	.150"	15 - 6470	389
17-11/16"	5/8"			2"	.240"	15 - 3381	361
17-11/16"	5/8"			2-1/2"	.240"	15 - 6203	361
17-3/4"				2-1/2"	.204"	15 - 13361	367
17-3/4"				2-1/2"	.204"	15 - 13367	367
17-53/64"	25/64"		2-23/64"	2-23/64"	.204"	15 - 10203	395
17-7/8"	5/8"			3"	.240"	15 - 10372	370
17-7/8"	5/8"			3"	.204"	15 - 10972	369
17-7/8"				5/8"		15 - 11556	370
17-7/8"				5/8"		15 - 11557	370
17-7/8"	5/8"			2-1/2"	.204"	15 - 13976	416
17-7/8"	1/2"				.204"	15 - 50287	367
17-57/64"				2-1/2"	.188"	15 - 12809	342
17-57/64"				2-1/2"	.156"	15 - 12909	342

14/16

BLADES



O.E.M. REPLACEMENT BLADES BY LENGTH

Length	Center Hole	Outside Hole	Center to Center	Width	Steel Thickness	Order No.	Page No.
17-29/32"	3/4"			2-1/2"	.204"	15 - 11250	342
17-29/32"	3/4"			2-1/2"	.150"	15 - 11479	341
17-29/32"				2-1/2"	.150"	15 - 11480	341
17-29/32"				2-1/2"	.187"	15 - 11506	341
17-29/32"				2-1/2"	.187"	15 - 11507	341
17-29/32"	5/8"			2-1/2"	.204"	15 - 6291	350
17-15/16"	5/8"			2-1/2"	.160"	15 - 6178	350
18"	5/8"			2-1/2"	.204"	15 - 10071	351
18"	5/8"	1/4"		2-1/2"	.150"	15 - 1010	336
18"	3/8"	5/16"		2"	.150"	15 - 1014	382
18"	5/8"			2-1/2"	.204"	15 - 10173	318
18"	5/8"			2-1/2"	.204"	15 - 10719	351
18"	1/2"			2-1/2"	.240"	15 - 11033	359
18"	15/16"			2-1/2"	.204"	15 - 11241	351
18"	15/16"			2-1/2"	.204"	15 - 11267	351
18"	15/16"			2-1/2"	.204"	15 - 11450	351
18"	15/16"			2-1/2"		15 - 11451	352
18"	15/16"			2-1/2"	.204"	15 - 11495	351
18"				3"	.187"	15 - 12121	323
18"				2-1/2"	.204"	15 - 12124	367
18"	9/16"			2-1/4"	.204"	15 - 12375	347
18"	5/8"			2-1/2"	.204"	15 - 13016	323
18"	1/2"			2-1/2"	.240"	15 - 13463	359
18"				2-1/2"	.203"	15 - 14391	368
18"	5/8"			2-1/2"	.240"	15 - 2173	334
18"	1/2"			2-1/2"	.187"	15 - 3361	408
18"	5/8"			2-1/2"	.204"	15 - 3374	338
18"	1/2"			2"	.204"	15 - 3379	359
18"	1/2"			2"	.204"	15 - 3380	359
18"	5/8"			2"	.187"	15 - 3394	409
18"	5/8"			2-1/2"	.204"	15 - 3401	336
18"	5/8"			2-1/2"	.204"	15 - 3404	347
18"	1/2"			2-1/2"	.187"	15 - 3405	408
18"	5/8"			3"	.204"	15 - 3442	380
18"	5/8"			2-27/32"	.117"	15 - 50022	381
18"				3"	.095"	15 - 50034	346
18"				2-1/4"	.187"	15 - 50252	330
18"				2-1/4"	.187"	15 - 50253	330
18"						15 - 50289	367
18"	5/8"			2-1/2"	.204"	15 - 6014	338
18"				2-1/4"	.150"	15 - 6123	330
18"	5/8"			2-1/2"	.204"	15 - 6183	337
18"	1/2"			2-1/2"	.204"	15 - 6217	351
18"	5/8"			2-1/2"	.204"	15 - 6294	323
18"	1/2"			2-1/2"	.204"	15 - 6309	322
18"	1/2"			2-1/2"	.240"	15 - 6323	359

BLADES



O.E.M. REPLACEMENT BLADES BY LENGTH

Length	Center Hole	Outside Hole	Center to Center	Width	Steel Thickness	Order No.	Page No.
18"	1/2"			2-1/2"	.187"	15 - 6410	322
18"		5/16"		2-1/4"	.134"	15 - 6448	387
18"	5/8"			2-1/2"	.204"	15 - 9229	323
18"	5/8"			2"	.240"	15 - 9968	319
18-3/64"	47/64"	23/64"		2-13/64"	.125"	15 - 50145	339
18-3/32"	45/64"		1-49/64"	2-13/64"	.160"	15 - 10198	381
18-1/8"	3/8"			2"	.134"	15 - 3447	393
18-1/8"				2"	.134"	15 - 50030	406
18-1/8"				3"	.095"	15 - 50122	414
18-1/8"					.204"	15 - 50296	406
18-1/8"				2-1/4"	.134"	15 - 6018	389
18-9/64"	3/4"			2"	.203"	15 - 10094	399
18-5/32"	3/8"			2"	.150"	15 - 1085	393
18-3/16"				2-1/4"	.150"	15 - 1124	389
18-3/16"			2-1/2"	2-1/4"	.117"	15 - 11310	339
18-3/16"			2-1/2"	2-1/4"	.117"	15 - 11311	339
18-3/16"				2-1/4"	.150"	15 - 50098	363
18-3/16"	13/32"	5/16"		3"	.150"	15 - 6143	382
18-1/4"	3/8"			2-1/4"	.187"	15 - 6120	330
18-3/8"				2-1/4"	.150"	15 - 10841	330
18-3/8"				3"	.187"	15 - 11180	331
18-3/8"			3-1/2"	2-1/4"	.160"	15 - 11314	377
18-3/8"				3"	.187"	15 - 13239	331
18-7/16"				3-3/8"	.150"	15 - 50101	363
18-7/16"	3/4"	13/32"		2-3/4"	.187"	15 - 6084	346
18-7/16"	27/32"	27/64"		2-1/4"	.204"	15 - 6787	363
18-1/2"	5/8"	11/32"		2-1/4"	.150"	15 - 1033	358
18-1/2"				3"	.204"	15 - 11719	342
18-1/2"	5/8"			2-1/2"	.204"	15 - 11856	370
18-1/2"				3"	.204"	15 - 12963	382
18-1/2"				2-1/2"	.204"	15 - 13482	401
18-1/2"	5/8"			2-1/2"	.204"	15 - 13623	370
18-1/2"				2-1/2"	.203"	15 - 14459	331
18-1/2"	3/4"	13/32"		2-1/2"	.187"	15 - 2078	399
18-1/2"	3/4"	13/32"		2"	.187"	15 - 2079	399
18-1/2"	3/4"	13/32"		2"	.187"	15 - 6069	338
18-1/2"	11/16"			2"	.187"	15 - 6101	346
18-1/2"	1-7/32"			2-1/4"	.150"	15 - 6104	327
18-1/2"	3/4"			3"	.204"	15 - 6239	342
18-5/8"				2-3/4"	.187"	15 - 11491	374
18-5/8"	23/32"			2-1/2"	.250"	15 - 14095	378
18-5/8"	57/64"			2-1/2"	.250"	15 - 14483	378
18-5/8"	57/64"			2-1/2"	.250"	15 - 14488	378
18-5/8"				2-1/2"	.134"	15 - 50031	367
18-5/8"				2-1/4"	.150"	15 - 50113	363
18-5/8"	3/8"			2-1/16"	.134"	15 - 6024	393

14/16

BLADES



O.E.M. REPLACEMENT BLADES BY LENGTH

Length	Center Hole	Outside Hole	Center to Center	Width	Steel Thickness	Order No.	Page No.
18-5/8"	13/16"			2-1/2"	.204"	15 - 6192	374
18-5/8"	13/16"			2-1/2"	.204"	15 - 6221	374
18-5/8"	13/16"			2-1/2"	.204"	15 - 6315	323
18-11/16"	1-1/8"			2-1/2"	.240"	15 - 6265	378
18-11/16"				2-1/2"	.204"	15 - 6738	374
18-45/64"				2-1/2"	.134"	15 - 50060	346
18-3/4"	3/4"			2"	.204"	15 - 3468	409
18-49/64"	5/8"		2-9/16"	2-13/64"	.160"	15 - 10201	381
18-27/32"	47/64"	23/64"		2-13/64"	.160"	15 - 50144	340
18-15/16"				2"	.150"	15 - 6488	368
18-15/16"	5/8"	17/32"		3"	.134"	15 - 848	379
19"	7/8"			2-1/2"	.249"	15 - 10072	323
19"	7/16"			2-1/2"	.125"	15 - 1011	409
19"	3/8"	5/16"		2"	.150"	15 - 1015	382
19"				2-3/4"	.204"	15 - 10292	374
19"	3/4"			3"	.204"	15 - 10362	342
19"	9/16"			2-1/2"	.204"	15 - 11662	347
19"				2-1/4"	.125"	15 - 12893	342
19"				2-1/4"	.150"	15 - 13498	368
19"				2-1/4"	.150"	15 - 13500	368
19"	5/8"			2-1/2"	.240"	15 - 14076	368
19"	5/8"			2-1/2"	.240"	15 - 14077	368
19"	5/8"			2-1/2"	.240"	15 - 14078	368
19"				2-1/2"	.240"	15 - 14475	374
19"	13/32"		1-7/8"	2-1/4"	.134"	15 - 50254	389
19"	13/32"			3"	.150"	15 - 6126	382
19"				2-1/4"	.187"	15 - 6218	331
19"	1/2"			2-1/2"	.204"	15 - 6435	370
19"				2-1/2"	.000"	15 - 6480	374
19"	1-1/4"			2-1/4"	.125"	15 - 6760	358
19-1/8"					.240"	15 - 50294	368
19-1/4"				2-1/4"	.150"	15 - 12240	331
19-1/4"	3/8"			2-1/4"	.187"	15 - 6105	331
19-1/4"	5/8"			2-1/2"	.187"	15 - 6184	409
19-5/16"		5/16"		3"	.150"	15 - 1024	386
19-5/16"		5/16"		3"	.150"	15 - 1026	386
19-5/16"		5/16"		3"	.150"	15 - 11232	386
19-5/16"	5/8"			2-1/2"	.187"	15 - 3395	409
19-5/16"	13/32"	5/16"		3"	.150"	15 - 6006	382
19-5/16"				2-1/4"	.150"	15 - 6124	331
19-5/16"	3/4"			3"	.204"	15 - 6147	342
19-11/32"	3/8"			2-1/4"	.150"	15 - 3392	331
19-3/8"	3/4"			2-3/4"	.204"	15 - 11477	342
19-3/8"	27/32"			2-1/4"	.150"	15 - 6111	390
19-3/8"	13/32"			2-1/4"	.134"	15 - 6142	390
19-3/8"	3/4"	5/16"		3"	.204"	15 - 6238	342

14/16
BLADES

BLADES



O.E.M. REPLACEMENT BLADES BY LENGTH

Length	Center Hole	Outside Hole	Center to Center	Width	Steel Thickness	Order No.	Page No.
19-7/16"	53/64"	27/64"		2-1/4"	.150"	15 - 3437	363
19-7/16"	53/64"	27/64"		2-3/4"	.160"	15 - 3438	363
19-7/16"	1"			2-1/4"	.204"	15 - 6197	401
19-1/2"						15 - 11555	390
19-1/2"	15/16"			3"	.204"	15 - 11777	352
19-1/2"	15/16"			3"	.204"	15 - 11778	352
19-1/2"	15/16"			3"	.204"	15 - 11779	352
19-1/2"	15/16"			3"	.204"	15 - 11780	323
19-1/2"	15/16"			3"	.204"	15 - 12004	352
19-1/2"				3"	.204"	15 - 12562	375
19-1/2"	11/16"			2-1/2"	.204"	15 - 6011	374
19-1/2"	27/32"			2-1/4"	.134"	15 - 6017	390
19-1/2"	27/32"			2-1/4"	.187"	15 - 6119	390
19-1/2"	27/32"			2-3/4"	.134"	15 - 6146	390
19-1/2"	5/8"			2-3/4"	.187"	15 - 6150	363
19-1/2"	5/8"			2-3/4"	.187"	15 - 6151	363
19-1/2"	11/16"			2-1/2"	.204"	15 - 6186	375
19-1/2"	11/16"			2-1/2"	.204"	15 - 6421	323
19-1/2"	11/16"			3"	.204"	15 - 6737	374
19-1/2"	11/16"			3"	.204"	15 - 845	375
19-5/8"	3/8"			2-1/8"	.134"	15 - 6025	393
19-5/8"				2-1/4"	.134"	15 - 6190	331
19-11/16"	3/8"			2"	.134"	15 - 3406	393
19-7/8"	3/8"			1-3/4"	.150"	15 - 1074	356
19-15/16"	13/32"	13/32"		2-1/4"	.150"	15 - 2012	390
19-31/32"				3"	.095"	15 - 50121	414
20"	3/8"			2-3/4"	.150"	15 - 10066	390
20"	3/8"	5/16"		2"	.150"	15 - 1016	382
20"	5/8"			2-1/2"	.134"	15 - 1043	331
20"	7/16"	15/32"		2"	.187"	15 - 1058	372
20"	15/16"			2-1/2"	.204"	15 - 11469	354
20"	18"			2-3/16"	.150"	15 - 13215	340
20"	5/8"			2-1/2"	.240"	15 - 13419	344
20"	3/8"	5/16"		2"	.150"	15 - 3336	393
20"	5/8"	3/16"		2-3/4"	.160"	15 - 3423	413
20"	13/16"	3/8"		2"	.150"	15 - 6005	382
20"	5/8"			2-1/2"	.204"	15 - 6008	380
20"	5/8"	3/8"		2-1/2"	.134"	15 - 6037	331
20"	13/16"	3/8"		2-1/4"	.125"	15 - 6140	382
20"	5/8"	3/8"		2-1/4"	.134"	15 - 6235	332
20"	5/8"			2-1/2"	.240"	15 - 6270	409
20"		5/16"		2-1/4"	.125"	15 - 6438	387
20"		5/16"		2-1/4"	.125"	15 - 6439	387
20"	13/16"	3/8"		2-1/4"	.125"	15 - 6457	383
20-1/16"	13/32"	5/16"		3-5/16"	.095"	15 - 50246	406
20-1/8"	10"			2"	.160"	15 - 10739	406

BLADES 14/16



O.E.M. REPLACEMENT BLADES BY LENGTH

Length	Center Hole	Outside Hole	Center to Center	Width	Steel Thickness	Order No.	Page No.
20-1/8"					.117"	15 - 11317	396
20-5/32"	5/8"			2"	.204"	15 - 3421	415
20-3/16"	5/8"			2"	.204"	15 - 6467	415
20-13/64"	25/64"		2-23/64"	2-23/64"	.204"	15 - 10195	395
20-1/4"					.095"	15 - 11316	396
20-1/4"	3/8"			2-3/4"	.134"	15 - 6099	394
20-1/4"	7/16"		2-1/2"	2-1/2"	.134"	15 - 6275	409
20-1/4"	5/8"			2"	.204"	15 - 6432	415
20-5/16"	3/4"			2-1/2"	.204"	15 - 6254	328
20-5/16"		13/32"		2-1/4"	.134"	15 - 6428	363
20-23/64"	27/64"	21/64"		2"	.150"	15 - 50201	383
20-23/64"	27/64"	21/64"		2"	.150"	15 - 50202	383
20-3/8"	3/8"	3/8"		2-1/2"	.187"	15 - 1076	398
20-3/8"	27/32"			2-1/4"	.134"	15 - 6034	390
20-3/8"	27/32"			2-1/4"	.150"	15 - 6112	390
20-3/8"	27/32"			2-1/4"	.187"	15 - 6129	391
20-3/8"	27/32"			2-3/4"	.134"	15 - 6145	390
20-3/8"				2-1/4"	.134"	15 - 6475	390
20-7/16"	11/16"			2"	.204"	15 - 3388	378
20-15/32"	15/16"			2-1/4"	.240"	15 - 3389	378
20-1/2"	5/8"			2-1/2"	.203"	15 - 10249	352
20-1/2"	3/4"			3"	.204"	15 - 10383	342
20-1/2"	5/8"			2-1/2"	.204"	15 - 10667	334
20-1/2"	5/8"			3"	.204"	15 - 11139	353
20-1/2"	15/16"			2-1/2"	.204"	15 - 11224	353
20-1/2"	15/16"			3"	.204"	15 - 11242	352
20-1/2"	15/16"			2-1/2"	.240"	15 - 11248	353
20-1/2"	15/16"			2-1/2"	.240"	15 - 11249	353
20-1/2"	15/16"			2-1/2"	.204"	15 - 11496	353
20-1/2"	1-1/8"			2-1/2"	.240"	15 - 11558	378
20-1/2"	5/8"			2-1/2"	.240"	15 - 13624	361
20-1/2"	5/8"			2-1/2"	.204"	15 - 13977	416
20-1/2"	57/64"			2-1/2"	.250"	15 - 14481	378
20-1/2"	23/32"			2-1/2"	.250"	15 - 14482	378
20-1/2"	25/32"			2"	.187"	15 - 2120	375
20-1/2"	1"			2-1/4"	.250"	15 - 2164	361
20-1/2"	13/32"			2-3/4"	.160"	15 - 3322	328
20-1/2"	5/8"			2"	.240"	15 - 3339	361
20-1/2"	23/32"	23/64"		2-13/64"	.160"	15 - 50142	340
20-1/2"	23/32"	23/64"		2-13/64"	.160"	15 - 50143	340
20-1/2"	5/8"			2-1/2"	.240"	15 - 6083	344
20-1/2"	5/8"			2-1/2"	.240"	15 - 6180	334
20-1/2"	1-1/8"			2-1/2"	.240"	15 - 6209	378
20-1/2"	5/8"			2-1/2"	.240"	15 - 6213	361
20-1/2"	1/2"			2-1/2"	.204"	15 - 6216	352
20-1/2"	1/2"			2-1/2"	.204"	15 - 6250	352

14/16

BLADES

BLADES



O.E.M. REPLACEMENT BLADES BY LENGTH

Length	Center Hole	Outside Hole	Center to Center	Width	Steel Thickness	Order No.	Page No.
20-1/2"	29/32"			2-1/2"	.313"	15 - 6253	375
20-1/2"	5/8"			2-1/2"	.240"	15 - 6285	361
20-1/2"	5/8"			2-1/2"	.204"	15 - 6290	353
20-1/2"	5/8"			2-1/2"	.204"	15 - 6303	324
20-1/2"	5/8"			3"	.240"	15 - 6441	344
20-1/2"				5-1/8"	.160"	15 - 6482	327
20-1/2"				5-1/8"	.160"	15 - 6483	327
20-1/2"	11/16"			2-1/2"	.240"	15 - 6784	346
20-1/2"	5/8"			2-1/4"	.204"	15 - 9171	409
20-1/2"	1/2"			2-1/2"	.204"	15 - 9465	324
20-9/16"	25/64"	9/32"		2-3/16"	.160"	15 - 50241	414
20-9/16"	25/64"	9/32"		2-3/16"	.160"	15 - 50245	414
20-5/8"			3-1/2"	2-1/4"	.160"	15 - 11312	371
20-5/8"				2-1/4"	.160"	15 - 12118	377
20-5/8"				2-1/4"	.150"	15 - 50106	363
20-5/8"	5/8"			2-1/4"	.182"	15 - 6230	396
20-43/64"	27/32"			2-1/4"	.160"	15 - 50160	364
20-11/16"	5/8"		2-9/16"	2-13/64"	.160"	15 - 10202	381
20-11/16"				2-1/2"	.150"	15 - 10376	377
20-11/16"	3/8"	3/8"		2-3/4"	.160"	15 - 2007	401
20-11/16"	3/8"	3/8"		2-3/4"	.160"	15 - 6110	402
20-11/16"	3/4"	9/16"		2-1/4"	.150"	15 - 6173	378
20-11/16"	3/8"			2-3/4"	.160"	15 - 6317	324
20-11/16"	5/8"			2-1/2"	.240"	15 - 6433	415
20-11/16"	5/8"			2-1/2"	.240"	15 - 6434	416
20-3/4"	5/8"			2-1/2"	.134"	15 - 1057	379
20-3/4"	15/16"			3"	.204"	15 - 11781	354
20-3/4"	15/16"			3"	.204"	15 - 11782	354
20-3/4"	15/16"			3"	.204"	15 - 11783	354
20-3/4"	15/16"			3"	.204"	15 - 11784	324
20-3/4"	15/16"			3"	.204"	15 - 12005	354
20-3/4"	1-3/4"			2-5/8"	.134"	15 - 14657	364
20-3/4"	3/8"	3/8"		2-3/4"	.160"	15 - 2006	402
20-3/4"	3/8"			2-1/4"	.150"	15 - 3348	375
20-3/4"	13/32"			2-1/4"	.134"	15 - 9228	391
20-13/16"	13/32"	13/32"		2-1/4"	.134"	15 - 3390	391
20-13/16"	13/32"			2-1/4"	.134"	15 - 6039	391
20-27/32"	7/16"		2-7/16"	2-1/4"	.015"	15 - 10928	352
20-7/8"	7/8"			2-3/4"	.187"	15 - 1087	402
20-7/8"	3/8"			2-1/4"	.150"	15 - 2051	327
20-7/8"	27/32"	13/32"		2-1/4"	.150"	15 - 2160	364
20-7/8"				3"	.125"	15 - 50125	335
20-7/8"	27/32"	13/32"		2-1/4"	.150"	15 - 6092	364
20-7/8"	13/32"			2-3/4"	.150"	15 - 6160	391
20-7/8"		13/32"		2-1/4"	.095"	15 - 6431	364
20-7/8"	27/32"			2-1/4"	.160"	15 - 6458	364

BLADES 14/16



O.E.M. REPLACEMENT BLADES BY LENGTH

Length	Center Hole	Outside Hole	Center to Center	Width	Steel Thickness	Order No.	Page No.
20-7/8"		5/16"		2-1/4"	.240"	15 - 824	417
20-7/8"	5/8"	17/32"		3"	.134"	15 - 849	379
20-29/32"	25/32"			4-1/8"	.095"	15 - 50153	364
20-15/16"	13/16"	3/8"		2"	.150"	15 - 6096	383
20-15/16"	7/16"	3/8"		2-9/16"	.134"	15 - 6256	410
21"	7/16"			2-5/8"	.125"	15 - 1006	410
21"				2-1/2"	.240"	15 - 10073	324
21"	7/16"	3/8"		2-5/8"	.125"	15 - 1008	410
21"	1/2"			2-1/2"	.240"	15 - 10102	359
21"	7/16"			2-5/8"	.125"	15 - 1012	410
21"	3/8"	5/16"		2"	.150"	15 - 1017	383
21"	5/8"			2-1/2"	.204"	15 - 10174	318
21"	3/8"	3/8"		2-1/2"	.150"	15 - 1036	337
21"	3/4"			3"	.204"	15 - 10363	342
21"	5/8"			3"	.240"	15 - 10373	370
21"	3/8"			2-3/4"	.125"	15 - 10458	375
21"	3/4"			2-3/4"	.187"	15 - 1053	395
21"				2-1/2"	.150"	15 - 10635	375
21"	5/8"			2-1/2"	.204"	15 - 10720	368
21"	5"			3"	.204"	15 - 10930	398
21"	5/8"			3"	.204"	15 - 10971	370
21"	7"			2-3/4"	.160"	15 - 11594	376
21"	9/16"			2-1/2"	.020"	15 - 11663	347
21"				2-1/2"	.204"	15 - 12125	368
21"				2-3/4"	.204"	15 - 12380	376
21"	5/8"			2-1/4"	.150"	15 - 12732	332
21"	5/8"			2-1/2"	.240"	15 - 13017	324
21"			7/16"	2-1/4"	.150"	15 - 13260	354
21"	1/2"			2-1/2"	.240"	15 - 13464	360
21"				2-1/2"	.203"	15 - 14392	369
21"	5/8"			2-1/2"	.240"	15 - 2174	337
21"	5/8"			2-1/2"	.240"	15 - 3402	337
21"	1/2"			2"	.204"	15 - 3424	360
21"	5/8"			2-1/2"	.204"	15 - 3434	362
21"	13/16"	3/8"		2-1/2"	.150"	15 - 6042	383
21"		13/32"		2-3/4"	.134"	15 - 6122	375
21"				2-1/4"	.150"	15 - 6125	332
21"	27/32"	3/8"		2-1/4"	.125"	15 - 6139	383
21"	5/8"			2-1/2"	.204"	15 - 6141	339
21"	1/2"			2-1/2"	.240"	15 - 6167	359
21"	1/2"			2-1/2"	.240"	15 - 6168	360
21"	5/8"	7/32"		2-3/4"	.160"	15 - 6176	413
21"				2-1/4"	.150"	15 - 6189	332
21"				2-1/4"	.187"	15 - 6262	332
21"	5/8"			2-1/2"	.240"	15 - 6272	337
21"	13/16"	3/8"		2-1/4"	.134"	15 - 6277	402

14/16

BLADES

BLADES



O.E.M. REPLACEMENT BLADES BY LENGTH

Length	Center Hole	Outside Hole	Center to Center	Width	Steel Thickness	Order No.	Page No.
21"	5/8"			2-1/2"	.204"	15 - 6299	324
21"	7/16"		2-7/16"	2-1/2"	.160"	15 - 6308	324
21"	1/2"			2-1/2"	.204"	15 - 6311	324
21"	1/2"			2-1/2"	.240"	15 - 6401	360
21"		5/16"		2-1/4"	.125"	15 - 6423	387
21"	17/64"	13/32"		2-5/8"	.095"	15 - 6430	364
21"		5/16"		2-1/4"	.134"	15 - 6450	387
21"				2-1/2"	.000"	15 - 6479	375
21"				5-5/8"	.150"	15 - 6484	332
21"				5-5/8"	.150"	15 - 6485	332
21"	5/8"			2-1/2"	.204"	15 - 9230	324
21"	5/8"	3/8"		2-1/4"	.134"	15 - 9810	332
21"	5/8"			2"	.240"	15 - 9969	319
21"	5/8"			2-1/2"	.240"	15 - 9987	357
21-1/16"				2-1/4"	.150"	15 - 12563	332
21-1/16"	7/16"	3/8"		2-3/4"	.134"	15 - 6002	410
21-3/16"		5/16"		3"	.150"	15 - 1031	386
21-3/16"		5/16"		3"	.150"	15 - 1032	386
21-3/16"		5/16"	2-1/2"	3"	.150"	15 - 11233	386
21-3/16"				2-1/4"	.170"	15 - 12852	402
21-3/16"	13/32"	5/16"		3"	.150"	15 - 6028	383
21-3/16"	13/32"	7/16"		3"	.150"	15 - 6127	383
21-3/16"	3/4"	5/16"		3"	.204"	15 - 6237	343
21-3/16"	13/32"	5/16"		3"	.150"	15 - 6295	325
21-3/16"				2-1/4"	.134"	15 - 6476	391
21-1/4"	3/4"			2-3/4"	.204"	15 - 11475	343
21-1/4"				4-1/4"	.117"	15 - 12615	364
21-1/4"	3/8"	17/32"		2-1/2"	.204"	15 - 6078	343
21-1/4"	27/32"			2-3/4"	.134"	15 - 6144	391
21-1/4"	27/32"			2-1/4"	.150"	15 - 6162	391
21-1/4"	27/32"			2-1/4"	.150"	15 - 6166	391
21-1/4"	27/32"			2-1/2"	.150"	15 - 6460	325
21-1/4"	27/32"			2-1/4"	.187"	15 - 9897	391
21-3/8"	13/16"			2-1/2"	.203"	15 - 10074	376
21-3/8"	7"			2-3/4"	.155"	15 - 11593	376
21-3/8"	5/8"			2-1/2"	.250"	15 - 14442	344
21-3/8"	5/8"			2-1/2"	.250"	15 - 14467	344
21-27/64"	43/64"			2-1/2"	.156"	15 - 12919	376
21-15/32"	11/16"			2-1/2"	.160"	15 - 9959	376
21-1/2"	1/2"			2-1/2"	.204"	15 - 10209	318
21-1/2"	3/8"			2-1/4"	.150"	15 - 3366	327
21-1/2"	1/2"			2-1/2"	.187"	15 - 6251	411
21-1/2"	1"	7/16"		2-1/2"	.187"	15 - 6258	412
21-5/8"	3/8"		1-7/8"	2-1/4"	.135"	15 - 11868	392
21-5/8"	5/8"			2-1/4"	.160"	15 - 13129	323
21-5/8"	5/8"	3/8"		2-1/2"	.150"	15 - 6038	332

BLADES 14/16



O.E.M. REPLACEMENT BLADES BY LENGTH

Length	Center Hole	Outside Hole	Center to Center	Width	Steel Thickness	Order No.	Page No.
21-5/8"	3/8"			2"	.187"	15 - 6286	394
21-43/64"	5/8"			2-1/4"	.160"	15 - 11821	411
21-23/32"	25/64"		2-23/64"	2-13/64"	.160"	15 - 10204	395
21-23/32"	7/16"			2-1/4"	.150"	15 - 10929	411
21-23/32"	7/16"			2-1/4"	.150"	15 - 12649	323
21-3/4"	5/8"			2-1/2"	.150"	15 - 1044	333
21-3/4"	13/32"			3-15/16"	.134"	15 - 6138	394
21-3/4"				2-1/4"	.240"	15 - 6284	417
21-7/8"	13/32"			2-1/4"	.134"	15 - 6471	392
21-15/16"	13/32"	13/32"		2-1/4"	.150"	15 - 2013	392
21-15/16"	5/8"	7/32"		2-3/4"	.160"	15 - 6177	413
22"	3/8"	5/16"		2"	.150"	15 - 1018	383
22"	13/32"	5/16"		2"	.187"	15 - 3407	384
22"	5/8"	3/16"		2-3/4"	.187"	15 - 3445	413
22"	5/8"	3/16"		2-3/4"	.187"	15 - 3446	413
22"	13/16"	3/8"		2"	.150"	15 - 6004	383
22"	13/32"			2-1/4"	.150"	15 - 6174	392
22"	13/16"	3/8"		2-1/4"	.125"	15 - 6212	384
22"	5/8"			2-1/4"	.204"	15 - 6228	396
22"	3/8"			2-1/2"	.187"	15 - 6229	396
22"	5/8"	3/8"		2-1/4"	.134"	15 - 6236	333
22"	5/8"	3/16"		2-3/4"	.187"	15 - 6414	325
22"		5/16"		2-1/4"	.125"	15 - 6424	387
22"		5/16"		2-1/4"	.125"	15 - 6425	388
22"				2-1/4"	.240"	15 - 9176	417
22-3/16"					.240"	15 - 50291	369
22-3/16"	3/4"			2-1/2"	.204"	15 - 6077	343
22-1/4"	3/4"			2"	.203"	15 - 10096	399
22-1/4"	15/16"			2-1/2"	.187"	15 - 14491	354
22-1/2"	5/8"			3"	.204"	15 - 11721	371
22-3/4"	15/16"			3"	.204"	15 - 11785	354
22-3/4"	15/16"			3"	.204"	15 - 11786	354
22-3/4"	15/16"			3"	.204"	15 - 11787	354
22-3/4"	15/16"			3"	.204"	15 - 11788	325
22-3/4"	15/16"			3"	.204"	15 - 12027	354
23"				2-3/4"	.150"	15 - 12242	333
23"				2-1/2"	.150"	15 - 12721	333
23"				2-1/4"	.187"	15 - 12974	333
23"	5/8"			2-1/2"	.187"	15 - 6135	411
23"	5/8"			2-1/2"	.187"	15 - 6136	411
23-1/4"				3"	.150"	15 - 12956	386
23-5/16"	5/8"			2-1/2"	.240"	15 - 12616	344
23-5/16"	5/8"			2-1/2"	.240"	15 - 13987	344
23-1/2"	5/8"			2-1/2"	.187"	15 - 6231	396
23-7/8"	1/2"			2-3/4"	.240"	15 - 6628	371
23-7/8"	1/2"			2-3/4"	.240"	15 - 6728	371

BLADES



O.E.M. REPLACEMENT BLADES BY LENGTH

Length	Center Hole	Outside Hole	Center to Center	Width	Steel Thickness	Order No.	Page No.
24"	5/8"			3"	.240"	15 - 10797	371
24"	5/8"			2-1/2"	.240"	15 - 6404	334
24"	5/8"			3"	.240"	15 - 6833	334
24-13/32"	5/8"			3"	.204"	15 - 6481	355
24-7/16"	1-1/8"			2-1/2"	.240"	15 - 12995	379
24-7/16"	23/32"				.160"	15 - 50162	340
24-7/16"	23/32"				.160"	15 - 50163	340
24-1/2"	5/8"			3"	.204"	15 - 10421	355
24-1/2"	15/16"			3"	.204"	15 - 11229	355
24-1/2"	15/16"			3"	.204"	15 - 11244	355
24-1/2"	15/16"			3"	.204"	15 - 11498	355
24-1/2"	15/16"			2-1/2"	.204"	15 - 11501	355
24-1/2"	5/8"			2-1/2"	.204"	15 - 6026	334
24-1/2"	5/8"			2-1/2"	.240"	15 - 6171	362
24-1/2"	1"			2-1/2"	.204"	15 - 6210	416
24-1/2"	1"	7/16"		2-1/2"	.187"	15 - 6257	412
24-1/2"	1"	7/16"		2-1/2"	.187"	15 - 6259	412
24-1/2"	5/8"			3"	.204"	15 - 9882	355
24-1/2"	5/8"			2-1/2"	.204"	15 - 9883	325
24-9/16"	15/16"			2-1/2"	.240"	15 - 6207	379
24-3/4"	15/16"			3"	.204"	15 - 11789	355
24-3/4"	15/16"			3"	.204"	15 - 11790	355
24-3/4"	15/16"			3"	.204"	15 - 11791	355
24-3/4"	15/16"			3"	.204"	15 - 11792	325
24-3/4"	15/16"			3"	.204"	15 - 12028	355
24-3/4"				2-1/2"	.295"	15 - 13593	371
24-3/4"	1/2"			2-1/2"	.204"	15 - 9986	411
24-15/16"	29/32"			2-1/2"	.313"	15 - 6252	376
24-15/16"	29/32"			2-1/2"	.313"	15 - 6255	376
25"	1-1/16"	35/64"		2-3/4"	.187"	15 - 1103	402
25"				3"	.250"	15 - 12643	376
25"	5/8"			2-1/2"	.240"	15 - 3329	337
25"	3/4"			2-1/2"	.240"	15 - 3362	411
25"	1/2"			2-1/2"	.240"	15 - 6402	360
25"	1/2"			2-1/2"	.240"	15 - 6403	360
25-1/16"	5/8"	7/32"		2-3/4"	.187"	15 - 6169	413
25-1/16"	5/8"	7/32"		2-3/4"	.187"	15 - 6170	413
25-3/16"	1/2"			2-1/2"	.240"	15 - 6271	412
25-7/32"	5/8"			2-1/2"	.187"	15 - 6001	412
25-11/16"	3/4"			2-3/4"	.187"	15 - 6232	396
26"	1-1/16"	35/64"		2-3/4"	.187"	15 - 1091	403
26"	1/2"			2-1/2"	.204"	15 - 6406	356
26"	1/2"			2-1/2"	.204"	15 - 6407	356
27-7/8"	7/16"	3/8"		2-3/4"	.187"	15 - 6445	328
28"	1-1/16"	35/64"		2-3/4"	.187"	15 - 1098	403
28"	1-1/16"			2-3/4"	.187"	15 - 11238	403

BLADES 14/16



O.E.M. REPLACEMENT BLADES BY LENGTH

Length	Center Hole	Outside Hole	Center to Center	Width	Steel Thickness	Order No.	Page No.
28"	3/4"	25/64"		2-3/4"	.180"	15 - 3323	328
28"	1-1/16"	35/64"		2-3/4"	.160"	15 - 6108	403
28"	1-1/16"			2-3/4"	.187"	15 - 6302	326
29-1/2"	11/16"			2-1/2"	.204"	15 - 6327	376
29-1/2"	11/16"			2-1/2"	.204"	15 - 6328	376
29-1/2"	11/16"			2-1/2"	.204"	15 - 6329	376
29-9/16"	5/8"	31/64"		2-3/4"	.187"	15 - 6153	365
29-5/8"				2-1/4"	.170"	15 - 12957	333
29-3/4"		31/64"		2-3/4"	.160"	15 - 2165	365
29-7/8"	1/2"			2-3/4"	.187"	15 - 6468	394
30"		21/64"		2-3/4"	.160"	15 - 1023	386
30"	7/8"			2-3/4"	.187"	15 - 1089	346
30"	1-1/16"	35/64"		2-3/4"	.187"	15 - 1092	403
30"	3/4"	25/64"		2-3/4"	.187"	15 - 2137	328
30"				2-1/4"	.150"	15 - 2166	392
30"	3/8"	5/16"		3"	.150"	15 - 3354	384
30"	27/32"			2-3/4"	.160"	15 - 3430	392
30"	27/32"			2-1/4"	.187"	15 - 3443	392
30"				2-3/4"	.160"	15 - 6010	392
30"	27/32"			2-3/4"	.160"	15 - 6027	392
30"	1-1/16"	35/64"		2-3/4"	.187"	15 - 6029	403
30"	27/32"			2-3/4"	.150"	15 - 6215	392
30"	1-1/16"			2-3/4"	.187"	15 - 6297	326
31-3/8"	5/8"				.187"	15 - 2171	412
31-3/8"	5/8"			2-1/2"	.187"	15 - 6118	412
33"	1-1/16"	35/64"		2-3/4"	.187"	15 - 1060	403
33"	1-1/16"			2-3/4"	.187"	15 - 11239	403
33"	1-1/16"	35/64"		2-3/4"	.160"	15 - 6109	403
33"	1-1/16"			2-3/4"	.187"	15 - 6301	326
410"				2-1/4"	.187"	15 - 50062	371
430"						15 - 50290	366
630"				3"	.187"	15 - 50127	328

BLADES



**UNIVERSAL COMMERCIAL
MULCHER BLADE**



Order No.	Length
14 - 10243	16" (406.4 mm)
14 - 10244	18" (457.2 mm)

Blade Spec: Center Hole 1" (25.4mm), Width 2-1/2" (63.5mm), Thickness .150 (3.8mm). Includes washer and bus-ing kit 3/8" - 7/8".

**UNIVERSAL
MULCHER BLADE**



Order No.	Length
14 - 6052	18" (457.2 mm)
14 - 6053	19" (482.6 mm)
14 - 6044	20" (508 mm)
14 - 6045	21" (533.4 mm)
14 - 6046	22" (558.8 mm)

Blade Spec: Outside Hole 3/8" x 1-1/2" (9.53mm x 38.1mm), Center Hole 3/8" (9.5mm), Outside Hole 3/8" x 1-1/2" (9.53mm x 38.1mm), Width 2-1/4" (57.2mm), Thickness .150 (3.8mm)

**UNIVERSAL COMMERCIAL
MULCHER BLADE**



Order No.	Length
14 - 6322	22" (558.8 mm)

Blade Spec: Center Hole 3/8" (9.5mm), Width 2-1/2" (63.5mm), Thickness .150 (3.8mm)

**UNIVERSAL COMMERCIAL
MULCHER BLADE**



Order No.	Length
14 - 10631	20" (508 mm)
14 - 10633	22" (558.8 mm)

Blade Spec: Center Hole 1" (25.4mm), Width 2-1/2" (63.5mm), Thickness .150" (3.8mm)

**UNIVERSAL
MULCHER BLADE**



Order No.	Length	
14 - 6245	20" (508 mm)	
14 - 16245 cd	20" (508 mm)	MIN005
14 - 6246	21" (533.4 mm)	
14 - 16246 cd	21" (533.4 mm)	MIN005
14 - 6247	22" (558.8 mm)	
14 - 16247 cd	22" (558.8 mm)	MIN005

Blade Spec: Outside Hole 3/8" x 1-1/2" (9.53mm x 38.1mm), Center Hole 1" (25.4mm), Outside Hole 3/8" x 1-1/2" (9.53mm x 38.1mm), Width 2-1/4" (57.2mm), Thickness .150 (3.8mm). Carded blades include Blade Reducers.

**UNIVERSAL
THATCHER BLADE**



Order No.	Length	
14 - 6248	16" (406.4 mm)	
14 - 16248 (cd)	16" (406.4 mm)	MIN005
14 - 8385	Replacement Springs, Hardware & Blade Reducers	

Blade Spec: Outside Hole 3/8" x 1-1/2" (9.53mm x 38.1mm), Center Hole 1" (25.4mm), Outside Hole 3/8" x 1-1/2" (9.53mm x 38.1mm), Width 2-1/4" (57.2mm), Thickness .150 (3.8mm)

14/16
BLADES



**UNIVERSAL COMMERCIAL
MULCHER BLADE**



Order
No. **Length**
14 - 50288 19" (482.6 mm)

Blade Spec: Center Hole 12 mm, Width 2-1/2" (63.5mm), Thickness .150 (3.8mm)

**UNIVERSAL
THATCHER BLADE**



Order
No. **Length**
14 - 2009 16" (406.4 mm)
14 - 2008 Replacement Springs &
Hardware.
(14-2009 hardware included)

Blade Spec: Outside Hole 3/8" x 1-1/2" (9.53mm x 38.1mm), Center Hole 3/8" (9.5mm), Outside Hole 3/8" x 1-1/2" (9.53mm x 38.1mm), Width 2-1/4" (57.2mm), Thickness .150 (3.8mm)

**UNIVERSAL
SUPER-LIFT BLADES**



Order
No. **Length**
14 - 2094 18" (457.2 mm)

Blade Spec: Outside Hole 3/8" x 1-1/2" (9.53mm x 38.1mm), Center Hole 3/8" (9.5mm), Outside Hole 3/8" x 1-1/2" (9.53mm x 38.1mm), Width 2-1/4" (57.2mm), Thickness .150 (3.8mm)

**1" HOLE
STRAIGHT SUCTION LIFT**



Order
No. **Length**

14 - 951	18" (457.2 mm)	
14 - 952	19" (482.6 mm)	
14 - 10952(cd)	19" (482.6 mm)	MIN005
14 - 953	20" (508 mm)	
14 - 10953(cd)	20" (508 mm)	MIN005
14 - 954	21" (533.4 mm)	
14 - 10954(cd)	21" (533.4 mm)	MIN005
14 - 955	22" (558.8 mm)	
14 - 10955(cd)	22" (558.8 mm)	MIN005

Blade Spec: Outside Hole 3/8" x 1-1/2" (9.53mm x 38.1mm), Center Hole 1" (25.4mm), Outside Hole 3/8" x 1-1/2" (9.53mm x 38.1mm), Width 2-1/4" (57.2mm), Thickness .150 (3.8mm) . Only carded blades include Blade Reducers.

**3/8" HOLE
STRAIGHT SUCTION LIFT**



Order
No. **Length**

14 - 977	18" (457.2 mm)
14 - 978	19" (482.6 mm)
14 - 979	20" (508 mm)
14 - 980	21" (533.4 mm)
14 - 981	22" (558.8 mm)

Blade Spec: Outside Hole 3/8" x 1-1/2" (9.53mm x 38.1mm), Center Hole 3/8" (9.5mm), Outside Hole 3/8" x 1-1/2" (9.53mm x 38.1mm), Width 2-1/4" (57.2mm), Thickness .150 (3.8mm), Pin Hole 13/64" (5.2mm). Carded blades include Blade Reducers.

14/16

BLADES

BLADES



**1" HOLE
OFFSET SUCTION LIFT**



Order No.	Length
14 - 965	21" (533.4 mm)

Blade Spec: Outside Hole 3/8" x 1-1/2" (9.53mm x 38.1mm), Center Hole 1" (25.4mm), Outside Hole 3/8" x 1-1/2" (9.53mm x 38.1mm), Width 2-1/4" (57.2mm), Thickness .150 (3.8mm)

**3/8" HOLE
OFFSET SUCTION LIFT**



Order No.	Length
14 - 988	18" (457.2 mm)
14 - 990	20" (508 mm)
14 - 991	21" (533.4 mm)
14 - 992	22" (558.8 mm)

Blade Spec: Outside Hole 3/8" x 1-1/2" (9.53mm x 38.1mm), Center Hole 3/8" (9.5mm), Outside Hole 3/8" x 1-1/2" (9.53mm x 38.1mm), Width 2-1/4" (57.2mm), Thickness .150 (3.8mm), Pin Hole 13/64" (5.2mm)



Lawnmower safety starts with help from Shriners Hospitals

The snow has melted and soon enough, the long blades of grass underneath will need to be cut.

To ensure a safe lawnmowing experience, Shriners Hospitals for Children suggest that safety precautions be carefully followed.

Shriners Hospitals treat many children each year who have been seriously injured as a result of power lawnmower accidents. Many of these incidents result in the loss of fingers, toes, limbs and even eyes.

Tragically, some lawnmower accidents can result in permanent brain damage or even death. In 2001, about 275,000 people were treated in hospital emergency rooms for injuries related to lawn and garden tools, and about 35,000 of those injured were under 15 years of age.

According to the U.S. Consumer Product Safety Commission, each year about 75 people are killed and about 20,000 are injured on or near riding lawnmowers and garden tractors. One out of every five deaths involves a child. The Commission estimates that most of the deaths occur when a child is in the path of a moving mower. Although tragic, these unfortunate situations could have been avoided, if adults had taken the proper precautions.

Although tragic, these unfortunate situations could have been avoided, if adults had taken the proper precautions.

To prevent injuries to children and adults from lawnmowers, please follow these safety tips from Shriners Hospitals and the U.S. Consumer Product Safety Commission:

- Do not allow passengers on a riding mower.
- Keep children out of the yard and indoors while mowing the lawn.
- It is recommended that children under the age of 14 not be allowed to operate a lawnmower.
- Always prepare your lawn for mowing. Check your lawn for items such as sticks, rocks, toys, etc. Make sure nothing is hidden in the grass.

- Handle fuel with care. Wipe up spills. Never fill the tank on a mower that is hot. Never smoke or use any kind of flame around gasoline.
- Wear appropriate clothing and shoes. Wear long pants, long-sleeved shirts, eye protection and heavy gloves. Wear sturdy, closed-toe shoes with slip-resistant rubber soles.
- Check guards and shields. Be sure to read the owner's manual and know how to operate the equipment. Don't remove or disable guards or other safety devices.
- Use a mower with a automatic blade cut-off. Stay behind the handle until the blade stops. Never reach under a mower while it is still operating. If you need to remove debris or check the blade, disconnect the wire from the spark plug.
- Don't cut grass when it's wet.
- On slopes, mow up and down rather than across the slope.

For more information on lawnmower safety, or Shriners' network of hospitals that treat children with orthopedic problems, burns and spinal cord injuries, please write to Shriners International Headquarters, Public Relations Dept., 2900 Rocky Point Drive, Tampa, FL 33607, or visit our Web site a www.shrinershq.org. If you know a child Shriners can help call 1-800-237-5055 in the United States or 1-800-361-7256 in Canada. Shriners Hospitals provide free treatment to children under the age of 18 without regard to race, religion or relationship to a Shriner.

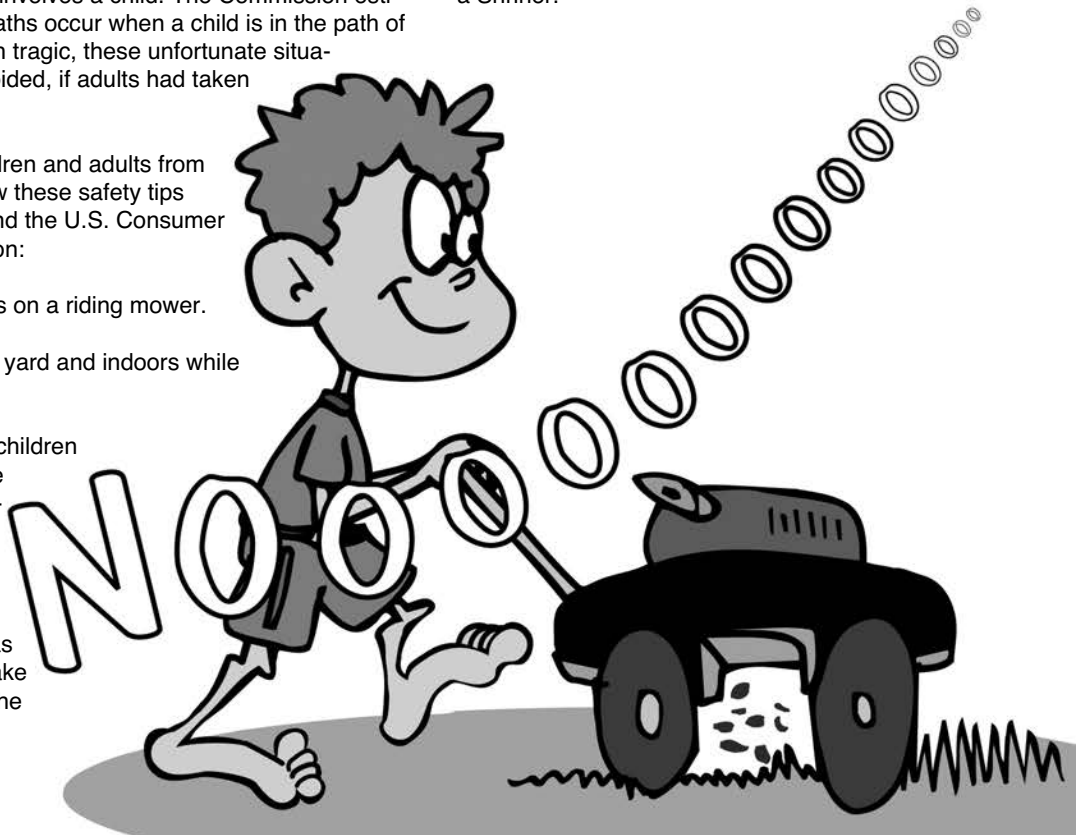

BLADES



FLAT BLADE







MULTI-APPLICATION

BLADE APPLICATIONS:

- BOBCAT: 32", 36", 48", 54", 61"
- BUNTON: 36", 48", 52", 61"
- DIXIE CHOPPER: 60"
- ENCORE: 36", 52"
- EXMARK: 32", 36", 48", 52", 60"
- FERRIS: 36", 48", 61"
- GREAT DANE: 52" & 61"
- GRAVELY: 60"
- HUSQVARNA: 32", 36", 48", 52"
- LESCO: 36", 48", 52", 61"
- SCAG: 36", 52", 61"
- SNAPPER: 36", 48", 52", 61"
- TORO: 36", 52"
- YAZOO/KEES: 32", 36", 48", 52", 61"

- **HEAVY DUTY**
- **SHARPENED ALL 4 SIDES**
- **EXTENDED CUTTING EDGE**
- **NO LIFT**
 REQUIRES LESS POWER
 CREATES LESS DUST
 LESS NOISE
 EXTENDS EQUIPMENT LIFE OF:
 ENGINES, DECKS, SPINDLES
 BLADES, DECKS, BELTS,
 AIR FILTERS & etc.

ORDER NO.	See O.E.M Listed Below	LENGTH	CENTER HOLE DIAM.	OUTSIDE HOLE DIAM.	CENTER TO CENTER	WIDTH	STEEL THICK.	APPLICATION
 15 - 10172	Bobcat, Exmark Ferris, Husqvarna Snapper	16-1/4" 412.8mm	5/8" 15.8mm			2-1/2" 63.5mm	.204" 5.2mm	Sharpened - 4-sides (2) blades for 32" cut (3) blades for 48" cut Flat Blade
 15 - 10173	Bobcat, Bunton Encore, Exmark Ferris, Great Dane Husq, Lesco, Scag Snapper, Toro	18" 457.2mm	5/8" 15.8mm			2-1/2" 63.5mm	.204" 5.2mm	Sharpened - 4-sides (2) blades for 36" cut (3) blades for 52" & 54" cut Flat Blade
 15 - 10175	Dixie Exmark Gravelly Toro	20-1/2" 520.7mm	5/8" 15.8mm			2-1/2" 63.5mm	.204" 5.2mm	Sharpened - 4-sides (2) blades for 40" cut (3) blades for 60" cut Flat Blade
 15 - 10174	Bobcat, Bunton Ferris, Great Dane Lesco, Scag Snapper	21" 533.4mm	5/8" 15.8mm			2-1/2" 63.5mm	.204" 5.2mm	Sharpened - 4-sides (3) blades for 61" cut Flat Blade
 15 - 10209	Toro	21-1/2" 546.1mm	1/2" 12.7mm			2-1/2" 63.5mm	.204" 5.2mm	Sharpened - 4-sides (3) blades for 62" cut Fits Toro "ZERO TURN"s. Flat Blade

14/16
BLADES





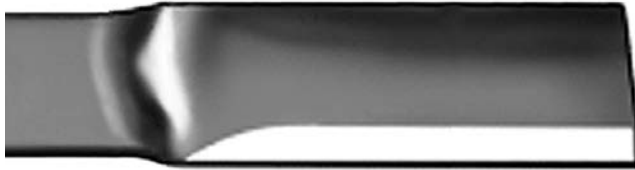

LOW-LIFT BLADE



BLADE APPLICATIONS:

- BOBCAT: 32", 36", 48", 54", 61"
- BUNTON: 36", 48", 50", 52", 61"
- DIXIE CHOPPER: 50" & 60"
- ENCORE: 36", 52"
- EXMARK: 32", 36", 48", 52", 60"
- FERRIS: 36", 48", 61"
- GREAT DANE: 52" & 61"
- GRAVELY: 50" & 60"
- HUSQVARNA: 32", 36", 48", 52"
- LESCO: 36", 48", 52", 61"
- SCAG: 36", 52", 61"
- SNAPPER: 36", 48", 52", 61"
- TORO: 36", 50", 52"
- YAZOO/KEES: 32", 36", 48", 52", 61"

- **MULTI-APPLICATION**
- **HEAVY DUTY**
- **SHARPENED ALL 4 SIDES**
- **LOW LIFT**
- **EXTENDED CUTTING EDGE**

ORDER NO.	See O.E.M Listed Below	LENGTH	CENTER HOLE DIAM.	OUTSIDE HOLE DIAM.	CENTER TO CENTER	WIDTH	STEEL THICK.	APPLICATION
 15 - 9967	Bobcat, Exmark Ferris Husq, Snapper	16-1/4" 412.8mm	5/8" 15.8mm			2" 50.8mm	.240" 6.1mm	Sharpened - 4-sides (2) blades for 32" cut (3) blades for 48" cut Low Lift Blade
 15 - 6013	Bunton Dixie Chopper Gravely, Toro	17" 431.8mm	5/8" 15.8mm			2" 50.8mm	.240" 6.1mm	Sharpened - 4-sides (3) blades for 50" cut Low Lift Blade
 15 - 9968	Bobcat, Encore Exmark, Ferris Great Dane Husq. Lesco, Scag Snapper, Toro	18" 457.2mm	5/8" 15.8mm			2" 50.8mm	.240" 6.1mm	Sharpened - 4-sides (2) blades for 36" cut (3) blades for 52" & 54" cut Low Lift Blade
 15 - 6194	Dixie Chopper Exmark, Gravely Toro	20-1/2" 520.7mm	5/8" 15.8mm			2" 50.8mm	.240" 6.1mm	Sharpened - 4-sides (2) blades for 40" cut (3) blades for 60" cut Low Lift Blade
 15 - 9969	Bobcat, Ferris Great Dane, Lesco Scag, Snapper	21" 533.4mm	5/8" 15.8mm			2" 50.8mm	.240" 6.1mm	Sharpened - 4-sides (3) blades for 61" cut Low Lift Blade

14/16

BLADES

BLADES



Commercial Mulching Blade

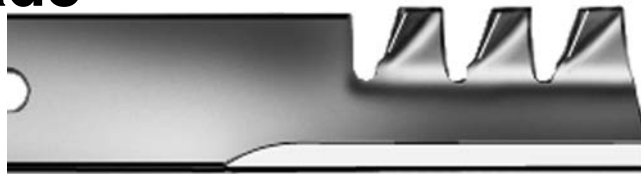

BLADE APPLICATIONS:

UNIVERSAL: 16", 18", 19", 20", 21", 22"

AYP: 46", 38", 20", 42", 22"

BOBCAT: 32", 48", 36", 61"

BUNTON: 48", 52", 36", 61"

DIXIE CHOPPER: 42", 50", 60",

DIXON: 42", 50", 60",

ENCORE: 36",

EXMARK: 44", 48", 36", 60"

FERRIS: 36", 48", 61"

GRASSHOPPER: 44", 48", 52", 61"

GRAVELY: 50", 60"

HUSQVARNA: 34", 32", 48", 54", 36"

JOHN DEERE: 36", 38", 48", 54", 61", 60"

LESCO: 48", 36", 52", 61"

MTD: 42", 20", 21", 22",

MURRAY: 46", 42",

SCAG: 32", 48", 36", 52", 61", 72"

SNAPPER: 21", 28", 30", 33", 36", 48", 52", 61"

TORO: 44", 50", 36", 52", 21", 32"





WALKER: 42", 62", 48"

WOODS: 52", 61"

YAZOO/KEES: 32", 36", 48", 52", 61"

- **MULTI-APPLICATION**
- **HEAVY DUTY**
- **EXTENDED CUTTING EDGE**
- **CENTRIFUGAL AIR LIFT DESIGN**
- **MULTI CUTTING TEETH**
FOR A CLEANER, FINER CUT
INCREASED MULCHING
UNIFORM CLIPPING DISTRIBUTION









14/16
BLADES

ORDER NO.	REPLACES O.E.M. NO.	LENGTH	CENTER HOLE DIAM.	OUTSIDE HOLE DIAM.	CENTER TO CENTER	WIDTH	STEEL THICK.	APPLICATION
 14 - 10243		16" 406.4mm	1" 25.4mm			2-1/2" 63.5mm	.150" 3.8mm	Universal Commercial Mulching Blade
 14 - 10244		18" 457.2mm	1" 25.4mm			2-1/2" 63.5mm	.150" 3.8mm	Universal Commercial Mulching Blade
 14 - 50288		19" 482.6mm	.472" 12mm			2-1/2" 63.5mm	.150" 3.8mm	Universal Commercial Mulching Blade



Commercial Mulching Blade (cont.)



ORDER NO.	See O.E.M Listed Below	LENGTH	CENTER HOLE DIAM.	OUTSIDE HOLE DIAM.	CENTER TO CENTER	WIDTH	STEEL THICK.	APPLICATION
 15 - 6312	Dixon	14-7/16" 366.7mm	45/64" 17.9mm			2-1/2" 63.5mm	.187" 4.8mm	Commercial Mulching Blade
 15 - 6316	Dixie Chopper	14-1/2" 368.3mm	5/8" 15.8mm			2-1/2" 63.5mm	.204" 5.2mm	Commercial Mulching Blade
 15 - 6415	Grasshopper	15" 381mm	1/2" 12.7mm			2-1/2" 63.5mm	.204" 5.2mm	Commercial Mulching Blade
 15 - 9884	Exmark	15-5/16" 388.9mm	5/8" 15.8mm			2-1/2" 63.5mm	.204" 5.2mm	Commercial Mulching Blade
 15 - 9885	Toro	15-1/2" 393.7mm	5/8" 15.9mm			2-1/2" 63.5mm	.187" 4.8mm	Commercial Mulching Blade
 15 - 9970	Ayp	15-9/16" 395mm	5 point star			2-1/2" 63.5mm	.187" 4.8mm	Commercial Mulching Blade
 15 - 6491	Murray	15-3/4" 400mm	27/32" 21.4mm			2-1/2" 63.5mm	.150" 3.8mm	Commercial Mulching Blade.
 15 - 6496	John Deere	16" 406.4mm	11/16" 17.5mm			2" 50.8mm	.187" 4.8mm	Commercial Mulching Blade













14/16

BLADES

BLADES



Commercial Mulching Blade (cont.)

ORDER NO.	See O.E.M Listed Below	LENGTH	CENTER HOLE DIAM.	OUTSIDE HOLE DIAM.	CENTER TO CENTER	WIDTH	STEEL THICK.	APPLICATION
 15 - 6296	Bobcat, Exmark Ferris Husqvarna Snapper	16-1/4" 412.8mm	5/8" 15.8mm			2-1/2" 63.5mm	.204" 5.2mm	Commercial Mulching Blade
 15 - 11772	Exmark 103-9614 103-8296	16-1/4" 412.75mm	15/16" 23.8mm			3" 76.2mm	.204" 5.2mm	Mulching Blade PATENTED (3) blades for a 46" cut.
 15 - 6300	Bunton, Bad Boy John Deere Lesco, Scag Snapper	16-1/2" 419.1mm	5/8" 15.8mm			2-1/2" 63.5mm	.204" 5.2mm	Commercial Mulching Blade
 15 - 6420	John Deere	16-5/8" 422.3mm	13/16" 20.6mm			2-1/2" 63.5mm	.204" 5.2mm	Commercial Mulching Blade
 15 - 6314	John Deere	16-5/8" 422.3mm	13/16" 20.6mm			2-1/2" 63.5mm	.204" 5.2mm	Commercial Mulching Blade
 15 - 12475	AYP 173921 173920 180054	16-5/8" 422.3mm	5 point star			2-1/2" 63.5mm	.204" 5.2mm	Mulching Blade. PATENTED (3) blades for a 48" cut.
 15 - 6298	Dixie Chopper Dixon, Gravely Toro	17" 431.8mm	5/8" 15.8mm			2-1/2" 63.5mm	.204" 5.2mm	Commercial Mulching Blade
 15 - 6785	Dixon	17" 431.8mm	11/16" 17.9mm			2-1/2" 63.5mm	.204" 5.2mm	Commercial Mulching Blade
 15 - 6426	Snapper	17" 431.8mm	1/2" 12.7mm			2-1/2" 63.5mm	.204" 5.2mm	Commercial Mulching Blade
 15 - 11776	Exmark 103-9615	17-1/2" 444.5mm	15/16" 23.8mm			3" 76.2mm	.204" 5.2mm	Mulching Blade PATENTED (3) blades for a 50" cut.
 15 - 6410	Toro	18" 457.2mm	1/2" 12.7mm			2-1/2" 63.5mm	.187" 4.8mm	Commercial Mulching Blade
 15 - 6309	Grasshopper Woods	18" 457.2mm	1/2" 12.7mm			2-1/2" 63.5mm	.204" 5.2mm	Commercial Mulching Blade











14/16

BLADES



Commercial Mulching Blade (cont.)



ORDER NO.	See O.E.M Listed Below	LENGTH	CENTER HOLE DIAM.	OUTSIDE HOLE DIAM.	CENTER TO CENTER	WIDTH	STEEL THICK.	APPLICATION
 15 - 6294	Bad Boy Bobcat, Bunton Encore, Exmark Husq, J.Deere Scag, Snapper	18" 457.2mm	5/8" 15.8mm			2-1/2" 63.5mm	.204" 5.2mm	Commercial Mulching Blade
 15 - 9229	Scag	18" 457.2mm	5/8" 15.9mm			2-1/2" 63.5mm	.204" 5.2mm	Commercial Mulching Blade
 15 - 13016	Bobcat 112111-02	18" 457.2mm	5/8" 15.9mm			2-1/2" 63.5mm	.204" 5.2mm	(2) blades for a 36" cut. Mulching Blade. PATENTED
 15 - 12121	187254 187255	AYP 18-1/2" 469.9mm	5 point star			3" 76.2mm	.187" 4.8mm	Mulching Blade PATENTED (3) blades for a 54" cut.
 15 - 6315	John Deere	18-5/8" 473.1mm	13/16" 20.6mm			2-1/2" 63.5mm	.204" 5.2mm	Commercial Mulching Blade
 15 - 10072	John Deere	19" 482.6mm	7/8" 22.2mm			2-1/2" 63.5mm	.240" 6.1mm	Commercial Mulching Blade
 15 - 6421	John Deere	19-1/2" 495.3mm	11/16" 17.5mm			2-1/2" 63.5mm	.204" 5.2mm	Commercial Mulching Blade
 15 - 11780	Exmark 103-9628	19-1/2" 495.3mm	15/16" 23.8mm			3" 76.2mm	.204" 5.2mm	Mulching Blade PATENTED (3) blades for a 56" cut.
 15 - 13129	Toro 110-1857-03 110-6568-03 106-8744-03 106-2247-03	21-5/8" 549.2mm	5/8" 15.9mm			2-1/2" 63.5mm	.160" 4.1mm	Mulching Blade PATENTED (2) blades for a 42" cut.
 15 - 12649	Toro 108-9764-03	21-23/32" 551.6mm	7/16" 11.1mm			2-1/4" 57.2mm	.150" 3.8mm	Mulching Blade PATENTED Fits 22" recycler

14/16











BLADES

BLADES



Commercial Mulching Blade (cont.)



ORDER NO.	See O.E.M Listed Below	LENGTH	CENTER HOLE DIAM.	OUTSIDE HOLE DIAM.	CENTER TO CENTER	WIDTH	STEEL THICK.	APPLICATION
 15 - 6303	Bad Boy Dixie Chopper Dixon, Exmark Gravely	20-1/2" 520.7mm	5/8" 15.8mm			2-1/2" 63.5mm	.204" 5.2mm	Commercial Mulching Blade
 15 - 9465	Exmark	20-1/2" 520.7mm	1/2" 12.7mm			2-1/2" 63.5mm	.204" 5.2mm	Commercial Mulching Blade
 15 - 6317	Snapper	20-11/16" 525.5mm	3/8" 9.5mm			2-3/4" 69.9mm	.160" 4.1mm	Commercial Mulching Blade
 15 - 11784	Exmark 103-9629	20-3/4" 527.1mm	15/16" 23.8mm			3" 76.2mm	.204" 5.2mm	Mulching Blade PATENTED (3) blades for a 60" cut.
 15 - 6422	Ayp	21" 533.4mm	5 point star			2-1/2" 63.5mm	.187" 4.8mm	Commercial Mulching Blade
 15 - 6299	Bobcat, Bunton Ferris, Husq. Lesco, Scag	21" 533.4mm	5/8" 15.8mm			2-1/2" 63.5mm	.204" 5.2mm	Commercial Mulching Blade
 15 - 6308	Toro	21" 533.4mm	7/16" 11.1mm			2-1/2" 63.5mm	.150" 3.8mm	Commercial Mulching Blade
 15 - 6311	Grasshopper Woods	21" 533.4mm	1/2" 12.7mm			2-1/2" 63.5mm	.204" 5.2mm	Commercial Mulching Blade
 15 - 9230	Scag	21" 533.4mm	5/8" 15.9mm			2-1/2" 63.5mm	.204" 5.2mm	Commercial Mulching Blade
 15 - 10073	John Deere Exmark	21" 533.4mm	.904" 23mm			2-1/2" 63.5mm	.240" 6.1mm	Commercial Mulching Blade
 15 - 13017	Bobcat 112111-03	21" 533.4mm	5/8" 15.9mm			2-1/2" 63.5mm	.240" 6.1mm	(3) blades for a 61" cut. Mulching Blade PATENTED









14/16

BLADES



Commercial Mulching Blade (cont.)



ORDER NO.	See O.E.M Listed Below	LENGTH	CENTER HOLE DIAM.	OUTSIDE HOLE DIAM.	CENTER TO CENTER	WIDTH	STEEL THICK.	APPLICATION
 15 - 6295	MTD	21-3/16" 538.2mm	13/32" 10.3mm	5/16" 7.9mm	2-1/2" 63.5mm	3" 76.2mm	.150" 3.8mm	Commercial Mulching Blade
 15 - 6460	Murray	21-1/4" 539.8mm	27/32" 21.4mm			2-1/2" 63.5mm	.150" 3.8mm	Commercial Mulching Blade
 15 - 13129	Toro 110-1857-03 110-6568-03 106-8744-03 106-2247-03	21-5/8" 549.2mm	5/8" 15.9mm			2-1/2" 63.5mm	.160" 4.1mm	(2) blades for a 42" cut. Mulching Blade. PATENTED
 15 - 12649	Toro 108-9764-03	21-23/32" 551.6mm	7/16" 11.1mm			2-1/4" 57.2mm	.150" 3.8mm	Fits 22" Recycler Mulching Blade. PATENTED
 14 - 6322	Universal	22" 533.4mm	3/8" 9.5mm			2-1/2" 63.5mm	.150" 3.8mm	Commercial Mulching Blade
 15 - 6414	Walker	22" 558.8mm	5/8" 15.9mm	3/16" 4.8mm	3" 76.2mm	2-3/4" 69.9mm	.187" 4.8mm	Commercial Mulching Blade
 15 - 11788	Exmark 103-9630	22-3/4" 577.85mm	15/16" 23.8mm			3" 76.2mm	.204" 5.2mm	Mulching Blade PATENTED (3) blades for a 66" cut.
 15 - 9883	Scag	24-1/2" 622.3mm	5/8" 15.9mm			2-1/2" 63.5mm	.204" 5.2mm	Commercial Mulching Blade
 15 - 11792	Exmark 103-9631	24-3/4" 628.7mm	15/16" 23.8mm			3" 76.2mm	.204" 5.2mm	Mulching Blade PATENTED (3) blades for a 72" cut.

14/16



BLADES

BLADES



Commercial Mulching Blade (cont.)



ORDER NO.	See O.E.M Listed Below	LENGTH	CENTER HOLE DIAM.	OUTSIDE HOLE DIAM.	CENTER TO CENTER	WIDTH	STEEL THICK.	APPLICATION
 15 - 6302	Snapper	28" 711.2mm	1-1/16" 27 mm	35/64" 13.9 mm	7-1/2" 190.5mm	2-3/4" 69.9mm	.187" 4.8mm	Commercial Mulching Blade
 15 - 6297	Snapper	30" 762mm	1-1/16" 27mm	35/64" 13.9mm	7-1/2" 190.5mm	2-3/4" 69.9mm	.187" 4.8mm	Commercial Mulching Blade
 15 - 6301	Snapper	33" 838.2mm	1-1/16" 27mm	35/64" 13.9mm	7-1/2" 190.5mm	2-3/4" 69.9mm	.187" 4.8mm	Commercial Mulching Blade

14/16



BLADES





BLADES

**Blades for
AGS / SECO**





ORDER NO.	REPLACES O.E.M. NO.	LENGTH	CENTER HOLE DIAM.	OUTSIDE HOLE DIAM.	CENTER TO CENTER	WIDTH	STEEL THICK.	APPLICATION
 15 - 6482	532-050-422-533	20-1/2" 520.7mm	.640" 16.2mm	.265" 6.7mm		5-1/8" 130mm	.160" 4.1mm	Right side blade. Left Hand rotation.
 15 - 6483	532-050-422-543	20-1/2" 520.7mm	.640" 16.2mm	.265" 6.7mm		5-1/8" 130mm	.160" 4.1mm	Left side blade. Right Hand rotation.

AIRCAP

 15 - 2051	122035	20-7/8" 530.2mm	3/8" 9.5mm			2-1/4" 57.2mm	.150" 3.8mm	
 15 - 3366	10680-01	21-1/2" 546.1mm	3/8" 9.5mm			2-1/4" 57.2mm	.150" 3.8mm	

ALLEN

 27 - 9035 MIN003		4" 101.6mm	31/64" 12.3mm					Steel inserted plastic blade. Fits Allen SE1601.
 15 - 6104	H192271	18-1/2" 469.9mm	1-7/32" 31mm			2-1/4" 57.2mm	.150" 3.8mm	Fits model #218

14/16

BLADES











BLADES



AMF (See NOMA)



Blades for ARIENS

ORDER NO.	REPLACES O.E.M. NO.	LENGTH	CENTER HOLE DIAM.	OUTSIDE HOLE DIAM.	CENTER TO CENTER	WIDTH	STEEL THICK.	APPLICATION
 15 - 14540	 04265400	14-7/8" 355.6mm	5/8" 15.8mm			2-1/4" 50.8mm	.187" 4.7mm	Fits ZT42, Zoom 42
 15 - 3326	30278	16-5/8" 422.3mm	3/4" 19.1mm			2-1/2" 57.2mm	.180" 4.8mm	Center blade for Ariens 60" cut, GT-Decks (3) blades for 48" cut
 15 - 6060	3123759 31237	16-5/8" 422.3mm	3/4" 19.1mm			2-1/2" 57.2mm	.204" 5.2mm	(3) blades for 48" cut Deck #831031 GT
 15 - 13177	 03746500 03971900	17.35" 440.6mm	5/8" 15.8mm			2-1/4" 50.8mm	.187" 4.7mm	Fits ZT50, Zoom 50
 15 - 6254	3624759 36247	20-5/16" 515.9mm	3/4" 19.1mm			2-1/2" 63.5mm	.204" 5.2mm	(2) blades for 40" cut front engine rider model YT 13, 14 & 15 hp
 15 - 3322	11370	20-1/2" 546.1mm	13/32" 10.3mm			2-3/4" 69.9mm	.160" 4.1mm	Zone start mower Used on 21" walk behind mowers
 15 - 6445	2749351	26-7/8" 682.6mm	7/16" 12.7mm	3/8" 9.5mm	4" 44.5mm	2-3/4" 69.9mm	.187" 4.8mm	Fits 28" Riding mowers.
 15 - 3323	2728551 27285	28" 711.2mm	3/4" 19.1mm	25/64" 9.9mm	11" 279.4mm	2-3/4" 69.9mm	.180" 4.6mm	For 28" rear engine rider Uses our 15-911 Air lifts.
 15 - 2137	2728759 27287	30" 762mm	3/4" 19.1mm	25/64" 9.9mm	11" 279.4mm	2-3/4" 69.9mm	.187" 4.8mm	For 30" rear engine rider Uses our 15-911 Air lifts

Air Lifts for ARIENS

Order No. 15 - 911

Complete Kit. Replaces Ariens No. 527011. Used on our **15-1096**, **15-3323**, **15-3324** and **15-2137** blades. Includes (4) 5/16" 24 x 3/4" hex screw, (4) 5/16"-24 top lock nut.



AS MOTOR (EXPORT ONLY)

 15 - 50127	10004145	630 mm 20.24mm	.79" 20.24mm			3.00" 76.20mm	.187" 4.76mm	
--	----------	--------------------------	------------------------	--	--	-------------------------	------------------------	--













14/16
BLADES



BLADES

AYP - SEARS/ROPER/HUSKY/POULAN (HUSQVARNA)



ORDER NO.	REPLACES O.E.M. NO.	LENGTH	CENTER HOLE DIAM.	OUTSIDE HOLE DIAM.	CENTER TO CENTER	WIDTH	STEEL THICK.	APPLICATION
 15 - 1019	25118	14-5/8" 371.5mm	5/8" 15.9mm	5/16" 7.9mm		2-1/2" 63.5mm	.150" 3.8mm	
 15 - 1020	9484H 25321	14-5/8" 371.5mm	1-1/4" 31.8mm	15/32" 11.9mm	3" 76.2mm	2-1/2" 63.5mm	.150" 3.8mm	(3) blades for 42" cut
 15 - 2162	25034 25034R	15-3/8" 390.5mm	3/8" 9.5mm			2-1/4" 57.2mm	.187" 4.8mm	(3) blades for 44" cut
 15 - 6205	130652	15-3/8" 390.5mm	5 point star			2-1/4" 57.2mm	.160" 4.1mm	(3) blades for 44" cut Hi Performance
 15 - 6263	130652	15-3/8" 390.5mm	5 point star			2-1/4" 57.2 mm	.187" 4.8 mm	(3) blades for 44" cut. (Heavy Duty) . Also fits Poulan.
 15 - 6437	163819 152443	15-1/2" 393.7mm	5 point star			2-1/4" 57.2mm	.160" 4mm	(3) blades for 46" cut. Fits AYP, Sears, Husky and Poulan.
 15 - 6495	159705 170698 176084	15-1/2" 393.7mm	5 point star			2-1/4" 57.1mm	.160" 4.8mm	High lift blade. (3) blades for 46" cut. Fits AYP, Sears, Husqvarna & Poulan.
 15 - 9170	157033	15-9/16" 395mm	5 point star			2-1/4" 57.2mm	.187" 4.8mm	(3) blades for 46" cut. Fits AYP, Sears, Husky and Poulan. (Heavy Duty)
 15 - 9970	157033	15-9/16" 395mm	5 point star			2-1/2" 63.5mm	.187" 4.8mm	Mulching Blade PATENTED
 15 - 2690	25322 9485H 25322R	16-5/8" 422.3mm	1-1/4" 31.8mm	15/32" 11.9mm	3" 76.2mm	2-1/2" 63.5mm	.187" 4.8mm	(3) blades for 48" cut
 15 - 10377	173921	16-5/8" 422.3mm	5 point star			2-1/2" 63.5mm	.204" 5.2mm	(3) blades for 48" cut. Mulching Blade
 15 - 12475	173921 173920 180054	16-5/8" 422.3mm	5 point star			2-1/2" 63.5mm	.204" 5.2mm	(3) blades for a 48" cut. Mulching Blade. PATENTED

14/16

BLADES

BLADES



Blades for
AYP - SEARS/ROPER/HUSKY/POULAN
(HUSQVARNA) (continued)



ORDER NO.	REPLACES O.E.M. NO.	LENGTH	CENTER HOLE DIAM.	OUTSIDE HOLE DIAM.	CENTER TO CENTER	WIDTH	STEEL THICK.	APPLICATION
 15 - 9907	173920 180054	16-3/4" 425.5mm	5 point star			2-1/2" 63.5mm	.204" 5.2mm	(3) blades for 48" cut. High Lift
 15 - 6196	137380	17-3/8" 441.3mm	5 point star			2-1/4" 57.2mm	.160" 4.1mm	(3) blades for 50" cut front engine lawn tractor.
 15 - 6195	121798X	17-3/8" 441.3mm	3/8" 9.5mm			2-1/4" 57.2mm	.187" 4.8mm	(3) blades for 50" cut front engine lawn tractor
 15 - 6264	137380	17-3/8" 441.3mm	5 point star			2-1/4" 57.2mm	.187" 4.8mm	(3) blades for 50" cut. (Heavy Duty) . Also fits Poulan.
 15 - 10841	140101	18-3/8" 466.7mm	5 point star			2-1/4" 57.2mm	.150" 3.8mm	(2) blades for 36" cut
 15 - 50252	165560 170037	18" 457.2mm	5 point star			2-1/4" 57.1mm	.187" 4.8mm	Fits 36" rear discharge tractor. Mulching blade. Right hand blade.
 15 - 50253	165561 170038	18" 457.2mm	6 point star			2-1/4" 57.1mm	.187" 4.8mm	Fits 36" rear discharge tractor. Mulching blade. Left hand blade.
 15 - 6123	138496 127841	18" 457.2mm	5 point star			2-1/4" 57.2mm	.150" 3.8mm	(2) blades for 36" cut
 15 - 6219	131321	18-1/8" 460.3mm	5 point star			2-1/4" 57.2mm	.187" 4.8mm	(2) blades for 36" cut also fits Husky & Poulan (Heavy Duty)
 15 - 3358	25645 98111 71285	18-3/16" 462mm	3/8" 9.5mm			2-1/2" 63.5mm	.134" 3.4mm	(2) blades for 36" cut
 15 - 6120	126338X 120262X	18-1/4" 462mm	3/8" 9.5mm			2-1/4" 57.2mm	.187" 4.8mm	(2) blades for 36" cut

14/16













BLADES



BLADES

**Blades for
AYP - SEARS/ROPER/HUSKY/POULAN
(HUSQVARNA) (continued)**



ORDER NO.	REPLACES O.E.M. NO.	LENGTH	CENTER HOLE DIAM.	OUTSIDE HOLE DIAM.	CENTER TO CENTER	WIDTH	STEEL THICK.	APPLICATION
 15 - 13239	187254	18-3/8" 466.7mm	5 point star			3" 76.2mm	.187" 4.8mm	(3) blades for a 54" cut. Low lift blade.
 15 - 11180	187254	18-3/8" 466.7mm	5 point star			3" 76.2mm	.187" 4.8mm	Fits Craftsman, Husqvarna and Poulan Pro. (3) blades for 54" cut Standard Lift Blade.
 15 - 14459	187254 532-187256	18-1/2" 401.3mm	5 point star			2-1/2" 63.5mm	.204" 5.2mm	High Lift Bagging Blade (3) blades for 54" cut
 15 - 12121	187255 187256 187254	18-1/2" 469.9mm	5 point star			3" 76.2mm	.187" 4.8mm	Mulching Blade PATENTED (3) blades for a 54" cut.
 15 - 6218	131322	19" 482.6mm	5 point star			2-1/4" 57.2mm	.187" 4.8mm	(2) blades for 38" cut also fits Husky & Poulan (Heavy Duty)
 15 - 6105	121263X	19-1/4" 489mm	3/8" 9.5mm			2-1/4" 57.2mm	.187" 4.8mm	(2) blades for 38" cut
 15 - 12240	193957	19-1/4" 488.95mm	5 point star			2-1/4" 57.2mm	.150" 3.8mm	Fits Sears Craftsman rider. 3 in 1 blade. (2) blades for a 38" cut.
 15 - 6124	138497 127842	19-5/16" 490.54mm	5 point star			2-1/4" 57.2mm	.150" 3.8mm	(2) blades for 38" cut Standard Lift Blade
 15 - 3392	106634 25036 25036R	19-11/32" 491.3mm	3/8" 9.5mm			2-1/4" 57.2mm	.150" 3.8mm	(2) blades 15-3392 & (2) 15-6015 blades for 38" cut (blades cross)
 15 - 6190	134148	19-5/16" 498.5mm	5 point star			2-1/4" 57.2mm	.134" 3.4mm	(2) blades for 38" cut front engine rider Mulcher blade
 15 - 1043	56400 8020 56400R	20" 508mm	5/8" 15.9mm			2-1/2" 63.5mm	.134" 3.4mm	
 15 - 6037	850972	20" 508mm	5/8" 15.9mm	3/8" 9.5mm	1-7/8" 47.6mm	2-1/2" 63.5mm	.134" 3.4mm	For 20" walk behind

14/16













BLADES

BLADES



**Blades for
AYP - SEARS/ROPER/HUSKY/POULAN
(HUSQVARNA) (continued)**



ORDER NO.	REPLACES O.E.M. NO.	LENGTH	CENTER HOLE DIAM.	OUTSIDE HOLE DIAM.	CENTER TO CENTER	WIDTH	STEEL THICK.	APPLICATION
 15 - 6235	752233 145106	20" 508mm	5/8" 15.9mm	3/8" 9.5mm	1-7/8" 47.6mm	2-1/4" 57.2mm	.134" 3.4mm	Mulching Blade Fits Craftsman 20" walk behind mowers.
 15 - 6125	138971 138498 127843	21" 533.4mm	5 point star			2-1/4" 57.2mm	.150" 3.8mm	(2) blades for 42" cut
 15 - 6189	134149	21" 533.4mm	5 point star			2-1/4" 57.2mm	.134" 3.4mm	(2) blades for 42" cut front engine rider Mulcher blade
 15 - 6262	134149	21" 533.4mm	5 point star			2-1/4" 57.2mm	.187" 4.8mm	(2) blades for 42" cut (Heavy Duty) . Also fits Poulan.
 15 - 6422	134149	21" 533.4mm	5 point star			2-1/2" 63.5mm	.187" 4.8mm	Mulching Blade PATENTED
 15 - 6484	168720 175450 180583	21" 533.4mm	5 point star			5-5/8" 143mm	.150" 3.8mm	Fits 42" rear discharge. Left side blade. Right Hand rotation.
 15 - 6485	168721 175451 180584	21" 533.4mm	6 point star			5-5/8" 143mm	.150" 3.8mm	Fits 42" rear discharge. Right side blade. Left Hand rotation.
 15 - 9810	159267 532-40-67-12 406712 165833 175064 189028	21" 533.4mm	5/8" 15.8mm	3/8" 9.5mm	1-7/8" 47.6mm	2-1/4" 57.2mm	.134" 3.4mm	Blade for a 21" walkbehind mower. Mulching blade.
 15 - 12732	165833 175064 406712 189028	21" 533.4mm	5/8" 15.9mm	3/8" 9.5mm	1-7/8" 47.6mm	2-1/4" 57.2mm	.150" 3.8mm	Fits 21" Walkbehind Mower Mulching Blade. PATENTED
 15 - 12563	139775	21-1/16" 534mm	5 point star			2-1/4" 57.2mm	.150" 3.8mm	Fits Sears Craftsman rider. (2) blades for a 42" cut. 3 in 1 blade
 15 - 6038	850973	21-5/8" 549.3mm	5/8" 15.9mm	3/8" 9.5mm	1-7/8" 47.6mm	2-1/2" 63.5mm	.150" 3.8mm	For 22" walk behind
 15 - 6220	48126 88174	21-11/16" 550.9mm	1" 25.4mm	1/2" 12.7mm	3-11/16" 93.7mm	2-1/2" 63.5mm	.187" 4.8mm	22" cut for BBC models walk behind

14/16









BLADES



BLADES

**Blades for
AYP - SEARS/ROPER/HUSKY/POULAN
(HUSQVARNA) (continued)**













ORDER NO.	REPLACES O.E.M. NO.	LENGTH	CENTER HOLE DIAM.	OUTSIDE HOLE DIAM.	CENTER TO CENTER	WIDTH	STEEL THICK.	APPLICATION
 15 - 6106	103524X	21-3/4" 553.5mm	3/8" 9.5mm			2-1/2" 63.5mm	.150" 3.8mm	For 22" walk behind
 15 - 1044	56401 8021	21-3/4" 553.5mm	5/8" 15.9mm			2-1/2" 63.5mm	.150" 3.8mm	
 15 - 6236	406713 192682 157101 335256 114886 141114	22" 558.8mm	5/8" 15.9mm	3/8" 9.5mm	1-7/8" 47.6mm	2-1/4" 57.2mm	.134" 3.4mm	Blade for 22" cut, side discharge mulching mower. Fits models HW706D, HW906D, HWRBSP22525A, HWT450A, HWT450B, J455SDE, J555RDEB.
 15 - 13023	420463 421825	22" 558.8mm	5 point star			2-1/2" 63.5mm	.134" 3.4mm	Fits Craftsman/Husqvarna. 22" Walk behind mowers.
 15 - 12242	405380	23" 584.2mm	5 point star			2-3/4" 69.9mm	.150" 3.8mm	Fits 2007 models (2) blades for a 46" cut. Standard Lift Blade
 15 - 12721	403107	23" 584.2mm	5 point star			2-1/4" 57.2mm	.150" 3.8mm	(2) blades for a 46" cut. Mulching Blade. PATENTED
 15 - 12974	403107	23" 584.2mm	5 point star			2-1/4" 57.2mm	.187" 4.8mm	(2) blades for a 46" cut. (Heavy Duty) Blade.
 15 - 12957	419274	29-5/8" 752.47mm	5 point star			2-1/4" 57.2mm	.170" 4.3mm	Fits 30" model PXT12530 960460008.

BLADES



**Blades for
BAD BOY**



ORDER NO.	REPLACES O.E.M. NO.	LENGTH	CENTER HOLE DIAM.	OUTSIDE HOLE DIAM.	CENTER TO CENTER	WIDTH	STEEL THICK.	APPLICATION
 15 - 2172	038-4820-00	16-1/4" 412.8mm	5/8" 15.9mm	1 1/32" 8.7mm	1-5/8" 41.3mm	2-1/2" 63.5mm	.240" 6.1mm	(Heavy Duty) (2) blades for 32" cut. (3) blades for 48" cut.
 15 - 6300	038-5350-0050	16-1/2" 419.1mm	5/8" 15.8mm			2-1/2" 63.5mm	.204" 5.2mm	Commercial Mulching Blade (3) blades for 50" cut
 15 - 6294		18" 457.2mm	5/8" 15.9mm			2-1/2" 63.5mm	.204" 5.2mm	Commercial Mulching Blade
 15 - 2173	038-3000-00	18" 457.2mm	5/8" 15.9mm			2-1/2" 63.5mm	.240" 6.1mm	(Heavy Duty) (2) blades for 36" cut (3) blades for 52" cut
 15 - 10667	038-6060-00 038-6050-00 038-2007-00	20-1/2" 520.7mm	5/8" 15.9mm			2-1/2" 63.5mm	.204" 5.2mm	Notched High Lift blade. (3) blades for a 60" cut.
 15 - 6303		20-1/2" 520.7mm	5/8" 15.9mm			2-1/2" 63.5mm	.204" 5.2mm	Commercial Mulching Blade
 15 - 6180	9383	20-1/2" 520.7mm	5/8" 15.9mm			2-1/2" 63.5mm	.240" 6.1mm	(3) blades for 60" cut
 15 - 6404	038-7202-00	24" 609.6mm	5/8" 15.9mm			2-1/2" 63.5mm	.240" 6.1mm	(3) blades for 72" cut.
 15 - 6833	038-7202-00	24" 609.6mm	5/8" 15.9mm			3" 76.2mm	.240" 6.1mm	(3) blades for 72" cut. (Heavy Duty)
 15 - 6026	038-7220-00 038-7230-00	24-1/2" 622.3mm	5/8" 15.9mm			2-1/2" 63.5mm	.204" 5.2mm	(3) blades for 72" cut
 15 - 9883	038-7220-00 038-7230-00	24-1/2" 622.3mm	5/8" 15.9mm			2-1/2" 63.5mm	.204" 5.2mm	Commercial Mulching Blade

14/16

BLADES











BLADES

**Blades for
BERNARD**



ORDER NO.	REPLACES O.E.M. NO.	LENGTH	CENTER HOLE DIAM.	OUTSIDE HOLE DIAM.	CENTER TO CENTER	WIDTH	STEEL THICK.	APPLICATION
 15 - 50125	12806	20-7/8" 530.23mm	.412" 10.71mm			3.00" 76.20mm	.125" 3.18mm	

BLUE BIRD

 15 - 10780								Fits model P18. 20 blades per set.
 15 - 8720 MIN052	5201	3-17/32" 89.9mm	17/32" 13.5mm			1" 25.4mm	.125" 3.2mm	Flail blades. Fits F20 & F20B.
 15 - 6324 MIN052	5001 350100	4" 101.6mm	1/2" 12.7mm			1" 25.4mm	.125" 3.2mm	Flail blades. Fits Blue Bird Lawn comber-rotor Used with our 10-8755 shaft, 09-8863 bearing & 10-8741 spacer set.
 15 - 10968 MIN052	5001	4" 101.6mm	1/2" 12.7mm			1" 25.4mm	.125" 3.2mm	(NHT) Fits lawn Comber-Roter. 52 Blades per set.
 15 - 11643 MIN024	5601	3-17/32" 89.7mm	17/32" 13.5mm			1" 25.4mm	.125" 3.17mm	Also replaces Stiga 1621-0050-01 Fits 300 RSC & VB38 (NHT) Minimum 24
 15 - 11645 MIN052	5201	3-17/32" 89.7mm	17/32" 13.5mm			1" 25.4mm	.125" 3.17mm	(NHT) Minimum 52
 15 - 11644 MIN052	5401	4" 101.6mm	17/32" 13.5mm			1" 25.4mm	.125" 3.17mm	Fits models TLC-240 (48 pcs), 405 (36 pcs), 720 (52 pcs) (NHT) Minimum 52
 15 - 12714	71910	7-5/8" 178.4mm						Requires the following: (30)for Lawnaire IV plus. (42)for Lawnaire V plus Fits models 424, 530A & 742. Aerator Tine.

14/16













BLADES

BLADES



**Blades for
BOBCAT**



ORDER NO.	REPLACES O.E.M. NO.	LENGTH	CENTER HOLE DIAM.	OUTSIDE HOLE DIAM.	CENTER TO CENTER	WIDTH	STEEL THICK.	APPLICATION
 15 - 1009	32061A	16-1/4" 412.8mm	5/8" 15.9mm			2-1/2" 63.5mm	.150" 3.8mm	(2) blades for 32" cut (3) blades for 48" cut.
 15 - 2172	32061A	16-1/4" 412.8mm	5/8" 15.9mm	11/32" 8.7mm	1-5/8" 41.3mm	2-1/2" 63.5mm	.240" 6.1mm	(Heavy Duty) (2) blades for 32" cut. (3) blades for 48" cut.
 15 - 10172	32061A	16-1/4" 412.8mm	5/8" 15.8mm			2-1/2" 63.5mm	.204" 5.2mm	Flat Blade Sharpened - 4-sides
 15 - 6296	32061A	16-1/4" 412.8mm	5/8" 15.9mm			2-1/2" 63.5mm	.204" 5.2mm	Mulching Blade PATENTED
 15 - 9967	32061A	16-1/4" 412.8mm	5/8" 15.8mm			2" 50.8mm	.240" 6.1mm	Low-Lift Blade Sharpened - 4-sides
 15 - 3400	112111-01	16-1/4" 412.8mm	5/8" 15.9mm			2-1/2" 63.5mm	.204" 5.2mm	(2) blades for 32" cut (3) blades for 48" cut
 15 - 1010	32022A	18" 457.2mm	5/8" 15.9mm	1/4" 6.4mm	1-5/8" 41.3mm	2-1/2" 63.5mm	.150" 3.8mm	(2) blades for 36" cut (3) blades for 54" cut
 15 - 2173	32022A	18" 457.2mm	5/8" 15.9mm			2-1/2" 63.5mm	.240" 6.1mm	(Heavy Duty) (2) blades for 36" cut (3) blades for 54" cut
 15 - 10173	32022A	18" 457.2mm	5/8" 15.8mm			2-1/2" 63.5mm	.204" 5.2mm	Flat Blade Sharpened - 4-sides
 15 - 6294	32022A	18" 457.2mm	5/8" 15.9mm			2-1/2" 63.5mm	.204" 5.2mm	Mulching Blade PATENTED
 15 - 9968	32022A	18" 457.2mm	5/8" 15.8mm			2" 50.8mm	.240" 6.1mm	Low-Lift Blade Sharpened - 4-sides
 15 - 3401	112111-02	18" 457.2mm	5/8" 15.9mm			2-1/2" 63.5mm	.204" 5.2mm	(2) blades for 36" cut











BLADES 14/16



BLADES

**Blades for
BOBCAT (continued)**



ORDER NO.	REPLACES O.E.M. NO.	LENGTH	CENTER HOLE DIAM.	OUTSIDE HOLE DIAM.	CENTER TO CENTER	WIDTH	STEEL THICK.	APPLICATION
 15 - 13016	112111-02	18" 457.2mm	5/8" 15.9mm			2-1/2" 63.5mm	.204" 5.2mm	(2) blades for a 36" cut. Mulching Blade. PATENTED
 15 - 6183	112243-02	18" 457.2mm	5/8" 15.9mm			2-1/2" 63.5mm	.204" 5.2mm	(2) blades for 36" cut (3) blades for 54" cut Low lift
 15 - 10174	42180B	21" 533.4mm	5/8" 15.8mm			2-1/2" 63.5mm	.204" 5.2mm	Flat Blade Sharpened - 4-sides
 15 - 9969	42180B	21" 533.4mm	5/8" 15.8mm			2" 50.8mm	.240" 6.1mm	Low-Lift Blade Sharpened - 4-sides
 15 - 1036	72039B	21" 533.4mm	3/8" 9.5mm	3/8" 9.5mm	2" 50.8mm	2-1/2" 63.5mm	.150" 3.8mm	
 15 - 2174	42180B	21" 533.4mm	5/8" 15.9mm			2-1/2" 63.5mm	.240" 6.1mm	(Heavy Duty) (3) blades for 61" cut
 15 - 6299	42180B	21" 533.4mm	5/8" 15.9mm			2-1/2" 63.5mm	.204" 5.2mm	Mulching Blade PATENTED
 15 - 3402	112111-03	21" 533.4mm	5/8" 15.9mm			2-1/2" 57.2mm	.240" 6.1mm	
 15 - 13017	112111-03	21" 533.4mm	5/8" 15.9mm			2-1/2" 63.5mm	.240" 6.1mm	(3) blades for a 61" cut. Mulching Blade PATENTED
 15 - 6272	112243-03	21" 533.4mm	5/8" 15.9mm			2-1/2" 57.2mm	.240" 6.1mm	(3) blades for 60" cut
 15 - 3329	112111-04 42139B	25" 635mm	5/8" 15.9mm			2-1/2" 57.2mm	.240" 6.1mm	(Heavy Duty) (3) blades for 74" cut.

14/16



BLADES

BLADES





**Blades for
BOLENS**



ORDER NO.	REPLACES O.E.M. NO.	LENGTH	CENTER HOLE DIAM.	OUTSIDE HOLE DIAM.	CENTER TO CENTER	WIDTH	STEEL THICK.	APPLICATION
 15 - 6066	172-7926	15-5/16" 388.9mm	3/8" 9.5mm	3/8" 9.5mm	2-3/4" 69.9mm	2" 50.8mm	.204" 5.2mm	(3) blades for 42" cut Fit models 18300, 30042R & 30042S center mount mower
 15 - 6068	177-2145 173-8571	17" 431.8mm	3/8" 9.5mm	3/8" 9.5mm	2-3/4" 69.9mm	2" 50.8mm	.204" 5.2mm	(3) for 48" cut attachment models 30048S, 30048E, 18336 & 192111
 15 - 6069	177-2335 174-7640	18-1/2" 469.9mm	3/4" 19.1mm	13/32" 10.3mm	2-9/16" 65.1mm	2" 50.8mm	.187" 4.8mm	(2) blades for 36" cut models 30036S & 31036S Fits Troy Bilt

BUNTON

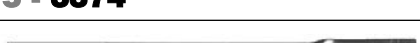
 15 - 3373	PL4055	16" 406.4mm	5/8" 15.9mm			2-1/2" 63.5mm	.204" 5.2mm	(3) blades for 48" cut Standard lift
 15 - 6115	PL4855	16-1/2" 419.1mm	5/8" 15.9mm			2-1/2" 63.5mm	.204" 5.2mm	Low lift blade (3) blades for 48" cut gear drive & hydro drive midsize V-deck models
 15 - 6116	PL4205	16-1/2" 419.1mm	5/8" 15.9mm			2-1/2" 63.5mm	.204" 5.2mm	High lift blade (3) blades for 48" cut gear drive & hydro drive midsize V-deck models
 15 - 6300	PL4205 PL4855	16-1/2" 419.1mm	5/8" 15.9mm			2-1/2" 63.5mm	.204" 5.2mm	Mulching Blade PATENTED
 15 - 6013	PL7329	17" 431.8mm	5/8" 15.8mm			2" 50.8mm	.240" 6.1mm	Low-Lift Blade Sharpened - 4-sides
 15 - 3374	P2005	18" 457.2mm	5/8" 15.9mm			2-1/2" 63.5mm	.204" 5.2mm	(3) blades for 52" cut Standard lift
 15 - 6014	PL4206	18" 457.2mm	5/8" 15.9mm			2-1/2" 63.5mm	.204" 5.2mm	(2) blades for 36" cut (3) blades for 52" cut High lift
 15 - 10173	PL4206	18" 457.2mm	5/8" 15.8mm			2-1/2" 63.5mm	.204" 5.2mm	Flat Blade Sharpened - 4-sides

14/16

BLADES



BLADES

**Blades for
BUNTON (continued)**







ORDER NO.	REPLACES O.E.M. NO.	LENGTH	CENTER HOLE DIAM.	OUTSIDE HOLE DIAM.	CENTER TO CENTER	WIDTH	STEEL THICK.	APPLICATION
 15 - 6294	PL4206	18" 457.2mm	5/8" 15.9mm			2-1/2" 63.5mm	.204" 5.2mm	Mulching Blade PATENTED
 15 - 9968	PL4206	18" 457.2mm	5/8" 15.8mm			2" 50.8mm	.240" 6.1mm	Low-Lift Blade Sharpened - 4-sides
 15 - 6141	PC005	21" 533.4mm	5/8" 15.9mm			2-1/2" 63.5mm	.204" 5.2mm	(3) blades for 61" cut
 15 - 10174	PC005	21" 533.4mm	5/8" 15.8mm			2-1/2" 63.5mm	.204" 5.2mm	Flat Blade Sharpened - 4-sides
 15 - 6299	PC005	21" 533.4mm	5/8" 15.9mm			2-1/2" 63.5mm	.204" 5.2mm	Mulching Blade PATENTED
 15 - 9969	PC005	21" 533.4mm	5/8" 15.8mm			2" 50.8mm	.240" 6.1mm	Low-Lift Blade Sharpened - 4-sides

CASE

 15 - 3332	C24442	15-9/16" 395.3mm	1-1/4" 31.8mm	7/16" 11.1mm	2-5/8" 66.7mm	2-1/2" 63.5mm	.187" 4.8mm	(3) blades for 44" cut Left hand cut
---	--------	---------------------	------------------	-----------------	------------------	------------------	----------------	---

CASTELGARDEN

 15 - 50146	81004396/0	16-5/64" 406.59mm	47/64" 18.26mm	23/64" 9.00mm	2-9/16" 64.80mm	2-13/64" 55.95mm	.125" 3.17mm	
 15 - 50145	81004397/0	18-3/64" 458.39mm	47/64" 18.26mm	23/64" 9.00mm	2-9/16" 64.80mm	2-13/64" 55.95mm	.125" 3.17mm	
 15 - 11310	82004345/0	18-3/16" 462mm	.710" 18.3mm	.340" 8.7mm	2-1/2" 63.5mm	2-1/4" 57mm	.117" 3.0mm	Left Hand Blade
 15 - 11311	82004344/0	18-3/16" 462mm	.710" 18.3mm	.340" 8.7mm	2-1/2" 63.5mm	2-1/4" 57mm	.117" 3.0mm	Right Hand Blade

14/16

BLADES

BLADES





Blades for CASTELGARDEN (continued)



ORDER NO.	REPLACES O.E.M. NO.	LENGTH	CENTER HOLE DIAM.	OUTSIDE HOLE DIAM.	CENTER TO CENTER	WIDTH	STEEL THICK.	APPLICATION
 15 - 50144	81004395	18-27/32" 478.63mm	47/64" 18.25mm	23/64" 9.00mm	2-9/16"	2-13/64"	.160" 4.00mm	
 15 - 13215	81004398/0	20" 508mm	.714 18mm			2-3/16"	.150" 3.8mm	Fits RL534, NP534TR, CA534TR, AL534TRE, TD534TRE, High Lift Blade.
 15 - 50142	82004340/0	20-1/2" 520.70mm	23/32" 18.25mm	23/64" 9.00mm	2-35/64"	2-13/64"	.160" 4.00mm	Takes (1) 50142 right hand cut and (1) 50143 blade. Comes as a set.
 15 - 50143	82004341/0	20-1/2" 520.70mm	23/32" 18.25mm	23/64" 9.00mm	2-9/16"	2-13/64"	.160" 4.00mm	Takes (1) 50143 left hand cut and (1) 50142 blade. Comes as a set.
 15 - 50162	82004343/0	24-7/16" 620.71mm	.714" 18.00mm	.343" 8.73mm	2.549"	2.165"	.160" 4.00mm	Left Hand Cut
 15 - 50163	82004342/0	24-7/16" 620.71mm	.741 18.00mm	3/4" 8.73mm	2.549"	2.165"	.160" 4.00mm	Right Hand Cut

CUB CADET

 15 - 6075	759-3848/759-3844 477-598-R3 490-471-R1	11" 279.4mm	3/4" 19.1mm			2-1/2"	.204" 5.2mm	1968 to 1973 models Takes (2) 15-6075 & (1) 15-6077 for 42" cut
 15 - 1030	942-04126 742-04126 742-04124 942-04124 942-0612 742-0612	14-13/16" 376.2mm	"H" Pattern	3/8" 9.5mm	2-1/2"	2-1/2"	.150" 3.8mm	Take (1) 15-1030 & (2) 15-1029 for 46" cut. Fits models 600 & 800 series. 1997 & after, side discharge tractors. Mulching blades.
 15 - 11476	742-04016	14-7/8" 377.8mm	3/4" 19.1mm			2-1/2"	.204" 5.2mm	3 in 1 blade. Center blade for 46" cut. Fits deck series 1500, 1529, LT1045 & 1046. Uses (1) 15-11476 & (2) 15-11478 .
 15 - 6081	759-8312 742-3002	15-1/8" 384.2mm	3/4" 19.1mm			2-1/2"	.204" 5.2mm	(3) for 44" cut Current models
 15 - 11805	01008616	15.94" 405mm	3/4" 19.1mm			3"	.204" 5.2mm	Fits Z Force Zero Turn Rider. High Lift Blade (3) blades for a 44" cut.











14/16

BLADES



**Blades for
CUB CADET (continued)**



ORDER NO.	REPLACES O.E.M. NO.	LENGTH	CENTER HOLE DIAM.	OUTSIDE HOLE DIAM.	CENTER TO CENTER	WIDTH	STEEL THICK.	APPLICATION
 15 - 10636	759-3939	16" 406.4mm	3/4" 19.05mm	5/16" 7.94mm	2-1/2" 63.5mm	2-1/2" 63.5mm	.204" 5.2mm	(3) blades for a 44" cut. Used on mowers from 2001 to present.
 15 - 11478	742-04015	16-1/4" 412.75mm	3/4" 19.1mm			2-1/2" 63.5mm	.204" 5.2mm	3 in 1 blade. Outer blade for 46" cut. Fits deck series 1500, 1529, LT1045 & 1046. Uses (1) 15-11476 & (2) 15-11478 .
 15 - 11564	1004772	16-1/2" 419.1mm	3/4" 19.05mm			3" 76.2mm	.204" 5.2mm	Fits Zero Turn Rider (3) blades for 48" cut.
 15 - 6240	742-3025 759-3825 742-3019	16-1/2" 419.1mm	3/4" 19.1mm	5/16" 7.9mm	2-1/2" 63.5mm	2-1/2" 63.5mm	.204" 5.2mm	(3) blades for 48" cut garden tractor model 2000 & Pro mid size walk behind
 15 - 10361	01005336	17" 431.8mm	3/4" 19.1mm			3" 76.2mm	.204" 5.2mm	(3) blades for 48" cut. High Lift Blade Fits Tanks Models
 15 - 6082	759-3813 742-3003	17-3/16" 436.6mm	3/4" 19.1mm			2-1/2" 63.5mm	.204" 5.2mm	(3) blades for 50" cut
 15 - 11479	759-04047 742-04068	17.9" 454.6mm	3/4" 19.05mm			2-1/2" 63.5mm	.150" 3.8mm	Fits 1000 series Hydrostatic lawn tractors. Model LT1024. (3) blades for 50" cut.
 15 - 11506	742-04068	17.9" 454.6mm	3/4" 19.05mm			2-1/2" 63.5mm	.187" 4.8mm	Fits 1000 series Hydrostatic lawn tractors. Model LT1024. Heavy Duty (3) blades for 50" cut.
 15 - 11480	742-04056 742-04053A	17.9" 454.6mm	Star			2-1/2" 63.5mm	.150" 3.8mm	Fits RZT series Tractors. Model RZT50 (3) blades for 50" cut.
 15 - 11507	742-04053A	17.9" 454.6mm	Star			2-1/2" 63.5mm	.187" 4.8mm	Fits RZT series Tractors. Heavy Duty Model RZT50 (3) blades for 50" cut.

14/16













BLADES

BLADES



**Blades for
CUB CADET (continued)**



ORDER NO.	REPLACES O.E.M. NO.	LENGTH	CENTER HOLE DIAM.	OUTSIDE HOLE DIAM.	CENTER TO CENTER	WIDTH	STEEL THICK.	APPLICATION
 15 - 12809	742-04053A 942-04053A	17.9" 454.66mm	star			2-1/2" 63.5mm	.187" 4.8mm	Mulching Blade PATENTED Fits RTZ series tractors.
 15 - 12909	742-04154	17.9" 454.6mm	59/64" X 11/16"			2-1/2" 63.5mm	.160" 4.0mm	(2) blades for a 33" cut walk behind.
 15 - 11250	01010168	17-29/32" 454.8mm	3/4" 19.05mm			2-1/2" 63.5mm	.204" 5.2mm	High Lift Blade (3) blades for a 50" cut. Fits Tank Commercial.
 15 - 6239	759-3841 759-3820 742-3013	18-1/2" 469.9mm	3/4" 19.1mm			3" 76.2mm	.204" 5.2mm	(3) blades for 54" cut garden tractor and Pro mid size walk behind
 15 - 11719	742-0677 942-0677	18-1/2" 469.9mm	"H" Pattern			3" 76.2mm	.204" 5.2mm	(3) blades for 54" cut. Fits 2002 and newer models 54" riders.
 15 - 12893	742-0739 942-0739	19" 482.6mm	59/64" X 11/16"			2-1/4" 57.2mm	.125" 3.18mm	Mulching Blade Fits 19" Walk behinds mowers.
 15 - 10362	01005337	19" 482.6mm	3/4" 19.1mm			3" 76.2mm	.204" 5.2mm	(3) blades for 54" cut. High Lift Blade Fit tank models
 15 - 6147	759-3816 742-3008	19-5/16" 490.5mm	3/4" 19.1mm			3" 76.2mm	.204" 5.2mm	(2) blades for 38" cut High lift
 15 - 11477	759-3829 742-3032	19-3/8" 492.3mm	3/4" 19.1mm			2-3/4" 69.85mm	.204" 5.2mm	3 in 1 blade. Fits deck series 2315 & 2146. (2) blades for a 38" cut.
 15 - 6238	759-3817 742-3009	19-3/8" 492.1mm	3/4" 19.1mm	5/16" 7.9mm	2-1/2" 63.5mm	3" 76.2mm	.204" 5.2mm	(2) blades for 38" cut front engine rider models 1015, 1020, 1030, 1715 & 1720
 15 - 10383	1004719	20-1/2" 520.7mm	3/4" 19.05mm			3" 76.2mm	.204" 5.2mm	(3) blades for a 60" cut. Fits Cub Cadet & MTD Pro "ZERO TURN"s with stamped steel decks.
 15 - 10363	01005338	21" 533.4mm	3/4" 19.1mm			3" 76.2mm	.204" 5.2mm	(3) blades for 60" cut. High Lift Blade Fits Tanks models





14/16
BLADES



BLADES

**Blades for
CUB CADET (continued)**



ORDER NO.	REPLACES O.E.M. NO.	LENGTH	CENTER HOLE DIAM.	OUTSIDE HOLE DIAM.	CENTER TO CENTER	WIDTH	STEEL THICK.	APPLICATION
 15 - 6237	759-3824 742-3018	21-3/16" 538.2mm	3/4" 19.1mm	5/16" 7.9mm	2-1/2" 63.5mm	3" 76.2mm	.204" 5.2mm	(2) blades for 42" cut garden tractor models 2000 & 1440
 15 - 6078	759-3853 547-191-R1	21-1/4" 539.8mm	3/8" 9.5mm	17/32" 5.6mm	4-1/2" 114.3mm	2-1/2" 63.5mm	.204" 5.2mm	(3) for 60" cut
 15 - 11475	759-3830 742-3033 742-04101	21-1/4" 539.75mm	3/4" 19.1mm			2-3/4" 69.85mm	.204" 5.2mm	3 in 1 blade. Fits deck series 1500 & 1517. (2) blades for a 42" cut.
 15 - 6077	759-3850/759-3843 477-597-R3 490-473-R1	22-3/16" 563.6mm	3/4" 19.1mm			2-1/2" 63.5mm	.204" 5.2mm	1968 to 1973 models Takes (1) 15-6077 & (2) 15-6075 for 42" cut.

DIXIE CHOPPER

 15 - 6020	30227-42	14-1/2" 368.3mm	5/8" 15.9mm			2-1/2" 63.5mm	.203" 5.2mm	(3) blades for 42" cut
 15 - 6316	30227-42	14-1/2" 368.3mm	5/8" 15.9mm			2-1/2" 63.5mm	.204" 5.2mm	Mulching Blade PATENTED
 15 - 3372	30227-50	17" 431.8mm	5/8" 15.9mm			2" 50.8mm	.204" 5.2mm	(3) blades for 50" deck
 15 - 6790	30227-50V	17" 431.8mm	5/8" 15.9mm			2-1/2" 63.5mm	.240" 6.1mm	(3) blades for 50" cut. High lift for wet grass.
 15 - 6224	30227-H	17" 431.8mm	5/8" 15.9mm			2-1/2" 63.5mm	.204" 5.2mm	(3) blades for 50" cut "ZERO TURN"
 15 - 6442	30227-N	17" 431.8mm	5/8" 15.8mm			3" 76.2mm	.240" 6.1mm	(3) blades for 50" cut. Fits "Zero Turn" models. High Lift
 15 - 6298	30227-50 30227-50V	17" 431.8mm	5/8" 15.9mm			2-1/2" 63.5mm	.204" 5.2mm	Mulching Blade PATENTED
 15 - 6013	30227-50	17" 431.8mm	5/8" 15.8mm			2" 50.8mm	.240" 6.1mm	Low-Lift Blade Sharpened - 4-sides

14/16















BLADES

BLADES



**Blades for
DIXIE CHOPPER (continued)**



ORDER NO.	REPLACES O.E.M. NO.	LENGTH	CENTER HOLE DIAM.	OUTSIDE HOLE DIAM.	CENTER TO CENTER	WIDTH	STEEL THICK.	APPLICATION
 15 - 13986	30227-56	20" 508mm	5/8" 15.9mm			2-1/4" 57.2mm	.240" 6.1mm	Mulching Blade
 15 - 13419	30227-56H	20" 508mm	5/8" 15.9mm			2-1/4" 57.2mm	.240" 6.1mm	(3) blades for 56" cut.
 15 - 6083	30227-60-V	20-1/2" 520.7mm	5/8" 15.9mm			2-1/2" 63.5mm	.240" 6.1mm	(3) blades for 60" cut High lift for wet grass
 15 - 6441	30227-60H	20-1/2" 520.7mm	5/8" 15.9mm			3" 76.2mm	.240" 6.1mm	(3) blades for 60" cut. High Lift.
 15 - 10175	30227-60	20-1/2" 520.7mm	5/8" 15.8mm			2-1/2" 63.5mm	.204" 5.2mm	Flat Blade Sharpened - 4-sides
 15 - 6303	30227-60 30227-60-V	20-1/2" 520.7mm	5/8" 15.9mm			2-1/2" 63.5mm	.204" 5.2mm	Mulching Blade PATENTED
 15 - 6194	30227-60	20-1/2" 520.7mm	5/8" 15.8mm			2" 50.8mm	.240" 6.1mm	Low-Lift Blade Sharpened - 4-sides
 15 - 6180	9383	20-1/2" 520.7mm	5/8" 15.9mm			2-1/2" 63.5mm	.240" 6.1mm	(3) blades for 60" cut
 15 - 14442	 30227-62X 30227-62T	21-3/8" 533.4mm	5/8" 15.8mm			2-1/2" 63.5mm	.240" 6.1mm	
 15 - 14467	 30227-62X 30227-62T	21-3/8" 533.4mm	5/8" 15.8mm			2-1/2" 63.5mm	.240" 6.1mm	Mulching Blade PATENTED
 15 - 13987	30227-66	23-5/16" 592.14mm	5/8" 15.9mm			2-1/4" 57.2mm	.240" 6.1mm	Mulching Blade (3) blades for 60" cut
 15 - 12616	30227-66H	23-5/16" 592.14mm	5/8" 15.9mm			2-1/4" 57.2mm	.240" 6.1mm	(3) blades for 66" cut.



14/16
BLADES











BLADES

**Blades for
DIXIE CHOPPER (continued)**



ORDER NO.	REPLACES O.E.M. NO.	LENGTH	CENTER HOLE DIAM.	OUTSIDE HOLE DIAM.	CENTER TO CENTER	WIDTH	STEEL THICK.	APPLICATION
 15 - 6404	30227-72H	24" 609.6mm	5/8" 15.9mm			2-1/2" 63.5mm	.240" 6.1mm	(3) blades for 72" cut.
 15 - 6833	30227-72N	24" 609.6mm	5/8" 15.9mm			3" 76.2mm	.240" 6.1mm	(3) blades for 72" cut. (Heavy Duty)

DIXON

 15 - 1100	6092	14-3/8" 365.1mm	11/16" 17.5mm			2" 50.8mm	.187" 4.8mm	(3) blades for 42" cut Low lift
 15 - 6312	6092/6013 8600	14-7/16" 366.71mm	45/64" 17.9mm			2-1/2" 63.5mm	.187" 4.8mm	Mulching Blade
 15 - 6086	6236	14-1/2" 368.3mm	11/16" 17.5mm			2-1/2" 63.5mm	.187" 4.8mm	For "ZERO TURN" models 428 & 429 (3) blades for 42" cut Low lift
 15 - 6087	8688	14-1/2" 368.3mm	11/16" 17.5mm			2-1/2" 63.5mm	.187" 4.8mm	For "ZERO TURN" models 428 & 429 (3) blades for 42" cut High lift
 15 - 1066	9229	17" 431.8mm	5/8" 15.9mm			2" 50.8mm	.204" 5.2mm	Std. deck (3) blades for 50" cut
 15 - 6088	9265	17" 431.8mm	5/8" 15.9mm			2-1/2" 63.5mm	.187" 4.8mm	For "ZTR" models 502 & 503 (3) blades for 50" deck High lift
 15 - 6298	9258 9265	17" 431.8mm	5/8" 15.9mm			2-1/2" 63.5mm	.204" 5.2mm	Mulching Blade PATENTED
 15 - 6782	9443	17" 431.4mm	11/16" 17.9mm			2-1/2" 63.5mm	.187" 4.8mm	(3) blades for 50" cut. Low lift.
 15 - 6766	9444	17" 431.4mm	11/16" 17.9mm			2-1/2" 63.5mm	.187" 4.8mm	(3) blades for 50" cut. High lift.

14/16

BLADES

BLADES



Blades for
DIXON (continued)





ORDER NO.	REPLACES O.E.M. NO.	LENGTH	CENTER HOLE DIAM.	OUTSIDE HOLE DIAM.	CENTER TO CENTER	WIDTH	STEEL THICK.	APPLICATION
 15 - 6785	6897	17" 431.8mm	11/16" 17.9mm			2-1/2" 63.5mm	.204" 5.2mm	Mulching Blade PATENTED
 15 - 6084	1351	18-7/16" 468.3mm	3/4" 19.1mm	13/32" 10.3mm	2-9/16" 65.1mm	2-3/4" 69.9mm	.187" 4.8mm	For ZTR 361 W/Catcher
 15 - 6101	1324	18-1/2" 469.9mm	11/16" 17.46mm			2" 50.8mm	.187" 4.8mm	For ZTR model 361 only Takes (2) blades for 36" cut
 15 - 6180	9383	20-1/2" 520.7mm	5/8" 15.9mm			2-1/2" 63.5mm	.240" 6.1mm	(3) blades for 60" cut
 15 - 6303	9383	20-1/2" 520.7mm	5/8" 15.9mm			2-1/2" 63.5mm	.204" 5.2mm	Mulching Blade PATENTED
 15 - 6784	9445	20-1/2" 520.7mm	11/16" 17.9mm			2-1/2" 63.5mm	.240" 6.1mm	(3) blades for 60" cut. High lift.
 15 - 1089	8278 30-2406	30" 762mm	7/8" 22.2mm			2-3/4" 69.9mm	.187" 4.8mm	

ECONOMY (POWER KING)

 15 - 825	60-4301	16-1/2" 419.1mm	3/4" 19.1mm	13/32" 10.3mm	3-1/8" 79.4mm	2-1/4" 63.5mm	.187" 4.8mm	(3) blades for 48" cut left hand cut
--	---------	--------------------	----------------	------------------	------------------	------------------	----------------	---

ELECTROLUX

 15 - 50034	6448400	18" 457.2mm	.394" 10.3mm	.331" 8.7mm	2.56" 65.1mm	3.0" 76.2mm	.095" 2.8mm	
 15 - 50060	6445800	18.7" 475.38mm	.400" 10.3mm	.337" 8.7mm	2.56" 65.1mm	2.5" 63.5mm	.134" 3.6mm	

14/16



BLADES







BLADES

**Blades for
ENCORE**



ORDER NO.	REPLACES O.E.M. NO.	LENGTH	CENTER HOLE DIAM.	OUTSIDE HOLE DIAM.	CENTER TO CENTER	WIDTH	STEEL THICK.	APPLICATION
 15 - 6279 MIN028	253027	4-1/4" 108mm	17/32" 13.5mm			1" 25.4mm	.117" 3mm	Finger Blades. Fits Encore Power Thatcher model 25T100. Fits our 10-8524 shaft. 28 blades per
 15 - 11647 MIN028	253027	4-1/4" 108mm	17/32" 13.5mm			1" 25.4mm	.117" 3.0mm	Fits models 25T1000 Replaces Exmark 503031. (NHT) Minimum 28
 15 - 3403	483035	16-1/2" 419.1mm	5/8" 15.8mm				.204" 5.2mm	(3) blades for 48" cut mid size mower.
 15 - 3404	363291 482306	18" 457.2mm	5/8" 15.8mm				.204" 5.2mm	(2) blades for 36" cut mid size mower.
 15 - 10173	363291 482462	18" 457.2mm	5/8" 15.8mm			2-1/2" 63.5mm	.204" 5.2mm	Flat Blade Sharpened - 4-sides
 15 - 6294	363291	18" 457.2mm	5/8" 15.8mm			2-1/2" 63.5mm	.204" 5.2mm	Mulching Blade PATENTED
 15 - 9968	363291	18" 457.2mm	5/8" 15.8mm			2" 50.8mm	.240" 6.1mm	Low-Lift Blade Sharpened - 4-sides

EVERRIDE

 15 - 12251	191107	16-1/2" 419.1mm	9/16" 14.3mm			2-1/4" 57.2mm	.204" 5.2mm	(3) blades for a 48" cut. Standard Blade
 15 - 12375	191108	18" 457.2mm	9/16" 14.29mm			2-1/4" 57.2mm	.204" 5.2mm	(3) blades for a 52" cut.
 15 - 11662	181042	19" 482.6mm	9/16" 14.3mm			2-1/2" 63.5mm	.204" 5.2mm	(3) blades for a 54" cut.
 15 - 11663	181026	21" 533.4mm	9/16" 14.3mm			2-1/2" 63.5mm	.204" 5.2mm	(3) blades for a 61" cut.

14/16













BLADES

BLADES



Blades for EXMARK



ORDER NO.	REPLACES O.E.M. NO.	LENGTH	CENTER HOLE DIAM.	OUTSIDE HOLE DIAM.	CENTER TO CENTER	WIDTH	STEEL THICK.	APPLICATION
 15 - 6279 MIN028	1-503031	4-1/4" 108mm	17/32" 13.5mm			1" 25.4mm	.117" 3mm	Finger Blades. Fits Encore Power Thatcher model 25T100. Fits our 10-8524 shaft. 28 blades per set.
 15 - 6834	1-513264	7" 177.8mm	1/2" 12.7mm			2-1/2" 63.5mm	.160" 4.1mm	Sweeper Blade. For 44" Exmark "ZERO TURN". Used with our 15-6089 & 15-6090
 15 - 6820	1-653102	15-1/4" 387.4mm	5/8" 15.9mm			2-1/2" 63.5mm	.204" 5.2mm	(3) blades for 44" cut. Mulching Blade
 15 - 10420	103-1579	15-1/4" 387.4mm	5/8" 15.9mm			2-1/2" 63.5mm	.204" 5.2mm	(3)blade for 44" cut Solid Air Foil Hi-Lift.
 15 - 11269	103-6400	15-1/4" 387.4mm	15/16" 23.8mm			2-1/2" 63.5mm	.204" 5.2mm	Notched Air Foil Blade (3) blades for 44" cut. High Lift Blade.
 15 - 11243	103-6395	15-1/4" 387.4mm	15/16" 23.8mm			2-1/2" 63.5mm	.204" 5.2mm	Patented (3) blades for 44" cut. Mulching Blade.
 15 - 11500	103-6390	15-1/4" 387.4mm	15/16" 23.8mm			2-1/2" 63.5mm	.204" 5.2mm	Commercial Mulcher (3) blades for 44" cut.
 15 - 6821	1-653101	15-5/16" 388.9mm	5/8" 15.9mm			2-1/2" 63.5mm	.204" 5.2mm	(3) blades for 44" cut. High lift.
 15 - 9884	1-653101	15-5/16" 388.9mm	5/8" 15.8mm			2-1/2" 63.5mm	.204" 5.2mm	Mulching Blade PATENTED
 15 - 1009	1-403026	16-1/4" 412.8mm	5/8" 15.9mm	1/4" 6.4mm	1-5/8" 41.3mm	2-1/2" 63.5mm	.150" 3.8mm	(3) blades for 48" cut
 15 - 2172	1-403059	16-1/4" 412.8mm	5/8" 15.9mm	11/32" 8.7mm	1-5/8" 41.3mm	2-1/2" 63.5mm	.240" 6.1mm	(3) blades for 48" cut (Heavy Duty)
 15 - 10718	103-2507	16-1/4" 412.8mm	5/8" 15.9mm			2-1/2" 63.5mm	.204" 5.2mm	Low Lift blade. (3) blades for a 48" cut.

14/16













BLADES



BLADES

Blades for EXMARK (continued)



ORDER NO.	REPLACES O.E.M. NO.	LENGTH	CENTER HOLE DIAM.	OUTSIDE HOLE DIAM.	CENTER TO CENTER	WIDTH	STEEL THICK.	APPLICATION
 15 - 9487	1-323515	16-1/4" 412.8mm	5/8" 15.8mm			2-1/2" 63.5mm	.204" 5.2mm	(3) blades for 48" cut. Fits Turf Tracer, HP Metro, & Viking units.
 15 - 6175	1-403086	16-1/4" 412.8mm	5/8" 15.9mm			2-1/2" 63.5mm	.160" 4.1mm	(3) blades for 48" cut Mulching blade
 15 - 9988	1036581 1-403148	16-1/4" 412.8mm	5/8" 15.9mm			2-1/2" 63.5mm	.204" 5.2mm	(3) blades for 48" cut. Mulching Blade (Heavy Duty)
 15 - 10419	103-1577	16-1/4" 412.8mm	5/8" 15.9mm			2-1/2" 63.5mm	.204" 5.2mm	(2)blade for 32" cut (3)blade for 48" cut Solid Air Foil Hi-Lift.
 15 - 10172	1-403026 1-403059 1-403086	16-1/4" 412.8mm	5/8" 15.8mm			2-1/2" 63.5mm	.204" 5.2mm	Flat Blade Sharpened - 4-sides
 15 - 6296	1-403026 1-403059 1-403086	16-1/4" 412.8mm	5/8" 15.9mm			2-1/2" 63.5mm	.204" 5.2mm	Mulching Blade PATENTED
 15 - 9967	1-403026 1-403059 1-403086	16-1/4" 412.8mm	5/8" 15.8mm			2" 50.8mm	.240" 6.1mm	Low-Lift Blade Sharpened - 4-sides
 15 - 11494	103-6386	16-1/4" 412.7mm	15/16" 23.8mm			2-1/2" 63.5mm	.204" 5.2mm	Low Lift Blade (2) blades for 32" cut. (3) blades for 48" cut.
 15 - 11493	103-6381	16-1/4" 412.7mm	15/16" 23.8mm			2-1/2" 63.5mm	.204" 5.2mm	High Lift Blade (2) blades for 32" cut. (3) blades for 48" cut.
 15 - 11231	103-6401	16-1/4" 412.7mm	15/16" 23.8mm			2-1/2" 63.5mm	.204" 5.2mm	Notched Air Foil Blade. (3) blades for 48" cut. High Lift Blade.
 15 - 11240	103-6391	16-1/4" 412.7mm	15/16" 23.8mm			2-1/2" 63.5mm	.204" 5.2mm	(3) blades for 48" cut. Mulching Blade.
 15 - 11279	103-6396	16-1/4" 412.7mm	15/16" 23.8mm			2-1/2" 63.5mm	.204" 5.2mm	Patented (3) blades for 48" cut. Mulching Blade.

14/16

BLADES

BLADES



Blades for EXMARK (continued)



ORDER NO.	REPLACES O.E.M. NO.	LENGTH	CENTER HOLE DIAM.	OUTSIDE HOLE DIAM.	CENTER TO CENTER	WIDTH	STEEL THICK.	APPLICATION
 15 - 12002	103-8251	16-1/4" 412.75mm	15/16" 23.8mm			3" 76.2mm	.204" 5.2mm	High Lift Blade (3) blades for a 46" cut.
 15 - 11770	103-8296 103-8370	16-1/4" 412.75mm	15/16" 23.8mm			3" 76.2mm	.204" 5.2mm	Med. Lift Blade (3) blades for a 46" cut.
 15 - 11769	103-8296 103-8390	16-1/4" 412.75mm	15/16" 23.8mm			3" 76.2mm	.204" 5.2mm	Low Lift Blade (3) blades for a 46" cut.
 15 - 11771	103-8296 103-8288	16-1/4" 412.75mm	15/16" 23.8mm			3" 76.2mm	.204" 5.2mm	Mulching Blade (3) blades for a 46" cut.
 15 - 11772	103-9614 103-8296	16-1/4" 412.75mm	15/16" 23.8mm			3" 76.2mm	.204" 5.2mm	Mulching Blade PATENTED (3) blades for a 46" cut.
 15 - 12003	103-9605	17-1/2" 444.5mm	15/16" 23.8mm			3" 76.2mm	.204" 5.2mm	High Lift Blade (3) blades for a 50" cut.
 15 - 11774	103-9600	17-1/2" 444.5mm	15/16" 23.8mm			3" 76.2mm	.204" 5.2mm	Med Lift Blade (3) blades for a 50" cut.
 15 - 11773	103-9598	17-1/2" 444.5mm	15/16" 23.8mm			3" 76.2mm	.204" 5.2mm	Low Lift Blade (3) blades for a 50" cut.
 15 - 11775	103-9510	17-1/2" 444.5mm	15/16" 23.8mm			3" 76.2mm	.204" 5.2mm	Mulching Blade (3) blades for a 50" cut.
 15 - 11776	103-9615	17-1/2" 444.5mm	15/16" 23.8mm			3" 76.2mm	.204" 5.2mm	Mulching Blade PATENTED (3) blades for a 50" cut.
 15 - 6291	1-633484	17-29/32" 454.8mm	5/8" 15.9mm			2-1/2" 63.5mm	.204" 5.2mm	(3) blades for 52" cut Mulching blade
 15 - 6178	1-303495	17-15/16" 455.6mm	5/8" 15.9mm			2-1/2" 63.5mm	.160" 4.1mm	(2) blades for 36" cut Mulching blade

14/16













BLADES



BLADES

**Blades for
EXMARK (continued)**



ORDER NO.	REPLACES O.E.M. NO.	LENGTH	CENTER HOLE DIAM.	OUTSIDE HOLE DIAM.	CENTER TO CENTER	WIDTH	STEEL THICK.	APPLICATION
 15 - 1010	1-303146	18" 457.2mm	5/8" 15.9mm	1/4" 6.4mm	1-5/8" 41.3mm	2-1/2" 63.5mm	.150" 3.8mm	(2) blades for 36" cut
 15 - 2173	1-303283	18" 457.2mm	5/8" 15.9mm			2-1/2" 63.5mm	.240" 6.1mm	(3) blades ofr 52" cut (2) blades for 36" cut (Heavy Duty)
 15 - 6217	1-603844	18" 457.2mm	1/2" 12.7mm			2-1/2" 63.5mm	.204" 5.2mm	(3) blades for 52" cut Fits model FMD52 Low lift
 15 - 10719	103-2508	18" 457.2mm	5/8" 15.9mm			2-1/2" 63.5mm	.204" 5.2mm	Low Lift blade. (3) blades for a 52" cut.
 15 - 10071	1-303527	18" 457.2mm	5/8" 15.9mm			2-1/2" 63.5mm	.204" 5.2mm	(3) blades for 52" cut. High Lift Blade. Fits Lazer Z units.
 15 - 10173	1-303146	18" 457.2mm	5/8" 15.8mm			2-1/2" 63.5mm	.204" 5.2mm	Flat Blade Sharpened - 4-sides
 15 - 6294	1-303146	18" 457.2mm	5/8" 15.9mm			2-1/2" 63.5mm	.204" 5.2mm	Mulching Blade PATENTED
 15 - 9968	1-303146	18" 457.2mm	5/8" 15.8mm			2" 50.8mm	.240" 6.1mm	Low-Lift Balde Sharpened - 4-sides
 15 - 11267	103-6397	18" 457.2mm	15/16" 23.8mm			2-1/2" 63.5mm	.204" 5.2mm	(3) blades for 52" cut. Mulching Blade.
 15 - 11241	103-6392	18" 457.2mm	15/16" 23.8mm			2-1/2" 63.5mm	.204" 5.2mm	(2) blades for 36" cut. (3) blades for 52" cut. Mulching Blade.
 15 - 11495	103-6402	18" 457.2mm	15/16" 23.8mm			2-1/2" 63.5mm	.204" 5.2mm	High Lift Blade (2) blades for 36" cut. (3) blades for 52" cut.
 15 - 11450	103-6382	18" 457.2mm	15/16" 23.8mm			2-1/2" 63.5mm	.204" 5.2mm	High Lift Blade (3) blades for 52" cut.

14/16

BLADES

BLADES



Blades for EXMARK (continued)



ORDER NO.	REPLACES O.E.M. NO.	LENGTH	CENTER HOLE DIAM.	OUTSIDE HOLE DIAM.	CENTER TO CENTER	WIDTH	STEEL THICK.	APPLICATION
 15 - 11451	103-6387	18" 457.2mm	15/16" 23.8mm			2-1/2" 63.5mm	.204" 5.2mm	Low Lift Blade (3) blades for 52" cut.
 15 - 12004	103-9606	19-1/2" 495.3mm	15/16" 23.8mm			3" 76.2mm	.204" 5.2mm	High Lift Blade (3) blades for a 56" cut.
 15 - 11778	103-9607	19-1/2" 495.3mm	15/16" 23.8mm			3" 76.2mm	.204" 5.2mm	Med Lift Blade (3) blades for a 56" cut.
 15 - 11777	103-9603	19-1/2" 495.3mm	15/16" 23.8mm			3" 76.2mm	.204" 5.2mm	Low Lift Blade (3) blades for a 56" cut.
 15 - 11779	103-9611	19-1/2" 495.3mm	15/16" 23.8mm			3" 76.2mm	.204" 5.2mm	Mulching Blade (3) blades for a 56" cut.
 15 - 11780	116-5498 103-9628	19-1/2" 495.3mm	15/16" 23.8mm			3" 76.2mm	.204" 5.2mm	Mulching Blade PATENTED (3) blades for a 56" cut.
 15 - 10928	93-4106-03 108-3762-03	20-27/32" 531mm	7/16" 11mm	3/8" 9.5mm	2-7/16" 61.9mm	2-1/4" 57.2mm	.150" 3.8mm	Fits 21" Recycler Walkbehind mower.
 15 - 6250	1-603283	20-1/2" 520.7mm	1/2" 12.7mm			2-1/2" 63.5mm	.204" 5.2mm	Std. high lift for models Explorer, Explorer II, Turf Ranger & Turf Tracer. (3) blades for 60" cut.
 15 - 6216	1-603661	20-1/2" 520.7mm	1/2" 12.7mm			2-1/2" 63.5mm	.204" 5.2mm	(3) blades for 60" cut Fits model FMD60 Low lift
 15 - 6180	9383	20-1/2" 520.7mm	5/8" 15.9mm			2-1/2" 63.5mm	.240" 6.1mm	(3) blades for 60" cut
 15 - 10249		20-1/2" 520.7mm	5/8" 15.9mm			2-1/2" 63.5mm	.204" 5.2mm	60" deck. Low lift sand blade 20-1/2" x 5/8" center hole. Same as out 15-6216 but with a 5/8" center hole.
 15 - 11242	103-6393	20-1/2" 520.7mm	15/16" 23.8mm			3" 76.2mm	.204" 5.2mm	Fits Lazer model. (3) blades for 60" cut. Mulching Blade.

14/16











BLADES

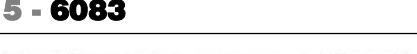

BLADES

Blades for EXMARK (continued)



ORDER NO.	REPLACES O.E.M. NO.	LENGTH	CENTER HOLE DIAM.	OUTSIDE HOLE DIAM.	CENTER TO CENTER	WIDTH	STEEL THICK.	APPLICATION
 15 - 11249	103-6383	20-1/2" 520.7mm	15/16" 23.8mm			2-1/2" 63.5mm	.240" 6.1mm	Air Foil Blade (3) blades for 60" cut. High lift blade.
 15 - 11248	103-6403	20-1/2" 520.7mm	15/16" 23.8mm			2-1/2" 63.5mm	.240" 6.1mm	(3) blades for 60" cut. Notched High lift blade
 15 - 11224	103-6403	20-1/2" 520.7mm	15/16" 23.8mm			2-1/2" 63.5mm	.204" 5.2mm	High lift blade (3) blades for 60" cut. Notched Air lift blade.
 15 - 11139	103-0301 1-613112	20-1/2" 520.7mm	5/8" 15.8mm			3" 76.2mm	.204" 5.2mm	(3) blades for 60" cut. Mulching Blade.
 15 - 9465	1-603283	20-1/2" 520.7mm	1/2" 12.7mm			2-1/2" 63.5mm	.204" 5.2mm	Mulching Blade PATENTED
 15 - 10667	103-2530	20-1/2" 520.7mm	5/8" 15.9mm			2-1/2" 63.5mm	.204" 5.2mm	Notched High Lift blade. (3) blades for a 60" cut.
 15 - 6083	1-633483	20-1/2" 520.7mm	5/8" 15.9mm			2-1/2" 63.5mm	.240" 6.1mm	(3) blades for 60" cut. High lift for wet grass
 15 - 6290	1-613112	20-1/2" 520.7mm	5/8" 15.9mm			2-1/2" 63.5mm	.204" 5.2mm	(3) blades for 60" cut. Mulching Blade
 15 - 10175	1-613112	20-1/2" 520.7mm	5/8" 15.8mm			2-1/2" 63.5mm	.204" 5.2mm	Flat Blade Sharpened - 4-sides
 15 - 6303	1-613112	20-1/2" 520.7mm	5/8" 15.9mm			2-1/2" 63.5mm	.204" 5.2mm	Mulching Blade PATENTED
 15 - 6194	1-613112	20-1/2" 520.7mm	5/8" 15.8mm			2" 50.8mm	.240" 6.1mm	Low-Lift Blade Sharpened - 4-sides
 15 - 11496	103-6388	20-1/2" 520.7mm	15/16" 23.8mm			2-1/2" 63.5mm	.204" 5.2mm	Formed Low Lift Blade (3) blades for 60" cut.

14/16

BLADES

BLADES



Blades for EXMARK (continued)



ORDER NO.	REPLACES O.E.M. NO.	LENGTH	CENTER HOLE DIAM.	OUTSIDE HOLE DIAM.	CENTER TO CENTER	WIDTH	STEEL THICK.	APPLICATION
 15 - 11469	103-6398	20-1/2" 520.7mm	15/16" 23.8mm			2-1/2" 63.5mm	.204" 5.2mm	Commercial Mulcher (3) blades for 60" cut.
 15 - 12005	103-8244	20-3/4" 527.1mm	15/16" 23.8mm			3" 76.2mm	.204" 5.2mm	High Lift Blade (3) blades for a 60" cut.
 15 - 11782	103-8396	20-3/4" 527.1mm	15/16" 23.8mm			3" 76.2mm	.204" 5.2mm	Med Lift Blade (3) blades for a 60" cut.
 15 - 11781	103-8240	20-3/4" 527.1mm	15/16" 23.8mm			3" 76.2mm	.204" 5.2mm	Low Lift Blade (3) blades for a 60" cut.
 15 - 11783	103-8107	20-3/4" 527.1mm	15/16" 23.8mm			3" 76.2mm	.204" 5.2mm	Mulching Blade (3) blades for a 60" cut.
 15 - 11784	103-9629	20-3/4" 527.1mm	15/16" 23.8mm			3" 76.2mm	.204" 5.2mm	Mulching Blade PATENTED (3) blades for a 60" cut.
 15 - 13260	108-0954-03	21" 533.4mm	7/16" 11.1mm			2-1/4" 57.2mm	.150" 4mm	Replaces Toro Atomic Bld Mulching Blade PATENTED
 15 - 14491	 116-1037-S	22-1/4" 558.8mm	15/16" 23.8mm			2-1/2" 63.5mm	.187" 4.7mm	(2) blades for 44" cut Fits Quest mowers.
 15 - 12027	103-9618	22-3/4" 577.85mm	15/16" 23.8mm			3" 76.2mm	.204" 5.2mm	High Lift Blade (3) blades for a 66" cut.
 15 - 11786	103-9619	22-3/4" 577.85mm	15/16" 23.8mm			3" 76.2mm	.204" 5.2mm	Med Lift Blade (3) blades for a 66" cut.
 15 - 11785	103-9616	22-3/4" 577.85mm	15/16" 23.8mm			3" 76.2mm	.204" 5.2mm	Low Lift Blade (3) blades for a 66" cut.
 15 - 11787	103-9612	22-3/4" 577.85mm	15/16" 23.8mm			3" 76.2mm	.204" 5.2mm	Mulching Blade (3) blades for a 66" cut.













14/16
BLADES



BLADES

Blades for EXMARK (continued)



ORDER NO.	REPLACES O.E.M. NO.	LENGTH	CENTER HOLE DIAM.	OUTSIDE HOLE DIAM.	CENTER TO CENTER	WIDTH	STEEL THICK.	APPLICATION
 15 - 11788	103-9630	22-3/4" 577.85mm	15/16" 23.8mm			3" 76.2mm	.204" 5.2mm	Mulching Blade PATENTED (3) blades for a 66" cut.
 15 - 6481	1-643006 103-2531	24-13/32" 619.9mm	5/8" 15.9mm			3" 76.2mm	.204" 5.2mm	(3) blades for 72" cut. Fits model Lazer Z.
 15 - 9882	103-2521 1-643097	24-1/2" 622.3mm	5/8" 15.9mm			3" 76.2mm	.204" 5.2mm	(3) blades for 72" cut. Mulching blade. Fits Lazer Z units.
 15 - 10421	103-1581	24-1/2" 622.3mm	5/8" 15.9mm			3" 76.2mm	.204" 5.2mm	(3) blades for 72" cut Solid Air Foil Hi-Lift.
 15 - 11498	103-6384	24-1/2" 622.3mm	15/16" 23.8mm			3" 76.2mm	.204" 5.2mm	Solid Air Foil High Lift (3) blades for 72" cut.
 15 - 11501	103-6399	24-1/2" 622.3mm	15/16" 23.8mm			2-1/2" 63.5mm	.204" 5.2mm	Commercial Mulcher (3) blades for 72" cut.
 15 - 11244	103-6394	24-1/2" 622.3mm	15/16" 23.8mm			3" 76.2mm	.204" 5.2mm	Fits 72" Lazer model. (3) blades for 72" cut. Mulching Blade.
 15 - 11229	103-6404	24-1/2" 622.3mm	15/16" 23.8mm			3" 76.2mm	.204" 5.2mm	Fits 72" Lazer model. (3) blades for 72" cut. Air Foil Lift Blade.
 15 - 12028	103-9624	24-3/4" 628.7mm	15/16" 23.8mm			3" 76.2mm	.204" 5.2mm	High Lift Blade (3) blades for a 72" cut.
 15 - 11790	103-9625	24-3/4" 628.7mm	15/16" 23.8mm			3" 76.2mm	.204" 5.2mm	Med Lift Blade (3) blades for a 72" cut.
 15 - 11789	103-9622	24-3/4" 628.7mm	15/16" 23.8mm			3" 76.2mm	.204" 5.2mm	Low Lift Blade (3) blades for a 72" cut.
 15 - 11791	103-9613	24-3/4" 628.7mm	15/16" 23.8mm			3" 76.2mm	.204" 5.2mm	Mulching Blade (3) blades for a 72" cut.

14/16



BLADES

BLADES



Blades for EXMARK (continued)



ORDER NO.	REPLACES O.E.M. NO.	LENGTH	CENTER HOLE DIAM.	OUTSIDE HOLE DIAM.	CENTER TO CENTER	WIDTH	STEEL THICK.	APPLICATION
 15 - 11792	103-9631	24-3/4" 628.7mm	15/16" 23.8mm			3" 76.2mm	.204" 5.2mm	Mulching Blade PATENTED (3) blades for a 72" cut.
 15 - 6406	1-513876	26" 660.4mm	1/2" 12.7mm			2-1/2" 63.5mm	.204" 5.2mm	Fits Right Hand side of Exmark Explorer 52" cut. Left hand cutting edge Used with our 15-6405 & 15-6407 .
 15 - 6407	1-513875	26" 660.4mm	1/2" 12.7mm			2-1/2" 63.5mm	.204" 5.2mm	Fits Left Hand side of Exmark Explorer 52" cut. Right hand cutting edge Used with our 15-6405 & 15-6406 .

FALLS (SYCAMORE) (K-MART)

 15 - 1074	352400	19-7/8" 504.8mm	3/8" 9.5mm	3/8" x 1-1/2"	3" 76.2mm	1-3/4" 44.5mm	.150" 3.8mm	For 20" push mower
---	--------	---------------------------	----------------------	----------------------	---------------------	-------------------------	-----------------------	--------------------

14/16











BLADES



BLADES

**Blades for
FERRIS**



ORDER NO.	REPLACES O.E.M. NO.	LENGTH	CENTER HOLE DIAM.	OUTSIDE HOLE DIAM.	CENTER TO CENTER	WIDTH	STEEL THICK.	APPLICATION
 15 - 12868	5061827	15" 381mm	5/8" 15.9mm			2-1/2" 63.5mm	.250" 6.35mm	(3) blades for a 44" cut deck. Fits IS500Z units.
 15 - 10172	5020843 1520843	16-1/4" 412.8mm	5/8" 15.8mm			2-1/2" 63.5mm	.204" 5.2mm	Flat Blade Sharpened - 4-sides
 15 - 6296	5020843 1520843	16-1/4" 412.8mm	5/8" 15.8mm			2-1/2" 63.5mm	.204" 5.2mm	Mulching Blade PATENTED
 15 - 9967	5020843 1520843	16-1/4" 412.8mm	5/8" 15.8mm			2" 50.8mm	.240" 6.1mm	Low-Lift Blade Sharpened - 4-sides
 15 - 10173	5021227 1521227	18" 457.2mm	5/8" 15.8mm			2-1/2" 63.5mm	.204" 5.2mm	Flat Blade Sharpened - 4-sides
 15 - 9968	5021227 1521227	18" 457.2mm	5/8" 15.8mm			2" 50.8mm	.240" 6.1mm	Low-Lift Blade Sharpened - 4-sides
 15 - 9987	5020842 1520842	21" 533.4mm	5/8" 15.9mm			2-1/2" 63.5mm	.240" 6.1mm	(3) blades for 61" cut. Fits Mid-Mount "Zero Turn".
 15 - 10174	5020842 1520842	21" 533.4mm	5/8" 15.8mm			2-1/2" 63.5mm	.204" 5.2mm	Flat Blade Sharpened - 4-sides
 15 - 6299	5020842 1520842	21" 533.4mm	5/8" 15.8mm			2-1/2" 63.5mm	.204" 5.2mm	Mulching Blade PATENTED
 15 - 9969	5020842 1520842	21" 533.4mm	5/8" 15.8mm			2" 50.8mm	.240" 6.1mm	Low-Lift Blade Sharpened - 4-sides
 15 - 3329	5022476 22476	25" 381mm	5/8" 15.9mm			2-1/2" 63.5mm	.240" 6.1mm	(3) blades for 74" cut

14/16

BLADES

BLADES





Blades for FLYMO



ORDER NO.	REPLACES O.E.M. NO.	LENGTH	CENTER HOLE DIAM.	OUTSIDE HOLE DIAM.	CENTER TO CENTER	WIDTH	STEEL THICK.	APPLICATION
 15 - 1033	1911	18-1/2" 469.9mm	5/8" 15.8mm	11/32" 8.7mm	1-3/8" 34.9mm	2-1/4" 57.2mm	.150" 3.8mm	



GIANT VAC

 15 - 6278 MIN036	36041	3-7/16" 87.3mm	17/32" 13.5mm			1" 25.4mm	.125" 3.2mm	Giant Vac flail blades. Fits Giant Vac Thatcher models 51GT & 81GT.
 15 - 11646 MIN036	3-7/16" 36041	17/32" 87.3mm	13.5mm			1" 25.4mm	.125" 3.17mm	Fits models 51GT & 81GT (NHT) Minimum 36

GILSON

 15 - 2030	37059	14-19/32" 370.7mm	1-1/8" 28.6mm	25/64" 9.9mm	3-1/4" 82.6mm	2-1/2" 63.5mm	.134" 3.4mm	(3) blades for 42" cut
---	-------	-----------------------------	-------------------------	------------------------	-------------------------	-------------------------	-----------------------	------------------------

GRASSCRAFT

 15 - 6760	GC-1605-91	19" 482.6mm	1-7/16" 36.5mm			2-1/4" 57.2mm	.125" 3.2mm	Fits 19" (Hover Mower)
 27 - 9035 MIN003		4" 101.6mm	31/64" 12.3mm					Steel inserted plastic blade Fits Grasscraft GC1601. (NHT) Minimum 36

14/16









BLADES



BLADES

**Blades for
GRASSHOPPER**



ORDER NO.	REPLACES O.E.M. NO.	LENGTH	CENTER HOLE DIAM.	OUTSIDE HOLE DIAM.	CENTER TO CENTER	WIDTH	STEEL THICK.	APPLICATION
 15 - 3377	320231	15" 381mm	1/2" 12.7mm			2" 50.8mm	.204" 5.2mm	Takes (1) 15-3377 & (2) 15-3379 for 48" cut (3) blades for 44" cut Standard lift
 15 - 6415	320231	15" 381mm	1/2" 12.7mm			2-1/2" 63.5mm	.204" 5.2mm	Mulching Blade PATENTED
 15 - 3378	320232	15" 381mm	1/2" 12.7mm			2" 50.8mm	.204" 5.2mm	Takes (1) 15-3378 & (2) 15-3380 for 48" cut (3) blades for 44" cut High lift
 15 - 6330	320233	15" 381mm	1/2" 12.7mm			2-1/2" 63.5mm	.240" 6.1mm	Takes (1) 15-6330 & (2) 15-6323 for a complete set. Fits 48" deck models 9548, 9548S, 9348, 9348S. Contour blade.
 15 - 11033	320236	18" 457.2mm	1/2" 12.7mm			2-1/2" 63.5mm	.240" 6.1mm	(3) blades for a 52" cut. Standard Lift Blade.
 15 - 3379	320236	18" 457.2mm	1/2" 12.7mm			2" 50.8mm	.204" 5.2mm	Takes (2) 15-3379 & (1) 15-3377 for 48" cut (3) blades for 52" cut Standard lift
 15 - 3380	320237 320239	18" 457.2mm	1/2" 12.7mm			2" 50.8mm	.204" 5.2mm	Takes (2) 15-3380 & (1) 15-3378 for 48" cut. (3) blades for 52" cut High lift
 15 - 6309	320236 320237	18" 457.2mm	1/2" 12.7mm			2-1/2" 63.5mm	.204" 5.2mm	Mulching Blade PATENTED
 15 - 13463	320239	18" 457.2mm	1/2" 12.7mm			2-1/2" 63.5mm	.240" 6.1mm	(3) blades for 52" cut
 15 - 6323	320238	18" 457.2mm	1/2" 12.7mm			2-1/2" 63.5mm	.240" 6.1mm	Takes (2) 15-6323 & (1) 15-6330 for a complete set. Fits 48" deck models 9548, 9548S, 9348, 9348S. Contour blade.
 15 - 10102	320244	21" 533.4mm	1/2" 12.7mm			2-1/2" 63.5mm	.240" 6.1mm	Contour Blade (3) blades for a 61" cut.
 15 - 6167	320242	21" 533.4mm	1/2" 12.7mm			2-1/2" 63.5mm	.240" 6.1mm	(Heavy Duty) (3) blades for 61" cut Standard lift

14/16







BLADES

BLADES







**Blades for
GRASSHOPPER (continued)**



ORDER NO.	REPLACES O.E.M. NO.	LENGTH	CENTER HOLE DIAM.	OUTSIDE HOLE DIAM.	CENTER TO CENTER	WIDTH	STEEL THICK.	APPLICATION
 15 - 3424	320243	21" 533.4mm	1/2" 12.7mm			2" 50.8mm	.204" 5.2mm	(3) blades for 61" cut High lift
 15 - 6168	320243	21" 533.4mm	1/2" 12.7mm			2-1/2" 63.5mm	.240" 6.1mm	(Heavy Duty) (3) blades for 61" cut High lift
 15 - 6401	320242	21" 533.4mm	1/2" 12.7mm			2-1/2" 63.5mm	.240" 6.1mm	(3) blades for 61" cut Med lift.
 15 - 13464	320245	21" 533.4mm	1/2" 12.7mm			2-1/2" 63.5mm	.240" 6.1mm	(3) blades for 61" cut
 15 - 6311	320243 320242	21" 533.4mm	1/2" 12.7mm			2-1/2" 63.5mm	.204" 5.2mm	Mulching Blade PATENTED
 15 - 6402	320250	25" 381mm	1/2" 12.7mm			2-1/2" 63.5mm	.240" 6.1mm	(3) blades for 72" cut Low lift.
 15 - 6403	320251	25" 381mm	1/2" 12.7mm			2-1/2" 63.5mm	.240" 6.1mm	(3) blades for 72" cut High lift.

GRAVELY

 15 - 1065	34984 14668	13-7/8" 352.4mm	5/8" 15.9mm			2" 50.8mm	.204" 5.2mm	(3) blades for 40" cut
 15 - 1066	8861651 88616 111234	17" 431.8mm	5/8" 15.9mm			2" 50.8mm	.204" 5.2mm	(3) blades for 50" cut
 15 - 6214	21285051 212850	17" 431.8mm	5/8" 15.9mm			2-1/2" 63.5mm	.240" 6.1mm	(3) blades for 50" cut "ZERO TURN"
 15 - 6181	8779251 87792 046998	17" 433.4mm	5/8" 15.9mm			2-1/2" 63.5mm	.240" 6.1mm	(3) blades for 50" cut "ZERO TURN" High lift













14/16
BLADES



BLADES

Blades for GRAVELY



ORDER NO.	REPLACES O.E.M. NO.	LENGTH	CENTER HOLE DIAM.	OUTSIDE HOLE DIAM.	CENTER TO CENTER	WIDTH	STEEL THICK.	APPLICATION
 15 - 6204	8866851 52928	17" 431.8mm	5/8" 15.9mm			2-1/2" 63.5mm	.240" 6.1mm	(3) blades for 50" cut Fits Pro 50 & Pro Master 50 Mulching Blade
 15 - 6298	046998	17" 433.4mm	5/8" 15.9mm			2-1/2" 63.5mm	.204" 5.2mm	Mulching Blade PATENTED
 15 - 6013	046998	17" 431.8mm	5/8" 15.8mm			2" 50.8mm	.240" 6.1mm	Low-Lift Blade Sharpened - 4-sides
 15 - 3381	88166 42124	17-11/16" 449.3mm	5/8" 15.9mm			2" 50.8mm	.240" 6.1mm	(2) blades for 36" cut High Lift
 15 - 6203	8866751 52927	17-11/16" 449.3mm	5/8" 15.9mm			2-1/2" 63.5mm	.240" 6.1mm	(2) blades for 36" cut Fits Pro 36 mower Mulching Blade
 15 - 2164	20034751 200347 9212P2	20-1/2" 520.7mm	1" 25.4mm			2-1/4" 57.2mm	.250" 6.4mm	(2) blades for 40" Commercial deck
 15 - 3339	8904651 89046 25124	20-1/2" 520.7mm	5/8" 15.9mm			2" 50.8mm	.240" 6.1mm	(2) blades for 40" cut (3) blades for 60" cut
 15 - 13624	 09081200	20-1/2" 520.7mm	5/8" 15.8mm			2-1/2" 63.5mm	.240" 6.1mm	(3) blades for 60" cut
 15 - 6180	8979651 89796 046999	20-1/2" 520.7mm	5/8" 15.9mm			2-1/2" 63.5mm	.240" 6.1mm	(3) blades for 60" cut
 15 - 6285	8781851 48864	20-1/2" 520.7mm	5/8" 15.9mm			2-1/2" 63.5mm	.240" 6.1mm	(3) blades for 60" cut Fits 60" mower with fabricated deck. Mulching blade
 15 - 6213	52929	20-1/2" 520.7mm	5/8" 15.9mm			2-1/2" 63.5mm	.240" 6.1mm	(3) blades for 60" cut Fits Pro Master 300 & Pro 40, Mulching Blade
 15 - 10175	46999	20-1/2" 520.7mm	5/8" 15.8mm			2-1/2" 63.5mm	.204" 5.2mm	Flat Blade Sharpened - 4-sides

14/16



BLADES

BLADES



Blades for GRAVELY (continued)



ORDER NO.	REPLACES O.E.M. NO.	LENGTH	CENTER HOLE DIAM.	OUTSIDE HOLE DIAM.	CENTER TO CENTER	WIDTH	STEEL THICK.	APPLICATION
 15 - 6303	46999	20-1/2" 520.7mm	5/8" 15.9mm			2-1/2" 63.5	.204" 5.2mm	Mulching Blade PATENTED
 15 - 6194	46999	20-1/2" 520.7mm	5/8" 15.8mm			2" 50.8mm	.240" 6.1mm	Low-Lift Blade Sharpened - 4-sides
 15 - 6171	8983851 89838 047685	24-1/2" 622.3mm	5/8" 15.9mm			2-1/2" 63.5mm	.240" 6.1mm	(3) blades for 72" cut

GREAT DANE

 15 - 3403	D18086	16-1/2" 419.1mm	5/8" 15.8mm				.204" 5.2mm	(3) blades for 48" cut
 15 - 3404	D18037	18" 457.2mm	5/8" 15.8mm				.204" 5.2mm	(3) blades for 52" cut
 15 - 10173	D18037	18" 457.2mm	5/8" 15.8mm			2-1/2" 63.5mm	.204" 5.2mm	Flat Blade Sharpened - 4-sides
 15 - 9968	D18037	18" 457.2mm	5/8" 15.8mm			2" 50.8mm	.240" 6.1mm	Low-Lift Blade Sharpened - 4-sides
 15 - 3434	C-39949	21" 533.4mm	5/8" 15.8mm				.204" 5.2mm	(3) blades for 61" cut
 15 - 10174	C-39949	21" 533.4mm	5/8" 15.8mm			2-1/2" 63.5mm	.204" 5.2mm	Flat Blade Sharpened - 4-sides
 15 - 9969	C-39949	21" 533.4mm	5/8" 15.8mm			2" 50.8mm	.240" 6.1mm	Low-Lift Blade Sharpened - 4-sides

14/16













BLADES



BLADES

**Blades for
HONDA**



ORDER NO.	REPLACES O.E.M. NO.	LENGTH	CENTER HOLE DIAM.	OUTSIDE HOLE DIAM.	CENTER TO CENTER	WIDTH	STEEL THICK.	APPLICATION
 15 - 6131	72513-758-N00 code #3389285	14-9/16" 369.9mm	.630" 16mm			2-3/4" 69.9mm	.187" 4.8mm	(3) blades for 42" cut Fits model 4213
 15 - 50102	72511 VA9-010	16-1/2" 419.10mm	1.09" 27.78mm	.24" x .33"	1.96" 28.18mm	2.25" 57.15mm	.095" 2.77mm	
 15 - 50098	72511 VA5-700	18-3/16" 461.96mm	.831" 21.43mm	.416" 10.71mm	3.45" 87.71mm	2.25" 57.15mm	.150" 3.97mm	
 15 - 50101	72511 VA5-840	18-7/16" 468.31mm	.836" 21.43mm	.564" 14.68mm	3.469" 88.20mm	3.375" 85.73mm	.150" 3.97mm	
 15 - 50113	425-1196004	18-5/8" 473.06mm	.831" 21.43mm	.416" 10.71mm	3.45" 87.71mm	2.25" 57.15mm	.150" 3.97mm	
 15 - 6787	72511-VA5-J00 code # 3451820	18-7/16" 468.3mm	.831" 21.4mm	.416" 10.7mm	3-7/16" 87.7mm	2-1/4" 57.2mm	.150" 3.8mm	Fits 19" walkbehind. Models HR-194 & HR-195.
 15 - 3437	72513-750-305 code #2685113	19-7/16" 493.7mm	.825" 21mm	.413" 10.5mm	3-15/32" 88.1mm	2-1/4" 57.2mm	.150" 3.8mm	High lift (narrow) Left side fit models 3810 K1 and 3813 SA
 15 - 3438	72512-750-305 code #2685105	19-7/16" 493.7mm	.825" 21mm	.413" 10.5mm	3-15/32" 88.1mm	2-3/4" 69.9mm	.160" 4.1mm	High lift (wide) Right side fit models 3810 K1 and 3813 SA
 15 - 6150	72531-758-L00	19-1/2" 495.3mm	.630" 16mm			2-3/4" 69.9mm	.187" 4.8mm	Fits 38" deck models 4514, 4518, 3013 & 4013 takes (1) 15-6150 & (1) 15-6151 Left hand blade
 15 - 6151	72511-758-L00 72511-771-L00	19-1/2" 495.3mm	.630" 16mm			2-3/4" 69.9mm	.187" 4.8mm	Fit models 4514, 4518, 3013 & 4013. Takes (1) 15-6151 & (1) 15-6150 Right hand blade
 15 - 6428	72511-V63-000 72511-VE1-020 code 4513511	20-5/16" 532mm	.804" 20mm	13/32" 10.3mm	3-15/32" 88.1mm	2-1/4" 57.2mm	.134" 3.4mm	Fits 21" walkbehind. Models HRB215, HRM215 High Lift. Lower Blade.
 15 - 50106	72511VB3-B51	20-5/8" 523.88mm	.831" 21.43mm	.416" 10.71mm	3.45" 87.71mm	2.25" 57.2mm	.150" 3.97mm	(Export Only)

14/16

BLADES

BLADES



**Blades for
HONDA (continued)**



ORDER NO.	REPLACES O.E.M. NO.	LENGTH	CENTER HOLE DIAM.	OUTSIDE HOLE DIAM.	CENTER TO CENTER	WIDTH	STEEL THICK.	APPLICATION
 15 - 50160	72511-VB3-E41	20.674" 525.04mm	.844" 21.43mm	.563" 14.28mm	3.469" 88.10mm	2.25" 57.15mm	.160" 4.00mm	
 15 - 10180		20-7/8" 530.2mm	27/32" 21.4mm	.415" 10.5mm	3-7/16" 87.3mm	2-1/4" 57.2mm	.150" 3.8mm	De-Thatcher Plus Fits 21" Honda Uses our 27-94222 line.
 15 - 6458	08750-960-333	20-7/8" 530.2mm	.845" 21.5mm	.415" 10.5mm	3-7/16" 87.3mm	2-1/4" 57.2mm	.160" 4.1mm	Off set blade. Fits 21" cut models.
 15 - 6431	72511-VE2-000 code # 4010609	20-7/8" 530.2mm	.830 27.3mm	13/32" 10.3mm	3-15/32" 88.1mm	2-1/4" 57.2mm	.095" 2.4mm	Lower blade. Use with our 15-6430 upper blade. Fits 21" walkbehind.
 15 - 6092	72511-VA4-641 code #3504230	20-7/8" 530.2mm	.845" 21.5mm	.415" 10.5mm	3-7/16" 87.3mm	2-1/4" 57.2mm	.150" 3.8mm	Fits all Honda 21" cut from 1981-1991, 21" Mulcher
 15 - 2160	72511-VA2-690 72511-960-004 code #2801595	20-7/8" 530.2mm	.845" 21.5mm	.415" 10.5mm	3-7/16" 87.3mm	2-1/4" 57.2mm	.150" 3.8mm	Fits HR 214, HRA 214 and HRA 216
 15 - 50153	72511-VE1-652	20-29/32" 531mm	.780" 19.8mm	.535" 13.6mm	3.60" 91.67mm	4.125" 12.7mm	.095" 2.4mm	Fits 1988-1994 Models HRB535, 536, HRD535, 536, HRG536C, HRH536
 15 - 14657	 72531-VK6-010	21" 533.4mm	1-3/4" 44.5mm	19/32" 15mm		2-5/8" 66.6mm	.134" 3.4mm	Fits 21" model HRC216K2 PDA upper blade. Used with our 15-12615 lower blade.
 15 - 6430	72531-VE2-020 code 4513529	21" 533.4mm	1-17/64 32.1mm	13/32" 10.3mm	3-15/32" 88.1mm	2-5/8" 66.7mm	.095" 2.4mm	Upper blade 15-6428 Lower blade 15-6431 Fits 21" walkbehind.
 15 - 12615	72511-VK6-000	21-1/4" 539.75mm	.804 20mm	.415 10.5mm	3.373 88mm	4-1/4" 108mm	.117" 3.0mm	Fits 21" Honda mower model HRC216K2. lower blade.



14/16

BLADES



**Blades for
HONDA (continued)**



ORDER NO.	REPLACES O.E.M. NO.	LENGTH	CENTER HOLE DIAM.	OUTSIDE HOLE DIAM.	CENTER TO CENTER	WIDTH	STEEL THICK.	APPLICATION
 15 - 6153	72511-763-A00	29-9/16"	.630"	.480"	4-5/16"	2-3/4"	.187"	Fits 30" rider model H3011 & HTR3009-K1. High lift
	72511-772-L00	750.9mm	16mm	12.2mm	109.5mm	69.9mm	4.8mm	
 15 - 2165	72513-751-020 code #2160372	29-3/4" 755.7mm	1.02" 25.9mm	.480" 12.2mm	4-5/16" 109.5mm	2-3/4" 69.9mm	.160" 4.1mm	Fits mid engine rider model HTR 3009.

HUSQVARNA / YAZOO/KEES

 15 - 6093	531-00-50-11 506-67-6501 506-6687-01	11-7/8" 304.9mm	.395" 10mm	.330" 8.4mm	2-3/8" 60.3mm	2" 63.5mm	.150" 3.8mm	(3) for 34" cut Fits Husky model 850-12
 15 - 6466	506-6687-01 506-67-6501 531-00-50-11	11-7/8" 304.9mm	.395" 10mm	.330" 8.4mm	2-3/8" 60.3mm	2-1/2" 63.5mm	.187" 4.8mm	Mulching Blade PATENTED
 15 - 50111	5067515-01	13-3/4" 349.25mm	.403" 10.31mm	.331" 8.73mm	2.375" 60.33mm	2.00" 50.80mm	.150" 3.97mm	(Export Only)
 15 - 13333	505544501	14-1/8" 358.8mm	3/8" 9.5mm			2" 50.8mm	.160" 4.06mm	Mulching Blade.
 15 - 50293	 505544601	14-1/8" 359mm	.472" 12mm			2.36" 60mm	.160" 4.06mm	Mulching Blade PATENTED (Export Only)
 15 - 12122	539-112078	14-5/8" 371.5mm	5 point star			2-1/2" 63.5mm	.204" 5.2mm	EZ-Series 4216 & 4217 models (3) blades for a 42" cut.
 15 - 7010	539-1032-74	14-7/8" 377.8mm	5/8" 15.8mm			2-1/2" 63.5mm	.204" 6.2mm	(3) blades for 42" cut. Fits Husqvarna, Yazoo/Kees commercial mowers.
 15 - 13334	504188201	15-1/4" 387.4mm	3/8" 9.5mm			2" 50.8mm	.160" 4.06mm	Mulching Blade.
 15 - 50292	 504190401	15-5/16" 390mm	.472" 12mm			2.36" 60mm	.160" 4.06mm	Mulching Blade PATENTED (Export Only)

14/16















BLADES

BLADES



**Blades for
HUSQVARNA / YAZOO/KEES (continued)**



ORDER NO.	REPLACES O.E.M. NO.	LENGTH	CENTER HOLE DIAM.	OUTSIDE HOLE DIAM.	CENTER TO CENTER	WIDTH	STEEL THICK.	APPLICATION
 15 - 6489	506-96-63-01	16-3/16" 411.2mm	.972" 24.69mm	.323" 8.2mm	1.899" 48.23mm	2" 50.8mm	.150" 3.8mm	
 15 - 1009	17036 76675	16-1/4" 412.8mm	5/8" 15.9mm	1/4" 6.4mm	1-5/8" 41.3mm	2-1/2" 63.5mm	.150" 3.8mm	(2) blades for 32" cut (3) blades for 48" cut
 15 - 6500	539-100-340	16-1/4" 412.8mm	5/8" 15.8mm			2-1/2" 63.5mm	.204" 5.2mm	(3) blades for 48" cut. Fits Husqvarna, Yazoo, Kees, commercial mowers.
 15 - 2172	17036 77378	16-1/4" 412.8mm	5/8" 15.9mm	11/32" 8.7mm	1-5/8" 41.3mm	2-1/2" 63.5mm	.240" 6.1mm	(Heavy Duty) (2) blades for 32" cut (3) blades for 48" cut
 15 - 10172	483011	16-1/4" 412.8mm	5/8" 15.8mm			2-1/2" 63.5mm	.204" 5.2mm	Flat Blade Sharpened - 4-sides
 15 - 6296	483011 76675 77378	16-1/4" 412.8mm	5/8" 15.8mm			2-1/2" 63.5mm	.204" 5.2mm	Mulching Blade PATENTED
 15 - 9967	483011	16-1/4" 412.8mm	5/8" 15.8mm			2" 50.8mm	.240" 6.1mm	Low-Lift Blade Sharpened - 4-sides
 15 - 12123	539-113425	16-1/4" 412.8mm	5 point star			2-1/2" 63.5mm	.204" 5.2mm	EZ-Series 4819 model (3) blades for a 48" cut.
 15 - 13335	504188101	16-1/2" 419.1mm	3/8" 9.5mm			2" 50.8mm	.160" 4.06mm	Mulching Blade.
 15 - 6300	17043	16-1/2" 419.7mm	5/8" 15.9mm			2-1/2" 63.5mm	.204" 5.2mm	Mulching Blade PATENTED
 15 - 50297	 544102701	16-1/2" 420mm	.472" 12mm			2.36" 60mm	.160" 4.06mm	Mulching Blade PATENTED (Export Only)
 15 - 50290	 522449503	17" 430mm	.472" 12mm			2.36" 60mm	.134" 3.4mm	Mulching Blade PATENTED (Export Only)

14/16















BLADES



BLADES

**Blades for
HUSQVARNA / YAZOO/KEES (continued)**



ORDER NO.	REPLACES O.E.M. NO.	LENGTH	CENTER HOLE DIAM.	OUTSIDE HOLE DIAM.	CENTER TO CENTER	WIDTH	STEEL THICK.	APPLICATION
 15 - 50141	506-88-52	17-1/4" 438.1mm	.405" 10.2mm			2.345" 59.5mm	.204" 5.2mm	(2) blades for 36" cut
 15 - 13367	574870801	17-3/4" 450.8mm	5 point star			2-1/2" 63.5mm	.204" 5.18mm	Mulching Blade Patented. (3) 52" cu
 15 - 13361	574870801	17-3/4" 450.8mm	5 point star			2-1/2" 63.5mm	.204" 5.18mm	(3) 52" cut
 15 - 50287	 535429401	17-7/8" 431.8mm	1/2" 12.7mm			2.36" 60mm	.204" 5.2mm	Mulching Blade (Export Only)
 15 - 50289	 531211017	18" 457.2mm	.68" 17.3mm			2.25" 57.2mm	.125" 3.2mm	Mulching Blade PATENTED (Export Only)
 15 - 1010	17037 363055	18" 457.2mm	5/8" 15.9mm	1/4" 6.4mm	1-5/8" 41.3mm	2-1/2" 63.5mm	.150" 3.8mm	(2) blades for 36" cut
 15 - 2173	17037 77344	18" 457.2mm	5/8" 15.9mm			2-1/2" 63.5mm	.240" 6.1mm	(Heavy Duty) (2) blades for 36" cut (3) blades for 54" cut.
 15 - 10173	77344	18" 457.2mm	5/8" 15.8mm			2-1/2" 63.5mm	.204" 5.2mm	Flat Blade Sharpened - 4-sides
 15 - 6294	77344 363055 76450	18" 457.2mm	5/8" 15.9mm			2-1/2" 63.5mm	.204" 5.2mm	Mulching Blade PATENTED
 15 - 9968	77344	18" 457.2mm	5/8" 15.8mm			2" 50.8mm	.240" 6.1mm	Low-Lift Blade Sharpened - 4-sides
 15 - 12124	539-112079	18" 457.2mm	5 point star			2-1/2" 63.5mm	.204" 5.2mm	EZ_Series 5221 Model (3) blades for a 52" cut.
 15 - 50031	516400500	18-5/8" 473.1mm	.403" 10.2mm	.337" 8.5mm	2.56" 65.02mm	2.50" 63.5mm	.134" 3.4mm	(Export Only)

14/16













BLADES

BLADES



**Blades for
HUSQVARNA / YAZOO/KEES (continued)**



ORDER NO.	REPLACES O.E.M. NO.	LENGTH	CENTER HOLE DIAM.	OUTSIDE HOLE DIAM.	CENTER TO CENTER	WIDTH	STEEL THICK.	APPLICATION
 15 - 14391	 521981501	18" 457.2mm	5 point star			2.50" 63.5mm	.204" 5.2mm	Mulching Blade PATENTED (3) blades for 54" cut
 15 - 6488	506-96-97-01	18-15/16" 481mm	.950" 24mm	.322" 8.3mm	1.899" 48.2mm	2" 50.8mm	.150" 3.8mm	
 15 - 13498	532427984	19" 482.6mm	5 point star			2-1/4" 57.2mm	.150" 3.8mm	LH Blade. Fits 38" Center rear discharge models CTH2038, CTH2238 CT 151/131.
 15 - 13500	532427985	19" 482.6mm	5 point star			2-1/4" 57.2mm	.150" 3.8mm	RH Blade. Fits 38" Center rear discharge models CTH2038, CTH2238 CT 151/131.
 15 - 14076	575265901	19" 482.6mm	5/8" 15.8mm			2-1/2" 63.5mm	.240" 6.1mm	Hi-Lift Blade (3) blades for 54" cut Fits PZ series, Zero Turn Riders.
 15 - 14077	574481101	19" 482.6mm	5/8" 15.8mm			2-1/2" 63.5mm	.240" 6.1mm	Low-Lift Blade (3) blades for 54" cut Fits PZ series, Zero Turn Riders.
 15 - 14078	525525901	19" 482.6mm	5/8" 15.8mm			2-1/2" 63.5mm	.240" 6.1mm	Mulching Blade (3) blades for 54" cut Fits PZ series, Zero Turn Riders.
 15 - 50294	 544175701	19-1/8" 482mm	.472" 12mm			2.36" 60mm	.240" 6.1mm	Mulching Blade (Export Only)
 15 - 6299	539-10-1733	21" 533.4mm	5/8"			2-1/2" 63.5mm	.204" 5.2mm	Commercial Mulching Blade
 15 - 10720	539-10-17-33	21" 533.4mm	5/8" 15.9mm			2-1/2" 63.5mm	.204" 5.2mm	(3) blades for a 61" cut.
 15 - 12125	539-113312	21" 533.4mm	5 point star			2-1/2" 63.5mm	.204" 5.2mm	EZ-Series, 6124 model (3) blades for a 61" cut.

14/16





BLADES



BLADES

**Blades for
HUSQVARNA / YAZOO/KEES (continued)**



ORDER NO.	REPLACES O.E.M. NO.	LENGTH	CENTER HOLE DIAM.	OUTSIDE HOLE DIAM.	CENTER TO CENTER	WIDTH	STEEL THICK.	APPLICATION
 15 - 14392	 521981601	21" 533.4mm	5 point star			2.50" 63.5mm	.204" 5.2mm	Mulching Blade PATENTED (3) blades for 61" cut
 15 - 50291	 544175801	22-3/16" 558.8mm	.489" 12.4mm			2.362" 60mm	.240" 6.1mm	Mulching Blade (Export Only)

HUSTLER

 15 - 9173	712224	4-11/16" 119.1mm	29/64" 11.5mm			1-1/4" 31.8mm	.095" 2.4mm	Takes 8 blades per unit. Shredder blade Used on 251K.
 15 - 9172	716886	6-7/16" 163.5mm	29/64" 11.5mm			1-1/4" 31.8mm	.095" 2.4mm	Takes 8 blades per unit. Shredder blade Used on 260K
 15 - 11870	794206	13-3/4" 349.3mm	5/8" 15.8mm			2-1/2" 63.5mm	.204" 5.2mm	Fits Mini Fastrak 36" side mulching. Used with our 15-6290 .
 15 - 11810	793802	13-3/4" 349.3mm	5/8" 15.8mm			2-1/2" 63.5mm	.204" 5.2mm	Fits 36" Hustler Mini Z & TrimStar. Used with our 15-10249 .
 15 - 10371	784256	15-5/8" 238.1mm	5/8" 15.8mm			2-1/2" 63.5mm	.204" 5.2mm	(3) blades for 44" cut. Fits models Hustler Z, Super Z & Short Cut.
 15 - 10973	785428	15-5/8" 396.9mm	5/8" 15.8mm			2-1/2" 63.5mm	.204" 5.2mm	Mulching Blade.
 15 - 6300	Bunton, Bad Boy John Deere Lesco, Scag Snapper	16-1/2" 419.1mm	5/8" 15.8mm			2-1/2" 63.5mm	.204" 5.2mm	Commercial Mulching Blade
 15 - 6436	767111	16-31/32" 431mm	1/2" 12.7mm			2-1/2" 63.5mm	.204" 5.2mm	(3) blades for 48" cut. Fits 48" cut Excel short cut.
 15 - 10972	782532 785436	17-7/8" 454mm	5/8" 15.8mm			3" 76.2mm	.204" 5.2mm	Mulching Blade.

14/16













BLADES

BLADES



**Blades for
HUSTLER (continued)**



ORDER NO.	REPLACES O.E.M. NO.	LENGTH	CENTER HOLE DIAM.	OUTSIDE HOLE DIAM.	CENTER TO CENTER	WIDTH	STEEL THICK.	APPLICATION
 15 - 11557	795526	17-7/8" 454mm	5/8" 15.8mm			2-1/2" 63.5mm	.204" 5.2mm	(3) blades for a 52" cut. Fits Super Z. High Lift.
 15 - 11556	785436	17-7/8" 454mm	5/8" 15.8mm			2-1/2" 63.5mm	.204" 5.2mm	Mulching Blade PATENTED (3) blades for a 52" cut. Fits Super Z.
 15 - 10372	781898	17-7/8" 454.4mm	5/8" 15.8mm			3" 76.2mm	.240" 6.1mm	(3) blades for 52" cut. Fits models Hustler Z, Super Z & Short Cut.
 15 - 11856	797696	18-1/2" 401.3mm	5/8" 15.8mm			2-1/2" 63.5mm	.204" 5.2mm	Fits Z & Super Z 54 XR-7 side discharge (3) blades for a 54" cut.
 15 - 13623	797704	18-1/2" 401.3mm	5/8" 15.8mm			2-1/2" 63.5mm	.204" 5.2mm	Mulching Blade (3) blades for 54" cut
 15 - 12733	797704	18-1/2" 469.9mm	5/8" 15.9mm			2-1/2" 63.5mm	.204" 5.2mm	Mulching Blade. PATENTED (3) blades for a 54" cut.
 15 - 6435	770339	19" 482.6mm	1/2" 12.7mm			2-1/2" 63.5mm	.204" 5.2mm	(3) blades for 54" cut. Fits 54" cut Excel short cut.
 15 - 6180	794-685	20-1/2" 520.7mm	5/8" 15.9mm			2-1/2" 63.5mm	.240" 6.1mm	(3) blades for 60" cut. (2) 42: cut
 15 - 50106	72511VB3-B51	20-5/8" 523.88mm	.831" 21.43mm	.416" 10.71mm	3.45" 87.71mm	2.25" 57.2mm	.150" 3.97mm	(Export Only)
 15 - 10971	782557	21" 533.4mm	5/8" 15.8mm			3" 76.2mm	.204" 5.2mm	Mulching Blade.
 15 - 10373	782516	21" 533.4mm	5/8" 15.8mm			3" 76.2mm	.240" 6.1mm	"Does not fit RX7 decks". (3) blades for 60" cut. Fits models Hustler Z, Super Z & Short Cut.
 15 - 6441	602771	20-1/2" 520.7mm	5/8" 15.9mm			3" 76.2mm	.240" 6.1mm	(3) blades for 60" cut. High Lift.

14/16
BLADES



BLADES

Blades for HUSTLER (continued)







ORDER NO.	REPLACES O.E.M. NO.	LENGTH	CENTER HOLE DIAM.	OUTSIDE HOLE DIAM.	CENTER TO CENTER	WIDTH	STEEL THICK.	APPLICATION
 15 - 11721	798496	22-1/2" 571.5mm	5/8" 15.8mm			3" 76.2mm	.204" 5.2mm	(3) blades for a 66" cut.
 15 - 6628	754879	23-7/8" 606.4mm	1/2" 12.7mm			2-3/4" 69.9mm	.240" 6.1mm	Fits 72" heavy duty dual trim deck takes (2) 15-6628 & (1) 15-6728 . Also fits Range Wing mowers takes (4) 15-6628 & (3) 15-6728 .
 15 - 6728	754853	23-7/8" 606.4mm	1/2" 12.7mm			2-3/4" 69.9mm	.240" 6.1mm	Fits models 2500, 72" deck 275, 285, 295, 305, 320, 340, 400, 3000, 3200, 3400, 4100, 4200, 4300, 4400, 4420, 4500 & 4600 units with 72" "Three way deck" or "Quad Cycler" deck
 15 - 10797	783977	24" 609.6mm	5/8" 15.9mm			3" 76.2mm	.240" 6.1mm	(3) blades for a 72" cut. Fits Super Z.
 15 - 10421	798710 103-158	24-1/2" 622.3mm	5/8" 15.9mm			3" 76.2mm	.204" 5.2mm	(3)blade for 72" cut Solid Air Foil Hi-Lift.

INTERNATIONAL

 15 - 6078	759-3853 547-191-R1	21-1/4" 539.8mm	3/8" 9.5mm	17/32" 5.6mm	4-1/2" 114.3mm	2-1/2" 63.5mm	.204" 5.2mm	
---	------------------------	---------------------------	----------------------	------------------------	--------------------------	-------------------------	-----------------------	--

ISEKI

 15 - 50062	FM-041-40	410 mm 410 mm	.79" 20.24mm			2.25" 57.15mm	.187" 4.76mm	
 15 - 50063	8595-306-06-10-0	16-27/32" 427.8 mm	.554" 14.29mm			2.0" 50.80mm	.150" 3.97mm	
 15 - 11312	2500-220-0001-00	20-5/8" 523.9mm	.985" 25mm	.530" 13.5mm	3-1/2" 88.9mm	2-1/4" 57.2mm	.160" 4.1mm	
 15 - 13593	3495550M4	24-3/4" 628.7mm	.792" 20mm			2-1/2" 63.5mm	.295" 7.5mm	Fits SF300,330, 303, 333 & TM217 Tractors W/SSM 72 Deck 1999 - up. (3) Blades for a 72" cut

14/16



BLADES

BLADES









**Blades for
JACOBSEN**



ORDER NO.	REPLACES O.E.M. NO.	LENGTH	CENTER HOLE DIAM.	OUTSIDE HOLE DIAM.	CENTER TO CENTER	WIDTH	STEEL THICK.	APPLICATION
 15 - 3346	500904 330721	14-7/8" 377.8mm	7/16" 11.1mm	1/2" 12.7mm	1-5/8" 41.3mm	2" 50.8mm	.150" 3.8mm	(3) blades for 42" cut
 15 - 1058	326484 330719	20" 508mm	7/16" 11.1mm	15/32" 11.9mm	1-5/8" 41.3mm	2" 50.8mm	.187" 4.8mm	

JOHN DEERE

 15 - 1126	AM100991 M41237 AM30698	14" 355.6mm	11/16" 17.5mm			2" 50.8mm	.187" 4.8mm	(3) blades for 38" cut Model 200 series
 15 - 6193	M115759	14-1/16" 357.2mm	11/16" 17.5mm			2-1/2" 63.5mm	.204" 5.2mm	(3) blades for 38" cut shallow deck
 15 - 1127	M127466 M41967 AM31100	16" 406.4mm	11/16" 17.5mm			2" 50.8mm	.187" 4.8mm	(3) blades for 48" cut Model 300
 15 - 6496	AM31100 M41967	16" 406.4mm	11/16" 17.5mm			2 1/2" 63.5mm	.187" 4.8mm	Mulching Blade PATENTED
 15 - 6222	AM104489	16-1/2" 419.1mm	5/8" 15.9mm			2-1/2" 63.5mm	.204" 5.2mm	(3) blades for 48" cut
 15 - 6300	AM104489	16-1/2" 419.1mm	5/8" 15.9mm			2-1/2" 63.5mm	.204" 5.2mm	Mulching Blade PATENTED

14/16











BLADES



BLADES

**Blades for
JOHN DEERE (continued)**



ORDER NO.	REPLACES O.E.M. NO.	LENGTH	CENTER HOLE DIAM.	OUTSIDE HOLE DIAM.	CENTER TO CENTER	WIDTH	STEEL THICK.	APPLICATION
 15 - 6206	M115495	16-5/8" 422.3mm	13/16" 20.6mm			2-1/2" 63.5mm	.204" 5.2mm	(3) blades for 48" cut
 15 - 6223	M113517	16-5/8" 422.3mm	13/16" 20.6mm			2-1/2" 63.5mm	.204" 5.2mm	(3) blades for 48" cut Fits model F 710 Mulching Blade
 15 - 6420	M113517	16-5/8" 422.3mm	13/16" 20.6mm			2-1/2" 63.5mm	.204" 5.2mm	Mulching Blade PATENTED
 15 - 6314	M115495	16-5/8" 422.3mm	13/16" 20.6mm			2-1/2" 63.5mm	.204" 5.2mm	Mulching Blade PATENTED
 15 - 10634	GX20250	17" 431.8mm	.675" 17.1mm			2-1/2" 63.5mm	.150" 3.8mm	Fits L120 & L130 series riders. (3) Blades for 48" cut.
 15 - 12920	GX20250	17" 431.8mm	.675" 17.1mm			2-1/2" 63.5mm	.160" 4.0mm	Mulching Blade (3) Blades for 48" cut PATENTED
 15 - 10291	M127500 M145476	17" 431.8mm	.800" 20.6mm			2-1/2" 63.5mm	.204" 5.2mm	Fits 48C decks. Since 1999. (3) blades per unit 48" cut.
 15 - 12821	M127673 M145476 M127500	17" 431.8mm	.800" 20.3mm			2-1/2" 76.2mm	.204" 5.2mm	Mulching Blade. PATENTED. (3) blades for a 48" cut.
 15 - 10284	M136194 TCU14939	17" 431.8mm	.904" 23mm			2-1/2" 63.5mm	.240" 6.1mm	Fits 7-Iron decks. (3) blades for a 48" cut.
 15 - 11595	GX21784 GY20852	17" 431.8mm	7 point star			2-3/4" 69.8mm	.160" 4.0mm	3 in 1 blade. (3) blades for a 48" cut. Fits model 145, 155C riders.
 15 - 11596	GX21784	17" 431.8mm	7 point star			2-3/4" 69.8mm	.160" 4.0mm	Commercial Mulcher 3 in 1 blade. (3) blades for a 48" cut. Fits model 145, 155C riders.
 15 - 6012	M86209 AM39966	17-3/16" 436.6mm	11/16" 17.5mm			2-1/2" 63.5mm	.204" 5.2mm	(3) blades for 50" cut (Old No. 3383)

14/16













BLADES

BLADES



**Blades for
JOHN DEERE (continued)**



ORDER NO.	REPLACES O.E.M. NO.	LENGTH	CENTER HOLE DIAM.	OUTSIDE HOLE DIAM.	CENTER TO CENTER	WIDTH	STEEL THICK.	APPLICATION
 15 - 6294	PT8721	18" 457.2mm	5/8" 15.9mm			2-1/2" 63.5mm	.204" 5.2mm	Mulching Blade PATENTED
 15 - 6192	M115496	18-5/8" 473.1mm	13/16" 20.6mm			2-1/2" 63.5mm	.204" 5.2mm	(3) blades for 54" cut
 15 - 6221	M113518	18-5/8" 473.1mm	13/16" 20.6mm			2-1/2" 63.5mm	.204" 5.2mm	(3) blades for 54" cut Fits model F-725 Mulching Blade
 15 - 6315	M115496	18-5/8" 473.1mm	13/16" 20.6mm			2-1/2" 63.5mm	.204" 5.2mm	Mulching Blade PATENTED
 15 - 11491	GX21380 GY20684	18-5/8" 473.1mm	7 point star			2-3/4" 69.8mm	.187" 4.8mm	(3) blades for a 54" cut. Fits G110 series riders.
 15 - 6738	M122455	18-11/16" 474.3mm	1"x1-1/8"			2-1/2" 63.5mm	.204" 5.2mm	(2) blades for 36" cut Fits midsize commercial mowers, models GS25, 36
 15 - 10292	M143520	18-7/8" 479mm	.800" 20.6mm			2-3/4" 69.9mm	.204" 5.2mm	(3) blades for a 54" cut.
 15 - 14475	 M144516	19" 482.6mm	.800" 20.3mm			2-1/2" 63.5mm	.240" 6.1mm	Mulching Blade PATENTED (3) blades for 54" cut
 15 - 6480	M136195	19" 482.6mm	.904" 23mm			2-1/2" 63.5mm	.240" 6.1mm	(3) blades for 54" cut. Fits the 7-Iron Deck.
 15 - 10072	M136195	19" 482.6mm	.904" 23mm			2-1/2" 63.5mm	.240" 6.1mm	(3) blades for 54" cut Mulching Blade PATENTED
 15 - 6011	AM100946 M82408	19-1/2" 495.3mm	11/16" 17.5mm			2-1/2" 63.5mm	.204" 5.2mm	(2) blades for 38" cut for riders.
 15 - 6737	M84472	19-1/2" 495.3mm	11/16" 17.5mm			3" 76.2mm	.204" 5.2mm	(2) blades for 38" cut Fits models SX38.













BLADES 14/16



BLADES

**Blades for
JOHN DEERE (continued)**



ORDER NO.	REPLACES O.E.M. NO.	LENGTH	CENTER HOLE DIAM.	OUTSIDE HOLE DIAM.	CENTER TO CENTER	WIDTH	STEEL THICK.	APPLICATION
 15 - 845	M83459	19-1/2" 495.3mm	11/16" 17.5mm			3" 76.2mm	.204" 5.2mm	(2) blades for 38" cut Fits model SX-38 High Lift
 15 - 6186	M112991	19-1/2" 495.3mm	11/16" 17.5mm			2-1/2" 63.5mm	.204" 5.2mm	(2) blades for 38" cut Mulching Blade
 15 - 6421	M112991	19-1/2" 495.3mm	11/16" 17.5mm			2-1/2" 63.5mm	.204" 5.2mm	Mulching Blade PATENTED
 15 - 12562	M153118	19-1/2" 495.3mm	7 point star			3" 76.2mm	.204" 5.2mm	Hi-Lift Blade (2) blades for a 38" cut.
 15 - 2120	M112847 M48452 AM35557	20-1/2" 520.7mm	25/32" 19.8mm			2" 50.8mm	.187" 4.8mm	(3) blades for 60" cut Model 400 & WH-D-250
 15 - 6253	M87622 M141785	20-1/2" 520.7mm	29/32" 23mm			2-1/2" 63.5mm	.313" 8mm	(3) blades for 60" cut
 15 - 3348	PT6921	20-3/4" 527.1mm	3/8" 9.5mm			2-1/4" 57.2mm	.150" 3.8mm	For 21" walk behind
 15 - 10458	GC00344	21" 533.4mm	3/8" 9.5mm	.480" 12.3mm	2" 50.8mm	2-3/4" 69.9mm	.125" 3.2mm	Mulching Blade Fit 21" steel decks. Walkbehind mowers.
 15 - 10635	GX20249	21-27/64" 544.1mm	.675" 17.1mm	13/32" 10.3mm		2-1/2" 63.5mm	.160" 4.0mm	Fits L100 & L110 series riders. (2) Blades for 42"cut. Also fits Sabre and Scotts mowers.
 15 - 6479	M128485	21" 533.4mm	29/32" 23mm			2-1/2" 63.5mm	.313" 8mm	(3) blades for 60" cut. Fits the 7-Iron Deck.
 15 - 10073	M128485	21" 533.4mm	.908" 23mm			2-1/2" 63.5mm	.240" 6.1mm	TCU15881, High Lift Blade M133381, Low Lift Mulching Blade PATENTED
 15 - 6122	M112738 M125413 M112972	21" 533.4mm	.904" 23mm	.411" 10.4mm	3-11/16" 93.7mm	2-3/4" 29.9mm	.134" 3.4mm	21" mulching blade for Models GX14SB & GX14SBE

14/16

BLADES

BLADES



Blades for JOHN DEERE (continued)



ORDER NO.	REPLACES O.E.M. NO.	LENGTH	CENTER HOLE DIAM.	OUTSIDE HOLE DIAM.	CENTER TO CENTER	WIDTH	STEEL THICK.	APPLICATION
 15 - 11593	GX22151	21-3/8" 542.9mm	7 point star			2-3/4" 69.8mm	.155" 3.9mm	3 in 1 blade. (2) blades for a 42" cut. Fits 102,115,125,135 riders.
 15 - 11594	GX22151	21-3/8" 542.9mm	7 point star			2-3/4" 69.8mm	.160" 4.0mm	Commercial Mulcher 3 in 1 blade. (2) blades for a 42" cut. Fits 102,115,125,135 riders.
 15 - 12380	M154061	21-3/8" 542.9mm	7 point star			2-3/4" 69.8mm	.204" 5.2mm	Heavy Duty Blade. Fits models 102, 115, 125 & 135. 42" Riders (2) blades for a 42" cut.
 15 - 10074	M148613 M139976	21-3/8" 542.9mm	13/16" 20.6mm			2-1/2" 63.5mm	.203" 5.2mm	(2) blade for 42" cut model GT225 (3) blades for 60" cut. Fits new style decks from 1999.
 15 - 12919	GX20249	21-27/64" 544.1mm	.675" 17.1mm	13/32" 10.3mm		2-1/2" 63.5mm	.160" 4.0mm	Mulching Blade Patented (2) Blades for 42" cut
 15 - 9959	M139802	21-15/32" 545.3mm	11/16" 17.5mm			2-1/2" 63.5mm	.160" 4.1mm	(2) blades for 42" cut. Mulching Blade. Fits Scott Yard Tractor.
 15 - 6252	M83363 AM102401	24-15/16" 612.4mm	29/32" 23mm			2-1/2" 63.5mm	.313" 8mm	(3) blades for 72" cut 9/16" Lift
 15 - 6255	M141786 M80783	24-15/16" 612.4mm	29/32" 23mm			2-1/2" 63.5mm	.313" 8mm	(3) blades for 72" cut 1" Lift
 15 - 12643	TCU15882	25" 635mm	.900 22.8mm			3" 76.2mm	.250" 6.35mm	Hi-Lift Blade
 15 - 6327	M89455 AM101539	29-1/2" 749.3mm	11/16" 17.5mm			2-1/2" 63.5mm	.204" 5.2mm	For 30" deck mowers with grass catcher. High lift.
 15 - 6328	M89454 AM101538	29-1/2" 749.3mm	11/16" 17.5mm			2-1/2" 63.5mm	.204" 5.2mm	For 30" deck mowers. Regular lift.
 15 - 6329	M118958	29-1/2" 749.3mm	11/16" 17.5mm			2-1/2" 63.5mm	.204" 5.2mm	For 30" deck mowers. Mulching blade.



14/16
BLADES



BLADES



**Blades for
KAAZ**







ORDER NO.	REPLACES O.E.M. NO.	LENGTH	CENTER HOLE DIAM.	OUTSIDE HOLE DIAM.	CENTER TO CENTER	WIDTH	STEEL THICK.	APPLICATION
 15 - 11314	91014-165	18-3/8" 466.7mm	.830" 21mm	.450" 11.5mm	3-1/2 88.9mm	2-1/4" 57.2mm	.160" 4.1mm	
 15 - 12118	91014-159	20-5/8" 523.9mm	.830" 21mm	.435" 11mm	3-1/2 88.9mm	2-1/4" 57.2mm	.160" 4.1mm	High Lift Blade

KEE (TRIAL MATE) (SEE TRIALMATE)

KLIPPO

 15 - 50148	60-00-4	18-7/8" 475.45mm	35/64" 13.89mm			2-1/4" 2.25mm	.150" 3.8mm	
 15 - 10376	90-805R	20-11/16" 525.5mm	.565" 14.3mm			2-1/2" 63.5mm	.150" 3.8mm	Fits models older than 2004 G7 21", Comet, Pro S, Pro S OHV & Pro SHD.
 15 - 50147	60-04-4	20-7/8" 530.22mm	9/16" 13.89mm			2-1/4" 57.15mm	.150" 3.8mm	

KUBOTA

 15 - 3386	70712-34330	15-5/16" 388.9mm	11/16" 17.5mm	.338" 8.6mm	1-1/2" 38.1mm	2" 50.8mm	.204" 5.2mm	(3) blades for 44" cut Model RC44-G
 15 - 14096	 K5576-34350	16-1/2" 419.1mm	.890" 22.6mm			2-1/2" 63.5mm	.250" 6.4mm	Fits model H30T, series GR, ZG200, ZD200. (3) blades for 48" cut
 15 - 3387	70721-34330	16-5/8" 422.3mm	11/16" 17.5mm	.338" 8.6mm	1-1/2" 38.1mm	2" 50.8mm	.204" 5.2mm	(3) blades for 48" cut Model MR4800
 15 - 6208	76500-34330	16-5/8" 422.3mm	.719" 18.26mm			2" 50.8mm	.204" 5.2mm	(3) blades for 48" cut Fits models RC62, 72 & 82 Deck #RC48-62H, RC48-62A/F & RC48G

14/16















BLADES

BLADES



BLADES FOR KUBOTA (continued)



ORDER NO.	REPLACES O.E.M. NO.	LENGTH	CENTER HOLE DIAM.	OUTSIDE HOLE DIAM.	CENTER TO CENTER	WIDTH	STEEL THICK.	APPLICATION
 15 - 14488	 K5619-34350	18-5/8" 457.2mm	.890" 22.6mm			2-1/2" 63.5mm	.250" 6.4mm	Fits model H30T, series ZG & ZD models. K446 (3) blades for 54" cut.
 15 - 14483	 K5351-34342	18-5/8" 457.2mm	.890" 22.6mm			2-1/2" 63.5mm	.250" 6.4mm	K424 (3) blades for 54" cut
 15 - 14095	 K5617-34330	18-5/8" 457.2mm	.715" 18.1mm			2-1/2" 63.5mm	.250" 6.4mm	Fits model H30T, series 2G127,ZG23,GR2100/2110 BX-RCK54P models. K327 (3) blades for 54" cut.
 15 - 6265	76529-34330	18-11/16" 474.7mm	1-1/8" 28.6mm			2-1/2" 63.5mm	.240" 6.1mm	(3) blades for 54" cut. rider mowers. Fits G1800, 1900 & 2000 models.
 15 - 3388	70722-34330	20-7/16" 519.1mm	11/16" 17.5mm			2" 50.8mm	.204" 5.2mm	(3) blades for 60" cut Models MR6000, RCB60- 1/E/AE, RC60-71H, RC60- 72/A, RC60-27
 15 - 3389	76540-34330	20-15/32" 519.9mm	15/16" 23.8mm			2-1/4" 57.2mm	.240" 6.1mm	For models RC60-20, RC60-F20, RC60-25
 15 - 6209	K5647-3433 76539-34330 K5649-3434	20-1/2" 520.7mm	1-1/8" 28.6mm			2-1/2" 63.5mm	.240" 6.1mm	(3) blades for 60" cut. Fits tractor models B2150, B1750, B7100HSD, B1550, FZ2100, FZ2400, G1900 & G2000 with deck models:RC60-21B, RC60 -71B, 60B, 60F221 & 60GO
 15 - 11558	76539-34330	20-1/2" 520.7mm	1-1/8" 28.6mm			2-1/2" 63.5mm	.240" 6.1mm	Fits models B2150, B1750 B7100HSD, B1550, FZ2100, FZ2400, G1900, G2000. (3) blades for a 60" cut. Commercial Mulcher
 15 - 14481	 K5371-34340	20-1/2" 520.7mm	.890" 22.6mm			2-1/2" 63.5mm	.250" 6.4mm	K472 (3) blades for 60" cut
 15 - 14482	 K5112-71940	20-1/2" 520.7mm	.715" 18.2mm			2-1/2" 63.5mm	.250" 6.4mm	K132 (3) blades for 60" cut
 15 - 6173	65621-37-212	20-11/16" 525.5mm	3/4" 19.1mm	9/16" 14.3mm	3-17/32" 89.7mm	2-1/4" 57.2mm	.150" 3.8mm	Fits 5 hp 21" self- propelled Walk behind, elec. start Model W50021SCE

14/16



BLADES



BLADES

**Blades for
KUBOTA (continued)**





ORDER NO.	SUGG. LIST	CODE	REPLACES O.E.M. NO.	LENGTH	CENTER HOLE DIAM.	OUTSIDE HOLE DIAM.	CENTER TO CENTER	WIDTH	STEEL THICK.	APPLICATION
	15 - 12995		 K5677-34340	24-7/16" 609.6mm	1-1/8" 25.4mm			2-1/2" 63.5mm	.240" 6.1mm	Fits model H30T, series ZD28, ZD326, ZD331 ZTR RCK72P-28Z models. K462 (3) blades for 72" cut.
	15 - 6207		76550-34330	24-9/16" 623.9mm	15/16" 23.8mm			2-1/2" 63.5mm	.240" 6.1mm	(3) blades for 72" cut. Fits tractor models L2850, L2550, F2100, F2100F & F2400 with deck models RC72-78, RC72-F25, RC72-F20 & RC72-F24



KYNAST

	15 - 50123		3R-1668	18-5/8" 473.08mm	.782" 20.00mm	.41" 10.72mm	1.56" 39.69mm	2.75" 69.85mm	.125" 3.18mm	
---	-------------------	--	---------	----------------------------	-------------------------	------------------------	-------------------------	-------------------------	------------------------	--

LAWN-BOY (also see GILSON)

	15 - 848		612079-03 612079 682909	18-15/16" 481mm	5/8" 15.9mm	17/32" 13.5mm	2-9/16" 65.1mm	3" 76.2mm	.134" 3.4mm	For Scamp Mowers
	15 - 1057		603703	20-3/4" 527.1mm	5/8" 15.9mm			2-1/2" 63.5mm	.134" 3.4mm	
	15 - 849		612543-03 612543 683682 608094	20-7/8" 530.2mm	5/8" 15.9mm	17/32" 5.6mm	2-9/16" 65.1mm	3" 76.2mm	.134" 3.4mm	For 21" Tri cut (Std.)

LESCO

	15 - 3403		021871	16-1/2" 419.1mm	5/8" 15.9mm			2-1/2" 63.5mm	.204" 5.2mm	(3) blades for 48" cut
	15 - 6009		050111	16-1/2" 419.1mm	5/8" 15.9mm			3" 76.2mm	.204" 5.2mm	(3) blades for 48" cut
	15 - 6300		21871	16-1/2" 419.1mm	5/8" 15.9mm			2-1/2" 63.5mm	.204" 5.2mm	Mulching Blade PATENTED

14/16











BLADES

BLADES



**Blades for
LESCO (continued)**



ORDER NO.	SUGG. LIST	CODE	REPLACES O.E.M. NO.	LENGTH	CENTER HOLE DIAM.	OUTSIDE HOLE DIAM.	CENTER TO CENTER	WIDTH	STEEL THICK.	APPLICATION
15 - 3404			050125	18" 457.2mm	5/8" 15.9mm			2-1/2" 63.5mm	.204" 5.2mm	(2) blades for 36" cut (3) blades for 52" cut.
15 - 3442			050140 482467	18" 457.2mm	5/8" 15.9mm			3" 76.2mm	.204" 5.2mm	(2) blades for 36" cut (3) blades for 52" cut High lift
15 - 10173			050140	18" 457.2mm	5/8" 15.8mm			2-1/2" 63.5mm	.204" 5.2mm	Flat Blade Sharpened - 4-sides
15 - 6294			050140 50125	18" 457.2mm	5/8" 15.9mm			2-1/2" 63.5mm	.204" 5.2mm	Mulching Blade PATENTED
15 - 9968			050140	18" 457.2mm	5/8" 15.8mm			2" 50.8mm	.240" 6.1mm	Low-Lift Blade Sharpened - 4-sides
15 - 6008			050156 482129	20" 508mm	5/8" 15.9mm			2-1/2" 63.5mm	.204" 5.2mm	
15 - 3434			050170	21" 533.4mm	5/8" 15.9mm			2-1/2" 63.5mm	.204" 5.2mm	(3) blades for 61" cut
15 - 10174			050170	21" 533.4mm	5/8" 15.8mm			2-1/2" 63.5mm	.204" 5.2mm	Flat Blade Sharpened - 4-sides
15 - 6299			050170	21" 533.4mm	5/8" 15.9mm			2-1/2" 63.5mm	.204" 5.2mm	Mulching Blade PATENTED
15 - 9969			050170	21" 533.4mm	5/8" 15.8mm			2" 50.8mm	.240" 6.1mm	Low-Lift Blade Sharpened - 4-sides

14/16





BLADES



BLADES

**Blades for
MARINA**







ORDER NO.	SUGG. LIST	CODE	REPLACES O.E.M. NO.	LENGTH	CENTER HOLE DIAM.	OUTSIDE HOLE DIAM.	CENTER TO CENTER	WIDTH	STEEL THICK.	APPLICATION
	15 - 10199		CP042013	16-17/64" 413.1mm	13/32" 10.3mm	5/16" 7.9mm	2-9/16"2-13/64"	56mm	.160" 4.1mm	Fits model GT42B.
	15 - 10198		CP047010	18-3/32" 459.6mm	45/64" 17.9mm	5/16" 7.9mm	1-49/64"2-13/64"	56mm	.160" 4.1mm	Fits model GT47E
	15 - 10201		CP050013	18-49/64" 476.6mm	5/8" 15.9mm	5/16" 7.9mm	2-9/16"2-13/64"	56mm	.160" 4.1mm	Fits models GT50B/GT50SB
	15 - 10202		CP056103	20-11/16" 525.5mm	5/8" 15.9mm	5/16" 7.9mm	2-9/16"2-13/64"	56mm	.160" 4.1mm	Fits model GT56SB

MOUNTFIELD

	15 - 50022		M1336	18" 457.20mm	.629" 16.00mm	.281" 7.14mm	2.75"	2.85"	.117" 3.00mm	
---	-------------------	--	-------	------------------------	------------------	-----------------	-------	-------	-----------------	--

MTD

	15 - 3408		942-0252 742-0252	6-3/8" 161.9mm	3/8" 9.5mm			1-1/2" 38.1mm	.095" 2.4mm	Takes (1) 15-3408 and (2) 15-3407 for 44" deck (MTD, White and Yardman)
	15 - 6128		942-0539 742-0539	12-3/8" 314.3mm	1-1/2" 38.1mm	7/16" 11.1mm	2-1/2"	3-3/4" 95.3mm	.117" 3mm	Cross Blade for 42" cut. used with blades 15-6126 & 15-6127
	15 - 6019		942-0486 742-0486	14-3/4" 374.7mm	13/32" 10.3mm	5/16" 7.9mm	2-1/2"	3" 76.2mm	.150" 3.8mm	Deep Deck, 800 series Takes (2) 15-6003 and (1) 15-6019 for 46" cut
	15 - 1077		942-0118 742-0118	15-5/16" 388.9mm	3/8" 9.5mm	5/16" 7.9mm	2-1/2"	2" 50.8mm	.150" 3.8mm	(2) blades for 30" cut

14/16













BLADES

BLADES



**Blades for
MTD**



ORDER NO.	SUGG. LIST	CODE	REPLACES O.E.M. NO.	LENGTH	CENTER HOLE DIAM.	OUTSIDE HOLE DIAM.	CENTER TO CENTER	WIDTH	STEEL THICK.	APPLICATION
15 - 6003			942-0487A 742-0487A	16-1/4" 412.8mm	13/32" 10.3mm	5/16" 7.9mm	2-1/2" 63.5mm	3" 76.2mm	.150" 3.8mm	Deep Deck, 800 series Takes (2) 15-6003 and (1) 15-6019 for 46" cut.
15 - 997			942-0120B 942-0120 742-0120	17-1/4" 438.2mm	3/8" 9.5mm	5/16" 7.9mm	2-1/2" 63.5mm	2" 50.8mm	.150" 3.8mm	(2) blades for 34" cut
15 - 3356			942-0171B 742-0171B 742-0171	17-1/4" 438.2mm	3/8" 9.5mm	5/16" 7.9mm	2-1/2" 63.5mm	2-1/2" 63.5mm	.204" 5.2mm	(3) blades for 50" cut
15 - 1014			942-0120B 742-0121B 742-0121	18" 457.2mm	3/8" 9.5mm	5/16" 7.9mm	2-1/2" 63.5mm	2" 50.8mm	.150" 3.8mm	(2) blades for 36" cut 18" push/side discharge
15 - 6143			942-0496 742-0496	18-3/16" 462mm	13/32" 10.3mm	5/16" 7.9mm	2-1/2" 63.5mm	3" 76.2mm	.150" 3.8mm	Deep Deck, 1989 & after (2) blades for 36" cut High lift
15 - 12963			942-0677-X	18-1/2" 469.9mm	"H" Pattern			3" 76.2mm	.204" 5.1mm	Mulching Blade (3) Blades for 54" cut PATENTED
15 - 1015			942-0122A 742-0122A	19" 482.6mm	3/8" 9.5mm	5/16" 7.9mm	2-1/2" 63.5mm	2" 50.8mm	.150" 3.8mm	(2) blades for 38" cut
15 - 6126			942-0537 742-0537	19-5/16" 490.5mm	.406" 10.3mm	.450" 11.4mm	2-1/2" 63.5mm	3" 76.2mm	.150" 3.8mm	Mulching blade Takes (2) for 38" cut use with our 15-6128
15 - 6006			942-0473A 742-0473A	19-5/16" 490.5mm	13/32" 10.3mm	5/16" 7.9mm	2-1/2" 63.5mm	3" 76.2mm	.150" 3.8mm	For 38" Deep Deck. Takes (1) 15-6006 and (1) 15-3471 or (2) 15-6006
15 - 1016			942-0123B 742-0123	20" 508mm	3/8" 9.5mm	5/16" 7.9mm	2-1/2" 63.5mm	2" 50.8mm	.150" 3.8mm	
15 - 6005			942-0620 742-0620 742-0520	20" 508mm	13/16" 20.6mm	3/8" 9.5mm	2-1/2" 63.5mm	2" 50.8mm	.150" 3.8mm	Fits 030/040 mower
15 - 6140			942-0720 942-0500 742-0500	20" 508mm	13/16" 20.6mm	3/8" 9.5mm	2-1/2" 63.5mm	2-1/4" 57.2mm	.125" 3.2mm	Fits 090 series 20" mulcher











14/16

BLADES



**Blades for
MTD (continued)**



ORDER NO.	SUGG. LIST	CODE	REPLACES O.E.M. NO.	LENGTH	CENTER HOLE DIAM.	OUTSIDE HOLE DIAM.	CENTER TO CENTER	WIDTH	STEEL THICK.	APPLICATION
15 - 6457			942-0720	20" 508mm	13/16" 20.6mm	3/8" 9.5mm	2-1/2" 63.5mm	2-1/4" 57.2mm	.125" 3.2mm	Fits 20" walkbehind mowers. For splined shaft models & Electric models. Mulching blade.
15 - 50201			742-0608	20-23/64" 517.13mm	27/64" .410mm	21/64" .320mm	2-1/2" 2.50mm	2" 50.80mm	.150" 3.8mm	
15 - 50202			742-0607	20-23/64" 517.13mm	27/64" .410mm	21/64" .320mm	2-1/2" 63.50mm	2" 50.80mm	.150" 3.8mm	
15 - 6096			942-0621 742-0621 742-0521	20-15/16" 531.8mm	13/16" 20.6mm	3/8" 9.5mm	2-1/2" 63.5mm	2" 50.8mm	.150" 3.8mm	21" Rear Bagger Fits models 312R, 313R, 315R
15 - 1017			942-0124B 742-0124	21" 533.4mm	3/8" 9.5mm	5/16" 7.9mm	2-1/2" 63.5mm	2" 50.8mm	.150" 3.8mm	
15 - 6042			942-0621A 742-0621 742-0306A	21" 533.4mm	13/16" 20.6mm	3/8" 9.5mm	2-1/2" 63.5mm	2-1/2" 63.5mm	.150" 3.8mm	21" Rear Bagger Fits models 816R, 818R, 462R thru 479R
15 - 6139			942-0721 742-0721	21" 533.4mm	27/32" 21.4mm	3/8" 9.5mm	2-1/2" 63.5mm	2-1/4" 57.2mm	.125" 3.2mm	21" mulcher Fits Yardman & White Fits models 410/425
15 - 6127			942-0538 742-0538	21-3/16" 538.2mm	13/32" 10.3mm	7/16" 11.1mm	2-1/2" 63.5mm	3" 76.2mm	.150" 3.8mm	Takes (2) for 42" cut use with our 15-6128
15 - 6028			942-0499A 742-0499A 742-0499	21-3/16" 538.2mm	13/32" 10.3mm	5/16" 7.9mm	2-1/2" 63.5mm	3" 76.2mm	.150" 3.8mm	Deep Deck 42" cut mower. Takes (2) blades, side discharge 1990 & after
15 - 6295			742-0499	21-3/16" 538.2mm	13/32" 10.3mm	5/16" 7.9mm	2-1/2" 63.5mm	3" 76.2mm	.150" 3.8mm	Mulching Blade PATENTED
15 - 1018			942-0125B 742-0125B 742-0125	22" 558.8mm	3/8" 9.5mm	5/16" 7.9mm	2-1/2" 63.5mm	2" 50.8mm	.150" 3.8mm	(2) blades for 42" cut
15 - 6004			942-0622 742-0622 742-0522	22" 558.8mm	13/16" 20.6mm	3/8" 9.5mm	2-1/2" 63.5mm	2" 50.8mm	.150" 3.8mm	22" Std. deck

14/16



BLADES

BLADES



**Blades for
MTD (continued)**



ORDER NO.	SUGG. LIST	CODE	REPLACES O.E.M. NO.	LENGTH	CENTER HOLE DIAM.	OUTSIDE HOLE DIAM.	CENTER TO CENTER	WIDTH	STEEL THICK.	APPLICATION
										
15 - 3407			942-0295 742-0295	22" 558.8mm	13/32" 10.3mm	5/16" 7.9mm	2-1/2" 63.5mm	2" 50.8mm	.187" 4.8mm	Takes (1) 15-3408 and (2) 15-3407 for 44" deck (MTD, White and Yardman)
										
15 - 6212			942-0722 742-0722	22" 558.8mm	13/16" 20.6mm	3/8" 9.5mm	2-1/2" 63.5mm	2-1/4" 57.2mm	.125" 3.2mm	Fits 22" walk behind Mulcher.
										
15 - 3354			942-0256A 742-0256A	30" 762mm	3/8" 9.5mm	5/16" 7.9mm	2-1/2" 63.5mm	3" 76.2mm	.150" 3.8mm	









14/16

BLADES



**Blades for
MTD (continued)**



ORDER NO.	SUGG. LIST	CODE	REPLACES O.E.M. NO.	LENGTH	CENTER HOLE DIAM.	OUTSIDE HOLE DIAM.	CENTER TO CENTER	WIDTH	STEEL THICK.	APPLICATION
15 - 1022			942-0543 742-0543	14-13/16" 376.2mm	"H" Pattern	5/16" 7.9mm	2-1/2" 63.5mm	3" 76.2mm	.125" 3.2mm	Takes (1) 15-1022 & (2) 15-1021 for 46" cut
15 - 1030			742-04124 942-04124 942-0612 742-0612	14-13/16" 376.2mm	"H" Pattern	3/8" 9.5mm	2-1/2" 63.5mm	2-1/2" 63.5mm	.150" 3.8mm	Takes (1) 15-1030 & (2) 15-1029 for 46" cut. Fits models 600 & 800 series 1997 & after, side discharge tractors. Mulching blade.
15 - 1038			942-0645	14-13/16" 376.2mm	"H" Pattern	21/64" 8.2mm	2-1/2" 63.5mm	3" 76.2mm	.125" 3.2mm	Takes (1) 15-1038 & (2) 15-1037 for 46" cut. Fits deep deck riding mowers, 1997 & after. Mulching blade.
15 - 1021			942-0542 742-0542	16-1/4" 412.8mm	"H" Pattern	5/16" 7.9mm	2-1/2" 63.5mm	3" 76.2mm	.125" 3.2mm	Takes (2) 15-1021 & (1) 15-1022 for 46" cut
15 - 1037			942-0644	16-1/4" 412.8mm	"H" Pattern	5/16" 7.9mm	2-1/2" 63.5mm	3" 76.2mm	.125" 3.2mm	Takes (1) 15-1038 & (2) 15-1037 for 46" cut. Fits deep deck riding mowers, 1997 & after. Mulching blade.
15 - 1029			942-0611 742-0611	16-1/4" 412.8mm	"H" Pattern	3/8" 9.5mm	2-1/2" 63.5mm	2-1/2" 63.5mm	.150" 3.8mm	Takes (1) 15-1030 & (2) 15-1029 for 46" cut. Fits models 600 & 800 series 1997 & after, side discharge tractors. Mulching blade.
15 - 1034			942-0623	17-5/16" 439.7mm	"H" Pattern	21/64" 8.2mm	2-1/2" 63.5mm	2-1/2" 63.5mm	.187" 4.8mm	(3) blades for 50" cut. Fits deep deck riding mowers, 1998 & after. Mulching blade.
15 - 11719			742-0677 942-0677	18-1/2" 469.9mm	"H" Pattern			3" 76.2mm	.204" 5.1mm	(3) blades for 54" cut. Fits 2002 and newer models 54" riders.

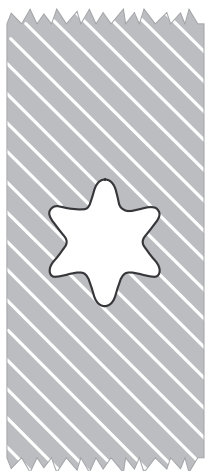

Old blade
Center Hole Pattern

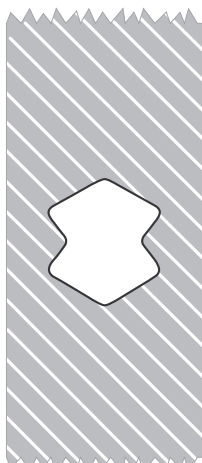

New Blade
Center Hole "H" Pattern

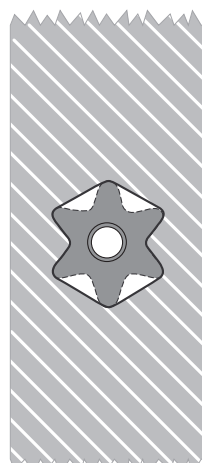

New Blade Center Hole
with MTD's 6 Point
Star Spindle

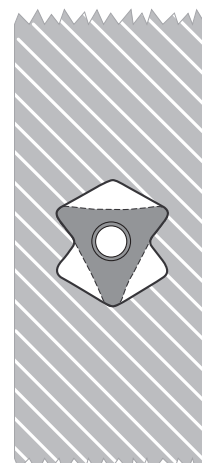

New Blade Center Hole
with our 10-9284, 10-9285,
10-9286, 10-9287,
10-9288 Spindle

14/16

BLADES

BLADES



Blades for MTD (continued)



ORDER NO.	SUGG. LIST	CODE	REPLACES O.E.M. NO.	LENGTH	CENTER HOLE DIAM.	OUTSIDE HOLE DIAM.	CENTER TO CENTER	WIDTH	STEEL THICK.	APPLICATION
15 - 1024			942-0610	19-5/16" 490.5mm	"H" Pattern	5/16" 7.9mm	2-1/2" 63.5mm	3" 76.2mm	.150" 3.8mm	(2) blades for 38" cut.
15 - 1026			942-0610	19-5/16" 490.5mm	"H" Pattern	5/16" 7.9mm	2-1/2" 63.5mm	3" 76.2mm	.150" 3.8mm	(2) blades for 38" cut. Mulching Blade
15 - 11232			942-0610	19-5/16" 490.5mm	"H" Pattern	5/16" 7.9mm	2-1/2" 63.5mm	3" 76.2mm	.150" 3.8mm	(2) Blades for 38" cut. Mulching Blade.
15 - 1031			742-04126 942-0616 742-0616	21-3/16" 538.2mm	"H" Pattern	5/16" 7.9mm	2-1/2" 63.5mm	3" 76.2mm	.150" 3.8mm	(2) blades for 42" cut.
15 - 1032			742-0416 942-0616 742-0616	21-3/16" 538.2mm	"H" Pattern	5/16" 7.9mm	2-1/2" 63.5mm	3" 76.2mm	.150" 3.8mm	(2) blades for 42" cut. Mulching Blade
15 - 11233			742-04126 942-0616 742-0616	21-3/16" 538.2mm	"H" Pattern	5/16" 7.9mm	2-1/2" 63.5mm	3" 76.2mm	.150" 3.8mm	Mulching Blade.
15 - 12956			942-04244 942-04290	23-1/2" 596.9mm	"H" Pattern			3" 76.2mm	.150" 3.81mm	Fits Cub Cadet series 100 LTX lawn tractors with 46" decks, 2009 and after. Also fits LTX1046.
15 - 1023			942-0609	30" 762mm	"H" Pattern	21/64" 8.2mm	2-1/2" 63.5mm	2-3/4" 69.9mm	.160" 4.0mm	Fits MTD side discharge deck, riding mowers 1990 & after.

14/16

BLADES

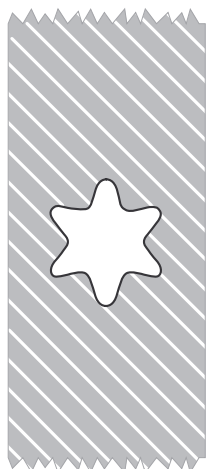

Old blade
Center Hole Pattern

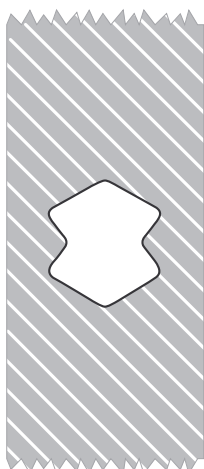

New Blade
Center Hole "H" Pattern

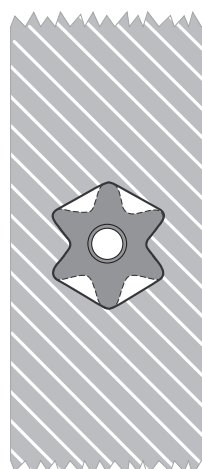

New Blade Center Hole
with MTD's 6 Point
Star Spindle

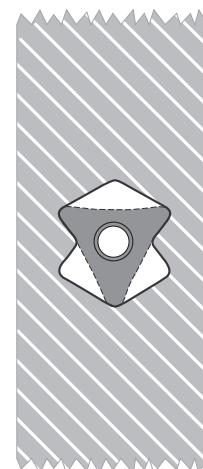

New Blade Center Hole
with our 10-9284, 10-9285, 10-9286, 10-9287, 10-9288 Spindle



**Blades for
MTD (continued)**



ORDER NO.	SUGG. LIST	CODE	REPLACES O.E.M. NO.	LENGTH	CENTER HOLE DIAM.	OUTSIDE HOLE DIAM.	CENTER TO CENTER	WIDTH	STEEL THICK.	APPLICATION
15 - 6448			942-0738	18" 457.2mm	59/64" X 11/16" Prox.*	5/16" 7.9mm	2-1/2" 63.5mm	2-1/4" 57.2mm	.134" 3.4mm	* See Details Below * Mulching blade. Fits MTD deck 1995 & newer. Fits 18" walkbehind.
15 - 12893			742-0739 942-0739	19" 482.6mm	59/64" X 11/16"			2-1/4" 57.2mm	.125" 3.18mm	Fits 19" walk behind mowers.
15 - 6438			942-0740	20" 508mm	59/64" X 11/16" Prox.*	5/16" 7.9mm	2-1/2" 63.5mm	2-1/4" 57.2mm	.125" 3.2mm	* See Details Below * Mulching blade. Fits MTD deck 1997 & newer. Fits 20" walkbehind.
15 - 6439			942-0640	20" 508mm	59/64" X 11/16" Prox.*	5/16" 7.9mm	2-1/2" 63.5mm	2-1/4" 57.2mm	.125" 3.2mm	* See Details Below * High lift blade. Fits MTD deck 1997 & newer. Fits 20" walkbehind.
15 - 6423			942-0741 742-0741	21" 532.2mm	59/64" X 11/16" Prox.*	5/16" 7.9mm	2-1/2" 63.5mm	2-1/4" 57.2mm	.125" 3.2mm	* See Details Below * Mulching blade Fits MTD deck 1995 & newer.
15 - 6450			942-0641	21" 533.4mm	59/64" X 11/16" Prox.*	5/16" 7.9mm	2-1/2" 63.5mm	2-1/4" 57.2mm	.134" 3.4mm	* See Details Below * High lift blade. Fits MTD deck 1997 & newer. Fits 21" walkbehind.
15 - 6424			942-0742 742-0742	22" 558.88mm	59/64" X 11/16" Prox.*	5/16" 7.9mm	2-1/2" 63.5mm	2-1/4" 57.2mm	.125" 3.2mm	* See Details Below * Mulching blade Fits MTD deck 1995 & newer. Fits 22" walkbehind.

NOTE: ROTARY DOES NOT SELL THIS BLADE ADAPTOR, THIS IS FOR ILLUSTRATION ONLY

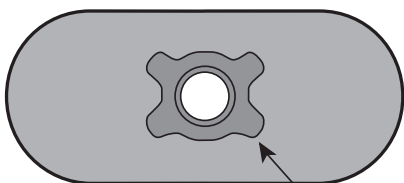

**MTD
BLADE
ADAPTER**
ORIGINAL
DESIGN

Blade Hub
Blade Hub

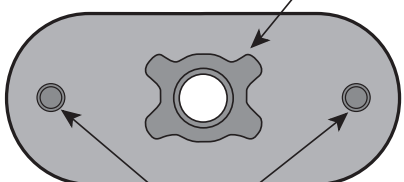

**MTD
BLADE
ADAPTER**
REVISED
DESIGN

Raised Bosses

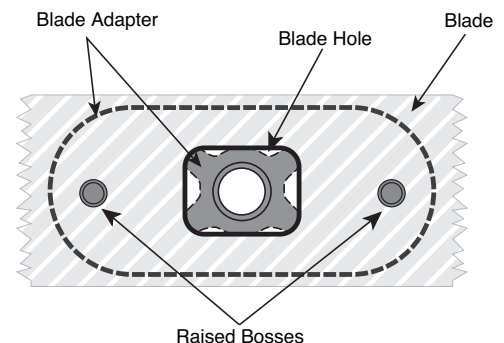

Illustration of our new 59/64" x 11/16" center hole, on Rotary Part #'s **6423, 6424, 6425, 6438, 6439, 6446, 6448 & 6450** that will adapt to MTD's 4-point star center hole. **MUST BE UTILIZED WITH "REVISED" BLADE ADAPTER (WITH BOSSES) ONLY.**

14/16



BLADES

BLADES



Blades for MTD (continued)



ORDER NO.	SUGG. LIST	CODE	REPLACES O.E.M. NO.	LENGTH	CENTER HOLE DIAM.	OUTSIDE HOLE DIAM.	CENTER TO CENTER	WIDTH	STEEL THICK.	APPLICATION
15 - 6425			942-0642 742-0642	22" 558.88mm	59/64" X 11/16" Prox.*	5/16" 7.9mm	2-1/2" 63.5mm	2-1/4" 57.2mm	.125" 3.2mm	* See Details Below * Fits MTD deck 1995 & newer. Fits 22" walkbehind.
14 - 10631			20"	1" 508mm	25.4mm		2-1/2" 63.5mm	.150" 3.8mm		*See Details Below* Universal Commercial Mulching Blade.
14 - 10633			22"	1" 558.8mm	25.4mm		2-1/2" 63.5mm	.150" 3.8mm		*See Details Below* Universal Commercial Mulching Blade.

NOTE: ROTARY DOES NOT SELL THIS BLADE ADAPTOR, THIS IS FOR ILLUSTRATION ONLY

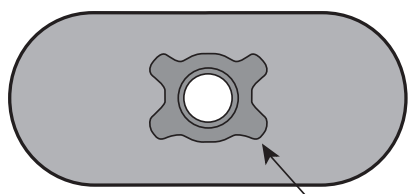

MTD BLADE ADAPTER

ORIGINAL DESIGN

Blade Hub
Blade Hub

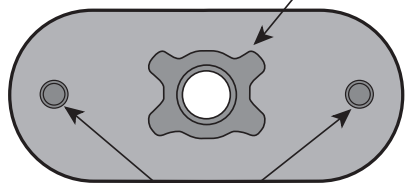

MTD BLADE ADAPTER

REVISED DESIGN

Raised Bosses

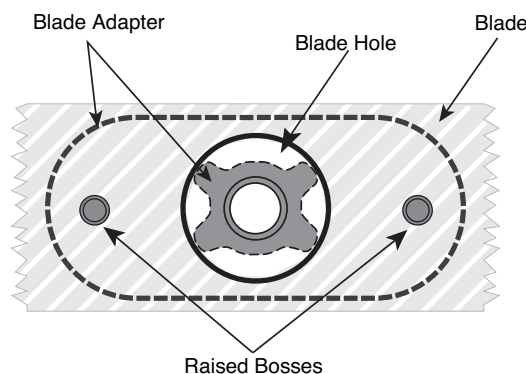
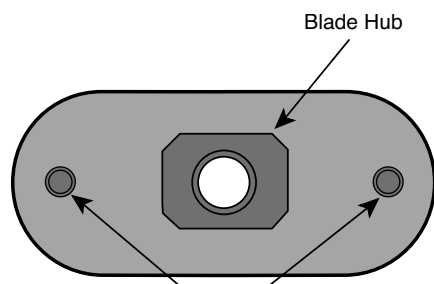

Illustration of our new 1" center hole Universal Commercial Mulcher, on Rotary Part #'s **10631, 10632, 10633** that will adapt to MTD's 4-point star center hole. **MUST BE UTILIZED WITH "REVISED" BLADE ADAPTER (WITH BOSSES) ONLY.**

14/16

BLADES



MTD BLADE ADAPTER

Raised Bosses

Illustration of our new 7/8" center hole Universal Commercial Mulcher, on Rotary Part #'s **14580, 14581, 6448, 12893, 438, 6439, 6423, 6450, 6424, 6425** that will adapt to MTD's 4-point star center hole.



BLADES

**Blades for
MURRAY**



ORDER NO.	SUGG. LIST	CODE	REPLACES O.E.M. NO.	LENGTH	CENTER HOLE DIAM.	OUTSIDE HOLE DIAM.	CENTER TO CENTER	WIDTH	STEEL THICK.	APPLICATION
15 - 844			24458E701	15-1/32" 381.8mm	7/8" x 1"			2-1/4" 57.2mm	.150" 3.8mm	(3) blades for 42" cut
15 - 1122			20928E701	15-3/16" 385.8mm	7/8" x 1"			2-1/4" 57.2mm	.150" 3.8mm	(2) blades for 30" cut
15 - 6161			92352E701	15-11/16" 398.5mm	.850" 21.4mm			2-1/4" 57.2mm	.134" 3.4mm	(3) blades for 46" cut Low Lift
15 - 6408			56631E701	15-11/16" 398.5mm	.850" 21.4mm			2-1/4" 57.2mm	.134" 3.4mm	(3) blades for 46" cut Mulcher
15 - 6113			92117E701	15-3/4" 400.1mm	27/32" 21.4mm			2-1/4" 57.2mm	.134" 3.4mm	(3) blades for 46" deck High Lift
15 - 6491			92117E701	15-3/4" 400mm	27/32" 21.4mm			2-1/2" 63.5mm	.150" 3.8mm	Mulching Blade PATENTED
15 - 9896			92117	15-3/4" 400mm	27/32" 21.4mm			2-1/4" 57.2mm	.187" 4.8mm	(3) blades for 46" cut. High Lift (Heavy Duty)
15 - 50255			881076YP	16" 406.4mm	13/32" 10.3mm	13/32" 10.3mm	1-7/8" 25.4mm	2-1/4" 50.8mm	.150" 3.8mm	(Export Only)
15 - 6470			94692E701	17-41/64" 448.07mm	.850" 21.8mm			2-1/4" 57.2mm	.150" 3.8mm	Fits models 48560X9Z, 50563x8, 52370x92 48", 50" & 52" cut.
15 - 6018			54390E701	18-1/8" 460.4mm	7/8" x 1"			2-1/4" 57.2mm	.134" 3.4mm	For 36" cut, takes (2) 15-3429 and (2) 15-6018 Blades cross
15 - 1124			20930E701 54390E701	18-3/16" 462mm	7/8" x 1"			2-1/4" 57.2mm	.150" 3.8mm	(2) blades for 36" cut
15 - 50254			880638YP	19" 482.6mm	13/32" 10.3mm	13/32" 10.3mm	1-7/8" 25.4mm	2-1/4" 50.8mm	.150" 3.8mm	(Export Only)

14/16













BLADES

BLADES



**Blades for
MURRAY (continued)**



ORDER NO.	SUGG. LIST	CODE	REPLACES O.E.M. NO.	LENGTH	CENTER HOLE DIAM.	OUTSIDE HOLE DIAM.	CENTER TO CENTER	WIDTH	STEEL THICK.	APPLICATION
15 - 6111			92003E701	19-3/8" 492.1mm	.850" 21.4mm			2-1/4" 57.2mm	.150" 3.8mm	Low lift (2) blades for 38" cut
15 - 6142			71548E701 43865	19-3/8" 492.1mm	13/32" 10.3mm			2-1/4" 57.2mm	.134" 3.4mm	20" mulcher (1991)
15 - 6119			91742E701	19-1/2" 495.3mm	.850" 21.4mm			2-1/4" 57.2mm	.187" 4.8mm	(Heavy Duty) (2) blades for 38" cut
15 - 6017			91742E701	19-1/2" 495.3mm	.850" 21.4mm			2-1/4" 57.2mm	.134" 3.4mm	(2) blades for 38" cut
15 - 6146			56250E701	19-1/2" 495.3mm	.850" 21.4mm			2-3/4" 69.9mm	.134" 3.4mm	(2) blades for 38" cut mulcher
15 - 11555			95104E701 09510E701	19-1/2" 495.3mm	.850" 21.6mm			2-1/2" 63.5mm	.134" 3.4mm	3 in 1 blade. (2) blades for a 38" cut.
15 - 2012			20045E701 42785E701	19-15/16" 506.4mm	13/32" 10.3mm	13/32" 10.3mm	2-1/2" 63.5mm	2-1/4" 57.2mm	.150" 3.8mm	
15 - 10066			672763	20" 508mm	3/8" 9.5mm			2-3/4" 69.9mm	.150" 3.8mm	Fits 20" walkbehind mower. Mulching Blade.
15 - 6034			91871E701	20-3/8" 517.5mm	.850" 21.4mm			2-1/4" 57.2mm	.134" 3.4mm	Fits models 40603, 40604, 40606, 40620 & 40622 Takes (2) for 40" cut
15 - 6112			92002E701	20-3/8" 517.5mm	.850" 21.4mm			2-1/4" 57.2mm	.150" 3.8mm	Low lift (2) blades for 40" cut
15 - 6145			56251E701	20-3/8" 517.5mm	.850" 21.4mm			2-3/4" 69.9mm	.134" 3.4mm	(2) blades for 40" cut mulcher
15 - 6475			095103E701	20-3/8" 517.5mm	.850" 21.8mm			2-1/4" 57.2mm	.134" 3.4mm	3-n-1 Blade. Takes (2) blades for 40" cut.













14/16
BLADES



BLADES

**Blades for
MURRAY (continued)**



ORDER NO.	SUGG. LIST	CODE	REPLACES O.E.M. NO.	LENGTH	CENTER HOLE DIAM.	OUTSIDE HOLE DIAM.	CENTER TO CENTER	WIDTH	STEEL THICK.	APPLICATION
15 - 6129			91871E701	20-3/8" 517.5mm	27/32" 21.4mm			2-1/4" 57.2mm	.187" 4.8mm	(2) blades for 40" cut (Heavy Duty)
15 - 11234			91871E701	20-3/8" 517.5mm	27/32" 21.4mm			2-1/4" 57mm	.187" 4.8mm	(2) Blades for 40" cut. Mulching Blade.
15 - 9228			71584E701	20-3/4" 527mm	13/32" 10.3mm			2-1/4" 57.2mm	.134" 3.4mm	Mulching Blade. For 21" walk-behinds
15 - 6039			43836E701	20-13/16" 528.6mm	13/32" 10.3mm			2-1/4" 57.2mm	.134" 3.4mm	Fits models 21681X5 & 21681X62 For 21" walk behind
15 - 3390			22860E701	20-13/16" 528.6mm	13/32" 10.3mm	13/32" 10.3mm	2-1/2" 63.5mm	2-1/4" 57.2mm	.134" 3.4mm	
15 - 6160			71161E701	20-7/8" 530.2mm	13/32" 10.3mm			2-3/4" 69.9mm	.150" 3.8mm	Mulcher
15 - 6476			095100E701A	21-3/16" 538.1mm	.850" 21.8mm			2-1/4" 57.2mm	.134" 3.4mm	3-n-1 Blade Takes (2) blades for 42" cut.
15 - 6144			56252E701	21-1/4" 539.8mm	.850" 21.4mm			2-3/4" 69.9mm	.134" 3.4mm	(2) blades for 42" cut Mulcher
15 - 6162			92418E701 95101E701	21-1/4" 539.8mm	.850" 21.4mm			2-1/4" 57.2mm	.150" 3.8mm	(2) blades for 42" cut High Lift
15 - 6460			92418E701 95101E701	21-1/4" 539.8mm	27/32" 21.4mm			2-1/2" 63.5mm	.150" 3.8mm	Mulching Blade PATENTED
15 - 9897			92418	21-1/4" 539.8mm	27/32" 21.4mm			2-1/4" 57.2mm	.187" 4.8mm	(2) blades for 42" cut. High Lift (Heavy Duty)
15 - 6166			95101E701 92419E701	21-1/4" 539.8mm	.850" 21.4mm			2-1/4" 57.2mm	.150" 3.8mm	(2) blades for 42" cut

14/16











BLADES

BLADES



**Blades for
MURRAY (continued)**



ORDER NO.	SUGG. LIST	CODE	REPLACES O.E.M. NO.	LENGTH	CENTER HOLE DIAM.	OUTSIDE HOLE DIAM.	CENTER TO CENTER	WIDTH	STEEL THICK.	APPLICATION
15 - 11868			7100851A 1101823	21-5/8" 549.3mm	13/32" 10.3mm	13/32" 10.3mm	1-7/8" 47.6mm	2-1/4" 57.2mm	.135" 3.5mm	3 in 1 blade
15 - 6471			672059E701	21-7/8" 555.6mm	13/32" 10.3mm			2-1/4" 57.1mm	.134" 3.4mm	Fits 22" walkbehind mowers.
15 - 2013			42225E701	21-15/16" 557.2mm	13/32" 10.3mm	13/32" 10.3mm	2-1/2" 63.5mm	2-1/4" 57.2mm	.150" 3.8mm	
15 - 6174			1101120E701 71849E701 71499E701 71113E701	22" 558.8mm	13/32" 10.3mm			2-1/4" 57.2mm	.150" 3.8mm	Mulcher blade for walkbehind
15 - 2166			54053E701	30" 762mm		7/8" x 1"		2-1/4" 57.2mm	.150" 3.8mm	High Lift
15 - 3430			55969E701	30" 762mm	.850" 21.4mm			2-3/4" 69.9mm	.160" 4.1mm	
15 - 6027			56246E701 56212E701	30" 762mm	.850" 21.4mm			2-3/4" 69.9mm	.160" 4.1mm	High Lift
15 - 6010			56061E701	30" 762mm		7/8" x 1"		2-3/4" 69.9mm	.160" 4.1mm	
15 - 3443			55793E701	30" 762mm	.850" 21.4mm			2-1/4" 57.2mm	.187" 4.8mm	
15 - 6215			56217 56210	30" 762mm	.850" 21.4mm			2-3/4" 69.9mm	.150" 3.8mm	Fits 30" rear engine rider models 2466A & 24661A Mulching Blade

14/16









BLADES



BLADES

**Blades for
NOMA**



ORDER NO.	SUGG. LIST	CODE	REPLACES O.E.M. NO.	LENGTH	CENTER HOLE DIAM.	OUTSIDE HOLE DIAM.	CENTER TO CENTER	WIDTH	STEEL THICK.	APPLICATION
15 - 6031			00782972 9248 300323	9-5/8" 244.5mm	3/8" 9.5mm			2" 50.8mm	.134" 3.4mm	(1) 15-6031 & (2) 15-6024 for 45" deck
15 - 6021			00782971 8684 56820	16-1/8" 409.6mm	3/8" 9.5mm			1-15/16" 49.2mm	.134" 3.4mm	(2) blades for 32" cut rear Engine rider
15 - 1093			00782971 42433	16-1/4" 412.8mm	3/8" 9.5mm			2" 50.8mm	.150" 3.8mm	(2) blades for 32" cut
15 - 3447			00782965 8685 56821	18-1/8" 460.4mm	3/8" 9.5mm			2" 50.8mm	.134" 3.4mm	(2) blades for 36" cut
15 - 6024			306931 58212	18-1/8" 460.4	3/8" 9.5mm			2-1/16" 52.4mm	.134" 3.4mm	(2) blades for 36" cut
15 - 1085			00782965 39311	18-5/32" 461.2mm	3/8" 9.5mm			2" 50.8mm	.150" 3.8mm	(2) blades for 36" cut
15 - 6025			30544-0637 306932 58190	19-5/8" 498.5mm	3/8" 9.5mm			2-1/8" 54mm	.134" 3.4mm	(2) blades for 39" cut Lawn Chief Tractor
15 - 3406			031039 309069 57299	19-11/16" 500.1mm	3/8" 9.5mm			2" 50.8mm	.134" 3.4mm	(2) blades for 39" cut Lawn Chief Tractor
15 - 3336			41198	20" 508mm	3/8" 9.5mm	5/16" 7.9mm	2-1/8" 54mm	2" 50.8mm	.150" 3.8mm	

14/16





BLADES

BLADES



**Blades for
NOMA (continued)**



ORDER NO.	REPLACES O.E.M. NO.	LENGTH	CENTER HOLE DIAM.	OUTSIDE HOLE DIAM.	CENTER TO CENTER	WIDTH	STEEL THICK.	APPLICATION
 15 - 6099	309070	20-1/4"	3/8"			2-3/4"	.134"	Fits model A4016-030 (2) blades for 40" cut
	303065	514.4mm	9.5mm			69.9mm	3.4mm	
 15 - 6286	330278	21-5/8"	3/8"			2"	.187"	(2) blades for 43" cut. Mulching blade
		549.3mm	9.5mm			50.8mm	4.8mm	
 15 - 6138	316608	21-3/4"	13/32"			3-15/16"	.134"	(2) blades for 42" & 43" cut
	313954	552.5mm	10.3mm			100mm	3.4mm	
 15 - 6468	325751	29-7/8"	1/2"	.390x.940"	2.708"	2-3/4"	.187"	
		758.8mm	12.7mm		68.3mm	.69.9mm	4.8mm	

**Tine Spring for
PARKER**

Order No.	Description	Coil Dia.	Length Over All	Length of Coil	Thick- ness
 15 - 8590	MIN101 Tine spring replaces Parker 66-238-A-1100. Fits on tine reel assembly. 101 per set.	13/16"	5"	9/16"	3/32"

14/16







BLADES



BLADES

**Blades for
PILOTE**



ORDER NO.	REPLACES O.E.M. NO.	LENGTH	CENTER HOLE DIAM.	OUTSIDE HOLE DIAM.	CENTER TO CENTER	WIDTH	STEEL THICK.	APPLICATION
 15 - 10199	43160	16-17/64" 413.1mm	13/32" 10.3mm	5/16" 7.9mm	2-9/16"2-13/64"	56mm	.160" 4.1mm	
 15 - 10203	72972	17-53/64" 452.8mm	25/64" 9.9mm	17/64" 6.7mm	2-23/64"2-23/64"	59.9mm	.204" 5.2mm	
 15 - 10198	43484	18-3/32" 459.6mm	45/64" 17.9mm	5/16" 7.9mm	1-49/64"2-13/64"	56mm	.160" 4.1mm	
 15 - 10201	72231	18-49/64" 476.6mm	5/8" 15.9mm	5/16" 7.9mm	2-9/16"2-13/64"	56mm	.160" 4.1mm	
 15 - 10195	31461	20-13/64" 513.2mm	25/64" 9.9mm	17/64" 6.7mm	2-23/64"2-23/64"	59.9mm	.204" 5.2mm	
 15 - 10202	72258	20-11/16" 525.5mm	5/8" 15.9mm	5/16" 7.9mm	2-9/16"2-13/64"	56mm	.160" 4.1mm	
 15 - 10204	72292	21-23/32" 551.7mm	25/64" 9.9mm	17/64" 6.7mm	2-23/64"2-13/64"	56mm	.160" 4.1mm	

ROBERINE

 15 - 50140	59006601	24-1/2" 622.3mm	1-9/32" 32.5mm	.414" 10.5mm	3.154" 80.1mm	2.953" 75mm	.240" 6.1mm	Fits Park Models 100M, 102M & Villa.
--	----------	---------------------------	-------------------	-----------------	------------------	----------------	----------------	---

ROOF

 15 - 1053	2177	21" 533.4mm	3/4" 19.1mm	1/2" 12.7mm	3" 76.2mm	2-3/4" 69.9mm	.187" 4.8mm	
---	------	-----------------------	----------------	----------------	--------------	------------------	----------------	--

14/16



BLADES

BLADES



Blades for SABO



ORDER NO.	REPLACES O.E.M. NO.	LENGTH	CENTER HOLE DIAM.	OUTSIDE HOLE DIAM.	CENTER TO CENTER	WIDTH	STEEL THICK.	APPLICATION
 15 - 11317	527-220-000	20-1/8" 511.2mm	1.260" 31.8mm			3.70" 94.2mm	.117" 3.0mm	
 15 - 11316	450-203-000	20-1/4" 514.4mm	1.260" 31.8mm			3.70" 94.2mm	.095" 2.4mm	

SARLO

 15 - 6230	1511	20-5/8" 523.9mm	5/8" 15.9mm			2-1/4" 57.2mm	.182" 4.6mm	
 15 - 6228	1512	22" 558.8mm	5/8" 15.9mm			2-1/4" 57.2mm	.204" 5.2mm	
 15 - 6229	1517	22" 558.8mm	3/8" 9.5mm			2-1/2" 63.5mm	.187" 4.8mm	
 15 - 6231	1513	23-1/2" 569.9mm	5/8" 15.9mm			2-1/2" 63.5mm	.187" 4.8mm	
 15 - 6232	1516	25-11/16" 652.5mm	3/4" 19.1mm			2-3/4" 69.9mm	.187" 4.8mm	

14/16











BLADES



BLADES

Blades for SCAG



ORDER NO.	REPLACES O.E.M. NO.	LENGTH	CENTER HOLE DIAM.	OUTSIDE HOLE DIAM.	CENTER TO CENTER	WIDTH	STEEL THICK.	APPLICATION
 15 - 3403	482461	16-1/2" 419.1mm	5/8" 15.9mm			2-1/2" 63.5mm	.204" 5.2mm	(2) blades for 32" cut & (3) blades for 48" cut
	481706							
	48110							
 15 - 6009	481710	16-1/2" 419.1mm	5/8" 15.9mm			3" 76.2mm	.204" 5.2mm	(2) blades for 32" cut & (3) blades for 48" cut High Lift
	48184							
 15 - 6300	A48184	16-1/2" 419.1mm	5/8" 15.9mm			2-1/2" 63.5mm	.204" 5.2mm	Mulching Blade PATENTED
	A48110							
 15 - 3404	482878	18" 457.2mm	5/8" 15.9mm			2-1/2" 63.5mm	.204" 5.2mm	STD Lift (2) blades for 36" cut & (3) blades for 52" cut
	482462							
	481707							
	48108							
 15 - 3442	481711	18" 457.2mm	5/8" 15.9mm			3" 76.2mm	.204" 5.2mm	(2) blades for 36" cut & (3) blades for 52" cut High Lift
	48185							
 15 - 10173	48185	18" 457.2mm	5/8" 15.8mm			2-1/2" 63.5mm	.204" 5.2mm	Flat Blade Sharpened - 4-sides
 15 - 9229	482235	18" 457.2mm	5/8" 15.9mm			2-1/2" 63.5mm	.204" 5.2mm	Mulching Blade PATENTED
 15 - 6294	481707	18" 457.2mm	5/8" 15.9mm			2-1/2" 63.5mm	.204" 5.2mm	Mulching Blade PATENTED
	48185							
	48108							
 15 - 9968	48185	18" 457.2mm	5/8" 15.8mm			2" 50.8mm	.240" 6.1mm	Low-Lift Blade Sharpened - 4-sides
 15 - 6008	48109	20" 508mm	5/8" 15.9mm			2-1/2" 63.5mm	.204" 5.2mm	(2) blades for 40" cut

14/16









BLADES

BLADES



Blades for SCAG (continued)



ORDER NO.	REPLACES O.E.M. NO.	LENGTH	CENTER HOLE DIAM.	OUTSIDE HOLE DIAM.	CENTER TO CENTER	WIDTH	STEEL THICK.	APPLICATION
 15 - 3434	482879 481708 48111	21" 533.4mm	5/8" 15.9mm			2-1/2" 63.5mm	.204" 5.2mm	(3) blades for 61" cut
 15 - 6299	A48111	21" 533.4mm	5/8" 15.9mm			2-1/2" 63.5mm	.204" 5.2mm	Mulching Blade PATENTED
 15 - 9230	482237	21" 533.4mm	5/8" 15.9mm			2-1/2" 63.5mm	.204" 5.2mm	Mulching Blade PATENTED
 15 - 10930	481712	21" 533.4mm	5/8" 15.8mm			3" 76.2mm	.204" 5.2mm	(3) Blades for 61" cut. High Lift Blade.
 15 - 10174	A48111	21" 533.4mm	5/8" 15.8mm			2-1/2" 63.5mm	.204" 5.2mm	Flat Blade Sharpened - 4-sides
 15 - 9969	A48111	21" 533.4mm	5/8" 15.8mm			2" 50.8mm	.240" 6.1mm	Low-Lift Blade Sharpened - 4-sides
 15 - 6026	481709 48112	24-1/2" 622.3mm	5/8" 15.9mm			2-1/2" 63.5mm	.204" 5.2mm	(3) blades for 72" cut
 15 - 9883	48112	24-1/2" 622.3mm	5/8" 15.9mm			2-1/2" 63.5mm	.204" 5.2mm	Mulching Blade PATENTED

14/16

SEARS (See AYP-SEARS/ROPER)

BLADES

SENSATION (TRU-CUT)











 15 - 1076	123001	20-3/8" 517.5mm	3/8" 9.5mm	3/8" 9.5mm	2" 50.8mm	2-1/2" 63.5mm	.187" 4.8mm	
---	--------	---------------------------	----------------------	----------------------	---------------------	-------------------------	-----------------------	--



BLADES

**Blades for
SIMPLICITY / ALLIS CHALMERS**



ORDER NO.	REPLACES O.E.M. NO.	LENGTH	CENTER HOLE DIAM.	OUTSIDE HOLE DIAM.	CENTER TO CENTER	WIDTH	STEEL THICK.	APPLICATION
 15 - 1116	108297	11-9/16" 293.7mm	1-3/8" 34.9mm	3/8" 9.5mm	3-1/16" 77.8mm	2-1/2" 63.5mm	.150" 3.8mm	(3) blades for 32" cut
 15 - 1117	108501	13" 330.2mm	1-3/8" 34.9mm	3/8" 9.5mm	3-1/16" 77.8mm	2-1/2" 63.5mm	.150" 3.8mm	(3) blades for 36" cut Allis Chalmers 2087731
 15 - 2083	1656144	14-1/2" 368.3mm	3/4" 19.1mm	13/32" 10.3mm	3-1/16" 77.8mm	2" 50.8mm	.150" 3.8mm	(3) blades for 42" cut Left hand cut
 15 - 2081	1656147	15-5/16" 388.9mm	3/4" 19.1mm	13/32" 10.3mm	2-9/16" 65.1mm	2" 50.8mm	.150" 3.8mm	(3) blades for 42" cut Right hand cut
 15 - 10095	1704856	16-1/8" 409.6mm	3/4" 19.05mm			2" 50.8mm	.203" 5.15mm	Fits right side for 38" cut; LTH series. Also fits Allis-Chalmers. (3) for 44" cut
 15 - 10093	1704100	16-9/64" 409.97mm	3/4" 19.05mm		2-9/16" 65.1mm	2" 50.8mm	.203" 5.15mm	Fits small frame garden tractor 1989 & later. Also fits Allis-Chalmers. (3) for 44" cut.
 15 - 2082	1656143	16-11/16" 423.9mm	3/4" 19.1mm	13/32" 10.3mm	3-1/16" 77.8mm	2" 50.8mm	.150" 3.8mm	(3) blades for 48" cut Left hand cut
 15 - 10094	1726357 1726453A 1708229 1726453	18-9/64" 460.77mm	3/4" 19.05mm		2-9/16" 65.1mm	2" 50.8mm	.203" 5.15mm	Fits large frame tractors and Allis-Chalmers. Fits models 14-16 GT & 1700 series. (3) for 50" cut
 15 - 2079	1657589	18-1/2" 469.9mm	3/4" 19.1mm	13/32" 10.3mm	2-9/16" 65.1mm	2" 50.8mm	.187" 4.8mm	Takes (1) 15-2078 & (1) 15-2079 for 36" cut
 15 - 2078	1671565 1685172	18-1/2" 469.9mm	3/4" 19.1mm	13/32" 10.3mm	2-9/16" 65.1mm	2-1/2" 63.5mm	.187" 4.8mm	Takes (1) 15-2078 & (1) 15-2079 for 36" cut.
 15 - 10096	1704101	22-1/4" 565.2mm	3/4" 19.05mm			2" 50.8mm	.203" 5.15mm	Fits 38" cut. LTH and 1600 series. Also fits Allis-Chalmers. Left side blade.

14/16













BLADES

BLADES



**Blades for
SNAPPER**



ORDER NO.	REPLACES O.E.M. NO.	LENGTH	CENTER HOLE DIAM.	OUTSIDE HOLE DIAM.	CENTER TO CENTER	WIDTH	STEEL THICK.	APPLICATION
 15 - 7010	539-1032-74	14-7/8" 377.8mm	5/8" 15.8mm			2-1/2" 63.5mm	.204" 6.2mm	(3) blades for 42" cut. Fits Husqvarna, Yazoo/Kees commercial mowers.
 15 - 13481	1737228BZ	16-3/32" 408.8mm	.805" 20.4mm			2-1/2" 63.5mm	.204" 5.18mm	(3) blades for a 46" cut. Fits 46" Zero Turn mowers. Simplicity, Massey Ferg.
 15 - 1009	7017036 7076675	16-1/4" 412.8mm	5/8" 15.9mm	1/4" 6.4mm	1-5/8" 41.3mm	2-1/2" 63.5mm	.150" 3.8mm	(2) blades for 32" cut (3) blades for 48" cut
 15 - 6500	539-100-340	16-1/4" 412.8mm	5/8" 15.8mm			2-1/2" 63.5mm	.204" 5.2mm	(3) blades for 48" cut. Fits Husqvarna, Yazoo, Kees, commercial mowers.
 15 - 2172	7017036 7077378	16-1/4" 412.8mm	5/8" 15.9mm	11/32" 8.7mm	1-5/8" 41.3mm	2-1/2" 63.5mm	.240" 6.1mm	(Heavy Duty) (2) blades for 32" cut (3) blades for 48" cut
 15 - 10172	7077378	16-1/4" 412.8mm	5/8" 15.8mm			2-1/2" 63.5mm	.204" 5.2mm	Flat Blade Sharpened - 4-sides
 15 - 6296	483011 7076675 7077378	16-1/4" 412.8mm	5/8" 15.9mm			2-1/2" 63.5mm	.204" 5.2mm	Mulching Blade PATENTED
 15 - 9967	7077378	16-1/4" 412.8mm	5/8" 15.8mm			2" 50.8mm	.240" 6.1mm	Low-Lift Blade Sharpened - 4-sides
 15 - 6472	7029247	16-1/2" 419.1mm	5/8" 16mm			2-1/2" 63.5mm	.204" 5.2mm	Fits Yardcruiser model HZS 1848 2BVE homeowner model.
 15 - 6300	7017043	16-1/2" 419.7mm	5/8" 15.9mm			2-1/2" 63.5mm	.204" 5.2mm	Mulching Blade PATENTED
 15 - 2169	7019733	16-1/2" 419.1mm	3/8" 9.5mm			2-3/4" 69.9mm	.160" 4.1mm	(3) blades on LT48 Steel Deck
 15 - 6185	7079369	16-13/16" 427mm	1/2" 12.7mm			2-1/2" 63.5mm	.204" 5.2mm	(3) blades for 48" cut

14/16











BLADES



BLADES

**Blades for
SNAPPER (continued)**



ORDER NO.	REPLACES O.E.M. NO.	LENGTH	CENTER HOLE DIAM.	OUTSIDE HOLE DIAM.	CENTER TO CENTER	WIDTH	STEEL THICK.	APPLICATION
 15 - 6035	7079388	17" 431.8mm	1/2" 12.7mm			2-1/2" 63.5mm	.204" 5.2mm	48" deck For Snapper "ZERO TURN" machine Hi Lift Blade
 15 - 6426	7079388	17" 431.8mm	1/2" 12.7mm			2-1/2" 63.5mm	.204" 5.2mm	Mulching Blade PATENTED
 15 - 9968	7077344	18" 457.2mm	5/8" 15.8mm			2" 50.8mm	.240" 6.1mm	Low-Lift Blade Sharpened - 4-sides
 15 - 6294	7077344 7076450 363055 482462 7017037 7029246	18" 457.2mm	5/8" 15.9mm			2-1/2" 63.5mm	.204" 5.2mm	Mulching Blade PATENTED
 15 - 6014	7029246	18" 457.2mm	5/8" 15.9mm			2-1/2" 63.5mm	.204" 5.2mm	Fits Snapper Pro Series. (2) blades for 36" cut (3) blades for 52" cut
 15 - 1010	7017037 363055	18" 457.2mm	5/8" 15.9mm	1/4" 6.4mm	1-5/8" 41.3mm	2-1/2" 63.5mm	.150" 3.8mm	(2) blades for 36" cut
 15 - 2173	7017037 7077344	18" 457.2mm	5/8" 15.9mm			2-1/2" 63.5mm	.240" 6.1mm	(Heavy Duty) (2) blades for 36" cut (3) blades for 54" cut.
 15 - 10173	7077344	18" 457.2mm	5/8" 15.8mm			2-1/2" 63.5mm	.204" 5.2mm	Flat Blade Sharpened - 4-sides
 15 - 13482	1737252BZ	18-1/2" 469.9mm	.805" 20.4mm			2-1/2" 63.5mm	.204" 5.18mm	(3) blades for a 52" cut Fits 52" Zero Turn mowers. Simplicity, Massey Ferg.
 15 - 6197	7024466 7042998	19-41/64" 498.9mm	1" 25.4mm			2-1/4" 57.2mm	.204" 5.2mm	(2) blades for 38" cut front engine rider models LT1438H & Black Hawk model BH120G38A
 15 - 2007	7019795	20-11/16" 525.5mm	3/8" 9.5mm	3/8" 9.5mm	2-3/4" 69.9mm	2-3/4" 69.9mm	.160" 4.1mm	Uses 15-910 Air lifts Steel Deck

14/16













BLADES

BLADES



Blades for SNAPPER (continued)



ORDER NO.	REPLACES O.E.M. NO.	LENGTH	CENTER HOLE DIAM.	OUTSIDE HOLE DIAM.	CENTER TO CENTER	WIDTH	STEEL THICK.	APPLICATION
15 - 6110 	7017168	20-11/16"	3/8"	3/8"		2-3/4"	.160"	Mulcher blade for 21" Steel Decks
	7041939	525.5mm	9.5mm	9.5mm		69.9mm	4.1mm	
15 - 6317 	7019645	20-11/16"	3/8"	9.5mm		2-3/4"	.160"	Mulching Blade PATENTED
	7019795							
	7017168							
15 - 2006 	7017002	20-3/4"	3/8"	3/8"	2-3/4"	2-3/4"	.160"	Used on 21" & 41" Steel Deck
	7019702							
	7019645							
	7026691							
15 - 1087 	7018193	20-7/8"	7/8"			2-3/4"	.187"	V-series
		530.2mm	22.2mm			69.9mm	4.8mm	
15 - 6167 	7079222	21"	1/2"			2-1/2"	.240"	(Heavy Duty) (3) Blades for 61" cut Regular lift
		533.4mm	12.7mm			63.5mm	6.1mm	
15 - 6168 	7079222	21"	1/2"			2-1/2"	.240"	(Heavy Duty) (3) Blades for 61" cut High lift
		533.4mm	12.7mm			63.5mm	6.1mm	
15 - 9969 	101733	21"	5/8"			2"	.240"	Low-Lift Blade Sharpened - 4-sides
		533.4mm	15.8mm			50.8mm	6.1mm	
15 - 10174 	101733	21"	5/8"			2-1/2"	.204"	Flat Blade Sharpened - 4-sides
		533.4mm	15.8mm			63.5mm	5.2mm	
15 - 6277 	7026428	21	13/16"	3/8"	2-1/2"	2-1/4"	.134"	New 21" blade for Snapper walk behinds. For Platinum series mowers.
		533.4mm	20.6mm	9.5mm	63.5mm	57.2mm	3.4mm	
15 - 12852 	1731898	21-3/16"	.975			2-1/4"	.170"	Fits LT-200 series & Zero Turn 150Z series 42" cut.
		538.1mm	24.7mm			57.2mm	4.3mm	
15 - 11868 	7100851A	21-5/8"	13/32"	13/32"	1-7/8"	2-1/4"	.135"	3 in 1 blade
	1101823		549.3mm	10.3mm	10.3mm			
15 - 1103 	7019518	25"	1-1/16"	35/64"	7-1/2"	2-3/4"	.187"	New Style Uses the 3 bolt hole High air lift 15-1136
		635mm	27mm	13.9mm	190.5mm	69.9mm	4.8mm	











14/16

BLADES



**Blades for
SNAPPER (continued)**

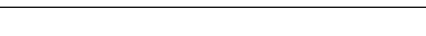

ORDER NO.	REPLACES O.E.M. NO.	LENGTH	CENTER HOLE DIAM.	OUTSIDE HOLE DIAM.	CENTER TO CENTER	WIDTH	STEEL THICK.	APPLICATION
 15 - 1091	7018068	26" 660.4mm	1-1/16" 27mm	35/64" 13.9mm	7-1/2" 190.5mm	2-3/4" 69.9mm	.187" 4.8mm	New Style Uses the 2 bolt hole Regular air lifts 15-1131
 15 - 6108	7016980	28" 711.2mm	1-1/16" 27mm	35/64" 13.9mm	7-1/2" 190.5mm	2-3/4" 69.9mm	.160" 4.1mm	Mulching blade For 28" rear engine riders
 15 - 1098	7019515	28" 711.2mm	1-1/16" 27mm	35/64" 13.9mm	7-1/2" 190.5mm	2-3/4" 69.9mm	.187" 4.8mm	New Style Uses the 3 bolt hole High air lifts 15-1136
 15 - 6302	7019515	28" 711.2mm	1-1/16" 27mm	35/64" 13.9mm	7-1/2" 190.5mm	2-3/4" 69.9mm	.187" 4.8mm	Mulching Blade PATENTED
 15 - 11238	7019515	28" 711.2mm	1-1/16" 27mm			2-3/4" 69.9mm	.187" 4.8mm	Blade without air lift holes.
 15 - 1092	7018069	30" 762mm	1-1/16" 27mm	35/64" 13.9mm	7-1/2" 190.5mm	2-3/4" 69.9mm	.187" 4.8mm	New Style Uses the 2 bolt hole Regular air lifts 15-1131
 15 - 6029	7018069	30" 762mm	1-1/16" 27mm	35/64" 13.9mm	7-1/2" 190.5mm	2-3/4" 69.9mm	.187" 4.8mm	No air lift holes New Style
 15 - 6297	7018069	30" 762mm	1-1/16" 27mm	35/64" 13.9mm	7-1/2" 190.5mm	2-3/4" 69.9mm	.187" 4.8mm	Mulching Blade PATENTED
 15 - 1089	7060332 7018038	30" 762mm	7/8" 22.2mm	35/64" 13.9mm	7-1/2" 190.5mm	2-3/4" 69.9mm	.187" 4.8mm	Old Style Will fit Dixon 30" rider (without bagger). Also uses 15-1131 Air Lifts
 15 - 11239	7019523	33" 838.2mm	1-1/16" 27mm			2-3/4" 69.9mm	.187" 4.8mm	Blade without air lift holes.
 15 - 6109	7016982	33" 838.2mm	1-1/16" 27mm	35/64" 13.9mm	7-1/2" 190.5mm	2-3/4" 69.9mm	.160" 4.1mm	Mulching blade For 33" rear engine riders
 15 - 1060	7019523	33" 838.2mm	1-1/16" 27mm	35/64" 13.9mm	7-1/2" 190.5mm	2-3/4" 69.9mm	.187" 4.8mm	New Style Uses the 3 bolt hole. High Air Lifts 15-1136

14/16

BLADES

BLADES



Blades for SNAPPER (continued)



ORDER NO.	REPLACES O.E.M. NO.	LENGTH	CENTER HOLE DIAM.	OUTSIDE HOLE DIAM.	CENTER TO CENTER	WIDTH	STEEL THICK.	APPLICATION
 15 - 6301	7019523	33"	1-1/16"	35/64"	7-1/2"	2-3/4"	.187"	Mulching Blade PATENTED
		838.2mm	27mm	13.9mm	190.5mm	69.9mm	4.8mm	

Drive Kit for SNAPPER



INCLUDES BLADE, DISC & BELT

Before 1991 Models

Size	Order No.
25" Kit	15 - 3529
26" Kit	15 - 3527
28" Kit	15 - 3528
30" Kit	15 - 3526
33" Kit	15 - 3524

After 1991 Models

Size	Order No.
25" Kit	15 - 9941
26" Kit	15 - 9942
28" Kit	15 - 9943
30" Kit	15 - 9938

Air Lifts for SNAPPER



Order No. 15 - 1131

Complete Air Lift Kit for Snapper. Used on **15-1088, 15-1089, 15-1091, 15-1092** and **15-1097** blades. Includes (4) 5/16"-24 x 3/4" screws, (4) 5/16" lock washers, (4) 5/16"-24 hex nut.

Order No. 15 - 1132

Air Lifts Only. Replaces Snapper 7031724.

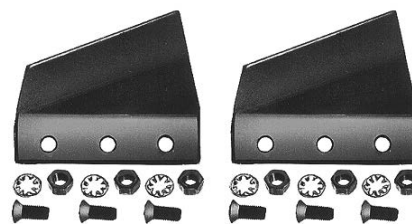

Order No. 15 - 1136

Complete Kit. Replaces Snapper 7060480. Used on **15-1060, 15-1098** and **15-1103** blades. Includes (6) 5/16"-24 x 3/4" screws, (6) 5/16" lock washers, (6) 5/16"-24 hex nut.

14/16

BLADES



BLADES

Air Lifts for SNAPPER

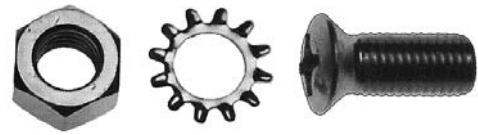
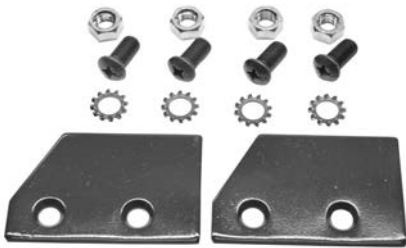



Order No. 15 - 909

Hardware Only. Includes (25) 5/16"-24 x 3/4" screws, (25) 5/16" lock washers, (25) 5/16"-24 hex nut for all of our Snapper Air Lifts. Replaces Snapper 7090228, 7090391 and 7090223. **Packaged 25 sets per bag.**

Order No. 15 - 910

Air Lift Kit. Replaces Snapper 7060785. Used with our **15-2007** Blade. Fits 21" walkbehinds.

Blades for STIGA (EXPORT ONLY)

ORDER NO.	REPLACES O.E.M. NO.	LENGTH	CENTER HOLE DIAM.	OUTSIDE HOLE DIAM.	CENTER TO CENTER	WIDTH	STEEL THICK.	APPLICATION
 15 - 50150	1111-9003-01	5-1/2" 139.70mm	5/16" 7.94mm			2" 50.80mm		Fits Stiga Kommun & Multiclip.
 15 - 14172	1134-5073-01 1134-9123-01	6-39/64" 168mm	21/64" 8.2mm					Fits Park Models 107M, Villa 92M, 107M.
 15 - 50027	1134-1452-01 Stiga Villa	12-1/4" 312mm	.397" 10.32mm	.335" 8.73mm	3.25" 82.55mm	2.0" 50.80mm	.150" 3.97mm	
 15 - 50247	1111-2759-01	12-11/16" 322.27mm	3/4" 19.05mm			1-9/16" 40.09mm	.095" 2.3mm	
 15 - 50007	1134-1903-00 Stiga Park	14-1/2" 370mm	.399" 10.32mm	.334" 8.73mm	3.24" 82.55mm	2.0" 50.80mm	.150" 3.97mm	
 15 - 50026	1134-0456-00 Stiga Villa	14-1/2" 370mm	.397" 10.32mm	.335" 8.73mm	3.25" 82.55mm	2.0" 50.80mm	.150" 3.97mm	
 15 - 50061	1134-2450-01	15" 382mm	13/32" 10.3mm	11/32" 8.5mm	3-9/32" 83.3mm	2" 50mm	.150" 4mm	Fits Park Models 100M, 102M & Villa.

14/16
BLADES

BLADES



Blades for STIGA (EXPORT ONLY)



ORDER NO.	REPLACES O.E.M. NO.	LENGTH	CENTER HOLE DIAM.	OUTSIDE HOLE DIAM.	CENTER TO CENTER	WIDTH	STEEL THICK.	APPLICATION
 15 - 50295	 1134-9124-01	16-11/16" 406.4mm	3 lobed			2.362" 60mm	.134" 3.4mm	Mulching Blade (Export Only)
 15 - 50030	1111-1530 Stiga Multiclip	18-1/8" 457mm	.385" 10.32mm	.326" 8.73mm	2.12" 53.98mm	2.0" 50.80mm	.134" 3.57mm	
 15 - 50296	 1134-9125-01	18-1/8" 465mm	3 lobed			2.52" 64mm	.134" 3.4mm	Mulching Blade (Export Only)
 15 - 50139	1111-2442-02 1111-9076-01	20-1/8" 511.2mm	.411" 10.4mm	.341" 8.7mm	2.135" 54.2mm	2" 50.8mm	.160" 4.1mm	
 15 - 10739	1111-9109-01	20-1/8" 511.2mm	.411" 10.4mm	.442" 11mm	2.135" 54.2mm	2" 50.8mm	.160" 4.1mm	Fits Stiga model Multiclip Pro 5/S
 15 - 50246	1111-2598-01	20-13/16" 528.64mm	13/32" 10.31mm	5/16" 8.33mm	2-1/8" 53.98mm	3-5/16" 84.14mm	.095" 2.3mm	



THATCHER HARDWARE



Order No. 14 - 2008

Thatcher hardware fits our 15-50071, 15-50072, 15-50107, 15-50109 blades. Contains replacement Springs and Hardware.

Blades for THATCHING

 15 - 50071		16" 406.40mm	3/8" 9.53mm					Includes our 14-2008 Thatcher Hardware.
 15 - 50109		16" 406.40mm	5/8" 15.88mm			2.25" 63.50mm	150" 3.97mm	Hardware Not Included Uses our 14-2008 Thatcher Hardware.

14/16









BLADES



BLADES

**Blades for
TORO/WHEEL HORSE**



ORDER NO.	REPLACES O.E.M. NO.	LENGTH	CENTER HOLE DIAM.	OUTSIDE HOLE DIAM.	CENTER TO CENTER	WIDTH	STEEL THICK.	APPLICATION
 15 - 6137	72-7690	10-1/2" 266.7mm	5/8" 15.9mm			2-1/2" 63.5mm	.134" 3.4mm	Fits 48" midsize recycler takes (1) 15-6137 (1) 15-6136 & (1) 15-6135 Center Blade
 15 - 2000	117192	13-7/8" 352.4mm	3/4" 19.1mm			2" 50.8mm	.187" 4.8mm	For 42" cut side discharge (set of 3 # 3-11620)
 15 - 1108	100200	14" 355.6mm	3/4" x 5/8"	1/4" 6.4mm	1-5/8" 41.3mm	2" 50.8mm	.187" 4.8mm	42" cut, WH set of (3) No. 3-6693. For side discharge models R1-426, 5-1000 thru 5-1001, 5-1010, 5-1011, 5-1421, thru 5-14 and 65-42 MSOL from 1966 - 1976
 15 - 6267	14-4879 79-2920	14-1/2" 368.3mm	3/4" 19.1mm			2-1/2" 63.5mm	.187" 4.8mm	(3) blades for 42" cut. Fits 42" cut "ZERO TURN" mower with 42" deck. Mulching blade.
 15 - 851	10610	14-1/2" 368.3mm	3/4" 19.1mm			2" 50.8mm	.204" 5.2mm	For 42" cut, Rear discharge WH set 106635
 15 - 1030	112-0302	14-13/16" 376.2mm	"H" Pattern	3/8" 9.5mm	2-1/2" 63.5mm	2-1/2" 63.5mm	.150" 3.8mm	Takes (1) 15-1030 & (2) 15-1029 for 46" cut. Mulching blade.
 15 - 3393	55-4940	15-1/2" 393.7mm	5/8" 15.9mm			2-1/2" 63.5mm	.187" 4.8mm	Fits Model 30144 44" Midsize Cutting Mower High Lift
 15 - 3441	54-0010	15-1/2" 393.7mm	5/8" 15.9mm			2-1/2" 63.5mm	.187" 4.8mm	(3) blades for 44" cut Deck 57358, Groundsmaster model 117 and 1144 rider tractor
 15 - 9885		54-0010 393.7mm	15-1/2" 15.9mm	5/8"		2-1/2" 63.5mm	.187" 4.8mm	Mulching Blade PATENTED

14/16













BLADES

BLADES



**Blades for
TORO/WHEEL HORSE (continued)**



ORDER NO.	REPLACES O.E.M. NO.	LENGTH	CENTER HOLE DIAM.	OUTSIDE HOLE DIAM.	CENTER TO CENTER	WIDTH	STEEL THICK.	APPLICATION
 15 - 6326	92-7952	15-1/2" 393.7mm	5/8" 15.9mm			2-1/2" 63.5mm	.187" 4.8mm	(3) blades for 44" cut Recycle Blade.
 15 - 2001	106637	16" 406.4mm	3/4" 19.1mm			2" 50.8mm	.187" 4.8mm	For 48" cut side discharge Wheel Horse set (3-10607)
 15 - 1029	112-0304	16-1/4" 412.8mm	"H" Pattern	3/8" 9.5mm	2-1/2" 63.5mm	2-1/2" 63.5mm	.150" 3.8mm	Takes (1) 15-1030 & (2) 15-1029 for 46" cut. Mulching blade.
 15 - 6187	93-0107 84-4370	17" 428.6mm	21/32" 16.7mm			2-1/2" 63.5mm	.187" 3.2mm	Fits 37" deck
 15 - 3372	113579	17" 431.8mm	5/8" 15.9mm			2" 50.8mm	.204" 5.2mm	(3) blades for 50" cut. Fits Wheel Horse 718Z & 724Z Also replaces Dixie Chopper 30227
 15 - 6224	113579	17" 431.8mm	5/8" 15.9mm			2-1/2" 63.5mm	.204" 5.2mm	(3) blades for 50" cut Toro "ZERO TURN" (Heavy Duty)
 15 - 6298	113579	17" 431.8mm	5/8" 15.9mm			2-1/2" 63.5mm	.204" 5.2mm	Mulching Blade PATENTED
 15 - 6013	113579	17" 431.8mm	5/8" 15.8mm			2" 50.8mm	.240" 6.1mm	Low-Lift Blade Sharpened - 4-sides
 15 - 12273	110-6837-03	17-1/2" 444.5mm	5/8" 15.9mm			2-1/4" 57.2mm	.170" 4.3mm	High Lift Blade. Fits model Timecutter Z (3) blades for a 50" cut.
 15 - 12362	112-9759-03 110-6837-03	17-1/2" 444.5mm	5/8" 15.9mm			2-1/4" 57.2mm	.187" 4.8mm	Commercial Mulcher Fits model Timecutter Z (3) blades for a 50" cut.
 15 - 3361	27-0990	18" 457.2mm	1/2" 12.7mm			2-1/2" 63.5mm	.187" 4.8mm	(3) blades for 52" cut Groundsmaster Std. Lift
 15 - 3405	56-2390	18" 457.2mm	1/2" 12.7mm			2-1/2" 63.5mm	.187" 4.8mm	(2) blades for 36" cut & (3) blades for 52" cut High Lift











14/16

BLADES



**Blades for
TORO/WHEEL HORSE (continued)**



ORDER NO.	REPLACES O.E.M. NO.	LENGTH	CENTER HOLE DIAM.	OUTSIDE HOLE DIAM.	CENTER TO CENTER	WIDTH	STEEL THICK.	APPLICATION
 15 - 3394	55-4210	18" 457.2mm	5/8" 15.9mm			2" 50.8mm	.187" 4.8mm	Fits model 30136 and 30152. For 36" and 52" cut. Midsize mowers
 15 - 10173	55-4210	18" 457.2mm	5/8" 15.8mm			2-1/2" 63.5mm	.204" 5.2mm	Flat Blade Sharpened - 4-sides
 15 - 6410	56-2390	18" 457.2mm	1/2" 12.7mm			2-1/2" 63.5mm	.187" 4.8mm	Mulching Blade PATENTED
 15 - 9968	55-4210	18" 457.2mm	5/8" 15.8mm			2" 50.8mm	.240" 6.1mm	Low-Lift Blade Sharpened - 4-sides
 15 - 3468	109918	18-3/4" 476.3mm	3/4" 19.1mm			2" 50.8mm	.204" 5.2mm	Takes (2) for 37" cut Wheel Horse Set 109079
 15 - 1011	8-5240	19" 482.6mm	7/16" 11.1mm			2-1/2" 63.5mm	.125" 3.2mm	New Toro Whirlwind and Guardian
 15 - 6184	79-3061 14-7799	19-1/4" 489mm	5/8" 15.9mm			2-1/2" 63.5mm	.187" 4.8mm	(2) blades for 38" cut "ZERO TURN" models 616 & 620 mulching blade
 15 - 3395	57-4700	19-5/16" 490.5mm	5/8" 15.9mm			2-1/2" 63.5mm	.187" 4.8mm	38" cut Fits 612, 616 and 620 ZT unit. Also fits 200 series side discharge
 15 - 6270	69-6920	20" 508mm	5/8" 15.9mm			2-1/2" 63.5mm	.240" 6.1mm	Fits Toro 580D mower. (11) blades for 16' deck Groundmaster
 15 - 6275	93-0241	20-1/4" 514.4mm	7/16" 11.1mm			2-1/2" 63.5mm	.134" 3.4mm	Fits 21" Toro recycler with 4.5 hp motor. Fits model 20444.
 15 - 9171	112947	20-1/2" 520.7mm	5/8" 15.8mm			2-1/2" 63.5mm	.204" 5.2mm	Fits Wheel Horse

14/16

BLADES

BLADES



**Blades for
TORO/WHEEL HORSE (continued)**



ORDER NO.	REPLACES O.E.M. NO.	LENGTH	CENTER HOLE DIAM.	OUTSIDE HOLE DIAM.	CENTER TO CENTER	WIDTH	STEEL THICK.	APPLICATION
 15 - 10667	103-2530	20-1/2" 520.7mm	5/8" 15.9mm			2-1/2" 63.5mm	.204" 5.2mm	Notched High Lift blade. (3) blades for a 60" cut. Fits Ground Master
 15 - 10175		20-1/2" 520.7mm	5/8" 15.8mm			2-1/2" 63.5mm	.204" 5.2mm	Flat Blade Sharpened - 4-sides
 15 - 6194		20-1/2" 520.7mm	5/8" 15.8mm			2" 50.8mm	.240" 6.1mm	Low-Lift Blade Sharpened - 4-sides
 15 - 10928	93-4106-03 108-3762-03	20-27/32" 531mm	7/16" 11mm	3/8" 9.5mm	2-7/16" 61.9mm	2-1/4" 57.2mm	.150" 3.8mm	Fits 21" Recycler Walkbehind mower.
 15 - 6256	91-2256-03 14-9419 75-9420	20-15/16" 531.9mm	7/16" 11.1mm	3/8" 9.5mm	2-7/16" 61.9mm	2-9/16" 65.1mm	.134" 3.4mm	Blade only Fits Toro 21" Recycler without saddle
 15 - 6465	80-0510-03							Blade stiffener. Used with our 15-6256 Blade.
 15 - 13260	108-0954-03	21" 533.4mm	7/16" 11.1mm			2-1/4" 57.2mm	.150" 4mm	Replaces Toro Atomic Bld. Mulching Blade Patented.
 15 - 6308	75-9420	21" 533.4mm	7/16" 11.1mm	3/8" 9.5mm	2-7/16" 61.9mm	2-1/2" 63.5mm	.160" 3.8mm	Mulching Blade PATENTED
 15 - 1006	20-2720	21" 533.4mm	7/16" 11.1mm			2-5/8" 66.7mm	.125" 3.2mm	Guardian
 15 - 1012	8-5230	21" 533.4mm	7/16" 11.1mm			2-5/8" 66.7mm	.125" 3.2mm	New Toro Whirlwind
 15 - 1008	26-0880 42-1000	21" 533.4mm	7/16" 11.1mm	3/8" 9.5mm	2-7/16" 61.9mm	2-5/8" 66.7mm	.125" 3.2mm	Toro rear bagger and Grassmaster
 15 - 6002	62-7700	21-1/16" 534.99mm	7/16" 11.1mm	3/8" 9.5mm	2-7/16" 61.9mm	2-3/4" 69.9mm	.134" 3.4mm	Vac-U Deck For 21" Rear Bagger model 26622











14/16

BLADES



**Blades for
TORO/WHEEL HORSE (continued)**



ORDER NO.	REPLACES O.E.M. NO.	LENGTH	CENTER HOLE DIAM.	OUTSIDE HOLE DIAM.	CENTER TO CENTER	WIDTH	STEEL THICK.	APPLICATION
 15 - 6251	44-6250	21-1/2" 546.1mm	1/2" 12.7mm			2-1/2" 63.5mm	.187" 4.8mm	(3) blades for 62" cut Fits Toro 62" cut Groundmaster
 15 - 10209	55-4210	21-1/2" 546.1mm	1/2" 12.7mm			2-1/2" 63.5mm	.204" 4.8mm	Flat Blade Sharpened - 4-sides
 15 - 13129	110-1857-03 110-6568-03 106-8744-03 106-2247-03	21-5/8" 549.2mm	5/8" 15.9mm			2-1/4" 57.2mm	.160" 4.1mm	(2) blades for a 42" cut. Mulching Blade. PATENTED
 15 - 11821	106-2247-03	21.675" 550.5mm	5/8" 15.8mm			2-1/4" 57.2mm	.160" 4.1mm	Fits model Time Cutter Z Standard Blade (2) blades for a 42" cut.
 15 - 10929	104-8697-03 108-9764-03	21-23/32" 551.7mm	7/16" 11mm			2-1/4" 57.2mm	.150" 3.8mm	Fits 22" Recycler Walkbehind mower.
 15 - 12649	108-9764-03	21-23/32" 551.6mm	7/16" 11.1mm			2-1/4" 57.2mm	.150" 3.8mm	Fits 22" Recycler Mulching Blade. PATENTED
 15 - 6135	72-7740	23" 584.2mm	5/8" 15.9mm			2-1/2" 63.5mm	.187" 4.8mm	Fits 48" midsize recycler Takes (1) 15-6135 , (1) 15-6136 and (1) 15-6137 Right hand blade (RH cut)
 15 - 6136	72-7730	23" 584.2mm	5/8" 15.9mm			2-1/2" 63.5mm	.187" 4.8mm	Fits 48" midsize recycler Takes (1) 15-6136 , (1) 15-6135 and (1) 15-6137 Left hand blade (LH cut)
 15 - 9986	94-1861	24-3/4" 628.7mm	1/2" 12.7mm			2-1/2" 63.5mm	.204" 5.2mm	(3) blades for 72" cut. Fits 72" Grounds Master.
 15 - 3362	29-5530	25" 635mm	3/4" 19.1mm			2-1/2" 63.5mm	.240" 6.1mm	(3) for 72" cut Groundsmaster Left hand cut

14/16





BLADES

BLADES





**Blades for
TORO/WHEEL HORSE (continued)**



ORDER NO.	REPLACES O.E.M. NO.	LENGTH	CENTER HOLE DIAM.	OUTSIDE HOLE DIAM.	CENTER TO CENTER	WIDTH	STEEL THICK.	APPLICATION
 15 - 6271	85-6040	25-3/16" 639.8mm	1/2" 12.7mm			2-1/2" 63.5mm	.240" 6.1mm	72" recycler deck blade. Used on Groundmaster models 322D, 322, 325D, 325.
 15 - 6001	67-0200	25-7/32" 640.6mm	5/8" 15.9mm			2-1/2" 63.5mm	.187" 4.8mm	
 15 - 2171	33-4750	31-3/8" 796.9mm	5/8" 15.9mm			2-1/2" 63.5mm	.187" 4.8mm	High Lift
 15 - 6118	80-4430	31-3/8" 796.9mm	5/8" 15.9mm			2-1/2" 63.5mm	.187" 4.8mm	Mulching blade for 32" rear engine rider.

TRAILMATE / ARIENS / GRAVELY

 15 - 6258	16584	21-1/2" 546.1mm	1" 25.4mm	7/16" 11.1mm	2-1/2" 63.5mm	2-1/2" 63.5mm	.187" 4.8mm	Fits 22" cut high wheel mowers. (Straight Blade) with lift.
 15 - 6259	525GCS/16587	24-1/8" 612.8mm	1" 25.4mm	7/16" 11.1mm	2-1/2" 63.5mm	2-1/2" 63.5mm	.187" 4.8mm	Fits 25" cut high wheel mowers. (Formed Blade)
 15 - 6257	16588	24-1/2" 622.3mm	1" 25.4mm	7/16" 11.1mm	2-1/2" 63.5mm	2-1/2" 63.5mm	.187" 4.8mm	Fits 25" cut high wheel mowers. (Straight Blade) with lift.









14/16

BLADES



**Blades for
WALKER**



ORDER NO.	REPLACES O.E.M. NO.	LENGTH	CENTER HOLE DIAM.	OUTSIDE HOLE DIAM.	CENTER TO CENTER	WIDTH	STEEL THICK.	APPLICATION
 15 - 3423	5705-0	20" 508mm	5/8" 15.9mm	3/16" 4.8mm	3" 76.2mm	2-3/4" 69.9mm	.160" 4.1mm	Uses (3) blades for 54" side discharge Right hand
 15 - 6176	5705-10	21" 533.4mm	5/8" 15.9mm	7/32"	3" 76.2mm	2-3/4" 69.9mm	.160" 4.1mm	(2) 15-6176 or (2) 15-6177 for 42" cut Mulcher Lower blade.
 15 - 6177	5705-11	21-15/16" 533.4mm	5/8" 15.9mm	7/32"	3" 76.2mm	2-3/4" 69.9mm	.160" 4.1mm	(3) 15-6177 or (3) 15-3446 for 62" Mulcher cut (2) 15-6176 & (2) 15-6177 for 42" cut. Milled bottom Mulcher, Upper blade
 15 - 3445	5705-4	22" 558.8mm	5/8" 15.9mm	3/16" 4.8mm	3" 76.2mm	2-3/4" 69.9mm	.187" 4.8mm	(1) 15-3445 & (1) 15-3446 (G.H.S.) Grass Handling System. Fits 42" cut rear discharge Left hand
 15 - 3446	5705-3	22" 558.8mm	5/8" 15.9mm	3/16" 4.8mm	3" 76.2mm	2-3/4" 69.9mm	.187" 4.8mm	(3) 15-6177 or (3) 15-3446 for 62" mulcher cut. Fits 42" cut. Rear and side discharge Right hand. (3) blades for 62"
 15 - 6414	5705-3	22" 558.8mm	5/8" 15.9mm	3/16" 4.8mm	3" 76.2mm	2-3/4" 69.9mm	.160" 4.1mm	Mulching Blade PATENTED
 15 - 6169	7705-2	25-1/16" 636.6mm	5/8" 15.9mm	7/32" 5.6mm	3" 76.2mm	2-3/4" 69.9mm	.160" 4.1mm	(1) 15-6169 & (1) 15-6170 for 48" cut Left hand cut
 15 - 6170	7705-1	25-1/16" 636.6mm	5/8" 15.9mm	7/32" 5.6mm	3" 76.2mm	2-3/4" 69.9mm	.160" 4.1mm	(1) 15-6169 & (1) 15-6170 for 48" cut Right hand cut

14/16



BLADES

BLADES



Blades for WIKOV-SLAVIA





ORDER NO.	REPLACES O.E.M. NO.	LENGTH	CENTER HOLE DIAM.	OUTSIDE HOLE DIAM.	CENTER TO CENTER	WIDTH	STEEL THICK.	APPLICATION
 15 - 50241	DO226	20-9/16" 522.28mm	25/64" 9.92mm	9/32" 7.14mm	2-29/32" 73.81mm	2-3/16" 55.56mm	.160" 4.00mm	Rear discharge blade- (1) 50241 & (1) 50241 makes a set. Left hand.
 15 - 50245	DO225	20-9/16" 522.28mm	25/64" 9.92mm	9.32" 7.14mm	2-29/32" 73.81mm	2-3/16" 55.56mm	.160" 4.00mm	Rear discharge blade- (1) 50241 & (1) 50241 makes a set. Right hand.

WEED BLASTER

 27 - 9035	MIN003	4" 101.6mm	31/64" 12.3mm					Steel inserted plastic blade. Fits Grasscraft GC1601 & Allen SE1601.
---	--------	----------------------	-------------------------	--	--	--	--	--

WOLF

 15 - 50122	171046	18-1/8" 460mm	1.278" 32.54mm	.21" 5.56mm	1.92" 48.82mm		.095" 2.77mm	
 15 - 50121	171051	19-31/32" 507.2mm	1.278" 32.54mm	.21" 5.56mm	1.92" 48.82mm	3" 76.20mm	.095" 2.77mm	

14/16











BLADES WHEEL HORSE (see TORO/WHEEL HORSE)

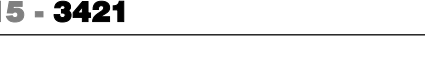

BLADES

**Blades for
WOODS**



ORDER NO.	REPLACES O.E.M. NO.	LENGTH	CENTER HOLE DIAM.	OUTSIDE HOLE DIAM.	CENTER TO CENTER	WIDTH	STEEL THICK.	APPLICATION
 15 - 3377	70014	15" 381mm	1/2" 12.7mm			2" 50.8mm	.204" 5.2mm	(3) blades for 44" cut Standard Lift
 15 - 3378	70062	15" 381mm	1/2" 12.7mm			2" 50.8mm	.204" 5.2mm	(3) blades for 44" cut High Lift
 15 - 3379	70104	18" 457.2mm	1/2" 12.7mm			2" 50.8mm	.204" 5.2mm	(3) blades for 52" cut Standard Lift
 15 - 6309		18" 457.2mm	1/2" 12.7mm			2-1/2" 63.5mm	.204" 5.2mm	Mulching Blade PATENTED
 15 - 3380	70117	18" 457.2mm	1/2" 12.7mm			2" 50.8mm	.204" 5.2mm	(3) blades for 52" cut High Lift
 15 - 3421	23825	20-5/32" 512mm	5/8" 15.9mm			2" 50.8mm	.204" 5.2mm	(3) blades for 60" cut For models RM-59 & L-59 Left hand cut (ccw)
 15 - 6467	6950	20-3/16" 512.7mm	5/8" 15.8mm			2" 50.8mm	.204" 5.2mm	(3) blades for 60" cut. Fits model 59C2. Medium Lift.
 15 - 6432	31359	20-1/4" 514.4mm	5/8" 15.9mm			2" 50.8mm	.204" 5.2mm	(3) blades for 60" cut. Fits models RM59, RM500, L59 & F35. High Lift Blade. Left hand cut.
 15 - 6433	34615	20-11/16" 525.5mm	5/8" 15.9mm			2-1/2" 63.5mm	.240" 6.1mm	(3) blades for 60" cut. Fits new Tunnel Deck. Models RM360 & RM550. High lift. Right hand cut.
 15 - 3424	70142	21" 533.4mm	1/2" 12.7mm			2" 50.8mm	.204" 5.2mm	(3) blades for 61" cut High Lift
 15 - 6167	70134	21" 533.4mm	1/2" 12.7mm			2-1/2" 63.5mm	.240" 6.1mm	(Heavy Duty) (3) blades for 61" cut Regular Lift

14/16





BLADES

BLADES





**Blades for
WOODS (continued)**



ORDER NO.	REPLACES O.E.M. NO.	LENGTH	CENTER HOLE DIAM.	OUTSIDE HOLE DIAM.	CENTER TO CENTER	WIDTH	STEEL THICK.	APPLICATION
 15 - 6168	70142	21" 533.4mm	1/2" 12.7mm			2-1/2" 63.5mm	.240" 6.1mm	(Heavy Duty) (3) blades for 61" cut High Lift
 15 - 6311		21" 533.4mm	1/2" 12.7mm			2-1/2" 63.5mm	.204" 5.2mm	Mulching Blade PATENTED
 15 - 6210	13404 31306	24-1/2" 622.3mm	1" 25.4mm			2-1/2" 63.5mm	.204" 5.2mm	Left hand cut (3) blades for 72" cut. Fits models L306, RM306, RM600
 15 - 6434	15127	24-11/16" 635mm	5/8" 22.2mm			2-1/2" 63.5mm	.240" 6.1mm	(3) blades for 72" cut. Fits new Tunnel Deck. Models RM372 & RM660. High lift.

WORLDLAWN

 15 - 13975	4801401	16-1/2" 419.1mm	5/8" 15.8mm			2-1/2" 63.5mm	.204" 5.2mm	(3) blades for a 48" cut.
 15 - 13976	3602005	17-7/8" 454mm	5/8" 15.8mm			2-1/2" 63.5mm	.204" 5.2mm	(3) blades for a 52" cut. (2) blades for a 36" cut.
 15 - 13977	6001004	20-1/2" 520.7mm	5/8" 15.8mm			2-1/2" 63.5mm	.204" 5.2mm	(3) blades for a 60" cut.



14/16

BLADES



**Blades for
YAZOO**



ORDER NO.	REPLACES O.E.M. NO.	LENGTH	CENTER HOLE DIAM.	OUTSIDE HOLE DIAM.	CENTER TO CENTER	WIDTH	STEEL THICK.	APPLICATION
 15 - 824	206-760	20-7/8" 530.2mm	1-1/4" x 3/4"	5/16" 7.9mm	3" 76.2mm	2-1/4" 57.2mm	.240" 6.1mm	(3) blades for 60" cut Left hand cut
 15 - 6284	206-660	20-3/4" 527.1mm	1-1/4" x 3/4"			2-1/4" 57.2mm	.240" 6.1mm	(3) blades for 60" cut Right hand cut
 15 - 9176	206-622	22" 558.8mm	1-1/4" x 3/4"		57.2mm 6.1mm	2-1/4"	.240"	Fits 22" walkbehind.

BLADES



Blades for VIKING



ORDER NO.	REPLACES O.E.M. NO.	LENGTH	CENTER HOLE DIAM.	OUTSIDE HOLE DIAM.	CENTER TO CENTER	WIDTH	STEEL THICK.	APPLICATION
 15 - 6195	6109-004-1006	17-3/8" 441.3mm	3/8" 9.5mm			2-1/4" 57.2mm	.187" 4.8mm	(3) blades for 50" cut front engine lawn tractor
 15 - 6123	6109-004-2127	18" 457.2mm	5 point star			2-1/4" 57.2mm	.150" 3.8mm	(2) blades for 36" cut
 15 - 6120	6109-004-1002	18-1/4" 462mm	3/8" 9.5mm			2-1/4" 57.2mm	.187" 4.8mm	(2) blades for 36" cut
 15 - 6105	6109-004-1001	19-1/4" 489mm	3/8" 9.5mm			2-1/4" 57.2mm	.187" 4.8mm	(2) blades for 38" cut
 15 - 6099	309070 303065	20-1/4" 514.4mm	3/8" 9.5mm			2-3/4" 69.9mm	.134" 3.4mm	Fits model A4016-030 (2) blades for 40" cut
 15 - 6125	6109-004-2012	21" 533.4mm	5 point star			2-1/4" 57.2mm	.150" 3.8mm	(2) blades for 42" cut
 15 - 6468	325751	29-7/8" 758.8mm	2-1/2" 63.5mm	.390x.940"	2.708" 68.3mm	2-3/4" .69.9mm	.187" 4.8mm	

14/16

BLADES



**Air Lifts for
SNAPPER**
(Made In U.S.A.)



Order No. 15 - 1131

Complete Air Lift Kit for Snapper. Used on our **15-1088, 15-1089, 15-1091, 15-1092** and **15-1097** blades. Includes (4) 5/16"-24 x 3/4" screws, (4) 5/16" lock washers, (4) 5/16"-24 hex nut.



Order No. 15 - 1132

Air Lifts Only. Replaces Snapper 31724.

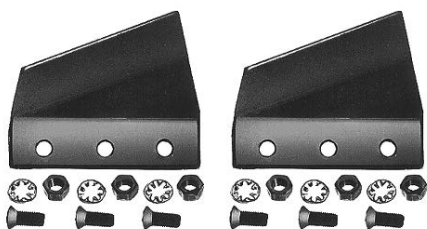

Order No. 15 - 1136

Complete Kit. Replaces Snapper 60480. Used on our **15-1060, 15-1098** and **15-1103** blades. Includes (6) 5/16"-24 x 3/4" screws, (6) 5/16" lock washers, (6) 5/16"-24 hex nut.

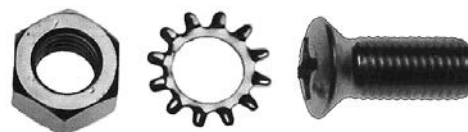

Order No. 15 - 909

Hardware Only. Includes (25) 5/16"-24 x 3/4" screws, (25) 5/16" lock washers, (25) 5/16"-24 hex nut for all our Snapper Air Lifts. Replaces Snapper 90228, 90391 and 90223. **Packaged 25 sets per bag.**



Order No. 15 - 910

Air Lift Kit. Replaces Snapper 7060785. Used with our **15-2007** Blade. Fits 21" walkbehinds.

**Air Lifts for
ARIENS**



Order No. 15 - 911

Complete Kit. Replaces Ariens 527011. Used on our **15-1096, 15-3323, 15-3324** and **15-2137** blades. Includes (4) 5/16"-24 x 3/4" hex screws, (4) 5/16"-24 top lock nut.













BLADES

EDGER BLADES

(Edger Blades are measured end to end)



ORDER NO.	REPLACES O.E.M. NO.	LENGTH	CENTER HOLE DIAM.	WIDTH	STEEL THICK.	DESCRIPTION/APPLICATION
 16 - 6764	82-010	6-3/16" 157.2mm	1/2" 12.7mm	1-1/2" 38.1mm	.095" 2.4mm	Replaces Black & Decker 82-010. Fits electric edgers
 16 - 2662	902343 701557	7" 177.8mm	9/16" D 14.3mm	1-1/2" 38.1mm	.095" 2.4mm	Replaces Weed Eater 701557
 16 - 6762	534205300	7-1/2" 190.5mm	1/4" 6.3mm	1-3/4" 44.5mm	.095" 2.4mm	(2) 1/4" mounting holes replaces Paramount 534205300. Fits electric edgers
 16 - 10962		7-1/2" 190.5mm	1/2" 12.7mm	1-1/2" 38.1mm	.095" 2.4mm	Unsharpened. Fits Black & Decker.
 16 - 6172	82-024	7-17/32" 191.3mm	7/16" 11.1mm	1-1/2" 38.1mm	.095" 2.4mm	Unsharpened. Fits Black & Decker 82-024
 16 - 2663	237001	7-11/16" 195.3mm	1" 25.4mm	2" 50.8mm	.095" 2.4mm	Echo 696015-52631 Fits Echo model PE2400 Replaces Green Machine 237001. Fits Edger Tool 2851, Shindaiwa Model LE-20 Also available in 50 per box.
 16 - 10712	237001	7-11/16" 195.3mm	1" 25.4mm	2" 50.8mm	.095" 2.4mm	Echo 696015-52631 Fits Echo model PE2400 Replaces Green Machine 237001. Fits Edger Tool 2851, Shindaiwa Model LE-20 Also available in 50 per box. Rust Resistant, oiled finish.
 16 - 6107	840084 216062	7-11/16" 195.3mm	1" 25.4mm	2" 50.8mm	.125" 3.2mm	Fits Maruyama Trimmer/Edger, Green Machine & Echo Trimmer/ Edger & Stihl FC 72 Trimmer. Stihl 4133-713-4101, Echo 720-237-001, Maruyama 216062 and Ryobi 613223 Also available in 50 per box.
 16 - 6477	840084 216062	7-11/16" 195.3mm	1" 25.4mm	2" 50.8mm	.125" 3.2mm	Fits Maruyama Trimmer/Edger Green Machine & Echo Trimmer/ Edger & Stihl FC 72 trimmer. Stihl 4133-713-4101, Echo 720-237-001, Maruyama 216062 and Ryobi 613223. (NHT) Pro Series Also available in 50 per box. Rust Resistant, oiled finish.
 16 - 10662	840084 216062	7-11/16" 195.3mm	1" 25.4mm	2" 50.8mm	.125" 3.2mm	Fits Maruyama Trimmer/Edger Green Machine & Echo Trimmer/ Edger & Stihl FC 72 trimmer. Stihl 4133-713-4101, Echo 720-237-001, Maruyama 216062 and Ryobi 613223. Also available in 50 per box Rust Resistant, oiled finish.

14/16

BLADES













BLADES



EDGER BLADES

(Edger Blades are measured end to end)



ORDER NO.	REPLACES O.E.M. NO.	LENGTH	CENTER HOLE DIAM.	WIDTH	STEEL THICK.	DESCRIPTION/APPLICATION
16 - 6276 	237001	8" 203.2mm	1" 25.4mm		.095" 2.4mm	Fits Green Machine and Edger Tool. Also fits Echo model PE2400 and Shindaiwa model LE-20
16 - 9886 	530-402-864	8-1/4" 209.6mm	3/4" 19mm	2-3/4" 69.9mm	.095" 2.4mm	Replacement for Poulan-Weedeater.
16 - 6788 	530095086	8-1/2" 215.9mm	9/16" "D" 14.3mm	1-1/2" 38.1mm	.120" 3.17mm	Replaces Weedeater 530095086. Fits gas powered edgers.
16 - 2672 	----	8-9/16" 217.5mm	1/2" 12.7mm	2" 50.8mm	.095" 2.4mm	Unsharpened
16 - 1145 	2059-HD	8-3/4" 222.3mm	1/2" 12.7mm	2-1/4" 57.2mm	.150" 3.8mm	Fits Lawn-Boy and McLane 2059-HD
16 - 6261 	03842	8-3/4" 222.3mm	1" 25.4mm	2" 50.8mm	.095" 2.4mm	Fits Homelite model E200 & PSE300 stick edger
16 - 1137 	----	9" 228.6mm	3/8" 9.5mm	2" 38.1mm	.117" 3mm	Tapered, Sharpened 4 sides
16 - 1141 	----	9" 228.6mm	3/8" D 9.5mm	1-1/2" 38.1mm	.117" 3mm	Replaces K&S Edger blades
16 - 1140 	----	9" 228.6mm	41/64" x 3/8" 16.3mmx9.5mm	2" 50.8mm	.095" 2.4mm	Replaces Cooper edger blades Double D hole
16 - 1138 	----	9" 228.6mm	1/2" 12.7mm	2" 50.8mm	.117" 3mm	Tapered, Sharpened 4 sides Also available in 50 per box.
16 - 2671 	----	9" 228.6mm	1/2" 12.7mm	2" 50.8mm	.095" 2.4mm	Unsharpened Also available in 50 per box.
16 - 1149 	----	9" 228.6mm	1/2"x29/64" 12.7mmx11.5mm	2" 50.8mm	.117" 3mm	Square-round center hole

14/16











BLADES



EDGER BLADES

(Edger Blades are measured end to end)



ORDER NO.	REPLACES O.E.M. NO.	LENGTH	CENTER HOLE DIAM.	WIDTH	STEEL THICK.	DESCRIPTION/APPLICATION
 16 - 1139	----	9" 228.6mm	5/8" 15.9mm	2" 50.8mm	.117" 3mm	Tapered, Sharpened 4 sides Also available in 50 per box.
 16 - 2148	781-0080	9-1/4" 235mm	5/8" 15.9mm	2-1/2" 63.5mm	.095" 2.4mm	Trail mate/Cooper blade. Replaces MTD 781-0080
 16 - 1151	----	9-13/16" 249.2mm	5/8" D 15.9mm	2-1/4" 57.2mm	.150" 3.8mm	Replacement for Whipper Clipper, Trail mate
 16 - 1143	----	10" 254mm	1/2" 12.7mm	2" 50.8mm	.125" 3.2mm	Tapered, Sharpened 4 sides Also available in 50 per box.
 16 - 2670	----	10" 254mm	1/2" 12.7m	2" 50.8mm	.125" 3.2mm	Unsharpened Also available in 50 per box.
 16 - 2673	2059-HD-10	10" 254mm	1/2" 12.7mm	2" 50.8mm	.150" 3.8mm	Used on commercial edgers. Sharpened 4 sides. Fits McLane 2059-HD-10 Also available in 50 per box.
 16 - 1148	----	10" 254mm	1/2" 12.7mm	2" 50.8mm	.117" 2.8mm	Fits Little Wonder Sharpened 4 sides Also available in 50 per box.
 16 - 1150	----	10" 254mm	1/2" x 29/64" 12.7mmx11.5mm	2" 50.8mm	.125" 3.2mm	Square-round center hole
 16 - 1144	----	10" 254mm	5/8" 15.9mm	2" 50.8mm	.125" 3.2mm	Tapered, Sharpened 4 sides Also available in 50 per box.
 16 - 2668	----	12-1/16" 306.4mm	1/2" 12.7mm	2" 50.8mm	.125" 3.2mm	Square, Sharpened 4 sides
 16 - 2669	----	12-1/8" 308mm	1/2" 12.7mm	2" 50.8mm	.125" 3.2mm	Unsharpened

14/16 BLADES

BLADES



STAR EDGER BLADES



Order No. 16 - 1147

Star Edger Blade 9" (228.6 mm) diameter, 1/2" (12.70 mm) center hole.

Order No. 16 - 2147

Star Edger Blade 9" (228.6 mm) diameter, 5/8" (15.88 mm) center hole.



Order No. 16 - 2658

9" (228.6 mm) X 1/2" (12.70 mm) Star Edger Blade.

Order No. 16 - 2661

9" (228.60 mm) X 5/8" (15.88 mm) Star Edger Blade. Replaces Trailmate 11250.

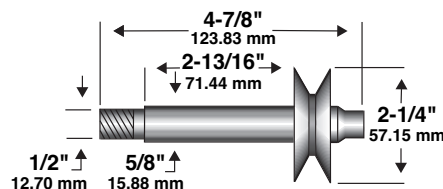

Order No. 16 - 1248

5/8" (15.88 mm) X 4-7/8" (123.8 mm) shaft with a 2-1/4" pulley. Replaces McLane 2033.

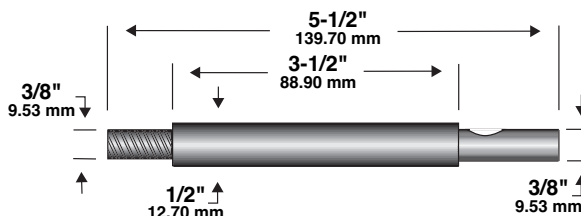

Order No. 16 - 1252

Replaces Trim-All 3/8" (9.5 mm) UNF - Overall Length: 5-1/2" (139.70 mm).

14/16

Edger Shaft for POWER TRIM

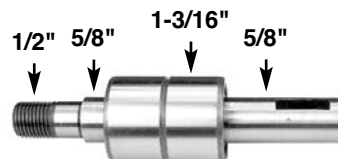

Order No. 16 - 9335

Edger shaft assembly replaces Power Trim 304. Assembly includes edger shaft, bearing. Length 4-1/2.

BLADES



Grass/Brushcutter Blades



Order No.	No. Teeth	Diameter In./MM	Bore In./MM	Thickness
27 - 4413	3	10"/254mm	1"/25mm	1.8mm
27 - 9741	3	10"/254mm	1"/25mm	3.0mm
27 - 13449	3	10"/254mm	1"/25mm	2.25mm
27 - 4414 *	3	12"/305mm	1"/20mm	2.25mm
27 - 9743	3	12"/305mm	1"/25mm	3.0mm
27 - 7854 *	4	8"/203mm	1"/25mm *	1.5mm
27 - 7855 *	4	9"/229mm	1"/25mm *	1.8mm
27 - 4280	4	10"/254mm	1"/25mm	1.8mm
27 - 4279	8	10"/254mm	1"/25mm	1.8mm
27 - 7862 *	8	8"/203mm	1"/25mm *	1.5mm
27 - 7863 *	8	9"/229mm	1"/25mm *	1.8mm
27 - 4278	80	10"/254mm	1"/25mm	1.8mm
27 - 4400	80	9"/229mm	1"/25mm	1.8mm
27 - 4405	80	9"/229mm	.750"/19mm	1.8mm
27 - 5957	80	8"/203mm	1"/25mm	1.8mm
27 - 5959	80	8"/203mm	.790"/20mm	1.8mm

*Includes reducer bushing 3/4"/20mm

**Grass/Brushcutter Blades
Professional Cutting Blades**



MAXI



MAXI



EIA

Order No.	No. Teeth	Diameter In./MM	Bore In./MM	Thickness
Maxi Series				
27 - 7857	24	9"/229mm	1"/25mm	1.8mm
27 - 8389	22	8"/203mm	.790"/20mm	1.5mm
EIA Series				
27 - 8458	22	8"/203mm	.790"/20mm	1.5mm
27 - 8459	22	8"/203mm	1"/25mm	1.5mm
27 - 8460	24	9"/229mm	.790"/20mm	1.8mm
27 - 8461	24	9"/229mm	1"/25mm	1.8mm

**Reducer Bushing for
Brushcutter Blades**



ID 20mm
OD 25mm

Order No. 27 - 7860

20mm Reducers for brushcutter blades. For our 27-7854, 27-7855, 27-4413, 27-4414, 27-7862, 27-7863.

MIN010

14/16

BLADES

BLADES



12" Universal Brush Cutter Blade



Order No. 27 - 50173

Universal Brush Cutter Blade. 12" (304.80mm) Length, 2.75" (69.85mm) Width, .095" (2.4mm) Thickness.

14" Universal Brush Cutter Blade



Order No. 27 - 50174

Universal Brush Cutter Blade. 14" (355.60mm) Length, 2.75" (69.85mm) Width, .095" (2.4mm) Thickness.

Razor Max Brushcutter Blade



Order No. 27 - 12580

Razor Max 7". (1" ID, 7" OD)

Order No. 27 - 12581

Razor Max 9". (1" ID, 9" OD)

- Designed for fast and easy cutting of small trees, heavy brush, thick weeds and grass.
- Suitable for gas powered trimmers and brushcutters with 30cc and higher engines.
- Designed to operate at maximum 10,000rpm
- Chainsaw tooth riveted onto blade can be sharpened with a 3/16" chainsaw file.
- 1" (25.4mm) center hole.

10" AireCut Tri Brush Cutter Blade



Order No. 27 - 14285

10" AireCut Tri Brush Cutter Blade. 250mm (under 25cc). The blade has a unique aerofoil twist that creates a strong upward airflow which carries the material away from the cutting area, saving energy, loss of power, fuel and time.

12" AireCut Tri Brush Cutter Blade



Order No. 27 - 14286

12" AireCut Tri Brush Cutter Blade. 300mm (25cc and above). The blade has a unique aerofoil twist that creates a strong upward airflow which carries the material away from the cutting area, saving energy, loss of power, fuel and time.

10 MM Blade Nut for STIHL

Order No. 27 - 14071

10 MM blade nut replaces Stihl 4126-642-7600. 10mm x 1.0 left hand thread brush blade nut. MIN005



14/16

BLADES



BLADE ADAPTERS



17
Quick-Glance

Quick-Glance

BLADE ADAPTERS	PG.
Adapters	428-433
Bolts	433-436
Washers	433-436
Bushings	436

BLADE ADAPTERS



17
BLADE ADAPTERS

Blade Clutch for AIRCAP

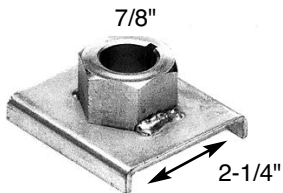

Order No. 17 - 6889

Blade Clutch. Replaces Air Cap 10109-00-05. Fits 21" walk behind. Also fits Eager Beaver and Lawn Tech.

Blade Adapter for AYP



Order No. 17 - 12728

Blade Adapter replaces AYP 193707, 184590. 25mm.

Blade Adapter for AYP

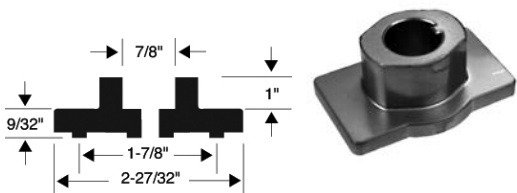

Order No. 17 - 8752

Blade adapter replaces AYP 850977. Fits models 1B101C, 3H302C, 2A271D and AYP 2033A59. For 20" & 22" walk behind mowers. Also fits Noma, Sears, Wizard and Husky.

Blade Adapter for AYP

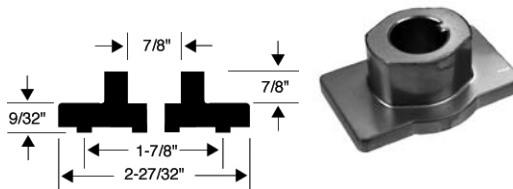

Order No. 17 - 8753

Blade adapter replaces AYP 851514. Fits models 4H472C, WE9656RD, 3M402A, 44W4B2A and YSC7K402C. For 22" self propelled mowers. Also fits Noma, Sears, Wizard and Husky

Splined Blade Bushing for EXMARK



ID 1/2"
Flange OD 1-3/4"
Height 1"



Order No. 17 - 14440

Splined blade bushing replaces Exmark 103-3037. Bushing fits all Exmark blades with .94" center hole. Fits our 10-13005 & 10-13540 spindle assemblies.

LAWN-BOY



Order No. 17 - 2220

Replaces Lawn-Boy blade adapter 677525. Weight 4 oz.

MTD

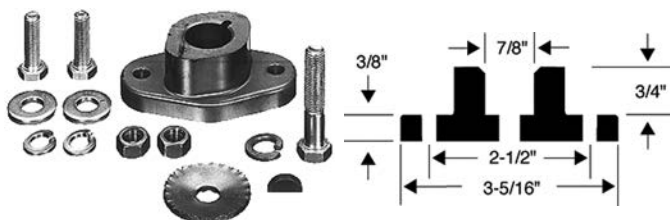

Order No. 17 - 1162

Replaces MTD 10769. Our 12 clutch assembly. For 7/8" crankshafts. Lowers blade 7/16". Has 5/32" keyway. Uses 1-3/4" Blade bolt & 5/16" - 24 x 1" attachment bolts. Weight: 15 oz.

MTD

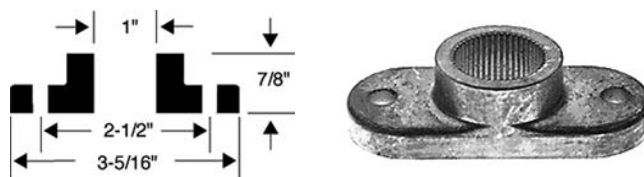

Order No. 17 - 6626

Replaces MTD blade adapter 748-0300.



MTD



Order No. 17 - 7200

Blade adapter assembly for our MTD 38" and 42" mulching kits. 7/16" width, mounting holes. Uses 7/16" - 20 x 1.25" attachment bolts. Fits our 10-7155 spindle assembly.

Order No. 17 - 7119

Hub only. Replaces MTD 748-0365, 948-0365.

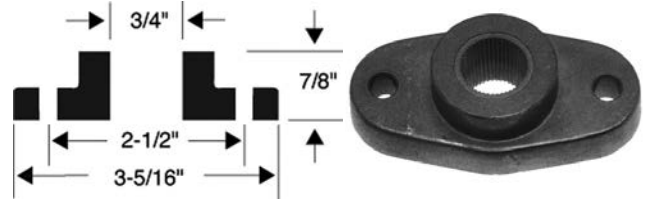

Order No. 17 - 7810

Blade adapter. Replaces MTD 748-0235, 753-0210. Fits 30" 500 series rear engine riders with model 796 deck.

Blade Adapter for MTD

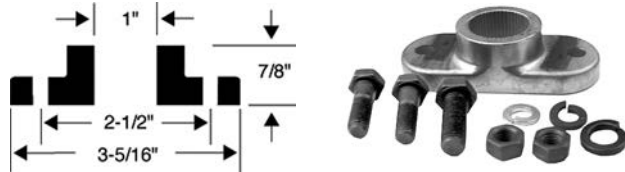

Order No. 17 - 9815

Blade adapter replaces MTD 753-0583. Fits MTD riders. Includes our 17-6626 hub.

Blade Adapter for MTD

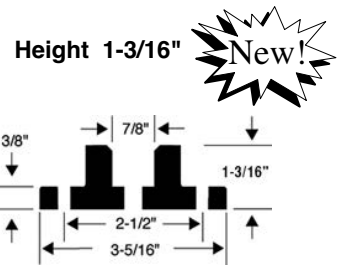

Order No. 17 - 14580

Blade adapter fits MTD walkbehind mowers. Fits our 15-6448, 15-12893, 15-6438, 15-6439, 15-6423, 15-6450, 15-6424, 15-6425 blades.

Blade Adapter Kit for MTD



Order No. 17 - 10239

Blade adapter kit replaces MTD 753-0484. Fits MTD walkbehind mowers. Has 3/16" built in key & 3/8" outside holes.

Order No. 17 - 10238

Blade hub only replaces MTD 948-0323. Fits MTD walkbehind mowers. Has 3/16" built in key & 3/8" outside holes. Used in our 17-10239 adapter kit.

Blade Adapter for MTD

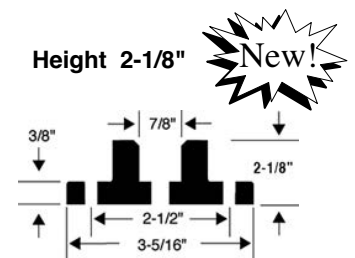

Order No. 17 - 14581

Blade adapter fits MTD walkbehind mowers. Fits our 15-6448, 15-12893, 15-6438, 15-6439, 15-6423, 15-6450, 15-6424, 15-6425 blades.

Blade Adapter for MURRAY

Top OD 7/8"
Splined ID .600"
Length 2-5/32"
Diameter 1-15/16"



Order No. 17 - 10957

Blade adapter replaces Murray 690411. Used on 42", 46" and 52" rail deck frames. Used with our 10-10189 Spindle.

BLADE ADAPTERS



BLADE ADAPTERS 17

MURRAY

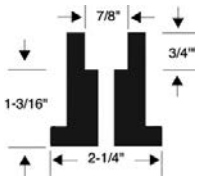

Order No. 17 - 1237

Replaces Murray 42735. For 21" and some 22" walk behind models 821853, 821861, 821951, 821981 & 822651. Uses 2-1/4" Blade bolt.

Order No. 17 - 1235

Hub only for our 17-1237.



Order No. 17 - 1167

Replaces Murray 54211. Clutch body only. Fits most Murray riders. 5/8" center hole.



Order No. 17 - 5935

Spline adapter replaces Murray 92466, 56258 & 91926. Used in our 38" & 42" mulching kits.

Blade Adapter for PARTNER

Top ID 7/8" (21.80 mm)
 Top OD 1-17/32" (38.82 mm)
 Bottom OD 2-37/64" (65.50 mm)
 Height 2-11/32" (59.24 mm)



Order No. 17 - 50225

Blade adapter only replaces Partner E-506-53-41-01. Fits HVA Rider Models #850-970. Has 1/4" (6.10 mm) keyway. Width 1-51/64" (45.55 mm).

Adapter Key for PARTNER



Order No. 17 - 50226

Adapter key replaces Partner E-506-53-35-01. Fits HVA Rider Models #850-970. Fits our 17-50225.

Blade Adapter for PARTNER

Top ID 7/8" (22.21 mm)
 Bottom ID 13/32" (10.30 mm)
 Top OD 1-1/4" (31.45 mm)
 Bottom OD 2-29/32" (73.82 mm)
 Height 1-5/16" (33.25 mm)



Order No. 17 - 50223

Blade adapter replaces Partner E 515-13-10-64. Fits HVA and Partner with 7/8" (22.23 mm) shaft.

Blade Adapter for PARTNER

Top ID 63/64" (25 mm)
 Bottom ID 13/32" (10.12 mm)
 Top OD 1-23/64" (34.43 mm)
 Bottom OD 2-29/32" (73.90 mm)
 Height 1-25/64" (35.12 mm)



Order No. 17 - 50224

Blade adapter only replaces Partner E-516-84-20-00.



SNAPPER

Order No. 17 - 1160

Replaces Snapper 7012927. Clutch assembly includes blade bolt, key and washer. Fits 7/8" shaft. Has 5/32" keyway. Uses 2" Blade bolt. Weight 14 oz.

Order No. 17 - 1178

Hub only.

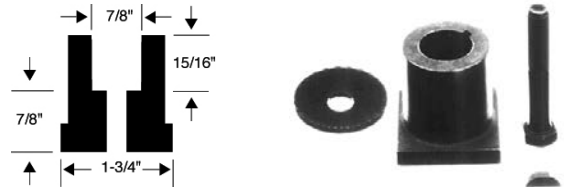

SENSATION

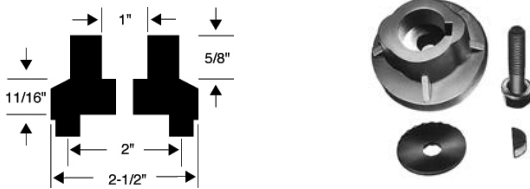

Order No. 17 - 1184

Replaces Sensation and Bobcat adapter, No. 3 blade clutch assembly. For 1" crankshaft. Has 1/4" keyway. Uses 1-3/4" Blade bolt. Used on 5 hp engines. Lowers blade 11-16".

Order No. 17 - 1225

Hub only for our 17-1184.

SENSATION

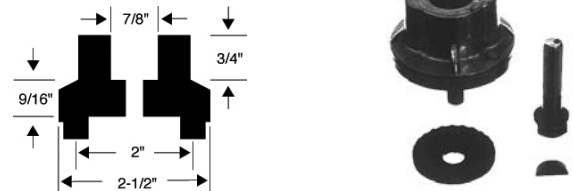

Order No. 17 - 1182

Replaces Sensation and Bobcat blade adapter, No. 2 blade clutch assembly. For 7/8" crankshaft. Has 5/32" keyway. Uses 1-3/4" Blade bolt. Weight: 14 oz. Used on 3-1/2" & 4 hp engines. Lowers blade 9/16".

Order No. 17 - 1224

Hub only for our 17-1182.

SEARS

ID 5/8"
Length 2-27/32"
Width 2"



Order No. 17 - 1152

Replaces Sears adapter 87711X00, 87711X004, 69226, 84918 and 80104 on most Sears rotary mowers. Black oxide finish. Very popular. Weight 4.5 oz.

Blade Adapter for STIGA

ID 47/64" (18.65 mm)
OD 11/32" (8.73 mm)
Length 4" (101.60 mm)
Height 37/64" (14.68 mm)



Order No. 17 - 50203

Blade adapter replaces Stiga 1134-2082-01. Fits Stiga Park 2000-2002, Stiga Villa, and Stiga Garden. Has 3/16" (4.76 mm) keyway.

Blade Adapter Key for STIGA

Order No. 17 - 50204

Blade adapter key replaces Stiga 1134-0323-00. Fits Stiga Park 2000-2002, Stiga Villa, and Stiga Garden. Fits our 17-50203. . MIN010



BLADE ADAPTERS



17

BLADE ADAPTERS

Blade Adapter for STIGA

Top ID 7/8" (21.90 mm)
 Top OD 1-17/32" (38.82 mm)
 Bottom OD 2-37/64" (65.50 mm)
 Height 1-63/64" (50.21 mm)



Order No. 17 - 50208

Blade adapter for Stiga. Fits Flandria Turbo. Has 3/16" (4.51 mm) keyway. .

Blade Adapter for STIGA

Top ID 63/64" (24.95 mm)
 Top OD 1-45/64" (43 mm)
 Bottom OD 2-37/64" (65.50 mm)
 Height 1-63/64" (50.20 mm)



Order No. 17 - 50209

Blade adapter for Stiga. Fits Pro 48. Has 3/16" (4.75 mm) keyway. .

Blade Adapter for STIGA

Top ID 7/8" (21.80 mm)
 Top OD 1-17/32" (38.82 mm)
 Bottom OD 2-37/64" (65.50 mm)
 Height 2-11/32" (59.24 mm)



Order No. 17 - 50206

Blade adapter for Stiga. Fits Multiclip. Has 3/16" (4.15 mm) keyway.

WALKER



Order No. 17 - 6793

Replaces Walker blade hub 5706.

Blade Adapter Kit for WALKER



Order No. 17 - 10019

Blade adapter kit fits Walker. Kit contains our (1) 17-6793, (2) 17-8802, (2) 17-8801.

YAZOO

OD 1-3/4" (44.5 mm)



Order No. 17 - 2947

Replaces Yazoo 101-002.

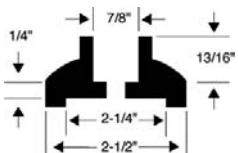

Order No. 17 - 1159

Our 9 clutch. For 7/8" crankshafts. Lowers blade 1/4", Lug Clutch, has 5/32" keyway. Uses 1-3/4" Blade bolt, diameter 2-1/2", weight 11.5 oz.

Order No. 17 - 1177

Hub only for 7/8" crankshafts.

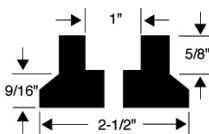

Order No. 17 - 1155

Our No. 4 clutch. For 1" crankshafts. Lowers blade 9/16". Has 5/32" keyway, diameter 2-1/2". Uses 1-3/4" Blade bolt, weight 11 oz.

Order No. 17 - 1173

Hub only for 1" crankshafts.



Order No. 17 - 1156

Our 6 clutch. For 7/8" crankshafts. Lowers blade 5/8". Has 5/32" keyway. Uses 1-3/4" Blade bolt, diameter 2-1/2", weight 12.5 oz.

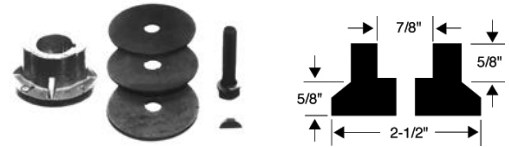

Order No. 17 - 1174

Hub only for 7/8" crankshafts.

Blade Bar for SNAPPER

Length 12-1/2"



Order No. 17 - 5847

Blade Holder Bar with adjustment bolt holes. Replaces Snapper 7037751.

Blade Bar Bolt for SNAPPER

Size 1/2" - 20 x 1-1/4"



Order No. 17 - 12268

Blade bar bolt replaces Snapper 7090491. Used with our 17-5847 blade bar. MIN010

Blade Bar Bolt for SNAPPER

Size 1/2" - 20 - 1"



Order No. 17 - 8453

Blade bar bolt replaces Snapper 7090392. Fits our blade bar 17-5847. MIN010

Blade Bar Washer for SNAPPER

ID 1/2" Internal Slotted



Order No. 17 - 8455

Blade bar washer replaces Snapper 7090509. Fits our blade bar 17-5847. MIN010

Blade Bar Nut for SNAPPER

Size 1/2" - 20



Order No. 17 - 8454

Blade bar nut replaces Snapper 7090559. Fits our blade bar 17-5847. MIN010

BLADE ADAPTERS



BLADE ADAPTERS 17

Washers



Length ID 7/8"
Width ID 5/8"
OD 1-7/8"

Order No. 17 - 423

Safety washer. Replaces Sears 1044-R.



ID 1/2"
OD 2-3/32"

Order No. 17 - 424

Blade washer. Replaces McLane 2044.



ID 3/8"
OD 1-1/2"

Order No. 17 - 1187

Cupped serrated washer. 3/8" hole size only. Heavy spring steel. MIN010

Lockwasher



Order No. 17 - 141

3/8" Lockwasher. MIN010

Steel Blade Washers

Order No. 17 - 1188

3/8" ID x 2-1/4" OD

MIN010

Order No. 17 - 1189

3/8" ID x 2-1/4" OD

MIN010

Order No. 17 - 1190

3/8" x 3"

MIN010



Fibre Washers

Order No.

17 - 1213	3/8" x 2-5/16"	MIN010
17 - 1214	1/2" x 2-5/16"	MIN010
17 - 1215	5/8" x 2-5/16"	MIN010
17 - 1216	3/4" x 2-5/16"	MIN010
17 - 1217	7/8" x 2-5/16"	MIN010
17 - 1218	1" x 2-5/16"	MIN010
17 - 1219	1-1/8" x 2-5/16"	MIN010
17 - 1220	1-1/4" x 2-5/16"	MIN010
17 - 1221	3/8" x 3"	MIN010



Fibre Spacer for DIXIE CHOPPER

OD 2-1/4"
ID 5/8"
THICKNESS 1/8"



Order No. 17 - 9531

Fibre spacer replaces Dixie Chopper W101. MIN010

Blade Washer for MURRAY

ID 5/8"
OD 1-3/4"
Thickness .117"



Order No. 17 - 14050

Blade belleville washer replaces Murray 17X166MA, Encore 583108, Exmark 1-513208. MIN005



BLADE ADAPTERS

17
BLADE ADAPTERS

Blade Bolt for AYP



Order No. 17 - 12280

Blade bolt with washer replaces AYP 174365. Used with our 10-11014 & 10-11590 spindles. MIN005

Blade Bolt for AYP

3/8" - 24 x 1-1/4" LH



Order No. 17 - 9586

Blade bolt replaces AYP 165484. Blade bolt for our 10-9574 spindle assembly. Left hand thread.

Blade Bolt with Washer for AYP

Size 7/16"



Order No. 17 - 14457

Blade bolt with washer replaces AYP 193003, Husqvarna 532-1930-03. Fits our 10-11014, 10-11590 & 10-12734 spindle assemblies. 1-1/4" x 7/16"-20.

Blade Bolt for CASTELGARDEN

Size 3/8"-24 x 1-1/2"



Order No. 17 - 50166

Blade bolt replaces Castelgarden 12735695/0. Hex head, grade 8. Plain finish, left handed threads.

Screw/Blade Bolt for EXMARK



Order No. 10 - 12633

Screw/Blade bolt replaces Exmark 3213-6. 1/2" -20 x 2-1/4", Grade 8. Fits Triton blades. MIN010

Order No. 10 - 13240

Screw/Blade bolt replaces Exmark 3213-5. 1/2" -20 x 2", Grade 8. MIN010

Order No. 10 - 13504

Screw/Blade bolt replaces Exmark 103-1026. 5/8" - 11 x 1", Grade 8. MIN010

Blade Bolt



Order No. 10 - 5704

Blade Bolt. Replaces Bunton PLO 815 and Snapper 90167. 9-1/2" with head, 5/8" x 9" without head.

Blade Bolt for EXMARK

5/8" - 18 x 2-3/4"



Order No. 10 - 11566

Blade bolt replaces Exmark 103-0862. 5/8" -18 thread x 2-3/4", cap screw, yellow zinc. MIN010

Blade Bolts



Order No.

Order No.	Size	
17 - 1202	1-1/4"	MIN010
17 - 1203	1-1/2"	MIN010
17 - 1204	1-3/4"	MIN010
17 - 1205	2"	MIN010
17 - 1206	2-1/4"	MIN010
17 - 1207	2-1/2"	MIN010
17 - 1208	3"	MIN010

1035- Steel - Heat Treated

Blade Bolt for HONDA

Size M10 x 1.25



Order No. 17 - 8640

Blade bolt replaces Honda 90105-960-710, code 1663665. Fits 21" mower models HR214, HRA214, HR215, HRA215, HR216, HRA216, HRC215, HRC216, HRM215, HRB215 & HRS21. Hex flange bolt.

Blade Locking Bolt for KUBOTA



Order No. 17 - 12829

Blade locking bolt replaces Kubota 76539-3437-2. Fits 19.5mm center hole blades including deck models: RC-54-G20, RC-54-F20, RC-60-21B, RC-60-G20, RC-60-FZ21, RCK-24B, RC-72-F30. Shoulder 19.5mm, Length 32mm, Allen head recess 14mm. MIN005

BLADE ADAPTERS



17
BLADE ADAPTERS

Blade Bolt for PARTNER



Top OD 5/64" (21.62 mm)
Length 1-11/32" (33.94 mm)

Order No. 17 - 50227

Blade bolt with locking replaces Partner E-506-67-54-01. Fits HVA 850 Rider.



Order No. 10 - 8343

Blade bolt replaces Scag 04001-41. Fits Scag midsize mower 32", 40", 48", 52", 61", 72" cut. 5/8" x 9-1/2" Overall length.

Blade Adapter Bolt for STIGA



Top OD 43/64" (16.80 mm)
Length 1-3/64" (26.38 mm)

Order No. 17 - 50205

Blade adapter bolt with Locking replaces Stiga 9990-1020-19. Fits Stiga Park and Stiga Villa.

Bolt for WALKER

10 - 24 x 1



Order No. 17 - 8801

Bolt replaces Walker F202. Fits our 17-6793 blade hub. Used with our 17-8802 nut. Stainless steel. MIN010

Blade Bushings



Serrated bushing to reduce 1" center hole blade to desired hole size.

Order No.	Size	MIN010
17 - 1195	3/8"	MIN010
17 - 1196	7/16"	MIN010
17 - 1197	1/2"	MIN010
17 - 1198	9/16"	MIN010
17 - 1199	5/8"	MIN010
17 - 1200	3/4"	MIN010
17 - 1201	7/8"	MIN010

Hex Nut



Order No. 10 - 5705

Hex Nut replaces Bunton Z32008. (5/8" x 18)

Nut for WALKER



10 - 24

Order No. 17 - 8802

Nut replaces Walker F002. Fits our 17-6793 blade hub. Used with our 17-8801 bolt. Zinc plated, low carbon steel. MIN010

13/16" Blade Reducer

ID 13/16"
OD 1"

Order No. 17 - 8680

13/16" blade reducer will adapt our 1" universal blades to the following applications. MTD 090 series, MTD 030/040, MTD 312R, 313R, 315R, 816R, 818R, 462R - 479R, MTD 22" mulcher. MIN010



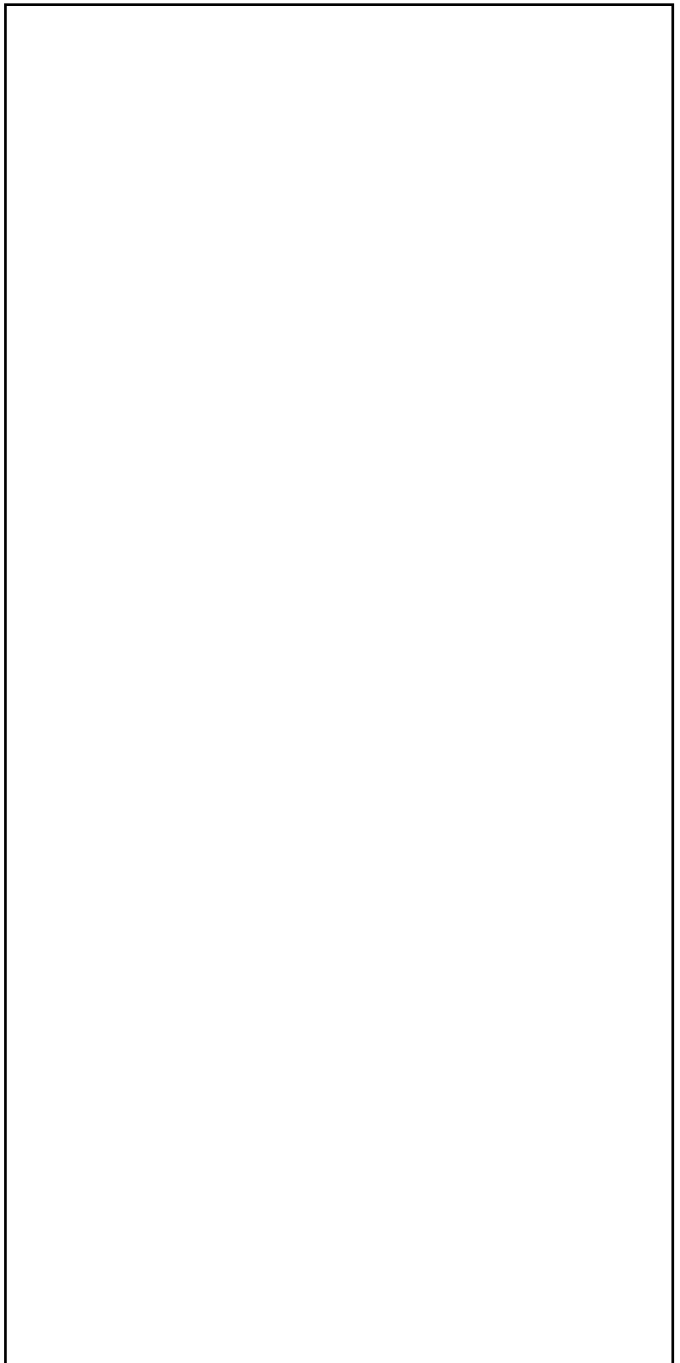
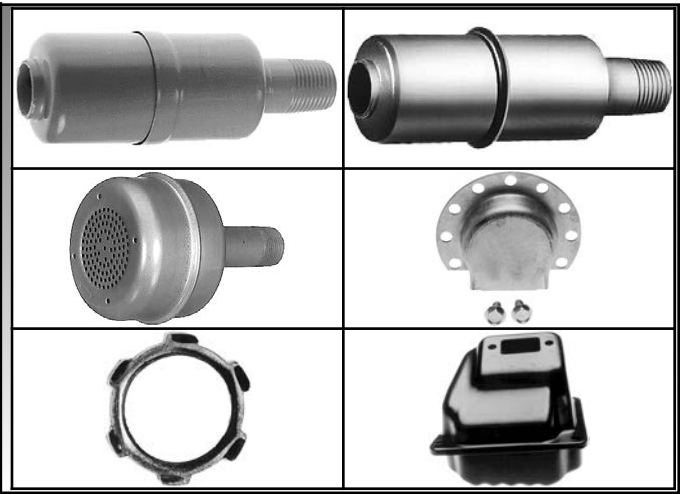

Quick-Glance

MUFFLERS	PG.
Small Engine	
Mufflers	438-444
Deflector	444
Lock Nuts	445
Chain Saws	
Mufflers	444

MUFFLERS



OEM Quality Replacement Mufflers for Briggs & Stratton

**Quality Features: Copper Brazed
OEM Gauge Material
Electrostatic Painted**

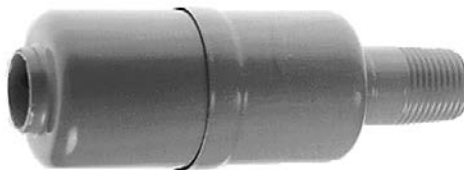

Pipe 1/2"
Length 4-3/4"

18
MUFFLERS

Order No. 18 - 2294

Muffler replaces Briggs & Stratton 89966. Fits 2-1/2 to 3-1/2 hp. Fits N, 5S, 6B-F, 6-R, 6B-HS, 6B-H, 6, 6R, 6F, 6S, 6B-S, 8, 8F, 8R, 8P, 8B-F, 8B-R, 8B-H, 60100 (2 hp horizontal): 80299, 80300, 81997, (3 hp horizontal). Also fits Tecumseh 33652, 30911, 30874, 27674, 28396 and Clinton 170-136-500, 170-18-500, 170-159-500 (OEM Type).

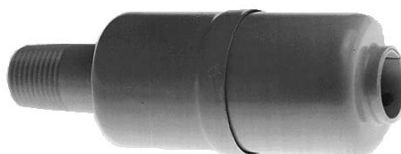

Pipe 3/4"

Order No. 18 - 2296

Muffler replaces Briggs & Stratton 294599. Fits 9, 9B, 9F, 9R, 100200 series, 130200, 131200 series (5 hp horizontal), 170400 series (7 hp horizontal), 170700, 171700 series, 190400 to 190799 (8 hp horizontal), 1954 - series (8 hp horizontal). Also fits Briggs & Stratton 291244, Tecumseh 29633, 31287, 31506, 32043, 32043A, 32043B, 32985, 31987. Also fits Clinton and Kohler (4-8 hp) (OEM Type).

Order No. 18 - 12296

Muffler for B/S. (bagged)

MIN005

**Mufflers for
BRIGGS & STRATTON**



Order No. 18 - 892

Muffler replaces B&S 494585, 393615. Fits 5 hp Vertical Shaft with gasket.



Order No. 18 - 862

Replaces B&S 394644. With bolts.



Order No. 18 - 891

Muffler replaces Wheel Horse 110774, 110771, Roper 101273-M, Murray 90330SE, Western International 54766, 54765. With bolts and heat shield. For B&S (10 & 11 hp). 1-7/8" bolt center.



Pipe 1/2"

Order No. 18 - 1267

Muffler replaces Briggs & Stratton 493288, 493288/392811. Painted, low-tone type. For vertical and horizontal engine series 60000 and 80000. Comes complete with muffler deflector 222238. Fits (1-1/2 to 3-1/2 hp) engines.



Mufflers for
BRIGGS & STRATTON (Cont.)

Pipe 1/2"



Order No. 18 - 1268

Universal Muffler replaces Briggs & Stratton 394569. Fits 110000 series (4 hp).

Pipe 3/4"



Order No. 18 - 1269

Muffler Replaces Briggs & Stratton 393010. Painted, low-tone, two-step type. Fits 9, 9B, 9F, 9R, 100200, 130200, 131200 (5 hp horizontal); 170499, 170700, 171700, 171706 (7 hp horz.); 190400, 190799, 195400 series (8 hp horz.).

Order No. 18 - 1278

Muffler replaces Briggs & Stratton 493936, 494585, 493936, 297274. Painted black. Bolt-on type with deflector and screw. Fits Briggs & Stratton 100900 series (4-8 hp).



Pipe 1/2"
Height 1-21/32"
Dia. 2-1/2"
Length 1-3/4"



Order No. 18 - 1273

Muffler replaces Briggs & Stratton 299106. Fits N, 5S, 6B-F, 6-R, 6B-HS, 6B-H, 6, 6F, 6S, 6B-S, 8, 8F, 8R, 8P, 8B-F, 8B-R, 8B-H, 60100 to 82500 and 92599 series, 92900 series (3.5 hp vertical), 93500 series (3.5 hp vertical), 111200 series (4 hp vertical). For use in tight places.

Plated Pipe 1/2"
Length 4-3/4"



Order No. 18 - 1270

Muffler Replaces Briggs & Stratton 89966. Fits 2-1/2 to 3-1/2 hp. Fits N, 5S, 6B-F, 6-R, 6B-HS, 6B-H, 6, 6R, 6F, 6S, 6B-S, 8, 8F, 8R, 8P, 8B-F, 8B-R, 8B-H, 60100 (2 hp horizontal); 80299, 80300, 81997 (3 hp horizontal). Also fits Tecumseh 33652, 30911, 30874, 27674, 28396 and Clinton 170-136-500, 170-18-500, 170-159-500.

Plated Pipe 3/4"



Order No. 18 - 1275

Muffler replaces Briggs & Stratton 294599. Fits 9, 9B, 9F, 9R, 100200 series, 130200, 131200 series (5 hp horizontal), 170400 series (7 hp horizontal), 170700, 171700 series, 190400 to 190799 (8 hp horizontal), 1954-series (8 hp horizontal).

For 1" Pipe
Pipe Thread 1"
ID 1-1/4"



Order No. 18 - 1277

Muffler replaces Briggs & Stratton 392989, 299477, 393232, (8-16 hp). Tecumseh 32043B and Kohler No. 275679. Also fits Wisconsin & Gravely. Fits many John Deere, Wheel Horse and Power King.

MUFFLERS



**Mufflers for
BRIGGS & STRATTON (Cont.)**



Order No. 18 - 2280

Muffler replaces Briggs & Stratton 391492, 394644. Fits 110000 series (4 hp vertical). Includes bolts, gasket keeper, and spacer.



Order No. 18 - 1283

Muffler replaces Briggs & Stratton 391313. Low-tone, square, bolt-on type. Fits vertical and horizontal engine series. 100000 and up (5, 7 & 8 hp) except 110000 series. Comes complete with bolts, lock and aluminum plate.

18

MUFFLERS

Plated Pipe 1/2"
Dia. 2-1/2"
Height 2-1/2"



Order No. 18 - 1272

Muffler replaces Briggs & Stratton 394569 & 298830. Fits 82500 to 92599, 92900 series (3.5 hp vertical), 93500 series. Also fits Tecumseh and Clinton (2-4 hp).

Pipe Thread 1-5/16"
Pipe Length 4-1/2"
ID 1"
Overall 7-3/4"



Order No. 18 - 859

Muffler replaces Briggs & Stratton 393232, 299477, MTD 600 Rider (11 hp).



Order No. 18 - 7867

Muffler replaces B&S 496106 & 490547. Fits 4-1/2 & 5 hp Quantum models.

For 1" Pipe
Pipe Thread 1"
ID 1-1/4"



Order No. 18 - 8001

Muffler replaces B&S 392989. Fits 9-16 hp single cylinder engines. Series 233400-252700, 254400, 280700, 281700, 326400, 402400, 422400.

For 1-1/4" pipe OD
Length 9-1/2"
Width 4-1/4"
Height 4"
ID 1-1/8"



Order No. 18 - 8002

Muffler replaces B&S 498984, 493963. Fits 12 hp series 252762 muffler. Fits Sears & midsize Exmark, Bunton, Toro.



Order No. 18 - 8003

Muffler replaces B&S 491413. Low-tone muffler for 10 thru 12-1/2 hp Horiz. & Vert. engines.



MUFFLERS

Muffler for GRAVELY



Inlet ID 1-5/16"
Outlet ID 1-1/4"

Order No. 18 - 2286

Muffler replaces Gravelly 18543.

Muffler Pipe for HONDA



Order No. 18 - 14594

Muffler pipe replaces Honda 18330-ZH9-N00, 18330-ZE2-W00, code 3682036. Fits GX240, GX340, GX390 series engines. Included with our 18-14449 Muffler.

Muffler for HONDA



Order No. 18 - 14449

Muffler pipe replaces Honda 18310-ZE2-W61. Fits GX340, GX390, muffler (100 db) for 11 & 13 hp engines with heat shield.

Muffler for HONDA



Order No. 18 - 14450

Muffler replaces Honda 18310-ZMO-000. Fits GCV135 AND GVC160 series engines, shield not included. Fits models GSV190 (A1G7, A2G7, N1G7, N2G7). Also fits models GX100VEA, GX100UBE14.

Muffler Protector for HONDA



Order No. 18 - 14451

Muffler protector replaces Honda 18320-ZE2-W62, 18320-ZE2-W61. Fits engines GX340 & 390 KBN#35-11 & Honda 18320-ZE3-W01.

Muffler for HONDA



Order No. 18 - 9577

Muffler replaces Honda 18310-ZF1-000. Fits 5.5 hp engines. Model GX160. Heat shield included.

Muffler for HONDA



Order No. 18 - 9578

Muffler replaces Honda 18310-ZE3-003. Fits 8 hp engines. Model GX240. Fits 11-13 hp. Shield not included.

Muffler for HONDA



Order No. 18 - 10271

Muffler replaces Honda 18310-ZE2-013. Fits GX240 & GX270 with 2 piece muffler shield. Shield Not Included.

Muffler for HONDA



Order No. 18 - 10272

Muffler replaces Honda 18310-ZE2-W00. Fits GX240 & GX270 with 1 piece muffler shield. Shield Not Included.

18

MUFFLERS

MUFFLERS



Muffler for KOHLER



Inlet ID 1-3/8"
Outlet ID 1-3/8"
Length 11-1/2"

Order No. 18 - 8284

Muffler replaces Kohler 237550. Fits 7, 10 & 12 hp engines. Also replaces Cub Cadet 393840-R91 garden tractors.



Order No. 18 - 2291

Replaces Kohler 220-145. Fits K-91 engines.



Order No. 18 - 7727

Replaces Kohler 41-068-08, 48-068-01. Fits K-161 & K-181 engines.



For 1-1/4" Pipe
ID 1-9/16"

Order No. 18 - 2285

Muffler replaces Kohler 45-068-01.

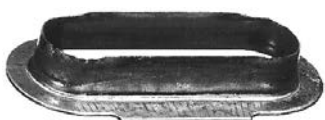

Order No. 18 - 2955

Exhaust Sleeve, replaces Lawn-Boy 602717.

MIN010

Muffler for MURRAY



Order No. 18 - 6510

Muffler for (11 & 12 hp) B&S equipped Murray front engine riders. Replaces Murray 903305E, 91271SE, model 9-38219. Also fits front engine rider Dynamark model 3912.

Muffler for MTD



Order No. 18 - 14456

Muffler replaces MTD 751-10448C, single cylinder B&S.

Muffler for SNAPPER



Order No. 18 - 13625

Muffler replaces Snapper 7074453. Used on OHV single cylinder Briggs & Stratton engines on rear engine riders.

18

MUFFLERS



Hardware for SNAPPER



Order No. 18 - 2300

Hardware only for Snapper 7060316. Used with our 18-2290.

Muffler Kit for SNAPPER



Order No. 18 - 2290

Complete Muffler Kit replaces Snapper 7060316. Fits Snapper (8 hp) rider.



Order No. 18 - 2288

Replaces Snapper 7018197. Pipe for our 18-2281.



Order No. 18 - 2289

Replaces Snapper 7018214. Pipe for our 18-2287.



Order No. 18 - 2281

Muffler replaces Snapper 7018198. Fits Briggs & Stratton and Tecumseh (8 hp).



Muffler for TECUMSEH

Order No. 18 - 12493

Muffler replaces Tecumseh 35056.



Order No. 18 - 7239

Muffler replaces Snapper 7051996. Fits (12 & 12-1/2 hp) Briggs on Snapper Riders.

Muffler for TECUMSEH



Order No. 18 - 8282

Muffler replaces Tecumseh 35603A. Fits model TVS-120, Premier & XL.



Order No. 18 - 2282

Muffler replaces Tecumseh 32401. Painted, bolt-on type. Fits HH40, H50, HH50, H60, HH60, H70, HH70, series. Also fits Troy Bilt (6 hp). For snow throwers.



Dia. 2-1/4"
Height 2-1/4"

Order No. 18 - 1274

Muffler replaces Tecumseh 27181C, 27181B, 30082-A, 30996. Plated, bolt on type. Comes complete with bolts and gasket. Fits (2-1/2 to 3-1/2 hp)

18

MUFFLERS

MUFFLERS



**Muffler for
TECUMSEH (Cont.)**

Order No. 18 - 1279

Muffler replaces Tecumseh 29633 and Kohler 220521. Painted. Fits Kohler K-91 engines (4 hp).



Pipe 3/4"



Pipe 7/8"

Order No. 18 - 2283

Muffler replaces Tecumseh 33280A & 34185B. Painted, bolt-on type, female. Fits HM70, HM80, HM100, VM70, VM80, VM100, H80, HHM80, V80 series. For snow throwers.



Order No. 18 - 2284

Muffler replaces Tecumseh 35771/33697A. Painted, bolt-on type. Female .895" "D" hole pipe. Fits H40, H50, H60, H70, HS50, LAV50, TVS120, TVS75, TVS90, TVS105, TVXL105 series.

**Muffler for
TORO**



Order No. 18 - 1282

Muffler replaces Toro Kit 2-9319. Painted, bolt-on type. Comes complete with bolts, gasket and lock. Heavy-gauge steel. 1-11/16" height. For push mowers.



Height 2-3/4"

Order No. 18 - 1280

Muffler replaces Toro Kit 5-4769. Painted, bolt-on type. Comes complete with bolts, lock and gasket. For self-propelled mowers.

**Muffler for
STIHL**



Order No. 39 - 7297

Muffler replaces Stihl 1110-140-0613. Fits models 040, 041 and 041G.

**Muffler for
STIHL**



Order No. 39 - 7300

Muffler replaces Stihl 1119-007-1027 and 1119-007-1005. Fits model 038.

Muffler Deflectors



Order No. 18 - 1276

Universal Muffler Deflector. Fits on (3, 3-1/2 and 4 hp). Briggs & Stratton engines. Can be used on our muffler **18-1272** and **18-1273**.



Order No. 18 - 1284

Deflector replaces Briggs & Stratton 393755. With self-tapping screw. Can be used on our muffler **18-2295** and **18-2293**.



Order No. 18 - 1281

Deflector replaces Briggs & Stratton 393750/221488. With self-tapping screw. Used on our muffler **18-1278**.



Order No. 18 - 2297

Deflector replaces Briggs & Stratton 393757. Can be used on our muffler **18-892** and **18-1283**. Fits models 170,000 & 190,000 series, 5-8 hp units.

18

MUFFLERS



Muffler Deflectors



Order No. 18 - 8004

Muffler deflector replaces B&S 393760. Fits 5 hp Horiz. series 60000, 80000, 90000, 100,000, 110,000, 120,000.

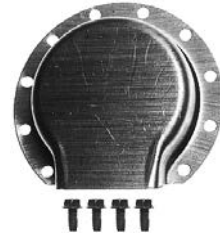

Order No. 18 - 2298

Deflector replaces Briggs & Stratton 393761. Can be used on our muffler **18-891** and **18-859**. Fits 220,000 series and up. 10 hp units.

Muffler Lock Nuts

Order No. 18 - 1286

1/2" Muffler Lock Nut replaces Briggs & Stratton 691720, 220859. MIN010

Order No. 18 - 1287

3/4" Muffler Lock Nut replaces Briggs & Stratton 690453, 692304, 261409. MIN010

Order No. 18 - 897

1" Muffler Lock Nut replaces Briggs & Stratton 691808, 261564. MIN010



18

MUFFLERS

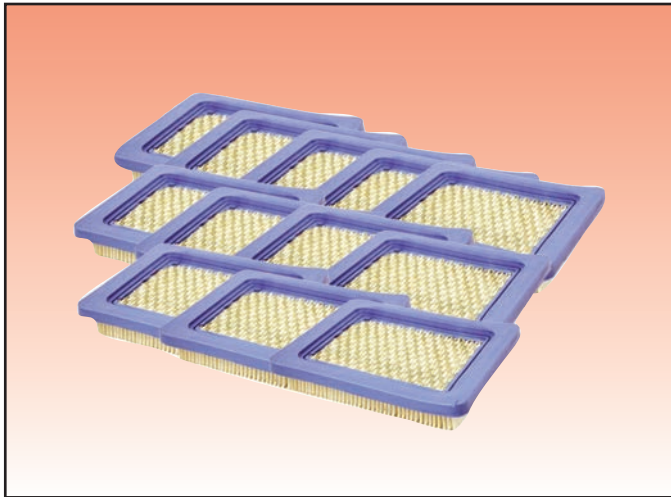

Quick-Glance

FILTERS	PG.
Shop Pack Filters	448-450
Small Engine	
Air Filters	451-482
Oil Filters	483-484
Transmission Filters	484
Trimmer/Blower	
Air Filters	485-495
Chain Saw	
Air Filters	485-495
Fuel Filters	
Assortment	496-502
Small Engine	496-502
Trimmer/Brushcutter	496-502
Chain Saw	496-502

FILTERS



Prefilter Shop Pack for BRIGGS & STRATTON



Order No. 19 - 12947

Prefilter Shop Pack replaces B&S 273356. Bulk pack for our 19-9592. MIN012

Prefilter Shop Pack for BRIGGS & STRATTON

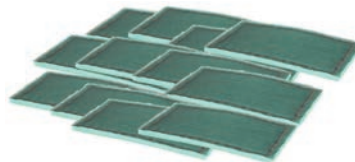

Order No. 19 - 12946

Prefilter Shop Pack replaces B&S 273638S. Bulk pack for our 19-9304. MIN012

Prefilter Shop Pack for BRIGGS & STRATTON



Order No. 19 - 12945

Prefilter Shop Pack replaces B&S 272490. Bulk pack for our 19-2797. MIN012

Air Filter Shop Pack for BRIGGS & STRATTON

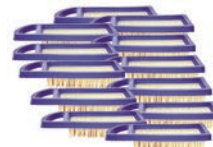

Order No. 19 - 12943

Air Filter Shop Pack replaces B&S 697014. Bulk pack for our 19-10184. MIN012

Air Filter Shop Pack for BRIGGS & STRATTON



Order No. 19 - 12942

Air Filter Shop Pack replaces B&S 499486. Bulk pack for our 19-9273. MIN012

Air Filter Shop Pack for BRIGGS & STRATTON

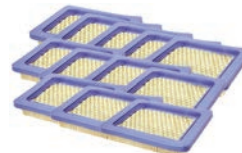

Order No. 19 - 12941

Air Filter Shop Pack replaces B&S 491588. Bulk pack for our 19-2838. MIN012

Air Filter Shop Pack for BRIGGS & STRATTON



Order No. 19 - 12940

Air Filter Shop Pack replaces B&S 698369. Bulk pack for our 19-11547. MIN012

Air Filter Shop Pack for BRIGGS & STRATTON



Order No. 19 - 12939

Air Filter Shop Pack replaces B&S 272235. Bulk pack for our 19-6524. MIN012

Air Filter Shop Pack for BRIGGS & STRATTON



Order No. 19 - 12938

Air Filter Shop Pack replaces B&S 27987. Bulk pack for our 19-1370. MIN012

Air Filter Shop Pack for BRIGGS & STRATTON



Order No. 19 - 12936

Air Filter Shop Pack replaces B&S 493909. Bulk pack for our 19-7094. MIN012

19

FILTERS



**Prefilter Shop Pack for
BRIGGS & STRATTON**



Order No. 19 - 13629

Prefilter Shop Pack replaces B&S 697015. Bulk pack for our 19-10304. MIN012

**Prefilter Shop Pack for
BRIGGS & STRATTON**

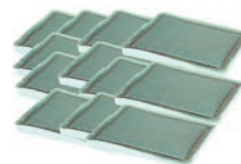

Order No. 19 - 12960

Prefilter Shop Pack replaces B&S 491435. Bulk pack for our 19-8481. MIN012

**Prefilter Shop Pack for
BRIGGS & STRATTON**



Order No. 19 - 12961

Prefilter Shop Pack replaces B&S 272403S. Bulk pack for our 19-7095. MIN012

**Prefilter Shop Pack for
KAWASAKI**



Order No. 19 - 12948

Prefilter Shop Pack replaces Kawasaki 11013-7001. Bulk pack for our 19-9611. MIN012

**Air Filter Shop Pack for
KOHLER**



Order No. 19 - 12935

Air Filter Shop Pack replaces Kohler 12-083-05. Bulk pack for our 19-6605. MIN012

**Air Filter Shop Pack for
KAWASAKI**

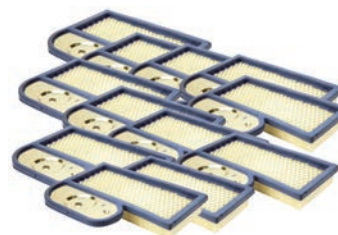

Order No. 19 - 12944

Air Filter Shop Pack replaces Kawasaki 11013-7002. Bulk pack for our 19-9506. MIN012

**Air Filter Shop Pack for
TECUMSEH**



Order No. 19 - 12953

Air filter Shop Pack replaces Tecumseh 36905. Bulk pack for our 19-9200. MIN012

**Air Filter Shop Pack for
TECUMSEH**



Order No. 19 - 12934

Air Filter Shop Pack replaces Tecumseh 35066. Bulk pack for our 19-2784. MIN012

FILTERS



Universal Fuel Filter Shop Pack



Order No. 20 - 12950

Universal fuel filter. Bulk pack for our 20-12619.

MIN050

Fuel Filter Shop Pack for BRIGGS & STRATTON



Order No. 20 - 12949

Fuel filter replaces B&S 394358. Bulk pack for our 20-1349.

MIN050

Fuel Filter Shop Pack for BRIGGS & STRATTON

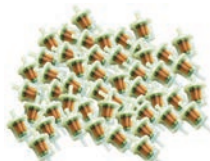

Order No. 20 - 12951

Fuel filter replaces B&S 493629. Bulk pack for our 20-7998.

MIN050

Fuel Filter Shop Pack for BRIGGS & STRATTON

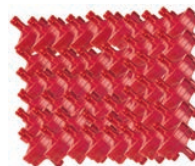

Order No. 20 - 12952

Fuel filter replaces B&S 298090. Bulk pack for our 20-6000.

MIN050

Oil Filter Shop Pack



19

FILTERS



Order No. 19 - 12861

Oil filter pack replaces B&S 492932, 696854, John Deere AM125424, Tecumseh 36563. **OD 2.92"**, **Ht. 2.7"**, **Thread size 3/4 - 16"**.

MIN012



Order No. 19 - 12862

Oil filter pack replaces Kohler 12-050-01S & John Deere AM101207. **OD 2.92"**, **Ht. 2.7"**, **Thread size 3/4 - 16"**.

MIN012



Order No. 19 - 12864

Oil filter pack replaces Kawasaki 49065-2078, 49065-2071 John Deere AM107423, Generac 1323 & 70185. **OD 2.685"**, **Ht. 2.977"**, **Thread size 3/4 - 16"**.

MIN012



Order No. 19 - 12863

Oil filter pack replaces Kohler 52-050-02S, B&S 491056. **OD 2.92"**, **Ht. 3.4"**, **Thread size 3/4 - 16"**.

MIN012



**Air Filters for
BRIGGS & STRATTON**



Order No. 19 - 1375

Replaces B&S 270447. Fits 130900 series (5 hp) models. Length: 5-3/8" to 6", Width: 3" to 3-5/8", Thickness: 1-1/2".



Order No. 19 - 1370

Replaces B&S 27987. Fits 60000 to 80000 series. 100200, 111200, 130200, 131200, 140200 and fits many (2, 3, 4 & 5 hp) horizontal. Also fits John Deere AM34963, Length: 4-5/8" to 5-1/4", Width: 3-5/8" to 4-1/4", Thickness: 1-1/2".

Order No. 19 - 12938

Air Filter Shop Pack replaces B&S 27987. Bulk pack for our 19-1370. MIN012



Order No. 19 - 1371

Replaces B&S 270579. (3-1/2 hp) vertical. Fits 82500 to 82997, 92599, 92900 and 93500 series. Also fits John Deere M47949. Length: 4-1/2" to 5-3/8", Width: 3" to 3-1/2", Thickness: 1-1/2".



Order No. 19 - 1376

Replaces B&S 270067. Fits 100900 (4 hp) series. Also fits John Deere AM37489. Length: 5" to 5-5/8", Width: 3" to 3-5/8", Thickness: 1-1/2".



Order No. 19 - 1372

Replaces B&S 270251. Fits 82500 thru 92900 and 92500 series, (for 3 & 3-1/2 engines) all up to automatic choke. Length: 5" to 5-3/4", Width: 2-7/8" to 3-5/8", Thickness: 1-1/2".



Order No. 19 - 1397

Replaces B&S 270843. Fits (10 hp & 11 hp) vertical series 252700, 251700, and 220700 series. Length: 8-1/2" to 9-1/4", Width: 3-3/4" to 4-1/2", Thickness: 1-1/2".



Order No. 19 - 1373

Replaces B&S 270528. Fits 146700 to 147703, 170700, 171700, 190700 and 191700, series (for 7 & 8 vertical hp) engines. Also fits John Deere AM49396, Length: 7-3/4" to 8-1/4", Width: 3-5/8" to 4-1/4", Thickness: 1-1/2".



Order No. 19 - 1398

Replaces B&S 270848. Fits (4 hp) vertical engines. 110900 and 111900. Also fits John Deere M82139. Length: 4-3/4" to 5-1/2", Width: 3-1/4" to 4", Thickness: 1-1/2".



Order No. 19 - 6524

Replaces B&S 272235. Fits models 92500, 92900, 93900, 95900, 96500 and 96900 Sprint and Classic engines (3, 3.5 & 3.75 hp) vertical shaft.

Order No. 19 - 12939

Air Filter Shop Pack replaces B&S 272235. Bulk pack for our 19-6524. MIN012



Order No. 19 - 11547

Air filter replaces B&S 698369. Fits 10A900, 98900, 9B900, 9C900 series after code 02101000.

Order No. 19 - 12940

Air Filter Shop Pack replaces B&S 698369. Bulk pack for our 19-11547. MIN012

Length 5-1/8"
Width 2-7/8"
Height 1-1/4"



FILTERS

BRIGGS & STRATTON (Cont.)



Length 4-1/2"
Width 4"
Thickness 1-1/4"



Order No. 19 - 12272

Air filter replaces B&S 794071. Fits 12OT00, 400-500 series vertical shaft engines.



Length 3"
Width 2"
Height 2"



Order No. 19 - 12080

Air filter replaces B&S 790166. Fits newer model 9.



ID 1-1/4"
OD 2-3/4"
Height 2-3/4"



Order No. 19 - 1396

Filter replaces B&S 392308. Fits models 60100, 80200, 80300, 80400, 81200, 81300, 81400, 92900, 93500, 110900, 112200, 130200, 130900, 131200, 131400, 131900, (2 thru 5 hp) horz. and vert. engines. Also fits JD M83339.

Order No. 19 - 1369

Prefilter replaces B&S 271466. Also fit JD PT7946.



ID 1-1/4"
OD 2-3/4"
Height 2-3/4"



Order No. 19 - 2788

Filter replaces B&S 396424. Fits models 60100, 80200, 80300, 80400, 81200, 81300, 81400, 82200, 82300, 82400, 92500, 92900, 110900, 111700, 112200, 112900, 114700, 114900, 130200, 130400, 130900, 131200, 131400, 131900, 132200, 132400, 132900 (2 thru 5 hp) horz. and vert. engines. Also fits JD PT7953.



Order No. 19 - 1369

Prefilter replaces B&S 271466. Also fits JD PT7946.



ID 2"
OD 4-1/4"
Height 3-3/4"



Order No. 19 - 1374

Filter replaces B&S 393957 and 390930. Fits models 170400, 171400, 190400, 194400, 195400, 220400, 221400, 222400, 233400, 243400, 252400, 253700, 254400, 290400, 294400, 302400, 303400, 326400 (7 thru 18 hp) horz. engines. Also fits JD PT9334.

Order No. 19 - 2786

Prefilter replaces B&S 271794 & 270782. Also fits JD M96098.



ID 5-5/8"
OD 7"
Height 2-1/4"



Order No. 19 - 2777

Filter replaces B&S 394018 and 392642. Fits models 290400, 290700, 294400, 294700, 303400, 303700, 350400, 350700, 400400, 401400, 402400, 404400, 422400 horizontal (L-Head) Twin, horz. and vert. V-Twin OHV Vanguard.

Order No. 19 - 2797

Prefilter replaces B&S 271271. Also fits JD M84655.



Length 9-5/8"
Width 4"
Height 2-1/2"



Order No. 19 - 2806

Filter replaces B&S 394019. Fits models 400700, 401700, 402700, 404700, 42700 (12, 14, 16 18 & 21 hp) vertical twin cylinder (L Head). Also fits JD AM38990.

Order No. 19 - 2797

Prefilter replaces B&S 272490, 271271. Also fits JD M84655.



Order No. 19 - 5941

Filter replaces B&S 399806 and 491519. Fits models 253700, 256700, 280700, 281700 (10 thru 12 hp) vertical I/C engines.



Order No. 19 - 5939

Prefilter replaces B&S 271962.



Length 8-5/8"
Width 2-5/8"
Height 2-3/4"

19

FILTERS



FILTERS

BRIGGS & STRATTON (Cont.)



ID 1-3/8"
OD 3-3/4"
Width 2-7/8"



Order No. 19 - 2773

Filter replaces B&S 390492. Fits models 146400, 170400, 171400, 190400 (7 & 8 hp) horizontal (early style). Also replaces EMGLO air compressor L54E.



OD 2-7/8"
ID 1-1/2"
Height 5-7/8"



Order No. 19 - 12673

Air filter replaces B&S 793569. Fits John Deere GY21055 & MIU11511.



Order No. 19 - 12894

Prefilter replaces B&S 793685. Fits John Deere (MIU11513) 21 HP. Also fits 31L-33M series engines. Fits our 19-12673 filter.



Length 5-3/16"
Width 3-1/4"
Height 2-1/2"



Order No. 19 - 2778

Filter replaces B&S 393725 and John Deere AM37816 (oval). Fits models 220700, 252700, 253700, 256700 (11 hp) vertical I/C series.



Length 5-3/16"
Width 3-1/8"
Height 2-1/8"



Order No. 19 - 2840

Filter replaces B&S 393406. Fits models 170700, 190700, 191700, 192700, 193700 series (7 & 8 hp) vert. engines. Also fits JD AM37540.



Length 6-3/4"
Width 2-7/8"
Height 3-1/8"



Order No. 19 - 6604

Filter replaces B&S 491021. Fits models 260700 & 261700 series, (12.5 & 14 hp) vert. single cylinder OHV Vanguard engines.



Length 5-1/2"
Width 2-1/2"
Height 2-3/4"



Order No. 19 - 6602

Filter replaces B&S 491950. Fits model 104700 series, (5 hp) vert. OHV Vanguard engines. Types 3112, 4024, 4025, 4044, & 4045.

Order No. 19 - 6575

Prefilter replaces B&S 492947.



Order No. 19 - 6603

Prefilter replaces B&S 272218.

Order No. 19 - 10104

Prefilter replaces B&S 272444.



Length 7-1/4"
Width 2-7/8"
Height 2-3/4"



Order No. 19 - 7094

Filter replaces Briggs & Stratton 496894, 493909. Fits (12 thru 15 hp) vertical engines models 282700, 283700 & 286700.



Length 7-1/4"
Width 2-7/8"
Height 2-3/8"



Order No. 19 - 7214

Filter replaces Briggs and Stratton 691667, 493910. Fits (8-1/2 thru 11-1/2 hp) vertical engines models 196700, 257700, 259700.

Order No. 19 - 12936

Air Filter Shop Pack replaces B&S 493909. Bulk pack for our 19-7094.



Order No. 19 - 7095

Prefilter replaces Briggs & Stratton 272403.



Order No. 19 - 7949

Prefilter replaces B&S 272477.

AIR CLEANER NUT

Order No. 19 - 7778

Air Cleaner Nuts comes with washer and rubber "O" ring attached. 1/4" - 20 with "O" ring. Replaces B/S 281051. Used with our Air Filter 19-7732 and 19-7094. MIN010



19

FILTERS



FILTERS

BRIGGS & STRATTON (Cont.)



ID 3-1/2"
OD 5"
Height 2-3/8"



Order No. 19 - 6514

Filter replaces B&S 392286. Fits models 252400, 253400, 255400 (10, 11 & 12 hp) vertical shaft engines.



Order No. 19 - 10181

Prefilter replaces B&S 270973. Fits our 19-6514 air filter.



OD 7-13/16"
ID 5-1/2"
Height 2-1/4"



Order No. 19 - 11795

Air filter replaces B&S 692519. Fits Twin Cylinder Vanguard engines model 358700-389400. Uses our 19-7050 prefilter.



Order No. 19 - 7050

Prefilter fits our 19-11795 air filter. Replaces B&S 692520.



Length 8-3/4"
Width 3-1/4"
Height 2-1/2"



Order No. 19 - 7879

Air filter replaces B&S 399968. Fits 7, 8 & 11 hp horz. engines.



Order No. 19 - 10105

Prefilter replaces B&S 271939. Fits our 19-7879 air filter.



Length 4"
Width 1-1/2"
Height 3"



Order No. 19 - 9591

Filter replaces B&S 692446. Fits 123600 series.



Order No. 19 - 9592

Prefilter replaces B&S 273356.

Order No. 19 - 12947

Prefilter Shop Pack replaces B&S 273356. Bulk pack for our 19-9592. MIN012

19

FILTERS



Length 3-9/16"
Width 2-1/4"
Height 3"



Order No. 19 - 9168

Filter replaces B&S 697029, 690610, 498596. Fits 5.5 & 6.5 hp engines (Intek). Uses our 19-9592 prefilter.



Length 3-7/8"
Width 2-5/8"
Height 2-3/16"



Order No. 19 - 8815

Air filter replaces B&S 497725. Fits 5 hp quantum engines, models 12U800 thru 12U899.

Order No. 19 - 8490

Prefilter replaces B&S 273185 & 272533.



Order No. 19 - 12282

Air filter replaces B&S 792105. Fits 40G-40H & 44H-44K series engines. Uses our 19-12479 prefilter.



Order No. 19 - 12479

Prefilter replaces B&S 792303. Fits 44H-Q777 series engines. Prefilter for our 19-12282 air filter. Taller version of our 19-12283.



Order No. 19 - 12283

Prefilter replaces B&S 792303. Fits 44H-Q777 series engines. Fits OEM Air Filter.

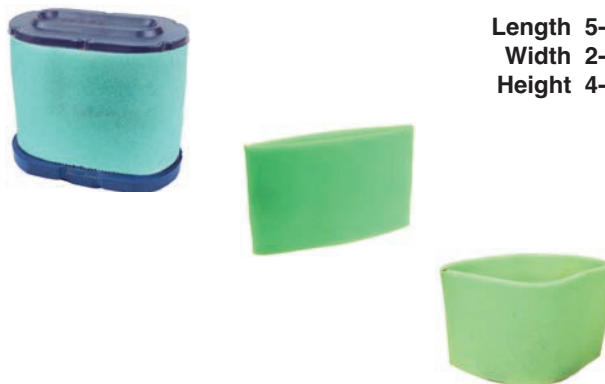

Length 5-1/8"
Width 2-3/4"
Height 4-1/2"



FILTERS

BRIGGS & STRATTON (Cont.)

Order No. 19 - 2789

Filter replaces B&S 397795. Fits models 90700, 91700, 95700, 96700, 110700, 112700, 114700, 130700, 131700 (3.5 & 4 hp) Max series engines. Also fits JD PT11025.



Length 6-1/4"
Width 4-1/2"
Height 7/8"

Order No. 19 - 8482

Prefilter replaces B&S 399039.



Length 4-5/8"
Width 4-5/8"
Height 7/8"



Order No. 19 - 2841

Filter replaces B&S 399877. Fits models 100700 (3.5 hp) Quantum engines. (Side Starter).



Length 7"
Width 3-1/8"
Height 1-1/2"

Order No. 19 - 10263

Air filter replaces B&S 697152, 613022, 6984-13. Fits models 21A900 and 21B900 series.



Order No. 19 - 10454

Prefilter replaces B&S 697292. Fit models 21A900 & 21B900, 10-10.5 Hp intek engines. Prefilter for our 19-10263 air filter.

Length 8-3/4"
Width 3-1/8"
Height 1-1/2"



Order No. 19 - 12964

Air filter replaces B&S 697153, 5078D, 5077H. Uses our 19-10304 prefilter. Fits 28, 30, 31 CID engines. Delivers up to 4 times the life of a standard paper element air filter.



Length 7-1/2"
Width 4-1/2"
Height 2"

Order No. 19 - 13049

Air filter replaces B&S 792101, 672772, 671231. Fits 44 CID OHV twin engines. Intek air filter engines 16-27 gross hp/cv v-twin. Also replaces B&S 5408H & John Deere MIU11286. Used with our 19-9304 prefilter.



Order No. 19 - 12877

Air filter replaces B&S 792038. Tri-Oval paper filter fits DOV mower engines, 100602 & 100800 series. Used with our 19-12895 prefilter.



Order No. 19 - 12895

Prefilter replaces B&S 793676. Fits DOV mower engines, 100602 & 100800. Fits our 19-12877 filter.

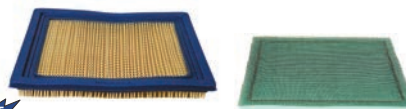

Length 7-3/8"
Width 6-5/16"
Height 3/4"

Order No. 19 - 6601

Filter replaces B&S 805113. Fits models 290400, 290700, 294400, 294700, 303400, & 303700 (12.5, 14 & 16 hp) horz. and vert. V-Twin OHV Vanguard engines.



Order No. 19 - 8480

Prefilter replaces B&S 805267.

Length 7"
Width 3-1/2"
Height 1-1/4"



Order No. 19 - 7877

Filter replaces B&S 494511. Fits 5 hp 133400 series industrial plus engines.

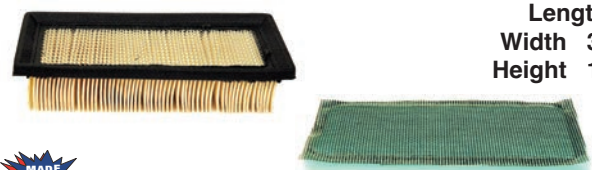

Length 7"
Width 3-1/2"
Height 1-1/2"

Order No. 19 - 7880

Filter replaces B&S 691643, 496077. Fits 8 hp industrial plus engines.

Order No. 19 - 8483

Prefilter replaces B&S 492889.



Order No. 19 - 8483

Prefilter replaces B&S 492889.

19

FILTERS



FILTERS

BRIGGS & STRATTON (Cont.)



Length 5-1/4"
Width 4-1/2"
Height 1"

Order No. 19 - 2838

Filter replaces B&S 491588, 399959. Fits models 80200, 82200, 83400, 112200, 121700, 121800, 122700, 123700, 123800, 124700, 124800, 125700, 126700, 126800, 130200, 132200 3 & 5 hp horz. and 3-1/2 - 5 hp Quantum. Top Starter. Also fits JD PT15853.

Order No. 19 - 12941

Air Filter Shop Pack replaces B&S 491588. Bulk pack for our 19-2838.

Order No. 19 - 8481

Prefilter replaces B&S 491435.

Order No. 19 - 12960

Prefilter Shop Pack replaces B&S 491435. Bulk pack for our 19-8481. MIN012



Length 8-3/4"
Width 3-1/8"
Height 1-1/2"

Order No. 19 - 10184

Air Filter replaces B&S 697153, 697014, 697634, 698083. Fits AVS models 284H07, 285H07, 286H77 and 31E700, 31G700, 31H700 series.

Order No. 19 - 12943

Air Filter Shop Pack replaces B&S 697014. Bulk pack for our 19-10184.

Order No. 19 - 10304

Prefilter replaces B&S 697015. Fits 15.5 - 17.5 intek engines. Prefilter for our 19-10184.

Order No. 19 - 13629

Prefilter Shop Pack replaces B&S 697015. Bulk pack for our 19-10304. MIN012

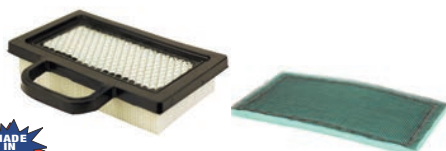

Length 7"
Width 4"
Height 1-1/2"

Order No. 19 - 9273

Filter replaces B&S 698754, 499486. Fits Intek 14-24 hp engines.

Order No. 19 - 9304

Prefilter replaces B&S 273638S.

Order No. 19 - 12942

Air Filter Shop Pack replaces B&S 499486. Bulk pack for our 19-9273.

Order No. 19 - 12946

Prefilter Shop Pack replaces B&S 273638S. Bulk pack for our 19-9304. MIN012



Order No. 19 - 12968

Air filter replaces B&S 795066. Fits models 110000, 120000, series 775, 850/875. Fits DOV engines.

Order No. 19 - 12985

Prefilter replaces B&S 796254. Fits professional series 7.75, 8.50, 8.75 engines. Models 110000-120000. Also fits DOV engines. Fits our 19-12968 air filter.



Length 8-3/8"
Width 4"
Height 1-1/8"

Order No. 19 - 8814

Air filter replaces B&S 710266. Fits 9 hp vanguard engines, model 185400.



Length 4-9/16"
Width 3-7/8"
Height 11/16"

Order No. 19 - 12886

Air filter replaces B&S 711459. Fits models 050032.



Length 8-1/8"
Width 2-3/4"
Height 1"

Order No. 19 - 7051

Filter replaces Briggs & Stratton 272922, 272405. Fits 194700 and 195700 series, (8 hp) horizontal engines.



Length 6-5/16"
Width 3-1/2"
Height 1"

Order No. 19 - 9167

Filter replaces B&S 710265. Fits 4 hp horizontal vanguard engines.

19

FILTERS



FILTERS

**Air Filter for
BRIGGS & STRATTON**

OD 4"
ID 2"
Height 4-3/4"



Order No. 19 - 14289

Air filter replaces B&S 798897. Cyclonic filter for vertical shaft engines used on Zero Turn Mowers. Fits models 44P977-49M977. Also used on TSC Huskee Riders.

**Air Filter for
BRIGGS & STRATTON**

Length 4-1/4"
Width 3-1/4"
Thickness 7/8"



Order No. 19 - 14099

Air filter replaces B&S 799579. Fits 550E-550EX series. Fits models 09P602 & 09P702.

**Air Filter for
BRIGGS & STRATTON**

OD 5"
ID 1-3/8"
Height 3-1/8"



Order No. 19 - 13641

Air filter replaces B&S 270093. Fits older style 7-16 hp.

**Air Filter for
BRIGGS & STRATTON**

OD 3"
ID 1-3/4"
Height 5"



Order No. 19 - 13644

Air filter replaces B&S 796031. Fits model series 31C700 & 31P677, 17.5 hp.



Order No. 19 - 14422

Prefilter replaces B&S 797704. Fits our 19-13644 filter.

**Air Filter for
BRIGGS & STRATTON**

OD 3"
ID 1-1/2"
Height 1-7/8"



Order No. 19 - 14089

Air filter replaces B&S 797819. Fits model 9 & 10, 4.50-6.00 ft-lbs gross torque, 450-600 series 3.0-5.0 gross HP/CV. Cartridge with gasket.

**Air Filter for
BRIGGS & STRATTON**

OD 3"
ID 1/2"
Length 3-7/8"



Order No. 19 - 14158

Air filter replaces B&S 796032. Fits model series 219807-0664-B1. Uses our 19-14423 pre-filter



Order No. 19 - 14423

Prefilter replaces B&S 798911. Fits our 19-14158 filter.

**Air Filter for
BRIGGS & STRATTON**

Width 2-1/4"
Height 2-1/2"
Length 3-1/4"



Order No. 19 - 14206

Air filter replaces B&S 796970. Fits 083152-0151-B1 & 5.5 gross torque model: 83132-0036-B1. Pre-filter included.

**Air Filter for
BRIGGS & STRATTON**

Length 4-3/8"
Width 2-1/2"
Height 1-3/8"



Order No. 19 - 14364

Air filter replaces B&S 798452. Fits models 09P702 9/10 OHV 140 CC 500-550 E & EX series walks.

19

FILTERS



FILTERS

Air Filters for BERNARD

ID 1-15/32" (37.30 mm)
OD 2-7/8" (73.02 mm)
Height 3" (76.20 mm)



Order No. 19 - 50243

Filter replaces Bernard 364. Comes with rubber insert and hose clamp.

ID 4-1/4" (107.95 mm)
OD 6" (152.40 mm)
Height 2" (50.80 mm)



Order No. 19 - 50242

Filter replaces Bernard 20062.

Air Filter for CLUB CAR

Length 7-5/8"
Width 6"
Height 1-11/64"



Order No. 19 - 8331

Air filter replaces Club Car 1015426.

Air Filter for EZ GO

Length 11-1/2"
Width 5-1/8"
Height 1-25/32"



Order No. 19 - 9571

Filter replaces EZ-GO 72144G01. Fits EZ-GO vertical twin cylinder engines.

Air Filter for EZ GO

ID 2"
OD 4-1/4"
Height 6-1/16"



Order No. 19 - 8332

Air filter replaces EZ-GO 14416GL. Replaces John Deere AM34093, AM100137, Nelson 83816A, fits Harley, Club Car & Columbia Golf Carts.

19

Air Filter for GENERAC

Length 6"
Width 3-1/4"
Height 1"



Order No. 19 - 10752

Air filter replaces Generac 78601. Fits air compressor and generator models, 0485-0, 0485-1, 0486-0, 0487-0, 0503-0, 0503-1, 0504-1 & 0602-0. Used with our 19-10753 prefilter.



Order No. 19 - 10753

Prefilter replaces Generac 78602.. Used with our 19-10752 air filter. MIN005

Air Filter for GENERAC

Length 5-1/8"
Width 4-1/2"
Height 1-1/4"



Order No. 19 - 11042

Air filter replaces Generac 73111GS. Fits models 1019-3, 7500EXL Alternator; 1786-0, 5500 Watt 5500CX, 1787-0, 5500 watt 5500CXE.

FILTERS



Air Filter Assembly for ENGINEAIRE



Order No. 19 - 9616

Air filter assembly for Engineaire. Used on many commercial units. Assembly includes our 19-9614 precleaner. Uses our 19-9550 filter.



19-9616



Order No. 19 - 9614

Precleaner for Engineaire. Precleaner for our 19-9616 air filter assembly.



19-9614



Order No. 19 - 9615

Indicator for Engineaire. Indicator for our 19-9616 air filter assembly.



19-9615



Order No. 19 - 10080

Filter safety element for Engineaire. Replaces Kubota K7561-82360 & John Deere M123378 Used with our 19-9616 & 19-9550. Length 7-1/4", ID 1-27/32", OD 3-1/2".



19-10080

Order No. 19 - 9550

Air filter replaces Toro 93-2195 & Kubota K1211-82320. Fits Toro "Z" series mowers with Kawasaki 22 hp engines. Also fits Walker 5090-01. Fits Kawasaki 12 hp on John Deere Gator M113621 & Kohler 26 hp on walker. Fits our 19-9616 assembly. Length 7-1/4", ID 1-27/32", OD 3-1/2".



19-9550

19

Safety Filter Element for KOHLER

ID 1-5/16"
OD 1-3/4"
Length 6-5/8"



Order No. 19 - 12001

Safety filter element replaces Kohler 25-083-03S, Kawasaki 11013-7039. Used with our 19-9950 & 19-9616 & 11842. Fits Nelson & Fleetguard Remote Air Filters. Import version of our 19-10080 filter.



FILTERS

Air Filters for KOHLER

ID 1-21/32"
OD 3-1/2"
Length 7-1/2"

Order No. 19 - 11842

Air filter replaces Kohler 25-083-02S. Used with our 19-10080 filter safety element. Also fits EngineAire, Donaldson & other Remote Air Filters. Import version of our 19-9550 filter.



FILTERS



Air Filter for HONDA

Length 6-1/2"
Width 4-1/2"
Height 1-3/8"



Order No. 19 - 12801

Air filter replaces Honda 17211-899-000. Fits engine models, GX240, GX270, GX340, GX390. Generator models EB3000, 4000, 5000, 6500, EM3000, 3800, 4000, 5000, 6000, 6500, EMS4000, EMS4500, EW140, EW17.



Length 8-5/8"
Width 4-3/4"
Height 7/8"



Order No. 19 - 10879

Air filter replaces Honda 17211-Z0A-013. Fits models GCV530 & GXV530, 16 hp V-twin vertical shaft units.



Length 9"
Width 6-1/2"
Height 1-1/4"



Order No. 19 - 10678

Air filter replaces Honda 17210-ZJ1-841 & Hustler 785600. Fits models 610K1, 620K1, 670, GXV610K1, GXV620K1. Used with our 19-10961 prefilter.



Order No. 19 - 12243

Prefilter replaces Honda 17218-Z0A-810. Prefilter for our 19-10879 air filter.



Order No. 19 - 10961

Pre filter replaces Honda 17218-ZJ1-840 & Huslter 785618. Fits models 610K1, 620K2, 670, GXV610K1, GXV620K1. Prefilter for our 19-10678 air filter.



Length 9-1/2"
Width 8"
Height 1-1/4"



Order No. 19 - 10679

Air filter replaces Honda 17010-ZJ1-000 & Hustler 787226. Fits models GX610, 620, GXV610, GXV620.



Length 5-3/4"
Width 3-1/2"
Height 1"



Order No. 19 - 13640

Air filter replaces Honda 17210-Z6L-010. Fits some GX630 & GX660, GX690 units.



OD 7-1/4"
ID 5-1/8"
Height 2"



Order No. 19 - 7980

Filter replaces Honda 17211-ZG9-MOO. Fits SX series, Harmony 215 model HRM215, Kohler 1408301S model XT173, MTD 751-10298.



Order No. 19 - 7979

Precleaner replaces Honda 17218-ZG9-MOO. Length 5-1/2", Width 3-1/4", Thickness 1/4".



Order No. 19 - 7979

Order No. 19 - 7712

Filter & Prefilter replaces Honda 17210-ZE3-010 & 17210-ZE3-505, code 2893907. Fits (8 thru 13 hp), models GX240, GX270, GX340 and GX390.

Length 4-3/8"
Width 3-3/4"
Height 3-5/8"

Order No. 19 - 7725

Prefilter replaces Honda 17218-ZE3-000 & 17218-ZE3-505, code 2577377.

Order No. 19 - 9473

Prefilter for our 19-7712 air filter.



19

FILTERS



FILTERS

Air Filters for HONDA

Length 7-1/2"
Width 2-1/2"
Height 1-7/8"



Order No. 19 - 6684

Filter & Prefilter replaces Honda 17210-ZE7-013, 17210-ZE7-505, code 2741627. Fits models GVX120, 140 & 160, (4 & 5 hp).



Order No. 19 - 2805

Prefilter replaces Honda 17218-888-003.

Air Cleaner Base & Cover for HONDA

ID 4-1/2"
OD 5-1/4"
Height 3/4"



Order No. 19 - 9953

Air filter replaces Honda 17211-ZL8-000, 17211-ZL8-023, code 5580402. Fits units GC 135, GCV 135 & GC160, GCV160.

Order No. 19 - 1047

Air cleaner base and cover replaces Honda 17231-ZM0-000 & 17220-ZM0-000. Fits models GCV 134/160. Uses our filter 19-9953.



Top OD 3-1/8"
Bottom OD 4-3/8"
Height 2-3/8"



Order No. 19 - 6686

Filter & Prefilter replaces Honda 172A-188-3902, code 2893915. Fits model G200 engines.



Order No. 19 - 6687

Prefilter replaces Honda 17218-883-901, code 1067131.

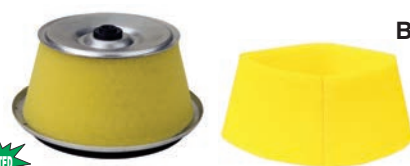

Top OD 3-7/8"
Bottom OD 5-1/4"
Height 2-5/8"



Order No. 19 - 6688

Filter & Prefilter replaces Honda 17211-890-023, code 102518. For 7, 10 & 11 hp engines. Fits model 3810 tractor and models G300 & G400.



Order No. 19 - 6689

Prefilter replaces Honda 17221-889-003.



Length 4"
Width 2-7/8"
Height 2-5/8"



Order No. 19 - 6690

Filter & Prefilter replaces Honda 17210-ZE1-821 & 17210-ZE1-505, code 2893881. Fits model GX110, GX120, GX140, GX160 (3-1/2, 5 & 5-1/2 hp) engines.



Order No. 19 - 6691

Prefilter replaces Honda 17218-ZE1-821, code 2535029.



Length 4"
Width 3-1/2"
Height 3-1/8"



Order No. 19 - 6692

Filter & Prefilter replaces Honda 17210-ZE2-822 & 17210-ZE2-505, code 2893899. Fits model GX240, GX270 (8 & 9 hp) horizontal engines.



Order No. 19 - 6693

Prefilter replaces Honda 17218-ZE2-821, code 2538429.

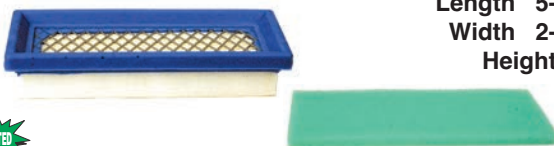

Length 5-1/4"
Width 2-1/4"
Height 1"



Order No. 19 - 8903

Filter replaces Honda 17211-ZG9-800, code 4327383. Fits models GVX 140 engine, 5 hp vertical shaft.



Order No. 19 - 8904

Prefilter replaces Honda 17218-ZG9-800, code 4327391.



Length 6-3/4"
Width 2-1/4"
Height 2"



Order No. 19 - 8906

Filter & prefilter replaces Honda 17211-ZE7-W03, code 5357389. Fits 5.5 hp vertical shaft on commercial mower models HR216 & HRA216



Order No. 19 - 8907

Prefilter.

19

FILTERS



FILTERS

HONDA (Cont.)

Length 8"
ID 1-3/4"
OD 3-5/8"



Order No. 19 - 10680

Air filter replaces Honda 17210-759-013. Fits models GX610, 620, with remote type air cleaner assembly.

Length 4-7/8"
Width 2-9/16"
Height 3-7/16"



Order No. 19 - 11793

Air filter replaces Honda 17211-ZF5-V01. Fits engine models GXV340 & GXV390.

Length 8-1/2"
Width 2-1/2"
Height 2-3/8"



Order No. 19 - 2807

Prefilter replaces Honda 17218-891-003, code 1067164.

Length 3"
Width 3-1/2"
Height 1/2"



Order No. 19 - 8905

Filter replaces Honda 17211-896-000. Fits model G100, 2 & 2.5 hp engines. Used on Honda pumps. Also fits Mclane & Powertrim edgers.

Metal/Rubber Grommet for HONDA



Order No. 19 - 6708

Replaces Honda 17232-891-000.

MIN010

Rubber Grommet for HONDA



Order No. 19 - 6707

Old Style Rubber Grommet used on Honda filters.

MIN010

19

FILTERS

Length 5"
Width 2-5/8"
Height 3-1/8"



Order No. 19 - 2808

Filter & Prefilter replaces Honda 17210-ZE8-013 & 17210-ZF5-505, code 2090207 for 8-1/2 -13 hp. Fits models GXV270, 340 & 390. Uses our 19-6707 & 19-6708 Grommet.



Order No. 19 - 2809

Prefilter.

Length 4"
Width 2-7/8"
Height 2-1/8"



Order No. 19 - 7044

Filter & Prefilter replaces Honda 17210-ZE0-822, code 2893873. Fits GX110 old 3-1/2 hp, GX120 new (4 hp) engines, also fits Tiller model 400, 401K1 horz. shaft.



Order No. 19 - 7045

Prefilter replaces Honda 17218-ZEO-821, code 2535011.

Length 6-1/2"
Width 4-1/8"
Height 1-5/8"



Order No. 19 - 7042

Filter & Prefilter replaces Honda 17211-ZA0-702 & 17210-ZA0-506, code 2893923. Fits HT3813 and 4213 tractors, also fits GX360K1 vertical engines.



Order No. 19 - 7043

Prefilter.

Length 7-1/2"
Width 2-1/2"
Height 1-5/8"



Order No. 19 - 7713

Filter & Prefilter replaces Honda 17210-ZE6-003 & 17210-ZE6-505, code 1495902. Fits (3-1/2, 4 and 5 hp), models GXV120, GV150, GV200, HR194 & HR195.



Order No. 19 - 7726

Prefilter replaces Honda 17218-888-003, code 1067149.



FILTERS

Air Filter for JOHN DEERE

Length 7-1/2"
Width 2-3/8"



Order No. 19 - 13390

Air filter replaces John Deere AM108185. Fits models F1145, F925, F932, F935, 755, 855, 955. Used with our 19-13389 outer element.

Air Filter for JOHN DEERE

Length 8-1/4"
Width 4"



Order No. 19 - 13389

Air filter replaces John Deere AM108184. Fits models F1145, F925, F932, F935, 755, 855, 955. Used with our 19-13390 inner element.

Air Filter for KAWASAKI

Length 3"
Width 3-1/2"
ID 2-5/16"



Order No. 19 - 13382

Air filter replaces Kawasaki 11029-7023. Fits models FJ180V. With prefilter.



Length 7"
Width 2-1/4"
Height 2-3/4"



Order No. 19 - 2803

Filter & Prefilter replaces Kawasaki 11013-2021. Wire Reinforced, fits (12-1/2 hp), FB-460. Also fits JD AM101191 & Wheel Horse KW10071.



Order No. 19 - 5861

Prefilter replaces Kawasaki 11013-2020. Also fits JD M88571.



Length 7-1/2"
Width 3-1/4"
Height 3-1/8"



Order No. 19 - 2828

Filter & Prefilter replaces Kawasaki 11013-2098. John Deere M97266, M70128, for model FC540, (17 hp) OHV Kawasaki equipped John Deere.



Order No. 19 - 6517

Prefilter replaces Kawasaki 11013-2097. Also fits JD M70127.



Length 4-3/4"
Width 2-5/8"
Height 2-13/16"



Order No. 19 - 6518

Filter replaces Kawasaki 11013-2093. For (9 hp) Kawasaki model FC-290Y on John Deere 30" rider model RX75. Fits John Deere M70284.



Order No. 19 - 6519

Prefilter replaces Kawasaki 11013-2092. Fits JD M70283.



Length 7"
Width 2-1/4"
Height 2-3/4"



Order No. 19 - 6567

Filter & Prefilter replaces Kawasaki 11013-2021. Fits (12-1/2 hp), FB-460. Also fits JD AM101191 & Wheel Horse KW10071.



Order No. 19 - 5861

Prefilter replaces Kawasaki 11013-2020. Also fits JD M88571.

19

FILTERS



FILTERS

Air Filter & Prefilter for KAWASAKI

Center Hole 5-15/16"
Diameter 7-7/8"
Height 2-13/16"



Order No. 19 - 9506

Air filter replaces Kawasaki 11013-7002. Fits FH-500V engine 17 hp. Width of filter and Lip 6-1/2".

Order No. 19 - 12944

Air Filter Shop Pack replaces Kawasaki 11013-7002. Bulk pack for our 19-9506. MIN012

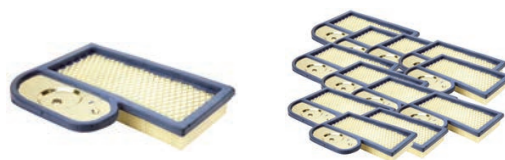

Order No. 19 - 10881

Air filter & Prefilter replaces Kawasaki 11013-2195 & 11013-2213. Fits models FD671D, FD711D, FD750D. Prefilter included. Uses our 19-10882 prefilter.



Order No. 19 - 10882

Prefilter replaces Kawasaki 11013-2194. Fits models FD671D, FD711D, FD750D. Uses our 19-10881 filter.

Length 8-1/4"

Total Width 3-13/16"

Height 1-1/2"



Order No. 19 - 9611

Prefilter replaces Kawasaki 11013-7001.



Order No. 19 - 12948

Prefilter Shop Pack replaces Kawasaki 11013-7001. Bulk pack for our 19-9611. MIN012

Air Filter for KAWASAKI



Order No. 27 - 13381

Air filter replaces Kawasaki 11029-2021. Fits backpack blower models KRB750A-A2, HG750AAS.

Length 7-1/2"

Width 3"

Height 3"



Order No. 19 - 9584

Air filter with prefilter replaces Kawasaki 11029-7012, 11029-7002, 11013-7010, 11013-7024. Fits models FH601V & FH721V, 19, 22, 23, & 25 hp engines. Uses our 19-9585 prefilter.



Order No. 19 - 9585

Prefilter replaces Kawasaki 11013-7009. Used with our 19-9584 Air Filter.



Length 8"
Width 2-1/4"
Height 1-1/4"



Order No. 19 - 10681

Air filter replaces Kawasaki 11013-21811.



OD 8"
ID 5-1/2"
Height 2-1/2"



Order No. 19 - 10880

Air filter replaces John Deere M149118. Also replaces Kawasaki 11013-7022. Fits John Deere models X465, 737, and 757 Mid Mount Z tracks. Fits Kawasaki 20-21 hp model FH641D. Uses our 19-7050 Prefilter Kawasaki 11013-7023.

Length 7-1/4"

Width 3-3/8"

OD 2-5/16"



Order No. 19 - 11230

Air filter replaces Kawasaki 11013-7031. Fits FH 381V, 450V, 541V & 580V / 13, 15, 17 & (TTHP) 19KA.



Order No. 19 - 11205

Prefilter replaces Kawasaki 11013-7025, John Deere M151768.

19

FILTERS



FILTERS

KAWASAKI (Cont.)

Length 7"
Width 3-5/8"
Height 2-1/2"



Order No. 19 - 8662

Filter replaces Kawasaki 11013-2135. Fits models FD440.



Order No. 19 - 8505

Prefilter replaces Kawasaki 11013-2134.



Length 3-5/8"
Width 2-3/8"
Height 2-1/4"

Order No. 19 - 6705

Filter replaces Kawasaki 11013-2120. Fits model FC150V vertical engines, for 4-1/2-5.5 hp for walk behind mowers. Also replaces John Deere M79451.



Order No. 19 - 7052

Prefilter replaces Kawasaki 11013-2119. Also fits JD M77555.



Length 6-1/4"
Width 2-7/8"
Height 3-1/8"

Order No. 19 - 6706

Filter replaces Kawasaki 11013-2141, 11013-2110. Fits model FC420V (14 hp) vertical engines. Also fits John Deere AM104560, M97211.



Order No. 19 - 6989

Prefilter replaces Kawasaki 11013-2109. Also fits John Deere M74285.



Base Length 4-7/8"
Base Width 4-5/16"
OD 3"
Height 2"

Order No. 19 - 7714

Filter & Prefilter replaces Kawasaki 3144AA-1312A. For (5.2 hp) model FA210 engines.



Order No. 19 - 7841

Prefilter replaces Kawasaki 11013-2010.

Air Filter for KAWASAKI

Length 7-3/4"
Width 4-1/2"
Height 2-3/4"



Order No. 19 - 9852

Air filter replaces Kawasaki 11013-2139. Fits FD620, 20 hp engines.

Order No. 19 - 9292

Prefilter replaces Kawasaki 11013-2114. Fits Kawasaki FD620 engine used on Scag mowers.



Length 8-3/4"
Width 3-5/8"
Height 2-3/4"

Order No. 19 - 9841

Air filter replaces Kawasaki 11013-2115. Fits FD590, 18 hp engines.



Order No. 19 - 9292

Prefilter replaces Kawasaki 11013-2114. Fits Kawasaki FD620 engine used on Scag mowers.



Length 8-5/8"
Width 2-5/8"
Height 1"

Order No. 19 - 10398

Filter replaces Kawasaki 11029-7021, 11029-7016. Fits 6.5hp model FJ180V-AS04 used on Cub Cadet mowers.



Order No. 19 - 10302

Pre-filter replaces Kawasaki 11013-7018. Fits models FJ180V-AS04 vertical shaft OHV engine.

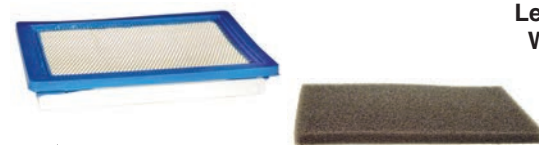

Length 7-1/4"
Width 4-1/4"
Height 1"

Order No. 19 - 10313

Air Filter replaces Kawasaki 11013-7017. Fits model FH430V.



Order No. 19 - 10305

Prefilter replaces Kawasaki 11013-7016. Prefilter for our 19-10313.

19

FILTERS

FILTERS

Air Filter for KAWASAKI



Order No. 19 - 14207

Air filter replaces Kawasaki 11013-7050. Fits models FR541V (18 hp) FR600V (20 hp).

Air Filter for KAWASAKI

OD 4-1/8"
ID 3-1/8"
Height 10-3/4"



Order No. 19 - 12786

Air filter replaces Kawasaki 11013-7038 (outer filter). Fits models FX751V, FX801V, FX850V, FX921V, FX1000V. Used with our 19-12787 inner filter.



Order No. 19 - 12787

Air filter replaces Kawasaki 11013-7039 (inner filter). Fits models FX751V, FX801V, FX850V, FX921V, FX1000V. Used with our 19-12786 outer filter.

OD 3"
ID 1-1/2"
Height 10"



Order No. 19 - 12758

Air filter replaces Kawasaki 11013-7049. Fits models FR481V, FR600V, FR651V, FR691V, FR730V engines. Used on Cub Cadet Mowers. Used with our 19-12797 prefilter.



Order No. 19 - 12797

Prefilter replaces Kawasaki 11013-7046. Fits 11013-7047 / 11013-7049, used on models FS481V, FS541V, FS600V, FS730V, FR651V, FR691V, 22 thru 26 hp engines. Fits our 19-12758 air filter.



Length 6-5/8"
Width 2-3/4"
Height 3"

19

FILTERS

True Flow Air Filter



Order No. 19 - 12395

True flow filter replaces our 19-9550 & 19-11843. Fits our 19-10080 Engine Air Cleaner Assembly. Length 7-1/4", OD 3-1/2".



Order No. 19 - 12402

True flow filter replaces our 19-9583 & 19-11841. Fits Nelson/Fleetguard Donaldson Air Cleaner Assemblies. Length 10-1/2", OD 4". Uses our 32-12418 Cleaning kit.



True Flow stops more dirt due to its superior foam technology. Foam has been used for years in off road applications such as motorcycles, ATV's, and Off-Road race vehicles. True Flow developed an air filter using fully reticulated foam cells and specially formulated tackifier that create an impossible journey for dirt particles to enter your engine.



FILTERS

KOHLER Air Filter



Order No. 19 - 1208305S
Kohler 1208305S OEM air filter. For CV11-CV16.

Order No. 19 - 1208308S 
Kohler 1208308S OEM pre cleaner filter. For CV11-CV16.



Order No. 19 - 1288305S1
Kohler 1288305S1 OEM carded air filter. For Command CV11-CV16 hp engines.



ID 3-3/8"
OD 4-1/2"
Height 2-13/16"



Order No. 19 - 6605
Filter replaces Kohler 12-083-05. Fits (11, 12-1/2 and 14 hp) vertical OHV Kohler Command engines on Snapper. Fits John Deere AM121608, M92359.

Order No. 19 - 12935
Air Filter Shop Pack replaces Kohler 12-083-05. Bulk pack for our 19-6605. MIN012



Order No. 19 - 6606
Prefilter replaces Kohler 12-083-08. Also fits John Deere M92360.

KOHLER Air Filter



Order No. 19 - 1208310S
Kohler 1208310S OEM air filter. For Pro CV11-CV16 & CV460-CV493.

Order No. 19 - 1208312S 
Kohler 1208312S OEM pre cleaner filter. For Pro CV11-CV16 & CV460-CV493.



Order No. 19 - 1288310S1
Kohler 1288310S1 OEM carded air filter. For Command Pro CV11-CV16 & CV460-493 engines.

ID 3-1/4"
OD 4-1/2"
Height 3-9/32"



Order No. 19 - 8235
Filter replaces Kohler 1208310. Fits CV11, CV12.5, CV14, Large capacity engines.



Order No. 19 - 8712
Prefilter replaces Kohler 12-083-12. Fits CV11, CV14 engines.

Rain Hood for KOHLER



Order No. 19 - 12713
Rain hood replaces Kohler 25-324-02-S.



OD 5-1/4"
ID 2"
Height 2-7/8"

19

FILTERS



FILTERS

KOHLER Air Filter



Order No. 19 - 2508301S

Kohler 2508301S OEM air filter. For CV18-750, CH18-750, LV625-680, LH640-775, C940-980.



Order No. 19 - 2508304S

Kohler 2508304S OEM air filter safety. For CV18-750, CH18-750, LV625-680, LH640-775, C940-980.

KOHLER Air Filter



Order No. 19 - 2508302S

Kohler 2508302S OEM air filter. For CV493, Triad OHC.

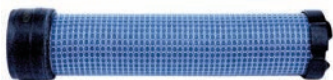

Order No. 19 - 2508303S

Kohler 2508303S OEM air filter. For CV493, Triad OHC.



Order No. 19 - 10080

Filter safety element for Engineaire. Replaces Kubota K7561-82360 & John Deere M123378 Used with our 19-9616 & 19-9550.

OD 4"
ID 2-13/32"
Height 10-1/2"



Order No. 19 - 9583

Filter replaces Kohler 25-083-01, Generac OE3557, Hustler 785261, Exmark 103-1327. Fits Toro Z-Master 200 series. Mid mount design "ZERO TURN" mowers with Kohler Command pro engines 23 & 25 hp. 52", 62" & 72" cut units.



Order No. 19 - 9728

Prefilter replaces Kohler 2508304, Generac OE3656. Fits our 19-9583 air filter.



Order No. 19 - 11865

Safety filter element replaces Kohler 25-083-04S. Used with our 19-9583 & 19-11841. Fits Nelson & Fleetguard Remote Air Filters. Import version of our 19-9728 filter.



Length 10-1/2"
OD 4"
ID 2-21/32"



Order No. 19 - 11841

Air filter replaces Kohler 25-083-01S & Kawasaki 11013-7020. Used with our 19-9728 filter safety element. Also fits Nelson & other Remote Air. Import version of our 19-9583 filter.



Length 7-1/2"
OD 3-1/2"
ID 1-21/32"



Order No. 19 - 11842

Air filter replaces Kohler 25-083-02S. Used with our 19-10080 filter safety element. Also fits EngineAire, Donaldson & other Remote Air Filters. Import version of our 19-9550 filter.



Order No. 19 - 12001

Safety filter element replaces Kohler 25-083-03S, Kawasaki 11013-7039. Used with our 19-9950 & 19-9616 & 11842. Fits Nelson & Fleetguard Remote Air Filters. Import version of our 19-10080 filter.

19

FILTERS



FILTERS

KOHLER Air Filter



Order No. 19 - 1408301S

Kohler 1408301S OEM air filter. For Courage XT series.

Order No. 19 - 1408302S

Kohler 1408302S OEM pre cleaner filter. For Courage XT series.



Order No. 19 - 1408301S1

Kohler 1408301S1 OEM carded air filter. For Courage XT-6 & XT-7 series.

KOHLER Air Filter



Order No. 19 - 2008306S

Kohler 2008306S OEM air filter. For Courage single SV470-SV620, 15-22 hp engines.



Order No. 19 - 2088306S1

Kohler 2088306S1 OEM carded air filter. For Courage single CV470-620, 15-22 hp engines.

KOHLER Pre Cleaner Filter

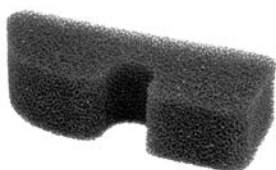

Order No. 19 - 2008304S

Kohler 2008304S OEM pre cleaner filter. For Courage single SV470-620.

Length 5-3/4"
Width 3-1/2"
Height 1"

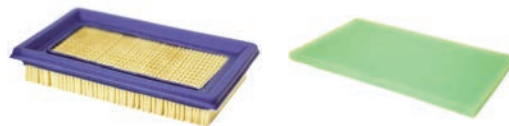

Order No. 19 - 7980

Filter replaces Kohler 1408301S. Fits model XT173, MTD 751-10298.



Order No. 19 - 7979

Prefilter for our 19-7980.

KOHLER Air Filter

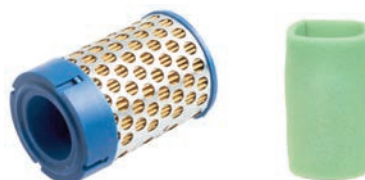

Order No. 19 - 1708307S

Kohler 1708307S OEM air filter. For Command Pro CH270.

Order No. 19 - 1708312S

Kohler 1708312S OEM pre cleaner filter. For Command Pro CH270.



Order No. 19 - 1788307S1

Kohler 1788307S1 OEM carded air filter. For Command Pro CH270.



Order No. 19 - 12289

Prefilter replaces Kohler 20-083-04s / 20-083-03s. Fits Courage single cylinder 15-20 hp models SV470 thru SV610. Goes with patented filter 20-083-02S.

19

FILTERS

FILTERS



KOHLER Air Filter



Order No. 19 - 2408303S

Kohler 2408303S OEM air filter. For CV18-CV25, CV675-CV740, CH18-25, CH730-750.

Order No. 19 - 2408305S

Kohler 2408305S OEM pre cleaner filter. For CV18-CV25, CV675-CV740, CH18-25, CH730-750.



Order No. 19 - 2488303S1

Kohler 2488303S1 OEM carded air filter. For CV18-CV25, CV675-CV740, CH18-25, CH730-750.

ID 5-1/2"
OD 7"
Height 3"



Order No. 19 - 8329

Filter replaces Kohler 2408303. Fits CH25 Command 25 hp OHV engine. Also fits CV18, 20, 22 & 26.



Order No. 19 - 8966

Prefilter replaces Kohler 24-083-05. Prefilter for our 19-8329 air filter.

KOHLER Air Filter



Order No. 19 - 235116S

Kohler 235116S OEM air filter. For K241-321, M8.

Order No. 19 - 237421S

Kohler 237421S OEM pre cleaner filter. For K241-321.



Order No. 19 - 2588303S1

Kohler 2588303S1 OEM carded air filter. For Magnum 8 hp and K241-K321, M8, 10-14 hp engines.

ID 4-3/4"
OD 6"
Height 1-7/8"



Order No. 19 - 1386

Filter replaces Kohler 235116, fits models K241, K301, K321, & M8 (8 thru 14 hp) Magnum engines. Also fits Gravely 10900, Cub Cadet 385168R2, I.H.C. 385168R2, Case A70090/C-28883, John Deere AM31400, Tecumseh 32008 and Wisconsin LO194A.



Order No. 19 - 1377

Prefilter replaces Kohler 237421. Also fits Gravely 19332, John Deere M45800.

Carded KOHLER Air Filter

Order No. 19 - 1888301S1

Kohler 1888301S1 OEM carded air filter. For Courage SH265.



19

FILTERS



Air Filters for KOHLER

ID 5-1/2"
OD 7"
Height 2-1/2"



Order No. 19 - 1389

Filter replaces Kohler 4708303 and John Deere M47494. Application: Fits (10 thru 20 hp) models K241, K301, K321, K361.



Order No. 19 - 7785

Prefilter replaces Kohler 41-083-04.



Order No. 19 - 9245

Prefilter replaces Kohler 24-083-02. Prefilter for our 19-1389. Thinner version of our 19-7785.

KOHLER Air Filter



Order No. 19 - 4708303S

Kohler 4708303S OEM air filter. For CV17-CV23, CV724-CV740, CH18-25, CH730-740.

Order No. 19 - 2408302S

Kohler 2408302S OEM pre cleaner filter. For CV17-CV23, CV724-CV740, CH18-25, CH730-740.



Order No. 19 - 4788303S1

Kohler 4788303S1 OEM carded air filter. For Command CH18-23 hp and CV17-23 hp engines, CV17-CV23, CV724-CV740, CH730-740.

KOHLER Air Filter



Order No. 19 - 3208303S

Kohler 3208303S OEM air filter. For Courage twin SV710-740.

Order No. 19 - 3208305S

Kohler 3208305S OEM pre cleaner filter. For Courage twin CV710-740.



Order No. 19 - 3288303S1

Kohler 3288303S1 OEM carded air filter. For Courage twin SV710-740.

ID 4" x 2-3/4"
OD 5-3/4" x 4-3/8"
Height 1-3/4"



Order No. 19 - 11505

Air filter replaces Kohler 32-083-03-S. Fits SV710-SV740. Uses our 19-7726 pre-filter.



Order No. 19 - 7726

Prefilter replaces Kohler 3208305S.

KOHLER Air Filter



Order No. 19 - 231847S

Kohler 231847S OEM air filter. For K181.

Carded KOHLER Air Filter



Order No. 19 - 1788303S1

Kohler 1788303S1 OEM carded air filter. For Command Pro CH395/440.



FILTERS



KOHLER (Cont.)



Order No. 19 - 3208306S

Kohler 3208306S OEM air filter. For Courage Pro twin SV810-840.

Order No. 19 - 3208308S

Kohler 3208308S OEM pre cleaner filter. For Courage Pro twin SV810-840.



Order No. 19 - 3288306S1

Kohler 3288306S1 OEM carded air filter. For Courage Pro twin SV810-840.



OD 5-3/4" x 4-3/8"
ID 4" x 2-3/4"
Height 3-1/8"



Order No. 19 - 12674

Air filter replaces Kohler 32-083-06-S. Fits SV810-SV830 series engines. Taller version of our 19-11505. Uses our 19-12674 pre-filter.



Order No. 19 - 12676

Prefilter replaces Kohler 32-083-08-S. Fits SV810-SV830 Courage PRO Twin series. Prefilter for our 19-12674.

KOHLER Air Filter

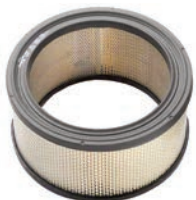

Order No. 19 - 4508302S

Kohler 4508302S OEM air filter. For CV17-25, CV675-740 and K341, M10-16, KT Dome Style.

Order No. 19 - 4508301S

Kohler 4508301S OEM pre cleaner filter. For CV17-25, CV675-740, K341, M10-16, KT Dome Style.



Order No. 19 - 4588302S1

Kohler 4588302S1 OEM carded air filter. For Command Pro CV17-25, CV675-740 and K341, M10-16, KT Dome Style.



ID 4-3/4"
OD 6"
Height 3"



Order No. 19 - 1388

Filter replaces Kohler 4508302, fits (10 thru 18 hp) Magnum engines. (Vertical shaft engines). Application: Fits K341, MV16 thru 20 & M10 thru M16. Also fits Onan 140-1216, Cub Cadet 61606C/1759-3359, Massey-Ferguson 1044-627-M1, Gravely 34776/43644, John Deere AM37201. Also fits Dixie Chopper 20 hp Magnum engines.



Order No. 19 - 2844

Prefilter replaces Kohler 45-083-01. For (18 & 20 hp) Magnum engine. Also fits Case C-20405, Gravely 34768/46346, John Deere ET12340.



Order No. 19 - 10212

Prefilter replaces Kohler 2808302-A. Fits our 19-7035 air filter.



19

FILTERS



FILTERS

KOHLER Air Filter



Order No. 19 - 4708301S

Kohler 4708301S OEM air filter. For CH11-16 and KT series square style.

Order No. 19 - 5208301S



Kohler 5208301S OEM pre cleaner filter. For CH11-16 and KT series square style.



Order No. 19 - 4788301S1

Kohler 4788301S1 OEM carded air filter. For Command CH11-16 hp and Magnum 18-20 hp & FT17-19 hp engines. KT series square style.



ID 5-5/8"
OD 7"
Height 1-3/4"



Order No. 19 - 2774

Filter replaces Kohler 4708301, Cub Cadet 117210C1/759-3547, John Deere M83646, I.H.C. 117210C. Fits models KT17, KT19 & M18 thru 20 (17 thru 20 hp) Magnum series horiz. shaft engines. Also used on Grazer, Snapper "ZERO TURN".



Order No. 19 - 5863

Prefilter replaces Kohler 52-083-01. Also fits John Deere M83681.

ID 3"
OD 4-3/8"
Height 1-1/2"



Order No. 19 - 1384

Filter replaces Kohler 230840. Fits models K-91 thru K161, for (4 hp) H40, HH40, (4.5 hp) H45D, HB45D, HR45D, (5 hp) H50, HH50, H55D, HB55D, HR55D (6 hp) H60, HH60, (7 hp) H70, HH70, Tecumseh 30804, Clinton 005-0233-00, Cub Cadet 385163R2, Gravely 20299, John Deere AM31034, I.H.C. 385163R2, Massey-Ferguson 1035-991-M1.



Order No. 19 - 5934

Prefilter replaces Kohler 234870.

ID 4-3/4"
OD 6"
Height 4"



Order No. 19 - 1387

Filter replaces Kohler 277138. For (20 hp) K532, (23 hp) K582, K301, K321, (12 & 14 hp).



Order No. 19 - 6516

Prefilter replaces Kohler 277593.

Length 4"
Width 4"
Height 7/8"



Order No. 19 - 9653

Prefilter replaces Kohler 15-083-05.

19

FILTERS

FILTERS



ID 3-5/32"
OD 4-1/2"
Height 4-1/4"



Order No. 19 - 9989

Air filter replaces Kohler 28-083-04. Fits models TH16-18 OHC engines.



ID 3"
OD 4-3/8"
Height 2-1/4"



Order No. 19 - 1385

Filter replaces Kohler 231847, Tecumseh 31925, John Deere AM30800, Gravely 15373, Onan 140-1188. Application: Fits K181 (8 hp). Fits Tecumseh HH80, HH100, HH120, VH80, VH100. Cub Cadet 548436R1. El Smith air compressor 2557. ROL-AIR (air comp.) 431.



Order No. 19 - 10213

Prefilter replaces Kohler 2808306-S. Fits our 19-9989 air filter.



Order No. 19 - 2780

Prefilter replaces Kohler 234869.

Air Filters for KUBOTA

ID 1-11/16"
OD 3-9/32"
Height 7-1/4"

Length 8"
Width 2-1/8"
Height 2"



Order No. 19 - 8279

Air filter replaces Kubota 70000-11221 & 15222-11221. Also replaces Grasshopper 100940, John Deere CH-15451, Onan 140P842, Toro 33-1300, 108-3808. Fits models B5100, B5200, B6100, B6100DT, B6100HST, B7100, B7100DT, B7100HST, B8200HST, L225, L225DT, L235, L245, L245DT, L245H, L260H (21 & 24 hp), L275.



Order No. 19 - 7046

Filter & Prefilter replaces Kubota 12681-11220. Used on (5 hp) self-propelled mowers.



Order No. 19 - 7047

Prefilter.

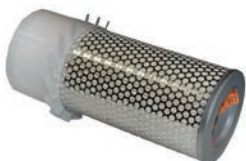

ID 2-1/2"
OD 4"
Height 10-1/4"



Order No. 19 - 8328

Filter replaces Kubota 70000-11081. Also replaces John Deere CH12767, Toro 27-7110, Bobcat 48426, Dixie Chopper 90122. Fits models L275, 285, 295, 295DT, 305, 345, 345DT, 355SS, 2250, 2550, 2850, 2650, 2950, 3450, 3650, M4000, 4050, 4500, 4500C, 4500DT.



ID 1-11/16"
OD 3-1/4"
Height 7-1/4"



Order No. 19 - 8327

Filter replaces Kubota 15852-11082. Fits models B20, B1550 & B1750, D, E, HSD, HSE, HST; G-1800S, G-1900HST, G-2000, G-2000S, G-3200, G4200H, G-5200H, G-6200H.

19

FILTERS



Inner Filter for KUBOTA

OD 2-1/8"
ID 1-5/8"
Height 9-1/4"



Order No. 19 - 13384

Inner Air filter replaces Kubota K3181-82250. Fits ZD326 diesel zero turn mower with Kubota D1005, 3 cylinder diesel.

OD 4-1/2"
ID 2-1/2"
Height 9-3/4"

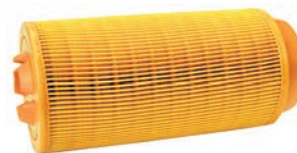

Order No. 19 - 13383

Air filter replaces Kubota K3181-82240. Fits ZD326 diesel zero turn mower with Kubota D1005, 3 cylinder diesel.

Air Filters for LAWN-BOY

Length 4"
Width 2"
Thickness 7/8"



Order No. 19 - 1379

Filter replaces Lawn-Boy 607580. Application: Fits C & D series engines.

Length 6-1/2"
Width 3-7/8"
Height 7/8"



Order No. 19 - 6659

Filter replaces Lawn-Boy 613361. Fits all M series engines including oil injected.



Order No. 19 - 1380

Filter replaces Lawn-Boy 609493. Fits F series engines from 1978 & up.

Length 4-1/2"
Width 2-1/2"
Thickness 1"



Order No. 19 - 6660

Prefilter replaces Lawn-Boy 614245, 613435.



Order No. 19 - 10183

Air filter replaces Lawn-Boy 95-5574. Fits late model 2-cycle mowers.

Length 5-1/2"
Width 3"
Height 1-1/4"



Order No. 19 - 2779

Filter replaces Lawn-Boy 602016. Fits C & D series engines.



Order No. 19 - 1378

Filter replaces Lawn-Boy 604274. Application: Fits C, D & F series and older models.

OD 3-1/4"
Thickness 1-1/4"

19

FILTERS

FILTERS

Air Filters for ONAN

ID 3-1/8" -1"
OD 4-1/8" -2"
Height 3-3/4"



Order No. 19 - 6584

Filter replaces Onan 140-2588, 140-2535, 140-2331. Fits model E125V, (12-1/2 hp) engines. Also fits Wheel Horse NN10872



Order No. 19 - 7419

Prefilter replaces Onan 140-2335. Also fits Wheel Horse NN10898

ID 6-1/2"
OD 8"
Height 2"



Order No. 19 - 2790

Filter replaces Onan 140-2628/140-1228. Fits models NHA, NHB, B43, P216, P220, P224, NHC, T260 and P218. (16-20 hp) engines. Fits Bobcat Twin-Trac 2000, John Deere AM106953, Wheel Horse NN10774.



Order No. 19 - 7050

Prefilter replaces Onan 140-1496. Also fits Wheel Horse NN10176.



ID 3"
OD 4-3/8"
Height 2-1/4"



Order No. 19 - 1385

Filter replaces Onan 140-188.



Order No. 19 - 2780

Prefilter.

Length 7-3/4"
Width 4-13/32"
Height 2-9/64"



Order No. 19 - 10708

Air filter replaces Onan 140-3010. Fits 12.5 to 14 hp E125V, E140V, E125V (Begin Spec C), E140V (Begin Spec C), E125H, E140H. Fits Cub Cadet models 2140, 2145, 2146. Uses our 19-1377 prefilter.

19

FILTERS

ID 2-3/4"
OD 4"
Height 3-1/8"



Order No. 19 - 2792

Filter replaces Onan 140-2379, 140-1891.

ID 6-3/8"
OD 8-1/4"
Height 3-13/16"



Order No. 19 - 6583

Filter replaces Onan 140-2523, 140-1911, 140-262-802. Fits (24 hp) engines.



ID 3"
OD 4-3/8"
Height 3-3/8"



Order No. 19 - 2791

Filter replaces Onan 140-0495. Fits models BFA, BGA, CKA, CCKB, NH, NHB, NHC.



Order No. 19 - 7209

Prefilter replaces Onan 140-1912. Fits (24 hp) Onan on Dixie Chopper, Wheel Horse and other commercial mowers.



FILTERS

Air Filters for ONAN

ID 5-1/8" -2-3/4"
OD 6-3/4" -4-1/4"
Height 3"



Order No. 19 - 6585

Filter replaces Onan 140-2597 and 140-2199. Fits (16 & 20 hp) engines.



Order No. 19 - 7420

Prefilter replaces Onan 140-2255.

Air Filter for ROBIN

Length 4-7/8"
Width 2-3/8"
Height 1-13/16"



Order No. 19 - 9748

Air filter replaces Robin 261-32601-07. Air filter cartridge with prefilter fits EH-18V.



Order No. 19 - 9904

Foam prefilter for our 19-9748 air filter only. Fits model EH-18V.

Air Filter for ROBIN / SUBARU

OD 3-5/8"
ID 2-1/2"
Height 1-1/2"



Order No. 19 - 14464

Air filter replaces Robin 274-32603-07. Fits model EH-09, 4 cycle, 2.4 HP OHV. Used on Dirt Tamper: Mikasa, Wacker.

Air Filter for ROBIN / SUBARU

Width 3-5/16"
Height 2-3/4"
Length 5-3/4"



Order No. 19 - 14431

Air filter replaces Robin 279-32607-17 / 279-32607-07, Wacker 0156753. Fits Subaru / Robin EX27, 9 hp engines. Prefilter included.

Air Filter for ROBIN

Width 2"
Height 1-7/8"
Length 4-1/2"



Order No. 19 - 14648

Air filter replaces Robin 277-32611-07, 252-32602-07, 277-32606-18, 20A-32636-00 & Wacker 01156759. Fits models Wacker WM130 & WM170, Robin EX13, EX17, EX21. For 4.5, 6 and 7 hp engine specifications.

19

FILTERS

FILTERS



**Air Filters for
TECUMSEH**



OD 2-13/16"
Top ID 1/4"
Bottom ID 1-7/64"
Height 4-1/2"

Order No. 19 - 9533

Air filter replaces Tecumseh 34700B. Fits HM70 - 100 model, 8 hp horizontal engines.



Order No. 19 - 11473

Air filter replaces Tecumseh 37360. Fits models OV691EA, OV691EP, TVT69 & VTX691.

Length 7-1/4"
Width 6-7/8"
Height 1-1/4"



Length 7-1/4"
OD 2"
Neck Length 5/8"
OD 1"



Order No. 19 - 2798

Filter replaces Tecumseh 35102. Used on Tecumseh powered Snappers.



Length 7-3/16"
Width 2-1/4"
Height 3/4"



Order No. 19 - 5940

Filter replaces Tecumseh 35500. Fits model TVS, 75, 90, 100, 105, 120, & TVXL105.



Order No. 19 - 5955

Prefilter replaces Tecumseh 35705. Length 6-1/4", Width 1-1/2", Height 1/2".



Order No. 19 - 2799

Prefilter replaces Tecumseh 35103. For Tecumseh powered Snappers.

19



Length 2-3/4"
Width 1-3/4"
Height 2-27/32"



Order No. 19 - 9200

Air filter replaces Tecumseh 36905. Fits models LEV 100, 115 and 120. Also fits 4-1/2", 5 and 5-1/2" hp engines.



Length 8"
Width 2"
Height 2-1/4"



Order No. 19 - 2829

Filter replaces Tecumseh 35403. Fits models TVXL195, 200 & OVXL120 for 12 hp Vert. engines.



Order No. 19 - 5862

Prefilter replaces Tecumseh 35404.

Order No. 19 - 12953

Air filter Shop Pack replaces Tecumseh 36905. Bulk pack for our 19-9200. MIN012

Length 3"
Width 3"
Height 3/4"



Order No. 19 - 2839

Filter replaces Tecumseh 450247. For (4 hp) XL series, model TVXL840.





ID 1-1/8"
OD 2-7/8"
Height 3-1/2"
Bottom Plate hole 1/4"



Order No. 19 - 6515

Filter replaces Tecumseh 34782A. Used on Snapper V-21 and Toro with (4 hp) 2 cycle Tecumseh engines. Fits models TVS840, TVXL105 thru 120 & HH60, 70.



Order No. 19 - 6553

Prefilter replaces Tec. 34783. Fits model TVS840.

TECUMSEH (Cont.)

ID 7/8"
OD 1-3/4"
Height 2-7/8"



Order No. 19 - 2784

Filter replaces Tecumseh 35066. Fits TVS, TC, ECV series & H35. Also replaces Sears 63087A, model 1972 & up with plastic canister.



Order No. 19 - 12784

Air filter for Tecumseh. (carded)

MIN005



Order No. 19 - 6847

Prefilter replaces Tecumseh 35435. Precleaner for our paper filter 19-2784.

Order No. 19 - 12934

Air Filter Shop Pack replaces Tecumseh 35066. Bulk pack for our 19-2784.

Length 3"
OD 2"
Neck Length 3/4"
OD 1"



Order No. 19 - 1395

Filter replaces Sears Eager 1 and Tecumseh 32972. Application: (3 hp) H30, (3.5 hp) H35, TVS90, (4 hp) TVS105, TVXL105, LAV30, LAV35, LAV40, (5 hp) LAV50 & ECV.

19

ID 2-3/8"
OD 3-3/4"
Height 2"



Order No. 19 - 1390

Filter replaces Tecumseh 30727. Fits models LAV, VH40 thru 70, HH60 thru 70, HM80, HS40 thru 50 for (3 hp to 8 hp) and most horizontal and vertical shaft engines. Cub Cadet 488619, John Deere AM30900. **Metal Top.**



Order No. 19 - 9795

Prefilter replaces Tecumseh 35974. Prefilter for our 19-1390 air filter.

Order No. 19 - 14188

Air filter replaces Tecumseh 35066 with screen. Fits TVS, TC, ECV series & H35. Also replaces Sears 63087A, model 1972 & up with plastic canister.



Length 2-3/4"
Width 1-3/4"
Height 2-1/8"



Order No. 19 - 8785

Air filter replaces Tecumseh 36745. Fits 5.5 hp centura engines.

FILTERS

Length 4-1/2"
Width 2-7/8"
Height 2-1/4"



Order No. 19 - 2775

Filter replaces Tecumseh 33268. Application: Fits (7, 8 & 10 hp). Fits HM70, H80, HM80, HM100.



Order No. 19 - 1394

Filter replaces Sears Eager 1 filter and Tecumseh 32796. Application: TVS75, (3.5 hp) TVS90, (4 hp) TVS105, TVXL105, TVS120 series.

Length 6"
OD 2"
Neck Length 3/4"
OD 1"



FILTERS



TECUMSEH (Cont.)

Order No. 19 - 1385

Filter replaces Tecumseh 31925. Fits Tecumseh HH80, HH100, HH120, VH80 and VH100.



ID 3"
OD 4-3/8"
Height 2-1/4"

Order No. 19 - 2780

Prefilter.



ID 4-3/4"
OD 6"
Height 1-7/8"

Order No. 19 - 1386

Filter replaces Tecumseh 32008.

Order No. 19 - 1377

Prefilter.



Length 7-1/8"
Width 2-3/4"
Height 3-1/16"



Order No. 19 - 7732

Filter replaces Tecumseh 36356. Fits Tecumseh (15 hp) OHV engine. Models YT15H, YT004 and YT005.

Order No. 19 - 7746

Prefilter. Fits Tecumseh 36357.



Order No. 19 - 1381

Filter replaces Tecumseh 31700. Application: (3 hp H22, H25, H30) (3.5 hp H35, LV35, LAV35) (4 hp H40, HS40, LAV40, V40) (5 hp H50, HS50, LAV50, V50, VH50) (6 hp H60, HH60, V60, VH60) (7 hp HH70, HM70, V70, VH70) (8 hp H80, HM80).



Dia. 3-3/4"
Height 2-3/16"

19

FILTERS



OD 2-1/2" to 3-3/8"
Thickness 2-1/4"



Order No. 19 - 1382

Filter replaces Tec. 29961. Application: (2.2 hp H22, LAV22), (2.5 hp H25, LAV25), (3 hp H30, LAV30), (3.5 hp H35, LV35, LAV35), (4 hp HS40, LAV40), (5 hp LAV50), (9 hp ECH90, TVS90, TVS105, TVS75, TVXL105, TVS120).



Length 6-3/8"
Width 2-3/4"
Thickness 1-7/8"



Order No. 19 - 2783

Filter replaces Tecumseh 34910.



Length 6"
Width 2-1/2"-3"
Thickness 1-1/2"



Order No. 19 - 1392

Filter replaces Tecumseh 33631. Application: (4 hp V40, VH40), (5 hp V50, VH50), (6 hp VH60), (7 hp VM70), (8 hp V80, VM80, V60-VM100, V70).



Length 4"
Width 2"
Thickness 1-11/16"



Order No. 19 - 1383

Filter replaces Tecumseh 33896. Application: Fits Toro Grassmaster. TNT100, TNT120 models.



Length 2-7/8"
Width 2-3/8"
Thickness 1-7/8"



Order No. 19 - 1393

Filter replaces Tecumseh 33006. Application: Fits Toro mowers. (3.5 hp TVS90), (4 hp TVS105, TVXL105), (5 hp LAV50, TVS75, TVS120, TVS150).

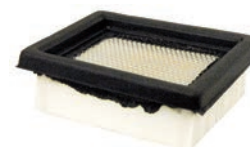

Length 3-7/8"
Width 3-7/16"
Height 1-3/8"



Order No. 19 - 8330

Filter replaces Tecumseh 36046. Fits Vector World engine 4-5-1/2 hp.



FILTERS

TECUMSEH (Cont.)



ID 3"
OD 4-3/8"
Height 4-3/4"



Order No. 19 - 6849

Filter replaces Tecumseh 32355. Fits (8, 10, 12 hp) engines. Models HH80, HH100 and HH120. Also fits JD AM31000.

Length 5-1/8"
Width 1-1/2"
Height 1-1/8"



Order No. 19 - 6848

Filter replaces Tecumseh 35604. Fits models TVS75 and TVS90.

Length 5-1/4"
Width 1-3/4"
Height 1-5/8"



Order No. 19 - 2842

Filter replaces Tec. 34340. For TVS75, TVS 90, 105, TVS120, Excel 105.

Air Filters for TORO

OD 3-1/2"
ID 1-27/32"
Length 7-1/4"



Order No. 19 - 9550

Air filter replaces Toro 93-2195 & Kubota K1211-82320. Fits Toro "Z" series mowers with Kawasaki 22 hp engines. Also fits Walker 5090-01. Fits Kawasaki 12 hp on John Deere Gator M113621 & Kohler 26 hp on walker. Fits our 19-9616 assembly.

Length 6-9/16"
Width 3-3/8"
Height 1-1/8"



Order No. 19 - 6991

Filter replaces Toro 63-9380. Used on 2-cycle Suzuki equipped Toro mowers.

Length 7"
Width 2"
Height 1-1/4"



Order No. 19 - 2843

Filter replaces Toro 81-4120 for Toro/Suzuki OHV 4-cycle engines.

Length 6-3/4"
Width 3-5/8"
Height 1-1/4"



Order No. 19 - 2782

Filter replaces Toro 81-0100. For 2-cycle Suzuki engine.

Length 5-1/2"
Width 3-11/16"
Height 1-3/8"



Order No. 19 - 7165

Filter replaces Wisconsin/Robin 2063600303 Std. Duty Air Filter. Fits engine models EY25W and EY27W.

ID 2-1/16"
OD 3-7/16"
Height 4-3/16"



Order No. 19 - 2781

Filter replaces Wisconsin L0173B.

ID 2"
OD 4-1/4"
Height 4"



Order No. 19 - 2785

Filter replaces Wisconsin L0175E.

19

FILTERS



FILTERS

WISCONSIN/ROBIN (Cont.)



Top OD 3-1/2"
Bottom OD 4-3/4"
Height 2-1/2"



Order No. 19 - 6704

Filter replaces Wisconsin/Robin 2073260008. Fits model EY27, (7-1/2 hp) horizontal engines.



Top OD 2-5/8"
Bottom OD 4-3/8"
Height 4-1/8"



Order No. 19 - 7715

Filter replaces Wisconsin/Robin 210-32601-28. Fits twin cylinder 16 hp model EY21W.



ID 1-3/4"
OD 2-3/8"
Height 2-1/4"



Order No. 19 - 7036

Filter & Prefilter replaces Wisconsin/Robin 1063270407. Fits EC-10 and EZ-08 engines.

Order No. 19 - 7037

Prefilter.



Top OD 2-1/2"
Bottom OD 4-1/4"
Height 3-1/2"



Order No. 19 - 7038

Filter & Prefilter replaces Wisconsin/Robin 207326018. Fits EY-27, EY-25, WI-340, WI-390 engines.



Order No. 19 - 7039

Prefilter.



Top OD 2"
Bottom OD 3-13/16"
Height 2-3/8"



Order No. 19 - 7040

Filter & Prefilter replaces Wisconsin/Robin 2263261007. Fits model W1185, (4.6 hp) vertical shaft engine.



Order No. 19 - 7041

Prefilter.



Top OD 2-13/16"
Bottom OD 3-9/16"
Height 2-3/8"



Order No. 19 - 6694

Filter & Prefilter replaces Wisconsin/Robin 2273280317. Fits models W1-145V and W1-185V, (4 and 5 hp) 4-cycle vertical engines on Snapper. Comes complete with wrap.



Order No. 19 - 6695

Prefilter replaces Wisconsin/Robin 2273261308.



Length 8-7/8"
Width 2-3/4"
Height 2-5/8"



Order No. 19 - 6696

Filter & Prefilter replaces Wisconsin/Robin 2353470121. Fits model W1-450V, (12 hp) vertical engines on Snapper riders. Comes with wrap.



Order No. 19 - 6697

Prefilter replaces Wisconsin/Robin 2353261008.



Top OD 2-1/2"
Bottom OD 4-1/4"
Height 2-1/2"



Order No. 19 - 6700

Filter & Prefilter replaces Wisconsin/Robin 2273261007. Fits model W1-185, (4 and 6 hp) horizontal engines.



Order No. 19 - 6701

Prefilter replaces Wisconsin/Robin filter wrap.



Top OD 2-1/2"
Bottom OD 3-3/8"
Height 2-3/8"



Order No. 19 - 6702

Filter & Prefilter replaces Wisconsin/Robin 2063260107. Fits model EY18-3W, (4 and 6 hp) horizontal.



Order No. 19 - 6703

Prefilter replaces Wisconsin/Robin filter wrap.



ID 2-1/4"
OD 3-1/8"
Height 2-3/8"



Order No. 19 - 6698

Filter & Prefilter replaces Wisconsin/Robin 1573620101. Fits model WT1-125V, (4 hp) 2-cycle vertical engines on Snapper.



Order No. 19 - 6699

Prefilter replaces Wisconsin/Robin 2273621008.

19

FILTERS

FILTERS



Oil Filter Shop Pack



Order No. 19 - 12861

Oil filter shop pack replaces B&S 492932, 696854, John Deere AM125424, Tecumseh 36563. **OD 2.92", Ht. 2.7", Thread size 3/4 - 16".** MIN012

Order No. 19 - 12862

Oil filter shop pack replaces Kohler 12-050-01S & John Deere AM101207. **OD 2.92", Ht. 2.7", Thread size 3/4 - 16".** MIN012

Order No. 19 - 12864

Oil filter discount pack replaces Kawasaki 49065-2078, 49065-2071 John Deere AM107423, Generac 1323 & 70185. **OD 2.685", Ht. 2.977", Thread size 3/4 - 16".** MIN012

Order No. 19 - 12863

Oil filter shop pack replaces Kohler 52-050-02S, B&S 491056. **OD 2.92", Ht. 3.4", Thread size 3/4 - 16".** MIN012

Transmission Oil Filters



Order No.

Description

Order No. 19 - 9380

Transmission oil filter replaces Scag 48758 & Encore 453048. Also fits Steiner, Bobcat and Land Pride. **Thread size 1" - 12, mounting seal OD 2-3/4", OD 3-11/16", Height 5-1/4", 10 Micron.**

Order No. 19 - 6680

Transmission filter. Replaces Wheel Horse 79-5270, 108335, Bolens 1726450, Cub Cadet 923-3014 & 723-3014 & 759-3605, JD AM-35176, AM39653 MTD 727-0162, Onan 122-0185 and Simplicity 1650954/171439. **25/30 Micron. 3.79" height, 3.660" OD, Thread size 3/4-16**

Order No. 19 - 8631

Hydro filter replaces Scag 48462-01 & Cub Cadet 723-04032A. **10 Microns. 3.790" height, 3.66" OD, Thread size 1 - 12**

Order No. 19 - 9464

Transmission filter replaces Exmark 1-523541, Toro E63-3752, Dixon 7252, 539125960, Dixie Chopper 68140, Gravely 09246900, Grasshopper 100850. **Hydrostatic transmission filter has 3/4" - 16 thread, 40 micron, 3-7/8" Height, 3" OD.**

Order No. 19 - 9361

Transmission filter replaces Exmark 1-513211, Toro E63-3750, Encore 423063, Exmark 109-4180, Hustler 768341. Yazoo-Kees 101164. **Hydrostatic transmission filter has 3/4" - 16 thread, 25 micron, 3.404" Height, 2.921" OD, Thread size 3/4 - 16.**

Order No. 19 - 12374

Oil filter replaces Hydro Gear HG52114. Fits (Transmission Model ZT2800). Replaces Scag HG52114, fits Freedom Z, Exmark 109-3321, Hustler 768341 & 600976, Gravely 21545100.

19

FILTERS



Air Filter for ECHO

OD 2-15/16"
Height 3/8"



Order No. 27 - 7160

Air filter replaces Echo 130-310-0076-0. Fits model PB400 Backpack Blowers. MIN005



Order No. 27 - 9067

Air filter replaces Echo 130310-51730. Fits Echo SRM2500 trimmer. MIN005



Order No. 27 - 9066

Air filter replaces Echo 130310-04560. Fits Echo 2400 hedge clipper. MIN005



ID 1-3/4"
OD 3-1/4"
Length 7"

Order No. 27 - 8585

Air filter replaces Echo 13031700760. Fits PB 400E backpack blower.



Order No. 27 - 6966

Replaces Echo 130-310-0306-0, 130-310-0492-2, Toro 46-3960, Hoffco 208645, McCulloch 215013, Poulan 530-091886. For most trimmers using Kioritz engines.



Length 10-1/2"
Width 3"
Height 1-1/2"

Order No. 27 - 8735

Air filter replaces Echo 130305-08360. Fits backpack blower models PB4600 & PB6000.



Length 2-5/8"
Width 2-5/8"
Hole Dia. 1/4"

Order No. 27 - 10759

Air filter replaces Echo 130310-54130. Fits models GT2000, GT1100, GT2400 trimmers. ES2100, EX2400 shredder & Vacs: HC1500, HC2000, HC2400, HC2410 Hedge Trimmers; Power Pruners; 2400 Mantis Tillers.



Order No. 39 - 6985

Replaces Echo 130-310-0336-0, McCulloch 300385, 213883, Poulan 91886, Toro. 43-9730.



Length 3-1/16"
Width 3-7/64"
Height 5/16"

Order No. 27 - 12377

Air filter replaces Echo 130-310-51830. Fits models PAS2400, PB24LN, PAS2601, PE260, SRM2400, SRM2601, SRM2605, SRM3100, ES231, HCA2400, HCA261 and LST2400.



Length 4-1/8"
Width 2-3/4"
Height 1-1/2"

Order No. 27 - 10269

Air filter replaces Echo A226000031. Fits blowers PB-403, PB413, PB-603, PB-611 and PB-650.

FILTERS



Air Filter for ECHO



Length 3-1/8"
Width 3-1/8"
Height 3/8"
ID 3/8"



Order No. 27 - 14163

Air filter replaces Echo A226000350 / A226000351 single layer. Fits PE-280, PB-251, PB-255, PB265, SRM280.

Length 6-3/4"
Width 4-7/16"
Height 1-1/8"



Order No. 27 - 12775

Air filter replaces Echo A226000410. Fits PB-770H & PB-770T, 63.3 cc backpack blower.

Order No. 39 - 13166

Air filter replaces Echo 13031039132. Fits models CS-300, CS301, CS305, CS306, CS341, CS346, CS3000, CS3400, CS3450.



Width 3-1/2"
Height 3/8"
Length 3"



Air Filter for KAWASAKI



Length 5"
Width 4-1/8"
Height 1-1/4"

Order No. 27 - 13381

Air filter replaces Kawasaki 11029-2021. Fits backpack blower models KRB750A-A2, HG750AAS.

Air Filters for SHINDAWIA



OD 2-3/8"
Height 1/2"

Order No. 27 - 5864

Replaces Green Machine 309891. Fits model 3000SS, Shindaiwa 20000-81740, models T25 & LT20. Also fits Robin 1082. Used in our 27-7926 assembly. MIN005

19

FILTERS



Length 2-1/4"
Width 2-3/8"
Height 1/2"

Order No. 27 - 3122

Replaces Green Machine 305901. MIN005

HOMELITE



Order No. 39 - 6988

Replaces Homelite 94456. Used on models ST160, 160A, 165, 180 and 200. MIN005

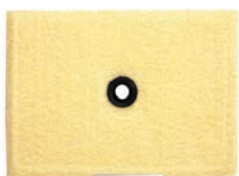

Order No. 39 - 3111

Replaces Homelite A-65178. Fits model super E-Z. 3-7/8" x 2-7/8".



ID 2"
OD 4-1/4"
Height 2-5/8"

Order No. 39 - 6511

Replaces Homelite 46073. Fits models DM50. Used on cut-off saws.



ID 3"
OD 5"
Height 1-11/16"

Order No. 39 - 8333

Air filter replaces Homelite 46687. Fits model DM20 saw.



ID 4"
OD 5"
Height 2 1/8"

Order No. 39 - 8334

Air filter replaces Homelite 54620B. Fits model XL98, A, C and D saw.



**Air Filter for
HOMELITE**



Order No. 27 - 8238

Air filter replaces Homelite D-98760-B. Fits Homelite 16cc, 25cc & 30cc trimmers, blowers, hedge trimmers & mini tillers. Also fits models ST145, 155, 175, 185, 285, 385, 485 and Wizard models HB100, HB180 and HB180V. MIN005



Order No. 27 - 8239

Air filter replaces Homelite D-06615. Fits models 2625CD, Z625CDV, 2825SD, 2725CB, 2830SB, D630CD, D730CDV, D830SD, D830CB, D830SB. MIN005



Order No. 39 - 1550

Replaces Homelite 63589-A, 63589. Fits XL-12. 5/8" thick, 4" length, 3-3/8" width.



Order No. 39 - 8405

Air filter replaces Homelite 02500. Fits models 200, 192 & 180 chain saws. Also fits Little Red XL, Super 2 and Green Machine model 20. MIN005



ID 3"
OD 7"
Height 2-5/8"

Order No. 39 - 8818

Air filter replaces Homelite 2308 & UP056131. Fits model MP38, 12" & 14" and MP88, 14".



ID 1-13/16"
OD 3-1/4"
Height 2-1/2"

Order No. 39 - 8335

Air filter replaces Homelite 47867A. Fits DM40 saw.

**Air Filter for
HUSQVARNA**

Length 2-1/4"
Width 1-7/8"
Height 3/8"



Order No. 39 - 1547

Replaces Homelite 69141 & D92702B. Fits XL2 and Super 2. 1/2" thick, 1-3/8" x 1-5/8" width, 2" length. MIN005

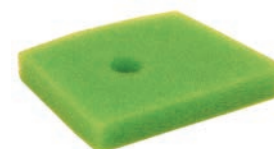

Order No. 27 - 12520

Air filter replaces Husqvarna 537186301. Fits models 123, 223, 322, 323, 325 & 326 trimmers. MIN005

**Air Filter for
HUSQVARNA**



Order No. 39 - 12485

Air filter replaces Husqvarna 530-029811. Fits Chain Saw models 136, 137, 141, 142, 36, 41.



Order No. 39 - 10779

Air filter replaces Husqvarna 506-26-34-01. Fits models 371K Cut-off saws.



FILTERS

Pre-Filter for HUSQVARNA

Length 10-3/4"
Width 5-1/2"
Height 13/16"



Order No. 39 - 12516

Pre-filter replaces Husqvarna 506231901. Fits models K950 & K960 Active.



Order No. 39 - 9955

Prefilter replaces Husqvarna 506-14-57-01. Fits model 268k & 272K cut off saws. Prefilter for our 39-9956 filter.

Order No. 39 - 9956

Air filter replaces Husqvarna 506-14-58-01. Fits model 268k & 272K cut off saws.

Pre-Filter for HUSQVARNA



Order No. 39 - 13132

Pre-filter replaces Husqvarna 506269101. Fits models K371 & K375 Pre-oiled.

Filter for HUSQVARNA

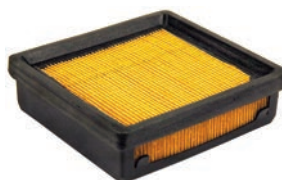

Order No. 39 - 12887

Filter replaces Husqvarna 506367202. Fits K750 cut off saws.

Order No. 39 - 12888

Pre-Filter replaces Husqvarna 506367101. Fits K750 cut off saws. Used with our 38-12887 filter.

Order No. 39 - 13133

Pre-filter replaces Husqvarna 506268601. Fits 3120K pre-oiled.



Air Filter for HUSQVARNA



Order No. 39 - 10778

Air filter replaces Husqvarna 503-81-45-03. Fits models 365 & 371 chainsaws.



Order No. 39 - 9627

Air filter replaces Husqvarna 501807101. Fits models 61, 66, 266, 281 & 288.

JONSEREDS



Order No. 39 - 3113

Replaces Jonserseds 100251 and Roper 35373. 3-7/8" x 2-3/8".

Pre-Filter for MAKITA



Order No. 39 - 13135

Pre-filter replaces Makita 326173080. Fits DPC811. Pre-oiled.



McCULLOCH



Order No. 39 - 3107

Replaces McCulloch 92410. 3" x 3-1/4".



Order No. 39 - 3105

Replaces McCulloch Mini Mac 214224. 1-7/8" Dia. x 7/8" High.

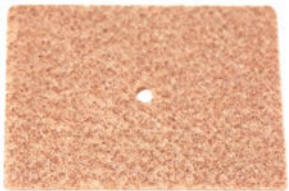

Order No. 39 - 1548

Replaces McCulloch 91458, 68685, Mac 6. 2-7/8" length, 2-1/8" width.

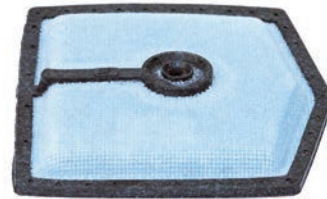

Order No. 39 - 3109

Replaces McCulloch 10 Series 216685, 69922, 92420. 4-1/8" x 4-3/8".

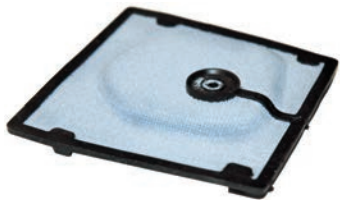

Order No. 39 - 3108

Replaces McCulloch 21422. Fits 600 Series 95213, 214226.

Pre-Filter for PARTNER



Order No. 39 - 13138

Pre-filter replaces Partner 506268701. Fits K1250. Pre-oiled.

Pre-Filter for PARTNER



Order No. 39 - 13136

Pre-filter replaces Partner 506226301. Fits K650, 700. Pre-oiled.



Length 6"
Width 4-1/4"
Height 2-5/8"

Order No. 39 - 12497

Air filter replaces Partner 506-23-18-02. Fits models K950 and 1250 active Cut-off saws. Also fit Husqvarna.

Air Filter for PARTNER



Order No. 39 - 9790

Air filter replaces Partner 5062242-01. Fits models K650 ACTIVE cut-off saws.



Order No. 39 - 9954

Pre-filter replaces Partner 999810. Fits model K650. Used with our 39-9790 air filter.



FILTERS

**Air Filter for
POULAN**



Order No. 39 - 13119

Air filter replaces Poulan & Craftsman 530037793. This will fit Poulan chainsaw models 222, 262, 1900, 1950, 1975, 2025, 2050, 2055, 2150, 2175, 2250, 2375, 2450, 2550, 2555FLW, PP220, PP221, PP230, PP260, BH2160, Snapper S1634, S1838 and others.
MIN005

POULAN



Order No. 39 - 12486

Air filter replaces Poulan 530-036141. Fits Chain Saw models 2200, 2500, 255, 2600, 2750, 2775, 2900, 295, 3050, 310 & 315.



Order No. 39 - 1567

Replaces Poulan 530-023791. Micro Poulan. 1" thick, 2-5/8" length, 1-1/2" width.
MIN005

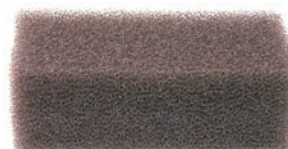

Order No. 39 - 1568

Replaces Poulan 25DA No. 520-023369. 1-1/8" thick, 3-1/4" length, 1-1/2" width.
MIN005



Order No. 39 - 3112

Replaces Poulan 24548. 3-3/4" x 2-5/8". Poulan 3400 saw.



Length 2-5/8"
Width 1-1/4"
Height 1-1/4"

Order No. 27 - 4300

Replaces Weedeater 701568. Poulan 47, 530-024371. Fits all XR series 1400, 1500, 1600, 1700, 4000, 5000, 6000 & Pro 150.
MIN005

**Air Filter for
LAWN-BOY/
RYAN, RYOBI**

Order No. 27 - 7206

Air Filter replaces Lawn-Boy/Ryobi 610312. Fits models 261, 262, 263, 264, 264-1, 265, 265-T, 265-1, 274, 275, 275-1, 284, 285, 500, 500-1, 520, 520-1, 540, 540-1, 580 and 580-1 trimmers.
MIN005



Length 2-3/4"
Width 1-1/4"
Height 1/2"

**Air Filter for
RED MAX**

Length 7-3/4"
Width 5"
Height 3/4"



Order No. 27 - 9909

Air filter replaces Red Max T4012-82310. Fits model EB7000.

Order No. 27 - 10311

Pre-filter replaces Red Max T4012-82320. Used with our 27-9909 air filter. Fits model EB7000.



Length 2-3/4"
Width 11/16"
Height 3/8"

Order No. 27 - 7208

Air Filter replaces Red Max 1260-84160 & Green Machine 170078. Fits model BT17.
MIN005



Air Filter for RYOBI



ID 1-3/16"
OD 2-1/4"
Height 7/8"

Order No. 27 - 8410

Air filter replaces Ryobi 180350. Fits blower model GBV28 & trimmer models 780RE & 790R. Also fit Walbro 125-48. Fits our 27-8080 Filter Assembly. MIN005

SEARS



Order No. 39 - 3114

Replaces Sears 3.7 Roper 9163-H. 3-3/4" x 3-5/8".

Air Filter for SACHS DOLMAR

Length 4-3/16"
Width 3-1/8"
Height 2-1/4"



Order No. 39 - 9957

Air filter replaces Dolmar Makita 391-173-010, 394-173-010. Fits Dolmar Makita DPC6300, 6201, 7300C, 7301.

Order No. 39 - 9958

Prefilter replaces Dolmar Makita 391-173-030, 394-173-030. Fits Dolmar Makita DPC6300, 6201, 7300C and 7301.

Order No. 39 - 13583

Inner filter replaces Dolmar/Mikta 394-173-020. Fits model DPC6200, DPC6201, DPC7300, DPC7301. Used with our 39-9957 & 39-9958 filters.

Order No. 39 - 3115

Replaces Sears 643A128, 9918-R. 4-1/4" x 2-1/2".



Air Cleaner Assembly for SHINDAIWA



Order No. 27 - 7926

Air cleaner assembly replaces Shindaiwa 20040-81700, 20000-81701. Used on model GP25. Also fits Green Machine GM309889 & Stihl. Uses our 27-5864 Prefilter.

Air Filter for SHINDAIWA

OD 2-3/8"
Height 3/8"



Order No. 27 - 7679

Air Filter replaces Shindaiwa 20056-81740, A226000650. Fits brushcutter models B450, C27, C270, C350, RC45, Power Broom model PB 270, Trimmer models T27, T270, T350. Also replaces Toro 54-5190. Fits trimmer models TC100, TC200, TC1000, TC2000, TC3000, TC4000 & TC 5000 MIN005



ID 5/8"
OD 1-1/4"
Height 1"

Order No. 27 - 8519

Air filter cover replaces Shindaiwa 20036-81712. Fits T-20. Used with our 27-8589 air filter.

Order No. 27 - 8589

Air filter replaces Shindaiwa 20036-81740. Fits T-20 model trimmers. Used with our 27-8519 air filter cover. MIN005

Air Cleaner Cover for SHINDAIWA



Order No. 27 - 8658

Air cleaner cover replaces Shindaiwa 20024-81777. Fits T-27 & C-27 trimmers models.

FILTERS



Order No. 27 - 8528

Fuel filter replaces Shindaiwa 22100-85420. Fits models T25, T27, C35. Filter only for Shindaiwa 20011-85400. Used with our 27-8529 & 27-8534 Fuel Filter with weight. MIN010



Length 2-3/8"
Width 2"
Height 3/8"

Order No. 27 - 12024

Air filter replaces Shindaiwa 20018-81750. Fits model T-230 trimmers.



Order No. 27 - 11642

Pre-filter replaces Shindaiwa 68900-82320. Fits model EB8510 4 cycle backpack blower. Used with our 27-11641 air filter.



Length 5"
Width 3-3/8"
Height 1"

Order No. 27 - 11641

Air filter replaces Shindaiwa 68900-82120, A226000530. Fits model EB8510 Backpack blower.

Air Filter for STIHL

Length 4-1/2"
Width 2-1/2"
Height 1-1/4"



Order No. 27 - 12081

Air filter replaces Stihl 4282-141-0300B. Fits Backpack blower models BR500, 550, 600.

Length 5-1/4"
Width 3"
Height 2"

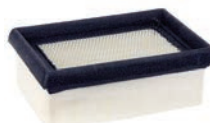

Order No. 19 - 9608

Filter replaces Stihl 4223-141-0300. Fits model TS400 cut-off saws.



Order No. 19 - 9609

Prefilter replaces Stihl 4223-141-0600. 3 Layer foam.

19

FILTERS

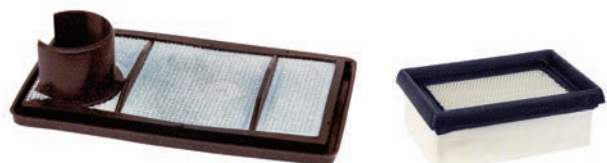

Order No. 19 - 9776

Inner air filter replace Stihl 4223-140-1800. Fits TS400 cut off saws. Inner filter for our 19-9608 filter.



Order No. 19 - 9608

Filter replaces Stihl 4223-141-0300. Fits model TS400 cut-off saws.

Air Filter & Pre-filter for STIHL



Order No. 27 - 7997

Air filter replaces Stihl 4203-141-0300 / 4201-140-1805. Fits BR320 & BR400 backpack blowers.

Order No. 27 - 9928

Pre filter replaces Stihl 4203-141-031. Fits blower models BR320 & BR400. Fits our 27-7997 filter.



FILTERS

Air Filter for STIHL

Length 2-3/8"
Width 2-3/8"
Height 1/4"



Order No. 27 - 11807

Air filter replaces Stihl 4137-124-2800. Fits FS75, FS80, FS85, HS80, HL75K, FC75 & BG75 trimmers. Used with our 27-11806 prefilter.

Order No. 27 - 11806

Prefilter replaces Stihl 4137-124-1500. Fits FS75, FS80, FS85, HS80, HL75K, FC75 & BG75 trimmers.

Length 5-1/8"
Width 3-1/2"
Height 1-1/4"



Order No. 27 - 10963

Air filter replaces Stihl 4203-141-0301. Fits B420 Blowers.

Order No. 27 - 13159

Plastic pre-filter replaces Stihl 4203-120-1500. Fits our 27-10963 filter. Fits BR340 & 380.



Order No. 27 - 11659

Air filter replaces Stihl 4134-141-0300. Fits trimmer models FS1210, 200, 250, 350, 450 and BT120C Earth Auger.

OD 2"
Height 3/8"



Order No. 27 - 7207

Air Filter replaces Stihl 4112-124-0801. Fits model FS80 trimmers. MIN005

Order No. 27 - 8716

Air filter replaces Stihl 41331241500, code 135263300. Fits Trimmer models FS 74, 76, FC 72, HS 72, 74, 76 & BG 72. MIN005

Length 2-7/16"
Width 2-7/16"
Height 1/4"



Order No. 39 - 5837

Replaces Stihl 1119-120-1615. For model 038.



Order No. 39 - 6986

Replaces Stihl 4114-124-0800. Fits models FS50, 51, 60, 61, & 65. MIN005



Order No. 39 - 5834

Replaces Stihl 1118-120-1611 and 1118-120-1615. For model 028. Super and 028 Wood Boss.



Air Filter for DOLMAR/MAKITA

Length 4-7/32"
Width 3-7/16"
Height 2"



Order No. 19 - 13394

Air filter replaces Dolmar/Makita 395-173-010. Fits power cutter model DPC7331, DPC7341, DPC8132.



19

FILTERS

FILTERS



Plate Filter for STIHL



Order No. 39 - 11580

Plate filter replaces Stihl 1130-124-0800. Fits model MS170/180.



Order No. 39 - 11587

Air filter replaces Stihl 1120-120-1600. Fits model 009.



Order No. 39 - 5906

Replaces Stihl 4201-140-1801. Used with our 39-5907 pre filter and 39-3116 canister filter. Fits models TS350, TS510, TS760, for 2 bolt mount.



Order No. 39 - 5907

Replaces Stihl 4201-141-0310. Fits models TS350, TS510, TS760. For (2) bolt mount. Used with our 39-5906 inner filter and 39-3116 canister filter.



Order No. 39 - 3116

Replaces Stihl 4201-141-0300, and Sachs-Dolmar. 1 in a box. OD 3-7/8", ID 2-3/8", Height 2-3/4".



Order No. 39 - 8283

Inner air filter for Stihl 4201-140-1802. Fits model TS 360

Air Filter for STIHL

Length 5-1/2"
Width 4-1/16"
Height 1-5/8"



Order No. 39 - 12561

Air filter replaces Stihl 4224-141-0300A. Fits Chain Saw models TS700 & TS800 cut-off saws.



Order No. 39 - 12306

Air filter replaces Stihl 1123-120-1612. Fits models MS210, 230 & 250.



Order No. 39 - 12305

Air filter replaces Stihl 1127-120-1621. Fits models MS290, MS310 & MS390.



Order No. 39 - 12716

Air filter set replaces Stihl 4238-140-4402. Includes 4238-140-1800 pre-filter & 4238-141-300B panel filter. Fits models TS410 & TS420 Cut Quik saws.

19

FILTERS



FILTERS

Inner Air Filter for STIHL



ID 1-11/16"
OD 1-7/8"
Height 1-11/16"

Order No. 39 - 12570

Inner air filter replaces Stihl 4221-140-1800. Fits models TS460, S510, TS760 (4205) new style cut-off saws.



ID 2-1/16"
OD 4-15/32"
Height 2-5/16"

Order No. 39 - 12571

Air filter replaces Stihl 4221-140-4400. Fits models TS460, S510, TS760 (4205) new style cut-off saws.

Pre Filter for STIHL



Width 2"
Thickness 1/8"
Length 6-5/16"

Order No. 39 - 12572

Pre filter replaces Stihl 4221-141-0310. Fits models TS460, S510, TS760.

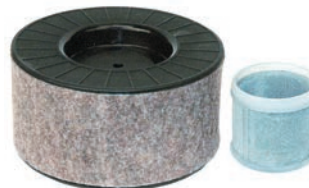

Width 2"
Thickness 1/8"
Length 6-5/16"

Order No. 39 - 12573

Air filter kit replaces Stihl 4221-141-4400. Fits models TS460, S510, TS760. (after serial 24097470)



Order No. 27 - 13160

Air filter replaces Stihl 0000-120-1654. Fits models 044, 046, 066, MS440, MS460, MS660 saws. These filters have a green foam interior surrounded by a cloth pre-filter.



Order No. 27 - 14258

Air filter replaces Stihl 4229-120-1800. Fits BG45, BG46, BG55, BG65, SH55, SH85 blowers.



Order No. 27 - 13553

Air filter replaces Stihl 4140-124-2800. Fits string trimmers FS 38, 45, 46, 55 & KM55 edger, FC55 hedge trimmer HL45, HS45. Used on Stihl models FC55, FS38, FS45, FS45C, FS45L, FS46, FS46C, FS55, FS55C, FS55R, FS55RC, FS55T, HL45, HS45, KM55, KM55C, KM55R, KM44RC.

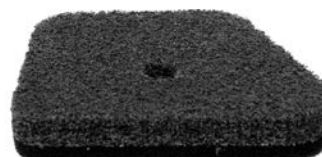

Length 2-5/8"
Width 3"
Height 1/2"



Order No. 27 - 14085

Air filter replaces Stihl 4180-120-1800B. For FE90, FS110, HT101. Air filter/pre-filter combo for trimmers with 4-mix engines FS, FC, KM, HT90, 100, 110, 130. Fits BG45, BG46, BG55, BG65, SH55, SH85 blowers. Woven fabric and foam.

Air Filter for SHINDAIWA & TORO



OD 2-3/8"
Height 3/8"

Order No. 27 - 7679

Air Filter replaces Shindaiwa 20056-81740, A226000650. Fits brushcutter models B450, C27, C270, C350, RC45, Power Broom model PB 270, Trimmer models T27, T270, T350. Also replaces Toro 54-5190. Fits trimmer models TC100, TC200, TC1000, TC2000, TC3000, TC4000 & TC 5000. MIN005

Air Cleaner Assembly for WALBRO



Order No. 27 - 8080

Air Cleaner assembly replaces Walbro 21-413, Tanaka 410-00731-900 & 410-00700-911. Fits Tanaka models TBC-373. Uses our 27-8410 Prefilter.

19

FILTERS

FILTERS



Fuel Filter for BRIGGS & STRATTON

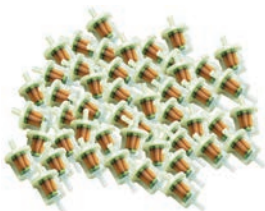

Order No. 20 - 7998

Fuel filter replaces B&S 691035 & 493629. Filter for selected engines with fuel pumps. 60 micron. (fits 1/4" fuel line)

Order No. 20 - 12951

Fuel filter replaces B&S 493629. Bulk pack for our 20-7998. MIN050

Fuel Filter for DIXIE CHOPPER



Order No. 20 - 12313

Fuel filter replaces Dixie Chopper 97392. Fuel filter, gas & water separator. 10 micron

Fuel Filter for HONDA



Order No. 20 - 13357

Fuel filter replaces Honda 16910-ZE4-S21. MIN005

Fuel Filter for KAWASAKI



Order No. 20 - 12515

Fuel filter replaces Kawasaki 49019-7001 & Cub Cadet 490-40-0001. 1/4" nipple. MIN005

19

FILTERS



Order No. 20 - 12865

Fuel filter replaces Kawasaki 49019-7005. In line drum style 30 micron fuel filter. Fits 1/4" fuel line. MIN005



Order No. 27 - 8533

Fuel filter assembly replaces Kawasaki 49019-2065. Fits trimmer models TD18, 22, 24, 33, 40 & 48.

Fuel Filter for KOHLER



Order No. 20 - 13115

Fuel filter replaces Kohler 25 050 42S. Fits 1/4" & 5/16" fuel line. 10 micron fuel filter. MIN005



Order No. 20 - 13652

Fuel filter replaces Kohler 25-050-07-S & 25-050-02-S. Fits 3/16" and 1/4" fuel line. 75 micron, 2-1/4" length. MIN005

KOHLER Fuel Filter



Order No. 20 - 2505007S

Kohler 2505007S OEM fuel filter. 75 micron with 3/16" & 1/4" fuel line ID.

Carded KOHLER Fuel Filter



Order No. 20 - 2505007S1

Kohler 2505007S1 OEM carded fuel filter. 75 micron with 3/16" & 1/4" fuel line ID.



KOHLER Fuel Filter



Order No. 20 - 2505021S

Kohler 2505021S OEM fuel filter. 75 micron with 3/16" & 1/4" fuel line ID.

Carded KOHLER Fuel Filter



Order No. 20 - 2505021S1

Kohler 2505021S1 OEM carded fuel filter. 75 micron with 3/16" & 1/4" fuel line ID.

Universal Fuel Filter



Order No. 20 - 9147

Universal fuel filter. Fits large capacity automotive style filter. 10 micron. Fits 1/4" fuel line. Replaces Kohler 24-050-10.

Universal Heavy Duty Fuel Filter



Order No. 20 - 12619

Universal in-line fuel filter. Dual hose barbs that fit 1/4" & 5/16" ID fuel line. 30 Micron rating. 3-1/2" long. Features a new high impact polymer-copolymer blend that will stand up to all standard and bio-based fuels including E85. MIN010

Order No. 20 - 12950

Universal fuel filter. Bulk pack for our 20-12619. MIN050

KOHLER Fuel Filter



Order No. 20 - 2405013S

Kohler 2405013S OEM fuel filter. 15 micron with 1/4" fuel line ID.

Carded KOHLER Fuel Filter



Order No. 20 - 2405013S1

Kohler 2405013S1 OEM carded fuel filter. 15 micron with 1/4" fuel line ID.

Fuel Filter for KUBOTA

Order No. 20 - 9146

Fuel filter replaces Kubota 12581-43012, Toro 18-1520, Grasshopper 101005. Fits larger horse power models. 10 micron. Fits 5/16" fuel line.





FILTERS

Fuel Filter for HUSQVARNA



Order No. 38 - 9227

Fuel filter replaces Husqvarna 503-443-201. Fits husky models 36, 40, 41, 42, 45, 50, 51, 61, 66 & 394 Pro. Also fits Poulan Pro saws. MIN005

Fuel Filter for POULAN



Order No. 38 - 11813

Fuel filter replaces Poulan 530-095643, 530-095646 / 530-014362. Fits gas saw models 2050, 2350, 2775, and LF 1500. 9/16" OD x 1-5/8" L. MIN005

Fuel Filter & Tube Assembly for SHINDAIWA



Order No. 27 - 8534

Fuel filter & tube assembly replaces Shindaiwa 20011-85401. Fits trimmer models T25, T27, C35 & B45.

Fuel Filter with Weight for SHINDAIWA



Order No. 27 - 8529

Fuel filter with weight replaces Shindaiwa 22100-85411. Fits models T25, T27, C35 & B45.

Fuel Filter for SHINDAIWA



Order No. 27 - 8528

Fuel filter replaces Shindaiwa 22100-85420. Fits models T25, T27, C35. Filter only for Shindaiwa 20011-85400. MIN010

Fuel Line/Filter Assembly for STIHL



Order No. 27 - 7159

Fuel line and filter assembly replaces Stihl 4112-350-3500. Fits model FS80.

19

FILTERS



Order No. 20 - 1358

Large in-line two step filter 1/4" and 5/16". Replaces Toro 71-5960. Used on small mowers and tractors. 20 to 25 microns. MIN010

Order No. 20 - 11358

Fuel Filter Large in-line two step 1/4" & 5/16". (bagged) MIN005

KOHLER Fuel Filter



Order No. 20 - 2505022S

Kohler 2505022S OEM fuel filter. 51 micron with 1/4" fuel line ID.



Order No. 20 - 2505022S1

Kohler 2505022S1 OEM carded fuel filter. 51 micron with 1/4" fuel line ID.



12 to a card

Order No. 20 - 1349

Fuel filter round in-line. Replaces B&S 394358, Toro 56-6360. For 1/4" nipple. 75 micron element. For engines with fuel pumps. MIN010

Order No. 20 - 11349

Fuel Filter replaces B&S 394358. (carded) MIN005

Order No. 20 - 2801

Fuel filter, round in-line. 75 microns. For 1/4" fuel line. 12 to a card.

Order No. 20 - 12949

Fuel filter replaces B&S 394358. Bulk pack for our 20-1349. MIN050



Order No. 20 - 1357

Fuel filter in-line. Replaces Snapper 7014359 and 11777. For 1/4" nipple. 85 Microns MIN010

Order No. 20 - 11357

Fuel Filter. Replaces Snapper 7014359 and 7011777. (card-ed) MIN005

1/4" In-Line Fuel Filter

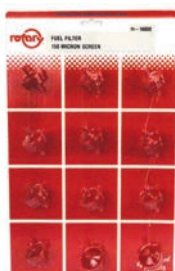

12 to a card

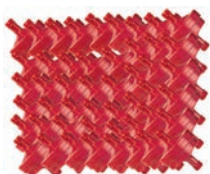

Order No. 20 - 6000

Fuel Filter round in-line, for 1/4" fuel line. Replaces B&S 298090, Scag 48057-02. 150 micron element. For engines without fuel pumps. MIN010

Order No. 20 - 16000

Fuel filter, round in-line. 150 microns. For 1/4" fuel line. (carded) 12 to a card.

Order No. 20 - 12952

Fuel filter replaces B&S 298090. Bulk pack for our 20-6000. MIN050

Fuel Line, Fuel Filter & Clamps Kit



Order No. 20 - 13173

Fuel line, fuel filter & clamps kit. Complete kit includes 24" of our 20-1502 1/4" SAE30R7 fuel line, (1) 20-12619 fuel filter, and (4) 20-5905 1/4" fuel clamps. Excellent for replacing one fuel line assembly for most rider units.

FILTERS



Fuel Filter



Order No. 20 - 10347

1/4" Fuel filter. 1/4" nipple. 75 microns. Stainless steel screen. 5/16" in/out diameter. 1.3" OD
MIN005



Order No. 20 - 10351

3/16" Fuel filter. 3/16" nipple. 75 microns. Stainless steel screen. 1/4" in/out diameter.
MIN005



Order No. 20 - 10348

1/4" Slim line fuel filter. 1/4" nipple. 75 microns. Sintered bronze screen. 5/16" in/out diameter. .88" OD
MIN005



Order No. 20 - 10424

1/4" Fuel filter. 1/4" nipple. 75 microns. Stainless steel screen. 5/16" in/out diameter. 1.7" OD
MIN005



Order No. 20 - 10422

1/4" Slim line fuel filter. 1/4" nipple. 75 microns. Sintered bronze screen. 5/16" in/out diameter. 1.19" OD
MIN005



Order No. 20 - 10349

1/4" Slim line fuel filter. 1/4" nipple. 90 microns. Polyester screen. 5/16" in/out diameter.
MIN005

19

FILTERS



Order No. 20 - 10423

1/4" fuel filter, 90 degree. 1/4" nipple, 90 microns. Polyester screen, 5/16" in/out diameter.
MIN005



Order No. 20 - 10352

1/4" High flow fuel filter replaces Kawasaki 49019-7001. 1/4" nipple. 80 microns. Polymer treated paper screen. 5/16" in/out diameter.
MIN005

Fuel Pick-Up Assemblies



Order No. 38 - 7298

Fuel Pick-Up Assembly replaces Stihl 1115-350-3503. Fits models 045 and 056.



Order No. 38 - 10091

Fuel filter replaces Stihl 0000-350-3500. Fits most small Stihl chainsaws.



ID 15/16"
OD 9/16"
Length 15/16"

ID 29/64"
OD 13/16"
Length 15/16"

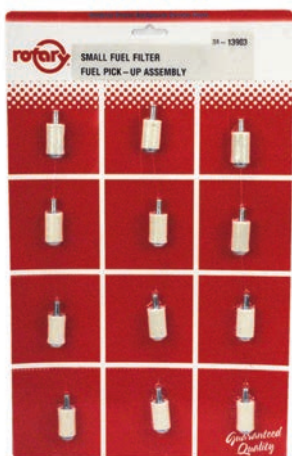

Order No. 38 - 3903

Replaces Homelite 69923, Poulan, Tillotson OW-802.

MIN010

Order No. 38 - 1400

Replaces Homelite 64083, 64083-1, Poulan 23364, Tillotson 95-182. Filter only for 38-3903.

MIN010

Order No. 38 - 13903

Fuel filter. 12 to a card. Our 38-3903 assembly. (carded)

Order No. 38 - 3902

Replaces Homelite, Poulan, Tillotson OW-497.

MIN010

Order No. 38 - 1399

Replaces Homelite 59253-1A, 59253, Poulan 34032, Tillotson 95-172. Filter only for 38-3902.

MIN010

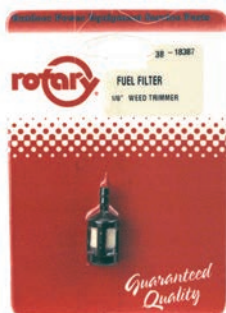

Order No. 38 - 4995

Replaces Tecumseh 410263, 410245, Homelite 49422. Fits chain saws and trimmers. 1/8" nipple. Zama-1.

MIN005

Order No. 38 - 18387

Fuel Filter. (carded)

MIN005



Order No. 38 - 14995

Fuel filter carded. 12 to a card. Our 38-4995 assembly. (card-ed)

FILTERS



Order No. 38 - 3906

Filter only for 20-3905.

MIN010



Order No. 38 - 1391

Solid Fuel Filter. Replaces McCulloch 63932.

MIN010

Order No. 38 - 3904

Fuel filter. Replaces Stihl 1110-358-1800.

MIN010



**Fuel Filter for
WALBRO**



Order No. 38 - 9025

Fuel filter replaces Walbro 125-528. Fits engines up to 80cc. For 3/16" ID, fuel line. Felt filter.

MIN005

**Fuel Filter from
ZAMA**



Order No. 38 - 9137

Zama ZF-2 fuel filter. Fits models with 3/16" ID fuel line. For engines 30cc and larger. .514" OD x 1.227" length.

MIN005

Order No. 38 - 9138

Zama ZF-3 fuel filter. Fits models with 1/8" ID fuel line. For engines 30cc and larger. .712" OD x 1.647" length.

MIN005

Order No. 38 - 9139

Zama ZF-4 fuel filter. Fits models with 3/16" ID fuel line. For engines 30cc and larger. .717" OD x 1.622" length.

MIN005

Order No. 38 - 9140

Zama ZF-5 fuel filter. Fits models with 1/4" ID fuel line. For engines 30cc and larger. .712" OD x 1.638" length.

MIN005



Order No. 38 - 9024

Fuel filter replaces Walbro 125-527. Fits engines up to 33cc. For 3/16" ID, fuel line. Felt filter.

MIN005

Chain saw Fuel Filters



Order No. 38 - 3905

Fuel filter and casting. Filter made of porous plastic rated at 40-50 microns. Residue free.

MIN010

19

FILTERS

FUEL LINE & ACCESSORIES

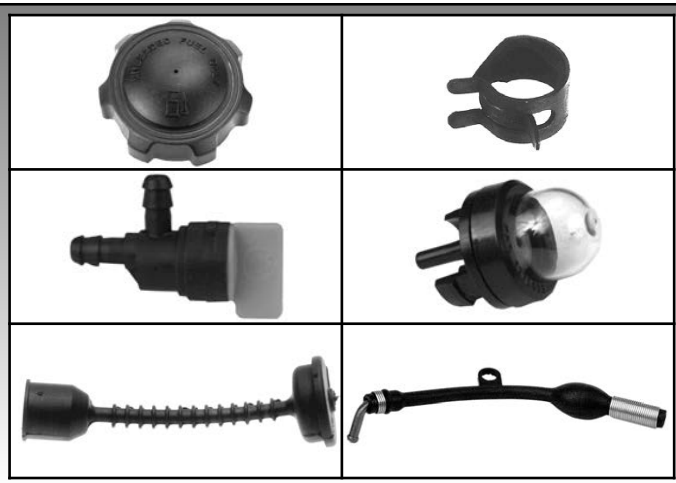

Quick-Glance

FUEL LINE & ACCESSORIES	PG.
Fuel Line	
Fuel Line, Filter & Clamp Kit	505-508
Hose Clamps	507-508
Bowl Nut	508
Primer Bulbs	508-510
Fuel Valves	510-512
Fuel Cut-off Valve	510-512
Fuel Tanks	512
Fuel Caps	512-518
Chain Saw	
Molded Fuel Line	519-520
Trimmer	
Fuel Tube	505-506



FUEL LINE & ACCESSORIES

Fuel Line



**3/8" OD
BLACK**

Order No. 20 - 1351

Black fuel line. Fits 1/4" nipples. Oil resistant. 50' roll.

Order No. 20 - 1502

25' coil of 1/4 fuel line and vapor emission hose. Meets SAE3OR7 specifications. Replaces B&S 395051R. Nitrile tube is reinforced with high strength RAYON. Neoprene cover resists oil, grease and ozone. Extremely durable to give years of trouble free service. Temp. Range 40° F to 200° F. Red Clamp



CLEAR

Order No.

Description

- 20 - 1352** For 1/8" nipples (chain saw) 50' roll.
- 20 - 1353** For 3/16" nipples (chain saws, scooters) 50' roll.
- 20 - 1354** For 1/4" nipples (lawn mowers) 50' roll.

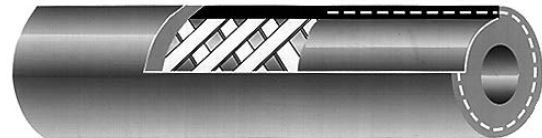

OD 1/2"

Tygon Fuel Line

Order No.	Dimensions ID x OD	Standard Package
20 - 14663	.080" x .140"	3 ft.
20 - 14664	.080" x .140"	10 ft.
20 - 14675	.080" x .140"	25 ft.
20 - 6616	.080" x .140"	50 ft.
20 - 14629	.080" x .140"	200 ft.
20 - 14665	3/32" x 3/16"	3 ft.
20 - 14666	3/32" x 3/16"	10 ft.
20 - 14676	3/32" x 3/16"	25 ft.
20 - 6617	3/32" x 3/16"	50 ft.
20 - 14628	3/32" x 3/16"	200 ft.
20 - 10699	.117" x .211"	25 ft.
20 - 11549	1/16" x 1/8"	25 ft.
20 - 6618	1/8" x 1/4"	50 ft.
20 - 8386	1/8" x 3/16"	50 ft.
20 - 6619	3/16" x 5/16"	50 ft.
20 - 6620	1/4" x 3/8"	50 ft.



Tygon Fuel and Lubricant Tubing for Petroleum and Petroleum/Alcohol blends. Gas and oil tubing for chain saws, small engines, snowmobiles, mowers, etc. Flexible and resists swelling and brittleness (Yellow). Temp. Range 35° below F to 165° F. F-4040A

20

FUEL LINE

FUEL LINE & ACCESSORIES



Premium Fuel Line

Order No.	Dimensions ID x OD	Standard Package
20 - 4197	3/32" x 3/16"	50 ft.
20 - 4198	1/8" x 1/4"	50 ft.
20 - 8595	1/8" x 3/16"	50 ft.
20 - 4199	3/16" x 5/16"	50 ft.
20 - 4200	1/4" x 3/8"	50 ft.
20 - 12982	.094" x .203"	25 ft.



VINYL FUEL AND LUBRICANT TUBING -

Special formula vinyl gas and oil tubing for chain saws, small engines, snowmobiles, mowers, etc. Maintains an airtight seal on fittings even in extreme climates. Resists swelling or hardening. Translucent material allows visual inspection of flow. Temp. Range 20° F to 160° F. **Meets all government specifications for Chain Saws and Gas Engines.**

Fuel Line



Order No. 20 - 10670

25' coil of 3/16" fuel line and vapor emission hose. Meets SAE30R7 specifications. Nitrile tube is reinforced with high strength RAYON. Neoprene cover resists oil, grease and ozone. Extremely durable to give years of trouble free service. Temp. Range 40° F to 200°F. 3/8" OD

Order No. 20 - 10777

25' coil of 5/16" fuel line and vapor emission hose. Meets SAE30R7 specifications. Nitrile tube is reinforced with high strength RAYON. Neoprene cover resists oil, grease and ozone. Extremely durable to give years of trouble free service. Temp. Range 40° F to 200°F. 9/16" OD

(CARB) Approved Fuel Line



Order No. 20 - 11816

1/4" Carb approved fuel line. 25' roll. Replaces B&S 792020.

Order No. 20 - 12062

5/16" Carb approved fuel line. 25' roll. Replaces Kohler 25-111-37S. Ethanol Resistant.

Fuel Line for ECHO



Order No. 20 - 13370

25' coil of 3mm ID x 6mm OD fuel line. Replaces Echo 90015.

Order No. 20 - 13369

25' coil of 3mm ID x 5mm OD fuel line. Replaces Echo 90014.

Fuel Line for HOMELITE

ID .115"
OD .204"



Order No. 20 - 8645

Fuel line replaces Homelite 70310-98. Used on Homelite & McCulloch trimmers & saws. 3/64" wall. 50' roll (gray).

Fuel Line, Fuel Filter & Clamps Kit



Order No. 20 - 13173

Fuel line, fuel filter & clamps kit. Complete kit includes 24" of our 20-1502 1/4" SAE30R7 fuel line, (1) 20-12619 fuel filter, and (4) 20-5905 1/4" fuel clamps. Excellent for replacing one fuel line assembly for most rider units.

20

FUEL LINE



Hose Clamps Assortment



Order No. 01 - 7204

Hose clamp Assortment contains 6 of the most popular sizes of hose clamps, 120 total in assortment.

See Section 01/02 for a complete listing.

Fuel Filter & Cut-Off Valve Assortment



Order No. 01 - 7205

Fuel Filter and Valve Assortment contains the most popular fuel filters and fuel valves for B&S equipped Snapper, Toro, etc. Assortment contains 40 pieces.

See Section 01/02 for a complete listing.

2 Cycle Primer Bulb Assortment



Order No. 01 - 12288

2 Cycle Primer Bulb Assortment. This assortment contains 27 pieces of our popular sizes in a see through impact resistant box.

See Section 01/02 for a complete listing.

4 Cycle Primer Bulb Assortment



Order No. 01 - 12287

4 Cycle Primer Bulb Assortment. This assortment contains 50 pieces of our popular sizes in a see through impact resistant box.

See Section 01/02 for a complete listing.

Hose Clamps



Order No.	Size	Description	Indust. No.	
20 - 3450	7/32" to 5/8"	With a 5/16" Band	Mini	MIN010
20 - 3451	1/2" to 29/32"	With a 5/16" Band	Mini	MIN010
20 - 3452	9/16" to 1-1/16"	With a 1/2" Band	#10	MIN010
20 - 3453	1-1/16" to 2"	With a 1/2" Band	#24	MIN010
20 - 3454	2-1/16" to 3"	With a 1/2" Band	#40	MIN010
20 - 3455	3-1/16" to 4"	With a 1/2" Band	#56	MIN010
20 - 3456	4-1/8" to 5"	With a 1/2" Band	#72	MIN010
20 - 3457	5-1/8" to 6"	With a 1/2" Band	#88	MIN010
20 - 3458	6-1/8" to 7"	With a 1/2" Band	#104	MIN010

FUEL LINE & ACCESSORIES



Hose Clamps

Order No. 20 - 5903

For our 3/16" clear fuel line. (Black) MIN010

Order No. 20 - 5904

For our 1/4" clear and black fuel line. (Green) MIN010

Order No. 20 - 15904

Hose Clamp. (carded) MIN005

Order No. 20 - 5905

For our 1/4" Nitrile fuel line. (Red) MIN010

Order No. 20 - 15905

Hose Clamp. (carded) MIN005



Bowl Nut for TECUMSEH



Size 3/8" - 24 - 1/2"

Order No. 20 - 9216

Bowl nut replaces Tecumseh 631937A. Fits carburetor models 632052, 632086, 632087, 632088, 632162, 632050A, 632388, 632389 and 632532. Brass material.

Bowl Nut for TECUMSEH



Size 3/8" - 24 - 1/2"

Order No. 20 - 9217

Bowl nut replaces Tecumseh 631935A. Fits carburetor models 632052, 632086, 632087, 632088, 632162, 632050A, 632388, 632389 and 632532. Brass material.

Fuel Bowl Assembly



Order No. 20 - 1348

Universal. Replaces B&S 393169. Also replaces Clinton 293-32-5, Kohler 210101, Wisconsin LP43. Fits HH80 8 hp, HH100 10 hp and HH120 12 hp.



Order No. 20 - 1342

Replacement glass bowl for our 20-1348 assembly. Replaces Briggs & Stratton 298683 & Kohler 210467.

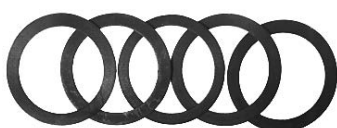

Order No. 20 - 1503

Bowl gasket. Replaces Briggs & Stratton 68477 & Kohler 210468. For our 20-1348. MIN010

Primer Bulb for B&S



Order No. 20 - 8958

Primer bulb replaces B&S 494408 & 694394. Fits quantum series 3.5, 3.75 & 4.0 hp models. Includes retainer. (Without hole) MIN010

20

FUEL LINE



Order No. 20 - 8959

Primer bulb replaces B&S 496115 & 694395. Fits quantum series 5.0, 5.5 & 6.0 hp models. Includes retainer. (With hole) MIN010

Primer Bulb for LAWN-BOY



Order No. 20 - 7236

Primer Bulb replaces Lawn-Boy 607310. Used on 1974 & newer models. MIN010



**Fuel Line Fitting for
POULAN**



Order No. 20 - 13448

Fuel line fitting replaces Poulan 530-023877. Fits gas saw models 180, 1800, 180C, 1800 Super, 190, 2000, 210, Micro XXV and S23 Arbor Pro. MIN010

**Fuel Pump Primer for
STIHL**



Order No. 20 - 12997

Fuel pump primer replaces Stihl 1130-350-6200 & 0000-350-6202. Fits BR500 blowers & TS400, TS800 Cut Off Saws.

**Hose Primer Assembly for
RYOBI**



Order No. 20 - 10006

Hose primer assembly replaces Ryobi 181801 / 181168 / 181558. Fits Ryobi trimmers. Also fits McCullough Eager Beaver 32cc. (red)

**Fuel Pump Primer for
STIHL**

OD 1-1/8"
ID 1/2"
Length 3-3/8"



Order No. 20 - 14292

Fuel pump primer replaces Stihl 0000-350-6202. Fits BR500, BR550, BR600 blowers & TS700 & TS800 cut off saws.

**Primer Assembly for
POULAN**



Order No. 20 - 12440

Primer assembly with plate replaces Poulan 530-038874. Fits models 111, 114, 115, 165, 175, 176, 185, 185R, 195, 196, BC2400, BC24W, BC308, BC3100, GT115, thru 19, 52, LT17, HP22, 28, XT125, 20, 30, 40, 45, 50, 85, 7000 and 7500 series gas trimmers. Mounting plate size: 1-5/16" L x 1" W, (2) line primer.

**Primer Assembly for
POULAN**



Order No. 20 - 12642

Primer assembly with plate replaces Poulan 530-071835. Mounting plate size: 1-3/8" L x 13/16" W, (2) line primer.

**Primer Assembly for
TECUMSEH**



Order No. 20 - 13038

Primer assembly replaces Tecumseh 570629B, 23120003, 321802A, 570629A, 32184, 570442A



Order No. 20 - 8751

Primer bulb replaces Tecumseh 632047. Fits models TNT100, 120, ECV100, 105, 110, 120 & TVS series. Includes lock washer.

**Primer Bulb for
TECUMSEH**



Order No. 20 - 9289

Primer bulb replaces Tecumseh 36045. Fits vector carburetor's. Includes lock washer. No vent hole. MIN010



Order No. 20 - 9807

Primer bulb with vented hole replaces Tecumseh 632694A. Fits VLV & LEV engines. MIN010

FUEL LINE & ACCESSORIES



Primer Bulb Assembly for WALBRO



Order No. 20 - 10392

Primer bulb assembly replaces Walbro 188-506. Fits HDA-97 carburetor.

Order No. 20 - 10393

Primer bulb assembly replaces Walbro 188-508. Fits HDA-51, WA 180, 181, 185 carburetor.

Order No. 20 - 10394

Primer bulb assembly replaces Walbro 188-509. Fits WA 135, 148A, 150, 154 carburetor.

Order No. 20 - 10395

Primer bulb assembly replaces Walbro 188-511. Fits WA 140 carburetor.

Primer Bulbs for WALBRO



Order No. 20 - 9479

Primer bulb replaces Walbro 188-13. Fits models HDA & WYK carburetors. MIN005

Order No. 20 - 9477

Primer bulb replaces Walbro 188-11. Fits models WZ3-WZ22, WZ26-WZ33, WZ35, WZ38, WZ39 & WZ43 carburetors. Also fits Echo 123181-26030 & Shindaiwa 20036-81670. MIN005

Order No. 20 - 9478

Primer bulb replaces Walbro 188-12. Fits models WA, WT, WY, WYJ, WYK, WYL, WYP & WZ carburetors, that require a .755" OD x .560" HT primer bulb. MIN005

Primer Pump for WALBRO



Order No. 20 - 11510

Primer pump replaces Walbro 188-512. Also replaces Ryobi 683974.

Primer Bulb for ZAMA



Order No. 20 - 9948

Primer bulb replaces ZAMA 0057004. Fits models CIU & CIQ carburetors. MIN005

Fuel Tank Bushing

ID 3/8"
OD 1-1/16"



Order No. 20 - 7730

Fuel tank bushing replaces Snapper 7012337, MTD 735-0149 & 935-0149, Noma 42690, Wheel Horse 104047, Tecumseh 33679, Toro 46-6560, Simplicity 165493, Bolens 1738433 and Kohler 25-313-01. MIN010

"L" Fuel Fitting



Order No. 20 - 8678

"L" fuel fitting 1/4" & 7/16" nipple. Fits MTD and other models. Also replaces Snapper 7012503. Used with our 20-7730 fuel tank bushing. MIN010

FUEL LINE

Straight Fuel Fitting



Order No. 20 - 8679

Straight fuel fitting 1/4" & 7/16" nipple. Fits MTD and other models. Used with our 20-7730 fuel tank bushing. Metal 1-1/2" length. MIN010

Fuel Valves



Order No. 20 - 1345

Straight gas fitting, replaces B&S 230318 & Kohler X380-2. 1/8" pt. - 1/4" nipple. MIN010



FUEL LINE & ACCESSORIES

Cut-Off Valve for B&S



Order No. 20 - 9294

1/4" Cut-off valve replaces B&S 494769. Fits B&S 3-1/2" & 5 hp industrial plus engines. Also replaces Tecumseh 35857.



Order No. 20 - 1346

Elbow fitting without screen. 1/8" pt. - 1/4" nipple. Replaces B&S 67218 & Kohler 25-155-02. MIN010

Fuel Line Shut-Off VALVE



Order No. 20 - 8675

Fuel line shut-off valve 1/4" nipple. Replaces Noma 42879. Used with our 20-7730 fuel tank bushing.



Order No. 20 - 8546

Elbow cut-off valve. Replaces B&S 492030. 1/8" pipe thread x 1/4" nipple.

Fuel Cut-Off Valve



Order No. 20 - 11271

90° Fuel cut-off valve. 1/8 - 27 NPT threads & 1/4" barb fitting.

Fuel Line Shut-Off for HONDA

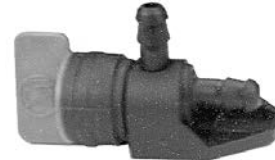

Order No. 20 - 10478

Fuel line shut-off replaces Honda 16950-ZG9-MO2. Fits models GCV 135/160.

Fuel Cut-Off Valve



Order No. 20 - 11273

Two-Way Fuel cut-off valve. 1/4" barb fitting. Fits Zero Turn riders with two tanks. Also replaces Exmark 1-633347 & Hustler 745059, Scag 482-212.

Fuel Valve for KOHLER



Order No. 20 - 13116

Fuel valve with filter and grommet replaces Kohler 25 462 03S. Includes our 20-7730 grommet. Also replaces B&S 192980GS, 208961 fuel valve with grommet. Replaces pressure washer fuel valve service kit. Fits plastic tanks on generators.

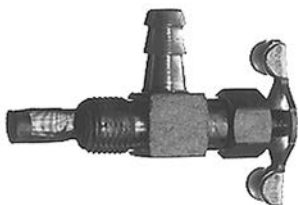

Order No. 20 - 1347

Elbow Cut-Off with screen. 1/8" pt. - 1/4" nipple. Replaces Lawn-Boy 677052, Gravely 18563, Tecumseh 29-683 and Kohler 220764. Also fits older Snapper Tanks. MIN010



Order No. 20 - 868

Straight Cut-Off valve, 1/4" nipples. Steel material, silver brazed, cadmium plated, low pressure valve.

20

FUEL LINE

FUEL LINE & ACCESSORIES



Order No. 20 - 5841

1/4" In-Line Cut-Off Valve, replaces Briggs & Stratton 494768. Also fits Snapper 34212. Uses (2) clamps our **20-5905**.



Order No. 20 - 5842

1/4" Cut-Off Valve replaces Briggs & Stratton 399517.

Fuel Filter Joint for HONDA



Order No. 20 - 10484

Fuel filter joint replaces Honda 16955-ZE1-000. Fits models GX 110, 120, 140, 160, 240, 270, 340 & 390.

Fuel Tank for HONDA



Order No. 20 - 10906

Fuel tank only replaces Honda 17510-ZE1-020ZA. Fits model GX140/160. Uses our **20-9603** fuel cap

Fuel Tank for HONDA



Order No. 20 - 11016

Fuel tank only replaces Honda 17510-ZE3-020ZA. Fits models GX340 & GX390, Honda code 7669757. Uses our **20-9603** fuel cap.

Fuel Cap for BRIGGS & STRATTON



Order No. 20 - 13228

Fuel cap replaces B&S 791545, 69221, 393156, 395005.



Order No. 20 - 6593

Replaces Briggs & Stratton 397974. Fits 100700 series, 3-1/2 thru 5 hp Vertical, Max & Quantum engines.



Order No. 20 - 3462

Fuel Cap replaces B&S 494559 and 490075. Fits 5 hp model 130202 engine.

20

FUEL LINE



Fuel Cap for B&S



Order No. 20 - 9315

Fuel cap replaces B&S 497929. Fits B&S 3.5 & 3.75 hp Classic & Sprint engines & 4 hp Quattro engines. 1-1/2" ID.



Order No. 20 - 8000

Fuel cap replaces B&S 493988, Snapper 7012515, 7019378. Fits 7 - 12-1/2 hp vert. engines

Fuel Cap for HONDA



Order No. 20 - 10018

Fuel cap replaces Honda 17620-ZL8-003, code 5580451. Fits GC V130/160 & GC 130/160.



Order No. 20 - 9604

Fuel cap replaces Honda 17620-ZH7-013 code 3682028. Fits 4-8 hp engines. Plastic cap.



Order No. 20 - 9603

Fuel cap replaces Honda 17620-ZE2-W00 & 17620-ZH7-023. Fits 4-8 hp engines. Metal cap. Fits our 20-10906 & 20-11016 fuel tank.



Order No. 20 - 12127

Fuel cap replaces Honda 17620-ZE7-000. Fits GXV120, GXV160K1, GXV340K1, GXV340K2, GXV390K. Mower models HR214SXAHR HRA HRC 215 & 216.

Fuel Cap for KUBOTA

Order No. 20 - 8936

Fuel cap replaces Kubota K1122-24122. Also replaces Lesco 18295 & Swisher 6102NC. I.D. 2-1/4"



Fuel Caps for LAWN-BOY

Order No. 20 - 7238

Fuel cap replaces Lawn-Boy 682755. Used on D & F series.



FUEL LINE & ACCESSORIES



Fuel Cap for MURRAY



Order No. 20 - 8934

Fuel cap replaces Murray 92317. Also replaces Exmark 513508. I.D. 2-1/4"

Fuel Cap for MTD



Order No. 20 - 8935

Fuel cap replaces MTD 751-3111 & 951-3111. Also replaces Howard Price 09-528, Kees 914363 & Encore 363257, Snapper 7014363. I.D. 2-1/4"

Fuel Cap for SNAPPER



Order No. 20 - 2232

Fuel cap replaces Snapper 7012155. ID 1-11/16", OD 1-7/8".

Fuel Cap for SNAPPER



ID 2-1/4"
OD 2-1/2"

Order No. 20 - 2235

Replaces Snapper No. 7019378/7012515. Vented fuel cap. Also fits Ariens, B&S 493988, Bolens, Cub Cadet, JD, Gilson, Gravely, Homelite, Jacobsen, MTD, Simplicity, Toro and Wheel Horse. 2-1/4" ID.

Fuel Cap for TECUMSEH



Dia. 1-1/2"

Order No. 20 - 1350

Replaces Tecumseh 410144B and Lawn-Boy 681446.



Dia. 1-13/16"

Order No. 20 - 8285

Fuel cap replaces Tecumseh 35355. Fits all Premier Tecumseh engines.

Order No. 20 - 12084

Locking vent gas cap replaces Dixie Chopper 600035. 2-1/4" dia.



Fuel Cap for TECUMSEH



Order No. 20 - 12055

Fuel cap replaces Tecumseh 37844. 1-3/4" ID. (Black)



Order No. 20 - 12056

Fuel cap replaces Tecumseh 37845. 1-3/4" ID. (Red)

Order No. 20 - 2233

Fuel cap for small tractors.



20

FUEL LINE



FUEL LINE & ACCESSORIES

Fuel Gauge for ARIENS

Overall Length 7-9/16"
Thread Dia. 1.7"



Order No. 20 - 7783

Fuel gauge replaces Ariens 31819. Fits YT series 10 hp front engine riders.

Fuel Gauge for MURRAY

Overall Length 5-7/8"



Order No. 20 - 6965

Fuel Gauge replaces Murray 24064. Fits Murray 5-1/4" depth fuel tanks, 2-1/4" diameter top.

Gas Cap for SCAG



Order No. 20 - 12566

Gas cap replaces Scag 481661. Fits Turf Tiger with 2-1/4" fuel tank neck. Gauge portion is 14" long.

Gas Cap for SCAG



Order No. 20 - 12567

Gas cap replaces Scag 482497. Fits Turf Tiger with 3-1/2" fuel tank neck.

Fuel Gauge for TORO/WHEEL HORSE

Overall Length 8"



Order No. 20 - 7172

Replaces Toro/Wheel Horse 106945. For 7" tank depth, 2-1/4" diameter.

Gas Cap Gauge



Order No. 20 - 12074

Gas cap gauge replaces John Deere AM39206, Dixie Chopper 40222, Fits 300 series tractors. For 9" tank depth, 2-1/4" dia.

Fuel Caps

Dia. 1-1/2"



Order No. 20 - 1359

Repl. B&S 493982, 298425.

Vented Fuel Cap

ID 3-1/2"



Order No. 20 - 9650

Vented fuel cap replaces Ariens 7525300, Ferris 1521866, 1522158, Great Dane D18097, John Deere RE64733, Snapper 7028903, Scag 482547 and many more.

Fuel Cap for ECHO



Order No. 20 - 7999

Fuel cap replaces Echo 131004-40930 & 131004-55730. Fits Echo Trimmers & Home Owner Blowers, models GT, SRM, HC, PB, PE.

Fuel Cap for ECHO



Order No. 20 - 7233

Replaces Echo 131-004-0632-0. Fits Echo Trimmer model SRM 140 & Blower model PB200 most trimmers equipped with Kioritz engines.

20

FUEL LINE

FUEL LINE & ACCESSORIES



Fuel Cap for ECHO



Order No. 20 - 9026

Fuel cap replaces Echo 131004-06610. Fits Echo blower models 4500 & 4600.

Fuel Cap for ECHO



Order No. 20 - 9048

Fuel cap replaces Echo 131004-48730/131004-55830 & 131004-55730. Fits models SRM2100, HC2400, SRM2500.

Fuel Cap Assembly for ECHO



Order No. 20 - 13531

Fuel cap assembly with retainer replaces Echo 13160009861, 3160009861, 13160009860, 13100406610, 13160003360. Fits models PB403, 403H, 403T, 413, 413H, 413HT, 413T, PB460LN, 461LN, 602, 610, 620. 2" OD

Fuel Cap for ECHO



Order No. 20 - 13530

Fuel cap replaces Echo 13100455530. Has internal retainer. Fits string trimmers, backpack blowers, hedge trimmers etc. Non-vented cap. 1-7/8" OD

Fuel Cap for HOMELITE

Diameter 1-1/2"



Order No. 20 - 9652

Fuel cap replaces Homelite A00982B. Fits Homelite "ST" series trimmers with straight shafts.

Fuel/Oil Caps Kit for HOMELITE



Order No. 20 - 9164

Fuel/Oil caps kit replaces Homelite DA-92701-C. Fits XL, XL-2, Super 2, VI Super 2, 180, 190, 192, 200, LX30, 240 and Super 240 chain saws.

Fuel Cap for HOMELITE

Dia. 2-1/16"



Order No. 20 - 8899

Fuel cap replaces Homelite DA-06486 & UP00106. Fits trimmer models Z625CDV, Z625CD, Z725CDV, Z825SD, Z725CB, Z830SB, D630CD, D730CD, D830SD, D830SB, A725CE.

Fuel Cap for HUSQVARNA



Order No. 20 - 13363

Fuel cap replaces Husqvarna 501-43-14-02. Fits saw models 225, 266, 268, 272, 44, 61, 66, 298, 2100, 2101.

FUEL LINE

Oil Cap for HUSQVARNA



Order No. 20 - 9561

Oil cap replaces Husqvarna 501765602.

Fuel Cap for HUSQVARNA



Order No. 20 - 9562

Fuel cap replaces Husqvarna 501819602 & 537215202. Fits models 234 & 238.



FUEL LINE & ACCESSORIES

**Fuel Cap for
KAWASAKI**



Order No. 20 - 7408

Fuel cap replaces Kawasaki 51049-2057. Used on brushcutters/trimmers model TA024 and some Kaaz trimmers. Fits Husky 140 blowers. 1-7/16" ID. Has rubber gasket with vent hole. No check valve. Thread to thread.

**Breather for
KAWASAKI**



Order No. 20 - 8737

Breather replaces Kawasaki 14069-2056 and Husqvarna 695-000510. Fits Kawasaki 51049-2057 fuel cap and our 20-7408 fuel cap. Fits Husky 140 blowers. Used on brushcutters and trimmers (trimmer model TA024) and some Kaaz trimmers.



Order No. 20 - 7407

Fuel cap replaces Kawasaki 310401-6641A & 51049-2058. Used on brushcutter models TD051. 1-1/2" ID.

**Fuel Cap for
RYOBI**



Order No. 20 - 9316

Fuel cap replaces Ryobi 180000. Fits models 135PR, 200, 264, 274, 280R, 284, 300BV, 310BVR, 364, 400, 410R, 500, 520, 530, 540, 580, 700R & 790R. 1-1/16" OD.

**Fuel Cap for
POULAN/WEEDEATER**



Order No. 20 - 6884

Replaces Poulan 701583 and 710567, Weedeater 530-14347, 530-010729. Fits models 1400, 1500, 1600, 1700, 1720, 1730, 1740, 1900, 4000, 5000, 6010 and Weedie 215. Fits WE, Yard Pro and chain saws with gas tank on top of engine.

**Fuel Cap for
SHINDAIWA**



Vented

Order No. 20 - 7931

Vented fuel cap replaces Shindaiwa 20040-85202. Used on trimmer models HT20 & EB45.



Order No. 20 - 7932

Fuel cap replaces Shindaiwa 20000-85200. Used on models T20, T25, C25, C35, B45, LT20, F21, C20 & T/C24.

**Fuel Cap for
STIHL**



Order No. 20 - 7883

Fuel cap replaces Stihl 4133-350-0501 & 4126-350-501C. Fits models FS86, 88, 72, 74, 76 & FC72. 1.83" OD. with anti-loss clasp.

**Fuel Cap for
STIHL**

Order No. 20 - 7882

Fuel cap replaces Stihl 4114-350-504 & 4114-350-0502. Used on FS80. 1.7" OD. with anti-loss clasp.



20

FUEL LINE

FUEL LINE & ACCESSORIES



Fuel Cap for STIHL



Order No. 39 - 7299

Fuel Cap replaces Stihl 1117-350-0520 and 1117-350-0500. Fits models 036, 038, 044, 066, 045, 048, 056 and 064.

Fuel/Oil Cap for STIHL



Order No. 39 - 7295

Fuel/Oil Cap replaces Stihl 1117-350-0510 and 1117-640-3600. Fits models 09 thru 044. Oil cap only for models 038, 036, 026 and 034.

Oil Cap for STIHL



Order No. 39 - 7083

Oil Cap. Replaces Stihl 0000-350-0510, 1117-640-3600. Used on models 024, 028, 038, 042 & 048.

Fuel Cap for STIHL



Order No. 39 - 7081

Fuel Cap. Replaces Stihl 0000-350-0520, 1117-350-0500. Used on Stihl model 024.

Fuel Cap for TANAKA

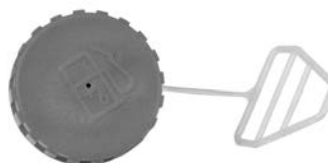

Order No. 20 - 8526

Fuel cap replaces Tanaka 5950165C91. Fits string trimmer models TBC265, TBC500 & hedge trimmer models THT200, THT2120, THT210, THT212, THT230, THT232, THT240.

Fuel Cap for TANAKA



Order No. 20 - 8527

Fuel cap replaces Tanaka 5950502490 & 59501320930. Fits back-pack blowers, models TBL500, TBL455, TBC355.

Oil Tank Cap for TORO & EXMARK



Order No. 20 - 9700

Oil tank cap replaces Toro E513167. Also replaces Exmark 1-513167. 1-5/16" OD, 1-1/2" ID.

Fuel Line Grommet for ECHO



Order No. 20 - 12605

Fuel line grommet replaces Echo V137000030 & 13211546730. 11/16" Diameter, 3 holes. Fits SRM 2510, 2410, GT 2011, HCA2400. Used in our **27-12598**

MIN010

Tank Grommet for STIHL



Order No. 38 - 7294

Tank Grommet replaces Stihl 4114-358-7300 and 4114-358-7000. Fits trimmer models FS60, FS61, FS62 and FS65.

MIN005

20

FUEL LINE



FUEL LINE & ACCESSORIES

Vent Assembly for ECHO & STIHL



Order No. 20 - 9607

Vent assembly replaces Echo 131300-56430 & Stihl 1129-350-5800A. Fits Models GT 1100, 2000, 2100, 2102, 2103, 2400, SRM-1500, 1501, 2100, 2300, 2301, 2400, 2500, 2501, 2510, 3000, 3800, SRS-2100, PE-2400, PB-1000/1010, 2400, ES-2000, SHR-2100.

Duck Bill Valve for HOMELITE



Order No. 38 - 7259

Duck Bill Valve replaces Homelite 69451.

MIN010

Molded Fuel Line for HOMELITE



Order No. 38 - 4972

Replaces Homelite 63745A, 63744A for XL-12 and Super XL-12.

Fuel Line & Grommet for McCULLOCH



Order No. 20 - 7293

Fuel Line and Grommet replaces McCulloch 213948 (fuel line) and McCulloch 215495 (grommet), Toro 41-1880. Also fits Echo and WeedEater trimmers and blowers.

Molded Fuel Line for McCULLOCH



Order No. 38 - 4971

Replaces McCulloch 215708 for model 1010.

Fuel Filter Assembly for KAWASAKI



Order No. 27 - 8533

Fuel filter assembly replaces Kawasaki 49019-2065. Fits trimmer models TD18, 22, 24, 33, 40 & 48.

Fuel Tube for SHINDAIWA



Order No. 27 - 8535

Fuel tube replaces Shindaiwa 20011-85451. Fits models T25, T27, C35 & B45.

Fuel Tube Assembly for SHINDAIWA



Order No. 20 - 7933

Fuel tube assembly replaces Shindaiwa 20000-85303. Fits T-25, C25 & C35 model trimmers.

Molded Fuel Line for STIHL



Order No. 38 - 5831

Replaces Stihl 1119-358-7700. For Stihl model 038.

Grommet with Fuel Line for ECHO



Order No. 27 - 12598

Grommet with fuel line replaces Echo 900103. Grommet with 3 hoses.

20

FUEL LINE

FUEL LINE & ACCESSORIES



Air Filter for SHINDAIWA



Order No. 27 - 8528

Fuel filter replaces Shindaiwa 22100-85420. Fits models T25, T27, C35. Filter only for Shindaiwa 20011-85400.

MIN010

Fuel Filter & Tube Assembly for SHINDAIWA



Order No. 27 - 8534

Fuel filter & tube assembly replaces Shindaiwa 20011-85401. Fits trimmer models T25, T27, C35 & B45.

Fuel Filter with Weight for SHINDAIWA



Order No. 27 - 8529

Fuel filter with weight replaces Shindaiwa 22100-85411. Fits models T25, T27, C35 & B45.

Fuel Line/Filter Assembly for STIHL



Order No. 27 - 7159

Fuel line and filter assembly replaces Stihl 4112-350-3500. Fits model FS80.

Fuel Hose for STIHL



Order No. 38 - 13171

Fuel hose replaces Stihl 1127-358-7702. Fits 029/034/036/039.

Grommet With Hose for STIHL



Order No. 20 - 12847

Grommet with hose replaces Stihl 9890516 & 9302803. Fits Stihl models FS350/400/450/480.

Fuel Hose for STIHL



Order No. 38 - 14277

Fuel hose replaces Stihl 1124-358-7700. Fits models MS 650, 066, MS640, MS880, 084, TS 700, 088, MS 780, TS 800, 064, MS660.

Grommet With Hose for STIHL



Order No. 38 - 14278

Fuel hose replaces Stihl 1122-647-9400. Fits models 026, 034, 036, 064, 066, MS 260, 361.



Order No. 38 - 14257

Fuel line replaces Stihl 1123-358-7701 / 7702. Fits models 021, 023, 025.



OD 1-1/8"
ID 1/2"
Length 3-3/8"

Order No. 20 - 13536

Fuel filter replaces Kubota 15231-443560, Woods 70666, Grasshopper 101000, Jacobsen 550489, Walker 70221. Fits models G4200, G5200, G6200, B1550, B20, B1500, B1750-B7100; all B series and older G series 29 tractor models.

20

FUEL LINE

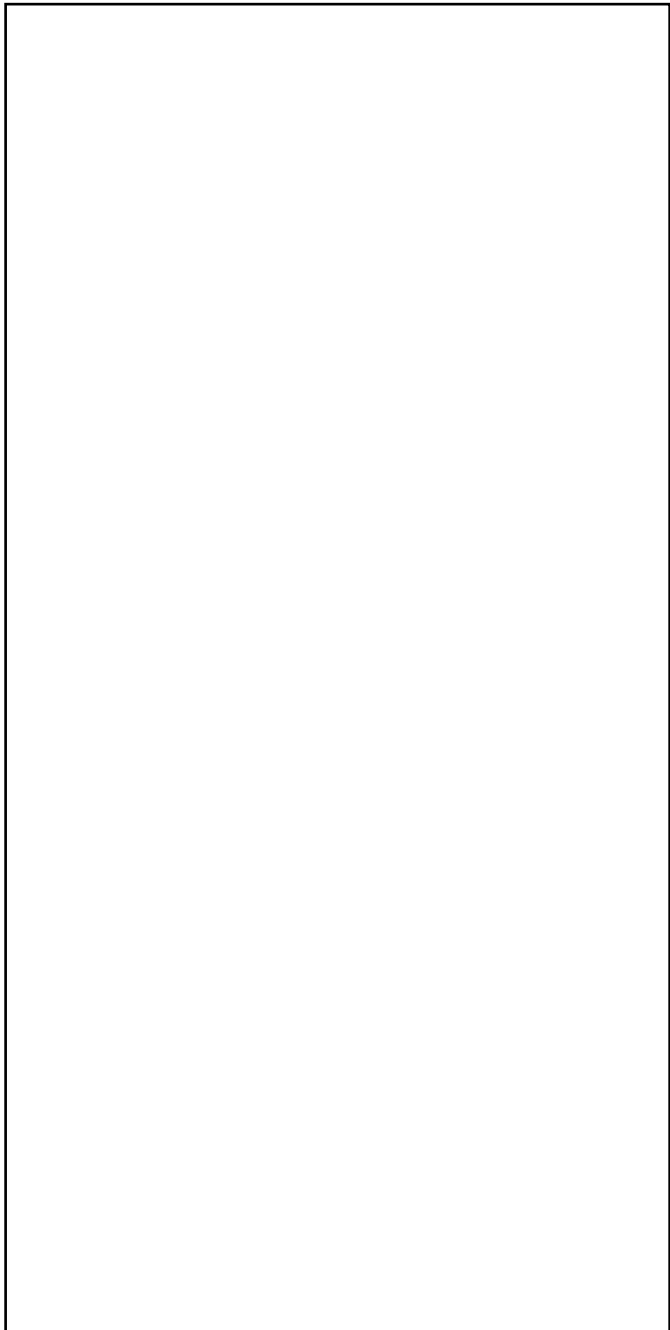

Quick-Glance

SEATS	PG.
Seats	
Universal	522-523
High Back Seats	524
Turf Glider	525
Suspension	525
Arm Rest	526

SEATS



21

Universal Seats
New Bolt Hole Patterns
For Broader Applications

SEATS



MEDIUM BACK SEAT

Order No. 21 - 2227

Universal molded seat and cushion. 1-hole bolt pattern 1/2 - 13 and a 12-hole pattern 5/16 - 18 clinch nut. Seat size: 8-7/8" high, 15-5/8" deep, 19" wide. Molded cushion, drawn steel pan with protective edge trim. Replaces Snapper 7019978. Also fits Ariens, Bolens, Gilson, Murray, MTD, Gravely, Dixon, Yazoo, Roper, Toro and Wheel Horse.

Order No. 21 - 6623

Medium Back Seat Cover. For our 21-2227 seat.

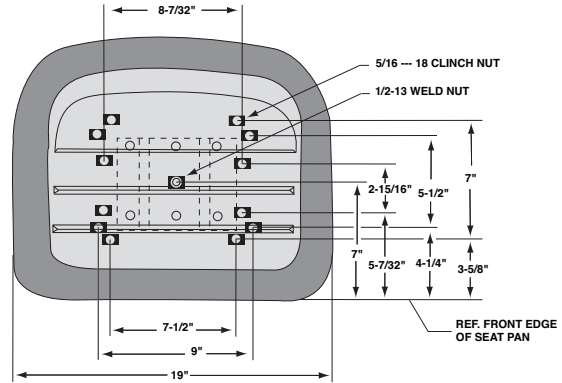

HI-BACK SEAT

Order No. 21 - 2228

Large Universal molded seat and cushion. 1-hole bolt pattern 1/2 - 13 and a 12-hole bolt pattern 5/16 - 18 clinch nut. Seat size: 14" high, 19-1/4" deep, 19-3/4" wide. Seat design features air circulation and water drainage. Molded cushion, drawn steel pan with protective edge trim. Also fits Ariens, Bolens, Ford, Gravely, Gilson, Toro, Snapper, Yazoo, John Deere, Dixon, Allis Chalmers, MTD and Wheel Horse.

Order No. 21 - 6624

High Back Seat Cover. For our 21-2228 seat.

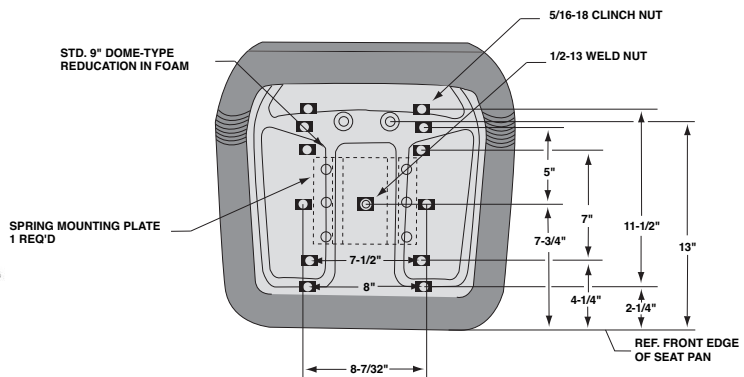

Order No. 21 - 6622

Low Back Seat Cover. Fits seat size: 6" high, 14-1/2" deep, 16-3/4" wide.

Seat Cover



Order No. 21 - 12679

Riding lawnmower seat cover. Protects new seats and renews old seats. Handy back pockets. Protects against weather, UV damages. Coated for water resistance.



Universal Seats (Cont.)
New Bolt Hole Patterns
For Broader Applications

SEAT (MEDIUM BACK)

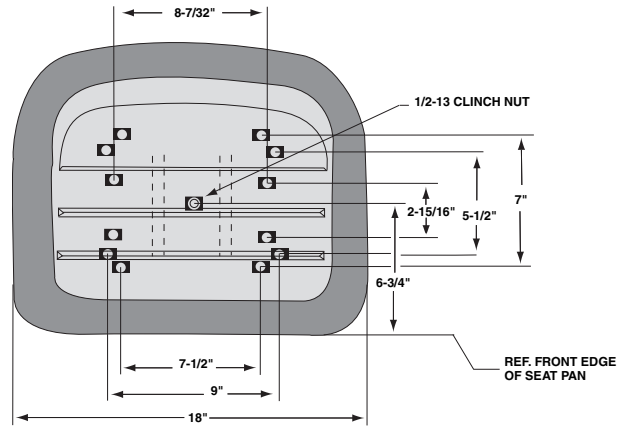

Order No. 21 - 8722

Riding lawnmower seat with medium back. 1-hole bolt pattern 1/2 - 13 and a 12 hole bolt pattern 5/16 - 18 clinch nut. Seat back is heavily padded and provides maximum support to the lumbar area of the operators back. 1-3/4" foam pad provides total comfort. Removable black cover.

SEAT (MEDIUM BACK)

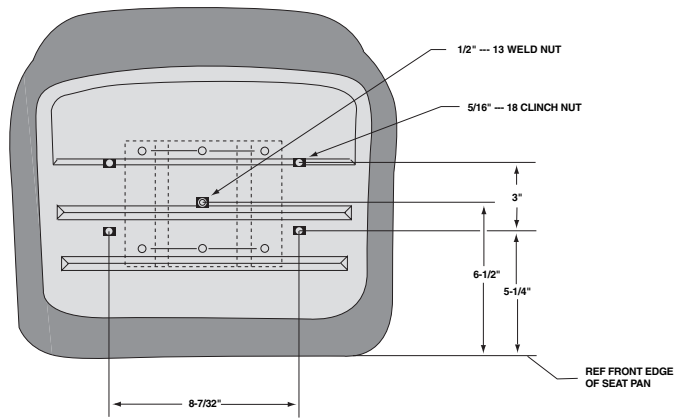

Order No. 21 - 9250

Universal molded seat and cushion. 1-hole bolt pattern, 1/2 - 13 and a 4-hole bolt pattern, 5/16 - 18 clinch nut. Seat size: 7" high, 15" deep, 18" wide. Molded cushion, drawn steel pan with protective edge trim. (Medium back seat)

SEAT (HI BACK)

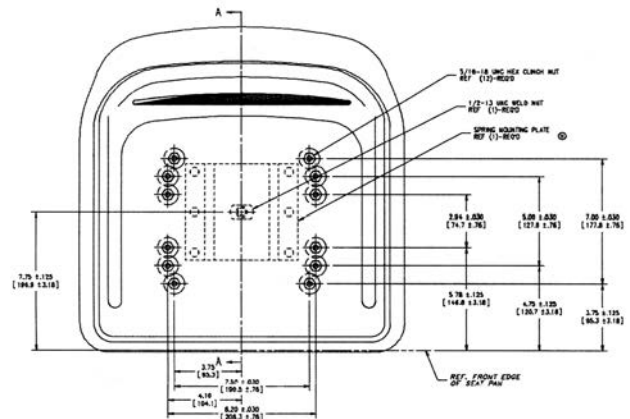

Order No. 21 - 8721

Riding lawnmower seat with hi back. 1-hole bolt pattern 1/2 - 13 and a 12 hole bolt pattern 5/16 - 18 clinch nut. Seat back is heavily padded and provides maximum support to the lumbar area of the operators back. 1-3/4" foam pad provides total comfort. Removable black cover.

SEATS



21

15" High Back Seat

Order No. 21 - 13341

15" High back seat. **Black** Vinyl, 24 x inserts universal bolt pattern.

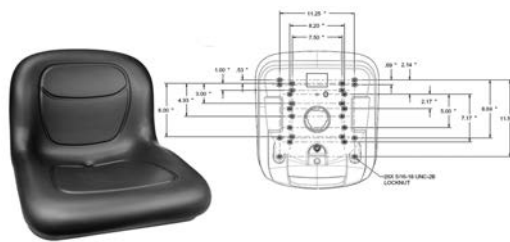

Order No. 21 - 13342

15" High back seat. **Gray** Vinyl, 24 x inserts universal bolt pattern.

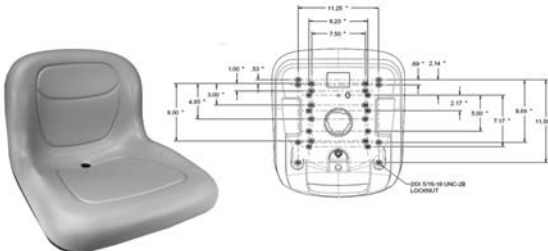

Order No. 21 - 13343

15" High back seat. **Yellow** Vinyl, 24 x inserts universal bolt pattern. Replaces John Deere AM133476.

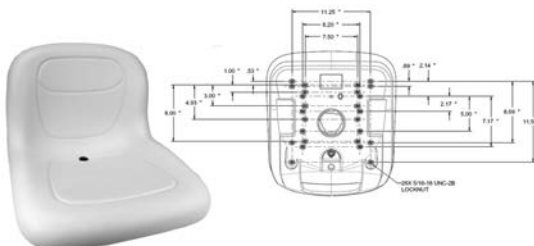

18" High Back Seat

Order No. 21 - 13344

18" High back seat. **Black** Vinyl, 24 x inserts universal bolt pattern.

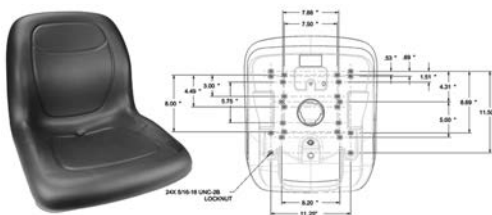

Order No. 21 - 13345

18" High back seat. **Gray** Vinyl, 24 x inserts universal bolt pattern.

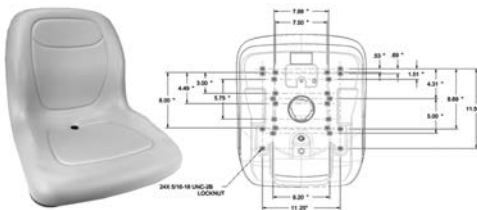

Order No. 21 - 13346

18" High back seat. **Yellow** Vinyl, 24 x inserts universal bolt pattern. Replaces John Deere VG11696.

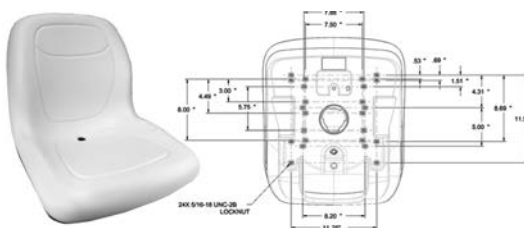

20" High Back Seat

Order No. 21 - 13358

20" High back seat. **Yellow** Vinyl, 24 x inserts universal bolt pattern. Replaces John Deere TCA13830. Heavy Duty

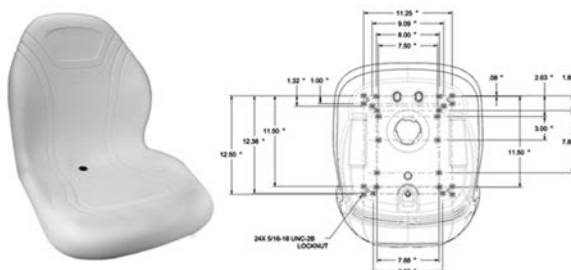



Turf Glider Seat with Suspension



Order No. 21 - 12512

Turf Glider seat with terrain jockey suspension, armrest, seat switch & adjusting sliders. Replaces Dixie Chopper 400293

Turf Glider Seat without Suspension



Order No. 21 - 12521

Turf Glider seat without suspension. Seat with arms, seat switch, sliders. Can be used with our 21-12522 suspension. Replaces Dixie Chopper 400200.

Seat (SST)



Order No. 21 - 12533

Seat (SST) (Spray Skin Technology), gray color with armrests. Replaces John Deere, Exmark, Scag, etc. Features: SST, rugged blow-molded plastic bucket. 4" fore/aft slide adjustment. Waterproof, no sewn covers, foam is recyclable. Can be used with our 21-12530 ultra low profile suspension

Seat Suspension



Order No. 21 - 12530

Seat suspension only. Designed for operator comfort in equipment where vertical space is limited. Easy to operate weight/ride control. Comes with our 21-12529 seat & fits our 21-12532 & 21-12533 seats.

Suspension Seat



Order No. 21 - 12529

Ultralow suspension seat with armrest. Features: 4 inch for/aft slide adjustment. Rugged stamped 14 gauge metal shell with black electrostatic powder coating finish. 32 oz. vinyl upholstery. 10.69 inch wide mounting. 18 inch wide seat cushion. All parts easily serviced. Made in USA.

Terrain Jockey Suspension



Order No. 21 - 12522

Terrain jockey suspension only. Fits Turf Glider Seats. Includes sliders and universal adapter mounting plate.

SEATS



21

Arm Rest Pad



Order No. 21 - 12531

Arm rest pad only. Comes with our 21-12529 seat & fits our 21-12532 & 21-12533 seats. Replaces Exmark 103-0291 & 103-0292.

Arm Rest for HUSTLER



Order No. 21 - 13998

Arm rest replaces Hustler 797480, Ariens/Gravely 01552900/715095 kit, Exmark/Toro 107-1887, 110-6569, 108-6163 & 69-1180.

NOTE:

Multiple horizontal lines for notes.



SMALL ENGINE CARBURETION

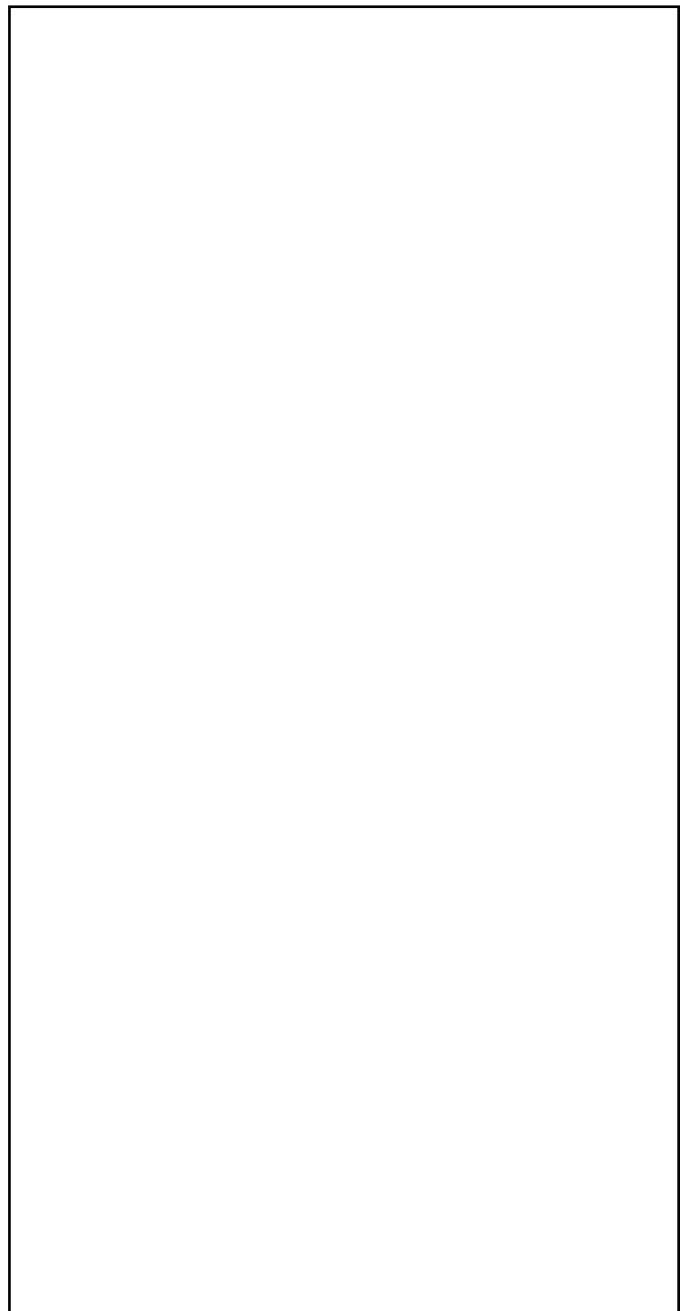
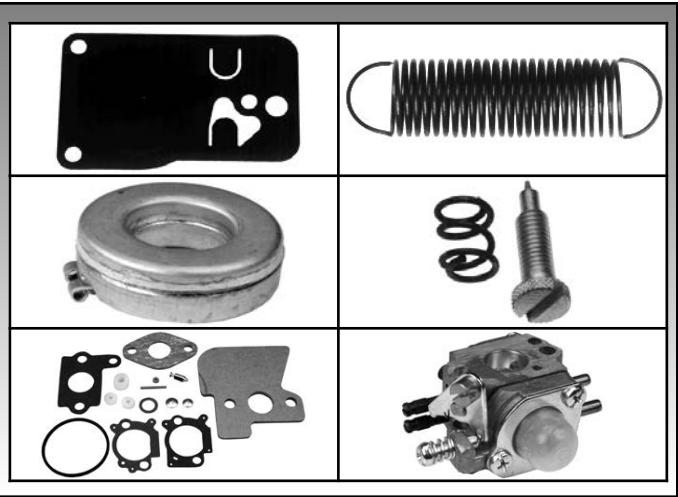
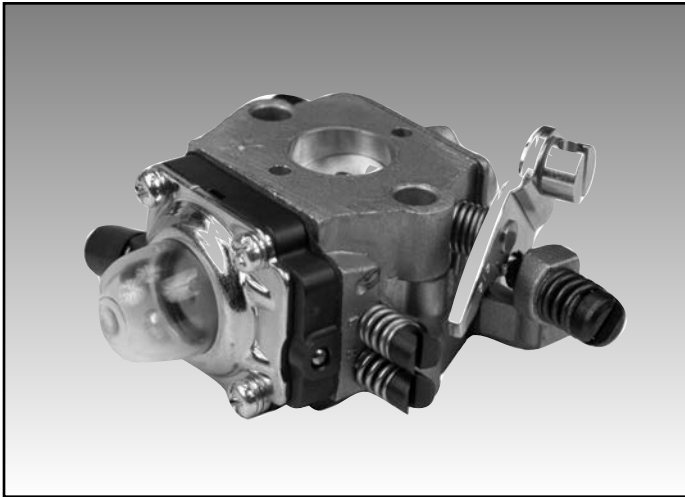

Quick-Glance

SMALL ENGINE CARBURETION	PG.
Small Engine	
Diaphragms	528-529
Governor Springs	530-532
Carburetor Bowl	533
Float Pin	533
Carburetor Float	533-534
Fuel Pump	535
Needle Valve	536-538
Carburetor Overhaul Kit	538-544
Carburetors	545-551

SMALL ENGINE CARBURETION



Diaphragms



Order No. 22 - 1425

Replaces B&S 270026. Fits 60000, 80000, 100000, 130000 series. Fits 3 thru 5 horz. (Pulsa-Jet Carb.). MIN010



Order No. 22 - 1426

Replaces B&S 270253. Fits 82000, 92000 series.

MIN010



Order No. 22 - 1427

Replaces Tecumseh 630978.

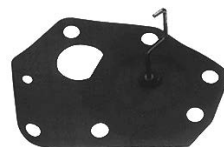

Order No. 22 - 1429

Replaces B&S 299637. Fits 3 hp vert. (Vacu-Jet Carb.)



Order No. 22 - 1428

Replaces B&S 391681. Most popular. Fits new automatic choke models, 3.5 & 4 hp vert. (Pulsa-Jet Carb.)

Diaphragm Kit for B&S



Order No. 22 - 7721

Diaphragm kit. Replaces B&S 495770. Fits 3.75 hp Sprint II Model 98902 and 3-1/2 hp model 95902.

Diaphragm Kit for BRIGGS & STRATTON

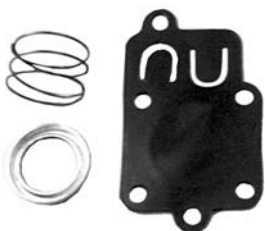

Order No. 22 - 10934

Diaphragm kit replaces B&S 5021D / 270026. Fits 3-5 hp horizontal shaft engines. Pulso jet / new style.

Damping Diaphragm for B&S



Order No. 22 - 8213

Damping Diaphragm replaces B&S 270989. Fits models 253700 thru 255400 & 400400 thru 422700. MIN010

22

SM. ENGINE CARB.



Pump Gasket for B&S



Order No. 22 - 8212

Pump gasket replaces B&S 271025. Fits models 253700 thru 255400 & 400400 thru 422700. MIN010

Fuel Pump Diaphragm for B&S



Order No. 22 - 8227

Fuel pump diaphragm replaces B&S 272638. Fits selected 8 & 11 hp horiz., 14, 16 & 18 hp L-Head twin engines. MIN010

Carburetor Diaphragm for B&S



Order No. 22 - 8364

Carburetor diaphragm replaces B&S 272538. Fits 3-1/2 hp horizontal B&S engine model 90200-90299 & 91200-91299. Also fits 5 hp horizontal B&S engine models 133200-133299, 135200-135299. MIN010

Fuel Pump Kit for B&S



Order No. 22 - 8380

Fuel pump kit replaces B&S 393397. Fits models 253700-255400, 400400-422700. Complete pump kit for B&S twin carburetor, 16 & 18 hp engines.

Fuel Pump Gasket Kit for MIKUNI



Order No. 22 - 8674

Fuel pump gasket kit for Mikuni. Fits Mikuni duel outlet fuel pump. For B&S 491922 fuel pump. Used with our 22-10876.

Throttle Return Spring for HONDA



Order No. 22 - 10856

Throttle return spring replaces Honda 16562-ZE1-020. Fits models GX110/120/140/160.

Throttle Return Spring for HONDA



Order No. 22 - 10869

Throttle return spring replaces Honda 16562-ZE2-000. Fits models GX 240/270/340/390.

Throttle Return Spring for HONDA



Order No. 22 - 10870

Throttle return spring replaces Honda 16562-ZM0-000. Fits models GXV 135/160.

22 SM. ENGINE CARB.

SMALL ENGINE CARBURETION



Governor Springs for BRIGGS & STRATTON

Coil 7/8"
Overall Length 2-1/2"



Order No. 22 - 181

Governor spring. Replaces B&S 260029.

MIN010

Coil 3/4"
Overall Length 6-9/16"



Order No. 22 - 182

Governor spring. Replaces B&S 692207, 260584. Fits models 190700, 191700, 92700, 193700, 253700.

MIN010

Coil 2-3/16"
Overall Length 2-5/8"



Order No. 22 - 171

Governor spring. Replaces B&S 260875, 260877 and 4113. Fits models 92500, 92900, 110000 (3400-3600 RPM).

MIN010

Coil 15/16"
Overall Length 3-1/4"



Order No. 22 - 172

Governor spring. Replaces B&S 260703. Fits models 100900, 130900 (3300 RPM).

MIN010

Coil 14/16"
Overall Length 1-9/16"



Order No. 22 - 173

Governor spring. Replaces B&S 260599. Fits models 60500, 80500 - w/Choke-O-Matic (4000-4200 RPM).

MIN010

Coil 5/16"
Overall Length 1-13/16"



Order No. 22 - 174

Governor spring. Replaces B&S 692205, 260041. Fits models 6B-S, 60100, 61100, 80100, 81100.

MIN010

Coil 13/16"
Overall Length 1-1/4"



Order No. 22 - 175

Governor spring. Replaces B&S 260596. Fits models 60900, 80900 - w/Choke-O-Matic (4000-4200 RPM).

MIN010

Coil 15/16"
Overall Length 1-7/16"



Order No. 22 - 176

Governor spring. Replaces B&S 260832. Fits models 82500, 82900 (4000-4200 RPM).

MIN010

Coil 2-3/8"
Overall Length 1-15/16"



Order No. 22 - 177

Governor spring. Replaces B&S 26763.

MIN010

Coil 2-1/16"
Overall Length 3-1/8"



Order No. 22 - 178

Governor spring. Replaces B&S 260545. Fits models 60200, 61200, 80200, 81200.

MIN010

Coil 2-3/16"
Overall Length 1-5/8"



Order No. 22 - 179

Governor spring. Replaces B&S 260591. Fits models 60900 to 60907, 61900 to 61907 (3400-3600 RPM).

MIN010

Coil 3/4"
Overall Length 1-3/4"



Order No. 22 - 180

Governor spring. Replaces B&S 260025. Fits models 6BH-S (on type #900060 and up), 6050060500, 80500 (w/manual choke).

MIN010

Coil 3/4"
Overall Length 2-3/8"



Order No. 22 - 184

Governor spring. Replaces B&S 691599, 26925. Fits models 6B, 8B, 8BH-A, (w/carb. #294348 only), 60300, 60700 (on type #907133), 80300.

MIN010

Coil 11/16"
Overall Length 3-7/16"



Order No. 22 - 187

Governor spring. Replaces B&S 260711. Fits models 100900, 1300900.

MIN010

SM. ENGINE CARB. 22



SMALL ENGINE CARBURETION

Governor Springs for B&S (Cont.)

Coil 1/2"
Overall Length 1-1/16"

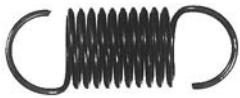

Order No. 22 - 188

Governor spring. Replaces B&S 692208, 260695. Fits models 100200, 130200. MIN010

Coil 13/16"
Overall Length 2-3/16"



Order No. 22 - 7738

Governor spring. Replaces B&S 691833, 262664. Fits 5 hp IC Quantum models 126700-126799. MIN010

Coil 15/16"
Overall Length 2-3/16"



Order No. 22 - 7739

Governor spring. Replaces B&S 691276, 262678. Fits 5 hp Europa models 99700-99799 series. MIN010

Coil 9/16"
Overall Length 1-3/16"



Order No. 22 - 7741

Governor spring. Replaces B&S 691278, 262784. Fits 12-1/2 hp IC models 2860700-286799 series. MIN010

Coil 1/2"
Overall Length 1-5/8"



Order No. 22 - 7735

Governor spring. Replaces B&S 262572. Fits 5 hp Vanguard models 104700-104799. MIN010

Coil 11/16"
Overall Length 1-7/8"



Order No. 22 - 7736

Governor spring. Replaces B&S No. 691832, 262604, 262505. Fits 14 hp Vanguard models 260700-260799 & 261700-261799 series. MIN010

Coil 7/8"
Overall Length 2-3/16"



Order No. 22 - 7737

Governor spring. Replaces B&S 262656. Fits 5 hp Quantum models 124700-124799. MIN010

Coil 1/2"
Overall Length 1-1/8"



Order No. 22 - 7733

Governor spring. Replaces B&S 690480, 260871. Fits 8 hp models 194700-194799 series. MIN010

Coil 1/2"
Overall Length 1-1/8"

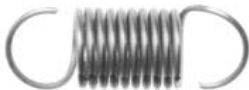

Order No. 22 - 7948

Governor spring. Replaces B&S 691798, 261306. Fits models 190700, 191700 & 192700. MIN010

Coil 2-1/4"
Overall Length 2-3/4"



Order No. 22 - 7940

Governor spring replaces B&S 261105. Fits models 146000, 170000, 190000, 220000 & 251000 1-1/2" Dia. MIN010

Overall Length 1-3/4"



Order No. 22 - 170

Governor spring. Replaces B&S 260878. Fits models 3, 3-1/2, 4 and 5 hp Briggs engines (link). MIN010



Order No. 22 - 13613

Governor blade replaces B&S 691912, 281024. Fits models 98902 & 10A902. 3.5 hp engines.

22

SM. ENGINE CARB.

SMALL ENGINE CARBURETION



Governor Springs for TECUMSEH

Coil 9/16"
Overall Length 1"



Order No. 22 - 183

Governor spring. Replaces Tecumseh 31361. Fits models V70 and 80, VH70 and 80, TVS and TNT. MIN010

Coil 3/4"
Overall Length 1-3/16"



Order No. 22 - 189

Governor spring. Replaces Tecumseh 31386. Fits models most LAV25, LAV-30, LAV-35, LAV-40, LAV-50 (mechanical governors). MIN010

Governor Spring for HONDA

Order No. 22 - 10857

Governor spring replaces Honda 16561-ZE1-810. Fits models GX 110/120/140/160.



Governor Spring for HONDA

Order No. 22 - 11838

Governor spring replaces Honda 16561-ZM0-000. Fits models GCV135/160.



Governor Spring for HONDA

Order No. 22 - 11839

Governor spring replaces Honda 16561-ZE3-000. Fits models GX240/340/390.



Welch Plug for BRIGGS & STRATTON

Order No. 22 - 7972

Welch plug. Replaces B&S 221997. Fits models 146000, 170000, 190000, 220000 & 251000 1-1/2" Dia. MIN010



Welch Plug for BRIGGS & STRATTON

Order No. 22 - 7971

Welch plug. Replaces B&S 690627, 221747. Fits models 220400, 221400, 243400, 252400, 301430 & 325430 1-3/4" Dia. MIN010



Diaphragm Spring for BRIGGS & STRATTON

Order No. 22 - 8209

Diaphragm spring. Replaces B&S 691801, 261395. Fits models 401400 to 422999. Used with our 22-8208. MIN010



Diaphragm Spring Cap for BRIGGS & STRATTON

Order No. 22 - 8208

Diaphragm spring cap. Replaces B&S 690766, 221377. Fits on all 3-1/2, 4 & 5 hp diaphragm style carburetors. Used with our 22-8047 & 22-8209. MIN010



Diaphragm Spring for BRIGGS & STRATTON

Order No. 22 - 8047

Diaphragm spring. Replaces B&S 692206, 260455. Used on many Briggs carburetors that use our 22-1425, 22-1426, 22-1428 & 22-1429. MIN010



Bowl Drain Assembly

Order No. 22 - 1543

Replaces Tecumseh 27136A. MIN010



22 SM. ENGINE CARB.



SMALL ENGINE CARBURETION

**Carburetor Bowl for
TECUMSEH**



Order No. 22 - 8926

Carburetor bowl replaces Tecumseh 631867. Carburetor bowl for Tecumseh 632019 float. Fits float style carburetors without bowl drain. Hole size 5/16". Used with our **22-12263**.

**Carburetor Bowl for
TECUMSEH**



Order No. 22 - 8591

Carburetor bowl replaces Tecumseh 631700. For float style carburetors without bowl drain. Hole size 3/8".



Order No. 22 - 12813

Carburetor float bowl replaces B&S 495933, Kohler 25-104-01-S. Fits Walbro Carburetors. 2-5/8" OD x 1-1/4" HT, 3/8" ID hole.



Order No. 22 - 13537

Carburetor float bowl **only** replaces B&S 495933, Kawasaki 16020-7003. Fits Walbro LMK carburetor's on 19 & 28 CID engines. Does not include gasket, washer, screw. 1.95" OD x 1-5/16" HT, 5/16" ID hole. Uses our gasket **23-11123**.

**Carburetor Float for
Briggs & Stratton**



Order No. 22 - 11958

Carburetor float replaces B&S 299707.

**Float Bowl for
Briggs & Stratton**



Order No. 22 - 13455

Float bowl replaces B&S 221995.



Order No. 22 - 12304

Carburetor float bowl replaces B&S 493640. Fits models LMR. For B&S and Lawnboy engines with Walbro carburetors. 1.860" OD x 1" HT. Small Walbro #20-141.



Order No. 22 - 11959

Carburetor float replaces B&S 99333. For 6, 7 & 8 hp engines with round cartridge filter and main jet on side of bowl. 1-5/16" ID, 2-7/64" OD, 13/16" Ht.



ID .658"
OD 1.54"
Height .643"

Order No. 22 - 10053

Carburetor float replaces B&S 398187, Kohler 12-757-02. Also replaces Walbro 75-570. Fits models LMJ, LMK & LMR.



Order No. 22 - 12670

Carburetor float replaces B&S 494381. Fits larger carburetor bowls.

**Float Pin for
BRIGGS & STRATTON**

OD 3/32"
Length 7/8"



Order No. 22 - 9558

Float pin replaces B&S 230896 & 691775. Also replaces Tecumseh 27106 & Lawnboy 300096 & 92-6389. MIN010

Length .800"
OD .079"



Order No. 22 - 10054

Float pin replaces B&S 691242 & 231371 & Walbro 78-47. Fits models LMJ, LMK & LMR. MIN010

22
SM. ENGINE CARB.

SMALL ENGINE CARBURETION



**Float Bowl Washer for
BRIGGS & STRATTON**



Order No. 22 - 7973

Float bowl washer. Replaces B&S 222014. Fits models 104700, 190700 thru 193700, 251700, 252700 & 280700.
MIN010



Order No. 22 - 12933

Float bowl washer replaces B&S 221172. Also replace Tecumseh 27110A. Fits models H22-H70, HM40-HM70, LAV25-LAV35, V, V40-V100 and VH50-VH70.
MIN010

**Float Bowl for
HONDA**



Order No. 22 - 10479

Float bowl replaces Honda 16015-ZE1-811. Fits models GX110, 120, 140, 160.



Order No. 22 - 10866

Carburetor float bowl replaces Honda 16015-ZE8-005. Fits models GX 240/270/340/390.

**Float for
HONDA**



Order No. 22 - 10476

Float replaces Honda 16013-ZA0-931. Fits models GX240, 270, 340, 390.

**Float & Pin for
HONDA**



Order No. 22 - 10474

Float and Pin replaces Honda 16013-ZE0-005. Fits models GX110, 120, 140, 160.

**Carburetor Float for
KOHLER**



Order No. 22 - 12878

Carburetor float replaces Kohler 25 757 09S. Fits M12-M20 engines.

**Carburetor Float for
KOHLER**



Order No. 22 - 11960

Carburetor float replaces Kohler 25-757-03. Fits models K161, K181, K241, K341 & KT twin series. For 7 & 8 hp engines. Fits all brass float carburetors.

**Carburetor Float Bowl for
Kohler**



Order No. 22 - 12813

Carburetor float bowl replaces Kohler 25-104-01-S. Fits Walbro carburetors. 2-5/8" OD x 1-1/4" HT, 3/8" ID hole.

**Float for
TECUMSEH**



Order No. 22 - 9971

Float replaces Tecumseh 632019. Used on most Tecumseh float type carburetors.

22
SM. ENGINE CARB.



SMALL ENGINE CARBURETION

Fuel Pump for KOHLER



Order No. 22 - 10273

Fuel pump replaces Kohler 52-559-01S & 52-559-03S. Fits models K241-K341 and KT series. Also fits MV16 with specs 56501-56518; MV18 with specs 58501-58539; MV20 with spec 57501-57514 with the exception of specs 58517, 58518, 58519, 58521 and 58523.

Fuel Pump for KOHLER



Order No. 22 - 10211

Fuel pump replaces Kohler 47-559-04S & 47-559-11S. Fits models K241- K341 and M10-M16. Includes hardware and gaskets.

Fuel Pump for KOHLER

Order No. 22 - 13386

Fuel pump replaces Kohler 12-559-02S, 12-393-03, 12-559-01. Fits models CH11-CH15 and CV11-CV16, 1/4" fuel line.



Fuel Pump for KOHLER



Order No. 22 - 10873

Fuel pump replaces Kohler A235845. Fits models K241, 301, 321, & 341.

Fuel Pump for KOHLER



Order No. 22 - 10876

Fuel pump replaces Kohler 24-393-04 & 24-393-16S, B&S 491922. (Metal body). Uses our 22-8674 kit.

Fuel Pump for KAWASAKI



Order No. 22 - 10875

Fuel pump replaces Kawasaki 49040-7001, Honda 16700-ZL8-013, Kohler 24-393-16 & BS 808656. Plastic Mikuni style.

Impulse Fuel Pump for WALBRO



Order No. 22 - 14655

Impulse fuel pump replaces Walbro FPC-1-1. With stainless steel screws.

Choke Lever for HONDA

Order No. 22 - 10863

Choke lever replaces Honda 16610-ZE1-000. Fits models GX 110/120/140/160 & GX 240/270/340/390.

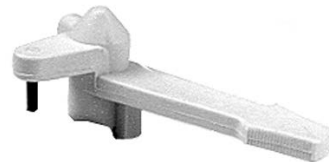

22
SM. ENGINE CARB.

SMALL ENGINE CARBURETION



Needle Valve for HONDA



Order No. 22 - 10463

Needle valve replaces Honda 16011-ZE0-005. Fits models GX110, 120, 140, 160. Inlet needle only.



Order No. 22 - 10475

Needle valve replaces Honda 16011-ZA0-931. Fits models GX240, 270, 340, 390. Inlet needle only.

Needle Valve for HONDA



Order No. 22 - 10945

Needle valve replaces Honda 16155-883-005. Fits models G10, G150, G200, G300, GV150 and GV200. Code 0636282. MIN005

Needle Valve for BRIGGS & STRATTON



Order No. 22 - 10944

Needle valve replaces B&S 231855S. Fits models 286402, 286707, 289707, 28B702, 28B707, 28M707, 28N707, 28N777 & 28P777. For 10, 10.5, 11.5, 12.5, 13, 14, 15 hp (28 CID) vertical engines. Included in our 22-10237 carburetion kit. MIN010

Carburetor Nozzle for BRIGGS & STRATTON

Length 2.534"



Order No. 22 - 10943

Carburetor nozzle replaces B&S 299740. Fits models 146700, 147700, 170700, 171700, 190000, 191000, 220000, 251700, 252700 & 300420.

Carburetor Nozzle for BRIGGS & STRATTON

Length 2.88"



Order No. 22 - 10942

Carburetor nozzle replaces B&S 398039. Fits models 142300 to 143457, 144200 to 145254, 146400 to 147700, 190400, 191400, 193401 to 200466 and 233401.

High Speed Needle Valve for BRIGGS & STRATTON

Order No. 22 - 10941

High speed needle valve replaces B&S 99525S. Fits 170400 - 190400, 220400, 221400, 243400, 252400, 254400, 300400 and 302400.



Needle & Seat for BRIGGS & STRATTON



Order No. 22 - 10940

Needle and seat replaces B&S 293962. Fits models 140000, 170000, 190000 and higher. Viton - Tipped style.

Needle & Seat Assembly for ONAN



Order No. 22 - 10946

Needle and seat assembly replaces Onan 0142-0553. Fits models B43 & B48.

SM. ENGINE CARB. 22



Order No. 22 - 2887

Replaces Briggs & Stratton 230005. Fits 60300, 60400, 60700, 80300, 81300, 80400, 81400 series. 2 hp horizontal and 3 hp horizontal. MIN010



Needle & Seat for BRIGGS & STRATTON



Order No. 22 - 10055

Needle and seat replace B&S 398188.

Order No. 22 - 1419

Needle-Float. Replaces B&S 394681. Fits 7 thru 18 hp Horz. and Vert. Engines.



Order No. 22 - 1423

Replaces B&S 299059 and Marvel Schebler 28-113A. Fits 80100, 80500 & 80600 series, 2 & 3 hp horz. (Vacu-Jet Carb.)

Order No. 22 - 1420

Replaces Needle Valve B&S 396795 & 391233.



Order No. 22 - 1424

Replaces B&S 299060 and Marvel Schebler 28-114A. Fits 3 thru 5 hp horz. & vert. (Pulsa-Jet Carb.)

Order No. 22 - 1431

Replaces B&S 293478. Fits 3 & 5 hp horz.



Idle Adjustment Valve Set for B&S



Order No. 22 - 8046

Idle adjustment valve set. Replaces B&S 292681. Fits 7-18 hp Horz. & Vert., engines. Fits models 170400-194400, 195400, 200400-252700, 253700, 254400, 255700, 256700, 280700, 300400, 302400, 320400, 326400, 400400-402400, 404400-422700.

Needle Valve Kit for BRIGGS & STRATTON



Order No. 22 - 8255

Needle valve kit. Replaces B&S 394682. Fits models 170400 thru 195400, 200400 thru 256700, 280700, 281700, 326400 if equipped with push in brass seat.



Order No. 22 - 2888

Replaces Briggs & Stratton 690266, 23433. Fits 60100, 60200, 60500, 60900, 80100, 80200, 80500, 80900, 82000, 92000, 94900, 100000, 110000 and 130000 series. 2 hp & 3 hp horizontal, 3.5 hp & 4 hp vertical, 5 hp horizontal & vertical. MIN010



Order No. 22 - 2890

Double slotted carburetor screw. Replaces Briggs & Stratton 690953, 94616, 93357. MIN010

22 SM. ENGINE CARB.

SMALL ENGINE CARBURETION



Needle Valve Seat for BRIGGS & STRATTON



Order No. 22 - 8053

Needle valve seat. Replaces B&S 692134, 230591. Fits 3 hp horz. 80200-80299, 3-1/2 hp vert. 92900-92909, 4 hp horz. 110200-110299, 5 hp horz. 130200-130299. MIN010

LAWN-BOY

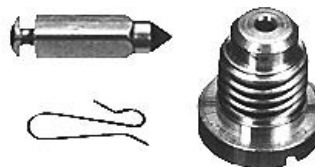

Order No. 22 - 2950

Replaces Lawn-Boy 92-9697, 681741, 301996, 678882.

Inlet Needle Kit for TECUMSEH



Order No. 22 - 12263

Inlet needle kit replaces Tecumseh 631021B.

TECUMSEH



Order No. 22 - 1430

Replaces Tecumseh 630932.

SM. ENGINE CARB. 22

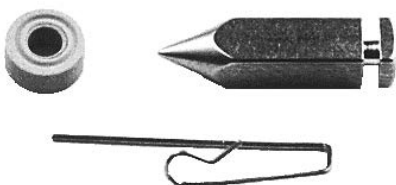

Order No. 22 - 1434

Replaces Tecumseh 631021.

WALBRO

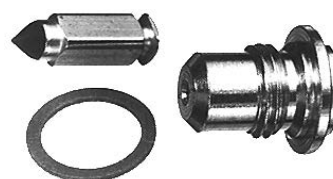

Order No. 22 - 2889

Replaces Walbro 200-547 & 200-506.

Carburetor Overhaul Kit for BRIGGS & STRATTON



Order No. 22 - 7967

Carburetor overhaul kit replaces B&S 494625. Fits models 100900, 130900, 131900, 132900.

Order No. 22 - 7951

Carburetor overhaul kit replaces B&S 494622. Fits models 92500, 92900, 93500, 93900, 94500, 94900, 95500, 110900, 111900, 112900, 113900, 114900. 3 - 3.5 vertical Vacu-Jet Carburetors.



Order No. 22 - 7968

Carburetor overhaul kit replaces B&S 394989. Fits models 10, 11 & 16 hp horizontal cast iron single cylinder engines.



Order No. 22 - 7969

Carburetor overhaul kit replaces B&S 494623. Fits models 92500, 92900, 93500, 93900, 94500, 94900, 95500, 110900, 111900, 112900, 113900, 114900. 3-1/2 & 4 vertical engines.



SMALL ENGINE CARBURETION



Order No. 22 - 10086

Carburetor overhaul kit replaces B&S 491539, 694056. Fits models 400400 thru 422700 (16 & 18 hp engines). Kit for twin cylinders. 3 hole fuel pump



Order No. 22 - 1407

Carburetor overhaul kit replaces B&S Early Pulsa Jet. Fits models 5S, 6BHS (900010 and up), 6BS, 6BSF, 6BSFB, 6BSR6, 6S, 6SFB, 6SR6, 60100 to 60197, 60500 to 60597, 61500 to 61597, 80100 to 81097, 81100 to 81597, 80600, 81600, 84502, 85502.



Order No. 22 - 1413

Carburetor overhaul kit replaces B&S Later Pulsa Jet. Fits models 60200 to 62097, 61200 to 61297, 60900 to 60907, 61900 to 61907, 80200 to 80297, 81200 to 81292, 80800, to 81800, 80900 to 81900, 84902, 85902, 100202 to 100293, 130202 to 130293, 140200, 141200, 144200, 145200.



Order No. 22 - 1414

Carburetor overhaul kit replaces B&S Latest Pulsa Jet. Fits models Type No. 0010-0499, 0110, 0280, 82500 to 82900, 92500 to 92900, 92500 to 92599, 92900 to 92997.



Order No. 22 - 1415

Carburetor overhaul kit replaces B&S 291691. Fits models 6, 6AH, 6B, 6BF, 6BFB, 6R6, 6BH, 6H, 6HF, 6BR6, 6F, 6FB, 8B, 8BF, 8BH, 8, 8F, 8FB, 8R6, 8BHA, 8BR6, 8R, 8P, 9, 9B, 9FB, 9R6, 9R6D, 9F, 9R, 60300 to 60499, 90700 to 60799, 61300 to 61499, 61700 to 61799, 80300 to 80499, 81300 to 81499, 2 & 3 hp horz. .



Order No. 22 - 1416

14, 14B, 14FB, 14R6, 14R6D, 14F, 14R, 19, 19B, 19D, 19FB, 19R6, 19R6D, 23, 23A, 23AB, 23B, 23C, 23D, 23R6, 23R6D, 142300 to 143457, 146400 to 146468, 146700 to 146708, 190400 to 190499, 191400 to 191477, 193400 to 200466, 231401 to 231499, 147400 to 147466, 147700 to 147703, 170400 to 170499, 170700 to 170799 (Fits older 7 hp). horizontal 146400, 147400, 147700, 170400, 170700, 191400 horizontal. 7 thru 9 hp horz..



Order No. 22 - 2884

Carburetor overhaul kit replaces B&S 294698, 299852. Fits models 146700, 170700, 171700, 190700, 191700, 220700, 251700, 394698, 252700 Series (6 hp, 7 hp vertical, 8 hp vertical, 10 hp vertical, 11 hp vertical). (For Float-type Carburetors). 7 thru 12 hp vert.



Order No. 22 - 2885

Carburetor overhaul kit replaces B&S 291071. Fits models 220400, 221400, 22240, 251400, 252400, 301430, 302430. 10 thru 12, 16 hp horz. (Single Cylinder)

22

SM. ENGINE CARB.

SMALL ENGINE CARBURETION



Carburetor Overhaul Kit for BRIGGS & STRATTON



Order No. 22 - 10237

Carburetor overhaul kit replaces B&S 498260. Fits models 83400, 90700, 91700, 99700, 12A800, 12D800, 121700, 121800, 122700, 126700, 126800 and all Quantums 5 HP. Walbro equipped float type.



Order No. 22 - 12293

Carburetor kit replaces B&S 692703/792383/499685. Fits Walbro Carburetor on IICID vertical shaft engines.

SM. ENGINE CARB. 22



Order No. 22 - 10933

Carburetor overhaul kit replaces B&S 497535 / 495799. Fits models 286700, 28N700, 196700 & 288700.



Order No. 22 - 10938

Carburetor overhaul kit replaces B&S 693503. Fits models 42A/B/D/E700



Order No. 22 - 10932

Carburetor overhaul kit replaces B&S 690191. Fits models 287707, 28777, 28N777, 28P777, 28Q777, 28S777, 28U707, 28U700, 28W707, 310707, 310777, 311707, 311777, 312777, 313777. Vanguard diamond I/C intek 15.5, 16, 16.5 & 17 hp.



Order No. 22 - 10939

Carburetor overhaul kit replaces B&S 497481. Fits 10, 10.5 & 11.5 hp vertical engines. (28 CID)



Order No. 22 - 11140

Carburetor overhaul kit replaces B&S 495606 / 494624. Fits 3-5.5 hp horizontal models 80200, 81200, 82200, 133200, 135200, 92200, 93200, 136200, 100200, 111200, 112200 & 130200.



Order No. 22 - 10935

Carburetor overhaul kit replaces B&S 494349. Fits 3.5 - 4 hp max series & Quantum engines. (12 CID). For 5 - 6 hp vertical engines with float carburetor.



SMALL ENGINE CARBURETION

Carburetor Overhaul Kit for BRIGGS & STRATTON



Order No. 22 - 10936

Carburetor overhaul kit replaces B&S 499220. Fits models 284700, 285700, 289700, 282700, 288700, 28C700, 28D700.



Order No. 22 - 10937

Carburetor overhaul kit replaces B&S 497578. Fits models 19B400, 19C400, 192400, 196400 & 197400.

Order No. 22 - 10931

Carburetor gasket set replace B&S 398183 / 498261. Fits models 122K02, 122K82, 124K02, 12F702, 12F782, 12G802, 12H702, 12H802 & 12H807. Fits engines with walbro carburetor's. Quantum 3.5, 4, 4.5, 5, 5.5, and 6 hp.



Carburetor Kit for KOHLER



Order No. 22 - 13231

Carburetor kit replaces Kohler 25-757-11S.



Order No. 22 - 2886

Carburetor Repair kit replaces Kohler 25-757-01. Fits models K-90, 91, 141, 160, 161, 181, 191, 241, 301, 321, 330, 331, 341 Series (4, 6, 7, 8, 10, 12, 14, and 16 hp) (Kit 251-25-757-01).

KOHLER Carburetor Repair Kit



Order No. 22 - 2575701S

Kohler 2575701S OEM carburetor repair kit. For K91-301, M8-12.



KOHLER Carburetor Repair Kit

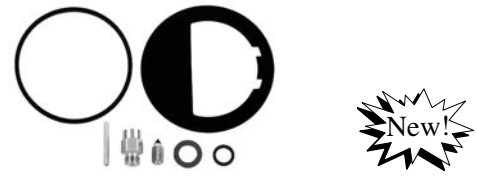

Order No. 22 - 2575702S

Kohler 2575702S OEM carburetor repair kit. For K301-582, M12-20.



Carburetor Repair Kit for HONDA

Order No. 22 - 14272

Carburetor repair kit replaces Honda 16010-ZE2-812. Only includes bowl gasket and O-rings. Fits Honda engine models GX340 and GX390.

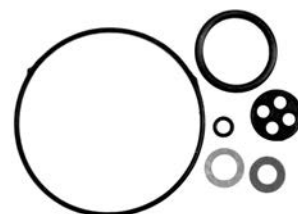

22

SM. ENGINE CARB.

SMALL ENGINE CARBURETION



Carburetor Overhaul Kit for TECUMSEH



Order No. 22 - 10947

Carburetor overhaul kit replaces Tecumseh 631839 / 631584. For models H25 -H70, LAV25 - 35, HA, HM40-70V, VH50-70 for 2-7 hp engines.



Order No. 22 - 13103

Carburetor Repair kit replaces Tecumseh 631978.



Order No. 22 - 13128

Carburetor Repair kit replaces Tecumseh 632347. Fits HM80-HM100, HH100, OHM120, OHSK120, OHV125, OVM120, OXVL120, TVM170, TVM195, TVM220, TVXL195, TVXL220, VH100, HHM80, HMSKSK.



Order No. 22 - 1408

Carburetor Repair kit replaces Tecumseh 31840. Fits models H25 thru 70, LAV25, 30, HS, HM40 thr 70, V, VH40 thur 70.



Order No. 22 - 13267

Carburetor kit for Tecumseh fits our 22-13143.

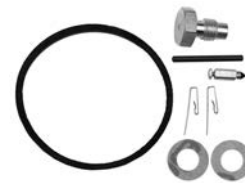

Order No. 22 - 13265

Carburetor kit for Tecumseh fits our 22-13141.



Order No. 22 - 10948

Carburetor overhaul kit replaces Tecumseh 631782. Fits H25 thru 70, LAV25 thru 35, HS, HM40 thru 70, V, VH50 thru 70.

SM. ENGINE CARB. 22



Carburetor Kit for
TECUMSEH

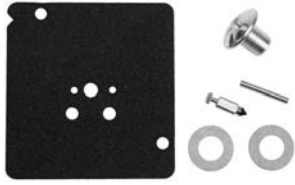

Order No. 22 - 13266

Carburetor kit for Tecumseh fits our 22-13142 & 22-13153.

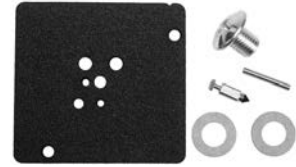

Order No. 22 - 13276

Carburetor kit for Tecumseh fits our 22-13148 & 22-13151.



Order No. 22 - 13275

Carburetor kit for Tecumseh fits our 22-13147.



Order No. 22 - 13274

Carburetor kit for Tecumseh fits our 22-13154 & 22-13155.



Order No. 22 - 13273

Carburetor kit for Tecumseh fits our 22-13146.



Order No. 22 - 13272

Carburetor kit for Tecumseh fits our 22-13150.



Order No. 22 - 13271

Carburetor kit for Tecumseh fits our 22-13152.



Order No. 22 - 13270

Carburetor kit for Tecumseh fits our 22-13149.

22

SM. ENGINE CARB.

SMALL ENGINE CARBURETION



Order No. 22 - 1409

Carburetor Repair kit replaces Tecumseh 29155, 30359, 31390. Fits models H22, H25, H30, H35, H40, H45, H50, H55, H60, H70, HH40, HH50, HH60, HH70, VH80, VH100, L Series, LV Series, LAV Series, V Series, VT Series. (Walbro Equipped). H50, H60, HH40, HH50, HH60, V40, V45, V45B, V45D, V55, V55B, 0359, V55D, VH80, VH100.



Order No. 22 - 1411

Carburetor Repair kit replaces Tecumseh 631893. Fits models H22, H22R, H25R, H30, H30R, H35, H35R, H221 thru H35P, HB22J thru HB35D, HR22J thru HR22P, H, HB, L, N, H. (Diaphragm Carbs)

22
SM. ENGINE CARB.



Order No. 22 - 10103

Carburetor Repair kit replaces Tecumseh 631029. Fits models H25 thru 50, LAV25 thru 35 HS, HM40 thru 70 V, VH50 thru 70.

Carburetor Overhaul Kit for CLINTON



Order No. 22 - 1409

Carburetor Repair kit replaces Clinton 29155. Fits models 400, A400, 404, 406, 490, 494, 498, 500, B1290, GEM Series.

Carburetor Overhaul Kit for JACOBSEN



Order No. 22 - 1409

Carburetor Repair kit replaces Jacobsen 29155, 29157. Fits models J321, J321B, J321E, J321G, J321VA, J321VE, J321VF.

Carburetor Overhaul Kit for LAWNBOY



Order No. 22 - 1421

Carburetor Repair kit replaces Lawnboy 678415, 677271. Fits models D Series, D460, 400, 401, 402, 403, 404, 440, 441, 442, 443, 444, 450, 451, 452. C Series, C10, 70, 71, 72, 73, 12, 12AA, 13, 14, 15, 40, 41, 50, 51, 60, 61, 17AA, 18, 18AA, 19, 43, 74, 76, 77, 78, 80, 81, 16, 17, 42. Does not include Primer Assembly (2951).



SMALL ENGINE CARBURETION

Zama Carburetor for ECHO



Order No. 22 - 11175

Zama carburetor replaces Echo 125200-20561. Fits Echo models PB2100. Zama C1U-K42B.

Zama Carburetor for ECHO



Order No. 22 - 11176

Zama carburetor replaces Echo 12520005962. Fits Echo models HC1500, HC1600, HC2000, HC2410, HC2400 and HCR1500. Zama C1U-K51.

Zama Carburetor for ECHO



Order No. 22 - 11177

Zama carburetor replaces Echo 12520013312. Fits Echo models SRM2100, GT2000, GT2100, ST2000SB, PAS and PDSR. Zama C1U-K52.

Zama Carburetor for ECHO



Order No. 22 - 11178

Zama carburetor replaces 12520013123. Fits Echo model TC2100. Zama C1U-K54A.

Zama Carburetor for ECHO



Order No. 22 - 11179

Zama carburetor replaces Echo A02100380 & A021000381. Fits Echo models GT200, GT201, SRM200, SRM201, SRM130, SRM231, HC160, HC180 & HC200. Zama RB-K66A, RB-K70A.

Walbro Carburetor for ECHO



Order No. 22 - 11165

Walbro carburetor replaces Echo 12300051730. Fits Echo model SRM2601, SRM2400. Walbro WYJ-220.

Walbro Carburetor for ECHO



Order No. 22 - 11164

Walbro carburetor replaces Echo 12300057730. Fits model SRM2610 trimmers. Walbro WYJ-192.

22

SM. ENGINE CARB.

SMALL ENGINE CARBURETION



Walbro Carburetor for ECHO



Order No. 22 - 11163

Walbro carburetor replaces Echo 12300040630. Fits Echo models SRM2000, SRM2200 & GT22000 trimmers and hedge trimmers. Walbro WY-18.

Walbro Carburetor for ECHO



Order No. 22 - 11155

Walbro carburetor replaces Echo 12300052133. Fits Echo model GT2400. Walbro WT-424, Zama C1U-K23B.

Walbro Carburetor for ECHO



Order No. 22 - 11968

Walbro carburetor replaces Echo A021000230. Fits model CS3000, CS301. Walbro WT-589-1.

Zama Carburetor for ECHO



Order No. 22 - 11967

Zama carburetor replaces Echo A02100740. Fits model SRM 230 string trimmers. Zama RB-K75.

Walbro Carburetor for ECHO

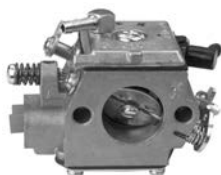

Order No. 22 - 11975

Walbro carburetor replaces Echo. Fits model SRM 2601. Walbro HDA-203-1.

Zama Carburetor for ECHO



Order No. 22 - 11973

Zama carburetor replaces Echo A021000770. Fits model PB-610, 620 blower. Zama C1M-K76.

Walbro Carburetor for ECHO



Order No. 22 - 11971

Walbro carburetor replaces Echo A021000052. Fits model SRM260 brushcutter. Walbro WYJ-250-1.

Zama Carburetor for ECHO



Order No. 22 - 11970

Zama carburetor replaces Echo 12520008561. Fits model PB-4600 blower. Zama C1M-K37D.

Zama Carburetor for ECHO



Order No. 22 - 11170

Zama carburetor replaces Echo 12520008664. Fits Echo models PB602, PB603, PB610 & PB611. Zama C1M-K49C.

22

SM. ENGINE CARB.



**Zama Carburetor for
HOMELITE**



Order No. 22 - 11974

Zama carburetor replaces Homelite 985308001. Fits model John Deere LE30CC trimmer. Zama C1U-H60D.

**Carburetor for
HONDA**



Order No. 22 - 13203

Carburetor replaces Honda 16100-ZOD-003. Fits model GX100.



Order No. 22 - 13204

Carburetor replaces Honda 16100-ZM7-G17. Fits model GXH50.



Order No. 22 - 13207

Carburetor replaces Honda 16100-ZJ1-892. Fits model GX620.



Order No. 22 - 13202

Carburetor replaces Honda 16100-ZE7-W21. Fits model GXV160.



Order No. 22 - 13205

Carburetor replaces Honda 16100-ZM5-803. Fits model GX31.



Order No. 22 - 13192

Carburetor replaces Honda 16100-ZH7-W61. Fits model GX120.



Order No. 22 - 13193

Carburetor replaces Honda 16100-ZE1-825. Fits model GX140.



Order No. 22 - 13194

Carburetor replaces Honda 16100-ZH8-W61. Fits model GX160.

Order No. 22 - 13195

Carburetor replaces Honda 16100-ZL0-W51. Fits model GX200.



SMALL ENGINE CARBURETION



Carburetor for HONDA



Order No. 22 - 13196

Carburetor replaces Honda 16100-ZE2-W71. Fits model GX240.



Order No. 22 - 13197

Carburetor replaces Honda 16100-ZH9-W21. Fits model GX270.



Order No. 22 - 13198

Carburetor replaces Honda 16100-ZE3-V01. Fits model GX340.



Order No. 22 - 13199

Carburetor replaces Honda 16100-ZF6-V01. Fits model GX390.



Order No. 22 - 13200

Carburetor replaces Honda 16100-ZE6-055. Fits model GXV120.



Order No. 22 - 13201

Carburetor replaces Honda 16100-ZG9-803. Fits model GXV140.



Order No. 22 - 13206

Carburetor replaces Honda 16100-ZN2-811. Fits model GX670.

Carburetor for HUSQVARNA



Order No. 22 - 13287

Carburetor replaces Walbro HDA-86, Husqvarna 503-28-10-16. Fits PS50, 51, 250R, 250RX clearing saw/brush cutter.



Order No. 22 - 13285

Carburetor replaces Husqvarna 503-28-10-19, 503-17-32-01, Walbro HDA-98. Fits 42, 238, 242, 246 chainsaws.



Order No. 22 - 13286

Carburetor replaces Husqvarna 503-28-13-20, 503-10-03-03, Walbro WT-99. Fits 40 & 244 chainsaws.

SM. ENGINE CARB. 22



SMALL ENGINE CARBURETION

Walbro Carburetor for KAWASAKI



Order No. 22 - 11969

Walbro carburetor replaces Kawasaki 15003-2804. Fits model AG20 blower, TE059D. Walbro WYK-128-1.

Walbro Carburetor for POULAN



Order No. 22 - 11151

Walbro carburetor replaces Poulan 530069651. Fits Poulan model GT1. Walbro WT-298, WT-629.

Walbro Carburetor for POULAN



Order No. 22 - 11972

Walbro carburetor replaces Poulan 530071637. Fits model GTI 32cc trimmer. Walbro WT-628-1.



Order No. 22 - 11147

Walbro carburetor replaces Red Max 1148-81001. Fits model GSK30D brushcutter, GOPEDS, KOMATSU ZENOAH G2, D8 and G230 PU. Walbro WA-167.

Walbro Carburetor for RYOBI



Order No. 22 - 11157

Walbro carburetor replaces Ryobi 7843. Fits Ryobi trimmer models. Walbro WT-539.

Walbro Carburetor for SHINDAIWA



Order No. 22 - 11168

Walbro carburetor replaces Shindaiwa 70036-81002. Fits Shindaiwa model T20 trimmers. Walbro WZ-8C.



Order No. 22 - 11166

Walbro carburetor replaces Shindaiwa 20016-81020 & 20016-81021. Fits Shindaiwa model S230. Walbro WYL-19.

Walbro Carburetor for STIHL



Order No. 22 - 11150

Walbro carburetor fits Stihl models 4133FS & 4226. Walbro WT-227, WT-264.

22

SM. ENGINE CARB.

SMALL ENGINE CARBURETION



Order No. 22 - 11148

Walbro carburetor fits Stihl models FS51, 61, 65, 85 & 90 trimmers. Walbro WT-38.



Order No. 22 - 11145

Walbro carburetor fits Stihl models BR400. Walbro HD-4.

**Carburetor for
Briggs & Stratton**



Order No. 22 - 14111

Carburetor replaces B&S 498170. Fits most vertical shaft engines with primer button (no choke). 4-7 hp. Also replaces 497586 for 12D800-123K00 series.



Order No. 22 - 14112

Carburetor replaces B&S 499059. Fits most vertical shaft engines with choke. 4-7 hp. Also replaces 497586 for 12D800-123K00 series.

**Carburetor for
TECUMSEH**



Order No. 22 - 13566

Carburetor replaces Tecumseh 640350, 640303, 640271. Fits models LV195EA, LV195XA. Replaces our 22-13144.



Order No. 22 - 13146

Carburetor replaces Tecumseh 632230. Fits model H50, H60. Uses our kit 22-13273.



Order No. 22 - 13147

Carburetor replaces Tecumseh 632615. Fits model H30, H50. Uses our kit 22-13275.



Order No. 22 - 13148

Carburetor replaces Tecumseh 632671C. Fits model VLV55, VLXL50, VLV40, VLV50, VLV60, VLV126. Uses our 22-13276 kit.



Order No. 22 - 13149

Carburetor replaces Tecumseh 632795A. Fits model TVS90. Uses our kit 22-13270.



Order No. 22 - 13150

Carburetor replaces Tecumseh 640017B. Fits model OHH45, OHH50. Uses our kit 22-13272.

22
SM. ENGINE CARB.



SMALL ENGINE CARBURETION

**Carburetor for
TECUMSEH**



Order No. 22 - 13151

Carburetor replaces Tecumseh 640020B. Fits model VLV50, VLV55, VLV60, VLV66, VLV126. Uses our kit **22-13276**.



Order No. 22 - 13152

Carburetor replaces Tecumseh 640025C. Fits model OHH55, OHH60, OHH65. Uses our kit **22-13271**.



Order No. 22 - 13153

Carburetor replaces Tecumseh 640065A. Fits model OHV110, OHV125, OHV130, OHV115, OHV120, OV358EA, OVH135. Uses our kit **22-13276**.



Order No. 22 - 13154

Carburetor replaces Tecumseh 640152A. Fits model HM80, HM100. Uses our kit **22-13274**.



Order No. 22 - 13141

Carburetor replaces Tecumseh 640084B. Fits models HSK40, HSK50 & LH1995P. Uses our kit **22-13265**.



Order No. 22 - 13142

Carburetor replaces Tecumseh 640330A. Fits models OHV140, OHV170, OHV175, OV490. Includes fuel shut off solenoid. Uses our kit **22-13266**.



Order No. 22 - 13143

Carburetor replaces Tecumseh 632334A. Fits model HM70, HM80. Uses our kit **22-13267**.



Order No. 22 - 13155

Carburetor replaces Tecumseh 640260A. Fits model HM80, HM90, HM100, LH318XA, LH358EA. Uses our kit **22-13274**.

Order No. 22 - 14110

Carburetor replaces Tecumseh 640349. Also replaces 640052, 640054. Fits Tecumseh models HMSK80, HMSK85, HMSK90, HMSK100, HMSK105, HMSK110, LH318SA, LH358SA series engines.



22
SM. ENGINE CARB.

INTERNAL ENGINE PARTS

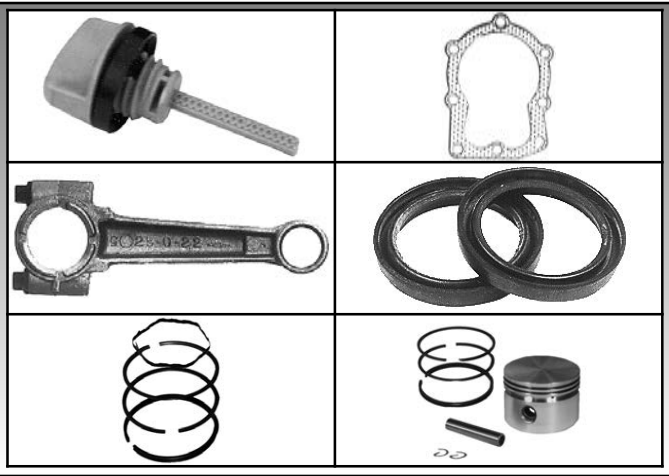
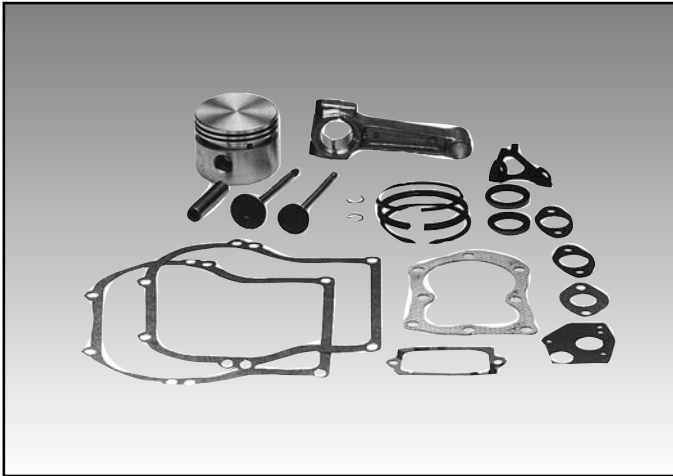

Quick-Glance

INTERNAL ENGINE PARTS	PG.
Small Engine	
Overhaul Kits	555
Oil Seals	556-557
Piston Ring Sets	557-562
Piston Assemblies	563-565
Connecting Rods	566
Valves	567-568
Head Gaskets	569-570
Gasket Sets	571-574
Carburetor Gaskets	575-581
Base Gaskets	582-584
Oil Gauge	584
Oil Drain Plug	585
Oil Plug	585
Oil Drain Valve	585-586
Flywheel Keys	586



INTERNAL ENGINE PARTS APPLICATION



MAKE & MODEL	CYLINDER DIAMETER	PISTON ASSEMBLY	STANDARD RING SET	CONNECTING ROD	VALVE INTAKE	VALVE EXHAUST	GASKET SET	HEAD GASKET	BASE GASKET	OIL SEAL TOP	OIL SEAL BOTTOM	VALVE COVER GASKET
BRIGGS & STRATTON ENGINES												
60100 to 60199 2 H.P. HORIZONTAL	2-3/8"	23-2720	23-1453	—	23-1511	23-1510	23-1469	23-1479	23-1401	23-1442	23-1442	23-2733
80100, 80200, 80300, AND 81200 SERIES. 3 H.P. HORIZONTAL	2-3/8"	23-2720 EXCEPT 81200	23-1453	23-1525	23-1511	23-1510	23-1469	23-1479	23-1401	23-1442	23-1442	23-2733
92500, 92900, 93500 SERIES 3, 3-1/2 H.P. VERTICAL	2-9/16"	23-2721	23-1461	23-1529	23-1511	23-1510	23-1471	23-1482	23-1401	23-1442	23-1441	23-2734
110,000 SERIES 4 H.P. VERTICAL	2-25/32"	—	23-2477	—	23-2816	23-2815	23-2747	23-2732	23-1401	23-1442	23-1441	23-2734
130200 HORIZONTAL SERIES 130900 VERTICAL SERIES 5 H.P.	2-9/16"	23-2721	23-1461	23-2772	23-1509	23-1508	23-1405 (HORIZ.) 23-1470 (VERT.)	23-1480	23-1402 (HORIZ.) 23-1403 (VERT.)	23-1442	23-1448 (HORIZ.) 23-1446 (VERT.)	23-2733
131200 to 131299 131400 to 131499 SERIES 5 H.P. HORIZONTAL	2-9/16"	—	—	23-2772	23-1509	—	23-1405	23-1480	23-1402	23-1442 (131400)	23-1448 (131200 SERIES) 23-2709 SERIES)	23-2733
170700 to 170799, 7 H.P. VERTICAL 190700 to 190799, 8 H.P. VERTICAL	3"	—	23-1463	—	23-2811	23-2810	23-1406	23-1484	23-1404	23-1448	23-1445	23-2735
CLINTON ENGINES												
252700 to 252799 11 H.P. VERTICAL	3-7/16"	—	23-1466	—	—	—	—	23-2761	23-3530	23-1445	23-1447	23-2735
100, V, VS-100, 400 to 409; 411, 415, 424, 426, 494, 800, 900, 1000, 1100, 2100, 3100, 4100 SERIES	2-3/8"	—	23-1453	23-1527	23-1515	23-1514	—	23-1485	—	—	—	—
1200, A, B, V, VS-1200												
KOHLER ENGINES												
SERIES. 497, 498, 499, V-1200 K91 4 H.P. HORIZONTAL	2-15/32" 2-3/8"	— —	23-1455 23-2468	23-1530 —	23-1513 —	23-1512 23-2835	— 23-2742 W/O SEALS	23-1486 23-2752	— —	— —	— —	— —
K161 7 H.P. HORIZONTAL	2-7/8"	—	—	—	—	23-2834	—	23-2763	23-3533	—	—	—
TECUMSEH ENGINES												
K181 8 H.P. HORIZONTAL LAV30 3 H.P. VERTICAL	2-15/16" 2-5/16"	— —	23-2470 23-2469 23-1458	— 23-1528	— 23-1519	23-2834 23-1518	— 23-1474	23-2763 23-1489	23-3533 23-3651	— 23-1444	— 23-2714	— —
LAV35, TVS90 3-1/2 H.P. VERTICAL	2-1/2"	—	23-1456	23-1528	23-1519	23-1518	23-1474 (LAV35 ONLY)	23-1489	23-3651	23-1444	23-2714	—
TNT100, ECV100 4 H.P. VERTICAL	2-5/8"	—	23-1460	23-1528	23-1519	23-1518	23-1474 (ECV100 ONLY)	23-2760 (TNT100 ONLY)	23-3651	23-1444	23-2714	—
V, VM, H, HM80 8 H.P. VERTICAL & HORIZONTAL	3-1/16"	—	23-1534 (BEFORE TYPE E)	—	—	23-1521	23-2745	23-2762 (BEFORE TYPE E)	23-3531	23-2713	—	—
VM100 10 H.P. VERTICAL	3-3/16"	—	—	—	—	23-1521	23-2745	23-2762	23-3531	23-2713	—	—

INTERNAL ENGINE PARTS



Tune Up Kits

BRIGGS & STRATTON 3-1/2 hp

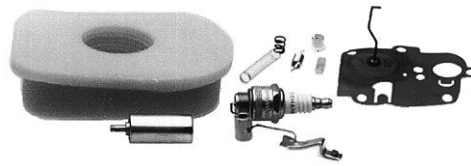

- Order No.** **Contents**
 Replaces
19-1371 B&S 270579 Air Filter
22-1428 B&S 391681 Diaphragm
23-1435 B&S 222698 Fly Wheel Key
24-5936 Champion J19LM Spark Plug
31-1772 B&S 294628 Points and Cond. Assy.

Order No. 23 - 6850
 Fits B&S 3-1/2 hp

BRIGGS & STRATTON 8 hp



- Order No.** **Contents**
 Replaces
19-1373 B&S 270528 Air Filter
22-1420 B&S 396795 Carburetor Kit
22-1419 B&S 394681 Needle Float
23-1435 B&S 222698 Fly Wheel Key
24-5936 Champion J19LM Spark Plug
31-1772 B&S 294628 Points and Cond. Assy.

Order No. 23 - 6852
 Fits B&S 8 hp

LAWN-BOY "D"



- Order No.** **Contents**
 Replaces
19-1379 LawnBoy 607580 Air Filter
22-2950 LawnBoy 681741 Needle and Seat
23-2961 LawnBoy 602850 Bowl Gasket
23-2974 LawnBoy 608362 Reed Plate Gasket
23-3550 LawnBoy 602052 Carburetor Gasket
24-5859 Autolite 458 (Champion CJ14 Spark Plug)

Order No. 23 - 6854
 Fits LB "D" Engines

LAWN-BOY "F"



- Order No.** **Contents**
 Replaces
19-1380 LawnBoy 609493 Air Filter
22-2950 LawnBoy 681741 Needle and Seat
24-5859 Autolite 258 (Champion CJ14 Spark Plug)

Order No. 23 - 6855
 Fits LB "F" Engines

INTERNAL ENGINE PARTS



REPLACEMENT OIL SEALS



BRIGGS & STRATTON

Order No.		Replaces OEM	Position	Application
23 - 1441	MIN010	391483	PTO Side	80000, 92000, 110000, 111000 series, 2 through 5 hp for Vertical Shafts.
23 - 1442	MIN010	299819	Magneto Side	60000, 80000, 92000, 93000, 110000 series 2 through 5 hp.
23 - 1445	MIN010	391086	Magneto Side	251000, 252000, 401000, 402000, 421000, 422000 series 10, 11 & 16 hp.
			PTO Side	170000, 190000 series. 6, 7 & 8 hp.
23 - 1447	MIN010	291675	PTO Side	251000, 252000, 401000, 402000, 421000, 422000 series. 10, 11 & 16 hp.
23 - 1448	MIN010	294606	Magneto Side	170000, 190000 series. 7 & 8 hp.
			PTO Side	100200, 130200 series. 4 & 5 hp.
23 - 2709	MIN010	393812		131700, 132200, 133400, 130400, 131400 series. 5 hp. Horz.
23 - 8825	MIN010	399781		Quantum series 97700, 99700, 12A800, 12D800, 121700-129800, 104700.
23 - 10770	MIN010	495307 555087		80200 - 135200. Fits 3 - 5 hp Horizontal
23 - 12627	MIN010	692550		

23

TECUMSEH

Order No.		Replaces OEM	Position	Application
23 - 1441	MIN010	25492	PTO Side	V17 thru V30 (earlier models).
23 - 1444	MIN010	29183	Magneto Side	LAV30 & 35, H30 & 35, TVS75 & 90, ECV100, TNT100.
23 - 2711	MIN010	32600	Magneto Side	LAV40, HS50, TVS105, LAV50, HS50, TNT120 series 4 & 5 hp Vert. & Horz.
23 - 2712	MIN010	27876B	Magneto Side	V50, H50, V60, H60, VH60, HH60 series. 5 & 6 hp Vertical & Horizontal.
23 - 2713	MIN010	32630	Magneto Side	VM70, 80, 100, HM70, 80, 100 Series. 7, 8 & 10 hp Vertical & Horizontal.
23 - 2715	MIN010	27897	PTO Side	LAV40, HS40, TVS105, LAV50, HS50, TNT120, V50, V60, VH60, V70, VH70 series. 4, 5, 6 & 7 hp Vert. 4 & 5 hp Horz.
23 - 2716	MIN010	28427	PTO Side	H50, H60, HH60, H70, HH70 series. 5, 6 & 7 hp Horz.
23 - 8561	MIN010	31950	PTO Side	VM & HM 70, 80, 100 & H 80.

CLINTON

Order No.		Replaces OEM	Position	Application
23 - 1441	MIN010	94-176-990	PTO Side	900, VS-1100, VS3100, Also 405, 407, 409, 415, 499 Series.

INTERNAL ENGINE



REPLACEMENT OIL SEALS



HONDA

Order No.	Replaces OEM	Position	Application
23 - 11989	91202-883-005		Front & Rear seal, G150-300, GV150-200, GX120-200
23 - 11990	91201-890-003		Front & Rear seal, G300-400, GV400, GX240-340
23 - 11991	91201-ZE3-004		Front & Rear seal, GCV530, GX340-390, GXV340-530

KOHLER

23 - 8421	MIN010	47-032-06	Magneto Side	K241 thru K361, front seal.
23 - 8422	MIN010	47-032-07	PTO Side	K241 thru K361 rear seal, K582, K532 front seal.

LAWN-BOY

23 - 2956	MIN010	611396, 609342, 605020, 602632		"C" Series, "D" Series, "F" Series.
------------------	--------	--------------------------------	--	-------------------------------------

Piston Ring Sets

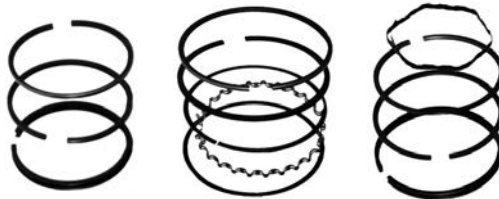

CHROME RINGS

BRIGGS & STRATTON

Order No.	Cylinder Diam.	Replaces OEM	Ring Size	Fits Models
23 - 7213	2.375"	294232	(Std.)	Fits 3 hp horizontal engines. (Chrome rings)
23 - 1531	2-9/16"	299742	(Std.)	90000 series, 130000 Series 3-1/2 & 5 hp Horizontal & Vertical. (Chrome rings) .
23 - 1532	3"	299743	(Std.)	170400, 170700, 171700 series. 190400, 190700 series. 7 & 8 hp Horz & Vert. (Chrome rings) .
23 - 5875	3-7/16"	392331 299745	(Std.) (Std.)	251000 and 252000; 10 & 11 hp engines. 300420, 301430, 302430 series 12 & 13 hp Horizontal. (Chrome rings) .

INTERNAL ENGINE PARTS



Piston Ring Sets

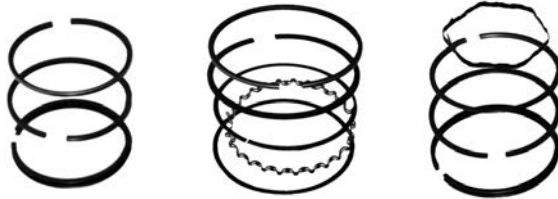

BRIGGS & STRATTON (Cont.)

Order No.	Cylinder Diam.	Replaces OEM	Ring Size	Fits Models
23 - 1461	2-9/16"	298982	Std.	90000 series 3-1/2 hp 130200 to 130999 5 hp Vertical & Horizontal. For our 23-2721 piston assy.
23 - 1452	2-1/2"	298174	Std.	100000 series, 100200, 100900 4 hp . After serial 6306141.
23 - 1466	3.4375"	499996 391780 394665 394959	Std.	220000, 251000, 252000, 253000 series. 10 & 11 hp Horizontal and 11 hp Vertical. For our 23-6725 piston assy.
23 - 1454	2-5/16"	293506 & 295649	Std.	6B, 6BH, 6BHS, 6BHF, 6BS, 60700 series. 61100, 61300, 61400, 61500 series prior to serial 5810060, 61700 series prior to serial 5809290 2 - 2-1/2".
23 - 1462	2-3/4"	295852 & 297815	Std.	146,000 and 147,000 series.
23 - 1463	3"	499921 391669	Std.	170000 series. 190400, 190700, 191700. For our 23-6722 piston assy.
23 - 1453	2-3/8"	294232 & 295657	Std.	60000 - 80000, series 8B. For our 23-2720 piston assy.
23 - 8794	2-11/16"	493261	Std.	12A800, 12D800, 121700-129800 Quantum engines. For our 23-8793 piston assy.
23 - 10754		498680	Std.	9D, 91400, 10B, 10D, 10E series engines. Fits 3.5 & 3.75 hp, newer models with thin rings
23 - 10755		499425	Std.	11A, 11C, 110600 series engines. Fits 5 hp, newer models with thin rings.
23 - 2479	3.010"	690018/391670	+010	8 hp for our 23-6723 piston assy.
23 - 6773	3.4475"	391781	+010	Fits 251000, 252000, 280700 series 10 thru 12 hp . For our 23-6726 piston assy.
23 - 8450	3-9/16"	390486	+010	320420-320428, 325430-325438, 326400-326499. 14-16 hp .
23 - 2475	2.5725"	298983	+010	Fits 3 thru 5 hp engines. For our 23-2722 .
23 - 8795	2-11/16"	493388	+010	12A800, 12D800, 121700-129800 Quantum engines.

INTERNAL ENGINE 23



Piston Ring Sets

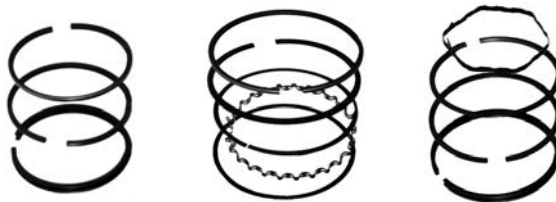

BRIGGS & STRATTON (Cont.)

Order No.	Cylinder Diam.	Replaces OEM	Ring Size	Fits Models
23 - 11322		498681	+010	Fits 3.5, 3.75, 5 HP , thin rings, For 9D, 91400, 10B, 10D, 10E, & 135200 series.
23 - 8827	3-7/16"	391782	+020	220000-222000, 252000-257000, 280000-286000, 40000, 402000-422000. 10-12.5 & 14-18 hp engines. For our 23-8826 .
23 - 2476	2.5825"	298984	+020	Fits 3 thru 5 hp . For our 23-2723 assembly.
23 - 8790	2-11/16"	493389	+020	12A800, 12D800, 121700-129800 Quantum engines. For our 23-8792 .
23 - 8946		391671	+020	Fits 7 and 8 hp series 170,000 - 190,000. For our 23-8947 piston assembly.
23 - 6878		298985	+030	Fits 3-1/2 and 5 hp engines.
23 - 6772	3.030"	391672	+030	Fits 190000, 191700 series 8 hp engines. For our 23-6724 piston assy.
23 - 6774	3.4675"	391783	+030	Fits 251000, 252000, 280700 series 10 thru 12 hp . For our 23-6727 piston.

HONDA

23 - 11283	2.36"	130A1-ZE6-003 13010-ZE6-013	Std.	Fits model GX120 For our 23-11282 piston assy.
23 - 11286	2.50"	13010-ZE1-013 130A1-ZE1-003	Std.	Fits model GX140 For our 23-11285 piston assy.
23 - 11290	2.11/16"	13010-ZF1-023	Std.	Fits model GX160 For our 23-11288 piston assy.
23 - 11302	3-15/32"	13010-ZF6-003	Std.	Fits model GX390 For our 23-11301 piston assy.
23 - 11296	2-7/8"	13010-ZE2-013	Std.	Fits model GX240 For our 23-11293 piston assy.

INTERNAL ENGINE PARTS



Piston Ring Sets

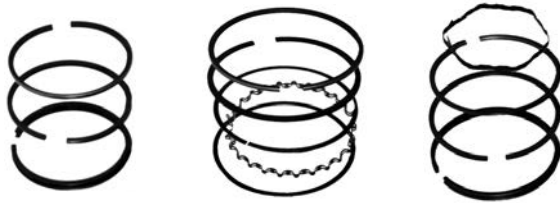

CLINTON

Order No.	Cylinder Diam.	Replaces OEM	Ring Size	Fits Models
23 - 1453	2-3/8"	233-112-500	Std.	100, V, VS-100, 400 to 409; 411, 415, 424, 426, 494, 800, 900, 1000, 1100, 2100, 3100, 4100 series. 3/16" Oil ring.
23 - 1455	2-15/32"	233-113-500	Std.	1200, A, B, V, VS-1200 series, 497, 498, 499, V1200.

23

INTERNAL ENGINE

LAWN-BOY

23 - 1464	2.375"	679252	Std.	Two ring set "D" Engines
23 - 2954	2.380"	681737	Std.	Two ring set "F" Engines



Piston Ring Sets

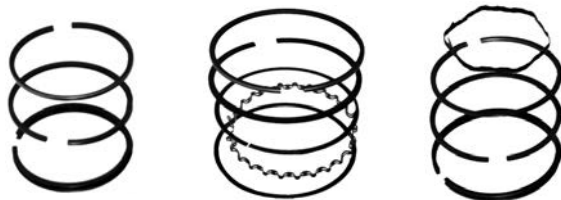

CHROME RINGS

KOHLER

Order No.	Cylinder Diam.	Replaces OEM	Ring Size	Fits Models
23 - 2470	2.9375"	232575	Std.	K181, 8 hp. (Chrome rings)
23 - 2471	3.251"	235287	Std.	K241, K482, 10 hp. (Chrome rings).
23 - 2472	3.375"	48-108-01 235889	Std.	K301, K532 12 hp. (Chrome rings).
23 - 2473	3.500"	48-108-05 236763	Std.	K321, 14 hp. (Chrome rings).
23 - 6794		220801	Std.	Fits model K-91, 4 hp engines. For our 23-6739 piston assy.
23 - 6796	2.9475"	232576	+010	Fits model K-181, 8 hp engines. For our 23-6742 piston assy.
23 - 6799	3.261"	235288	+010	Fits model K-241, 10 hp engines. For our 23-6746 piston assy.
23 - 6802	3.385"	235890 48-108-02	+010	Fits model K-301, 12 hp engines. For our 23-6750 piston assy.
23 - 6805	3.510"	236764 48-108-06	+010	Fits model K-321, 14 hp engines.
23 - 6795		220803	+020	Fits model K-91, 4 hp engines. For our 23-6740 piston assy.
23 - 6797		232577	+020	Fits model K-181, 8 hp engines. For our 23-6743 piston assy.
23 - 6800	3.271"	235289	+020	Fits model K-241, 10 hp engines. For our 23-6747 piston assy.
23 - 6803	3.395"	235891 48-108-03	+020	Fits model K-301, 12 hp engines. For our 23-6751 piston assy.

23

INTERNAL ENGINE

INTERNAL ENGINE PARTS



Piston Ring Sets

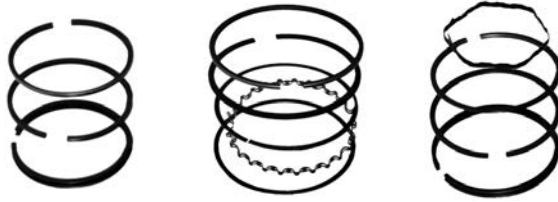

KOHLER (Cont.)

Order No.	Cylinder Diam.	Replaces OEM	Ring Size	Fits Models
23 - 6806	3.520"	236765 48-108-07	+020	Fits model K-321, 14 hp engines. For our 23-6755 piston assy.
23 - 6798	2.9675"	232578	+030	Fits model K-181, 8 hp engines. For our 23-6744 piston assy.
23 - 6801	3.281"	235290	+030	Fits model K-241, 10 hp engines. For our 23-6748 piston assy.
23 - 6804	3.405"	235892 48-108-04	+030	Fits model K-301, 12 hp engines. For our 23-6752 piston assy.
23 - 6807	3.530"	236766 48-108-08	+030	Fits model K-321, 14 hp engines. For our 23-6756 piston assy.

TECUMSEH

23 - 1456	2-1/2"	28986	Std.	LAV-25, LAV-30, V-22, V-25, V-30, VA, VA7, LA, LVC, LV, LAV35, LW, VX32A, V35A, V40A, V45A, ECH90, H35, LV35, TVS90. 2.5, 3, 3.5, 4 & 4.5 hp Vertical. LAV30-35 Spec. 40000 L to 1014M.
23 - 1458	2-5/16"	27565	Std.	H-20, H-22, H25, H-27, H-30, 2, 2.5, 3 & 3.5 hp Horizontal.
23 - 1460	2-5/8"	34854 33315	Std.	V55, V40, V50, V60, H40, H50, H60, H55, ECV100, ECV105, HH50, HH60, HS40, BLAV40, TNT100, TVS105, VH50, VH60, 4, 5, 5.5, 6 hp Vertical and Horizontal. For our 23-6733 and 23-6734 piston assy.
23 - 1459	2-1/2"	27889	Std.	V35B, V40B, V45, H45A, V45A, B. 3.5, 4 & 4.5 hp Vertical. 4.5 hp Horizontal.
23 - 1462	2-3/4"	32595	Std.	V70, H70, ECV110, HH70, VH70. 7 hp Vert. and Horiz. For our 23-6735 piston assy.
23 - 6775	3-1/2"	32241	Std.	Fits models HH120,150, 160, OH160; 12, 15, 16 hp . For our 23-6732 piston assy.
23 - 6777	3-5/16"	32004	Std.	Fits models HH140, OH140, VH100 10 & 14 hp . For our 23-6736 piston assy.



Piston Assemblies

Includes Piston, Piston Rings, Wrist Pin and Wrist Pin Keeper



BRIGGS & STRATTON

Order No.	Replaces OEM	Ring Size	Fits Models
23 - 2720	295587	Std.	3 hp Horizontal. Includes our 23-1453 ring set.
23 - 2721	298904	Std.	3-1/2 hp Vert. & 5 hp Horz. Includes our 23-1461 ring set.
23 - 6722	499907/391673	Std.	8 hp models 190000, 191700 series. Includes our 23-1463 rings.
23 - 6725	499956/499282 391285 394661 394955 393271/394955	Std.	10 - 12 hp , 251000, 252000, 280700 series. * 10 hp model 222416 * 11 hp model 252412, 11 hp IC model 253702, 255427, 14 hp IC model 400437, 400407, 16 hp IC model 402417, 18 hp IC model 421700, 422700. Includes our 23-1466 rings. (*cast iron block)
23 - 8793	493262	Std.	12A800, 12D800, 121700-129800 Quantum engines. Includes our 23-8794 rings.
23 - 2722	298905	+0.010	3-1/2 hp Vert. & 5 hp Horz. Includes our 23-2475 rings.
23 - 6720	391651	+0.010	4 hp models 110900, 111200, 111900 series. Includes our 23-6770 rings.
23 - 6723	391674	+0.010	8 hp models 190000, 191700 series. Includes our 23-2479 rings.
23 - 6726	391287 499957	+0.010	10 thru 12 hp models 251000, 252000, 280700 series. Includes our 23-6773 rings.(*cast iron cylinder)
23 - 8452	390365	+0.010	14-16 hp models 320420-320428, 325430-325438, 326400-326499. Includes our 23-8450 rings.
23 - 2723	298906	+0.020	3-1/2 hp Vert. & 5 hp Horz. Includes our 23-2476 rings.
23 - 6721	391652	+0.020	4 hp models 110900, 111200, 111900 series. Includes our 23-6771 rings.
23 - 8947	391675	+0.020	Fits 7 & 8 hp series 170000-190000. Includes our 23-8946 rings.
23 - 8826	499958/499290 391288 394663/394957	+0.020	10-12.5 hp & 14-18 hp models 22000-222000, 252000- 257000, 280000-286000, 40000, 402000-422000. Includes our 23-8827 rings.
23 - 8792	493386	+0.020	12A800, 12D800, 121700-129800 Quantum engines. Includes our 23-8790 rings. Includes our 23-6772 rings.
23 - 6727	391289	+0.030	10 thru 12 hp models 251000, 252000, 280700 series. Includes our 23-6774 rings. (*cast iron cylinder)

INTERNAL ENGINE PARTS



Piston Assemblies

Includes Piston, Piston Rings, Wrist Pin and Wrist Pin Keeper



HONDA

Order No.	Replaces OEM	Ring Size	Fits Models
23 - 11282	13101-ZE0-000 13101-ZH7-010	Std.	Fits model GX120. Includes our 23-11283 rings.
23 - 11285	13101-ZE1-010	Std.	Fits model GX140. Includes our 23-11286 rings.
23 - 11288	13101-ZH8-010	Std.	Fits model GX160. Includes our 23-11290 rings.
23 - 11298	13101-ZE3-000 13101-ZH3-W00	Std.	Fits model GX340. Includes our 23-11299 rings.
23 - 11301	13101-ZF6-W00	Std.	Fits model GX390. Includes our 23-11302 rings.
23 - 11293	13101-ZE2-010	Std.	Fits model GX240. Includes our 23-11296 rings.

KOHLER

23 - 6741	41-874-05	Std.	8 hp model K-181. Includes our 23-2470 rings.
23 - 6739	46-874-01	Std.	4 hp model K-91. Includes our 23-6794 rings.
23 - 6749	47-874-06	Std.	12 hp model K-301. Includes our 23-2472 rings.
23 - 6745	47-874-01	Std.	10 hp model K-241. Includes our 23-2471 rings.
23 - 6753	47-874-11	Std.	14 hp model K-321. Includes our 23-2473 rings.
23 - 6742	41-874-07	+010	8 hp model K-181. Includes our 23-6796 rings.
23 - 6746	47-874-03	+010	10 hp model K-241. Includes our 23-6799 rings.
23 - 6750	47-874-08	+010	12 hp model K-301. Includes our 23-6802 rings.
23 - 6740	46-874-04	+020	4 hp model K-91. Includes our 23-6795 rings.
23 - 6743	41-874-08	+020	8 hp model K-181. Includes our 23-6797 rings.
23 - 6747	47-874-04	+020	10 hp model K-241. Includes our 23-6800 rings.
23 - 6751	47-874-09	+020	12 hp model K-301. Includes our 23-6803 rings.
23 - 6755	47-874-14	+020	14 hp model K-321. Includes our 23-6806 rings.
23 - 6744	41-874-09	+030	8 hp model K-181. Includes our 23-6798 rings.
23 - 6748	47-874-05	+030	10 hp model K-241. Includes our 23-6801 rings.
23 - 6756	47-874-15	+030	14 hp model K-321. Includes our 23-6807 rings.



Piston Assemblies

Includes Piston, Piston Rings, Wrist Pin and Wrist Pin Keeper



LAWN-BOY

Order No.	Replaces OEM	Ring Size	Fits Models
23 - 2749	92-4923 682986	Std. Std.	Standard F - Engine piston and ring set.

TECUMSEH

Order No.	Replaces OEM	Ring Size	Fits Models
23 - 6734	34503, 31797B	Std.	6 hp models VH60 and HH60. (cast iron). Includes our 23-1460 rings.
23 - 6736	34508, 32001C	Std.	10 & 14 hp models HH140, OH140, VH100. Includes our 23-6777 rings.
23 - 6732	34511, 32238B	Std.	12, 15, 16 hp models HH120, 150, 160, OH160. Includes our 23-6775 rings.

23
INTERNAL ENGINE

INTERNAL ENGINE PARTS



Connecting Rods



BRIGGS & STRATTON

Order No.	Replaces OEM	Fits Models
23 - 1529	294201 294367	3 hp horizontal, 80000 series. 3-1/2 hp, 90000 series.
23 - 2770	390401	8 hp, 190400, 195400 & 294201 series. (with oil slinger) Identical to 390402 w/o oil slinger. Also fits 190700 series horz. and vert.
23 - 2772	299430	5 hp, 130200, 131200, 131400 series. (with oil slinger) Horizontal & vertical. Identical to 299429 w/o slinger.
23 - 6757	490566	4 hp, 110000, 111000, 113000, 114000 series.
23 - 6758	490348	10-12 hp horizontal & vertical 251000, 251400, 251700, 252000, 252400, 252700, 253400, 253700, 280700, 281700, 282700, 283700, 286700, 289700, 28A700, 28B700, 28C700, 28D700, 28M700 series.

HONDA

Order No.	Replaces OEM	Fits Models
23 - 9832	13200-ZE0-000	GX110/GX120.
23 - 9833	13200-ZE1-000	GX140/GX160.
23 - 9834	13200-ZE2-000	GX240.
23 - 9837	13200-ZE3-010 13200-ZE3-000	GX390, GX340

KOHLER

Order No.	Replaces OEM	Fits Models
23 - 6761	41-067-10 (std.)	K181, 8 hp.
23 - 6763	47-067-13 (std.)	K241, 10 hp.
23 - 6765	47-067-09 (std.)	K301 and K321, 12, 14 hp.

TECUMSEH

Order No.	Replaces OEM	Fits Models
23 - 1528	30963B	2, 2.5 & 3 hp horz.; 2, 2.5, 3.5, 4 & 4.5 hp vert. SLV, SLV50, V-17, V-20, H-22, H-25, H-27, H-30, LAV-30, LAV-25, V-30, VA, VA-7, LA, LVC, LV, LAV35, LW, VX32A, V35A, V40A, V45A.
23 - 6767	32875	TNT120, LAV40, HS40, HS50, TVS105, 120.
23 - 6768	31380C VH60, HH60.	V60, H60, TVM140 (Spec 70000K-390L, 100000E-20E),
23 - 6769	32591C	V70, 80, H70, 80, VM70, 80, VM100.

INTERNAL ENGINE 23



Valves



BRIGGS & STRATTON

Order No.	Replaces OEM	Type	Fits Models
23 - 1508	211119	Exhaust	100200, 100999, 130200, 130900 series.
23 - 1509	261044	Intake	4 & 5 hp horizontal and vertical 131900 series.
23 - 9877	494191/260860	Exhaust	5 hp engines and 131200, 131400, 131700 series.
23 - 1510	296676	Exhaust	60000, 80000, 90000, 10A900, 10A902 series.
23 - 1511	296677	Intake	2, 3, 3.5 hp horizontal.
23 - 2811	261055	Intake	7 & 8 hp horizontal & vertical 191700 series.
23 - 2815	212004	Exhaust	4 hp vertical 110000 series.
23 - 2816	261233	Intake	4 hp vertical 110000 series.
23 - 8049	691794, 390420	Exhaust	16 and 18 hp 402400 thru 422700.
23 - 9880	691804, 261528	Intake	16 and 18 hp 402400 thru 722700.
23 - 8050	394434	Intake	9 hp cast iron series 23400 thru 243499 before 1981.
23 - 9876	261184	Intake	10 hp 251000.
23 - 8562	261462, 690429	Intake	10 thru 11 hp 220400 thru 257700.
23 - 9879	262247	Intake	10 thru 13 hp 28A700-280700, 281700, 283700, 284700, 285700, 286700, 289700.
23 - 9878	262246	Exhaust	10 thru 13 hp 28A700-280700, 281700, 283700, 284700, 285700, 286700, 289700.
23 - 8821	262651	Exhaust	For Quantum models 121700, 121800, 122700, 123700, 123800, 124700, 124800, 125700, 126700 & 126800
23 - 8822	262652	Intake	Fits Quantum models 121700, 121800, 122700, 123700, 123800, 124700, 124800, 125700, 126700 & 126800

23

INTERNAL ENGINE

HONDA

23 - 9820	14711-ZE0-010	Intake	GX110.
23 - 9821	14721-ZE0-010	Exhaust	GX110.
23 - 9822	14711-ZF0-000	Intake	GX120.
23 - 9826	14711-ZF1-000	Intake	GX160.
23 - 9827	14721-ZF1-000	Exhaust	GX160.

INTERNAL ENGINE PARTS



Valves



HONDA (Cont.)

Order No.	Replaces OEM	Type	Fits Models
23 - 9829	14721-ZE2-000	Exhaust	GX240 & GX270.
23 - 9830	14711-ZE3-000	Intake	GX340.
23 - 9831	14721-ZE3-000	Exhaust	GX340.

KOHLER

23 - 2830	235008	Intake	model K241 (10 hp), K301 (12 hp), 20 & 23 hp.
23 - 2833	235826	Exhaust	model K241, K301 (12 hp), 10 hp.
23 - 2834	230710	Exhaust	model K141 (6 hp), K161 (7 hp), K181 (8 hp).
23 - 2837	5201601	Exhaust	model KT17, KT 19.
23 - 8474	235582	Intake	K241, K301, K321, K332, K582.
23 - 8473	237672	Exhaust	K321, K341, K532, K582, M14, M16.
23 - 8475	235838	Exhaust	K241, K301, K321 up to D series, M10-12.

TECUMSEH

23 - 1518	29313C	Exhaust	V27, V30, V32, H30, H35, LAV22 thru 35 series.
23 - 1519	29314B	Intake	3, 3.5, 4 hp Vert. & 3, 3.5 hp Horz. LAV40



INTERNAL ENGINE PARTS

Head Gaskets

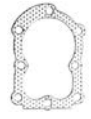

23-1479

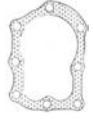

23-1482



23-1484



23-13510



23-2761



23-8242



23-8413

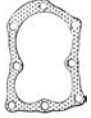

23-1480



23-13525



23-2732



23-11077



23-2753



23-8243



23-8834

BRIGGS & STRATTON

Order No.		Replaces OEM	Fits Models
23 - 1479	MIN010	272167 27670	6B, 6BH, 6BHS, 6BHF, 6BS, 60100 to 61909, 61100, 61300, 61400, 61500 series prior to Serial 5810060, 61700 series prior to Serial 5809290, 60100, 60300, 60400, 60500 series after Serial 5810030; 60700 series after Serial 5809080; 8B, 80000 series, 80100 to 80800, 80900 to 80997, 81100 to 81800, 81900 to 82997. 2 & 3 hp horizontal.
(metal).			
23 - 1480	MIN010	272157 270383	1963-65, 100,000 series; 100200, 100900-3/32" Comp. 130200 & 130999, 31200 to 131400 & 131900 series 5 hp horizontal & vertical. (metal) .
23 - 1482	MIN010	272536 272170 270341	90000 series 3-1/2 hp. (metal) .
23 - 1484	MIN010	272163 270430	170000 series, 190700-8, 191700-8, 171000, 190400, 190700, 195400 Series. 7 & 8 hp horz. (metal) .
23 - 2732	MIN010	272171 270836	110,000 series 4 hp vertical. (metal) .
23 - 2761	MIN010	271866 271075	251400, 251700, 252400, 252700 11 hp horizontal.
23 - 2753	MIN010	272165 270273	Model 252700, 10 hp.
23 - 8242		271867	400400-422799 series. (For cylinder head #1)
23 - 8243		271868	400400-422799 series. (For cylinder head #2)
23 - 8413	MIN010	272200	12A800 only type 0100, 0413, 0414, 0508, 0511-0514, model 12D800 only type 0100, 0508 & 0512 series 121700-799, 121800-899, 122700-799, 122800-899. 3-1/2 & 4 hp vertical Also fits 5 hp Quantum.
23 - 8834	MIN010	272166	16 HP vertical engine series 326400.
23 - 11077		273280S	For 13,14,15 hp (25CID) 15.5 intek OHV vertical engines.
23 - 13525	MIN010	698210 692554 273489	Fits 12D & 121000 series OHV Engines, graphite reinforced.
23 - 13510	MIN010	692249 272916	Fits 12CID series engines, graphite reinforced.

23

INTERNAL ENGINE

INTERNAL ENGINE PARTS



Head Gaskets



23-9785



23-9786



23-9839

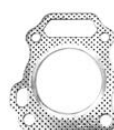

23-9838



23-13514



23-13515



23-13516



23-14146

HONDA

Order No.	Replaces OEM	Fits Models
23 - 9785	12251-ZF1-800	GX160. 5.5 hp horz. (metal)
23 - 9786	12251-ZE3-800	GX340. 11 hp horz. (metal)
23 - 9839	12251-ZE0-800	GX110 & GX120. (metal)
23 - 9838	12251-ZF2-800	GX240. (metal)
23 - 13514	12251-ZF6-W00	GX390. 13 HP engines.
23 - 13515	12251-ZF7-000	GXV160. 5.5 HP engines.
23 - 13516	12251-ZF7-800	GVX120. 4 HP engines.
23 - 14146	12251-ZE6-000	GVX120.

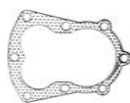

23-1491

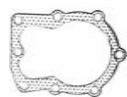

23-2760



23-2762

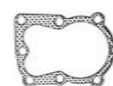

23-1489



23-13522

TECUMSEH

23 - 1491	MIN010	28938C	V35, V40, V50, V60, H40, H50, H60, H55. V & VH40-60, H & HH40-60, 3.5, 4, 5, 6 hp vertical. 5, 5.5, 6 hp horz. (metal)
23 - 2760	MIN010	36443, 33554A, 33015A	LAV 40, 50, TVS 105, TNT 100, TNT 120. (metal)
23 - 2762	MIN010	34041B, 34041A, 33270	VM 70-80, V-80, H80, HM70-80. 7 & 8 hp horz. & vert. (metal)
23 - 1489	MIN010	29953C	LAV Series exc. A, B, C, D, H22, H35, TVS75. 3.5, 4, 5 hp vert. (metal) .
23 - 13522	MIN010	32643A	TVS100, TVS105, TVS120.

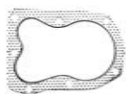

23-2763



23-2764



23-2750

KOHLER

23 - 2763	MIN010	41-041-05 41-041-10	K41, K161, K181. 6, 7 & 8 hp. (graphite)
23 - 2764	MIN010	237658 47-041-10 47-041-15	K241, K301, K321. 10, 12 & 14 hp. (graphite)
23 - 2750	MIN010	45-041-17 45-052-01 45-041-16	Model 341 Cast Iron, 16 hp. Gravely 34775



23-2759

LAWN-BOY

23 - 2759	MIN010	604116	"C" & "D" series.
------------------	--------	--------	-------------------

INTERNAL ENGINE 23



INTERNAL ENGINE PARTS

Gasket Sets

BRIGGS & STRATTON

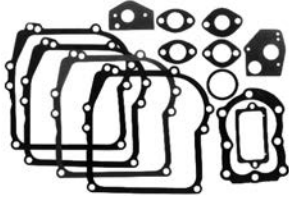

2 & 3 hp

Order No. 23 - 1469

Replaces B&S 495602, 397144 & 297275. Fits models 61100, 300, 400, 500 series prior to Serial 58100060. 61700 series prior to Serial 5809290. 60100, 300, 400, 500, series after Serial 5810030. 60700 series after Serial 5809080. 8B, 80000 series aluminum cylinder 2 & 3 hp horizontal.

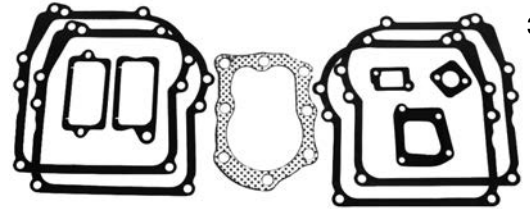

3.5 hp

Order No. 23 - 1471

Replaces B&S 298989. Fits models 90000, through 95500 series. 3.5 hp vertical.

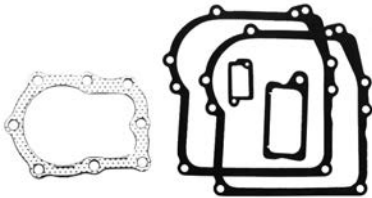

4 hp

Order No. 23 - 2747

Replaces B&S 391662. Fits models 110900, 111900 series. 4 hp vertical.

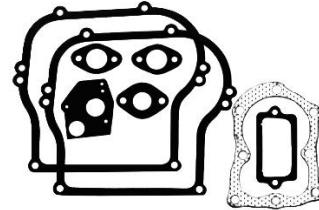

4 & 5 hp

Order No. 23 - 1405

Replaces B&S 495603, 397145 & 297615. Fits models 100200, 130200, 131200, 4 and 5 hp horizontal.

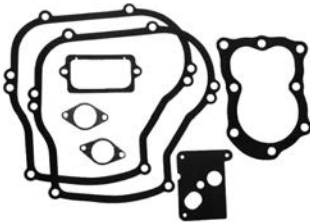

4 & 5 hp

Order No. 23 - 1470

Replaces B&S 496659, 297616. Fits models 100900-3/32" Comp. 130900 to 131999. 4 and 5 hp vertical.

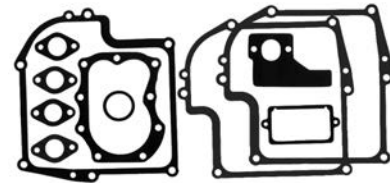

7 & 8 hp

Order No. 23 - 1406

Replaces B&S 299577. Fits models 170000, 17100, 190400, 190700, 190700-8, 191700-8, 195400 series 7 & 8 hp vertical and horizontal.

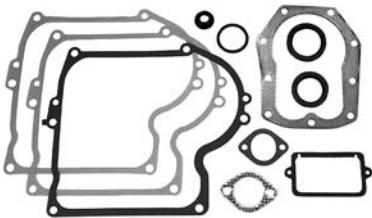

10 & 11 hp

Order No. 23 - 8951

Gasket set replaces B&S 393411. Fits 220700, 251700, 252700, 253700, 254700, 255700, 256700, 257700. Series 10 & 11 hp vertical engines.

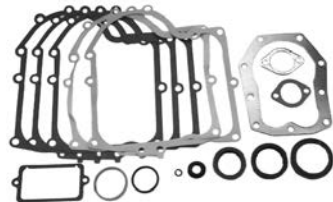

12, 12.5 hp

Order No. 23 - 9261

Gasket set replaces B&S 494241. Fits B&S 12 & 12.5 hp vertical engines.

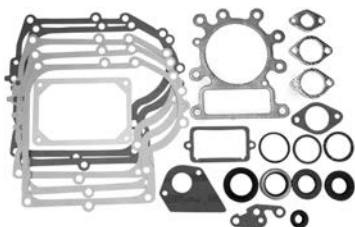

Order No. 23 - 13210

Gasket set replaces B&S 495993. Includes oil seals. Fits 28N & 287000 series engines.



Order No. 23 - 13513

Gasket set replaces B&S 492653, 391834. Fits 10 & 11 hp horizontal engine models 220400, 221400, 251400 & 252400. Includes oil seals.

INTERNAL ENGINE PARTS



Gasket Sets

Gasket Set for
Briggs & Stratton

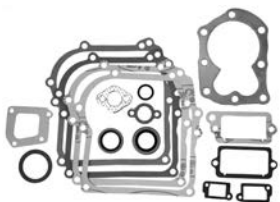

Order No. 23 - 13526

Gasket set replaces B&S 794209, 298989, 699933 gasket set with seals, for 3-3-1/2 hp vertical engines.



Order No. 23 - 13290

Gasket set replaces B&S 496117, 493263. Fits models 121700, 121800, 122700, 123700, 123800, 124700, 124800, 126700, 126800, 129700 Quantum 12CID vertical engines. Includes oil seals. MIN010

Gasket Set with Seals for
BRIGGS & STRATTON

Order No. 23 - 14548

Gasket set with seals replaces B&S 495603. Fits 5 hp horizontal flathead engines.

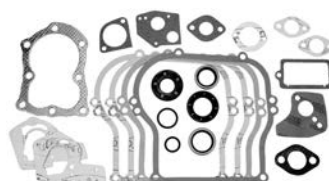

HONDA

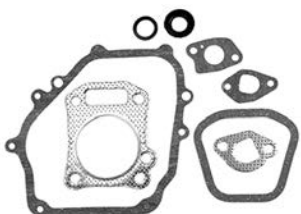

Order No. 23 - 9731

Gasket set replaces Honda 06111-ZH7-405. Fits model GX120.

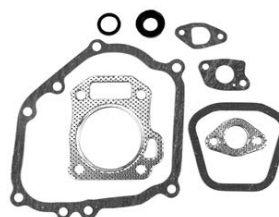

Order No. 23 - 9843

Gasket set replaces Honda 061A1-ZE1-010. Fits model GX140.

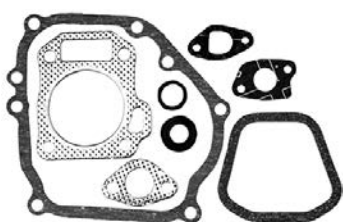

Order No. 23 - 9842

Gasket set replaces Honda 061A1-ZE0-000. Fits model GX110.



Order No. 23 - 12593

Gasket set replaces Honda 06111-ZE6-405. Fits models GXV120. Code 5296264

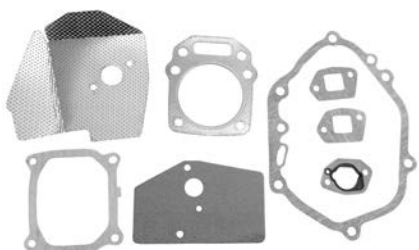

Order No. 23 - 12314

Gasket set replaces Honda 06111-ZE7-406 & 061A1-ZE7-801. Fits model GXV 160.



Order No. 23 - 9784

Gasket set replaces Honda 06111-ZE3-405. Fits model GX340, 11 hp.

INTERNAL ENGINE 23



Gasket Sets

HONDA

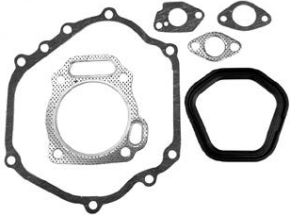

Order No. 23 - 9732

Gasket set replaces Honda 06111-ZF6-406. Fits model GX390.

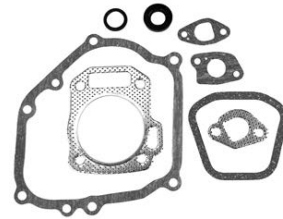

Order No. 23 - 9782

Gasket set replaces Honda 06111-ZH8-405. Fits model GX160K1, 5.5 hp.

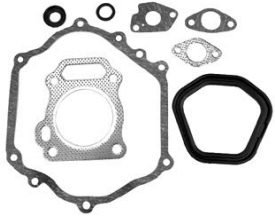

Order No. 23 - 9783

Gasket set replaces Honda 06111-ZE2-405. Fits model GX240K1, 8 hp.

KOHLER

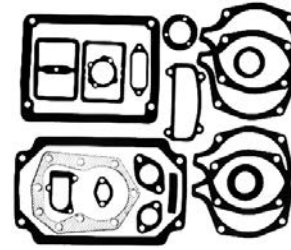

10, 12, 14 hp

Order No. 23 - 2754

Replaces Kohler 47-755-08, 47-004-01. Fits models K241, 301, 321. 10, 12, 14 hp. Over Haul Kit.

KOHLER

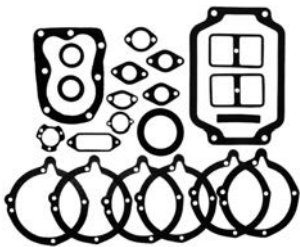

6, 7, 8 hp

Order No. 23 - 2755

Replaces Kohler 41-755-06. Fits models K141, 161, 181. 6, 7, 8 hp. Includes seals.

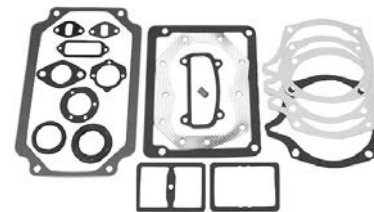

16 hp

Order No. 23 - 9381

Gasket set replaces Kohler 45-755-04. Fits models K341, 16 hp engines. Single cylinder engines. Includes oil seals.



Order No. 23 - 13211

Gasket set replaces Kohler 25 755 37S, 52 755 93-S, 52 755 93, 52 755 93S. For 17, 19 and 21 hp engines. Fits models KT17, KT19, KT21 series engines. Includes (2) oil seals.

LAWN-BOY

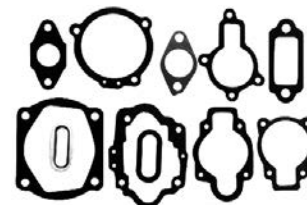

Order No. 23 - 2758

Replaces Lawn-Boy 678071. Fits models "C" & "D" Engines.

INTERNAL ENGINE PARTS



Gasket Sets

**Gasket Set for
TECUMSEH**

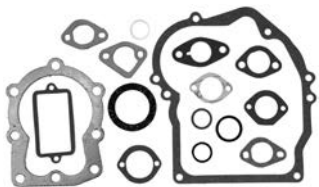

Order No. 23 - 13521

Gasket set replaces Tecumseh 33740F. Fits TVS120. Includes oil seals.

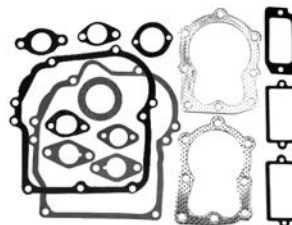

3.5, 4 &
5 hp

Order No. 23 - 1474

Replaces Tecumseh 33238D. Fits models LAV series except A, B, C, D. TVS 75, 90, 105-EVC100LAV40, LAV30-50, H30-35, HS40-50, TNT100-120. 3.5, 4, 5 hp vertical.

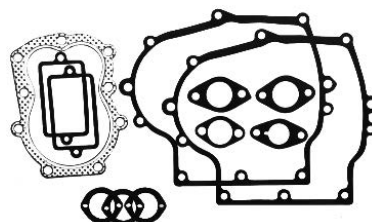

8 hp

Order No. 23 - 2745

Replaces Tecumseh 33279J, 33279G. Fits models VM70, HM70, V80, H80, VM80, HM80. 8 hp horizontal and vertical.

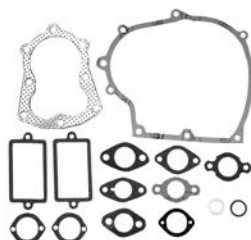

5, 6 & 7 hp

Order No. 23 - 2757

Replaces Tecumseh 33234B & 33234A. Fits models VH-50, 60, 70, VH60-70, HH60-70. 5, 6, 7 hp.

Gasket chart for B&S

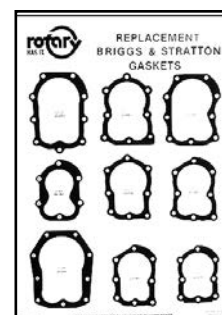
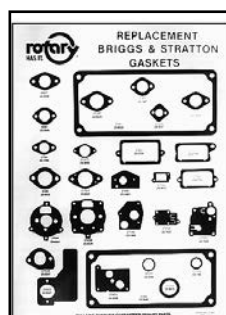

Order No. 32 - 6621

Use these charts to quickly identify and organize your gaskets. All replacement gaskets for Briggs & Stratton that are cataloged by us are shown on these charts in actual size. (set of 3). Chart size 18" x 24".



INTERNAL ENGINE PARTS

Carburetor Gaskets



23-3673 23-7945 23-7946 23-8226 23-8746 23-13224 23-13137

BRIGGS & STRATTON
Air Cleaner Mounting Gasket

Order No.		Replaces OEM	Fits Models
23 - 3673	MIN010	271139	Air Cleaner Mounting Gasket.
23 - 7945	MIN010	271077	Air Cleaner Gasket. Fits 3 thru 5 hp models.
23 - 7946	MIN010	271411	Air Cleaner Gasket. 401400 - 422999.
23 - 8226	MIN010	272296	Air Cleaner Gasket. 2-5 hp engines using flat paper air filters contained in a plastic filter box.
23 - 8746	MIN010	272653	Air Cleaner Gasket. 133700-133799, 135700-135799, 127700-127799, 127800-127899, 129800-129899
23 - 13224	MIN010	691894	Air Cleaner Gasket. Fits 12CID OHV.
23 - 13137	MIN010	692667	Air Cleaner Gasket. Fits 12CID single cylinder OHV.



23-6521 23-6526 23-6531 23-3545 23-3546 23-3547 23-7942 23-7943 23-7944 23-8414

Carburetor Body Gasket

Order No.		Replaces OEM	Fits Models
23 - 6521	MIN010	27034 301000, 325000.	Carburetor Body Gasket. 142000 thru 147000, 252000,
23 - 6526	MIN010	270268, 692215	Carburetor Body Gasket. 220000 thru 251000.
23 - 6531	MIN010	271412, 692278	Carburetor Mounting Gasket. 401400 thru 422999.
23 - 3545	MIN010	68987	Carburetor Mounting Gasket. 60000, 80000, 140000 series. 2, 2.5, 3 hp horz. 6 hp.
23 - 3546	MIN010	65647	Carburetor Mounting Gasket. 142000, 143000, 170400, 191400 series. 6, 7 & 8 hp horz.
23 - 3547	MIN010	692915 270538	Carburetor Mounting Gasket. 140000, 170700, 190700, 191700 series. 6, 7 & 8 hp vertical.
23 - 7942	MIN010	27917	Carburetor Body Gasket. 60300 - 81400 & 140000 - 145000 series.
23 - 7943	MIN010	27918	Carburetor Body Gasket. 5, 7, 8 hp horiz. shaft bowl carb. Fits models series 142000, 147000, 170000, 190000, 191000, 200000.
23 - 7944	MIN010	273186, 271607	Carburetor Body Gasket. 401400 - 422999 series.
23 - 8414	MIN010	498869, 272554	Carburetor Mounting Gasket. 10 thru 12.5 hp.



23-158



23-3548

Intake Gasket

Order No.		Replaces OEM	Fits Models
02 - 158	MIN010	270344 3 & 4 hp vert.	Seal Intake Tube. 92500, 92900, 110000, 111900 series.
23 - 3548	MIN010	280393, 270074	Seal Intake Tube. 100900, 130900 series. 4 & 5 hp vert.

INTERNAL ENGINE PARTS



Carburetor Gaskets

BRIGGS & STRATTON (Cont.)



Sump Cover Gasket

23-6971

Order No.		Replaces OEM	Fits Models
23 - 6971	MIN010	270328, 691868	Sump Cover Gasket. 92500, 92900, 3-1/2 hp.



23-1478



23-1497



23-1498



23-3543



23-3672



23-6523



23-6525



23-7965

Intake Elbow Gasket

Order No.		Replaces OEM	Fits Models
23 - 1478	MIN010	27828	Intake Elbow Gasket. 14000 series, 170400 to 170499, 190400 to 190499 series.
23 - 1497	MIN010	27909	Intake Elbow Gasket. 60000 & 80000 series. 2, 2.5 & 3 hp.
23 - 1498	MIN010	27355	Intake Elbow Gasket. 3, 4, 5 hp horizontal. All models.
23 - 3543	MIN010	270070	Intake Elbow Gasket. 100900, 130900 series. 4 & 5 hp vert.
23 - 3672	MIN010	270345	Intake Elbow Gasket. 92000 series.
23 - 6523	MIN010	27381	Intake Elbow Gasket. 300400, 301400, 325400, 326400.
23 - 6525	MIN010	270267, 692214	Intake Elbow Gasket. 243430 thru 243475.
23 - 7965	MIN010	270684	Intake Elbow Gasket. 170000, 171000, 190000, 191700 & 195400 series.



23-1493



23-1494



23-3537



23-3538



23-7941



23-7963

Tank Mounting Gasket

Order No.		Replaces OEM	Fits Models
23 - 1493	MIN010	27404	Tank Mounting Gasket. 60000 & 80000 series.
		3, 2.5 & 3 hp horz.	
23 - 1494	MIN010	272409 271592	Tank Mounting Gasket. 60200, 60900, 80200, 80800, 84902, 85902, 100200, 100299; 130200 to 130299; 131200 to 131299; 111200 to 111299.
23 - 3537	MIN010	270250	Tank Mounting Gasket. 82500, 92500 series. 3 & 3.5 hp vert.
23 - 3538	MIN010	270073	Tank Mounting Gasket. 100900, 130900. 4 & 5 hp vert.
23 - 7941	MIN010	272489 692241	Tank Mounting Gasket. 130200, 132400. (Older & Newer)
23 - 7963	MIN010	272996, 272410	Tank Mounting Gasket. 80200, 81200, 82200, 100200, 111200, 112200, 130200, 131200, 132200.

INTERNAL ENGINE 23



Carburetor Gaskets

B&S (Cont.)



23-7173



23-7421



23-8229

Intake Gasket

Order No.	Replaces OEM	Fits Models
23 - 7173	MIN010 272199	Intake Gasket. Fits Quantum Engines.
23 - 7421	MIN010 270884	Intake Manifold Gasket. Fits 18 hp v-twin engines. 400400, 400499, 401400-401499, 402400-402499, 401700-401799, 402700-402799.
23 - 8229	MIN010 270844	Intake Gasket. 110000, 111000, 4 hp vert. series.



23-7964



23-7966

Intake Port Gasket

Order No.	Replaces OEM	Fits Models
23 - 7964	MIN010 394732	Intake Port Gasket. 80200, 81200, 82200, 100200, 11200, 130200, 131200 & 132200 series.
23 - 7966	MIN010 273113, 272585	Intake Port Gasket. 80200, 81200, 822000, 100200, 111200, 112200, 130200, 131200 & 132200 series.



23-7781



23-1503



23-11123



23-12043

Carburetor/Fuel Bowl Gasket

Order No.	Replaces OEM	Fits Models
23 - 7781	MIN010 270511	Carburetor Bowl Gasket. Fits 8 thru 12 hp vertical.
20 - 1503	MIN010 68477, 692190	Fuel Bowl Gasket. For our 20-1348.
23 - 11123	MIN010 693981	Carburetor Bowl Gasket. Used in our 22-10237 carburetor kit.
23 - 12043	MIN010 281165S	Carburetor Bowl Gasket. For larger carburetor bowls.



23-7939

Choke Link Gasket

Order No.	Replaces OEM	Fits Models
23 - 7939	MIN010 270571	Choke Link Gasket. 80200, 80300, 81200, 81300, 92500, 92900, 93500, 94500 & 95500, 3-4 hp vertical engines.



23-7211



23-8797

Exhaust Gasket

Order No.	Replaces OEM	Fits Models
23 - 7211	MIN010 692237, 272309	Exhaust Gasket. 100700, 193700, 220700, 3-1/2 & 5 hp with 3/4" opening.
23 - 8797	MIN010 272293	Exhaust Gasket. Fits 10 & 12.5 hp. 280000, 281000.

INTERNAL ENGINE PARTS



Carburetor Gaskets



23-7234



23-10483



23-10480



23-10481



23-10482



23-13517



23-13519



23-13518



23-13520

HONDA

Order No.		Replaces OEM	Fits Models
23 - 7234		16010-883-015	Carburetor Gasket Kit. G-15, G-200, G-300 and G-400.
23 - 10483	MIN010	16228-ZL8-000	Carburetor Gasket . GCV135 and GCV160.
23 - 10480	MIN010	18381-ZL8-305	Exhaust Gasket . GCV135 and GCV165.
23 - 10481	MIN010	16212-ZL8-000	Intake Insulator Gasket . GCV135 and GCV160.
23 - 10482	MIN010	16221-883-800	Intake Carburetor Gasket . GCV135 and GCV160.
23 - 13517	MIN010	18333-ZK6-Y00	Exhaust Gasket . GX240, GX340, GX390.
23 - 13519	MIN010	18381-ZE6-820	Exhaust Gasket . GXV120/GXV160.
23 - 13518	MIN010	18381-ZE2-W10	Exhaust Gasket . GX240, GX270, GX340, GX390. 3-bolt
23 - 13520	MIN010	18381-ZH8-800	Exhaust Gasket . GX160, 5.5 HP engine.

HONDA

Carburetor Bowl Gasket



23-13250



23-13549

Order No.		Replaces OEM	Fits Models
23 - 13250	MIN005		Fits GX110/120/140/160. Included in our 22-10479 assembly.
23 - 13549	MIN010	16010-ZE2-812	Fits GX240,GX270, GX340, GX390, GXV270, GXV340, GXV390. Included in our 22-10866 assembly.

TECUMSEH

Exhaust Gasket



23-2743



23-3553



23-7801

Order No.		Replaces OEM	Fits Models
23 - 2743	MIN010	30081A	Exhaust Gasket. LAV-30, LAV-35, Toro engines.
23 - 3553	MIN010	35865 27930A	Exhaust Gasket. V35-80, VM70-100, R40-80, HM70-100 series. 3.5 thru 10 hp vertical. 4 thru 10 hp horizontal.
23 - 7801	MIN010	33670A	Exhaust Gasket. LAV-50 & HS-50, 5 hp vert. & horz.



23-3539



23-3540



23-3541

Carburetor Bowl Gasket

Order No.		Replaces OEM	Fits Models
23 - 3539	MIN010	631028	Carburetor Bowl Gasket. For Tecumseh carb. (Heavy)
23 - 3540	MIN010	27109	Carburetor Bowl Gasket. For large Carter and Walbro carb.
23 - 3541	MIN010	30356	Carburetor Bowl Gasket. For Walbro carburetors. (Small)

INTERNAL ENGINE 23



Carburetor Gaskets

TECUMSEH (Cont.)



23-1522



23-3551



23-3554



23-3555



23-7798

Carburetor Mounting Gasket

Order No.	Replaces OEM	Fits Models
23 - 1522	MIN010 31688A	Carburetor Mounting Gasket. LV22 - 35, LAV40, H22 - 70.
23 - 3551	MIN010 26756	Carburetor Mounting Gasket. V, VA, LV, H, LAV, HS, TNT, TVS series. 3.5, 4 & 5 hp vertical. 3, 3.5, 4, 5 & 7 hp horz.
23 - 3554	MIN010 33263, 33861	Carburetor Mounting Gasket. V-80, VM70-100, HM70-100 series. 7 through 10 hp vertical & horizontal.
23 - 3555	MIN010 32544 series. 4 hp Sears.	Carburetor Mounting Gasket. ECV100, ECV105, ECV110
23 - 7798	MIN010 33751A	Carburetor Mounting Gasket. LAV-50, 5 hp vertical.



23-1449



23-1501



23-3550

Intake Gasket

Order No.	Replaces OEM	Fits Models
23 - 1449	MIN010 32649A, 30188	Intake Gasket. LAV30 thru 40, ECV100 thru 120, TNT100 thru 120, TVS75 thru 120.
23 - 1501	MIN010 26754A	Intake Gasket. V, VA, LV, H, LAV, HS, TNT, TVS.
23 - 3550	MIN010 27915A	Intake Gasket. V40-80, VH70, VM80-100, H-40-80, HM 70-100 series. 4 thru 10 hp horizontal & vertical.



23-3552



23-7800



23-7799

Carburetor to Air Cleaner

Order No.	Replaces OEM	Fits Models
23 - 3552	MIN010 27272A	Carburetor to Air Cleaner. All models.
23 - 7800	MIN010 33735	Breather Gasket. LAV-50, TNT-100 & TNT-120, 4 & 5 hp.
23 - 7799	MIN010 32760A	Breather Gasket. ECV-100, 105, 110 & 120, 4 & 5 hp.

INTERNAL ENGINE PARTS



Carburetor Gaskets



23-3556



23-3557



23-7795



23-3542



23-1503



23-12819

KOHLER

Order No.		Replaces OEM	Fits Models
23 - 3556	MIN010	210223	Carburetor. K141, K161, K181 series. 6, 7 & 8 hp.
23 - 3557	MIN010	271030	Carburetor. K241, K301, K321 series. 10, 12 & 14 hp.
23 - 7795	MIN010	41-041-11	Air Cleaner Gasket. K-91 & K-161 4 & 7 hp horizontal.
23 - 3542	MIN010	25-041-09 25-041-05, 52-041-1747-041-04	Fuel Pump Gasket. K241, K301, K321 series. 10, 12 & 14 hp.
20 - 1503	MIN010	210468	Bowl Gasket. K-91 & K161, 4 & 7 hp horizontal.
23 - 12819	MIN010	25-041-04S	Float Bowl Gasket. 2-7/16" dia.



23-7168

RYAN

Order No.		Replaces OEM	Fits Models
23 - 7168	MIN010	610675	Carburetor Mounting Gasket. Fits model 10-C, also Ryobi.



23-2971



23-3550



23-3544



23-2961



23-2970

LAWN-BOY

Order No.		Replaces OEM	Fits Models
23 - 2971	MIN010	609476	Carburetor to Block Gasket. F series.
23 - 3550	MIN010	602052	Carb. Throat Gasket. C & D series.
23 - 3544	MIN010	604283	Carburetor Bowl Gasket. D series.
23 - 2961	MIN010	602850	Carburetor Bowl Gasket. C & F series (Plastic Carb.)
23 - 2970	MIN010	93-1233, 609420	Muffler Gasket. "F" Engines.

INTERNAL ENGINE 23



INTERNAL ENGINE PARTS

Carburetor Gaskets



23-2972



23-2973



23-2974



23-8369

LAWN-BOY

Order No.		Replaces OEM	Fits Models
23 - 2972	MIN010	609419	Gear Box Gasket. "F" Engines Self-Propelled.
23 - 2973	MIN010	602763	Crank Case. D & E series.
23 - 2974	MIN010	608362	Reed Plate Gasket to Cylinder. C & D series.
23 - 8369	MIN010	612574	Carburetor Mounting Gasket. All new Lawn-Boy, carburetor to block gasket.

Valve Cover Gaskets



23-2733



23-2734



23-2735



23-8225

BRIGGS & STRATTON

Order No.		Replaces OEM	Fits Models
23 - 2733	MIN010	27549	60000, 80000, 100000, 130000 series 2, 3 & 5 hp horz., 4 & 5 hp vert.
23 - 2734	MIN010	270239, 272602	90000, 110000, 111000 series, 3.5 & 4 hp vert., 4 hp horz.
23 - 2735	MIN010	27803	140000, 170000, 190000, 251000, 252000, 6, 7, 8 & 11 hp horz. & vert.
23 - 8225	MIN010	272481	Quantum & Europa engine series.



23-2736



23-2737



23-2738



23-7793

TECUMSEH

Order No.		Replaces OEM	Fits Models
23 - 2736	MIN010	27234A	LAV22-50, H22-35, HS40, HS50. Fits most vertical 2.5 thru 5 hp Fits 2.5 - 3.5, 4 & 5 hp horizontal.
23 - 2737	MIN010	27896A	V40-60, H40-80, HM70-100, VH40-70. 4 hp Horizontal. 7-10 hp horizontal. 4-7 hp vertical.
23 - 2738	MIN010	31619A	TVS-75, 90, 100, 105 series. 3.5 & 4 hp vertical.
23 - 7793	MIN010	31958A	8, 10 & 12 hp cast iron engines.



23-2739



23-2740



23-2741



23-7794

KOHLER

Order No.		Replaces OEM	Fits Models
23 - 2739	MIN010	230048	K141, K161, K181 series. 6, 7 & 8 hp.
23 - 2740	MIN010	235048	K241, K301, K321 series. 10, 12 & 14 hp. Used with 23-2741 .
23 - 2741	MIN010	275144	K241, K301, K321 series. 10, 12 & 14 hp. Used with 23-2740 .
23 - 7794	MIN010	220370	K-91 4 hp horizontal.

23

INTERNAL ENGINE

INTERNAL ENGINE PARTS



Base Gaskets

BRIGGS & STRATTON

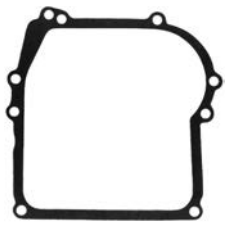

23-1401



23-1402

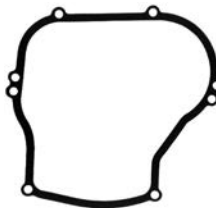

23-1403

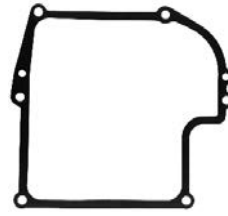

23-1404

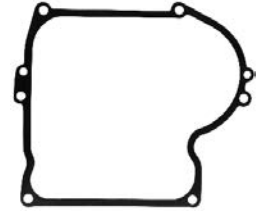

23-3530



23-3648

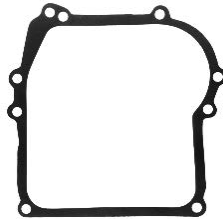

23-3649



23-6522

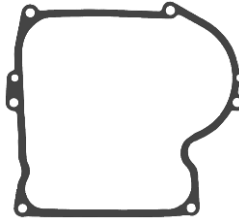

23-6528

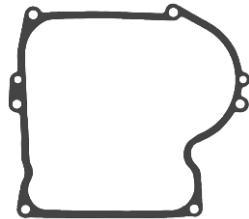

23-6529

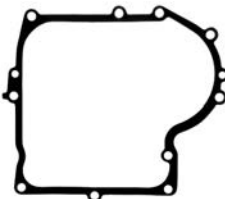

23-7246

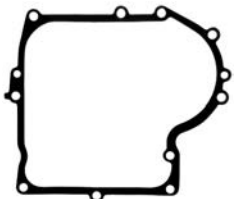

23-7247

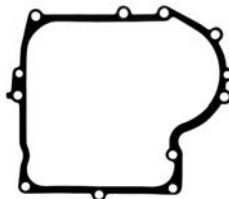

23-7248

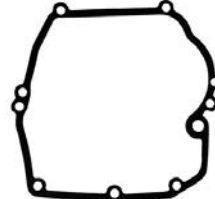

23-8228

INTERNAL ENGINE 23

Order No.		Replaces OEM	Fits Models
23 - 1401	MIN010	692218 270833	Base Gasket. .015 6B, 8B, 60100 to 61909, 80100 to 80800, 80900 to 80997, 81100 to 81800, 81900 to 82997, 92500 to 95599, 110900 to 111900. 3.5 & 4 hp vertical.
23 - 1402	MIN010	692213 270080	Base Gasket. .015 100200 to 100299, 130200 to 130299, 131200 to 131499. 5 hp horizontal and 4 hp.
23 - 1403	MIN010	270069	Base Gasket. .015 100900, 130900, 131900, 5 hp vertical.
23 - 1404	MIN010	692221 271701 27750	Base Gasket. .015 146000, 140200 to 147703, 170400 to 190799, 191700 to 191799, 195400 to 195499. 6, 7 & 8 hp vert. and horz.
23 - 3530	MIN010	271702 270808	Base Gasket. 251700, 252700 series 11 hp vertical .015.
23 - 3648	MIN010	27293	Base Gasket. 191400 - 193400.
23 - 3649	MIN010	270895	Base Gasket. 80000 series, .005 90000 series thru 111000 series.
23 - 6522	MIN010	691569 27351	Base Gasket. 6, 7, 8 hp Cast Iron; horz. cast Iron 16 hp 326400.
23 - 6528	MIN010	270915	Base Gasket. .005 thick.
23 - 6529	MIN010	270916	Base Gasket. .009 thick.
23 - 7246	MIN010	692226 271916	Base Gasket. 1/64" thick 12 & 12.5 hp. Models 280000, 281000.
23 - 7247	MIN010	692406, 271997	Base Gasket. .005" thick 12 & 12.5 hp. Models 282700, 286700.
23 - 7248	MIN010	692405, 271996	Base Gasket. .009" thick 12 & 12.5 hp. Models 282700, 286700.
23 - 8228	MIN010	272198	Crankcase Gasket. Quantum engine series.



Base Gaskets

TECUMSEH

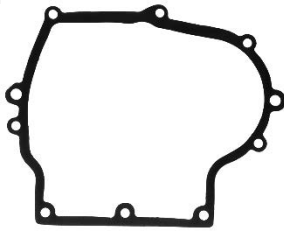

23-3531

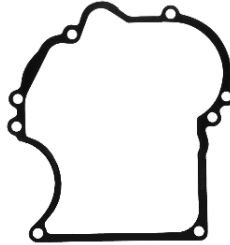

23-3532

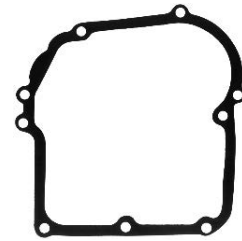

23-3650

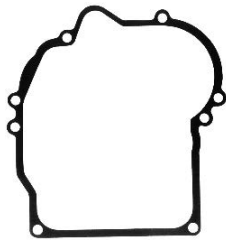

23-3651

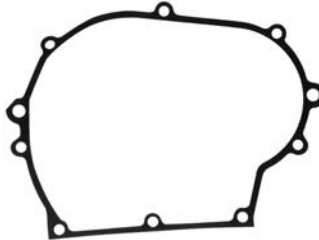

23-3652

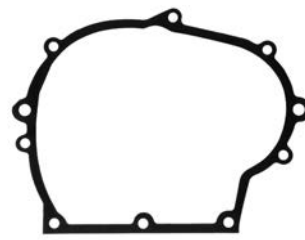

23-3653

Order No.	Replaces OEM	Fits Models
23 - 3531	MIN010 35262A 33253A	Base Gasket. VM70-100, HM70-100, V-80 series. 7 thru 10 hp horz & vert.
23 - 3532	MIN010 32793	Base Gasket. ECV100, 105, 110, 120 series. For Sears.
23 - 3650	MIN010 27677A	Base Gasket. LAV30-35, H30, HS40, HS50. 3 & 3.5 hp vert. 3, 4 & 5 hp horz.
23 - 3651	MIN010 35261 26750A	Base Gasket. 4 hp TNT, LAV30, LAV35, LAV40, LAV50, ECV100, TVS75, TVS105, TNT100, TNT120, 35261, 5 hp vert.
23 - 3652	MIN010 30667	Base Gasket. V35, V40, 3.5 & 4 hp vertical.
23 - 3653	MIN010 30684	Base Gasket. V60, VH60, H50, H60, HH60, H70, HH70, VH70, V70.

KOHLER

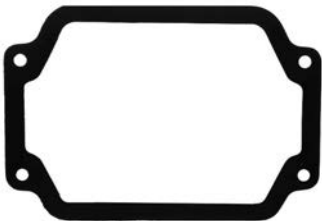

23-3533

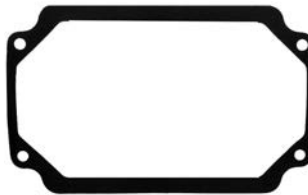

23-3534

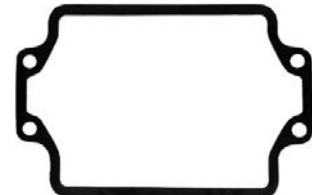

23-7803

Order No.	Replaces OEM	Fits Models
23 - 3533	MIN010 41-041-03	Base Gasket. K141, K161, K181. 6, 7 & 8 hp.
23 - 3534	MIN010 235057	Base Gasket. K301, K321 series. 10, 12 & 14 hp.
23 - 7803	MIN010 220157	Base Gasket. K-91 4 hp horizontal.

INTERNAL ENGINE PARTS



Base Gaskets

HONDA



23-13650

Order No.	Replaces OEM	Fits Models
23 - 13650	MIN010	11381-ZH8-801 Base Gasket. Fits GX160/GX200.

Breather Tube Grommet for BRIGGS & STRATTON



Order No. 23 - 14299

Breather tube grommet replaces B&S 692189. 90 degree.
MIN010

Oil Gauge & Gasket for HONDA



Order No. 23 - 10471

Oil gauge and gasket replaces Honda 15600-ZE1-003. Fits models GX110, 120, 140, 160.

Oil Gauge & Gasket for HONDA



Order No. 23 - 10467

Oil gauge and gasket replaces Honda 15650-ZMO-801. Fits models GCV135/160.

Oil Fill Cap for HONDA



Order No. 23 - 10864

Oil fill cap replaces Honda 15600-ZG4-003. Fits models GX110/120/140/160, GX240/270/340/390.

Oil Plugs for BRIGGS & STRATTON



Order No. 23 - 2681

Replaces B&S 281658, 66768. Made of Nylon. MIN010

Oil Seal for B&S



Order No. 23 - 8789

Oil seal replaces B&S 281370A, 68838. For engine with extended plastic dipstick. MIN010

Oil Gauge for B&S



Order No. 23 - 9811

Oil gauge replaces B&S 692939 & 296768. Fits horizontal & vertical shaft engines. MIN005

23

INTERNAL ENGINE



Magnetic Oil Drain Plug for B&S



Order No. 23 - 9778

Magnetic drain plug replaces B&S 92738. Fits B&S & Kohler engines. 3/8" - 18 pipe thread. MIN005



Order No. 23 - 6866

Oil Plug with built-in dipstick. Replaces B&S 280663. Used on B&S Quantum engines.

Magnetic Drain Plug for B&S



Order No. 23 - 9965

Magnetic drain plug replaces B&S 691663 / 94174. Fits 2 - 5 hp engines. 1/4" pipe threads. MIN005

Oil Drain Valve for HONDA



Order No. 23 - 12110

Oil drain valve (Metric M14 x 1.5) threads. Fits Honda. Replaces Honda 15558-ZJ1-010AH. For GX610 & 620.

Oil Drain Valve for KAWASAKI



Order No. 23 - 12111

Oil drain valve (Metric M16 x 1.5) threads. Replaces Kawasaki 99969-1395. Fits model FD620. Also replaces John Deere AM115362, Scag 482351.

Oil Drain Valve for SCAG



Order No. 23 - 12259

Oil drain valve (3/8" - 18 NPTF) threads. 2-1/8" longer version of our 23-12260. Replaces Scag 482352. Also fits some Kawasaki 19-25 hp vert engines.

Oil Drain Valve for SCAG



Order No. 23 - 12112

Oil drain valve (Metric M20 x 2.5) threads. Replaces Scag 482349. Also fits some Kawasaki 19-25 hp vert engines.

Oil Drain Valve



Order No. 23 - 12260

Oil drain valve (3/8" - 18 NPTF) threads.

INTERNAL ENGINE PARTS



Oil Drain Valve for BRIGGS & STRATTON

Order No. 23 - 6783

Oil drain valve replaces Briggs & Stratton 186071GS. Also replaces Kohler 25-755-14. Easy to use oil drain valve allows you to change engine oil on lawn equipment without the mess associated with traditional and expensive pipe fittings. Now in an attractive package with a length of vinyl tubing and dust cap. Instructions on reverse side. **(carded)**



FLYWHEEL KEYS

Order No.

Replaces OEM

23 - 1435	MIN100	Briggs & Stratton 222698
23 - 11435	MIN005	Briggs & Stratton 222698 (3 per card)
23 - 1437	MIN010	Tecumseh 27902
23 - 1439	MIN010	Tecumseh 610951
23 - 1440	MIN010	Tecumseh 610961
23 - 8955	MIN010	Tecumseh 610995
23 - 8953	MIN010	Tecumseh 611004
23 - 11812	MIN010	Tecumseh 611154

23-1435

23-1437

23-11435

23-1439

23-1440

23-8953

23-8955

23-11812

Tune Up Kit for BRIGGS & STRATTON

Order No. 23 - 14333

Briggs & Stratton Tune-up Kit for 3.5 hp - 6.5 hp Quantum Engines. Includes spark plug, air filter, 4 cycle oil, and fuel stabilizer. The handy package converts to an oil funnel and drain pan. MIN004

Order No. 23 - 14334

Briggs & Stratton Tune-up Kit for 3.5 hp - 4.5 hp Q45, Classic, Sprint, Quattro Engines. Includes spark plug, air filter, 4 cycle oil, and fuel stabilizer. The handy package converts to an oil funnel and drain pan. MIN004



Tune Up Kit for HONDA

Order No. 23 - 14335

Honda Tune-up Kit for 3.5 hp - 5.0 engines for older applications. Includes spark plug, air filter, 4 cycle oil, and fuel stabilizer. The handy package converts to an oil funnel and drain pan. MIN004

Order No. 23 - 14336

Honda Tune-up Kit for HRR, HRX applications 5.0 + mulcher engine. Includes spark plug, air filter, 4 cycle oil, and fuel stabilizer. The handy package converts to an oil funnel and drain pan. MIN004



SPARK PLUGS AND ACCESSORIES

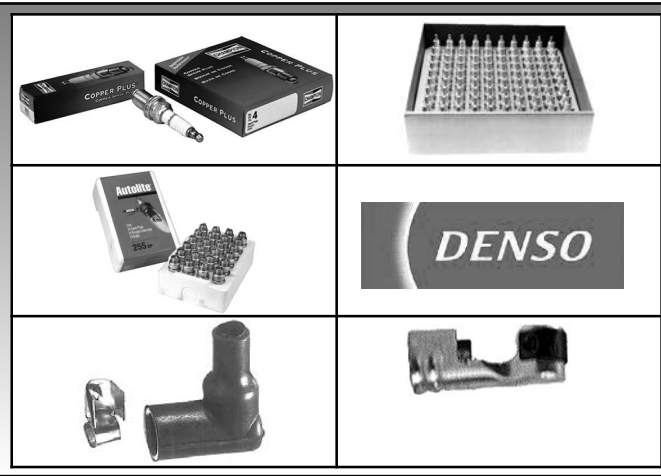

Autolite
Everything goes with Autolite.



Quick-Glance

SPARK PLUGS AND ACCESSORIES PG.

Spark Plugs

Autolite	589-590
Champion	591-593
NGK	594-597
NGK ATV	597
Denso	598
Boot	599-600
Shorting Clips	599-600
Wire	599-600
Clip	599-600



Autolite

Everything goes with Autolite.



Order No.		Description
24 - 7019	MIN004	* 26 Autolite Replaces Champion RBL16Y, NGK UR4, Nippondenso T16PR-U
24 - 7220	MIN004	* 64 Autolite Replaces Champion RN11YC, NGK BPR5ES, ND W16EPR-U & Bosch WR8DS.
24 - 7222	MIN004	* 106 Autolite Replaces Champion RS14YC, NGK TR-5 & ND T20EPR-U.
24 - 2542	MIN004	** 216 Autolite Replaces Champion H10, NGK B6L, ND W14L, Bosch WSAO. Fits Kohler, Bolens, Gravely, Hoffco, L & G Equipment; Toro Power Mowers.
24 - 2543	MIN004	** 255 Autolite Bantam Replaces Champion CJ6, CJ8, NGK BM6A, W20M-U, Bosch WS8E Fits B&S.
24 - 5859	MIN004	** 258 Autolite Repl. Champion CJ14, NGK BM4A, ND W14M-U10, Bosch WS8E
24 - 7231	MIN004	** 275 Autolite Replaces Champion L92YC, NGK B4HS, BP4HS, ND W14FP, W14FP-L & Bosch W8BC.
24 - 5860	MIN004	** 295 Autolite Repl. Champion J8, J8C, NGK B6S, ND W20S, Bosch W9ECO.
24 - 7224	MIN004	* 306 Autolite Replaces Champion J11C, NGK B4, ND W9-U & Bosch WR9EC.
24 - 7225	MIN004	* 308 Autolite Replaces Champion RJ19LM, Rc12CNGK B2 & Bosch WR9EC & RJ12C.
24 - 7227	MIN004	* 386 Autolite Repl. Champion D14, D16J & D21, NGK A6 & A7, ND L14-U & M22.
24 - 8963	MIN004	* 403 Autolite Repl. Champion RN3C, NGK BR6ES.
24 - 7153	MIN004	* 425 Autolite Replaces Champion RL86C, L86C, L14 & L90, NGK B4H & B6HS, ND W14F-U, W20FS-U, Bosch W7AC & W7AO.
24 - 2544	MIN004	** 456 Autolite Replaces Champion J8, J17LM, NGK B4LM, ND W14LM-U. Fits Ariens, Bolens, Bunton, Craftsman, Dayton, FMC, Jacobsen, Lawn-Boy, Toro, Wheel Horse, Yardman Power Mowers.
24 - 6595	MIN004	** 458 Autolite Repl. Champion No. J19LM, NGK B4LM, W14LM-U, Bosch W9EO.
24 - 6835	MIN004	** 2554 Autolite Replaces Champion No. DJ7Y, NGK BPM6F.
24 - 2547	MIN004	** 2956 Autolite Bantam Tapered Seat Plug Replaces Champion DJ8J, NGK BM6F, ND WA20M-U, Bosch HS8E. Fits Homelite, K&S, Lawn-Boy, McCulloch, Ryan, Danarm, Homelite, Skil Power Saws.
24 - 7191	MIN004	** 2974 Autolite Repl. Champion CJ7Y, NGK BPM7A, ND W22MP-U, Bosch WS7F.

Note: * Resistor type plug **Non-resistor type plug

SPARK PLUGS AND ACCESSORIES



Autolite

Everything goes with Autolite.



Order No.	Description	
24 - 2548	MIN004	** 2976 Autolite Bantam Gasket Seat Plug Replaces Champion CJ8Y, NGK BPM6A, ND W20MP-U. Fits Honda Engines & Generators; Echo, Suzuki, Dayton, Echo, Poulan, Shindaiwa, Skil Power Saws.
24 - 8964	MIN010	** 3076 Autolite Replaces Champion W14.
24 - 7229	MIN004	* 3924 Autolite Replaces Champion RC12YC & NGK BCPR6ES. For B&S Vanguard
24 - 10021	MIN004	* 3926 Autolite Fits V-Twin B&S engines.
24 - 7232	MIN004	* 4063 Autolite Replaces Champion RN3C, NGK BR8ES & ND W24ESR-U.
24 - 2550	MIN004	** 4093 Autolite Special Repl. Champion L82C, UL4J, UL81C, UL81J, NGK B7HS, ND W22FS. Fits Honda, Kawasaki, Robin, Sachs, Solo, Suzuki, Tanaka & Tec.
24 - 7230	MIN004	* 4263 Autolite Replaces Champion RN9YC, NGK BP6ES, ND W20ETR-S.
24 - 7311	MIN004	* 4265 Autolite Plug. Replaces Champion N11YC, NGK BP5ES & ND W16EX-U Bosch WR8DS.

Note: * Resistor type plug **Non-resistor type plug

Autolite Spark Plug Display Pack



- Order No. 24 - 9734**
255DP Autolite spark plugs, display pack. MIN010
- Order No. 24 - 9735**
258DP Autolite spark plugs, display pack. MIN010
- Order No. 24 - 9736**
295DP Autolite spark plugs, display pack. MIN010
- Order No. 24 - 9737**
456DP Autolite spark plugs, display pack. MIN010
- Order No. 24 - 9738**
458DP Autolite spark plugs, display pack. MIN010
- Order No. 24 - 9739**
2956DP Autolite spark plugs, display pack. MIN010

AUTOLITE Service Packs



24 plugs in a protective styrofoam box.

- Order No. 24 - 2551**
255 Autolite spark plugs, 24/service pack. MIN024
- Order No. 24 - 2555**
456 Autolite spark plugs, 24/service pack. MIN024

SPARK PLUG/ACCE. 24



SPARK PLUGS AND ACCESSORIES





Order No.		Description
24 - 2510	MIN004	CJ6 Champion Replaces Autolite 254, NGK BM7A, ND W22M-U & Bosch WS7E.
24 - 8882	MIN004	CJ6Y Champion Replaces Autolite 2974, NGK BPM7A, Bosch WS5F.
24 - 2513	MIN004	CJ7Y Champion Repl. Autolite 2974, NGK BPM7A, ND W22MP-U, & Bosch WS7F.
24 - 2504	MIN004	CJ8 Champion Replaces Autolite 255, NGK BM6A, ND W20M-U, & Bosch WS8E.
24 - 7148	MIN004	CJ8Y Champion Repl. Autolite 2976, NGK BPM6A, ND W20MP-U & Bosch WS8F.
24 - 2507	MIN004	CJ14 Champion Repl. Autolite 258, NGK BM4A, ND W14M-U10, & Bosch WS8E.
24 - 7185	MIN006	D14 Champion Replaces Autolite 386, NGK AB7, ND M22 & Bosch M5A.
24 - 7422	MIN006	D16 Champion Replaces Autolite 386, NGK AB7, ND L14-U.
24 - 2512	MIN004	DJ6J Champion Repl. Autolite 2954, NGK BM7F, ND WA22M-U, & Bosch HS5E.
24 - 8496	MIN004	DJ7Y Champion Repl. Autolite 2554, NGK BPM6F.
24 - 2509	MIN004	DJ8J Champion Replaces Autolite Spark Plug No. 2956.
24 - 6932	MIN004	H10C Champion Repl. Autolite 215, 216, 217, NGK B4L, ND W14L, Bosch WSAO.
24 - 2506	MIN004	J8C Champion Replaces Autolite 295, NGK B6S, ND W20S, & Bosch W9ECO.
24 - 2505	MIN004	J17LM Champion Repl. Autolite 456, NGK B4LM, ND W14LM-U, & Bosch W9EO.
24 - 5936	MIN004	J19LM Champion Replaces Autolite Spark Plug No. 458. NGK B2LM.
24 - 7187	MIN004	L82C Champion Repl. Autolite 4092, NGK B7HS, ND W24FS-U, Bosch W6AC.
24 - 7150	MIN004	L86C Champion Repl. Autolite 425, NGK B6HS, ND W20FS-U & Bosch W9EO.
24 - 7186	MIN004	L78C Champion Repl. Autolite 4092, NGK B8HS, ND W24FS-U & Bosch W4-A1.
24 - 7149	MIN004	N9YC Champion Repl. Autolite 4253, NGK BP6ES, ND W20EP-U & Bosch W6D.
24 - 7868	MIN004	N11YC Champion Repl. Autolite 64, NGK BP4ES, ND W16EX-U/W16EPU & Bosch W8DC.
24 - 10786	MIN004	QC12YC Champion
24 - 10788	MIN004	QJ19LM Champion
24 - 14492	MIN004	 RA8HC Champion Replaces Autolite 4164, NGK DCPR7E & DR7EB, Torch TK9RTC Kohler 1413207S. Fits Toro XT149 & XT650.
24 - 8883	MIN004	RCJ6Y Champion Replaces Autolite 2974 & 2984, NGK BP6M7A & Bosch WRS5F.
24 - 7190	MIN004	RCJ8Y Champion Replaces Autolite 2985, NGK BP6M6A, ND W20MPR.
24 - 11307	MIN004	RCJ7Y Champion
24 - 11308	MIN004	RCJ8 Champion

24

SPARK PLUG/ACCE.

SPARK PLUGS AND ACCESSORIES



Order No.		Description
24 - 7423	MIN006	RC12YC Champion Replaces Autolite 3924, NGK BCPR6ES.
24 - 8495	MIN004	RC14YC Champion Replaces Autolite 3926.
24 - 14308	MIN004	 RDZ4H Champion Replaces MTD 794-00043.
24 - 9538	MIN004	RDZ19H Champion Replaces Torch A4RTF.
24 - 9539	MIN004	RH10C Champion Replaces Autolite 216.
24 - 8571	MIN004	RJ12C Champion Replaces Autolite 308, NGK BR6S.
24 - 11309	MIN004	RJ17LM Champion
24 - 8054	MIN008	RJ18YC Champion Replaces Autolite 86, NGK XR4, ND W9PR-U.
24 - 6934	MIN004	RJ19LM Champion Replaces Autolite 308, NGK BR2LM, Bosch WR9EC.
24 - 9535	MIN004	RL95YC Champion Replaces Autolite 275.
24 - 7188	MIN004	RN9YC Champion Replaces Autolite 4263, NGK BPR6ES, ND W20ETR-S.
24 - 7189	MIN004	RN11YC4 Champion Repl. Autolite 64, NGK BPR5ES, ND W16EPR-U & Bosch WR8DS.
24 - 8497	MIN004	RN4C Champion Replaces Autolite 403, NGK BR6ES.
24 - 6935	MIN006	RS14YC Champion Replaces Autolite 106, NGK TR5, ND T20EPR-U.
24 - 9493	MIN004	RS17YX Champion Replaces Autolite 106, NGK TR4.
24 - 8073	MIN004	RV17YC Champion Replaces Autolite 26, NGK UR4.
24 - 14637	MIN004	 XC10YC Champion Replaces Kohler 6213204S. Fits Kohler CH940-1000.
24 - 14636	MIN004	 XC12YC Champion Replaces Autolite 5503, Denso Q16PR-U, NGK BCPR5ES, BKR5E, CS6, Kohler 2513214S.
24 - 12381	MIN004	XYC92YC Champion This plug has a special resistor in it that meets more stringent RFI standards.

24 SPARK PLUG/ACCE.

Spark Plug for MTD/RYOBI



Order No. 24 - 12650

Spark plug replaces MTD/Ryobi 791-180852B. Fits 4-cycle trimmers. Replaces Torch A4RTF & Champion RDZ19H our 24-9538.

CHAMPION Premium Gold Spark Plug



Order No. 24 - 9730

Champion 2071 premium gold. Replaces NGK FR4, Autolite 3924. MIN004



CHAMPION
Service Packs



24 plugs in a protective styrofoam box.

Order No.	Replaces	
24 - 2529	CJ8 Champion	MIN024
24 - 9993	CJ8Y Champion	MIN024
24 - 2530	J17LM Champion	MIN024
24 - 6877	J19LM Champion	MIN024
24 - 6933	RC12YC Champion	MIN024
24 - 11220	RC14YC Champion	MIN024
24 - 2531	J8C Champion	MIN024
24 - 2532	CJ14 Champion	MIN024
24 - 9536	RJ19LM Champion	MIN024

AUTOLITE XTREAM START
Spark Plugs

- Iridium center electrode lasts longer
- Maintains optimal performance longer
- Up to 26%quicker starts than standard spark plugs.
- Up to 21% less HC emissions than a standard spark plug
- Better fuel efficiency and horsepower due to lower HC emissions.



Order No. 24 - 13018

Autolite Xtream Start spark plug XST255DP. Replaces Champion CJ8, NGK BM6A, Denso W20MU, Autolite 255. Carded
MIN010

Order No. 24 - 13020

Autolite Xtream Start spark plug XST2974DP. Replaces Champion CJ6Y & CJ7Y, NGK BPM6A & BPM7A, Autolite 2974. Carded
MIN010

Order No. 24 - 13022

Autolite Xtream Start spark plug XST3924DP. Replaces Champion RC12YC, NGK BCPR6ES, FR5. Carded.
MIN010

Order No. 24 - 13021

Autolite Xtream Start spark plug XST2976DP. Replaces Champion CJ8Y, Autolite 2976.
MIN010

SPARK PLUGS AND ACCESSORIES



NGK
SPARK PLUGS



THE HIGH PERFORMANCE PLUG
COPPER CORE SINCE 1958

Order No.		Description
24 - 5856	MIN010	AB6 NGK Replaces Champion D9, D9J, D10, D14, D16, D16J, D21, K13, K15J, Autolite 375, 376, 377, 378, AC S85F, C86, C87, 585F, ND M-17. For Wisconsin, Onan, B&S with 18mm heads.
24 - 2535	MIN010	AB7 NGK Replaces Autolite 2695, Bosch M5A, Champion D14, ND M22, AC C82. Snowmobiles: Bombardier, Hirth, JLO, Kohler, Sachs.
24 - 5855	MIN010	B4H NGK Replaces Champion L90, L14, Autolite 415, 417, 425, ND W14F-U, AC 45F, M45FF, 46F. Used on Honda models G150 and G200, also Toro with Suzuki engines.
24 - 10706	MIN010	B2LM NGK Replaces Champion 846, CJ14 and Autolite 458.
24 - 1294	MIN010	B4LM NGK Replaces Champion J17LM, J19LM, AC-LM46 and Autolite 456.
24 - 11304	MIN010	B5HS NGK.
24 - 2536	MIN004	B6HS NGK Replaces Autolite 415 or 425, Bosch W64S, Champion L86C, ND W20FS-U, AC M43FF. Snowmobiles: JLO, Chainsaw: Kaaz, Husky, Stihl. Outboards: Chrysler, Force, Johnson, Mariner, Mercury, Wards Engines: Honda, Kawasaki, Tecumseh, Xenoa, Lawnmowers: Solo, Yazoo.
24 - 2526	MIN010	B6L NGK Replaces Champion H10. Fits Kohler engines K241, K301, K321, K341, K361, K532.
24 - 2517	MIN010	B6S NGK Replaces Champion J6J, J8, J8J, J11, J12, J6, J6C, 12-1/2 & 16 hp. Twin Cylinder Briggs, Green Machine model 4600 LP.
24 - 2516	MIN010	B7HS NGK Replaces UL4J, UJ81J, UL81C, Go Kart Plug.
24 - 2552	MIN010	B8HS NGK Replaces Autolite 4092, Bosch W4A1, Champion L78C, ND W24FS-U, AC M41FF. Snowmobiles: Bolens, Bombardier, Canadian Curtis Wright, Xenoah, Hirth Rupp Sachs, Yamaha. Outboards: Suzuki, Wards, Volvo, Wizard.
24 - 11305	MIN010	B8ES NGK
24 - 2524	MIN010	B8S NGK Green Machine BP Blower model 4600 & Tanaka model TBL 450.
24 - 11306	MIN004	BCPR5ES NGK
24 - 8554	MIN004	BCPR6ES NGK Fits B&S Vanguard. Replaces Champion RC12YC, Autolite 3924.
24 - 12431	MIN010	BKR4E NGK Replaces Champion RC12YC, Autolite 3926, Generac OE6037.
24 - 9872	MIN004	BKR5E (BCPR5ES) NGK Replaces Champion RC12YC, Autolite 3924.
24 - 14559	MIN004	 BKR5E-11 NGK Replaces Champion RC12YC, Denso K16PR-U11.
24 - 2523	MIN010	BM4A NGK Fits Lawn-Boy 2-cycle engines. All Weedeater trimmers. Replaces Champion CJ-14.
24 - 1295	MIN010	BM6A NGK The Low Profile Plug (Shorty) for 2 and 4 cycle Engines, interchangeable with CJ-8, 255, CS-45. Glass sealed insulator.
24 - 1289	MIN010	BM6F NGK Chain saw Plug. A tapered spark plug, for Mini Chainsaws. Replaces Champion DJ8J.
24 - 2500	MIN010	BM7A NGK Replaces CJ4 and CJ6. Fits many Poulan, Pioneer, Remington, McCulloch, Homelite, Echo & Sears.

24
SPARK PLUG/ACCE.



SPARK PLUGS AND ACCESSORIES

NGK
SPARK PLUGS



THE HIGH PERFORMANCE PLUG
COPPER CORE SINCE 1958

Order No.		Description
24 - 2503	MIN010	BM7F NGK Replaces DJ6J. Fits many Wards, Homelite and Sears.
24 - 5854	MIN010	BMR4A NGK Replaces Champion CJ-14. For 12-1/2 thru 17 hp Kawasaki.
24 - 2537	MIN010	BMR6A NGK Replaces Autolite 245, Bosch WSR9E. Champion RCJ8, Nippondenso W20MR-U. Resistor plug for popular BM6A (1295 Plug) Engine: Kawasaki, Xenoah, Chain saws: Dolmar, Pioneer, Tanaka.
24 - 10326	MIN010	BMR7A NGK Resistor plug.
24 - 5858	MIN010	BP4HS NGK Replaces Champion L92YC, Autolite 515, 516, 517, AC 44FFS, ND W14FP-L. For 12.5 Onan engines.
24 - 2534	MIN004	BP5ES NGK Replaces Autolite 54 or 64, Bosch W9D, Champion N11YC, Nippondenso W16EP-U, AC 44X6S. Lawnmowers: Honda.
24 - 2519	MIN004	BP6ES NGK Fits Honda (HR214-HRA214) 4 hp Model GXV120. Also Toro-Suzuki Overhead valve 4-cycle engine.
24 - 2518	MIN010	BPM4A NGK Fits Toro Suzuki 2-cycle engines. Replaces Toro No. 81-0181.
24 - 2501	MIN010	BPM6A NGK Replaces CJ7Y, CJ8Y. Fits Husqvarna, JD, Echo, Honda.
24 - 2533	MIN010	BPM7A NGK Replaces Autolite 2974, Bosch WS5F, Champion CJ7Y, Nippondenso W22MP-U. Engines: Honda, Xenoa. Chain saws: Echo, Jonsereids, Poulan, Tonaka, Wairds.
24 - 7893	MIN010	BPM-6Y Replaces Echo Trimmers/Brushcutters, Chain Saws, Blowers.
24 - 7892	MIN010	BPM-7Y Replaces Echo Trimmers/Brushcutters, Chain Saws, Blowers.
24 - 10020	MIN010	BPM8Y NGK. Replaces Echo. Fits Tornado Engine.
24 - 8358	MIN010	BPMR4A NGK Fits Toro/Wheel Horse & Lawn-Boy 2 cycle with Suzuki engine. Replaces Champion RCJ7Y. Resistor plug.
24 - 10950	MIN010	BPMR6F NGK Replaces MTD 791-61031B. Resistor plug.
24 - 10176	MIN010	BPMR6A NGK Resistor plug.
24 - 5850	MIN010	BPMR7A NGK Replaces Champion RCJ7Y, AC CS42S, Autolite 2974, Nippondenso W22MFV Chain saw Plug for Echo and all Stihl except 08S.
24 - 13373	MIN010	BPMR7Y NGK Fits Echo & Husqvarna.
24 - 13362	MIN010	BPMR8Y NGK Fits Echo PB403T, PB610, PF620, PB650, PG651, PF651T, PB750, PB751.
24 - 9890		BPR2ES NGK Used on Kawasaki 27 hp water cooled model FD750D.
24 - 9873	MIN004	BPR4ES NGK Replaces Champion RN14YC, Autolite 4265.
24 - 2538	MIN004	BPR5ES NGK Replaces Autolite 64, Bosch WR9D, Champion RN11YC, Nippondenso W16EPR-U, AC CR44NS. Inboard Marine Engines: Chrysler, Engines: Kawasaki. Outboard Marine Engines: Honda.
24 - 2539	MIN004	BPR6ES NGK Replaces Autolite 4263, Bosch WR7D, Champion RN9YC, ND W20EPR-U, AC R42XLS, Torch F6RTC. Inboard Marine Engines: Chrysler, Mercousier, Engines: Kohler.
24 - 12984	MIN010	BPR6HS NGK Fits Kubota Gas ZTR's 22 & 27 hp, V-Twin.
24 - 5852	MIN010	BR4HS NGK Replaces Champion L92YC. For Honda Generators.

SPARK PLUGS AND ACCESSORIES



NGK
SPARK PLUGS



THE HIGH PERFORMANCE PLUG
COPPER CORE SINCE 1958

Order No.		Description
24 - 2553	MIN010	BR8ES NGK Replaces Autolite 4063, Champion RN3C, ND W24ESR-U, AC S42 XLR. For Snowmobiles: Artic Cat, Bombardier, Xenoah, JD, Fuji.
24 - 2554	MIN010	BR9ES NGK Replaces Autolite 4062, Champion RN2C, ND W27ESR, AC S41XLR. Snowmobiles: Artic Cat, Bombardier, JD, Fuji, Scorpion & Yamaha
24 - 10234	MIN010	BR2LM NGK Resistor plug.
24 - 14560	MIN010	 BR4LM NGK Replaces Champion RJ17LM, Denso W14LMR-US.
24 - 10707	MIN010	BR6S NGK Replaces Champion RJ8C and Autolite 303. Resistor Plug.
24 - 10999	MIN010	BR7HS NGK Replaces Champion RL82C/874, and Autolite 4093. Resistor Plug.
24 - 10370	MIN010	C8HSA NGK Resistor plug.
24 - 11571	MIN010	CM6 NGK Used on Honda Generators. Replaces Denso U20MU
24 - 9593	MIN010	CMR-7A NGK Resistor Plug.
24 - 12376	MIN010	CMR-6A NGK Fits Robin. Resistor Plug
24 - 12064	MIN010	CMR-4H NGK Fits Stihl. Replaces Bosch USR7AC to fit 4 stroke. Resistor
24 - 10427	MIN010	CMR-5H NGK Fits Stihl Trimmers. Resistor Plug
24 - 10187	MIN010	CMR-6H NGK Resistor plug.
24 - 10188	MIN010	CMR-7H NGK Resistor plug. Fits Red Max, Champion RZ7C
24 - 14415	MIN010	CMR7H-10 NGK Replaces Husqvarna 528-07-40-01. Fits Red Max & Husqvarna models 243J, 243R, 543RS.
24 - 9405		CR5HSB NGK Used on Honda 4 cycle trimmers. Resistor Plug
24 - 13039	MIN010	DR7EB NGK Fits Kohler Vertical models XT6. Replaces Champion 8815, Torch K5RTC. Resistor Plug.
24 - 9871	MIN004	FR4 NGK Replaces Champion RC144C, Autolite 3924. Resistor Plug
24 - 5851	MIN004	TR-5 NGK Replaces Champion RS9YC. For Onan on Wheelhorse. Resistor.
24 - 5857	MIN004	UR4 NGK Replaces Champion RV12YC, RV17YC, RV15YC, Autolite 15, 16, 25, 26, 27, 725, 726, AC 45TS, 44TS, 46TS, R44TS, R45TS, R46TS. For Kohler Mag. series. 17-21 hp. Resistor Plug
24 - 7021	MIN004	XR-5 NGK Replaces Autolite 26, Champion RJ14YC, ND T16PR-U. Resistor
24 - 10898	MIN004	ZFR4F-11 NGK Fits Generac engines GTV990. Used on Dixie Choppers. Resistor.
24 - 11078	MIN004	ZGR5A NGK Fits Honda GXV610, 620, 670 twin cylinders. Resistor Plug

24 SPARK PLUG/ACCE.

NGK CS Series Plugs



Order No.		Description
24 - 12312	MIN100	CS6 NGK Replaces BKR5ES, BKR5E, Champion RC12YC, RC14YC. (RES)



SPARK PLUGS AND ACCESSORIES

**NGK
Shop Packs**



NGK SHOP PACK FEATURES

- 25 spark plugs for convenient storage and easy access.
- Carton is recyclable and biodegradable.
- Attractive new packaging for quick identification

Order No.	Description	Order No.	Description
24 - 9371	MIN025 B2LM NGK.	24 - 11650	MIN025 BMR6A NGK.
24 - 9385	MIN025 B4LM NGK.	24 - 11651	MIN025 BPM7Y NGK.
24 - 9388	MIN025 BM6A NGK.	24 - 11652	MIN025 BPM8Y NGK.
24 - 9392	MIN025 BPM7A NGK.	24 - 11653	MIN025 BPMR6A NGK.
24 - 11648	MIN025 BKR5E NGK.	24 - 11654	MIN025 BPMR7A NGK.
24 - 11649	MIN025 BMR4A NGK.	24 - 11655	MIN025 BPR2ES NGK.
		24 - 11656	MIN025 BR7HS NGK.

**NGK Spark Plugs for
ATV's**



Order No. 24 - 10988

NGK CR7E Spark Plug. Replaces Champion G59C / 654, Autolite 4303. Fits Artic Cat, Kawasaki & Suzuki ATV's.
MIN010

Order No. 24 - 10989

NGK BPR7HS Spark Plug. Replaces Champion RL82YC / 814, Autolite 4123. Resistor.
MIN010

Order No. 24 - 10990

NGK DR8EA Spark Plug. Replaces Champion RA6HC / 809, Autolite 4163. Resistor.
MIN010

Order No. 24 - 10991

NGK DPR8EA-9 Spark Plug. Replaces Champion RA6HC / 809, Autolite 4163. Resistor. Fits Honda, Kawasaki & Yamaha ATV's.
MIN010

Order No. 24 - 10992

NGK DR7EA Spark Plug. Replaces Champion RA8HC / 810, Autolite 4163. Resistor. Fits Artic Cat, Kawasaki & Suzuki ATV's.
MIN010

Order No. 24 - 11523

NGK BKR6E spark plug. Fits Polaris ATV's.
MIN004

Order No. 24 - 10993

NGK CR7HS Spark Plug. Replaces Champion 294 / 808, Autolite 4194. Resistor.
MIN010

Order No. 24 - 10994

NGK DR8ESL Spark Plug. Replaces Champion RA6HC / 809, Autolite 4162. Resistor. Fits Honda,ATV's.
MIN010

Order No. 24 - 10995

NGK CR6E Spark Plug. Resistor. Fits Artic Cat & Suzuki ATV's.
MIN010

Order No. 24 - 10997

NGK BPR4HS Spark Plug. Replaces Champion RL95YC / 929, Autolite 275, 4114. Resistor.
MIN010

Order No. 24 - 10998

NGK DCPR8E Spark Plug. Replaces Champion RA4HC / 905. Resistor.
MIN010

Order No. 24 - 10999

NGK BR7HS Spark Plug. Replaces Champion RL82C / 874, Autolite 4093. Resistor.
MIN010

Order No. 24 - 12234

NGK C7HSA spark plug. Used on Chinese built ATV's. Replacement for NHSP LD Torch A7RTC 044 & 041.
MIN010

SPARK PLUGS AND ACCESSORIES



DENSO Spark Plugs



Order No.		Description
24 - 12542	MIN010	Denso W20M-U Replaces Champion CJ8, Autolite 255, NGK BM6A.
24 - 12543	MIN004	Denso W16EX-U#4 Replaces Champion N11YC, Autolite 64, NGK BP5ES.
24 - 12544	MIN010	Denso W14LM-U Replaces Champion J19LM, Autolite 458, NGK B4LM.
24 - 12545	MIN010	Denso W22MP-U Replaces Champion CJ7Y, Autolite 2794, NGK BPM7A.
24 - 12546	MIN010	Denso W20MP-U Replaces Champion CJ8Y, Autolite 2796, NGK BPM6A.
24 - 12547	MIN004	Denso W20EX-U#4 Replaces Champion N9YC, Autolite 63, NGK BP6ES.
24 - 12548	MIN010	Denso W14-U Replaces Champion J8, Autolite 295, NGK B6S.
24 - 12549	MIN010	Denso W22M-U Replaces Champion CJ6, Autolite 254, NGK BM7A.
24 - 12550	MIN004	Denso W20EPR-U#4 Replaces Champion RN9YC, Autolite 4263, NGK BPR6ES. Torch F6RTC
24 - 12551	MIN004	Denso Q16PR-U#4 Replaces Champion RC12YC, Autolite 5503, NGK BCPR5ES
24 - 12552	MIN010	Denso W22MPR-U Replaces Champion RCJ7Y, Autolite 2974, NGK BPMR7A
24 - 12553	MIN004	Denso W16EPR-U#4 Replaces Champion RN11YC, Autolite 4264, NGK BPR5ES
24 - 12554	MIN010	Denso W20MR-U Replaces Champion RCJ8, NGK BMR6A
24 - 12555	MIN004	Denso W14EPR-U Replaces Champion RN14YC, Autolite 4265, NGK BPR4ES
24 - 12558	MIN010	Denso U20MU Replaces Champion Y82, NGK CM6

24 SPARK PLUG/ACCE.



SPARK PLUGS AND ACCESSORIES

Plug Shorting Clips



Order No. 24 - 1296

Snap on shorting clip.

MIN010

Spark Plug Wire



Order No. 24 - 8775

7mm spark plug wire. 10' coils. Quality black Hypalon - copper.

Order No. 24 - 8776

5mm spark plug wire. 10' coils. Quality black Hypalon - copper.

Spark Plug Boot



Order No. 24 - 8799

Spark plug boot with wire end replaces NGK LB05EP. Boot is water tight and has a built in resistor of 5000 OHMS.

Spark Plug Boot from NGK



Order No. 24 - 9370

45 degree spark plug boot NGK VB05F. Fits overhead valve engines. (water tight)

Spark Plug Boot



Order No. 24 - 10190

Spark plug boot 7mm.

MIN010

Spark Plug Boot for HONDA



Order No. 24 - 10865

Spark plug boot fits Honda models GX110/120/140/160, GX240/270/340/390.

Terminal Spark Plug



Order No. 24 - 9161

Terminal spark plug replaces Briggs & Stratton 493880. Fits 7mm plug wire, positive lock.

MIN010

Terminal Thrust

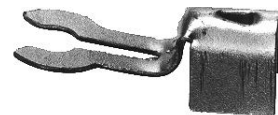

Order No. 24 - 2268

Fits all spark plug wire. Easily installed with pliers. Chrome plated for durability.

MIN010



Order No. 24 - 6710

5 mm Spark plug boot for chain saws and trimmers. Fits Homelite A55373-A.

MIN010

Spark Plug Boot for B&S



Order No. 24 - 12054

Spark plug boot replaces B&S 691909. Fits OHV engines.

MIN010

Clip



Order No. 24 - 8750

Clip only for our 24-6710 plug boot.

MIN010

Clip

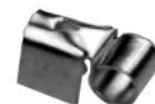

Order No. 24 - 8749

Clip only for our 24-1285 plug boot.

MIN010



Order No. 24 - 1298

Bolt on shoring clip. Replaces B&S 225171, 220197. Pointed to penetrate spark plug boot.
MIN010

Plug Boot & Card Display

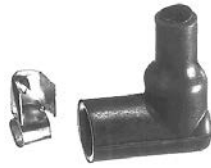

Order No. 24 - 1285

Boot. Replaces Briggs & Stratton 493880, 221798, 66538. Terminal and Elbow.
MIN010

Order No. 24 - 1290

Spark plug boots (carded). (12 per card).



STARTER HANDLES & ROPE

25

Quick-Glance

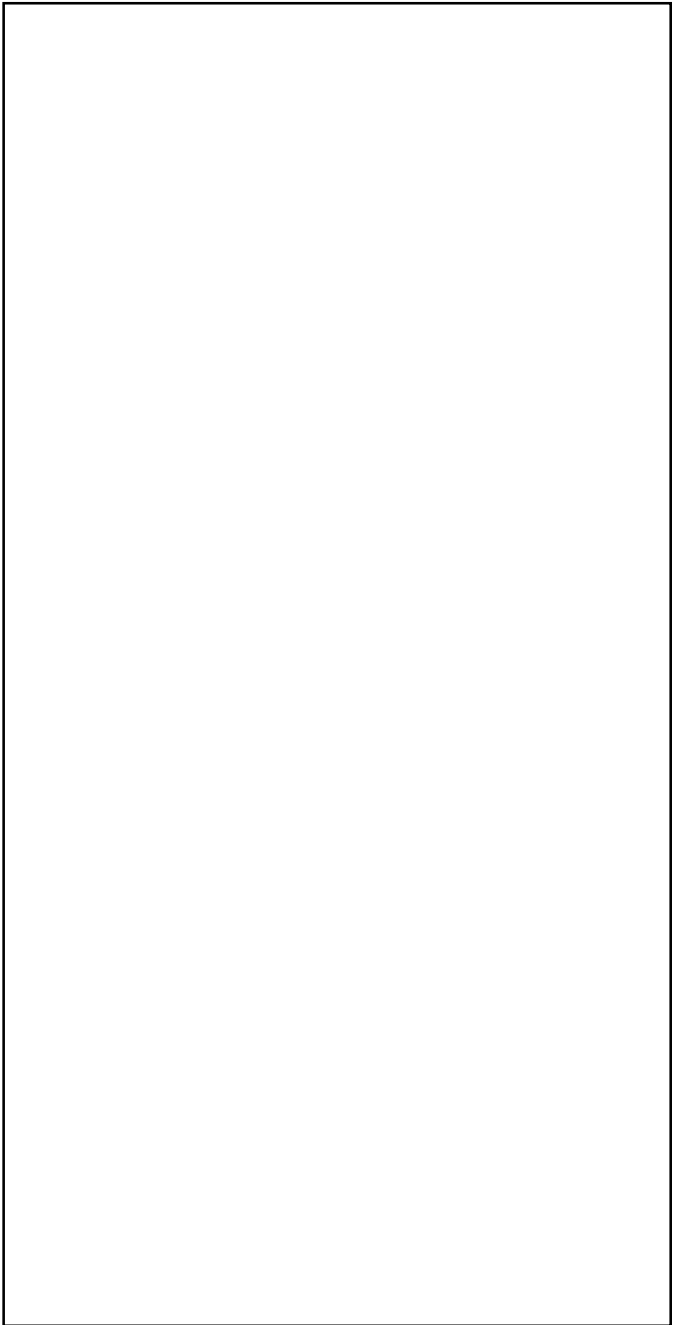

Quick-Glance

STARTER HANDLES & ROPE	PG.
STARTER	
Cord	602-603
Handles	603-606

STARTER HANDLES & ROPE



25

STARTER ROPE

Economy Starter Cord



- 200' Rolls**
Order No.
25 - 11722
25 - 11723
25 - 11724
25 - 11725
25 - 11726
25 - 11727
25 - 11728
25 - 11729
25 - 11730

- Red Tracer Starter Cord
- Economy Quality With Low Stretch Core
- Heavy Duty
- Stiffer, More Abrasion Resistant
- Wound on a plastic spool
- Made in Germany

- 1500' Rolls**
25 - 11731
25 - 11732
25 - 11733
25 - 11734

- Description**
No. 3 3/32" Dia.
No. 3-1/2 7/64" Weedeaters
No. 4 1/8" Dia.
No. 4-1/2 9/64" L/B & B&S
No. 5 5/32" Tec. & Clinton
No. 5-1/2 11/64" Dia.
No. 6 3/16" Dia.
No. 7 7/32" Dia. Honda
No. 8 1/4" large engines

- No. 3-1/2** 7/64" Weedeaters
No. 4 1/8" Dia.
No. 4-1/2 9/64" Dia.
No. 5 5/32" Dia.

Premium Starter Cord



- Order No.**
100' Rolls
25 - 11737
25 - 11738
25 - 11739
25 - 11740
25 - 11741
25 - 11742

- Rotary's New Premium 16 Carrier Smooth Braid Starter Rope.
- Twice the carriers of our other rope
 - Red tracer.
 - Smoother cycling.
 - Flexibility increased while maintaining firmness.
 - Wound on a plastic spool.
- Made in Germany

- 500' Rolls**
25 - 11743
25 - 11744
25 - 11745
25 - 11746
25 - 11747
25 - 11748

- Description**
No. 3-1/2 7/64" Dia.
No. 4 1/8" Dia.
No. 4-1/2 9/64" Dia.
No. 5 5/32" Dia.
No. 5-1/2 11/64" Dia.
No. 6 3/16" Dia.

No. 3-1/2 7/64" Dia.
No. 4 1/8" Dia.
No. 4-1/2 9/64" Dia.
No. 5 5/32" Dia.
No. 5-1/2 11/64" Dia.
No. 6 3/16" Dia.



STARTER HANDLES & ROPE

25
STARTER ROPE

- Red Braided Premium Starter Cord
- High Quality With Low Stretch Core
- Heavy Duty
- Stiffer, More Abrasion Resistant
- New Construction - Made From High Tenacity Nylon Cover With Tire Cord Core
- Made in U.S.A.



- 200' Rolls**
Order No.
25 - 5810
25 - 1300
25 - 1301
25 - 1302
25 - 1303
25 - 1304
25 - 1305
25 - 1313
25 - 1306

- 1500' Rolls**
25 - 10299
25 - 1308
25 - 1309
25 - 1310
25 - 1311
25 - 1312

- Description**
No. 3 3/32" Dia.
No. 3-1/2 7/64" Weedeaters
No. 4 1/8" Dia.
No. 4-1/2 9/64" L/B & B&S
No. 5 5/32" Tec. & Clinton
No. 5-1/2 11/64" Dia.
No. 6 3/16" Dia.
No. 7 7/32" Dia. Honda
No. 8 1/4" large engines

- No. 3-1/2** 7/64" Weedeaters
No. 4 1/8" Dia.
No. 4-1/2 9/64" Dia.
No. 5 5/32" Dia.
No. 5-1/2 11/64" Dia.
No. 6 3/16" Dia.

Starter Cord



- Order No.**
100' Rolls
25 - 9340
25 - 9341
25 - 9342
25 - 9343
25 - 9344
25 - 9345

- Description**
No. 3-1/2 7/64" Dia.
No. 4 1/8" Dia.
No. 4-1/2 9/64" Dia.
No. 5 5/32" Dia.
No. 5-1/2 11/64" Dia.
No. 6 3/16" Dia.

Rotary's New Performance Enhanced Premium 16 Carrier Smooth Braid Starter Rope.

- Twice the carriers of our other rope
- Red tracer.
- Twisted tire cord center core with torque tensioning for increased cycles.
- Smoother cycling.
- Flexibility increased while maintaining firmness.
- Wound on a plastic spool.

Made in the U.S.A.

- 500' Rolls**
25 - 9347
25 - 9348
25 - 9349
25 - 9350
25 - 9351
25 - 9352

- No. 3-1/2** 7/64" Dia.
No. 4 1/8" Dia.
No. 4-1/2 9/64" Dia.
No. 5 5/32" Dia.
No. 5-1/2 11/64" Dia.
No. 6 3/16" Dia.



Order No. 25 - 1320
 No. 5 rope & handle. Rope Length 42"

Order No. 25 - 1321
 No. 6 rope & handle. Rope Length 42".



Order No. 25 - 1317
 Plastic Handle.

STARTER HANDLES & ROPE



25

STARTER ROPE

Universal Handle



Order No. 25 - 1318

Universal Handle. This popular handle will work equally well as a replacement both on vertical pull Lawnmower engines and chain saws.

Universal Starter Handle



Order No. 25 - 12057

Universal plastic starter handle.

Starter Rope & Handle for WEEDEATER



Order No. 25 - 7307

Starter rope and handle. Replaces Weedeater 530-024451. Rope Length 24".

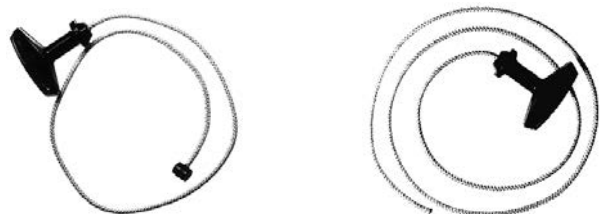

Order No. 25 - 4969

Molded Starter Handle and Rope for Poulan Micro 25 saws. Replaces 530-026791 & 530-023783 (with knob). Rope Length 21".

Order No. 25 - 4968

Molded Starter Handle and Rope for Poulan XR Trimmers. Replaces 26112 (without knob). Rope Length 35".

Starter Handle for HONDA



Order No. 25 - 10473

Starter handle replaces Honda 28461-ZL8-003. Fits models GCV135 / 160. Fits our 26-9985 recoil starter.

Starter Grip for BRIGGS & STRATTON



Order No. 25 - 10275

Starter grip replaces B&S 281434S.



Order No. 25 - 7723

Mitten style handle. Replaces Tecumseh 590574, B&S 398101, 695740 & John Deere PT10615.

Starter Handle for B&S



Order No. 25 - 7327

Large Rubber Handle. Replaces B&S 490652/66728. Handle for 8, 11, 12 hp engines.

Order No. 25 - 17327

Rubber Handle with 42" rope. Replaces B&S. (carded)

MIN005

Starter Handle for B&S



Order No. 25 - 1330

Small Rubber Handle. Replaces B&S 393152.

MIN010

Order No. 25 - 11330

Rubber Handle with 84" rope. Replaces B&S. (carded)

MIN005



STARTER HANDLES & ROPE

25
STARTER ROPE

Starter Handle for B&S



Order No. 25 - 2234
Rubber Handle. Replaces B&S 393152, 491288.

Starter Handle for ECHO



Order No. 25 - 2239
Replaces Echo 17722801110.

Starter Handle for LAWN-BOY



Order No. 25 - 2230
Starter Handle. Replaces Lawn-Boy 609477, 606863.

Starter Handle for HONDA (Large)



Order No. 25 - 9065
Starter handle replaces Honda 28461-ZE1-003, code 1428747. For large Honda engines.

Starter Handle for HONDA (Small)



Order No. 25 - 9114
Starter handle replaces Honda 28461-ZGO-004, code 4186425. Fits Honda G100. For small Honda engines.

Starter Handle for HONDA



Order No. 25 - 10871
Starter handle fits Honda models GX110, GX120, GX140, GX160.

Starter Handle for HUSQVARNA



Order No. 25 - 7290
Starter Handle. Replaces Husqvarna 50354-39-01, 5015514-02. Fits model 40 chain saw.

Starter Handle for STIHL



Order No. 25 - 7301
Starter Handle. Replaces Stihl 1121-195-3400. Fits models 09, 011, 024 and 026 chain saws.

Starter Handle with Rope for STIHL



Order No. 25 - 12541
Starter handle with rope replaces Stihl 0000 190 3400. 3.5mm rope, 43" length.



Order No. 25 - 13098
Starter handle with rope replaces Stihl 1122 190 3400. 4.5mm rope, 43" length.

STARTER HANDLES & ROPE



25

Starter Handle for
TANAKA



Order No. 25 - 7410

Starter Handle. Replaces Tanaka 785-51020-7900 & 785-10207-201. Fits models TBC 5000, TBC 232 and TLE 550 edgers.

Starter Handle for
TECUMSEH



Order No. 25 - 6780

Starter Handle. Replaces Tecumseh 590387.

STARTER ROPE



STARTERS & RECOIL SPRINGS

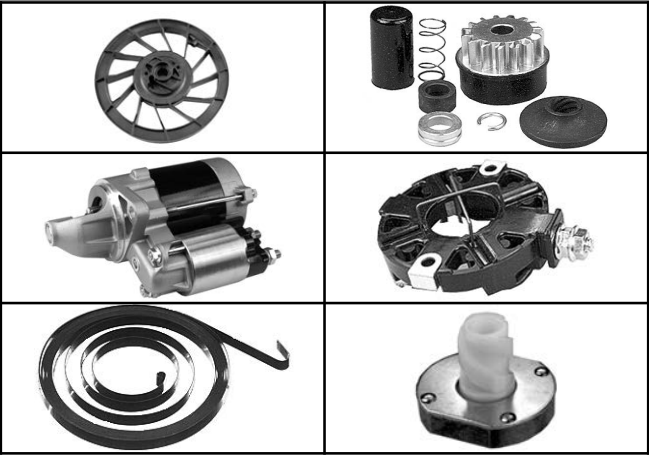

Quick-Glance

STARTERS & RECOIL SPRINGS PG.

STARTERS & RECOIL SPRINGS	PG.
Starter	
Bumper	608
Clutch	608
Pulley	608-610
Pawl	611
Electric Starters	612-620
Starter Kits	621-622
Recoil Assembly	622-626
Brush Set	628-629
Small Engine Starter Springs	629-632
Timmer Rewind Springs	633-634

STARTERS & RECOIL SPRINGS



B & S



Order No. 26 - 1338

Bumper clip replaces Briggs & Stratton 68618. Fits 3 and 3-1/2 hp engines. MIN010



Order No. 26 - 1339

Starter Bumper. Fits larger Briggs & Stratton recoils. Replaces B&S 68848. MIN010

Order No. 26 - 860

Starter Gear. Replaces B&S 280104S. 16 tooth. MIN010



Order No. 26 - 10860

Starter Gear. (carded) MIN005

Starter Pinion Gears



Order No. 26 - 2959

Replaces Lawn-Boy 609133. Fits "F" series engines. 3 spline. MIN010



Order No. 26 - 2241

Replaces Lawn-Boy 607547. Fits "C & D" series engines. 4 spline. MIN010



Order No. 26 - 852

Starter Gear Assembly. Replaces B&S 299948.



Order No. 26 - 1324

Starter Clutch Assembly. Replaces Briggs & Stratton 399671 and 298310.

OD 4-1/8"



Order No. 26 - 875

Starter Rewind Pulley. Replaces B&S 280439 & 280117. Fits many 2, 3, 3-1/2 and 4 hp.

OD 5-1/4"



Order No. 26 - 876

Starter Rewind Pulley. Replaces B&S 295871. Fits many 5, 7, 8 hp and larger.



Order No. 26 - 6673

Starter Pulley replaces Briggs & Stratton 490877. Fits 3-1/2 hp Quantum vertical pull engines.

Starter Pulley for B&S

OD 6-3/8"
ID 1/2"



Order No. 26 - 9507

Starter pulley replaces B&S 280918. Fits models 290400, 290700, 294700, 303400, 303700, 350400 & 350700. Fits 8 hp & up vanguard engines.

26
STARTERS/RECOILS



STARTERS & RECOIL SPRINGS

Starter Pulley Kit for B&S

OD 5-1/2"



Order No. 26 - 9488

Starter pulley kit replaces B&S 498144. Fits models 121600-699, 125800-899, 122600-699, 134400-499, 134200-299, 133200-299, 135400-499, 136200-299, 137200-299. Fits 5 hp & 6 hp vertical intrek engines. Comes with spring.



Order No. 26 - 8286

Starter pulley replaces B&S 493824 & 492832. For 5 hp vert. OHV Vanguard, 12CID Quantum. For models 99700, 121700, 121800, 123800, 124800, 126800, 122700 & 124700. Comes with our Spring 26-5876.

Starter Pulley Kit for BRIGGS & STRATTON



Order No. 26 - 12707

Starter pulley kit with spring replaces B&S 499901. Fits Sprint and Classic engines.

Recoil Starter Pulley for HONDA



Order No. 26 - 10867

Recoil starter pulley replaces Honda 28421-ZE2-W01. Fits models GX240 & GX270.



Order No. 26 - 10868

Recoil starter pulley replaces Honda 28421-ZE3-003. Fits models GX340 & GX390 newer style.



Order No. 26 - 10858

Recoil starter pulley replaces Honda 28420-ZH8-003. Fits models GX110, GX120, GX140, GX160.

Starter Pulley Repair Kit for HONDA



Order No. 26 - 9180

Starter pulley repair kit for Honda engines. For Honda models GX110, 120, 140 & 160. Replaces Honda 28422-ZH8-013 (ratchet), 28443-ZH8-003 (spring), 28441-ZH8-003 (washer), 28433-ZH8-003 (guide ratchet).



Order No. 26 - 12129

Recoil starter pulley replaces Honda 28421-ZH8-801 with 28442-ZH8-003 spring. Fits Honda GX120, GX160KI, GX200. Fits our 26-12079 recoil assembly.

Starter Pulley & Spring for HONDA



Order No. 26 - 13355

Starter pulley and spring replaces Honda 28415-ZG9-802. Fits model GXV140 & GXV160.

Starter Pulley for ECHO



Order No. 26 - 13532

Starter pulley replaces Echo 177215-43130. Fits models SRM3000, SRM3605, SRM4605, CLS 4600-4610.

Pulley & Spring Assembly for HONDA



Order No. 26 - 10465

Pulley and spring assembly fits Honda. Fits models GCV135 & 160. Used on our 26-9985 recoil starter.

26 STARTERS/RECOILS



STARTERS & RECOIL SPRINGS

**Rewind Pulley for
LAWN-BOY**



Order No. 26 - 7722

Starter rewind pulley replaces Lawn-Boy 610032. Fits mowers from 1972-1983.

**Starter Pulley for
KAWASAKI**



Order No. 26 - 9617

Starter pulley replaces Kawasaki 59101-2067. Fits model TD-40 trimmer. Also fits Shindaiwa T25, C25, C35 & CP25, Stihl models FS60, 61, 80 & 90.

**Starter Pulley for
RYAN**



Order No. 26 - 8288

Starter pulley replaces Ryan 683856. Fits models 265-1, 365-SSR, 284-3, 264-3. Fits K&S 706-16835, Ryobi 700, Lawn-Boy 1150, 1400CL, 1480.

**Starter Pulley for
SHINDAIWA**



Order No. 26 - 7930

Starter pulley replaces Shindaiwa 70030-75120. Fits models F20, T20, LT20, HT21 & C20. Fits Stihl 4215-19J-0400, Husky 531-0040-99-323-210 & Echo 177215-42030. Also fits Kawasaki 311901-34418.

Order No. 26 - 7927

Starter pulley replaces Shindaiwa 20000-75120. Fits models T25, C25, C35 & GP25. Fits Stihl 4112-195-040, models FS60-61-6J-66 & FS-80-90. Fits Green Machine 309849, models 3000SS. Fits Echo models SRM1501.

**Starter Gear Pinion for
TORO**



Order No. 26 - 13037

Starter gear pinion replaces Toro 28-9110. For 2-cycle snowthrower models S200 & S620. 16 tooth.

**Flywheel Ring Gear for
BRIGGS & STRATTON**



Order No. 26 - 10384

Flywheel ring gear replaces B&S 399676, 392134, 696537. Fits model 28 series engines.

**Starter Pulley for
HOMELITE**



Order No. 26 - 9045

Starter pulley replaces Homelite 98770-A. Fits models ST145, 155 & 175.

**Starter Rewind Pulley for
TECUMSEH**



Order No. 26 - 13100

Starter rewind pulley replaces Tecumseh 590413A.

**Starter Pulley for
TECUMSEH**



Order No. 26 - 13101

Starter pulley replaces Tecumseh 590618A, 29780011. For the latest version of Tecumseh engines.

**Pawl Friction Plate for
BRIGGS & STRATTON**



Order No. 26 - 10325

Pawl friction plate replaces B&S 692299.

26
STARTERS/RECOILS



**Starter Pawl for
BRIGGS & STRATTON**



Order No. 26 - 10324
Ratchet starter pawl replaces B&S 281505S.

MIN005

**Starter Pawl Assembly for
ECHO**



Order No. 26 - 12848
Starter pawl assembly replaces Echo 177218-42030. Includes pawl, spring, e-clip.

**Starter Pawl Assembly for
ECHO**



Order No. 26 - 13172
Starter pawl assembly replaces Echo A052000160. Also fits Stihl.

**Starter Pawl Assembly for
HONDA**

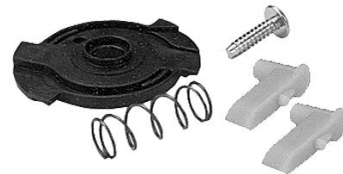

Order No. 26 - 10464
Starter pawl assembly for Honda. Fits models GCV135 / 160. Fits our recoil starter 26-9985.

**Pawl Assembly for
HONDA**



Order No. 26 - 10470
Pawl assembly for replaces Honda 28444-ZE2-W01. Fits models GX240, 270, 340, 390.

**Pawl Assembly for
HONDA**



Order No. 26 - 10472
Pawl assembly for replaces Honda 28434-ZE1-711. Fits models GX340, 390. Fits our 26-9998 Starter Assembly.

**Starter Pulley for
STIHL**



Order No. 26 - 9781
Starter pulley replaces Stihl 4130-195-0400. Fits FS36 trimmers.

**Starter Pawl for
STIHL**



Order No. 26 - 9780
Starter pawl replaces Stihl 4130-195-7200. Fits FS36 trimmers.



STARTERS & RECOIL SPRINGS

Starter Drive Repair Kit for B&S

Order No. 26 - 9854

Starter drive repair kit replaces B&S 497606 & 696541. Fits new style starters. Used on our 26-9796, 26-9797, 26-9798, 26-9799 starters.



Electric Starters for B&S



Order No. 26 - 9974

Electric starter replaces B&S 396306. 16 tooth gear.



Order No. 26 - 9796

Electric starter replaces B&S 497595. Fits single cylinder aluminum engines. 16 tooth gear.



Order No. 26 - 9798

Electric starter replaces B&S 497401. Heavy duty, fits single cylinder aluminum engines and some twin cylinder engines. 16 tooth gear.



Order No. 26 - 9797

Electric starter replaces B&S 497596. Fits most twin cylinder engines. 16 tooth gear.



Order No. 26 - 9799

Electric starter replaces B&S 498148. Heavy duty, fits most twin cylinder engines. 16 tooth gear.



Order No. 26 - 10709

Electric starter replaces B&S 691564 & 808106. Fits models 350000-380000 with steel flywheels.

Starter Drive Kit for BRIGGS & STRATTON

Order No. 26 - 10877

Starter drive kit replaces B&S 496881. Fits our 26-10709 starter. 15 tooth.



26
STARTERS/RECOILS



Order No. 26 - 13096

Electric starter replaces B&S 695479. Fits 20000 series engines. 12 volt, 14 tooth, CCW. Uses our 26-13114 starter gear.



Order No. 26 - 12954

Electric starter replaces B&S 693552. 12 volt, 14 tooth, CCW rotation, 16 & 18 hp engines, long case housing for steel ring gear. Heavy Duty version of our 26-12494. Uses our 26-13114 starter gear.



Order No. 26 - 12494

Electric starter replaces B&S 693551. Metal coating over plastic gear. Engines with steel flywheels. 14 tooth gear. Uses our 26-13114 starter gear.

Starter Gear for BRIGGS & STRATTON



Order No. 26 - 13114

Starter gear replaces B&S 693713. Fits models 220700-252799, 210700-312799 series engines. Metal 14 tooth starter gear with plastic inner for some starter motors. Does not replace 16 tooth plastic gear, the tooth pitch is different. Fits our 26-12494, 26-12954 & 26-13096 starters.

Electric Starter for GENERAC

Order No. 26 - 12432

Electric starter replaces Generac OE4271, OC3017, OE9323, 10455515. For Dixie Chopper. 8 tooth gear.



Electric Starter for HONDA

Order No. 26 - 10674

Electric starter replaces Honda 31210-ZE3-013. Fits model GX340. Solenoid included. 14 tooth

Order No. 26 - 12050

Solenoid replaces Honda 31204-ZA0-003. Used with our 26-10674 starter.



Order No. 26 - 11079

Electric starter replaces Honda 31200-ZJ1-004 / 31200-ZJ4-003. Fits GX610 & 620, GXV 610 & 620. 12 volt, ccw, 10 tooth.



STARTERS & RECOIL SPRINGS



26
STARTERS/RECOILS

Electric Starter for HONDA



Order No. 26 - 11489

Electric starter replaces Honda 31210-ZA1-003 & 31210-ZE8-801. Models GXV270, GXV340 & GXV390. CCW; 14-tooth. Fits EMS4000A, EMS4500A, Generators, ES4500K1A, EV4000A. G300 & G400K1 engines. HT3810SA & HT3810K1SA lawn tractors. 14 tooth



Order No. 26 - 11488

Electric starter replaces Honda 31210-ZE1-023. Used on 5.5 hp engines. 12-volt, 17-tooth, Models GX140 & GX 160..



Order No. 26 - 12065

Electric starter replaces Honda 31200-ZJ4-831. Used on models GXV610, 620 & 670 engines. 12 volt, cw, 12 tooth.



Order No. 26 - 12087

Electric starter replaces Honda 31200-ZJ1-841. Used on Honda GX610, 620, 670 engines. 12 volt, CW, 12 tooth.



Order No. 26 - 11490

Electric starter replaces Honda 31200-ZH9-003. Used on 9.9 hp engines. Models GX270. 12-volt, CW, 17-tooth.



Order No. 26 - 12481

Electric starter replaces Honda 31200-ZF-5-L32 & 31200-ZF5-L31. Fits models GXV 340 & GXV 390, 12-volt, CCW, 10 tooth.

Electric Starter for KAWASAKI



Order No. 26 - 10241

Electric starter replaces Kawasaki 21163-2077. Fits model FD590V-S05. 9 tooth.



Order No. 26 - 11487

Electric starter replaces Kawasaki 211632068. Fits FC290V, 87-96 John Deere 9hp engines. 12-volt, CCW, 9-tooth.



**Electric Starter for
KAWASAKI**



Order No. 26 - 12697

Electric starter replaces Kawasaki 21163-7003. Fits models FH451V engines, 12-volt, CCW, 10 tooth.



Order No. 26 - 10683

Electric starter replaces Kawasaki 21163-2101. Fits models FD501-FD661. 9 tooth.



Order No. 26 - 10806

Electric starter replaces Kawasaki 21163-2073A. Fits models FB460V - FC400V - 420V.



Order No. 26 - 10561

Electric starter replaces Kawasaki 21163-7010 & 21163-7001. Fits models FH451-FH721. 12 -volt, ccw, 10 tooth



Order No. 26 - 12254

Electric starter replaces Kawasaki 21163-2081 / 21163-2070. Fits FB460V engines. Used on JD 130 & 160 lawn tractor LX176, SX95. Also replaces JD AM107206. 12 volt, 9 tooth.



Order No. 26 - 12279

Electric starter replaces Kawasaki 21163-7014 & 21163-7002. Fits FH541V - FH721V. Also replaces John Deere AM133636.



Order No. 26 - 13473

Electric starter replaces Kawasaki 21163-7035, 21163-7024, 21163-7034. Fits FR391V-AS04 engines. Used on Cub Cadet zero-turn mowers. Also fits Husqvarna LGTH2454.



Order No. 26 - 13379

Electric starter replaces Kawasaki 21163-2051, 21163-2120, 21163-2130. Fits FD750D, John Deere AM132303/MIA10967. engines. Used on Cub Cadet & John Deere 23-27 hp engines.

STARTERS & RECOIL SPRINGS



Order No. 26 - 12430

Electric starter replaces Kawasaki 21163-2093 and John Deere AM108615. Fits FC540V.



Order No. 26 - 14378

Electric starter replaces Kawasaki 21163-7028, 21163-7020. Fits Kawasaki Mule 600, 610 (all 401cc engine) & John Deere (UTV) Gator TX (with Kawasaki 13 hp engine). Replaces OEM AM134946 & MIA11410. Fits 12 volt, 9 tooth, CCW rotation. Nippondenso style starter.

STARTERS/RECOILS
26

Electric Starter for KOHLER

Order No. 26 - 12281

Electric starter replaces Kohler 25-098-09S, 12-098-03, 24-098-01, 25-098-08. Fits models CH12.5S, 14S, 15S, 18S, 20S, 22S, 23S, 25S, 26S, 730S, 740S, 745S, LH685S, CV12.5S, 17S, 15S, 18S, 20S, 22S, 23S, 25S, 26S, 460S, 624S, 724S, 675S, 730S, 740S, 745S, LV675S & John Deere AM108390. Delco style starter.



Solenoid Starter for KOHLER

Order No. 26 - 13626

Solenoid starter replaces Kohler 25-435-04S. Fits our 26-12281 starter.



KOHLER Electric Starter



Order No. 26 - 2509811S

Kohler 2509811S OEM electric starter, solenoid shift. For Command Twin.



Order No. 26 - 5209811S

Kohler 5209811S OEM electric starter, bendix drive. For KT series.



Order No. 26 - 9977

Electric starter replaces Kohler 52-098-13-S. Fits M18, M20, MV20, KT19, KT21, K161 and K181. 9 tooth gear.



Order No. 26 - 5209813S

Kohler 5209813S OEM electric starter, bendix drive. For Magnum Vertical.



Electric Starters for KOHLER



Order No. 26 - 1209822S

Kohler 1209822S OEM electric starter, bendix drive. For Command single vertical engines.



Order No. 26 - 9976

Electric starter replaces Kohler 12-098-20 & 12 -098-22. Fits models CH 14, CV 11, 12.5, 13, 14, 15 & 16. Side Terminal. 13 tooth gear.



Order No. 26 - 10262

Electric starter replaces Kohler 25-098-09, 12-098-03, 25-098-09S & 24-098-01. Fits models CH12.5, 13, 14, 15, 18, 20, 22, 258, CV12.5, 15S, 16, 18, 20, 22, & 25. 9 tooth gear. Denso style starter.



Order No. 26 - 9997

Electric starter replaces Kohler 12-098-10 & 25-098-04, 25-098-07, 25-098-05. Fits models CV12.5 & CV14. 10 tooth gear.



Order No. 26 - 4109806S

Kohler 4109806S OEM electric starter, bendix drive. For magnum series.



Order No. 26 - 9800

Electric starter replaces Kohler 41-098-06. Fits M10, 14 & 16 series engines. 10 tooth gear.



Order No. 26 - 4509809S

Kohler 4509809S OEM electric starter, bendix drive. For K series singles (high mount).



Order No. 26 - 9802

Electric starter replaces Kohler 45-098-09. Fits K321 & K341, 14 & 16 hp engines, K301 12hp engines. 10 tooth gear. High mount style.

STARTERS & RECOIL SPRINGS



KOHLER Electric Starter



Order No. 26 - 4509810S

Kohler 4509810S OEM electric starter, bendix drive. For K series singles (low mount).



Order No. 26 - 9812

Electric starter replaces Kohler 45-098-10. Fits K341 16 hp engines. 10 tooth gear. Low mount style



Order No. 26 - 4809804S

Kohler 4809804S OEM electric starter, bendix drive. For K series, cast iron twins.



Order No. 26 - 9813

Electric starter replaces Kohler 48-098-04 & 48-098-02. Fits K482, K532 & K582; 18, 20 & 22 hp engines. 9 tooth gear.



Order No. 26 - 4109808S

Kohler 4109808S OEM electric starter, bendix drive. For K series.



Order No. 26 - 9801

Electric starter replaces Kohler 41-098-08. Fits K161 & K181, 6 & 8 hp engines. 16 tooth gear.



Order No. 26 - 1209821S

Kohler 1209821S OEM electric starter, bendix drive. For Command single horizontal engines.



Order No. 26 - 9975

Electric starter replaces Kohler 12-098-19 & 12-098-21. Fits models CH 11, 12.5, 13, 14, 15 & CV15. Rear Terminal. 13 tooth gear.

26
STARTERS/RECOILS



KOHLER Electric Starter



Order No. 26 - 5209812S

Kohler 5209812S OEM electric starter, bendix drive. For KT series, Magnum twins.



Order No. 26 - 9814

Electric starter replaces Kohler 52-098-12. Fits models MV16 & MV18; 16 & 18 hp twin cylinder engines. 9 tooth gear.



Order No. 26 - 12709

Electric starter replaces Kohler 20-098-05S & 20-098-01S. Fits Courage Single.



Order No. 26 - 2509807S

Kohler 2509807S OEM electric starter, bendix drive. For Command twin engines.



Order No. 26 - 3209804S

Kohler 3209804S OEM electric starter, bendix drive. For Courage twins.



Order No. 26 - 12710

Electric starter replaces Kohler 32-098-01S. Fits Courage V-Twin.

Starter Solenoid for KOHLER & KAWASAKI



Order No. 26 - 12130

Starter solenoid replaces Kohler 52-435-02S. Fits our 26-10262. Also replaces Kawasaki 27010-2122. Fits our 26-10241, 26-10683 & 26-10806 & 26-12430.

STARTERS & RECOIL SPRINGS



Electric Starter for KUBOTA



Order No. 26 - 14551

Electric starter replaces Kubota 1G069-63010. Fits models ZD28, ZD331, mowers. D1105 Diesel engines. Nippondenso style starter.

Starter Drive Gear Kit for TECUMSEH



Starter Drive Gear for TECUMSEH



Order No. 26 - 13338

Starter drive gear replaces Tecumseh 33844. Fits models HH100, HH120, HH80, OH140, OH160. 11 teeth. Fits our 26-9990 starter.

Order No. 26 - 13336

Starter drive gear kit replaces Tecumseh 36853. Fits our 26-9980 & 26-9981 starters. Includes 10 Teeth gear, nut and retaining ring. Fits Tecumseh starters 36795, 37425, 36914 & 37284.

Electric Starters for TECUMSEH



Order No. 26 - 9980

Electric starter replaces Tecumseh 36795. Fits models OHV 135-17. 10 tooth gear.

Order No. 26 - 9990

Electric starter replaces Tecumseh 33835. Fits OH120, 140, 160 and 180. 11 tooth gear.



Order No. 26 - 9979

Electric starter replaces Tecumseh 36680, 35763. Fits models TVM, TVXL170-220, OVM, OVXL 120, HM70-100, OVXL 125, OHV13. 16 tooth gear.



Order No. 26 - 9981

Electric starter replaces Tecumseh 36914, 37425. Fits models OH50, OHH50, OHV110-135. 10 tooth gear.

Order No. 26 - 10364

Starter shoulder screw for Tecumseh. Used to mount newer style starter. Fits our 26-9981 starter. MIN012

Order No. 26 - 14511

Electric starter replaces Tecumseh 37284. Used on OV691EA, EP, TVT691, VTX691 engines, 12 volt.



26
STARTERS/RECOILS



**Electric Starter Kit for
TECUMSEH**



Order No. 26 - 10975

Electric starter kit replaces Tecumseh 33290E, 33290D and Ariens 72200600. Fits models HSSK40-50, H30-35 and HSK35. 120 Volt, includes switch, hardware, extension cord and instruction sheet.

**Hardware Kit for
TECUMSEH**



Order No. 26 - 12701

Hardware kit for our 26-10975 Starter.

**Electric Starter Kit for
TECUMSEH**



Order No. 26 - 10976

Electric starter kit replaces Tecumseh 33228D and Ariens 72403500. Fits models H50-70, TVM125 & 140. For 7 hp Snow King Engines. 120 Volt, includes starter, starter button, extension cord and hardware.

**Hardware Kit for
TECUMSEH**



Order No. 26 - 12702

Hardware kit for our 26-10976 Starter.

**Electric Starter Kit for
TECUMSEH**



Order No. 26 - 10982

Electric starter kit replaces Tecumseh 33329D / 33329E and Ariens 72403600. Fits models HMSK70-100, TVM170-220 and HM70-100. For 8, 10 & 12 hp Snow King Engines. Includes starter, starter button, extension cord and hardware.

**Hardware Kit for
TECUMSEH**



Order No. 26 - 12274

Hardware kit for our 26-10982 Starter.

**Starter Extension Cord for
TECUMSEH**



Order No. 26 - 13643

Starter extension cord replaces Tecumseh 32450B, Ariens 2483100, MTD 629-0071, 939-0071, Murray 6219MA. Included in our 26-10975, 26-10976, 26-10982 starters.

STARTERS & RECOIL SPRINGS



**Starter Pawl Kit for
BRIGGS & STRATTON**



Order No. 26 - 13587

Starter pawl kit replaces B&S 281503, 281505, 692299, 492333. Fits our **26-12368 & 26-12329** recoil assembly. Includes 2 pawls, friction plate, screw, 2-springs, spring ring retainer.

**Recoil Starter Assembly for
BRIGGS & STRATTON**



Order No. 26 - 10385

Recoil starter assembly replaces B&S 497598. Fits Quantum & Europa series engines.



Order No. 26 - 12368

Recoil starter replaces B&S 497680. Fits models 099772 series vertical shaft engines.



Order No. 26 - 12330

Recoil starter assembly replaces B&S 693900. Fits 192404 - 192432 & 19E400 series.



Order No. 26 - 12329

Recoil starter assembly replaces B&S 497830, 494782, 494846, 495766 & 496650.

Order No. 26 - 13252

Recoil starter spring replaces B&S 499706. Fits Quattro series 0912120-0989820, 09B9000-10T812.



**Starter Recoil Assembly for
ECHO**



Order No. 26 - 13609

Starter recoil assembly replaces Echo 17720055931. Fits models SMR-230, 231, PE-260, 2601.

**Starter Recoil Assembly for
ECHO**



Order No. 26 - 13610

Starter recoil assembly replaces Echo A051000201, USE A051000840. Fits PB-650T & PB-651H & PB-751.

26
STARTERS/RECOILS



STARTERS & RECOIL SPRINGS

Recoil Starter Assembly for HONDA



Order No. 26 - 9063

Starter spring replaces Honda 28400-883-040ZB, code 3488467. Fits Honda G150 & G200 engines. 1 metal pawl.

Recoil for HONDA



Order No. 26 - 9064

Recoil replaces Honda 28400-ZE1-003ZA, code 3373768. Fits Honda series GX110, GX120, GX140, X160. 2 plastic pawls.



Order No. 26 - 10379

Recoil starter assembly replaces Honda 28400-ZE3-W01ZA. Fits newer style model GX340 & GX390. 2 metal pawls.



Order No. 26 - 10466

Recoil starter assembly replaces Honda 28400-ZM3-003. Fits GX22/3, 1B/C, 22/31CC, Zenoah G34/160.

Recoil Repair Kit for HONDA



Order No. 26 - 12221

Recoil repair kit for Honda. Fits Honda GX120, GX160K1, GX200. Fits our 26-12079.

Recoil Starter Assembly for HONDA



Order No. 26 - 12079

Recoil starter assembly replaces Honda 28400-ZH8-023YA. Fits GX120, GX160K1, GX200. 2 metal pawls



Order No. 26 - 14643

Starter recoil assembly replaces Honda 28400-ZOL-V20ZA. Fits models GXV135 & GCV160. Similar to our 26-9985, but with 82" of rope. Black



Order No. 26 - 9985

Starter recoil assembly replaces Honda 28400-ZM0-003, code 6061204. Fits GC 130/160, GCV 130/160. 55" Rope.

26 STARTERS/RECOILS

STARTERS & RECOIL SPRINGS



Order No. 26 - 10469

Recoil starter assembly replaces Honda 28400-ZE2-W01ZA. Fits GX240, 270 & K1. 2 metal pawls



Order No. 26 - 9998

Starter recoil assembly replaces Honda 28400-ZE8-8113A, code 3417292. Fits GX 340. 1 metal pawl.

26
STARTERS/RECOILS

Recoil Starter Assembly for HONDA



Order No. 26 - 12019

Recoil starter assembly replaces Honda 28400-ZG9-803, 28400-ZG9-802. Fits GXV140 & GXV160.

Starter Recoil Assembly for RED MAX



Order No. 26 - 14656

Starter recoil assembly replaces Red Max 521342701, Husqvarna 4810-75100. Fits models BCZ2500, 2600, 2601, 2610, 2650, 2660, EXZ2500, HBZ2500, 2600, 2601, 2610, HEZ2500, 2601, 2602, 2610, 2650, LRTZ2500, PSZ2500, RMNBZ2500, 2601, RMSZ2500, 2601.

Starter Recoil Assembly for SHINDAIWA



Order No. 26 - 13528

Starter recoil assembly replaces Shindaiwa A051001520 / 68206-75010. Fits Red Max Blowers Zehoah T4030-75100, EB4300, EB431, EB4400, EB4401, EB441, EB6200, EB7000, EB7000RH, EB7001, EB7001RH, EBZ4800, EBZ4800RH, EBZ5000, EBZ5000Q, EBZ5100, EBZ5100-CA, EBZ5100RH, EBZ5100Rh-CA.

Starter Recoil Assembly for STIHL



Order No. 26 - 14340

Starter recoil assembly replaces Stihl 4137-190-4000. Fits FS75-FS85, BG, FC, FS, HL, HT, KM, 70, 75, 80, 85. Fits Stihl blowers, edger, string trimmer, hedge trimmer, pole pruner, Kombi & Harvester models.



STARTERS & RECOIL SPRINGS

Starter Recoil Assembly for STIHL



Order No. 26 - 13582

Starter recoil assembly replaces Stihl 4180-190-4000. Fits models KM90, KM100, KM110, KM130, FS90, FS100, FS110, FS130, FC90, FC100, FC110, FC130.

Recoil Assembly for STIHL



Order No. 26 - 13562

Recoil assembly replaces Stihl 1125-080-2105. Fits models FS034, 034 AV 036, MS340, MS360.

Recoil Assembly for STIHL



Order No. 26 - 13561

Recoil assembly replaces Stihl 1128-080-2104. Fits models 044, 046, MS440 and MS460.

Recoil Assembly for STIHL



Order No. 26 - 13560

Recoil assembly replaces Stihl 1122-080-2110. Fits models 066, MS650, MS660.

Recoil Assembly for STIHL



Order No. 26 - 13612

Recoil assembly replaces Stihl 1127-080-2103/1127-080-2103A. Fits models 029, 031, 039, MS290, MS310, MS390 Chain saws.

Recoil Assembly for STIHL



Order No. 26 - 13591

Recoil assembly replaces Stihl 4238-190-0301, 4238-190-0300 & 4238-190-0402B. Fits models TS410/TS420 Cut off saws.

Recoil Assembly for STIHL



Order No. 26 - 13529

Recoil assembly replaces Stihl 4282-190-0300A. Fits models BR500, BR550, BR600.

Starter Recoil Assembly for STIHL



Order No. 26 - 13580

Starter recoil assembly replaces Stihl 4203-190-0405. Fits models BR320, BR340, BR380, BR400, BR420 blowers.

26 STARTERS/RECOILS

STARTERS & RECOIL SPRINGS



Starter Recoil Assembly for STIHL



Order No. 26 - 13628

Starter recoil assembly replaces Stihl 4223-190-0401. Fits model TS400 Cutquick cut off saws.

Recoil Starter for TECUMSEH



Order No. 26 - 12654

Recoil starter assembly Tecumseh 590742. Fits models HSSK50 & HSK70.



Order No. 26 - 12655

Recoil starter assembly Tecumseh 590739. Fits models LV195EA, LEV80, LEV115, LEV120.



Order No. 26 - 12656

Recoil starter assembly Tecumseh 590746, 590748, 590748A. Fits models OHH65, OHH60, HM100.



Order No. 26 - 12657

Recoil starter assembly Tecumseh 590749, 590749A, 590789. Fits models HMSK105.

STARTER FOR TECUMSEH



Order No. 26 - 1325

Starter replaces Tecumseh 590706, 590420A. Fits IV-LAV-H-22 thru H-40 models. Made in U.S.A. Also used on many Clinton engines. Fits TVS, HS40, 638, 650, 670. 4" bolt center.

Starter Recoil Assembly for TECUMSEH



Order No. 26 - 10983

Starter recoil assembly replaces Tecumseh 590785, 590694, 590737, 590686, 590621. For small and medium frame EZ pull starts. Fits ECV series (Sears), TVS, Series 90 thru 120, 1990 production and newer, H30-70 and HS40-50 models.

26
STARTERS/RECOILS



Starter Drive Kit for B&S



Order No. 26 - 8498

Starter drive kit replaces B&S 495878 & 696540. Fits all electric start units (old style B&S starters).

Spring Kit for Starter Drive



Order No. 26 - 9362

Spring kit for starter drive replaces B&S 495877. Spring kit for our 26-8498.

Starter Drive Clutch for B&S



Order No. 26 - 9363

Starter drive clutch replaces B&S 398003. Starter drive clutch for our 26-8498.

Retainer Cover for B&S



Order No. 26 - 8637

Retainer cover for our 26-8498 starter drive kit.

MIN010

Starter Gear Retaining Ring for BRIGGS & STRATTON



Order No. 26 - 10233

Starter gear retaining ring replaces B&S 691265. MIN010

Starter Drive Kit for TECUMSEH



Order No. 26 - 12726

Starter drive kit replaces Tecumseh 37052A & 37050. Fits our 26-10982 & 26-9979 starter. 16 Tooth.

STARTERS & RECOIL SPRINGS



LAWN-BOY



Order No. 26 - 2240

Retainer clip replaces Lawn-Boy 604260 fits D series.

MIN010

Starter Dog Spring for TORO



Order No. 26 - 8769

Starter dog spring replaces Toro 81-1220. Fits 21" Toro walk-behind mowers.

MIN010

26
STARTERS/RECOILS



Order No. 26 - 2957

Retainer clip replaces Lawn-Boy 609229 fits F series.

MIN010

Brush Set for B&S

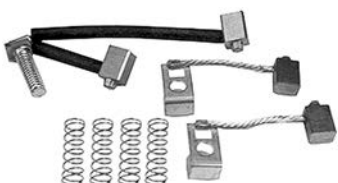

Order No. 26 - 10084

Brush set replaces B&S 497608. Fits B&S electric starters with "C" clip starter gear retainer. Spring Included.

Order No. 26 - 10085

Brush set replaces 490311. Fits B&S electric starters with roll pin starter gear retainer. (no springs)

Brush & Spring Kit for KOHLER



Order No. 26 - 9219

Brush & Spring Kit replaces Kohler 82755-28. Same as our 26-9218 without bushings.

Brush & Spring Kit for KOHLER



Order No. 26 - 9218

Brush & spring kit replaces Kohler 82755-28. Same as our 26-9219 with bushings.

Starter End Cap for TECUMSEH



Order No. 26 - 11022

Starter end cap replaces Tecumseh 37442, 36959, 35899. Fits models OHV110, OHV125 & OHV130. Includes brushes and bearings.



STARTERS & RECOIL SPRINGS

**Brush Assembly Card for
TECUMSEH**



Order No. 26 - 9220

Brush assembly card replaces Tecumseh 33848. Fits electric starters.

Order No. 26 - 9221

Brush assembly card replaces Tecumseh 33712. Fits electric starters.

**Starter Brush Retainer for
BRIGGS & STRATTON**

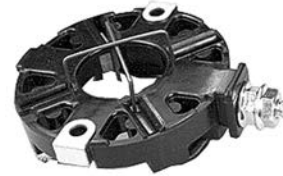

Order No. 26 - 10562

Starter brush retainer replaces B&S 691293 & 497605. Fits B&S starters.

**Brush Holder Cap End for
B&S**



Order No. 26 - 9353

Brush holder cap end replaces B&S 395537. Fits B&S electric starters.

**Brush & Bushing Set for
B&S**



Order No. 26 - 9354

Brush & bushing kit replaces B&S 395538. Fits B&S electric starters.

26 STARTERS/RECOILS

Small Engine Replacement Starter Springs

BRIGGS & STRATTON		
Order No.	OEM No.	Model Number
26 - 5876	491889	99700, 121700, 121800, 123800, 124800, 126800, 122700 & 124700, Magnum engines.
26 - 1326	490179 294303	60000, 80000, 81000, 82000, 92000, 93000, 100000, 111000, 130000, 131000, 146000, 147000, 170000, 171000, 190000, 191700, 195000, 220000, (Top mount side pull) .
26 - 1327	390066	94500, 94900, 110900 (Vertical pull starter).
TECUMSEH		
26 - 9534	590562	TC, TCH200 & 300, 2 cycle.
26 - 1329	590414	LAV35-50, V50-70, TVS, H35-70, 635, 650, 670.
26 - 1334	590433	LAV, ECV, TNT, Vertical Pull Starter.
26 - 2430	590487	HM 70-80, 100, V, VM, H.

See pages 631 and 632 for Illustrations.

STARTERS & RECOIL SPRINGS



Small Engine Replacement Starter Springs

26
STARTERS/RECOILS

Order No.	OEM No.	Model Number
CLINTON		
26 - 1329	265-278-500	400, 401, 404, 407, 410, 412, 415, 419, 492, 494, 498, 499 500, 501, 502, 503, K-201, 350, 505, 751, 752, 753, 900.
HONDA		
26 - 9505	28442-ZE6-003	GX100QE, GV100K1
26 - 9526	28442-ZE1-003	GX110, GX140, GX160 Single ratchet (before 1995).
26 - 9527	28442-ZH8-003	GX120, GX160, GX100 Twin ratchet (after 1995).
26 - 9528	28442-ZE1-713 28442-ZE1-711	GX240, GX340 Single ratchet (before 1995).
26 - 2421	28442-896-700 (093310)	HRC 216 HR17 PDAM.
26 - 2422 1600-	28442-883-000 (063667)	HR21, PDAM, HR21, SXAM, HR21-5 SDAM, HRA21 SDA, HRA21 SDAW, F500A1, F500A2, FR500, FR700, EM- 3000, WA20, WA30, HS35-50, SDAM/AW.
26 - 2424	28447-878-810 (044186)	Honda F400AZ.
LAWN-BOY		
26 - 1333	604257	D & F Series (Narrow).
26 - 2463	683210	1984 and 85 F Models (Wide)

See pages 631 and 632 for Illustrations.



STARTERS & RECOIL SPRINGS



Order No. 26-1326
Order No. 40-11326
(carded)



Side Pull



Order No. 26-1327
Order No. 40-11327
(carded)



Vert. Pull



Order No. 26-1329

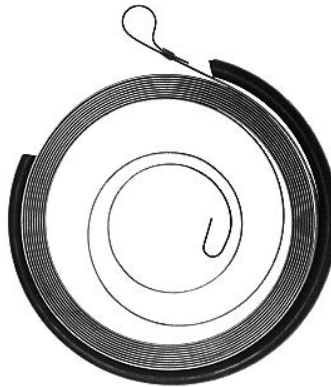

Order No. 26-1331



Order No. 26-1332



Order No. 40-11333
(carded) **Order No. 26-1333**

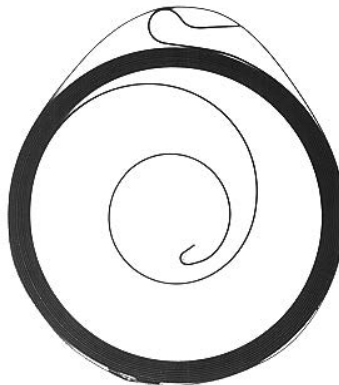

Order No. 26-1334



Order No. 26-2420

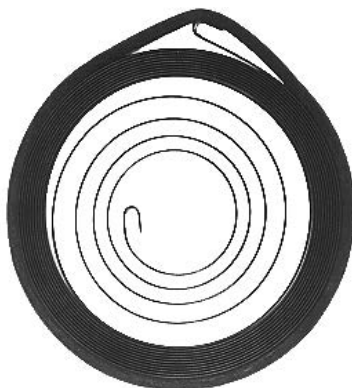

Order No. 26-2421

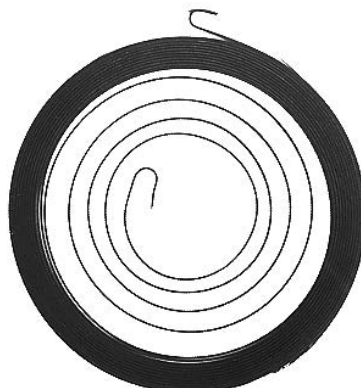

Order No. 26-2422



Order No. 26-2423

26 STARTERS/RECOILS

STARTERS & RECOIL SPRINGS



Order No. 26-2424



Order No. 26-2430



Order No. 26-2431



Order No. 26-2432



Order No. 26-2433

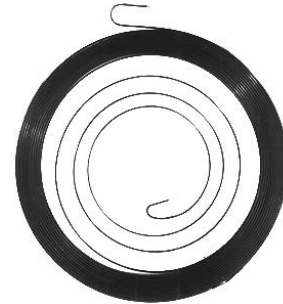

Order No. 26-2460



Order No. 26-5876

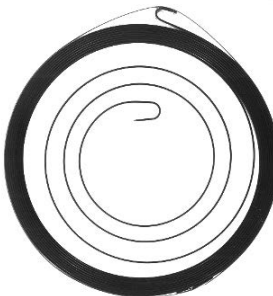

Order No. 26-2462



Order No. 26-2463



Order No. 26-9527

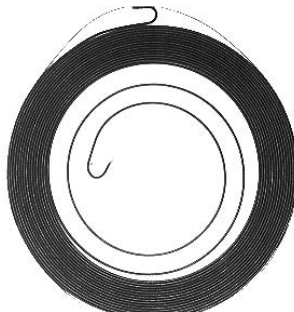

Order No. 26-9505

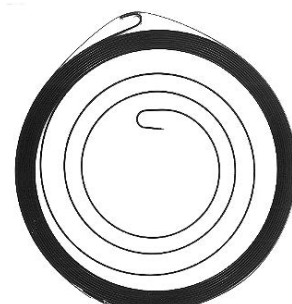

Order No. 26-9526

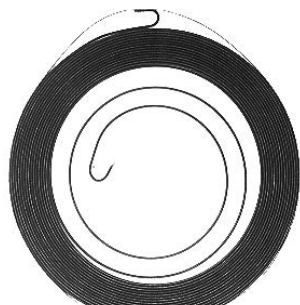

Order No. 26-9528



Order No. 26-9534

STARTERS/RECOILS 26

For application see page 629 and 630



STARTERS & RECOIL SPRINGS



String Trimmer

Rewind Springs

Order No.	OEM	Replaces	Model Number
37 - 3010	Echo	177220 0653 0	KE140, 200, GT140, 160, 200, F-2/1, 2/2, 2/3, S2A/1, 2A/2, SRM140, SRM210AE.
37 - 3003	Echo	177220 0393 0	SRM200, 202, 302, 400.
26 - 8071	Echo	177220-4203-0	GT1100, GT2102, GT2103, SRM1501, SRM2301, SRM2310, SRM2400, Trimmers and Brushcutters. also fits PB1000 Blowers
26 - 8072	Echo	177220-4063-0	Echo CLS4600, SRM2200, SRM2201, SRM2501, SRM2502, SRM3000, SRM3001, SRM3800 Trimmers & Brushcutters.
26 - 2444	Green Machine	300285	3000, 3100, 2000, 2500, (...201446).
37 - 3010	Hoffco	207575	GT14B, 14T, WT14H, FT215T, 215B, JP215, WT215HB.
26 - 2444	Hoffco	206073	215B, JP215, WT215HB, PC225, GT225, GT320, B, T, H, JP420.
26 - 13584	Husqvarna	537-09-31-01	340, 345, 346, 350,351, 353,357, 359, Jonsered models CS2141, CS2145, CS2150.
26 - 13533	Husqvarna	503-85-99-01	Fits models 333,335, 340, 345, 346, 350, 351, 3536.
26 - 2444	Kawasaki	717196	KT18.
37 - 3010	McCulloch	213867 300474 217482	MAC 60, 70, 80, 95.
26 - 13051	Robin	270-50115-08	Fits EX13, EX17, EX21
26 - 12914	Stihl	4133-195-1600	Fits models FS72, FS74, FS7 trimmers HS72, HS74, HS76 hedge trimmers, FC72 edgers, BG72, BG75 blowers.
26 - 2445	Stihl	1117-190-0601	New FS008, FS-410, 410AV FS410AVE (5816400...), New 070, 08, 510, TS 350.
37 - 3026	Stihl	1111-195-1600	FS08, FS410, 410AVE (...5816400).
26 - 2444	Stihl	4112-195-1600	FS-60, 61E, 65AVE, 80, 80E, 90AVE.
37 - 3024	Stihl	1114-190-0600	FS-150, 151, 200AV, 200AVSE.
26 - 8069	Stihl	4126-195-1600	FS48, FS52, FS56, FS66, FS62, FS86, FS106 Trimmers & Brushcutters.
26 - 13581	Stihl	4130-195-1600	FS36, FS40, FS44, FC75 edgers. Ryobi 610302, McCullough 83078.
26 - 2438	Tanaka (TAS)	779-00601-204	THT232, TBC232, TBC233.
26 - 2444	Shindaiwa	20000-75140	T25, C25, C35.

STARTERS & RECOIL SPRINGS



String Trimmer

Rewind Springs

Order No.	OEM	Replaces	Model Number
37 - 3010	Toro	34-7900	600, 700, 1700, ENGINES 14CC.
37 - 3003	Weedeater	6975-00 91543	600, 607, 608, 609, 698, K3AW, KEH, 202D, K3W.
37 - 3010	Weedeater	9168-01 91868	599, 609, ENGINE G1.
26 - 1329	Weedeater	590414	650, 657, 670.
26 - 2436	Weedeater	42067	2XR20-XR95, 1500, 1700, PRO150, PRO200, 4000-6500.

STARTERS/RECOILS 26



TRIMMER /BRUSHCUTTER/BLOWER ACC.



Quick-Glance

TRIMMER/BRUSHCUTTER/BLOWER PG.

Trimmer	
Line	637-639
Heads	639-646
Arbor Bolts	647
Brushcutter Blades	648-649
Trimmer Head Appl. Chart	650-654
Trimmer Harnesses	655-656
Trimmer Fuel Caps	657
Trimmer Fuel Line	658-659
Clutch	659-660
Shields	660-661
Blower Hose	661

TRIMMER /BRUSHCUTTER/BLOWER ACC.



RED COMMERCIAL TRIMMER LINE

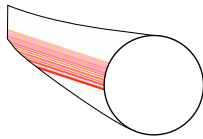

Order

No.	Size/Minimum Length
40' Loop (12 per case)	
27 - 12101	.065 x 50' Loop
27 - 12102	.080 x 50' Loop
27 - 17090	.095 x 40' Loop
27 - 12103	.105 x 30' Loop
27 - 12104	.130 x 25' Loop
1/2 Pound Donut (12 per case)	
27 - 5921	.065 x 300' (91.4 meters)
27 - 5922	.080 x 200' (61 meters)
27 - 5923	.095 x 140' (42.7 meters)
27 - 5924	.105 x 110' (35.1 meters)
27 - 5925	.130 x 75' (22.9 meters)
1 Pound Donut (12 per case)	
27 - 5928	.080 x 400' (121.9 meters)
27 - 5927	.095 x 280' (85.3 meters)
27 - 5930	.105 x 230' (70.1 meters)
27 - 5929	.130 x 150' (45.7 meters)
27 - 12105	.155 x 105' (27.3 meters)

Order

No.	Size/Minimum Length
1 Pound Spool (12 per case)	
27 - 3518	.080 x 400' (121.9 meters)
27 - 3519	.095 x 280' (85.3 meters)
27 - 3520	.105 x 230' (70.1 meters)
27 - 3521	.130 x 150' (45.7 meters)
27 - 6530	.155 x 99' (30.2 meters)
3 Pound Spool (9 per case)	
27 - 3505	.080 x 1200' (365.8 meters)
27 - 3509	.095 x 840' (256 meters)
27 - 3510	.105 x 690' (210.3 meters)
27 - 3515	.130 x 450' (137.2 meters)
27 - 9332	.155 x 300' (91.4 meters)
5 Pound Spool (6 per case)	
27 - 1344	.080 x 2000' (609.6 meters)
27 - 1337	.095 x 1400' (426.7 meters)
27 - 3513	.105 x 1150' (350.5 meters)
27 - 1368	.130 x 750' (288.6 meters)
27 - 9157	.155 x 500' (152.3 meters)

27 TRIMMER & ACCE.

ORANGE DIAMOND CUT PROFESSIONAL TRIMMER LINE

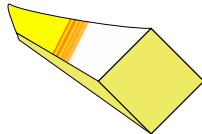

Order

No.	Size/Minimum Length
Loops (12 per case)	
27 - 12131	.080 x 50' Loop
27 - 12132	.095 x 40' Loop
27 - 12133	.105 x 30' Loop
27 - 12134	.130 x 25' Loop
1/2 Pound Donut (12 per case)	
27 - 12135	.080 x 180' (54.9 meters)
27 - 12136	.095 x 120' (36.6 meters)
27 - 12137	.105 x 100' (30.5 meters)
27 - 12138	.130 x 66' (20 meters)
1 Pound Donut (12 per case)	
27 - 12139	.080 x 355' (108.2 meters)
27 - 12140	.095 x 250' (76.2 meters)
27 - 12141	.105 x 205' (62.5 meters)
27 - 12142	.130 x 135' (41.2 meters)
27 - 12143	.155 x 95' (29 meters)

Order

No.	Size/Minimum Length
1 Pound Spool (12 per case)	
27 - 12144	.080 x 355' (108.2 meters)
27 - 12145	.095 x 250' (76.2 meters)
27 - 12146	.105 x 205' (62.5 meters)
27 - 12147	.130 x 135' (41.2 meters)
27 - 12148	.155 x 95' (29 meters)
3 Pound Spool (9 per case)	
27 - 12149	.080 x 1065' (324.7 meters)
27 - 12150	.095 x 755' (230.2 meters)
27 - 12151	.105 x 620' (189 meters)
27 - 12152	.130 x 400' (122 meters)
27 - 12153	.155 x 285' (86.9 meters)
27 - 9960	.170 x 249' (75.9 meters)
5 Pound Spool (6 per case)	
27 - 12154	.080 x 1780' (542.7 meters)
27 - 12155	.095 x 1260' (384.1 meters)
27 - 12156	.105 x 1035' (315.5 meters)
27 - 12157	.130 x 670' (204.3 meters)
27 - 10315	.155 x 475' (144.8 meters)



WE PUT A NEW TWIST ON TRIMMER LINE.



GREEN PREMIUM QUAD TRIMMER LINE

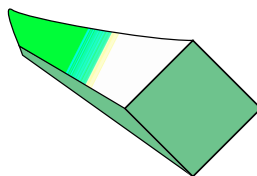

Order

No.	Size/Minimum Length
Loops (12 per case)	
27 - 12184	.080 x 45' Loop
27 - 12185	.095 x 36' Loop
27 - 12186	.105 x 27' Loop
27 - 12187	.130 x 22' Loop
Large Donut (12 per case)	
27 - 12188	.080 x 360' (109 meters)
27 - 12189	.095 x 256' (78 meters)
27 - 12190	.105 x 207' (63 meters)
27 - 12191	.130 x 135' (41 meters)

Order

No.	Size/Minimum Length
Medium Spool (9 per case)	
27 - 12192	.080 x 1080' (329 meters)
27 - 12193	.095 x 769' (234 meters)
27 - 12194	.105 x 621' (189 meters)
27 - 12195	.130 x 405' (123 meters)
Large Spool (6 per case)	
27 - 12196	.080 x 1800' (548 meters)
27 - 12197	.095 x 1285' (391 meters)
27 - 12198	.105 x 1035' (315 meters)
27 - 12199	.130 x 675' (205 meters)

GREEN PREMIUM QUAD-TEX TRIMMER LINE

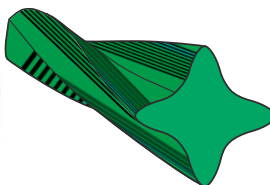

Order

No.	Size/Minimum Length
Loops (12 per case)	
27 - 12200	.080 x 40' Loop
27 - 12201	.095 x 32' Loop
27 - 12202	.105 x 24' Loop
27 - 12203	.130 x 20' Loop
Large Donut (12 per case)	
27 - 12204	.080 x 320' (97.meters)
27 - 12205	.095 x 230' (70 meters)
27 - 12206	.105 x 185' (56 meters)
27 - 12207	.130 x 120' (36 meters)

Order

No.	Size/Minimum Length
Medium Spool (9 per case)	
27 - 12208	.080 x 960' (292 meters)
27 - 12209	.095 x 685' (208 meters)
27 - 12210	.105 x 550' (167 meters)
27 - 12211	.130 x 360' (109 meters)
Large Spool (6 per case)	
27 - 12212	.080 x 1600' (487 meters)
27 - 12213	.095 x 1140' (347 meters)
27 - 12214	.105 x 920' (280 meters)
27 - 12215	.130 x 600' (182 meters)

Trimmer Line Cutter



Order No. 33 - 12820

Trimmer line cutter, "Patented", simple to use and safe with no exposed cutting edges. Put on your keyring and have ready when it is time to refill your trimmer. Cuts trimmer line from .065 to .130 in diameter. MIN010

Order No. 33 - 12918

Carded Trimmer Line Cutter. Cuts trimmer line from .065 to .130 dia. (Our 32-12820 carded).

TRIMMER /BRUSHCUTTER/BLOWER ACC.



BLACK VORTEX PROFESSIONAL TRIMMER LINE



- Low Noise
- Long Wear / Long Lasting
- Needs Less Power

Order

No.	Size/Minimum Length
Cut Length	
27 - 10067	.095 x 16-1/4" (20pc.)
27 - 10069	.130 x 16-1/4" (15pc.)
Small Donut (12 per case)	
27 - 12160	.080 x 160' (48.8 meters)
27 - 12161	.095 x 115' (35 meters)
27 - 12183	.105 x 90' (27.4 meters)
27 - 12163	.130 x 60' (18.3 meters)
Large Donut (12 per case)	
27 - 12164	.080 x 320' (97.6 meters)
27 - 12165	.095 x 230' (70.1 meters)
27 - 12166	.105 x 185' (56.4 meters)
27 - 12167	.130 x 120' (36.6 meters)
27 - 12168	.155 x 85' (25.9 meters)

Order

No.	Size/Minimum Length
Small Spool (12 per case)	
27 - 10068	.095 x 230' (70.1 meters)
27 - 10070	.130 x 120' (36.6 meters)
Medium Spool (9 per case)	
27 - 12174	.080 x 960' (292.7 meters)
27 - 12175	.095 x 685' (208.8 meters)
27 - 12176	.105 x 550' (167.7 meters)
27 - 12177	.130 x 360' (109.8 meters)
27 - 12178	.155 x 250' (76.2 meters)
Large Spool (6 per case)	
27 - 12179	.095 x 1140' (347.6 meters)
27 - 12180	.105 x 920' (280.4 meters)
27 - 12181	.130 x 600' (182.9 meters)
27 - 12182	.155 x 420' (128 meters)

27 TRIMMER & ACCE.

CUT LENGTH VORTEX PROFESSIONAL TRIMMER LINE



- Low Noise
- Long Wear / Long Lasting
- Needs Less Power



Order

No.	Size/Minimum Length	Code	Sugg. List
Cut Length			
27 - 11185	.095 x 8"	(24pc.)	
27 - 11194	.095 x 8"	(125pc.)	
27 - 11202	.095 x 8"	(427pc.)	
27 - 11186	.105 x 8"	(24pc.)	
27 - 11195	.105 x 8"	(100pc.)	
27 - 11203	.105 x 8"	(345pc.)	
27 - 11187	.130 x 8"	(24pc.)	
27 - 11196	.130 x 8"	(75pc.)	
27 - 11204	.130 x 8"	(225pc.)	

CUT LENGTH DIAMOND CUT PROFESSIONAL TRIMMER LINE (Orange)

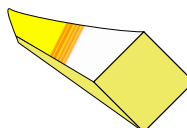

Order

No.	Size/Minimum Length	Code	Sugg. List
Cut Length			
27 - 11181	.095 x 8"	(24pc.)	
27 - 11189	.095 x 8"	(125pc.)	
27 - 11198	.095 x 8"	(375pc.)	
27 - 11182	.105 x 8"	(24pc.)	
27 - 11190	.105 x 8"	(100pc.)	
27 - 11199	.105 x 8"	(307pc.)	
27 - 11183	.130 x 8"	(24pc.)	
27 - 11192	.130 x 8"	(75pc.)	
27 - 11200	.130 x 8"	(202pc.)	
27 - 11184	.155 x 8"	(24pc.)	
27 - 11193	.155 x 8"	(50pc.)	
27 - 11201	.155 x 8"	(142pc.)	



High Wheel Trimmer Line

Order

No.	Size/Minimum Length
27 - 9595	.130 x 18" (36 pc)
27 - 9597	.130 x 21" (36 pc)
27 - 9596	.155 x 18" (24 pc)
27 - 9594	.155 x 21" (24 pc)
27 - 9961	.170 x 21" (24 pc)



Fixed Line Trimmer Head Assembly



Order No. 27 - 6865

Fixed Line Trimmer Head Assy. Fits all trimmers equipped to use weed trimmer/brushcutter blades. Comes with (12) pre cut lengths of .130 line, 2 spacers and instructions.

Pre-cut Trimmer Line



Order No. 27 - 9118

Pre-cut trimmer line. .130 line, 15" long. Replacement line for our 27-6865 trimmer head. **12 pieces per kit.**

Multi Application Trimmer Head



Order No. 27 - 10192

Multi-application trimmer head fits Ryobi, Homelite & McCulloch trimmers.

ROTARY COMMERCIAL TRIMMING SYSTEM

Order No. 27 - 10060

Rotary's Commercial Metal Fixed Line Trimming System. Fits Straight or curved shafts.

Uses our 27-10067 & 27-10069 Vortex Trimmer Line.

- Easy Load System
 - Eliminates Line Welding
 - Fits Most Trimmers

- Easy Load System
- Eliminates Line Welding
- Fits Most Trimmers

Replacement parts:

Order No.	Description
27 - 10061	Trimming Head
27 - 10062	Wear Plate
27 - 10063	Hardware

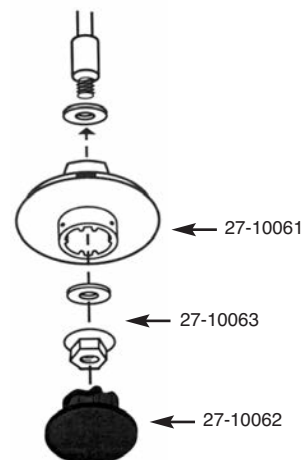

TRIMMER /BRUSHCUTTER/BLOWER ACC.



**Kwik Speed Loader
Trimmer Head**



Order No. 27 - 12596

Replacement eyelets (2) for our 27-12569 trimmer head.

Order No. 27 - 12594

Replacement cover for our 27-12569 trimmer head.

Order No. 27 - 12595

Replacement bump knob/spool for our 27-12569 trimmer head.

Kwik Loader Trimmer Head



Order No. 27 - 11831

Kwik loader trimmer head model KL730, 5-1/4" three line heavy duty head with collets and hardware included.

Order No. 27 - 11830

Kwik loader trimmer head model KL650, 5" dual line head with collets and hardware included.

Order No. 27 - 11826

Kwik loader trimmer head model KL450A, 4-3/4" dual line head with KL30 adapter included.

Order No. 27 - 11832

Kwik loader #7008 repair kit includes 3 cams and springs. Fits our 27-11826, 27-11830, 27-11831 trimmer heads.

27

TRIMMER & ACCE.

**Bump-N-Feed Trimmer Head from
KWIK PRODUCTS**

Bump & Feed Trimmer Head
Pre Packaged with Adapters, Brass Eyelets
10mm FLH
7mm MLH
8mm MLH
Uses .095 Line

Order No. 27 - 11988

Kwik loader Model KT30 dual line, Semi-Matic, Bump-N-Feed trimmer head with adapters included.

Order No. 27 - 11982

Replacement Outer Cam. 6 pins, replaces Echo P022006760

Order No. 27 - 11983

Replacement Inner Cam. Replaces Echo P022006750.

Order No. 27 - 11984

Replacement Brass Eyelets (2).

Order No. 27 - 11987

Replacement Spool. Replaces Echo P022006770. For 6 pin cam assembly.

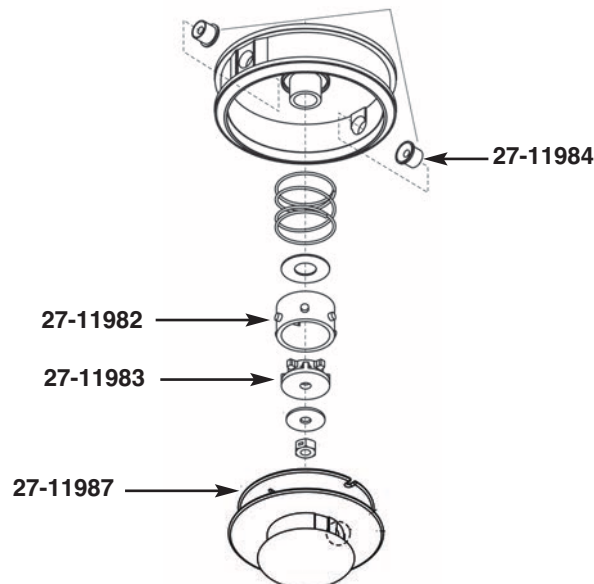



TRIMMER /BRUSHCUTTER/BLOWER ACC.

Bump & Feed Trimmer Head from KWIK Products

Order No. 27 - 12991

Kwik KT50 Bump & Feed trimmer head. Replaces Echo Matic Pro 21560031. Poly bagged with (2) studs, 10mm x 1.25LHF arbor fits the Echo. 8mm & 7mm studs.

Order No. 27 - 13031

Kwik KT50S Bump & Feed trimmer head. Fits Stihl.



Order No. 27 - 13300

Duel compartment spool replaces Echo P022006770, 6 prong replacement spool. Fits Echo trimmer head 21560030.

Bump & Feed Trimmer Head

Order No. 27 - 12384

Bump & Feed trimmer head. Trimmer head VP33S for Kawasaki. 8mm x 1.25 LHF arbor bolt.



Silverback 4" Trimmer Head



Order No. 27 - 14368

Silverback 4" Trimmer Head. Commercial rated with special glass-fill, nylon spool cap. Trouble-free line loading. Floating eyelets reduce line melt. Replaces Green Machine 20195, Red Max BC00088, PT104 & Shindaiwa 80401. Arbor sizes included: 7mm x 1.00 LHM, 8mm x 1.25 LHF, 8mm x 1.25 LHM, 10mm x 1.25 LHF, 10mm x 1.25 LHM, 10mm x 1.00 LHF.

Silverback 6" Trimmer Head

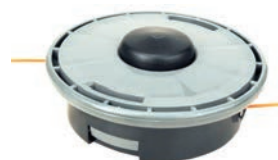

Order No. 27 - 14369

Silverback 6" Trimmer Head. Commercial rated with special glass-fill, nylon spool cap. Trouble-free line loading. Floating eyelets reduce line melt. Holds 80' - .080 line, 60' - .095, 50' - .105, 30' - .130 line. Replaces Green Machine 20735, Red Max BC00088, PT104 & Shindaiwa 80403. Arbor sizes included: 7mm x 1.00 LHM, 8mm x 1.25 LHF, 8mm x 1.25 LHM, 10mm x 1.25 LHF, 10mm x 1.25 LHM, 10mm x 1.00 LHF.



Order No. 27 - 14375

Spool with spring plate fits 4" Head Silverback Trimmer Head. Fits our 27-14368 Trimmer Head.



Order No. 27 - 14377

Spool with spring plate fits 6" Head Silverback Trimmer Head. Fits our 27-14369 Trimmer Head.



Order No. 27 - 14374

Cap & Cover for 4" Head Silverback Trimmer Head. Fits our 27-14368 Trimmer Head.



Order No. 27 - 14376

Cap & Cover for 6" Head Silverback Trimmer Head. Fits our 27-14369 Trimmer Head.

Order No. 27 - 14373

Spring for Silverback Trimmer Head. Fits our 27-14368 & 27-14369 Trimmer Head. MIN005



27 TRIMMER & ACCE.

TRIMMER /BRUSHCUTTER/BLOWER ACC.



UNIVERSAL PRODUCTS TRIMMER HEADS

Made in U.S.A.

Pro Bump & Feed

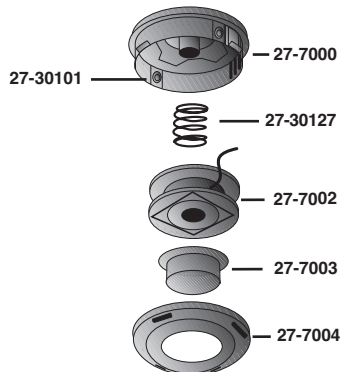

- Uses Arbor Bolt 30048 thru 30054.
- Double line indexing
- Spool capacity of 40 feet on .095 trimmer line
- Simple, problem free indexing mechanism
- Designed for professional use
- Recommended for trimmers under 36cc

Replacement parts:

Order No. 27 - 6994

VP35-5

Order No.

- 27 - 7000**
- 27 - 30127**
- 27 - 7002**
- 27 - 7003**
- 27 - 7004**
- 27 - 30101**

MIN010

Description

- Housing
- Spring
- L.H. Spool
- Button
- Cover
- Eyelet

Super Mini Bump & Feed Trimmer Head

Order No. 27 - 7897

Fits Homelite ST145M, ST155, ST175, ST175C, ST185, ST285, IDC364, 500, 520, 530, 540, McCulloch 60-SX, 65, 65-SL, 80-SX, 80-SLX2815, 2817, Eager Beaver Super, Super-SL, I-SX, II-SL, 280, 285, Pro-Mac 1, Road Runner models, Ryan 260, 261, 263, 264, 265, 270, 274, 275, 280, Ryobi 700R, 710R, 720R, 760R, 764R, 770R, 960R & Wizard HLT 2037A78.

Replacement Parts:

- Order No.**
- 27 - 8217**
- 27 - 8218**
- 27 - 8219**
- 27 - 8220**
- 27 - 8221**
- 27 - 8222**
- 27 - 8223**

MIN010
MIN010

- Description**
- Collar
 - Housing
 - Eyelets
 - Washer
 - Spring
 - Spool
 - Cover

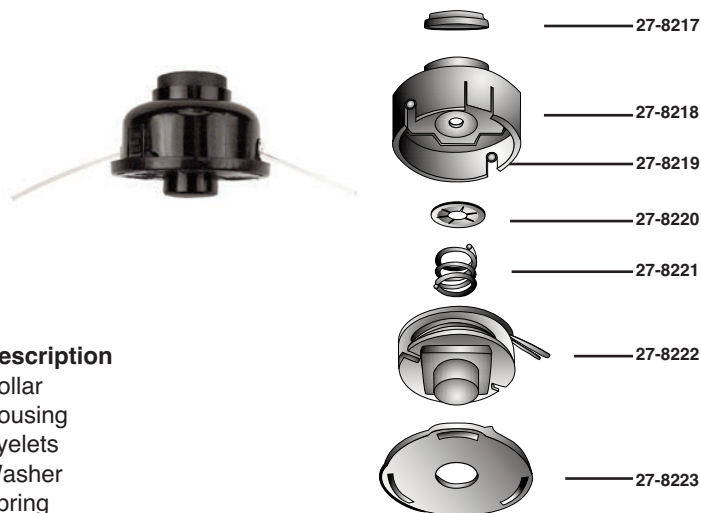

Manual Feed Trimmer Head

Complete with Arbor Bolt

Rotary's New Commercial Duty Trimmer Head Features

- Twist-Feed Line Advancing.
- Dual Line.
- Durable Nylon Construction.
- Large Capacity Spool.
- Easy Spool Release.
- Fits Multi Applications.

Order No. 27 - 9383

Manual Feed trimmer head assembly complete with 10mm x 1.25 FLH & 8mm x 1.25 MLH arbor bolts. Fits Echo, Shindaiwa, Stihl, Green Machine, Maruyama & Red Max.



Order No. 27 - 9300

Manual Feed trimmer head assembly complete with 10mm x 1.00 FLH & 7mm x 1.00 MLH arbor bolts. Fits Stihl, Red Max & Shindaiwa.

Order No. 27 - 9299

Manual Feed trimmer head assembly complete with 12mm x 1.75 FLH arbor bolt. Fits Husqvarna.

27

TRIMMER & ACCE.



TRIMMER /BRUSHCUTTER/BLOWER ACC.

Bump & Feed Trimmer Head

Complete with Arbor Bolt



Rotary's New Commercial Duty Trimmer Head Features

- Bump-Feed Line Advancing.
- Dual Line.
- Durable Nylon Construction.
- Large Capacity Spool.
- Easy Spool Release.
- Fits Multi Applications.

Order No. 27 - 9395

Bump & Feed trimmer head assembly complete with 8mm x 1.25 FLH arbor bolt. Fits Tanaka & Robin.

Order No. 27 - 9366

Bump & Feed trimmer head assembly complete with 10mm x 1.00 FLH & 7mm x 1.00 MLH arbor bolts. Fits Stihl, Red Max & Shindaiwa.

Order No. 27 - 9382

Bump & Feed trimmer head assembly complete with 10mm x 1.25 FLH & 8mm x 1.25 MLH arbor bolts. Fits Echo, Shindaiwa, Stihl, Green Machine, Maruyama & Red Max.

Order No. 27 - 9339

Bump & Feed trimmer head assembly complete with 12mm x 1.75 FLH arbor bolt. Fits Husqvarna.

Order No. 27 - 9301

Bump & Feed trimmer head assembly complete with 3/8" - 24 FRH arbor bolt. Fits Poulan, Weedeater, Hoffco.

Replacement Spool with Line for HOMELITE & RYOBI



Order No. 27 - 9224

Replacement spool with line replaces Homelite DA-98912 & Ryobi 153577R.

Replacement Bump & Feed Spool



Order No. 27 - 9851

Replacement manual feed spool for our 27-9301, 27-9339, 27-9366, 27-9382, 27-9384 & 27-9395 trimmer heads.

Replacement Spool with Line for TORO



Order No. 27 - 9226

Replacement spool with line replaces Toro 88192.

Replacement Manual Feed Spool



Order No. 27 - 9850

Replacement manual feed spool for our 27-9299, 27-9300 & 27-9383 trimmer heads.

MULTI-APPLICATION BUMP-N-FEED TRIMMER HEAD

Order No. 27 - 9914

Bump -N- Feed Head

- Fits most gas trimmers; Available in two models.
- A Unique Multi-Application shaft bolt and stud system contained in one package.
- Patented Quik-Feed system of indexing line.
- Heavy Duty brass eyelets.
- Square line eyelets helps reduce line weld.
- Displayed in a clear view clamshell ready for merchandising.
- Illustrated instructions.



27 TRIMMER & ACCE.



TRIMMER /BRUSHCUTTER/BLOWER ACC.

Bump & Feed Trimmer Head

Pre Packaged with
 10mm x 1.25 LHF Arbor Bolt
 7mm x 1.0 LHM Arbor Bolt
 8mm x 1.25 LHM Arbor Bolt
 (Fits application shown below)

Order No. 27 - 10231

VP33-ADU Bump & feed trimmer head assembly complete with arbor bolt. Fits Echo models SRM-2220, 2100, 2101, 2110, 2201, 2300, 2301, 2400, 2510, 3000, 3001, 3010, 2410, 2500, 2501/S, 2502, 300AE/AE1/E, 302, 303E, 140D/DA, 200AE/BE/CE/DA/DB/DE, 400AE/B/E, 1500, 1501, 202DA/FA, 210AE/E, 250E, 3410, 3800, 4600, 3100, 3100S, 3110, 3400, JP-390XL, 420D, 660, 260, 270, 300, 390. Tanaka models TBC-425, 501, 4500, 162, 205, 215, 218, 220/E, 232, 233, 240, 250, 322, 325, 355, 373, 422, 262, 265, 300, 301, 321, TST-218, 501, SUM321. Also fits several other models not listed above.

Replacement parts:

Order No.	Description
27 - 11750	Housing
27 - 30127	Spring
27 - 30128	Washer
27 - 11752	Outer Drive, Inner Cam
27 - 11757	Spool
27 - 11751	MIN010 eyelets

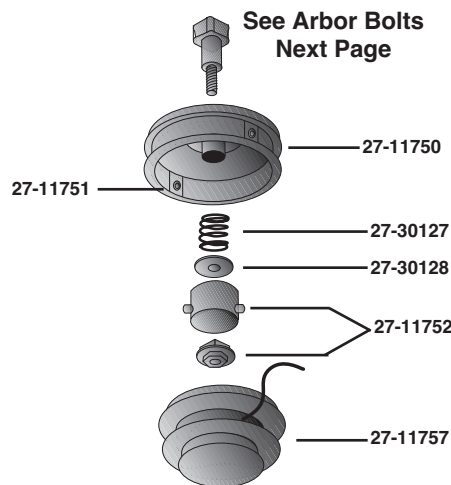

Bump & Feed Trimmer Head for STIHL



Order No. 27 - 10638

VP33N Bump & Feed trimmer head fits Stihl with 10mm x 1.0 LHF arbor bolt.

Bump & Feed Trimmer Head for HUSKY



Order No. 27 - 10639

VP33M Bump & Feed trimmer head fits Husky with 10mm x 1.25 LHF counterbored arbor bolt.

VP-75 Trimmer Head



Order No. 27 - 14367

VP-75 Trimmer Head. Heavy duty semi matic bump feed. 5-1/2 diameter. Holds 60' - .095, 50' - .105, line. High capacity, low profile professional head. "The Big Boy" Arbor sizes included: 8mm x 1.25 LHM, 10mm x 1.25 LHF, 10mm x 1.25 LHF, counter bore.

VP-75N Trimmer Head



Order No. 27 - 14287

VP-75N Trimmer Head. Heavy duty semi matic bump feed. 5-1/2 diameter. Fits Stihl. Holds 60' - .095, 50' - .105, line. High capacity, low profile professional head. "The Big Boy" Arbor size included: 10mm x 1.0 LHF, counter bore.

VP-78 Bump Feed Trimmer Head

Order No. 27 - 14127

VP-78 Trimmer Head. Designed for use by the casual user. Can be adapted to fit spindle unit trimmers offered by Ryobi, Ryan, IDC, Homelite, McCulloch, Weedeater along with many others. The user can load and remove line through the knob, never having to separate the cover.



27 TRIMMER & ACCE.



TRIMMER /BRUSHCUTTER/BLOWER ACC.

Trimmer Head for RYOBI



Order No. 27 - 9599

Bump & Feed trimmer head for Ryobi. Fits 700R / 720R models.

Trimmer Head Eyelets



Order No. 27 - 11751

VP33 Eyelets for our 27-10231, 27-10638 & 27-10639 trimmer heads. MIN010

Trimmer Head Housing



Order No. 27 - 11750

VP33 Trimmer head housing fits our 27-10231, 27-10638 & 27-10639 trimmer heads.

Trimmer Head Nut



Order No. 27 - 11753

VP33 Nut for our 27-10231, 27-10638 & 27-10639 trimmer heads. MIN010

Trimmer Head Cam Assembly



Order No. 27 - 11752

VP33 Cam assembly for our 27-10231, 27-10638 & 27-10639 trimmer heads. With 4 pins.



Order No. 27 - 30130

Inner Cam. Semi-matic tap-n-go. Fits older VP30 heads.

Trimmer Head Left Hand Spool



Order No. 27 - 11757

VP33 Left Hand spool for our 27-10231, 27-10638 & 27-10639 trimmer heads. For 4 pin Cam Assy.



Order No. 27 - 30129

Outer Drive. Semi-matic tap-n-go. Fits older VP30 heads. With 2 pins, uses our 27-30130 inner cam.



Order No. 27 - 30131

Spool. Semi-matic tap-n-go. Fits older VP30 heads. For 2 pin outer drive used with our 27-30129.

Eyelet Sleeve for STIHL



Order No. 27 - 14577

Eyelet sleeve replaces Stihl 4003-713-8301. Fits model 25-2 Autocut Trimmer Head. MIN005

Trimmer Head Base Cover for STIHL



Order No. 27 - 14501

Trimmer head base cover replaces Stihl 4002-713-9708. Fits Autocut 25-2 trimmer head. Fits models FS 44, 55, 80, 83, 85, 90, 100, 100RX, 110, 120, 130, 200, 250, KM 55, 85, 90, 110, 130, FS-KM.

Trimmer Head Spool for STIHL



Order No. 27 - 14500

Trimmer head spool replaces Stihl 4002-713-3017. Fits Autocut 25-2 trimmer head. Fits models FS 44, 55, 80, 83, 85, 90, 100, 100RX, 110, 120, 130, 200, 250, KM 55, 85, 90, 110, 130, FS-KM.

27 TRIMMER & ACCE.

TRIMMER /BRUSHCUTTER/BLOWER ACC.



Trimmer Head Speed Feed 375 LH



Order No. 27 - 13375

Trimmer Head Speed Feed 375 LH. 3-3/4" diameter, LH thread. Recommended for smaller trimmers and some curved shaft trimmers. Ideal for consumer use, spool holds 10' of .095 line. Uses .080", .095" or .105" diameter line. Large durable eyelets enhance line life, smooth and durable large bottom cover taps on ground to advance line and allows head to glide while trimming. Includes female adapters that fit the following sizes 8mmX1.25, 10mmX1.0, 10mmX1.25, also includes male adapters that fit the following sizes: 7mmX1.0, 8mmX1.25, 10mmX1.25.

Trimmer Head Speed Feed 450



Order No. 27 - 13377

Trimmer Head Speed Feed 450. 4-1/2" diameter. Replaces Shindaiwa 28820-08000 & 78890-210000. Fits models 22T, TR195's, LT18, T18, LT20, C20, T20, C230, M230, M231, T230, T231, T232, C25, C2510, M2500, M2510, T25, T250, T2500, T2510, T2510X, C260, T260, T261, C27, C270, T27, T270, T272X, T3410, T3410X, BP35, C35, C350, T350, B45, B450, RC45. Recommended for straight shaft trimmers. Arbor sizes included: 10mm x 1.25 LHF, 10MM X 1.00LHF, 8MM XZ 1.25 LHF, 7MM X 1.00LHM, 8MM X 1.25LHM. Spool holds 20' of .095" line, Uses .080", .095", .105" line.

Spool for SPEED FEED 375



Order No. 27 - 13597

Speed feed spool 375 L/H. Fits our 27-13375 Head. Shindaiwa & Echo X473000011 & 78890-11330.

Spool for SPEED FEED 450



Order No. 27 - 13603

Speed feed spool 450 L/H. Fits our 27-13377 Head. Shindaiwa & Echo X473000031 & 28820-07370.

Cover for SPEED FEED 375



Order No. 27 - 13598

Cover feed spool 375 L/H. Fits our 27-13375 Head. Shindaiwa & Echo X472000012 & 78890-11340.

Cover for SPEED FEED 450



Order No. 27 - 13602

Cover feed spool 450 L/H. Fits our 27-13377 Head. Shindaiwa & Echo X472000031 & 28820-07390.

Spring for SPEED FEED 375 & 450



Order No. 27 - 13599

Spring for 375 & 450 Speed Feed heads. Shindaiwa 450000871 & 17500-23600. Fits our 27-13375 & 27-13377. MIN010

Spring Cap for SPEED FEED 375 & 450



Order No. 27 - 13601

Spring Cap for 375 & 450 Speed Feed heads. Shindaiwa 28820-07380 & X494000280. Fits our 27-13375 & 27-13377. MIN010

Eyelet for SPEED FEED 375 & 450

Order No. 27 - 13600

Eyelet for 375 & 450 Speed Feed heads. Shindaiwa X4750000050 & 28820-07340. Fits our 27-13375 & 27-13377. MIN010



27 TRIMMER & ACCE.



TRIMMER /BRUSHCUTTER/BLOWER ACC.

T-Knob for RYOBI



Length 2-1/2"
Thread Size 1/4 - 20

Order No. 27 - 11038

T-Knob replaces Ryobi PS02071B. Also replaces Homelite UP05137.

Studs for Multi Application Trimmer Heads



Order No. 27 - 10682

7 mm x 1.00 x 10mm x 1.25 Male LH Stud. Gold.

Arbor Bolt for HUSKY



Order No. 27 - 30055

10mm x 1.25mm LHF counter sunk arbor bolt. Fits European made straight shaft trimmers.

LHF Arbor Bolt



Order No. 27 - 12498

LHF arbor bolt. 8mm x 1.25 LHF. Fits our 27-6994, VP35 head.

Arbor Bolts & Studs for MULTI-APPLICATION Heads



Order No.
27 - 9710
27 - 7318
27 - 7319

Description/Size

	Stud	10mm x 1.25-10mm x 1.25 Male LH
Black	Stud	8mm x 1.25 - 10mm x 1.25 Male LH
Silver	Stud	7mm x 1.00 - 10mm x 1.00 Male LH



Bolt Only for Semi-Matic Head

27-30048
27-30049
27-30050
27-30051
27-30052
27-30046
27-30047
27-30053
27-30054

Bolt Size

10mm x 1.25 LHF
7mm x 1.0 LHM
8mm x 1.25 LHM
8mm x 1.25 LHF
10mm x 1.25 LHM
3/8 x 24 RHF
3/8 x 24 RHF w/collar
12mm x 1.75 LHF
10 mm x 1.0 mm LHF
7/16 x 20 RHF
10mm x 1.25 RHF

27 - 30048 thru 27 - 30054

Bolt Only for Semi-Matic Head

27 - 30112

Knob R.H.

27 - 30113

Knob L.H.



TRIMMER /BRUSHCUTTER/BLOWER ACC.

Poly Blades for STIHL



Order No. 27 - 7141

Poly Blades replaces Stihl 4111-007-1001. 4-1/16" length, .475 center hole. Replaces Husky 531-01-77-15 blades
MIN012

Order No. 27 - 17141

Poly Blades. (Bagged) MIN005

WEED BLASTER



Order No. 27 - 9035

Weed Blaster Blades 4" length, 31/64" center hole. Steel inserted plastic blade. Fits Grasscraft GC1601 & Allen SE1601. MIN003

Heavy Duty Square Line Eyelets



Order No. 27 - 7324

Brass Square Line Eyelets reduce wear and extend the life of the trimmer line. Also helps reduce line weld. MIN010

Trimmer Head Eyelets



Order No. 27 - 12422

Heavy duty brass eyelets for round line. Similar to our 27-30101 aluminum eyelets. Helps reduce wear and extend the life of the trimmer line. Also helps reduce line weld. MIN010

27 TRIMMER & ACCE.

12" Universal Brush Cutter Blade



Order No. 27 - 50173

Universal Brush Cutter Blade. 12" (304.80mm) Length, 2.75" (69.85mm) Width, .095" (2.4mm) Thickness. 1" center hole.

14" Universal Brush Cutter Blade



Order No. 27 - 50174

Universal Brush Cutter Blade. 14" (355.60mm) Length, 2.75" (69.85mm) Width, .095" (2.4mm) Thickness. 1" center hole.

10" AireCut Tri Brush Cutter Blade



Order No. 27 - 14285

10" AireCut Tri Brush Cutter Blade. 250mm (under 25cc). The blade has a unique aerofoil twist that creates a strong upward airflow which carries the material away from the cutting area, saving energy, loss of power, fuel and time.

12" AireCut Tri Brush Cutter Blade



Order No. 27 - 14286

12" AireCut Tri Brush Cutter Blade. 300mm (25cc and above). The blade has a unique aerofoil twist that creates a strong upward airflow which carries the material away from the cutting area, saving energy, loss of power, fuel and time.



TRIMMER /BRUSHCUTTER/BLOWER ACC.

Grass/Brushcutter Blades



Order No.	No. Teeth	Diameter In./MM	Bore In./MM	Thickness
27 - 4413	3	10"/254mm	1"/25mm	1.8mm
27 - 9741	3	10"/254mm	1"/25mm	3.0mm
27 - 13449 *	3	10"/254mm	1"/25mm	2.25mm
27 - 4414 *	3	12"/305mm	1"/20mm	2.25mm
27 - 9743	3	12"/305mm	1"/25mm	3.0mm
27 - 7854 *	4	8"/203mm	1"/25mm *	1.5mm
27 - 7855 *	4	9"/229mm	1"/25mm *	1.8mm
27 - 4280	4	10"/254mm	1"/25mm	1.8mm
27 - 4279	8	10"/254mm	1"/25mm	1.8mm
27 - 7862 *	8	8"/203mm	1"/25mm *	1.5mm
27 - 7863 *	8	9"/229mm	1"/25mm *	1.8mm
27 - 4278	80	10"/254mm	1"/25mm	1.8mm
27 - 4400	80	9"/229mm	1"/25mm	1.8mm
27 - 4405	80	9"/229mm	.790"/20mm	1.8mm
27 - 5957	80	8"/203mm	1"/25mm	1.8mm
27 - 5959	80	8"/203mm	.790"/20mm	1.8mm

*Includes reducer bushing 3/4" /20mm

**Grass/Brushcutter Blades
Professional Cutting Blades**



MAXI



XRT



EIA

Order No.	No. Teeth	Diameter In./MM	Bore In./MM	Thickness
Maxi Series				
27 - 7857	24	9"/229mm	1"/25mm	1.8mm
27 - 8389	22	8"/203mm	.790"/20mm	1.5mm
EIA Series				
27 - 8458	22	8"/203mm	.790"/20mm	1.5mm
27 - 8459	22	8"/203mm	1"/25mm	1.5mm
27 - 8460	24	9"/229mm	.790"/20mm	1.8mm
27 - 8461	24	9"/229mm	1"/25mm	1.8mm

**Reducer Bushing for
Brushcutter Blades**



ID 20mm
OD 25mm

Order No. 27 - 7860

20mm Reducers for brushcutter blades. For our 27-7854, 27-7855, 27-4413, 27-4414, 27-7862, 27-7863.

MIN010



TRIMMER HEAD APPLICATION CHART

APPLICATION	Arbor Size	Rotary Commercial Trimming	Manual Twist Feed Feed	Bump & Feed	Commercial Bump Feed
ECHO "GT Series 100, 140, 140A, 140B, 160, 160AE, 200, 200A, 200B, 200BE, 200CE, 1000, 1100, 1100A, 2000, 2100, 2101, 2102, 2103, 2200, 2301, 2400; SRM2000	3/8-24 RHF	10060		9301	
SRM Series 140, 140A, 140D, 140DA, 200, 200A, 200AE, 200BE, 200CE, 200D, 200DA, 200DB, 200DE, 200DA, 202FA, 210AE, 210E, 250, 250E, 300, 300AE, 300AE1, 300AE/1, 300E, 300E/1, 302, 302ADX, 303E, 400AE, 400B, 400BE, 400E, 1500, 1500A, 1501, 2100, 2101, 2110, 2200, 2201, 2300, 2301, 2400, 2410, 2500, 2501, 2501S, 2502, 2510, 3000, 3001, 3010, 3100, 3100S, 3110, 3400, 3410, 3800, 4600	10mm x 1.25 LHF	10060	9383	9382	10231
GREEN MACHINE 525H, 1200, 1500, 1600, 1700, 1900, 1930, 1940, 1950, 2000, 2100, 2130, 2200, 2230, 2300, 2331, 2340, 2345, 2500, 2500LP, 2510LP, 2540, 2540LP, 2600, 2800, 2810, 2840, 2850, 3000, 3000SS, 3000M, 3000LP, SRM3000, 3000B, 3000J, SRM3000LP, SRM3000M, SRM3000SS, SRM3040M, 3050M, 3451, 3510, 3540, 3541, G2A, G2C	8mm x 1.25 LHM	10060	9383	9382	10231
HOFFCO 1600, Critter, GT Series 14A, 14B, 14H, 21, 22, 160B, 160T, 160TL, 210, 211, 211A, 215H, 215T, 225, 225SPL, 256SPL, 320B, 320T; GTX, GTSR, Hoffie22, GR320B, P22, Lil Wiz: 600, 1600; WC22, WC215, WT Series: 14, 160, 160H, 160HT, 215, 250C, 250HT, 250HTA, 250WT, 320, 320H, 320HT; PC Series: 22, 225, 380; WH Series	3/8-24 RHF	10060		9301	
JP Series: 215, 215GT, 220F, 225, 260, 260A, 260C, 270, 300, 300A, 300B, 300C, 300F, 320, 390, 390A, 390C, 390XL, 420, 420D, 660	10mm x 1.25 LHF	10060	9383	9382	10231
HOMELITE HK18, HK24, HK28, HK30, HK33, HK38, PBC3600, PBC3800, PBC4000, ST175, ST285, ST385, ST485	8mm x 1.25 LHF	10060		9395	
HK24, HK30, HK33	8mm x 1.25 LHM	10060	9383	9382	10231
HONDA HHT25, 31	10mm x 1.25 LHF	10060	9383	9382	10231
HUSQVARNA (Up to 1986) 16R, 24R, 25RL	8mm x 1.25 LHM	10060	9383	9382	10231
24R (Up to Ser.#603702)	7mm x 1.0 LHM	10060	9300	9366	10231
26LC, 26RLC, 32LC, 32RLC, Mondo	3/8-24 RHF	10060		9301	
32L, 32LR, 32R, 32RLC	3/8-24 LHF	10060			
23LC, 21LCN, Mondo	5/16-24 RHF	10060			
122L, 225L, 225LD/R/RD/RJ, 232L/R	10mm x 1.25 LHF	10060	9383	9382	10231
18R, 18RL, 22R, 22RL, 25R, 25RL, 36R, 39R, 120L, 120R, 125L, 125RL, 125RD, 125RJ, 132L 132LD, 132R, 132RD, 140R, 165RX, 235R, 240R, 244R, 245R, 250R, 265RX	12mm x 1.75 LHF		9299	9339	

27 TRIMMER & ACCE.



TRIMMER HEAD APPLICATION CHART

APPLICATION	Arbor Size	Rotary Commercial Trimming	Manual Twist Feed Feed	Bump & Feed	Commercial Bump Feed
IDC 364, 500, 520, 530, 540 540, 540-1, 540-2, 540 Supreme, 580, 580-1, 580-2, 580 Supreme	10mm x 1.25 LHF	10060	9383	9382	10231
JOHN DEERE 21C, 21S, 80G, 82, 82G, 83G, 85, 100G, 110G, 120G, 200G, 210G, 220G, 250G, 24S, 25S, 30S, 38B, 38R, 38S, 60G, 90G, 240G, 250G, 260G, 300G, 350G, 360G, 380G, 450G, 460G	3/8-24 RHF 10mm x 1.25 LHF	10060 10060	 9383	9301 9382	 10231
JONSERED GT26 BP40, BP40 COMBI, BR400, BR420, BR450, BR460, BR480, GT21L, GT24L, GR26D, GR26L, GR26 Combi, GR32L, GR32L Cat, LR200, LR220, LR220B, LR220L, LR260B, LR260, LR260L, LR300, LR320, LR400, LR420, LR450, LR460, Tiger 40, GR41, GR44, RS44	3/8-24 RHF 8mm x 1.25 LHM	10060 10060	 9383	9301 9382	 10231
LAWN-BOY 1460, 1480, 1480CC, 61653, 61953	10mm x 1.25 LHF	10060	9383	9382	10231
MAKITA RBC221, RBC230, RBC251, RBC260, RBC261, RBC310, RBC311, RST250	8mm x 1.25 LHM	10060	9383	9382	10231
MARUYAMA BC184, BC184/C, BC200, BC201, BC241, BC260CB, BC326, BC340DL, BC402, MC8, BC260, BC260H, BC320, BC320H, BC420H, BC500H, MC-S, BC430DWM, BC440DWM, BC500 BC220DL, BC221DL	8mm x 1.25 LHM 7mm x 1.0 LHM	10060 10060	9383 9300	9382 9366	10231 10231
McCULLOCH EB Series: I, ISL, ISX, II, IISL, IISX, IIISL, IIISX, 285BC, 287BC; Mac Series: 60, 60A, 60S, 60SX, 65, 65SL, 70, 70A, 75, 80, 80A, 80S, 80SL, 80SX, 85SL, 85A, 85S, 85SX, 2825, 2827, ProMac Series: II, II-Sup, ISX, IVHD; Roadrunner Series: I, II, III, SL SEBISX Special, SEBIIS, SEBIIS, Super EBIS, Proscaper Series: I, IS, ISX; SLVR EGL 28, SLVR EGL 28C, SLVR EGL 32BC, Titan 2100 and 2200 ProMac Series: III, III Sup, IV Sup; Proscaper Series: 28S, 32HD, 32HDS, III, IV, V, IS, II, IIHD, SEBIC, SupMac 100A; PS1, PS2, PS3, PS4, PS5, SEB4; EB Series: III, IVSL, 3, 4, 3SX, 32BCS, 35L, 280, 282, 285BCS, 287BCS, 297BCS, 325BC, 327BC, 2815, 2816, 2817, 1818, 2845, 3225, 3225HD, 3227, 3227HD; Slvr Eagle 32BCDLS, Slvr Eagle 32BCS, Titan Series: 2300, 2300AV, 2310, 2360, 2400, 2300AV, 2310, 2360, 2400, 2500, 2500AV, 2560AV, 2565AV, 3000, 3900; Mac Series: 90, 90A, 95, 95A, 99A, 99SL, 100A, 100AHD, 100HD	3/8-24 RHF 10mm x 1.25 LHF	10060 10060	 9383	9301 9382	 10231



TRIMMER HEAD APPLICATION CHART

APPLICATION	Arbor Size	Rotary Commercial Trimming	Manual Feed	Bump & Feed	Commercial Bump Feed
OLYMPYK (OLEOMAC) B200, B220, B220L, B220S, B260L, B260, 8300, B320, B400, B420, B450, B460, 727S, 727T, 733S, 733T, 740S, 740T, 433BP, OL8260BAV, OL8260DAV, OL8260LAV, OL8260TA, OL832BAV, OL8350LAV, OL8460BAV, OL88510BAV, Pro38	8mm x 1.25 LHM	10060	9383	9382	10231
POULAN 770, 800, PPC22, PPC25, PPC25E, PPC31, Pro Series: 111, 112, 113, 114, 115, 117, 559, 609, 1350, 1500, 2400, 2500, 2600, 2610, 2615, 2700; Yard Pro Series: 115, 120A, 130A, 145, 160, 200	3/8-24 RHF	10060		9301	
165, 175, 185, 195, 200, 800, 900, 2620, 2820	3/8-24 LHF	10060			
RED MAX BC220DL, BC221DL, BC240DL, BC300DL, BC260DL, BC261DL, BC262DL, BC340DL, BC341DL, BC342DL, BC2600DL, G2KC	7mm x 1.0 LHM	10060	9300	9366	10231
BC430DWM, BC440DWM, BC441DWM, BC442DWM	8mm x 1.25 LHM	10060	9383	9382	10231
BC200, BC2000DL, BT2000, BT2001DL, BC2300DL	10mm x 1.25 LHM				
10mm x 1.25 LHF	10060	9383	9382	10231	
ROBIN NB16, 16F, 16QF, 16S, 16T, NB26, NB211, NB211C, 231, 231C, NB26AU, 27, NB02, NB02-3A, NB02T, NB,31, NB31AU, NB223, NB253, NB281AU, NBF16, NBT415, NB02TM, NBO3M.	8mm x 1.25 LHF	10060		9395	
RYAN 260, 261, 263, 264, 265, 270, 274, 275, 280	Universal			9599	
RYOBI 700R, 710R, 720R, 760R, 764R, 770R,960R	Universal			9599	
740R, 740R-1, 750R, 775R, 780 series, 780R, 780R-1, 780RB, 780RE, 790R, 840R, 865R, 885R, 990R	10mm x 1.25 LHF	10060	9383	9382	10231
SACHS DOLMAR LT16, LT210	3/8-24 RHF	10060		9301	
BC210, 212	10mm x 1.25 LHF	10060	9383	9382	10231

27 TRIMMER & ACCE.



TRIMMER HEAD APPLICATION CHART

APPLICATION	Arbor Size	Rotary Commercial Trimming	Manual Feed	Bump & Feed	Commercial Bump Feed
SEARS 28151, 79544, 79621, 79721, 79821, 79826, 79541, 79542, 79551, 79552, 79580, 79590, 79603, 79604, 79605, 79606, 79608, 79611, 79612, 79614, 79616, 79680, 79690, 79703, 79713, 79715, 79717, 79718, 79772, 79782, 79803, 79804, 79805, 79812, 79814, 79815, 79924, 79925, 79929, 99512, 99515, 99516	3/8-24 RHF	10060		9301	
79543, 79622, 79623, 79624, 79714, 79725, 79727, 79753, 79754, 79755, 79762, 79821, 79822, 79827, 79828, 79844, 79845, 79846, 79847, 79849, 798471, 79854, 79856, 79857, 79926, 79973, 79975, 791760, 797161, <u>Weedeater Series</u>	3/8-24 LHF	10060			
636-79545, 636-79558 79801, 79809, 79852, 79853, 79855, 79908, 79909, 79911, 79912, 79933, 80956, 797101, 799211, HP22	10mm x 1.00 LHF 5/16-24 RHF	10060		9366	
SHINDAIWA C20, C230, LT20, T230, T230XR, LT18, T20, T20A	7mm x 1.0 LHM	10060	9300	9366	10231
PB35, PB45, C25, C250, C27, F20, R20, R25, R35, T25, T250, T260, T27, T270, T350, VP35, Yardware 220	8mm x 1.25 LHM	10060	9383	9382	10231
SNAPPER 212, 212CST, 213, 213CST, 214, 214DCST, P212CST	3/8-24 RHF	10060		9301	
210SS, 211SS, 211SST, 215RI, 215SST, 240SS, 240SST, 2450RT, 245SST, 310, 311, 311S, 410, 411SST, 4150RT, SSTBC, SST2401, SST4111, 410SST, P212LST	10mm x 1.25 LHF	10060	9383	9382	10231
SOLO S100, S400, 14, 100, 130S, 400	10mm x 1.25 LHF	10060	9383	9382	10231
120, 122, 124, 126, 135, 140, 200, 300, S200, S300	8mm x 1.25 LHF	10060		9395	
STIHL FS80E, FS80RE, FS50, FS50E, FS50F, FS51, FS51AVE, FS60, FS61, FS61AE, FS61E, FS65, FS65AVE, FS65AVRE, FS86, FS90, FS90AVE, FS91, FS96, FS109	8mm x 1.25 LHM	10060	9383	9382	10231
FR106, FR108, FS44, FS44J, FS44R, FS48, FS52, FS52AVE, FS52AVRE, FS56, FS56AVRE, FS62, FS66, FS62AVE, FS62AVRE, FS66AVE, FS66AVRE, FS74, FS74AVE, FS74AVRE, FS76, FS76AVE, FS76AVRE, FS81, FS81AVE, FS81AVRE, FS88, FS106AVE, FS86, FS86AVE, FS86AVRE, FS96, FS106, FS108	10mm x 1.00 LHF		9300	9366	

TRIMMER /BRUSHCUTTER/BLOWER ACC.



TRIMMER HEAD APPLICATION CHART

APPLICATION	Arbor Size	Rotary Commercial Trimming	Manual Twist Feed Feed	Bump & Feed	Commercial Bump Feed
TANAKA AST210, AST7000, SUM301, SUM321, TBC Series: 162, 205, 215, 218, 220, 220E, 220SS, 232, 233, 240, 250, 262, 265, 300, 301, 321, 322, 325, 373, 400, 422, 422C, 425, 500, 501, 2100, 2110, 2800, 4500; TST218, TST501	8mm x 1.25 LHM	10060	9383	9382	10231
TBC202, TBC210, TC1600	8mm x 1.25 LHF	10060		9395	
TBC200	3/8-24 RHF	10060		9301	
TORO CL2100, CL30900, CL30901, CL30920, CL700, 51628, 51641, 51645, 51650, 51660, TC300, TC400, TC3100, TC3500, TC5000, TC600, TC650, TC700, TC800, TC2100, TC3000, TC4000, 1000, 2000, 30900, 30901, 30920	10mm x 1.25 LHF	10060	9383	9382	10231
TC1000, TC2000	3/8-24 RHF	10060		9301	
WEEDEATER Featherlite, GT115T, GT11; 7C, GT117E, HP22, HP22T, LT7000, LT7500, XT20T, XT25, GT117, HP30T, XT40, XT40T	5/16-24 RHF	10060			
HP30SB, HP30SBP, TBC57, GT119, XR125, 165, 175, 185, 195 (straight shaft), XT90, XT20, XT50, XT85, XT100, XT125/B, Yard Pro 105, Yard Pro 140, XT125, XT125KT, XT125T, XT125TR	3/8-24 LHF	10060			
1400, 1400T, 1500, 1600, 1600T, 1700, 1700A, 1740, 3500, GT115, GT116, GT117T, GT118 (curved shaft), gt118KT, GT118T, GT118B, GT152, 85, 100, 125, 125B, 500, 507, 559, 587, 599, 600, 607, 608, 609, 1400, 1400T, 1500, 1600, 1600T, 1700, 1700A, 3500, GT115/T, GT116 Super, GT1 Super 16, GT117/C, XR20, XR20T, XR30, XR50, 175, 185, 195, GT119, XR125, XT50T, Pro Series: 111, 112, 114, 115 (curved shaft), 117; Pro Trim, Weedy 2215, XR Series: 20, 20T, 30, 50, 50A, 50S, 70, 75, 80, 80A, 85, XR Series: 20, 35, 50T, 80, 85, 85T; Yard Pro Series: 110, 115, 116, 120, 120A, 130, 130A, 145; YP110, YP115, YP120, YP116, XT80, YP120A, YP130, YP130A, YP145	3/8-24 RHF	10060		9301	

27
TRIMMER & ACCE.



TRIMMER /BRUSHCUTTER/BLOWER ACC.

Blade/Head Nut for ECHO

Size 10 x 1.25mm

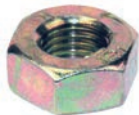

Order No. 27 - 9182

Blade/Head Nut replaces Echo 90051100010. Fits weedtrimmers, brushcutters for mounting blades or heads. 10 x 1.25mm left hand. MIN010

Blade/Head Nut for ECHO

Size 8 x 1.25mm

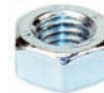

Order No. 27 - 9181

Blade/Head Nut replaces Echo 90050300008. Fits weedtrimmers, brushcutters for mounting blades or heads. 8 x 1.25mm left hand. MIN010

Shoulder Bolt for STIHL

Length 1"
Head OD 19/32"
Bushing OD 15/32"



Order No. 27 - 9043

Shoulder bolt, bushing & washer assembly replaces Stihl 4111-710-8700. MIN003

Trimmer/Brushcutter Handle



Order No. 27 - 7289

Universal Trimmer/Brushcutter Handle. Fits 24mm shafts.

Nut for STIHL



Order No. 27 - 11472

Nut for Stihl. Fits weedtrimmers, brushcutters for mounting blades or heads. 10mm x 1.0mm left hand. MIN010

10 MM Blade Nut for STIHL



Order No. 27 - 14071

10 MM blade nut replaces Stihl 4126-642-7600. 10mm x 1.0 left hand thread brush blade nut. MIN005

Universal Brushcutter Blade Guard & Bracket

Order No. 27 - 8638

Universal brushcutter blade guard & bracket. Overall length on guard 10-1/2".



Universal Trimmer Harness



Order No. 27 - 3512

Our trimmer harness comes with a universal clamp and adjustable strap to fit most trimmers, blowers, etc.

Trimmer Harness



Order No. 27 - 8570

Trimmer harness, with adjusting shoulder strap, hip pad & quick release. Fits Stihl, Solo, Poulan, Homelite, Hoffco, Echo & Brush King.

27 TRIMMER & ACCE.

TRIMMER /BRUSHCUTTER/BLOWER ACC.



Trimmer Harness Shoulder Strap



Order No. 27 - 8569

Trimmer harness, shoulder strap with pad & hanger. Fits Stihl, Solo, Poulan, Homelite, Hoffco, Craftsman & Brush King. 1-1/2" strap.

Harness Strap for ECHO



Order No. 27 - 9068

Harness strap replaces Echo 300300-08261. Fits Echo PB400, PB400E & PB4600 backpack blowers.

Starter Handles for POULAN



Order No. 25 - 4968

Molded Starter Handle and Rope for Poulan XR Trimmers. Replaces 26112. (without knob)

Starter Handle for TANAKA



Order No. 25 - 7410

Starter Handle replaces Tanaka 785-51020-7900 & 785-10207-201. Fits models TBC 5000, TBC 232 and TLE 550 edgers.

Starter Handle with Rope for STIHL



Order No. 25 - 12541

Starter handle with rope replaces Stihl 0000 190 3400. 3.5mm rope, 43" length.

Starter Handle with Rope for STIHL



Order No. 25 - 13098

Starter handle with rope replaces Stihl 1122 190 3400. 4.5mm rope, 43" length.

Stop Switch

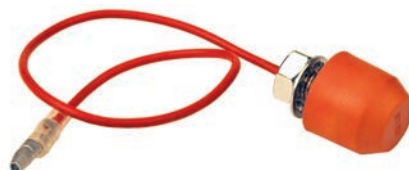

Order No. 31 - 7302

Stop Switch used on Tanaka, Kaaz.

27

TRIMMER & ACCE.



TRIMMER /BRUSHCUTTER/BLOWER ACC.

Carburetor Mounting Gasket for RYAN/RYOBI

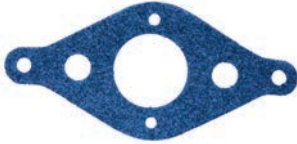

Order No. 23 - 7168

Replaces Ryan 610675. Fits model 10-C, also fits Ryobi. MIN010

Muffler Gasket for SHINDAIWA



Order No. 27 - 9047

Muffler gasket replaces Shindaiwa 20000-15131. Fits models C-25 & T-25.

Fuel Cap for KAWASAKI



Order No. 20 - 7408

Fuel cap replaces Kawasaki 51049-2057. Used on brushcutters/trimmers model TA024 and some Kaaz trimmers.

Breather for KAWASAKI



Order No. 20 - 8737

Breather replaces Kawasaki 14069-2056. Fits Kawasaki 51049-2057 fuel cap and our 20-7408 fuel cap. Used on brushcutters and trimmers (trimmer model TA024) and some Kaaz trimmers.

Fuel Cap for TANAKA



Order No. 20 - 8527

Fuel cap replaces Tanaka 5950502490 & 59501320930. Fits back-pack blowers, models TBL500, TBL455, TBC355.

Fuel Cap for TANAKA



Order No. 20 - 8526

Fuel cap replaces Tanaka 5950165C91. Fits string trimmer models TBC265, TBC500 & hedge trimmer models THT200, THT2120, THT210, THT212, THT230, THT232, THT240.

Fuel Cap for ECHO



Order No. 20 - 7233

Replaces Echo 131-004-0632-0. Fits Echo Trimmer model SRM 140 & Blower model PB200 most trimmers equipped with Kioritz engines.

Fuel Cap for ECHO



Order No. 20 - 9048

Fuel cap replaces Echo 131004-48730/131004-55830 & 131004-55730. Fits models SRM2100, HC2400, SRM2500.

Fuel Cap for ECHO



Order No. 20 - 9026

Fuel cap replaces Echo 131004-06610, 131-600-02260. Fits Echo blower models 400E, 4500 & 4600.



Order No. 20 - 6884

Replaces Poulan 701583 and 710567, Weedeater 530-14347, 530-010729. Fits models 1400, 1500, 1600, 1700, 1720, 1730, 1740, 1900, 4000, 5000, 6010 and Weedie 215. Fits WE, Yard Pro and chain saws with gas tank on top of engine.

Order No. 20 - 13530

Fuel cap replaces Echo 13100455530. Has internal retainer. Fits string trimmers, backpack blowers, hedge trimmers etc. Non-vented cap. 1-7/8" OD





TRIMMER /BRUSHCUTTER/BLOWER ACC.

Fuel Line/Filter/Grommet Assembly for HOMELITE



Order No. 27 - 10468

Fuel line and filter/grommet assembly fits Homelite, Kawasaki & Ryobi. Fuel line 8" x 1/8", primer line 6" x 1/8".

Elbow & Primer for KAWASAKI



Order No. 27 - 7864

Elbow & Primer replaces Kawasaki 49049-2057. Fits models KT12, KT18, TD24 & TD33.

Fuel Pick Up & Pipe for KAWASAKI



Order No. 27 - 7909

Fuel pick up & pipe replaces Kawasaki 92059-2113, 310370-6816A, also fits Astron 717295. Fits models KT12, KT18, TD24, TF22, DT18 & TD33.

Primer Bulb for KAWASAKI



Order No. 27 - 8532

Primer bulb replaces Kawasaki 49043-2065. Fits trimmer models TD18, TD24 & TG33. MIN005

Primer Assembly for KAWASAKI



Order No. 27 - 9162

Primer assembly replaces Kawasaki 49043-20701, 49043-2063. Fits models KT-12, KT-18 & KD40.

Fuel Line & Grommet McCULLOCH



Order No. 20 - 7293

Fuel Line and Grommet replaces McCulloch 213948 (fuel line) and McCulloch 215495 (grommet), Toro 41-1880. Also fits Echo and Weed Eater trimmers and blowers.

Fuel Pick Up & Primer for ROBIN/TASS



Order No. 27 - 7908

Fuel pick up & primer replaces Robin/Tass EC02-0098. Used with Robin/Tass EC02-624, fuel filter.

Fuel Line/Filter Assembly for RYOBI



Order No. 27 - 10206

Fuel line and filter assembly replaces Ryobi 682039. Fits Ryobi, Lawn-Boy, Ryan and others. 6" x 1/8" fuel line.

27 TRIMMER & ACCE.



Hose Primer Assembly for Ryobi



Order No. 20 - 10006

Hose primer assembly replaces Ryobi 181801/ 181168 / 181558 & Walbro 188-152. Fits Ryobi trimmers. (Red)

Fuel Tube Assembly for SHINDAIWA



Order No. 20 - 7933

Fuel tube assembly replaces Shindaiwa 20000-85303. Fits T-25, C25 & C35 model trimmers.

Fuel Tube for SHINDAIWA



Order No. 27 - 8535

Fuel tube replaces Shindaiwa 20011-85451. Fits models T25, T27, C35 & B45.

Head Springs



Order No. 27 - 6975

Replaces Echo 157410. Used on old style Tap-N-Go head with foam rings.

Order No. 27 - 30169

Replaces Green Machine 167901.

Order No. 27 - 6968

Replaces Weedeater 530-340007, 530-092067. Used on Tap-N-Go head.

Fuel Line/Filter Assembly for STIHL



Order No. 27 - 7159

Fuel line and filter assembly replaces Stihl 4112-350-3500. Fits model FS80.

Foam Pad Line Saver



Order No. 27 - 4299

Replaces Echo 158620, fit all GT series. Sears Electric and Weedeater with dome heads. MIN005

Line Saver for WEEDEATER



Order No. 27 - 6882

Line Saver replaces Weedeater 530-093216. Used on Weedeater models 507 and 509 electric. MIN010

Order No. 27 - 6881

Line Saver replaces Weedeater 530-093898, models 120, 120A, 130, 130A. Also replaces John Deere PT9022, Hoffco 2122085, Yard Pro. MIN010

Clutch Assembly for SHINDAIWA



Order No. 27 - 7928

Clutch assembly replaces Shindaiwa 20000-51104, 20000-51103. Fits models T/C25, T/C250 & T/C25.

Clutch Assembly for SHINDAIWA



Order No. 27 - 7929

Clutch assembly replaces Shindaiwa 20035-5100, 20035-51101. Fits model T18, T20, LT20, C20 & T/C230.

TRIMMER /BRUSHCUTTER/BLOWER ACC.



Clutch for STIHL

Order No. 27 - 9625

Clutch replaces Stihl 4130-160-2000. Fits Stihl FS36 trimmers. Fits Kaaz T-170 & Ryobi 31cc model.



OD 2-27/64"
Thread Size 3/8" - 24 RH

Clutch for WEEDEATER

Order No. 27 - 6883

Clutch replaces Weedeater 530-069195. Fit models XR85, XR95, XR105 and XR125.



Bump Head Knob for LAWN-BOY/RYAN

Order No. 27 - 7235

Bump Head Knob replaces Lawn-Boy 682069 and Ryan 153066.



27
TRIMMER & ACCE.

Bump Head Knob for HOMELITE

Order No. 27 - 8518

Bump head knob replaces Homelite DA98866. Fits Homelite EZ Line Advance Systems with right hand threads. (black)



Bump Head Knob for HOMELITE

Order No. 27 - 8521

Bump head knob replaces Homelite A97910A. Fits Homelite EZ Line Advance Systems with left hand threads. (red)



Hedge Trimmer Shield for ECHO & SHINDIAWA

Order No. 27 - 8555

Hedge trimmer shield for Echo. Fits Echo 30" models & TMC model HT3550A

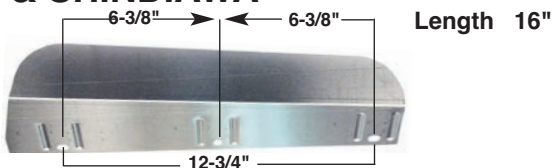

Hedge Trimmer Shield for STIHL

Order No. 27 - 8556

Hedge trimmer shield for Stihl. Fits Stihl 30" models.

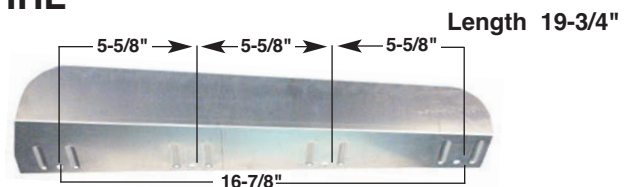

Hedge Trimmer Shield

Order No. 27 - 13176

Hedge trimmer shield. Heavy duty, clear Lexan for easy viewing of objects while trimming. .063" thick. Easy drilled for mounting.





TRIMMER /BRUSHCUTTER/BLOWER ACC.

Hedge Trimmer Shield for ECHO

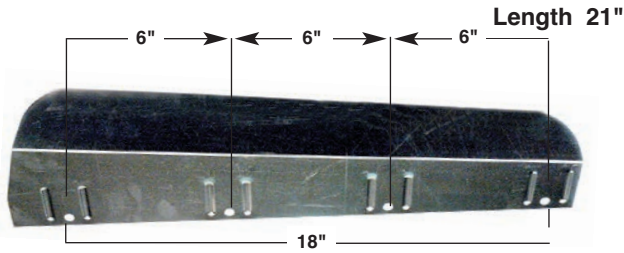

Order No. 27 - 8557

Hedge trimmer shield for Echo. Fits Echo 40" models.

Hedge Trimmer Shield for ASTRON, LITTLE WONDER, MARUYAMA, RED MAX, ROBIN & SHINDIAWA

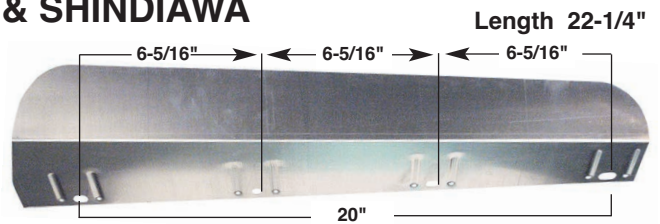

Order No. 27 - 8558

Hedge trimmer shield for Astron, Little Wonder, Maruyama, Red Max, Robin & Shindaiwa. Fits Little Wonder & Red Max 40" models.

Locking Hex Nut

Size 6mm x 10mm hex



Order No. 27 - 9394

Locking hex nut fits hedge trimmer blade bolts.

MIN010

Hedge Trimmer Shield



Order No. 27 - 12725

Hedge trimmer shield fits 40" hedge trimmers.

Hedge Trimmer Blade Washer for SHINDAIWA

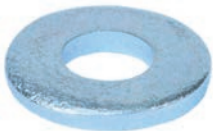

ID 17/64"
OD 5/8"
Thickness 1/16"

Order No. 27 - 9272

Washer replaces Shindaiwa 22910-13160. Fits hedge trimmer blades. OD 5/8", ID 17/64", Thickness 1/16".

MIN010

Blower Hose for STIHL



Order No. 27 - 8791

Blower hose replaces Stihl 42037016102. Fits models BR400, 106, 320.

Flex-Pipe for ECHO

Length 17-1/4"



Order No. 27 - 8572

Flex-Pipe replaces Echo 210012-01112. Fits Echo backpack blower model PB400E.

Extension Tubes for ECHO



Order No. 27 - 11800

Straight extension tube replaces Echo 21001503460. Fits Echo PB4600-PB6000 blowers. 17" length



Order No. 27 - 11801

Curved extension tube replaces Echo 21002303460. Fits Echo PB4600-PB6000 blowers. 13" length.

GRASS CATCHERS



Quick-Glance

GRASS CATCHERS

PG.

Grass Catchers

663-664



GRASS CATCHERS

Grass Bag for EXMARK



Order No. 28 - 8979

Grass bag replaces Exmark 1-352009. Also fits Encore, Jacobsen, FD Kees, Ariens & Gravely. (Black)

LAWN-BOY

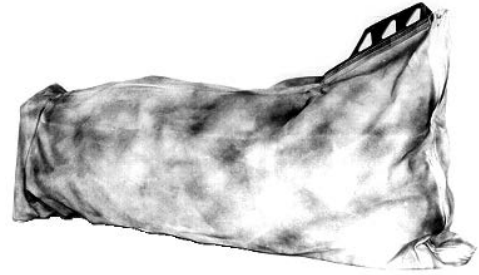

Order No. 28 - 1994

Replacement bag for Lawn-Boy side discharge mowers. Replaces 679966.

Grass Bag for HONDA



Order No. 28 - 8666

Grass bag replaces Honda 81320-VB5-J00, code 333-6815. Fits newer commercial 21" models after 1990. (Black)

Grass Bag for MURRAY



Order No. 28 - 8978

Grass bag replaces Murray 71589. Fits 21" rear bag units. (Black)

Grass Bags for SNAPPER



Order No. 28 - 1995

Replaces Snapper 7022319, 7012320. 21" standard push rear bagger. Home-owner.



Order No. 28 - 1999

Replaces Snapper 7023774, 12321. For 21" commercial mowers. 8" longer than standard bag.

GRASS CATCHERS



SNAPPER (Cont.)

Length 34"
Width 15"



Order No. 28 - 1997

Replacement closure kit for Snapper. Replaces Snapper 7050711.

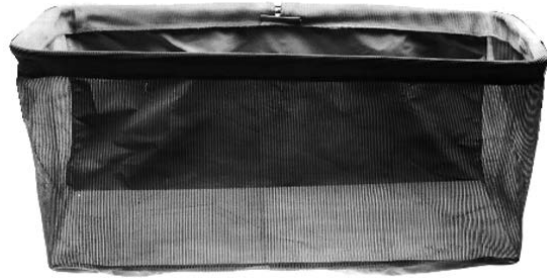

Order No. 28 - 1998

Replaces Snapper 7024819, 7019251, 7018177. Fits Snapper rider mower with rear bag. Replaces Yazoo 200-013. (Black)

Grass Bag for TORO



Order No. 28 - 8644

Grass bag replaces Toro 8-2759. Fits Toro 21" heavy duty commercial rear bag. 15" x 13".

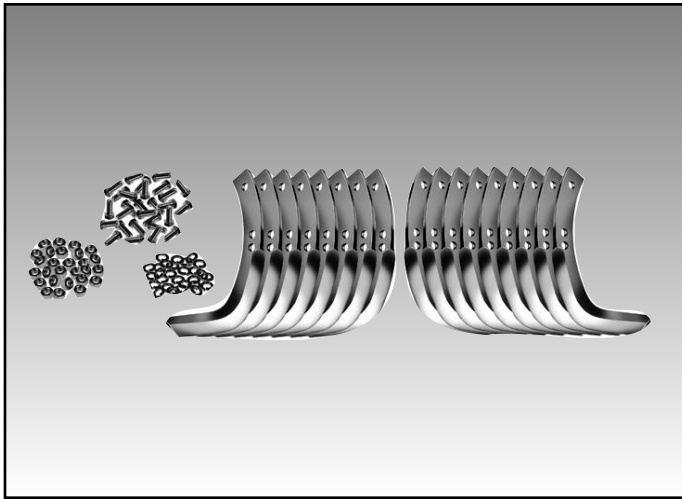

Quick-Glance

TILLER

PG.

Tiller

666-667

TILLER



29

TILLER

Idler Pulley



ID 5/8"
OD 2"
Height 7/8"
Bushing 1"

Order No. 13 - 435

Idler Pulley Assembly. Replaces Gilson 33632.



ID 1" (25.40 mm)
OD 1-31/32" (50.01 mm)
Height 19/32" (15.08 mm)

Order No. 09 - 814

Replaces Gilson 1046, 1045.

Order No. 09 - 813

Used on many different models. See Section 9 for references.



ID 3/4" (19.05 mm)
OD 1-25/32" (45.24 mm)
Height 21/32" (16.67 mm)

Bushing



ID 3/4"
OD 7/8"
Height 1"

Order No. 29 - 820

Replaces Gilson 1024.

Universal Hitch Pin Assembly

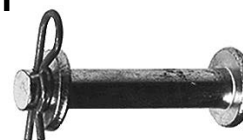

Order No. 29 - 31

2-1/4" x 1/2".

Seals (Cont.)



Order No. 29 - 482

Oil Seal for Merry Tiller Box. Replaces National 340356. 1-1/4" ID, OD 1-11/16". Also replaces Snapper 7013681. MIN010

Order No. 29 - 450

Oil Seal. Replaces Gilson 1054 and National No. 471224, Atlas 74-15, General Power 774-547. 1" x 1-1/2" x 1/4". MIN010

Oil Seal for TROY BILT



Order No. 29 - 8406

Oil seal replaces Troy Bilt 9618. Fits tine seal on Horse model tillers. 2" OD X 1-1/4" ID. MIN010

Oil Seal for TROY BILT



Order No. 29 - 8407

Oil seal replaces Troy Bilt 9621. Fits axle seal on Horse model tillers. 1-1/2" OD X 1" ID. MIN010

Tiller Reversing Disc for TROY BILT



ID 3/8"
OD 3-3/4"

Order No. 29 - 8192

Tiller reversing disc replaces Troy Bilt 1919, 2111 and 88174. Used on newer Horse models DP630-1260 since 1989.

Left & Right Hand Tiller Tines for HONDA

Order No. 29 - 8608

Left hand tiller tine replaces Honda 72461-723-700, Maxim 130721. Two 3/8" mounting holes, 3-1/8" center to center, 14" bolo tine.

Order No. 29 - 8609

Right hand tiller tine replaces Honda 72465-723-700, Maxim 130720. Two 3/8" mounting hole, 3-1/8" center to center, 14" bolo tine.

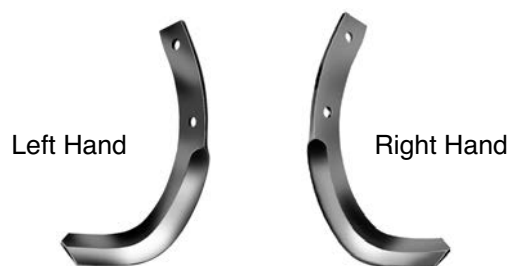



**Tine Shaft for
TROY BILT**

OD 1-1/4"
Length 7"

29

Order No. 29 - 8501

Tine shaft replaces Troy Bilt 1026A. Fits rear tine tiller models Horse 1, 2 & 3 - 6, 7 & 8 hp. Models OPC Horse & PTO Horse.



**Tiller Tines for
TROY BILT**



Order No. 29 - 8620

Tiller tine set replaces Troy Bilt 10802, 1901118, fits Pony & Horse models. Set contains (8) of our **29-8610** left hand & **29-8611** right hand tiller tines, (32) of our **29-8621** cap screw, **29-8622** hex nut, **29-8623** lock washer.

Order No. 29 - 8610

Left hand tiller tine replaces Troy Bilt 1270-1A, Fits Pony & Horse models. Fits Ariens 129359, MTD 742-0105, Roper 449J/6554J, Roto Hoe 1569. Three 3/8" bolt holes, 2-5/8" or 3-1/8" center to center, 12" bolo tine.

Order No. 29 - 8611

Right hand tiller tine replaces Troy Bilt 1270-2A, fits Pony & Horse models. Fits Ariens 129259, MTD 742-0106, Roper 4460J/6555J, Roto Hoe 1570. Three 3/8" bolt holes, 2-5/8" or 3-1/8" center to center, 12" bolo tine.

**Tiller Tines for
TROY BILT**



Order No. 29 - 12703

10" tiller tine **Set** replaces Troy Bilt GW-1901. Used on Troy Bilt Bronco, Pro-line, Tuffy from 2005-up. Set contains (8) of our **29-12859** & (8) **29-12860** tines, (32) of our 29-8621 cap screw, **29-8622** hex nut, **17-141** lock washer.

Order No. 29 - 12859

10" tiller tine **Right Hand** replaces Troy Bilt 742-04116-0637. Used on Troy Bilt Bronco, Pro-line, Tuffy from 2005-up. (2) mounting holes.

Order No. 29 - 12860

10" tiller tine **Left Hand** replaces Troy Bilt 742-04117-0637. Used on Troy Bilt Bronco, Pro-line, Tuffy from 2005-up. (2) mounting holes.

Tiller Tine Hardware Kit



Order No. 29 - 10298

Tiller tine hardware kit. Contains our (32) **29-8621** cap screw bolts, (32) **17-141** lock washers and (32) **29-8622** hex nut.



Order No. 29 - 8621

Cap screw for our **29-8620** tiller tine set. 3/8" - 1-1/4", grade 5 cap screw. MIN010



Order No. 17 - 141

Lock washer for our **29-8620** tiller tine set. 3/8" zinc lock washer. MIN010



Order No. 29 - 8622

Hex nut for our **29-8620** tiller tine set. 3/8" - 16 zinc hex nut. MIN010

TILLER



O.E.M. REPLACEMENT

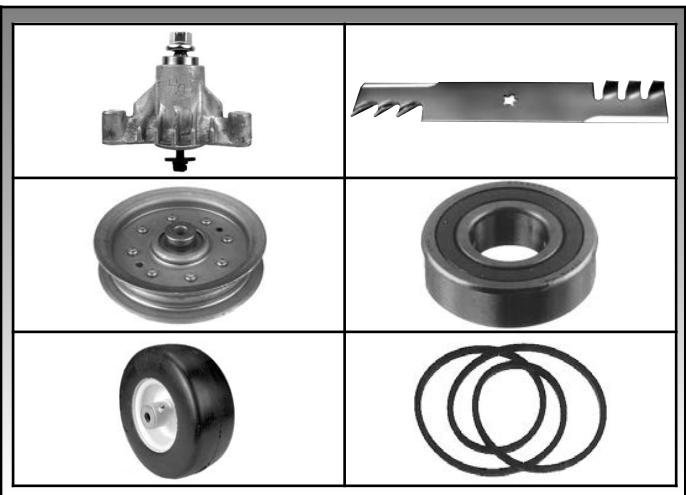
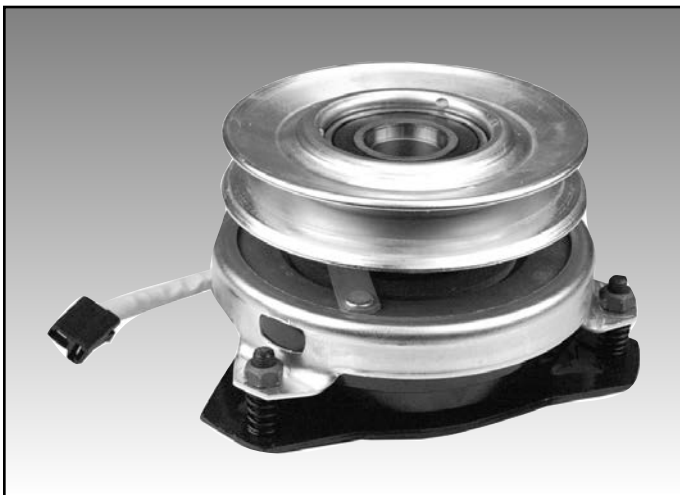

Quick-Glance
OEM REPLACEMENT PG.

AGS/SECO	670
Ariens	670-678
AYP	679-700
Bad Boy	701-704
Blue Bird	705
Bernard	704
Bobcat	706-716
Bolens	717-719
Bunton	720-724
Castle Garden	725-727
Cub Cadet	728-746
Dixie Chopper	747-756
Dixon	757-759
Exmark	761-789
Flymo	790
Gilson	791-792
Grasshopper	793-800
Gravely	800-807
Great Dane	808-810
Honda	811-830
Hustler	831-839
Husqvarna	839-856
Iseki (Export)	857
John Deere	858-887

Quick-Glance
OEM REPLACEMENT PG.



Kubota	888-891
Lawn-Boy	892-899
Lesco	900
Marina (Export)	901
McLane	901-902
Mountfield	903
MTD	903-937
Murray	938-956
Noma	957-962
Partner	963
Power Trim	964
Pilote	964-965
Sarlo	965
Scag	966-990
Snapper	991-1016
Stiga	1017-1020
Toro	1021-1043
Velke	1044-1045
Walker	1046-1049
Wikov-Slavia	1049
Woods	1050-1051
Wolf	1051
Yazoo	1052-1053
Viking	1054-1055

30
Quick-Glance



O.E.M. REPLACEMENT

AGS / SECO

ORDER NO.	REPLACES O.E.M. NO.	LENGTH	CENTER HOLE DIAM.	OUTSIDE HOLE DIAM.	CENTER TO CENTER	WIDTH	STEEL THICK.	APPLICATION
 15 - 6482	532-050-422-533	20-1/2" 520.7mm	.640" 16.2mm	.265" 6.7mm		5-1/8" 130mm	.160" 4.1mm	Left side blade. Right Hand rotation.
 15 - 6483	532-050-422-543	20-1/2" 520.7mm	.640" 16.2mm	.265" 6.7mm		5-1/8" 130mm	.160" 4.1mm	Right side blade. Left Hand rotation.

30

AMF/ DYNAMARK (See Noma)

ARIENS

O.E.M.



Conduit 38-7/8"
Inner Wire 39-7/8"
Wire Travel 1-1/2"

Order No. 03 - 9127

Throttle control replaces Ariens 69087. Fits rear engine riders with Tecumseh engines. Vinyl wrapped conduit.



Conduit 50-7/8"
Inner Wire 52-7/8"
Wire Travel 1-1/2"

Order No. 03 - 9128

Throttle control replaces Ariens 69076. Fits B&S powered rear engine riders from 1971-1979.



Conduit 27-1/8"
Inner Wire 29"
Wire Travel 1-3/4"

Order No. 03 - 9129

Throttle control replaces Ariens 69032. Fits snowblower models 10954, 10962, 10965, 10969, 10970. Negative action "F" to "S". Has bracket for side mounting.



ID 3"
OD 6"

Order No. 05 - 300

Drive Disc replaces Ariens 3003.



ID 2-1/4"
OD 4-7/16"

Order No. 05 - 7018

Driven Disc replaces Ariens 3240700, 3248300, 22013, 82-90 models. Fits 21" self-propelled mowers.



Order No. 42 - 14185

Pro-Gear 30-1001 Coupler. Replaces Peerless 786177, Ariens 04901200 9-Spline

Pro-Gear Transmission 5 Speed

Order No. 42 - 14177

Pro-Gear T7511 5-Speed transmission replaces Peerless 700-079, Ariens/Gravely 04901000/49010.





ARIENS (Cont.)



Order No. 42 - 14181

Pro-Gear 30-1019 Drive Shaft. Replaces Peerless 776468 & Ariens/Gravely 04923100. 6-1/8" Long, 9-Spline



ID 1/2"
Width 2-3/4"
Height 5"

Order No. 07 - 6916

Deck Wheel replaces Ariens 34717. 2-1/2" offset hub.



Order No. 08 - 8006

CARLISLE Tires with Snow Hog Tread. 410 X 4, 2 ply tubeless tire. Replaces Ariens 71211.

Order No. 08 - 8007

CARLISLE Tires with Snow Hog Tread. 410 X 6, 2 ply tubeless tire. Replaces Ariens 71213. Fits models 932026, 932 27, 932 29 & early model 932022 smaller snowthrowers.



Order No. 08 - 10461

11 x 400 x 5, 4 ply smooth tread Caster wheel assembly replaces Ariens 1588100. Mounted on a 5 x 3.25 steel wheel with 5" centered hub length, 3/4" angular contact heavy duty ball bearings. Fits 90 series riders with front cut 50", 60" & 72" decks. (Yellow)



Order No. 08 - 11217

9 x 350 -4, Reliance Wheel Assembly, smooth tread wheel assembly. Replaces Ariens 71301. Mounted on a flat base 4" x 2.25" steel wheel painted white with 3.25" centered hub length and 3/4" roller bearings.



Order No. 08 - 11062

13 x 500 -6 Reliance rib tread wheel assembly. Mounted on a 6" x 3.25" steel wheel painted silver with 3.75" centered hub length, without bearings. Replaces Gravely 52586 / 45205, Ariens 71301.



- 1 Piece Rim
- Flat Proof
- Semi Pneumatic

Order No. 08 - 10742

Wheel assembly replaces Ariens 01588100. 11x400-5 Reliance rib tread tire. 5" centered hub length, 3/4" roller bearings. Includes grease zerk. Painted white.



Order No. 08 - 8550

Caster wheel replaces Ariens 1588100. 9 x 350 x 4, 4 ply smooth tread tubeless tire, 1 piece. rim, 3/4" open cage roller bearing and zerk fitting. 4" hub length. Uses our 09-8706 spanner bushing. (painted yellow)

30

O.E.M.

O.E.M. REPLACEMENT



ARIENS (Cont.)



Order No. 08 - 8197

9 x 350 x 4 smooth tread 4 ply tire with tube, 3 piece rim, 3-1/4" centered hub with 3/4" open cage roller bearing and zerk fitting. Replaces Ariens 7130100. (painted white)



ID 3/4" (19.05 mm)
OD 1" (25.40 mm)
Height 5/8" (15.88 mm)

Order No. 09 - 8445

Snowblower axle bushing replaces Ariens 55039. Fits older Ariens snowblowers model 1032. Oil impregnated, bronze.



ID 1" (25.40 mm)
OD 1-1/8" (28.58 mm)
Height 5/8" (15.88 mm)

Order No. 09 - 8446

Snowblower auger bushing replaces Ariens 55035. Fits all auger side bushing models 1960 to present. Oil impregnated, bronze.



ID 3/4" (19.05 mm)
OD 1-25/32" (45.24 mm)
Height 19/32" (15.08 mm)

Order No. 09 - 484

Spindle Bearing replaces Ariens 54073 & 54120. Used on our 10-7154 Shaft. Bearing No. 9504-22.



ID 3/4" (19.05 mm)
OD 1-25/32" (45.24 mm)
Height 21/32" (16.67 mm)

Order No. 09 - 813

Replaces Ariens 54045 and 54055.



ID .787" (19.98 mm)
OD 1.850" (46.99 mm)
Height 9/16" (14.29 mm)

Order No. 09 - 442

Replaces Ariens 54123. Bearing No. 6204-2RS.



ID 1/2" (12.70 mm)
OD 1-3/8" (34.93 mm)
Height 7/16" (11.11 mm)

Order No. 09 - 8869

Bearing replaces Ariens 54080. Fits 21" self propelled walk behind mowers with 5/8" axle. Used in our 09-8823 bearing kit. Also fits model 824 snowblowers.



ID 3/4" (19.05 mm)
OD 1-3/4" (44.45 mm)
Height 1/2" (12.70 mm)

Order No. 09 - 487

Sealed high speed bearing. Replaces Ariens 54063. Bearing No. SC0493LU



ID 3/4" (19.05 mm)
OD 7/8" (22.23 mm)
Height 21/32" (16.67 mm)
Flange OD 1-3/16" (30.16 mm)

Order No. 09 - 8783

Bushing replaces Ariens 55216. Fits newer snowblower models ST-524 & ST-724. Oil impregnated, iron.



ID 7/8" (22.23 mm)
OD 1" (25.40 mm)
Height 5/8" (15.88 mm)
Flange OD 1-1/4" (31.75 mm)

Order No. 09 - 8796

Axle bushing replaces Ariens 55030. Fits snowblower models 910 & 924. (Bronze)

30

O.E.M.



ARIENS (Cont.)



Order No. 10 - 9911

Electric PTO clutch replaces Ariens 03643100. 1" ID x 3" Height, 5.375 pulley, 5/8" belt.



Order No. 10 - 9912

Electric PTO clutch replaces Ariens 03601800. 1" x 3" Height, 5.375" Dia. Pulley, 5/8" belt. Warner No. 5217-2.



Order No. 10 - 9913

Electric PTO clutch replaces Ariens 03090800. Double Pulley, 1-1/8" x 3-3/4" Height. 5" Dia Pulley, 1/2" belt. Warner No. 5215-62



Order No. 10 - 11070

Electric PTO clutch replaces Ariens 03450500, Warner 5215-88.



Order No. 10 - 11071

Electric PTO clutch replaces Ariens 9225400, Warner 5218-10.



Order No. 10 - 11664

Electric PTO clutch replaces Ariens 574100, 55430. 4-7/8" Dia. Pulley. 1/2" Belt, shaft size 1". Warner 5218-27.



Order No. 10 - 14009

Electric PTO clutch replaces Ariens 09232700. Warner 5218-94. 1-1/8" ID, 6" OD, for 5/8" belt.



Order No. 10 - 14495

Electric clutch replaces Ariens 09407700. Warner 5218-58, 5218-26. 1-1/8" ID, 3-1/2" height, 1/2" belt, 4-7/8" pulley.



Order No. 10 - 8682

3/8" - 24 Female right hand thread ball joint. Fits go-carts & Wagons. Fits Ariens 36531.



Order No. 15 - 911

Air Lift kit. Replaces Ariens 527011. Used on our 15-1096, 15-3323, 15-3324 and 15-2137 blades.

30
O.E.M.

O.E.M. REPLACEMENT



ARIENS (Cont.)

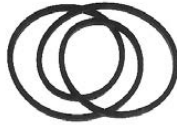



30
O.E.M.

Order No.	Description
12 - 8425	Snowblower Belt. Replaces Ariens 72114. 1/2" (12.70 mm) width x 34-1/2" (876.30 mm) length, raw edge belt.
12 - 8426	Snowblower Belt. Replaces Ariens 72131. 3/8" (9.53 mm) width x 36" (914.40 mm) length, raw edge belt. Fits models 924085, 924087, 924091 & 924092, 12 hp engines.
12 - 8427	Snowblower Belt. Replaces Ariens 72130. 1/2" (12.70 mm) width x 39" (990.60 mm) length, raw edge belt. Fits models 924085, 924087, 924091 & 924092, 10 hp engines.
12 - 8428	Snowblower Belt. Replaces Ariens 72108. 1/2" (12.70 mm) width x 37" (939.80 mm) length, raw edge belt. Fits models 924084, 924086, 10 hp engines.
12 - 8429	Snowblower Belt. Replaces Ariens 72098. 3/8" (9.53 mm) width x 33" (838.20 mm) length, raw edge belt. Fits 92400 series. Models 00026, 27, 32, 33, 36, 38, 39, 46, 48, 49 & some 51, 52.
12 - 8430	Snowblower Belt. Replaces Ariens 72066. 3/8" (9.53 mm) width x 34" (863.60 mm) length, raw edge belt. Fits models 924080, 924082, 924084, 924085, 924086, 924087, 8-12 hp engines.
12 - 8431	Snowblower Belt. Replaces Ariens 72086. 1/2" (12.70 mm) width x 40" (1016.00 mm) length, raw edge belt. Fits models 924082, 8 hp engines.
12 - 8432	Snowblower Belt. Replaces Ariens 72047. 3/8" (9.53 mm) width x 35-1/2" (901.70 mm) length, wrapped belt. Fits older model Ariens with single belt.
12 - 8762	Snowblower Belt. Replaces Ariens 72023. 1/4" (6.35 mm) x 27.153" (689.69 mm). Fits models 1975-1978 & Sno-Tro model. Drive belt 4 & 5 hp, 1969-1974 models 922018, 922019, 922020 & 922021. Raw edge, traction drive belt. Sold in matching pairs.
12 - 13284	Snowblower Belt. Replaces Ariens 7207400 . 1/4" (6.35 mm) x 27" (685.8 mm). Fits 6 HP Sno-Thro models. Traction Drive. Set of (2) matched belts.
12 - 13505	Snowblower Belt. Replaces Ariens 7200004 . 1/2" (12.7 mm) x 35.4" (899 mm). Fits 924 series Snow Throwing models. Laminated, Aramid cord construction.
12 - 13506	Snowblower Belt. Replaces Ariens 7236200 . 1/2" (12.7 mm) x 37-1/2" (952.5 mm). Auger Drive belt fits 924 series Snow Throwing models. Laminated, Aramid cord construction.
12 - 13507	Snowblower Belt. Replaces Ariens 7200021 . 1/2" (12.7 mm) x 38" (965.2 mm). Auger Drive belt fits 926 series Snow Throwing models. Laminated, Aramid cord construction.
12 - 13508	Snowblower Belt. Replaces Ariens 7200020 . 1/2" (12.7 mm) x 37-1/8" (943 mm). Auger Drive belt fits 926 series Snow Throwing models. Laminated, Aramid cord construction.
12 - 13509	Snowblower Belt. Replaces Ariens 7200007 . 1/2" (12.7 mm) x 34-7/8" (886 mm). Auger Drive belt fits 932 series Snow Throwing models. Laminated, Aramid cord construction.

*Made with KEVLAR® or non-trade marked Aramid fiber.



ARIENS (Cont.)

ORDER NO.	REPLACES O.E.M. NO.	LENGTH	CENTER HOLE DIAM.	OUTSIDE HOLE DIAM.	CENTER TO CENTER	WIDTH	STEEL THICK.	APPLICATION
15 - 14540	 04265400	14-7/8" 355.6mm	5/8" 15.8mm			2-1/4" 50.8mm	.187" 4.7mm	Fits ZT42, Zoom 42
15 - 3326	30278	16-5/8" 422.3mm	3/4" 19.1mm			2-1/2" 57.2mm	.180" 4.8mm	Center blade for Ariens 60" cut, GT-Decks (3) blades for 48" cut
15 - 6060	3123759 31237	16-5/8" 422.3mm	3/4" 19.1mm			2-1/2" 57.2mm	.204" 5.2mm	(3) blades for 48" cut Deck #831031 GT
15 - 13177	 03746500 03971900	17.35" 440.6mm	5/8" 15.8mm			2-1/4" 50.8mm	.187" 4.7mm	Fits ZT50, Zoom 50
15 - 6254	3624759 36247	20-5/16" 515.9mm	3/4" 19.1mm			2-1/2" 63.5mm	.204" 5.2mm	(2) blades for 40" cut front engine rider model YT 13, 14 & 15 hp
15 - 3322	11370	20-1/2" 546.1mm	13/32" 10.3mm			2-3/4" 69.9mm	.160" 4.1mm	Zone start mower Used on 21" walk behind mowers
15 - 6445	2749351	26-7/8" 682.6mm	7/16" 12.7mm	3/8" 9.5mm	4" 44.5mm	2-3/4" 69.9mm	.187" 4.8mm	Fits 28" Riding mowers.
15 - 3323	2728551 27285	28" 711.2mm	3/4" 19.1mm	25/64" 9.9mm	11" 279.4mm	2-3/4" 69.9mm	.180" 4.6mm	For 28" rear engine rider Uses our 15-911 Air lifts.
15 - 2137	2728759 27287	30" 762mm	3/4" 19.1mm	25/64" 9.9mm	11" 279.4mm	2-3/4" 69.9mm	.187" 4.8mm	For 30" rear engine rider Uses our 15-911 Air lifts

30 O.E.M.

Overall Length 7-9/16"



Order No. 20 - 7783

Fuel gauge replaces Ariens 31819. Fits YT series 10 hp front engine riders.

Diameter 3-1/2"



Order No. 20 - 9650

Vented fuel cap replaces Ariens 7525300 and many more.



O.E.M. REPLACEMENT

ARIENS (Cont.)



Order No. 29 - 8620

Tiller tine set. Set contains (8) of our 29-8610 left hand & 29-8611 right hand tiller tines, (32) of our 29-8621 cap screw, 29-8622 hex nut, 29-8623 lock washer.

Order No. 29 - 8610

Left hand tiller tine replaces Ariens 129359. Three 3/8" bolt holes, 2-5/8" or 3-1/8" center to center, 12" bolo tine.

Order No. 29 - 8611

Right hand tiller tine replaces Ariens 129259. Three 3/8" bolt holes, 2-5/8" or 3-1/8" center to center, 12" bolo tine.



Order No. 29 - 8621

Cap screw for our 29-8620 tiller tine set. 3/8" - 1, grade 5 cap screw. Packaged in lots of 10
MIN010



Order No. 17 - 141

Lock washer for our 29-8620 tiller tine set. 3/8" zinc lock washer. Packaged in lots of 10
MIN010



Order No. 29 - 8622

Hex nut for our 29-8620 tiller tine set. 3/8" - 16 zinc hex nut. Packaged in lots of 10
MIN010

30

Starter Extension Cord for Ariens

Order No. 26 - 13643

Starter extension cord replaces Ariens 2483100, Included in our 26-10975, 26-10976, 26-10982 starters.



Order No. 21 - 13998

Arm rest replaces Ariens/Gravely 01552900/715095 kit.

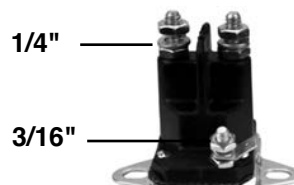

Order No. 31 - 3319

Solenoid replaces Ariens 3057700.



Order No. 31 - 5933

Universal Solenoid replaces Ariens 35510



Order No. 31 - 8943

Universal Solenoid. Replaces Ariens 35510.



Order No. 31 - 10771

Universal starter solenoid 3 pole, 12 volt. Terminal post will accommodate both 5/16" & 1/4" terminal connectors, Mounting bracket will accommodate both chassis and wall mount configurations. Replaces Ariens 3057700.



Order No. 31 - 10772

Universal starter solenoid 4 pole, 12 volt. Terminal post will accommodate both 5/16" & 1/4" terminal connectors, Mounting bracket will accommodate both chassis and wall mount configurations. Replaces Ariens 35510.



ARIENS (Cont.)



Order No. 31 - 13278

Starter key replaces Ariens 7500108/7532000. Pull / Push Key. MIN010

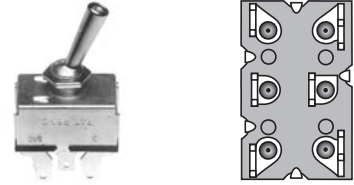

Order No. 31 - 7922

PTO Switch replaces Ariens 36024. Fits 936 series YT tractor models 936002, 936003, 936004, 936005, 936006, 936008, 936009, 936010, 936011, 936012. Includes mounting hardware.



Order No. 31 - 12839

Ignition switch replaces Snapper 7072684YP, Scag 483472, Ariens 03277000, Bush Hog 50047912. Plastic snap bezel. 3 position 5 terminals.



Order No. 31 - 14291

Seat switch replaces Ariens 03490500/3490500. Normally Open.



Order No. 31 - 9622

Multi-application start ignition switch only fits single stage Ariens. Includes key, lockwasher nut. 2 terminals/ 2 positions.

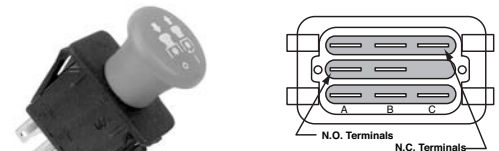

Order No. 31 - 9657

PTO switch replaces Ariens 5221. Middle terminal blank. Push-pull/Snap in mount. Red Knob

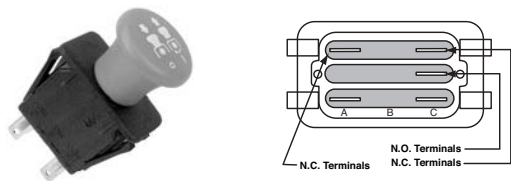

Order No. 31 - 11470

PTO switch replaces Ariens 1545600. Fits Lazer Z, Turf Tracer, & Turf Ranger Models. Red Knob

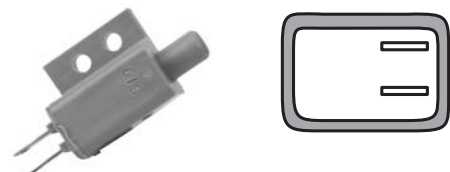

Order No. 31 - 9658

Plunger Interlock switch replaces Ariens 30957. Single pole, normally closed.



Order No. 31 - 9659

Plunger Interlock switch replaces Ariens 088281. Double pole, normally open / normally closed.

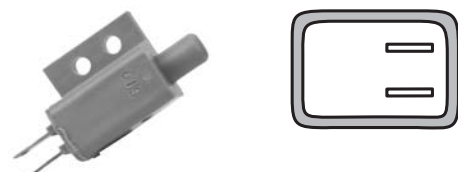

Order No. 31 - 9660

Plunger Interlock switch replaces Ariens 36571. Single pole, normally open.

30

O.E.M.

O.E.M. REPLACEMENT



ARIENS (Cont.)

Order No. 31 - 9663

Plunger Interlock switch replaces Ariens 27541. Single post, right angle snap in mounted. Normally open.



Order No. 41 - 5575

Shear pin replaces Ariens 52100100. Includes bolts and nuts. Fits new 2007 model series 921001, 921002 & 921003 that take the new black shear bolt. 1/2" wrench size.

MIN005



Order No. 41 - 916

Shear Pin. Replaces Ariens 510015. Packaged in lots of 5. MIN005

Order No. 41 - 918

Shear Pin. Replaces Ariens 532005. Packaged in lots of 5. MIN005



Order No. 41 - 917

Shear Pin. Replaces Ariens 532005, 510016. Packaged in lots of 5.

MIN005



Order No. 41 - 5510

Scrapers bar replaces Ariens 32159. Fits model 2 + 2. 20" length x 2-5/8" width x 7/8" mounting holes.



Order No. 41 - 5566

Scrapers bar replaces Ariens 10164. Fits model 924082. 23-3/4" length x 2" width x 1/4" mounting holes.

Order No. 41 - 5567

Scrapers bar replaces Ariens 22107. Fits all 20" augers. 19-1/4" length x 1-5/8" width x 3/8" mounting holes.



Order No. 41 - 13168

Scrapers blade replaces Ariens 03809400. Fits models SS522, SS722E, S322.

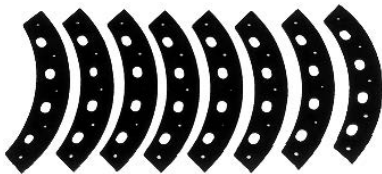

Order No. 41 - 5502

Rubber Paddle replaces Ariens 532018. Fits all 2 + 2 models. 8 piece set.



Order No. 41 - 5585

Universal snowblower skid shoes set. Fits most Ariens. 2 stage snowthrowers. Eccentric washers allow mounting to a variety of mounting dimensions. Mounting width (min 2", max 3", 5/16" bolt holes. Similar to our 41-8635.



Order No. 41 - 5134

Double sided, reversible runner replaces Ariens 02483851, 02483859. Fits all Ariens snowblowers from 60's until present. Used on models 924080 & 924082 with 24" auger. Painted orange.



Order No. 41 - 5568

Snowblower shoe replaces Ariens 24599. Fits all Ariens blowers from 60's until present. Ariens models 924080 & 924082 with 24" auger.

30

O.E.M.



AS MOTOR

ORDER NO.	REPLACES O.E.M. NO.	LENGTH	CENTER HOLE DIAM.	OUTSIDE HOLE DIAM.	CENTER TO CENTER	WIDTH	STEEL THICK.	APPLICATION
 15 - 50127	10004145	630 mm	.79" 20.24mm			3.00" 76.20mm	.187" 4.76mm	

AYP - SEARS/ROPER/HUSKY/POULAN

Thread Size 5/16" - 18
Thread Length 1-1/4"



Order No. 02 - 9374

Mounting Bolt, Hex head self-tapping screw replaces AYP 138776, 173984, 157722. Fits AYP, models PP 18hp, 44" 9540052-61 quill assembly. Mounting bolt for our **10-8479** quill assembly. **Packaged in lots of 10.** MIN010

Thread Size 3/8" - 16
Thread Length 3/4"



Order No. 02 - 9373

Mounting Bolt, Hex head self-tapping screw replaces AYP 17000612, 17490612. Fits AYP, Roper, Sears quill assemblies. Used with our quill assemblies **10-8649, 10-8647, 10-1171, 10-6813, 10-2914.** **Packaged in lots of 10.** MIN010



Order No. 02 - 9372

Klip ring replaces AYP 12000029. Fits king pin on 16, 18 & 20 hp garden tractors from 1991 to present. Also used to retain steering bell crank assy on 16hp garden tractors and to retain sector on 18 & 20 hp models. Fits 3/4" Shafts. **Packaged in lots of 10.** MIN010

Conduit 52"
Inner Wire 59-3/16"

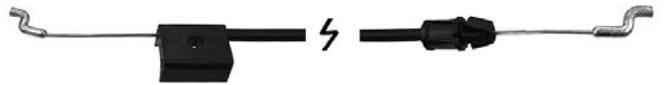

Order No. 03 - 9566

Engine stop cable replaces AYP 130861. Fits 22" walkbehind push mowers. Model PP751. Also fits YardPro & Husky mowers. "Z" Bend at both ends.

Conduit 63"
Inner Wire 64-7/8"
Wire Travel 1-7/8"



Order No. 03 - 9679

Throttle control replaces AYP 851462.

Conduit 47"
Inner Wire 49-1/4"
Wire Travel 2-1/4"



Order No. 03 - 9680

Throttle control replaces AYP 700417. Fits 20" & 22" side and rear discharge mowers. Axial negative.

Conduit Length 56"
Inner Wire 59-3/4"



Order No. 05 - 14623

Drive control & cable replaces AYP 700615, 146323, 145755, 184588, 184596. Fits 22" self-propelled mowers. Flexible innerwire with spring on end Z-bend on spring.



O.E.M. REPLACEMENT



AYP - SEARS/ROPER/HUSKY/POULAN

Conduit 59-3/4"
Inner Wire 63-1/2"

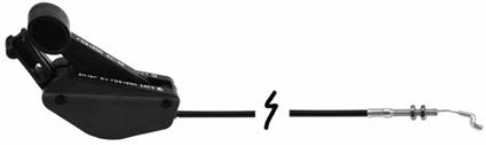

Order No. 05 - 13548

Drive control cable replaces AYP 87025, 133049.

Conduit 54"
Inner Wire 60"
Wire Travel 6"



Order No. 26 - 13355

Control cable replaces AYP 156581,156577,168552.

30



Order No. 05 - 10891

Deck engagement cable replaces AYP 175067/169676. Fits 42" riders.



Order No. 05 - 13380

Deck engagement cable replaces AYP 193235, Poulan 532193235. Fits 38" decks. Conduit Length 29-3/4", Cable Length 45-1/8", Spring Length 6", Coil Length 5"

O.E.M.



ID 5/8"
OD 2-3/4"
Height 1-7/8"

Order No. 05 - 308

Drive Roller replaces AYP 79951, Sears/Roper 79951.



ID 1/2"
OD 1"
Height 5/8"

Order No. 05 - 422

Replaces Sears 67486. For 43 chain, 9 tooth.

Order No. 05 - 5620

Ring rubber wheel replaces AYP 179831. Fits many units built since 2002.



ID 3-5/8"
OD 4-1/2"



Order No. 07 - 10758

Drive wheel replaces AYP 700953. 8" x 2" x 1/2" bore. lug gear tread, hub 1.60" offset. Fits self propelled mowers. 53 teeth.



Order No. 07 - 283

8" x 1.75", 1/2" C.H., 1-3/8" offset hub, lug tread AYP 148436.



Order No. 07 - 282

8" x 1.75", 1/2" C.H., 1-3/8" offset hub. Fits Toro 10-9680. Replaces AYP 103670X.



Order No. 07 - 9156

16" x 1.75 Universal plastic gray spoke wheel. Replaces AYP 851801 & MTD 734-1842 & 734-1661. 2-1/2" centered hub, 1/2" bearings. 1/2" ID.



AYP - SEARS/ROPER/HUSKY/POULAN



Order No. 07 - 13495

12" x 1-3/4" hub length, radial tire, 6 spoke rim 1/2" sealed ball bearings, replaces AYP 431880X460 / 194387X460. Gray Plastic.



Order No. 07 - 14035

5" x 1-7/8" x 1/2" bore, deck wheel replaces AYP 188606. Also replaces Husqvarna 532188606.



ID 1/2"
Width 1-3/8"
Height 5"

Order No. 07 - 6915

Deck Wheel replaces Sears/Roper 105455X. 1-1/2" centered hub with steel bushing.



ID 7/16"
Width 1-3/4"
Height 3"

Order No. 07 - 6909

Deck Wheel replaces Roper 109729X. 1-7/8" centered hub.



ID 1/2"
Width 2-3/4"
Height 5"

Order No. 07 - 6916

Deck Wheel. Replaces AYP 133957. 2-1/2" offset hub.



ID 3/8" (9.53 mm)
OD 17/32" (13.49 mm)
Height 15/32" (11.91 mm)
Flange OD 11/16" (17.46 mm)

Order No. 09 - 7279

Draglink bushing for front engine riders, replaces AYP 126847X. (4 per unit) Packaged in lots of 4.

MIN004



ID 3/4"
OD 1-3/8"
Height 1"

Order No. 09 - 13359

Wheel bearing/bushing replaces AYP 9040H / 532009040.



ID 3/4" (19.05mm)
OD 53/64" (21.83mm)
Height 25/32" (19.84mm)
Flange OD 1-1/8" (28.58mm)

Order No. 09 - 9745

King pin bushing replaces AYP 121922x.

MIN010



ID .787" (19.98 mm)
OD 1.850" (46.99 mm)
Height 9/16" (14.29 mm)

Order No. 09 - 442

Bearing replaces AYP 129895. Fits our quill assembly 17-8479. Bearing No. 6204-2RS.



ID 21/32" (16.67 mm)
OD 1-9/16" (39.69 mm)
Height 15/32" (11.91 mm)

Order No. 09 - 8507

Bearing replaces AYP 110485X. Fits AYP 130794 quill assembly (top bearing). Bearing No. 6203-2RS.

30
O.E.M.

O.E.M. REPLACEMENT



AYP - SEARS/ROPER/HUSKY/POULAN



ID 21/32" (17 mm)
OD 1-9/16" (40 mm)
Height 15/32" (12 mm)

Order No. 09 - 7917

Bearing used in 10-1172 quill assembly. Bearing No. 6203ZZ.



Order No. 09 - 9747

Roller cam assembly replaces AYP 155066. Assembly for AYP 42" Deck. Used with our 10-8830 shoulder bolt.

MIN005



ID 3/4" (19mm)
Height 1-39/64" (25.4mm)



Order No. 09 - 5618

Auger bearing replaces AYP 187925. 3-5/8" x 2" flange.



Order No. 10 - 13225

Shaft support replaces AYP 160395/124035X. Fits Sears model 917.257360.



Order No. 10 - 2210

Ball Joint Assembly. 3/8"-24. Right hand threads. Replaces AYP 109850X.



Order No. 10 - 9489

3/8" - 24 Left hand ball joint replaces AYP 109851X. Also replaces MTD 923-0351.



ID 1/2"

Order No. 10 - 6887

Steering Sector replaces Sears 102787X.



Length 23"

Order No. 10 - 7782

Steering pinion replaces AYP 102817X. Fits front engine rider models L0815AR, L0814AR, L0794BR, L0815BR L0794AR, L0784AR & L0774AR. Used with our 10-6887.



Size 1/2"- 13

Order No. 10 - 11142

Shoulder bolt replaces AYP 193406, 184219, 137644. Fits deck wheels on riders 2003 & up. **Packaged in lots of 10.**
MIN010



Order No. 10 - 8830

Shoulder bolt replaces AYP 131340. Fits 42" AYP vented decks. **Packaged in lots of 10.**
MIN010



Order No. 10 - 9718

Deck lift link replaces AYP 110448X. Total length 7-1/2"



ID 43/64"
OD 1-1/8"
Thickness 5/32"

Order No. 10 - 11474

Spacer washer replaces AYP 187690. Used with our 10-8479, 10-8549, 10-9519, 10-9520, 10-9574 & 10-9575 mandrel assemblies and shafts.
MIN010

30

O.E.M.



AYP - SEARS/ROPER/HUSKY/POULAN (Cont.)

Order No. 10 - 12309

Electric PTO clutch replaces AYP 174509, 124648X, 140923, 150283. 1.11" ID x 4.825" height, 5.31" pulley diameter, 1/2" Belt. Warner 5215-73. Clockwise direction.



Order No. 10 - 12980

Electric PTO clutch replaces AYP 174367. 1" ID x 6" pulley, 1/2" or 5/8" belt, 3-3/4" height. Warner 5215-134.



Order No. 10 - 9910

Electric PTO clutch replaces AYP 137140, 108218X & 142600. 1" ID Keyed hub, 5.304 Dia. Pulley. Warner No. 5215-51.



Order No. 10 - 11858

Electric PTO clutch replaces AYP 106316, 109550X. 1" ID x 6" pulley, A/B Belt type. Warner 5215-14.



Order No. 10 - 9912

Electric PTO clutch replaces AYP 145028. 1" x 3" Height, 5.375" Pulley, 5/8" belt. Warner No. 5217-2



Order No. 10 - 9911

Electric PTO clutch replaces AYP 160889, 145028. 1" ID x 3" Height, 5.375" Pulley, 5/8" belt



Order No. 10 - 11014

Spindle assembly replaces AYP 174356. Spindle shaft fits 48" decks built after 2001. Also replaces Husky 532-174356.



Order No. 10 - 12307

Spindle housing replaces AYP 174358. Housing only for our 10-11014 spindle assembly.



Order No. 10 - 12308

Spindle shaft replaces AYP 174360. Spindle only for our 10-11014 spindle assembly.

30

O.E.M.

O.E.M. REPLACEMENT



AYP - SEARS/ROPER/HUSKY/POULAN (Cont.)



Order No. 10 - 12723

Spindle assembly replaces AYP 130794. Six Pack.

MIN006



Order No. 10 - 12734

Spindle assembly replaces AYP 187292. Six Pack.

MIN006

Spindle Assembly for AYP

Order No. 10 - 11590

Spindle assembly replaces AYP 187292 & 192870. 4 hole mount. Taller version of our 10-11014 spindle assembly. Fits 46" deck, (2 blades).

Order No. 10 - 11591

Spindle Housing only replaces AYP 187281. 4 hole mount. Fits our 10-11590 spindle assembly.

Order No. 10 - 11592

Spindle Shaft only replaces AYP 187291. Shaft with bearing with grass shield & zerk. Fits our 10-11590 spindle assembly.

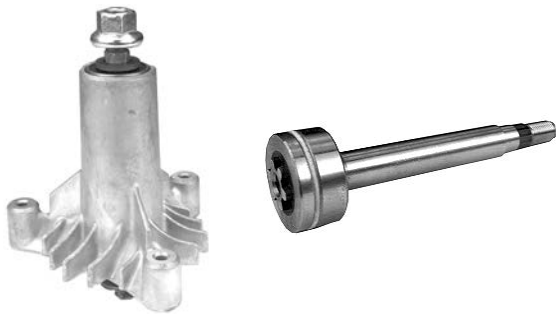

Order No. 10 - 9574

Spindle assembly replaces AYP 165579. Fits 36" rear discharge mowers. Using 6 point star center hole blade. Assembly includes our 10-9575 shaft, 10-8548 housing & 10-8901 pulley lock nut. Uses our 17-9586 blade bolt.

Order No. 10 - 9575

Mandrel shaft with bearings replaces AYP 165482. Using 6 point star center hole blade. Mandrel shaft for our 10-9574 spindle assembly. Includes 1 bearing, 2 washers. Uses our 17-9586 blade bolt.



Order No. 10 - 8901

Pulley lock nut replaces AYP139729, 137266. Fits our 10-8479 Spindle Assembly. Size 9/16" - 18

Order No. 10 - 8549

Mandrel shaft replaces AYP 137646. Fits 36", 38" & 42" Sears AYP mowers with ventilated decks using 5 point center hole blades. 3/4" OD shaft, 7" long. Comes with our 09-442 bearing. Shaft for our 10-8479 Mandrel assembly.

Order No. 10 - 8479

Mandrel assembly replaces AYP 130794. Fits 36", 38", & 42" AYP/Sears/Roper with ventilated decks using 5 point center hole blades. Uses our 09-442 & 09-8507 bearings.

Order No. 10 - 8548

Mandrel housing replaces AYP 128774. Housing only for our 10-8479 quill assembly.

30

O.E.M.



AYP - SEARS/ROPER/HUSKY/POULAN (Cont.)

Order No. 10 - 9519

Spindle assembly replaces AYP 143651. Fits 44", 46" & 50" decks with star center hole blade.



Order No. 10 - 9520

Spindle shaft only replaces AYP 137553. Used with our 10-9521 housing. Includes our 09-442 bearing. Double hex external spline for pulley.

Order No. 10 - 9521

Housing only replaces AYP 137152. Used with our 10-9520 spindle shaft. Cast aluminum housing. 3 bolt mounting.

30
O.E.M.

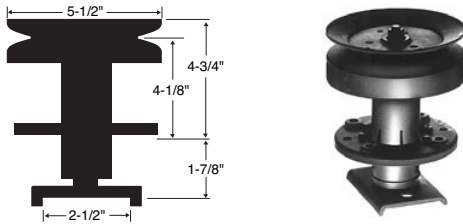

Order No. 10 - 1171

Quill Assembly replaces Sears 677A14, 101477X, 677A233. Weight is 3 lbs. 14.5 oz. Pulley 5-1/2", height 6-7/8", OD of saddle 3", ID of saddle 2-1/2", clearance 1-7/8".

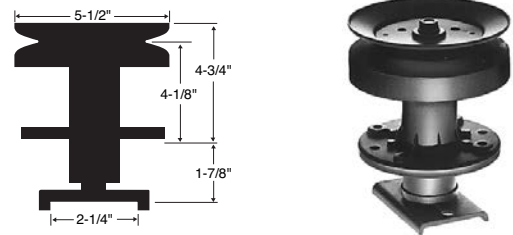

Order No. 10 - 6813

Quill Assembly replaces Sears 121676X, 121687X, 105891X. Fits 38" & 44" decks. Height 6-7/8", pulley 5-1/2", blade saddle 2-1/4".

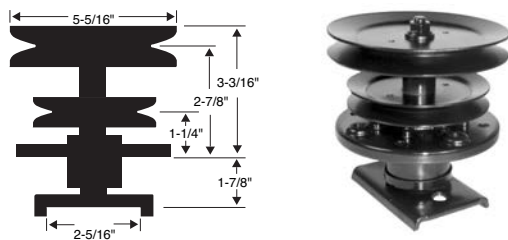

Order No. 10 - 8649

Quill assembly replaces AYP 121657X. Primary center quill on 20 hp 50" cut models. Fits models 4200-14, 951940, 8208A29 & TS2050A.

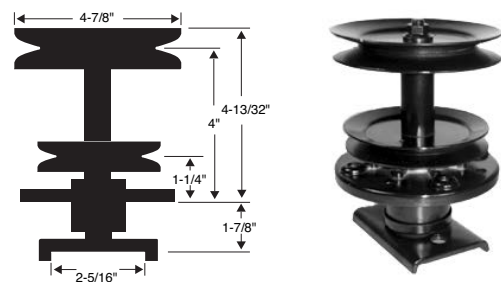

Order No. 10 - 8647

Quill assembly replaces AYP 121705X. Primary quill on 44" cut models GT2500BR, GT2500CR, RL1844B & PC18144A.

Order No. 10 - 8648

Quill assembly replaces AYP 136819. Fits 44" cut garden tractor, secondary, center & left side. Fits models GT2500BR, GT2500CR, RL1844B, PC1844A. Also fits 20 hp 50" cut models 4200-14, 951940.

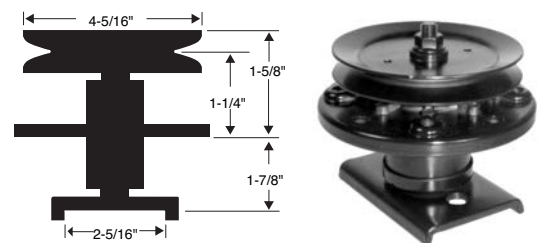

O.E.M. REPLACEMENT



AYP - SEARS/ROPER/HUSKY/POULAN (Cont.)



Order No.	Description
12 - 6900	Replaces Sears/Roper 124293X. 80" (2032 mm) x 1/2" (12.70 mm).
12 - 7184	Blade Belt. Replaces AYP - Sears/Roper 131290X. 88" (2235.2 mm). Fits 38" front engine rider model 7122A29.
12 - 6901	Blade Belt. Replaces Sears/Roper 106085X. 79.10" (2006.7 mm) x 17/32" (13.49 mm). Fits 18 hp rider tractors 36", 38" & 44" cut with electric clutch.
12 - 8464	Blade Belt. Replaces AYP 140067. 1/2" (12.70 mm) width x 82-1/2" (2095.50 mm) length. Fits 8 hp 36" cut model L1252AR, front engine rider.
12 - 8510	Blade Belt. Replaces AYP 62828. 1/2" (12.70 mm) width x 69-1/2" (1765.30 mm) length. Fits 8 hp 36" cut models L1252AR, L8212AR, front engine riders.
12 - 10232	Blade Drive Belt. Replaces AYP 174883. 21/32" (16.69 mm) x 97.4" (2473.96 mm). Secondary Drive Belt for 42" cut. Wrapped molded. General purpose, polyester cord construction, clutch cover.
12 - 8462	Drive Belt. Replaces AYP 131006. 1/2" (12.70 mm) width x 98-1/4" (2495.55 mm) length. Fits 18 hp 42" cut model RY1842A, WP1842A, front engine riders.
12 - 8465	Drive Belt. Replaces AYP 110883X. 1/2" (12.70 mm) width x 99" (2514.60 mm) length. Fits 20 hp 50" cut model 951940, front engine rider.
12 - 8781	Drive Belt. Replaces AYP 140218. 1/2" (12.70 mm) x 84.5" (2146.3 mm). Fits Western Auto 50" cut, model 8228A49 with 20 hp Kohler engine. *Aramid fiber.
12 - 9367	Drive Belt. Replaces AYP 137153. 1/2" (12.7 mm) x 83-1/2" (2120.9 mm). Fits 50" cut, 16hp engines. Model 8209B89. *Aramid fiber. White cover.
12 - 9767	Drive Belt. Replaces AYP 161741. 1/2" (12.7 mm) x 79" (2006.6 mm). Fits 10 & 11 HP, 36" cut front engine riders. *Aramid fiber.
12 - 9768	Drive Belt. Replaces AYP 163817. 1/2" (12.7 mm) x 95" (2413 mm). *Aramid fiber.
12 - 9768	Drive Belt. Replaces AYP 163817. 1/2" (12.7 mm) x 95" (2413 mm). *Aramid fiber.
12 - 9848	Drive Belt. Replaces AYP 146527. 3/8" (9.5mm) x 32-1/2" (825.5 mm). *Aramid fiber.
12 - 9697	Drive Belt Replaces AYP 144959. 1/2" (12.7 mm) x 95-1/2" (2425.4 mm). Fits model 24H4B3A, 8209A99. Fits 46" & 50" cut. 16, 22 & 24 hp engines. *Aramid fiber. Covered.
12 - 11862	Drive Belt. Replaces AYP 194346. 1/2" (12.7 mm) x 97.4" (2473.9 mm). Wrapped-molded, Aramid cord construction, double cover, clutching, brown color.
12 - 10306	Drive Belt. Replaces AYP 137078, 157769. 3/8" (9.52 mm) x 32.3/16" (817.8 mm). Fits self propelled walkbehind mowers. Fiberglass cord construction.

30 O.E.M.



AYP - SEARS/ROPER/HUSKY/POULAN (Cont.)



Order No.	Description
12 - 12892	Drive Belt. Replaces AYP 178138. 1/2" (12.7 mm) x 87.64" (2226.1 mm). Fits new 42" mower drive belt. Wrapped molded, aramid cord construction, double cover clutching, color brown.
12 - 8511	Deck Belt. Replaces AYP 130969. 1/2" (12.70 mm) width x 92-1/2" (2349.50 mm) length. Fits 12, 12.5, & 14 hp 42" cut models RL1242A, WP12542A, Y1442A, front engine riders.
12 - 8516	Deck Belt. Replaces AYP 144200. 1/2" (12.70 mm) width x 88-3/8" (2244.73 mm) length. Fits 42" cut decks with double idler pulleys.
12 - 8784	Deck Belt. Replaces AYP 138255. 1/2" (12.70 mm) x 95.25" (2419.4 mm). Secondary deck drive belt for 50" cut. *Aramid fiber.
12 - 9312	Deck Belt. Replaces AYP 158818. 1/2" (12.7 mm) x 83-5/8" (2124.1 mm) Fits 46" cut models. *Aramid fiber. Clutching cover.
12 - 9945	Deck Belt. Replaces AYP 110884X. 1/2" (12.7 mm) x 93-1/2" (2375 mm). Fits AYP models XEG11082HAR & PP2050 Poulan Pro PTO. *Aramid fiber.
12 - 9964	Deck Belt. Replaces AYP 174978. 1/2" (12.7 mm) x 84-1/2" (2146 mm). Fits 36" side discharge models. *Aramid fiber.
12 - 10005	Deck Belt. Replaces AYP 180217 , 165555. 1/2" (12.7 mm) x 106.9" (2715 mm). Fits 36" rear discharge lawn tractors. *Aramid fiber. Double "V"
12 - 11034	Deck Belt. Replaces AYP187283, 191273. 5/8" (15.875 mm) x 142.57" (3621.27 mm). Fits 54" mowers. Wrapped molded, neopreme, polyester cord construction, clutch cover.
12 - 8463	Deck Belt. Replaces AYP 131264. 1/2" (12.70 mm) width x 78-1/2" (1993.90 mm) length. Fits 10 hp 36" cut model WP1036A & 11 hp 36" cut model T1136B. Front engine riders.
12 - 12398	Deck Belt. Replaces AYP 401603. 1/2" (12.7 mm) x 95.68" (2430.5 mm). General purpose, fiberglass cord construction, Double cover, clutching.
12 - 11861	Deck Drive Belt. Replaces AYP 193214. 1/2" (12.7 mm) x 90.2" (2291.08 mm). Fits new 38" rider. General purpose, Aramid cord construction, double clutching cover.
12 - 11863	Deck Drive Belt. Replaces AYP 196103. 5/8" (15.875 mm) x 148" (3759.2 mm). Fits 54" rider. Neoprene, polyester cord, double cover.
12 - 11864	Deck Drive Belt. Replaces AYP 197242. 5/8" (15.875 mm) x 138.75" (3524.25 mm). Fits 48" rider. Polyester cord, double cover.
12 - 12423	Deck Drive Belt. Replaces AYP 402009/169178. 1/2" (12.7 mm) x 114" (2395.6 mm). Fits new 42" rear discharge. (AA x 114") General purpose, Aramid cord construction, double clutching cover.
12 - 12480	Deck Drive Belt. Replaces AYP 175436. 3/8" (9.5 mm) x 32" (812.8 mm). Fits 21" rear bagger, self propelled mower. General purpose, Aramid cord construction, double clutching cover.
12 - 12286	Deck Drive Belt. Replaces AYP 405143. 1/2" (12.7 mm) x 105-3/4" (2686.1 mm). Fits 2007 models with 46" twin blade decks. Double cover, Aramid cord construction.

O.E.M. REPLACEMENT



AYP - SEARS/ROPER/HUSKY/POULAN (Cont.)



Order No.	Description
12 - 11867	Deck to Spindle Belt. Replaces AYP 197253. 1/2" (12.7 mm) x 100.97" (2564.68 mm). Polyester cord, double cover.
12 - 10076	Primary Deck Belt. Replaces AYP 174368. 5/8" (15.88 mm) x 90" (2286 mm). Fits 48" riders. Polyester cord construction.
12 - 9368	Primary Deck Belt. Replaces AYP 139573. 1/2" (12.7 mm) x 83-1/2" (2120.9 mm) Fits 46" & 50" cut, 16, 19, 20, 22 & 24 hp engines. Deck models YGT, YPT & PP. *Aramid fiber. Black cover.
12 - 9698	Primary Drive Belt. Replaces AYP 148763. 5/8" (15.88 mm) x 85-3/8" (2168.5 mm). Tractor to mower for AYP 46" with 18 & 20 hp Kohler engines, model year '95 & '97. General purpose, polyester cord construction. Covered.
12 - 10077	Secondary Deck Belt. Replaces AYP 180808. 5/8" (15.88 mm) x 89" (2261 mm). Fits AYP & Poulan Pro units. Polyester cord construction.
12 - 10078	Ground Drive Belt. Replaces AYP 161597. 1/2" (12.7 mm) x 82-1/2" (2096 mm). *Aramid fiber. Fits 48" & 54" AYP riders & Poulan Pro units.
12 - 10008	Ground Drive Belt. Replaces AYP 156971. 1/2" (12.7 mm) x 82" (2096 mm). Fits 42" AYP riders. *Aramid fiber.
12 - 12052	Transmission Belt. Replaces AYP 199612. 1/2" (12.7 mm) x 96.7/8" (2460.6 mm). Fits AYP 48" decks. Wrapped-molded, Aramid cord construction.
12 - 6902	Transmission Belt. Replaces Sears/Roper 126907X, 125907X. 90" (2286 mm) x 1/2" (12.70 mm). 38" cut, model YT14.
12 - 8512	Transmission Belt. Replaces AYP 106412X. 1/2" (12.70 mm) width x 69" (1752.60 mm) length. Fits 11 hp 36" cut model L0815AR, front engine rider.
12 - 9764	Engine to Transmission Belt. Replaces AYP 130801. 1/2" (12.7 mm) x 95" (2413 mm). Polyester cord construction.
12 - 9336	Hydro Belt. Replaces AYP 140294. 1/2" (12.7 mm) x 82" (2082.8 mm) Fits 42" & 44" cut, 18 & 18.5 hp engines. Models WE185H42F & Y18H44D. *Aramid fiber. 2 ply white.
12 - 9337	Hydro Belt. Replaces AYP 141416. 1/2" (12.7 mm) x 83-3/4" (2127.3 mm) Fits 42" cut, 14.5 & 16hp engines. Model 9169A99. Neoprene, *Aramid fiber. Clutching cover.
12 - 9765	V Belt. Replaces AYP 132801. 1/2" (12.7 mm) x 52" (1320.8 mm). *Aramid fiber.
12 - 9769	V Belt. Replaces AYP 9180R. 1/2" (12.7 mm) x 41-1/2" (1054 mm). Polyester cord construction.
12 - 11130	Belt. Replaces AYP 180214. 1/2" (12.7 mm) x 87" (2209.8 mm). Fits 12.5 hp 38" cut. Wrapped 2ply aramid cord construction.
12 - 11129	Belt. Replaces AYP 180216. 1/2" (12.7 mm) x 83" (2108.2 mm). Fits 11 hp 36" cut. Wrapped 2ply aramid cord construction.

30

O.E.M.



AYP - SEARS/ROPER/HUSKY/POULAN (Cont.)



Order No.

Description

12 - 13251

Deck Belt. Replaces AYP 429636. 1/2" (12.7 mm) x 101.4" (2575.5 mm). Fits 2010 model 42" decks. Wrapped-molded, aramid cord construction, double cover, clutching, white.

12 - 14513

Snowthrower Belt. Replaces AYP **428454**, & Husqvarna **532428454**. 1/2" (12.7 mm) x 29.44" (747.8 mm). Fits models 1827 EXLT, 1830 EXLT Snowthrowers. Wrapped molded, Aramid cord construction, single cover.

12 - 14512

Snowthrower Belt. Replaces AYP **408019**, & Husqvarna **532408019**. 5/8" (15.8 mm) x 38.97" (989.8 mm). Fits models 1130 SBE OV, 11524E, 14527E, 145270 S Snowthrowers. Raw edge, Aramid cord construction.

12 - 14116



Snowthrower Belt. Replaces AYP **408007**, & Husqvarna **532408007**. 5/8" (15.8 mm) x 38" (965.2 mm). Fits models PP1150E27, PP208E24, PP208EPS24 Snowthrowers. Raw edge, Aramid cord construction.

12 - 14117

Snowthrower Belt. Replaces AYP **408010/183533**, & Husqvarna **532408010**. 5/8" (15.8 mm) x 37-3/4" (939.8 mm). Fits models 10527SB, 10527SBE, 10530SBE, 1130SBLS, 1130SBE, 5224STE, 924SB, 924SBE, 927SB. Snowthrowers. Raw edge, Aramid cord construction.

* Made with KEVLAR® or non-trade marked Aramid fiber.

Order No. 13 - 13622

Idler pulley replaces AYP 165626. Composite plastic Idler pulley. Belt groove 1/2".



ID 3/8"
OD 2-1/2"
Height 1"



ID 5/16"
OD 2-1/2"
Height 1/2"

Order No. 13 - 12385

Idler pulley replaces AYP 199532 & 179050. Export Only.



ID 3/8"
OD 2"
Height 3/8"

Order No. 13 - 10128

Idler pulley replaces AYP 166042. Belt idler for self-propelled walk behind mowers. Composite; glass filled nylon.



ID 3/8"
OD 3"
Height 1-1/8"

Order No. 13 - 10396

Deck Belt V-Idler pulley replaces AYP 139123. Fits AYP riding mowers.



ID 3/8"
OD 3-1/2"
Height 1-1/8"

Order No. 13 - 9849

Heavy duty Deck Belt V-Idler pulley replaces AYP 139245. Fits AYP & Husqvarna riding mowers.



ID 3/8"
OD 3-1/2"
Height 1-5/16"

Order No. 13 - 13178

Idler pulley replaces AYP 194326. Composite Plastic.



ID 3/8"
OD 3-1/2"
Height 1-1/2"

Order No. 13 - 13179

Idler pulley replaces AYP 194327. Composite Plastic.

30

O.E.M.

O.E.M. REPLACEMENT



AYP - SEARS/ROPER/HUSKY/POULAN (Cont.)



ID 3/8"
OD 3-1/2"
Height 2-1/8"

Order No. 13 - 12644
Idler pulley replaces AYP 179114.



ID 3/8"
OD 3-7/8"
Height 3/4"

Order No. 13 - 9376
Deck Idler pulley replaces AYP 131494. Fits AYP, Sears, Roper.



ID 3/8"
OD 3-7/8"
Height 1-1/4"

Order No. 13 - 11632
Idler pulley replaces AYP 173437. Fits 42" Decks from 2000-up.



ID 3/8"
OD 3-7/8"
Height 1-9/16"

Order No. 13 - 11634
Idler pulley replaces AYP 177968. Fits 48" Decks from 2001-up.



ID 3/8"
OD 4-1/4"
Height 11/16"

Order No. 13 - 12620
Idler pulley replaces AYP 146763. Fits 46" decks.



ID 3/8"
OD 4-1/4"
Height 1"

Order No. 13 - 7157
Idler pulley replaces AYP 105313X. Fits 36" and 42" decks.



ID 3/8"
OD 4-3/8"
Height 1-29/64"

Order No. 13 - 12661
Idler pulley replaces AYP 173901 & 156493. Fits 46" decks.



ID 3/8"
OD 4-1/2"
Height 1-3/16"

Order No. 13 - 11635
V-Idler pulley replaces AYP 189993. Fits 48" Decks from 2005-up.



ID 3/8"
OD 4-1/2"
Height 1-1/16"

Order No. 13 - 11633
Idler pulley replaces AYP 175820. Fits 48" Decks from 2000-up.



ID 3/8"
OD 4-5/8"
Height 7/8"

Order No. 13 - 9377
Flat Idler pulley replaces AYP 102403x. Includes high speed bearing with double seals. For heavy load applications.



ID 3/8"
OD 5"
Height 7/8"

Order No. 13 - 10414
Pump drive idler pulley replaces AYP 101344L. 5/16" offset reducer bushing.



ID 3/8"
OD 5-1/2"
Height 1-9/16"

Order No. 13 - 12061
Idler pulley replaces AYP 187284.

30

O.E.M.



AYP - SEARS/ROPER/HUSKY/POULAN (Cont.)



ID 3/8"
OD 5-3/8"
Height 1-5/8"

Order No. 13 - 13175

Idler pulley replaces AYP 196106. Painted version of AYP 197379.



ID 1/2"
OD 1-7/8"
Height 5/8"

Order No. 13 - 9846

Idler pulley replaces AYP 166043. Composite; glass filled nylon.



Splined ID 41/64"
OD 4-13/16"
Height 31/32"

Order No. 13 - 9148

Steel deck pulley replaces AYP 129206, 153532. Fits 38" cut mowers. Double Hex ID.



Splined ID 5/8"
OD 5-1/2"
Height 59/64"

Order No. 13 - 12456

Spindle pulley replaces AYP 198145. Fits Ayp, Craftsman, Dixon.



Splined ID 5/8"
OD 4-7/8"
Height 1-3/8"

Order No. 13 - 12513

Spindle pulley replaces AYP 174375. Fits 48" decks.



Splined ID 5/8"
OD 5-3/16"
Height 7/8"

Order No. 13 - 7180

Spindle pulley replaces AYP 173436, 177865, 153535, 129861. Fits 42" deck models 7147A29, 7167A29 and 7147B29.



Splined ID 5/8"
OD 4"
Height 1-1/2"

Order No. 13 - 12428

Spindle pulley replaces AYP 144197. Fits spindles on 46" decks.



ID 1" step down to 3/4"
Top OD 3-1/2"
Bottom OD 5-1/2"
Height 5-3/8"

Order No. 13 - 12271

Engine pulley replaces AYP 140186 & 532140186.



Splined ID 5/8"
OD 6-1/4"
Height 7/8"

Order No. 13 - 12378

Spindle pulley replaces AYP 195945. Fits newer 42" & 46" decks.



Splined ID 5/8"
OD 4-5/8"
Height 7/8"

Order No. 13 - 9121

Steel deck pulley replaces AYP 153531. Fits 36" & 46" cut mowers. Double Hex ID.













30
O.E.M.

O.E.M. REPLACEMENT



AYP - SEARS/ROPER/HUSKY/POULAN (Cont.)

30
O.E.M.

ORDER NO.	REPLACES O.E.M. NO.	LENGTH	CENTER HOLE DIAM.	OUTSIDE HOLE DIAM.	CENTER TO CENTER	WIDTH	STEEL THICK.	APPLICATION
 15 - 1019	25118	14-5/8" 371.5mm	5/8" 15.9mm	5/16" 7.9mm		2-1/2" 63.5mm	.150" 3.8mm	
 15 - 1020	9484H 25321	14-5/8" 371.5mm	1-1/4" 31.8mm	15/32" 11.9mm	3" 76.2mm	2-1/2" 63.5mm	.150" 3.8mm	(3) blades for 42" cut
 15 - 2162	25034 25034R	15-3/8" 390.5mm	3/8" 9.5mm			2-1/4" 57.2mm	.187" 4.8mm	(3) blades for 44" cut
 15 - 6205	130652	15-3/8" 390.5mm	5 point star			2-1/4" 57.2mm	.160" 4.1mm	(3) blades for 44" cut Hi Performance
 15 - 6263	130652	15-3/8" 390.5mm	5 point star			2-1/4" 57.2 mm	.187" 4.8 mm	(3) blades for 44" cut. (Heavy Duty) . Also fits Poulan.
 15 - 6437	163819 152443	15-1/2" 393.7mm	5 point star			2-1/4" 57.2mm	.160" 4mm	(3) blades for 46" cut. Fits AYP, Sears, Husky and Poulan.
 15 - 6495	159705 170698 176084	15-1/2" 393.7mm	5 point star			2-1/4" 57.1mm	.160" 4.8mm	High lift blade. (3) blades for 46" cut. Fits AYP, Sears, Husqvarna & Poulan.
 15 - 9170	157033	15-9/16" 395mm	5 point star			2-1/4" 57.2mm	.187" 4.8mm	(3) blades for 46" cut. Fits AYP, Sears, Husky and Poulan. (Heavy Duty)
 15 - 9970	157033	15-9/16" 395mm	5 point star			2-1/2" 63.5mm	.187" 4.8mm	Mulching Blade PATENTED
 15 - 2690	25322 9485H 25322R	16-5/8" 422.3mm	1-1/4" 31.8mm	15/32" 11.9mm	3" 76.2mm	2-1/2" 63.5mm	.187" 4.8mm	(3) blades for 48" cut
 15 - 10377	173921	16-5/8" 422.3mm	5 point star			2-1/2" 63.5mm	.204" 5.2mm	(3) blades for 48" cut. Mulching Blade
 15 - 12475	173921 173920 180054	16-5/8" 422.3mm	5 point star			2-1/2" 63.5mm	.204" 5.2mm	(3) blades for a 48" cut. Mulching Blade. PATENTED



AYP - SEARS/ROPER/HUSKY/POULAN (Cont.)

ORDER NO.	REPLACES O.E.M. NO.	LENGTH	CENTER HOLE DIAM.	OUTSIDE HOLE DIAM.	CENTER TO CENTER	WIDTH	STEEL THICK.	APPLICATION
 15 - 9907	173920 180054	16-3/4" 425.5mm	5 point star			2-1/2" 63.5mm	.204" 5.2mm	(3) blades for 48" cut. High Lift
 15 - 6196	137380	17-3/8" 441.3mm	5 point star			2-1/4" 57.2mm	.160" 4.1mm	(3) blades for 50" cut front engine lawn tractor.
 15 - 6195	121798X	17-3/8" 441.3mm	3/8" 9.5mm			2-1/4" 57.2mm	.187" 4.8mm	(3) blades for 50" cut front engine lawn tractor
 15 - 6264	137380	17-3/8" 441.3mm	5 point star			2-1/4" 57.2mm	.187" 4.8mm	(3) blades for 50" cut. (Heavy Duty) . Also fits Poulan.
 15 - 10841	140101	18-3/8" 466.7mm	5 point star			2-1/4" 57.2mm	.150" 3.8mm	(2) blades for 36" cut
 15 - 50252	165560 170037	18" 457.2mm	5 point star			2-1/4" 57.1mm	.187" 4.8mm	Fits 36" rear discharge tractor. Mulching blade. Right hand blade.
 15 - 50253	165561 170038	18" 457.2mm	6 point star			2-1/4" 57.1mm	.187" 4.8mm	Fits 36" rear discharge tractor. Mulching blade. Left hand blade.
 15 - 6123	138496 127841	18" 457.2mm	5 point star			2-1/4" 57.2mm	.150" 3.8mm	(2) blades for 36" cut
 15 - 6219	131321	18-1/8" 460.3mm	5 point star			2-1/4" 57.2mm	.187" 4.8mm	(2) blades for 36" cut also fits Husky & Poulan (Heavy Duty)
 15 - 3358	25645 98111 71285	18-3/16" 462mm	3/8" 9.5mm			2-1/2" 63.5mm	.134" 3.4mm	(2) blades for 36" cut
 15 - 6120	126338X 120262X	18-1/4" 462mm	3/8" 9.5mm			2-1/4" 57.2mm	.187" 4.8mm	(2) blades for 36" cut

30

O.E.M.

O.E.M. REPLACEMENT















AYP - SEARS/ROPER/HUSKY/POULAN (Cont.)

30
O.E.M.

ORDER NO.	REPLACES O.E.M. NO.	LENGTH	CENTER HOLE DIAM.	OUTSIDE HOLE DIAM.	CENTER TO CENTER	WIDTH	STEEL THICK.	APPLICATION
 15 - 13239	187254	18-3/8" 466.7mm	5 point star			3" 76.2mm	.187" 4.8mm	(3) blades for a 54" cut. Low lift blade.
 15 - 11180	187254	18-3/8" 466.7mm	5 point star			3" 76.2mm	.187" 4.8mm	Fits Craftsman, Husqvarna and Poulan Pro. (3) blades for 54" cut Standard Lift Blade.
 15 - 14459	187254 532-187256	18-1/2" 401.3mm	5 point star			2-1/2" 63.5mm	.204" 5.2mm	High Lift Bagging Blade (3) blades for 54" cut
 15 - 12121	187255 187256 187254	18-1/2" 469.9mm	5 point star			3" 76.2mm	.187" 4.8mm	Mulching Blade PATENTED (3) blades for a 54" cut.
 15 - 6218	131322	19" 482.6mm	5 point star			2-1/4" 57.2mm	.187" 4.8mm	(2) blades for 38" cut also fits Husky & Poulan (Heavy Duty)
 15 - 6105	121263X	19-1/4" 489mm	3/8" 9.5mm			2-1/4" 57.2mm	.187" 4.8mm	(2) blades for 38" cut
 15 - 12240	193957	19-1/4" 488.95mm	5 point star			2-1/4" 57.2mm	.150" 3.8mm	Fits Sears Craftsman rider. 3 in 1 blade. (2) blades for a 38" cut.
 15 - 6124	138497 127842	19-5/16" 490.54mm	5 point star			2-1/4" 57.2mm	.150" 3.8mm	(2) blades for 38" cut Standard Lift Blade
 15 - 3392	106634 25036 25036R	19-11/32" 491.3mm	3/8" 9.5mm			2-1/4" 57.2mm	.150" 3.8mm	(2) blades 15-3392 & (2) 15-6015 blades for 38" cut (blades cross)
 15 - 6190	134148	19-5/16" 498.5mm	5 point star			2-1/4" 57.2mm	.134" 3.4mm	(2) blades for 38" cut front engine rider Mulcher blade
 15 - 1043	56400 8020 56400R	20" 508mm	5/8" 15.9mm			2-1/2" 63.5mm	.134" 3.4mm	
 15 - 6037	850972	20" 508mm	5/8" 15.9mm	3/8" 9.5mm	1-7/8" 47.6mm	2-1/2" 63.5mm	.134" 3.4mm	For 20" walk behind



AYP - SEARS/ROPER/HUSKY/POULAN (Cont.)

ORDER NO.	REPLACES O.E.M. NO.	LENGTH	CENTER HOLE DIAM.	OUTSIDE HOLE DIAM.	CENTER TO CENTER	WIDTH	STEEL THICK.	APPLICATION
 15 - 6235	752233 145106	20" 508mm	5/8" 15.9mm	3/8" 9.5mm	1-7/8" 47.6mm	2-1/4" 57.2mm	.134" 3.4mm	Mulching Blade Fits Craftsman 20" walk behind mowers.
 15 - 6125	138971 138498 127843	21" 533.4mm	5 point star			2-1/4" 57.2mm	.150" 3.8mm	(2) blades for 42" cut
 15 - 6189	134149	21" 533.4mm	5 point star			2-1/4" 57.2mm	.134" 3.4mm	(2) blades for 42" cut front engine rider Mulcher blade
 15 - 6262	134149	21" 533.4mm	5 point star			2-1/4" 57.2mm	.187" 4.8mm	(2) blades for 42" cut (Heavy Duty) . Also fits Poulan.
 15 - 6422	134149	21" 533.4mm	5 point star			2-1/2" 63.5mm	.187" 4.8mm	Mulching Blade PATENTED
 15 - 6484	168720 175450 180583	21" 533.4mm	5 point star			5-5/8" 143mm	.150" 3.8mm	Fits 42" rear discharge. Left side blade. Right Hand rotation.
 15 - 6485	168721 175451 180584	21" 533.4mm	6 point star			5-5/8" 143mm	.150" 3.8mm	Fits 42" rear discharge. Right side blade. Left Hand rotation.
 15 - 9810	159267 532-40-67-12 406712 165833 175064 189028	21" 533.4mm	5/8" 15.8mm	3/8" 9.5mm	1-7/8" 47.6mm	2-1/4" 57.2mm	.134" 3.4mm	Blade for a 21" walkbehind mower. Mulching blade.
 15 - 12732	165833 175064 406712 189028	21" 533.4mm	5/8" 15.9mm	3/8" 9.5mm	1-7/8" 47.6mm	2-1/4" 57.2mm	.150" 3.8mm	Fits 21" Walkbehind Mower Mulching Blade. PATENTED
 15 - 12563	139775	21-1/16" 534mm	5 point star			2-1/4" 57.2mm	.150" 3.8mm	Fits Sears Craftsman rider. (2) blades for a 42" cut. 3 in 1 blade
 15 - 6038	850973	21-5/8" 549.3mm	5/8" 15.9mm	3/8" 9.5mm	1-7/8" 47.6mm	2-1/2" 63.5mm	.150" 3.8mm	For 22" walk behind
 15 - 6220	48126 88174	21-11/16" 550.9mm	1" 25.4mm	1/2" 12.7mm	3-11/16" 93.7mm	2-1/2" 63.5mm	.187" 4.8mm	22" cut for BBC models walk behind

30 O.E.M.



NOMA (AMF/Dynamark)



ID 2-1/4"
OD 4-7/16"

Order No. 05 - 7018

Driven Disc replaces Noma 53830 & 313883.



ID 17/32"
Width 1-3/8"
Height 5-3/4"

Order No. 07 - 3320

Deck Wheel. Replaces Noma-AMF/Dynamark 302611, 52204, 52584. 1-3/8" offset hub.

Order No. 07 - 8298

Deck wheel replaces Noma 39831, 52584, 302611. 1-3/8" offset hub.



ID 1/2"
Width 1-11/16"
Height 5-3/4"

Order No. 07 - 283

8" x 1.75", 1/2" C.H., 1-3/8" offset hub, lug tread. Noma 56324.



ID 3/4" (19.05 mm)
OD 1-3/8" (34.90 mm)
Height 1/2" (12.70 mm)
Flange OD 1-9/16" (39.69 mm)

Order No. 09 - 3303

Replaces AMF 54902. Flange Bearing. Graphite Impregnated.



ID 3/4" (19.05 mm)
OD 1-3/8" (34.93 mm)
Height 5/8" (15.88 mm)
Flange OD 1-1/2" (38.10 mm)

Order No. 09 - 339

Replaces AMF 39979. Also fits many Sears. Graphite Impregnated.



ID 3/4" (19.05 mm)
OD 1" (25.40 mm)
Height 3/4" (19.05 mm)
Flange OD 1-3/8" (34.93 mm)

Order No. 09 - 8306

Spindle bearing replaces AMF/Dynamark 52407. Used on 39" cut, 12 hp, front engine rider models 3912-081 & 082.



ID 3/4" (19.05 mm)
OD 1-3/8" (34.93 mm)
Height 3/4" (19.05 mm)
Flange OD 1-9/16" (39.69 mm)

Order No. 09 - 3305

Replaces AMF 40195. Spindle Bearing, Graphite Impregnated.



ID 21/32" (17 mm)
OD 1-9/16" (40 mm)
Height 15/32" (11.91 mm)

Order No. 09 - 7917

Bearing replaces Noma 49562. Fits Noma-AMF/Dynamark 32", 36" and 39" models 3210-5100, 3612-1500, 3612-1501, 3912-0500, 3912-0501. Used in 10-1172 quill assembly. Bearing No. 6203ZZ.



ID 3/4" (19.05 mm)
OD 1-1/8" (28.6 mm)
Height 3/4" (19.05 mm)

Order No. 09 - 9303

Axle bearing replaces Noma 581730. Axle bearing for Noma snowblowers.

30

O.E.M.



O.E.M. REPLACEMENT
NOMA (Cont.)

ID 43/64" (17.07 mm)
OD 1-7/8" (47.63 mm)
Length 3-3/4" (95.25 mm)



Order No. 09 - 9046

Auger bushing replaces Noma 54837. Fits Noma snow throwers.



Order No. 10 - 9143

Universal adjustable yoke ends. 3/8" - 24 female, for 3/8" pin. Replaces Noma 305530.

30

O.E.M.



Order No. 10 - 3301

Brake Spring. Replaces AMF 00782223, 35410. Coil diam. 5/8", length of coil 3", length overall 4-9/16".

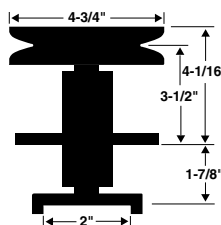

Order No. 10 - 1170

Replaces AMF/Dynamark 779057, 50334, 50335, 50630, 51438, 313907, 310240, 56283. Pulley Diameter 4-3/4", Saddle OD 2", Saddle ID 2", Clearance 1-7/8".

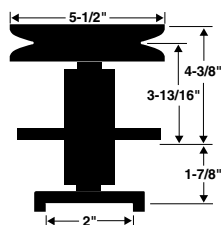

Order No. 10 - 1172

Replaces AMF327517, 50632, 56424, 307534, 39493, 51450. Pulley Dia. 5-1/2", Saddle OD 2-1/2", Saddle ID 2", Clearance 1-7/8".

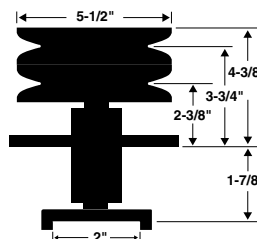

Order No. 10 - 7251

Center spindle assembly for Noma. Replaces Noma 779058, 310-675, 304076. Fits 45" cut front engine rider models 4158-00, 03, 04, 06 and 11.



NOMA (Cont.)



Order No.	Description
12 - 6871	Cutter Deck Belt. Replaces Noma 308701. 5/8" section belt (15.88 mm), 80" length (2032 mm).
12 - 6872	Cutter Deck Belt. Replaces Noma 302289. 5/8" section belt (15.88 mm), 73.75" length (1873.25 mm).
12 - 6896	Replaces Noma 54758. 1/2" section belt (12.70 mm), 82" length (2082.80 mm).
12 - 6898	Replaces Noma 303241.
12 - 6970	Replaces Noma 48044. 5/8" section belt (15.88 mm), 82" length (2082.80 mm). *Aramid fiber.
12 - 7128	Deck Drive Belt. Replaces Noma 300680. 5/8" section (15.88 mm), 77-3/4" length (1974.85 mm). Fits Noma Eagle Star.

*Made with KEVLAR® or non-trade marked Aramid fiber.

30
O.E.M.



Order No.	Description	Order No.	Description
13 - 714	Flat Idler w/Flange. Fits AMF 39498.	13 - 728	V-Belt Idler. Fits AMF 45074.
13 - 719	Flat Idler w/Flange. Fits AMF 27332.	13 - 730	V-Belt Idler. Fits AMF 45074.
13 - 721	Flat Idler w/Flange. Fits AMF 40223.	13 - 731	V-Belt Idler. Fits AMF 782964, 35374.
13 - 725	Flat Idler w/Flange.	13 - 733	V-Belt Idler. Fits AMF 27788.
13 - 726	Flat Idler w/Flange. Fits AMF 57736.	13 - 734	V-Belt Idler. Fits AMF 44280.

Note: See Section 13 for Idler measurements.

ID 3/8"
OD 4-3/4"
Height 7/8"



Order No. 13 - 7182











Idler Pulley replaces Noma 310-326. Fits 38", 39", 40", 42", 43" & 46" front engine rider models B3812-160, C3912-090, B4013-030, B4213-010, B4314-040, B4618-021. Composite: Glass Filled Nylon.

O.E.M. REPLACEMENT





NOMA (Cont.)

O.E.M. 30

ORDER NO.	REPLACES O.E.M. NO.	LENGTH	CENTER HOLE DIAM.	OUTSIDE HOLE DIAM.	CENTER TO CENTER	WIDTH	STEEL THICK.	APPLICATION
 15 - 6031	00782972 9248 300323	9-5/8" 244.5mm	3/8" 9.5mm			2" 50.8mm	.134" 3.4mm	(1) 15-6031 & (2) 15-6024 for 45" deck
 15 - 6021	00782971 8684 56820	16-1/8" 409.6mm	3/8" 9.5mm			1-15/16" 49.2mm	.134" 3.4mm	(2) blades for 32" cut rear Engine rider
 15 - 1093	00782971 42433	16-1/4" 412.8mm	3/8" 9.5mm			2" 50.8mm	.150" 3.8mm	(2) blades for 32" cut
 15 - 3447	00782965 8685 56821	18-1/8" 460.4mm	3/8" 9.5mm			2" 50.8mm	.134" 3.4mm	(2) blades for 36" cut
 15 - 6024	306931 58212	18-1/8" 460.4	3/8" 9.5mm			2-1/16" 52.4mm	.134" 3.4mm	(2) blades for 36" cut
 15 - 1085	00782965 39311	18-5/32" 461.2mm	3/8" 9.5mm			2" 50.8mm	.150" 3.8mm	(2) blades for 36" cut
 15 - 6025	30544-0637 306932 58190	19-5/8" 498.5mm	3/8" 9.5mm			2-1/8" 54mm	.134" 3.4mm	(2) blades for 39" cut Lawn Chief Tractor
 15 - 3406	031039 309069 57299	19-11/16" 500.1mm	3/8" 9.5mm			2" 50.8mm	.134" 3.4mm	(2) blades for 39" cut Lawn Chief Tractor
 15 - 3336	41198	20" 508mm	3/8" 9.5mm	5/16" 7.9mm	2-1/8" 54mm	2" 50.8mm	.150" 3.8mm	
 15 - 6099	309070 303065	20-1/4" 514.4mm	3/8" 9.5mm			2-3/4" 69.9mm	.134" 3.4mm	Fits model A4016-030 (2) blades for 40" cut
 15 - 6286	330278	21-5/8" 549.3mm	3/8" 9.5mm			2" 50.8mm	.187" 4.8mm	(2) blades for 43" cut. Mulching blade



NOMA (Cont.)

ORDER NO.	REPLACES O.E.M. NO.	LENGTH	CENTER HOLE DIAM.	OUTSIDE HOLE DIAM.	CENTER TO CENTER	WIDTH	STEEL THICK.	APPLICATION
 15 - 6138	316608 313954	21-3/4" 552.5mm	13/32" 10.3mm			3-15/16" 100mm	.134" 3.4mm	(2) blades for 42" & 43" cut
 15 - 6468	325751	29-7/8" 758.8mm	1/2" 12.7mm	.390x.940"	2.708" 68.3mm	2-3/4" .69.9mm	.187" 4.8mm	



Order No. 18 - 6510

Muffler for 11 & 12 hp. B&S equipped front engine rider Dynamark model 3912.



Order No. 20 - 7730

Fuel tank bushing replaces Noma 42690.

MIN010



Order No. 20 - 8675

Fuel line shut-off valve 1/4" nipple. Replaces Noma 42879. Used with our 20-7730 fuel tank bushing.

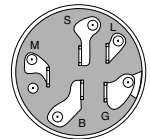

Order No. 31 - 2922

Ignition Switch. Replaces AMF 44745. 5 Terminals.



Order No. 31 - 2932

Ignition Key. Fits AMF 44745 switch.

MIN010



Order No. 31 - 9622

Multi-application ignition start switch only fits single stage Noma. Includes key, lockwasher nut. 2 terminals/ 2 positions.

30

O.E.M.

O.E.M. REPLACEMENT
NOMA (Cont.)



Order No. 31 - 3319

Solenoid. Replaces AMF/ Dynamark 53716.



Order No. 31 - 10771

Universal starter solenoid 3 pole, 12 volt. Terminal post will accommodate both 5/16" & 1/4" terminal connectors, Mounting bracket will accommodate both chassis and wall mount configurations. Replaces Noma 52323, AMF 53716.



Order No. 41 - 8635

Universal snowblower shoe fits Noma.



Order No. 41 - 5585

Universal snowblower skid shoes set. Fits most Noma. 2 stage snowthrowers. Eccentric washers allow mounting to a variety of mounting dimensions. Mounting width (min 2", max 3", 5/16" bolt holes. Similar to our 41-8635.



Order No. 41 - 13169

Snowblower paddle set for Sears/Noma. Fits Craftsman and all Sears 22" model numbers: 536.88150, 538.885210 that do not have replacement paddles.



Order No. 41 - 5531

Scrapers Bar replaces Noma 302418. Fits Noma 5 hp models. 20-7/8" length x 1-5/8" width x 1/4" mounting holes.



Order No. 41 - 9564

Shear pin & nut replaces Noma 301171. Fits Noma, John Deere, Sears, Eagle, AYP and Husky Snowblowers.

MIN005



Order No. 41 - 8938

Shear pin with spacer & nut replaces Noma 301172. Fits Noma, John Deere, Sears, Eagle, AYP & Husky snowblowers.

MIN005



Order No. 41 - 5543

Impeller shaft kit replaces Murray/Noma 50660 & MJ577412.



Order No. 41 - 5544

Gearbox input shaft replaces Murray/Noma MJ1401 & 1401.

30

O.E.M.



PARTNER



Top ID 7/8" (22.21 mm)
 Bottom ID 13/32" (10.30 mm)
 Top OD 1-1/4" (31.45 mm)
 Bottom OD 2-29/32" (73.82 mm)
 Height 1-5/16" (33.25 mm)

Order No. 17 - 50223

Blade adaptor replaces Partner E 515-13-10-64. Fits HVA and Partner with 7/8" (22.23 mm) shaft. (Export Only)



Top ID 63/64" (25 mm)
 Bottom ID 13/32" (10.12 mm)
 Top OD 1-23/64" (34.43 mm)
 Bottom OD 2-29/32" (73.90 mm)
 Height 1-25/64" (35.12 mm)

Order No. 17 - 50224

Blade adaptor only replaces Partner E-516-84-20-00. (Export Only)



Top ID 7/8" (21.80 mm)
 Top OD 1-17/32" (38.82 mm)
 Bottom OD 2-37/64" (65.50 mm)
 Height 2-11/32" (59.24 mm)

Order No. 17 - 50225

Blade adaptor only replaces Partner E-506-53-41-01. Fits HVA Rider Models #850-970. Has 1/4" (6.10 mm) keyway. Width 1-51/64" (45.55 mm). (Export Only)



Order No. 17 - 50226

Adaptor key replaces Partner E-506-53-35-01. Fits HVA Rider Models #850-970. Fits our 17-50225. (Export Only)



Top OD 55/64" (21.62 mm)
 Length 1-11/32" (33.94 mm)

Order No. 17 - 50227

Blade bolt with locking replaces Partner E-506-67-54-01. Fits HVA 850 Rider. (Export Only)



Order No. 39 - 9790

Air filter replaces Partner 5062242-01. Fits models K650 & K1200 ACTIVE cut-off saws.

Order No. 39 - 12497

Air filter replaces Partner 506-23-18-02. Fits models K950 and 1250 active Cut-off saws. Also fit Husqvarna.



Length 6"
 Width 4-1/4"
 Height 2-5/8"



Order No. 39 - 13136

Pre-filter replaces Partner 506226301. Fits K650, 700. Pre-oiled.



Order No. 39 - 13138

Pre-filter replaces Partner 506268701. Fits K1250. Pre-oiled.



Order No. 39 - 12628

Piston & Cylinder kit replaces Partner 506-29-42-71. Fits models K1250 cut off saws. (60mm)



Order No. 39 - 12885

Cylinder & Piston Assembly replaces Partner 520-75-73-02 & 506-38-61-71. Fits K750.

30

O.E.M.

**O.E.M. REPLACEMENT
POWER TRIM**



Order No. 06 - 2997

7" x 1.50" Edger Wheel, 1-3/4" centered hub, 1/2" ball bearing. Replaces Power Trim 332. (painted orange)



Order No. 12 - 4999

Replaces Power Trim 339. 27-1/2" length (698.50 mm).



Order No. 13 - 3316

Replaces Power Trim 307. 5/8" ID, 2" OD, 1" Width, 3/16" Keyway. Has keyway with 2 set screws.



Order No. 13 - 1262

Replaces Power Trim 334. 5/8" ID, 2-1/2" OD, 5/8" width. Has keyway and set screw.





Order No. 13 - 1263

Replaces Power Trim 334-1. 3/4" ID, 2-1/2" OD, 5/8" width. Has keyway and set screw.

30



O.E.M.

PILOTE

ORDER NO.	REPLACES O.E.M. NO.	LENGTH	CENTER HOLE DIAM.	OUTSIDE HOLE DIAM.	CENTER TO CENTER	WIDTH	STEEL THICK.	APPLICATION
 15 - 10199	43160	16-17/64" 413.1mm	13/32" 10.3mm	5/16" 7.9mm	2-9/16"2-13/64"	56mm	.160" 4.1mm	
 15 - 10203	72972	17-53/64" 452.8mm	25/64" 9.9mm	17/64" 6.7mm	2-23/64"2-23/64"	59.9mm	.204" 5.2mm	
 15 - 10198	43484	18-3/32" 459.6mm	45/64" 17.9mm	5/16" 7.9mm	1-49/64"2-13/64"	56mm	.160" 4.1mm	
 15 - 10201	72231	18-49/64" 476.6mm	5/8" 15.9mm	5/16" 7.9mm	2-9/16"2-13/64"	56mm	.160" 4.1mm	



PILOTE (Cont.)

ORDER NO.	REPLACES O.E.M. NO.	LENGTH	CENTER HOLE DIAM.	OUTSIDE HOLE DIAM.	CENTER TO CENTER	WIDTH	STEEL THICK.	APPLICATION
 15 - 10202	72258	20-11/16" 525.5mm	5/8" 15.9mm	5/16" 7.9mm	2-9/16" 65.1mm	2-13/64" 56mm	.160" 4.1mm	
 15 - 10204	72292	21-23/32" 551.7mm	25/64" 9.9mm	17/64" 6.7mm	2-23/64" 59.9mm	2-13/64" 56mm	.160" 4.1mm	
 15 - 10195	34161	20-13/64" 513.2mm	25/64" 9.9mm	17/64" 6.7mm	2-23/64" 59.9mm	2-23/64" 59.9mm	.204" 5.2mm	





30

ROBERINE

 15 - 50140	59006601	24-1/2" 622.3mm	1-9/32" 32.5mm	.414" 10.5mm	3.154" 80.1mm	2.953" 75mm	.240" 6.1mm	Fits Park Models 100M, 102M & Villa.
--	----------	---------------------------	--------------------------	------------------------	-------------------------	-----------------------	-----------------------	--------------------------------------

O.E.M.

SARLO

ORDER NO.	REPLACES O.E.M. NO.	LENGTH	CENTER HOLE DIAM.	OUTSIDE HOLE DIAM.	CENTER TO CENTER	WIDTH	STEEL THICK.	APPLICATION
 15 - 6230	1511	20-5/8" 523.9mm	5/8" 15.9mm			2-1/4" 57.2mm	.182" 4.6mm	
 15 - 6228	1512	22" 558.8mm	5/8" 15.9mm			2-1/4" 57.2mm	.204" 5.2mm	
 15 - 6229	1517	22" 558.8mm	3/8" 9.5mm			2-1/2" 63.5mm	.187" 4.8mm	
 15 - 6231	1513	23-1/2" 569.9mm	5/8" 15.9mm			2-1/2" 63.5mm	.187" 4.8mm	
 15 - 6232	1516	25-11/16" 652.5mm	3/4" 19.1mm			2-3/4" 69.9mm	.187" 4.8mm	

O.E.M. REPLACEMENT



COMMERCIAL REPLACEMENT PARTS BREAK-DOWN FOR SCAG
REPLACEMENT PARTS FOR 36", 48", 52", 61" SCAG WALK BEHIND MOWERS

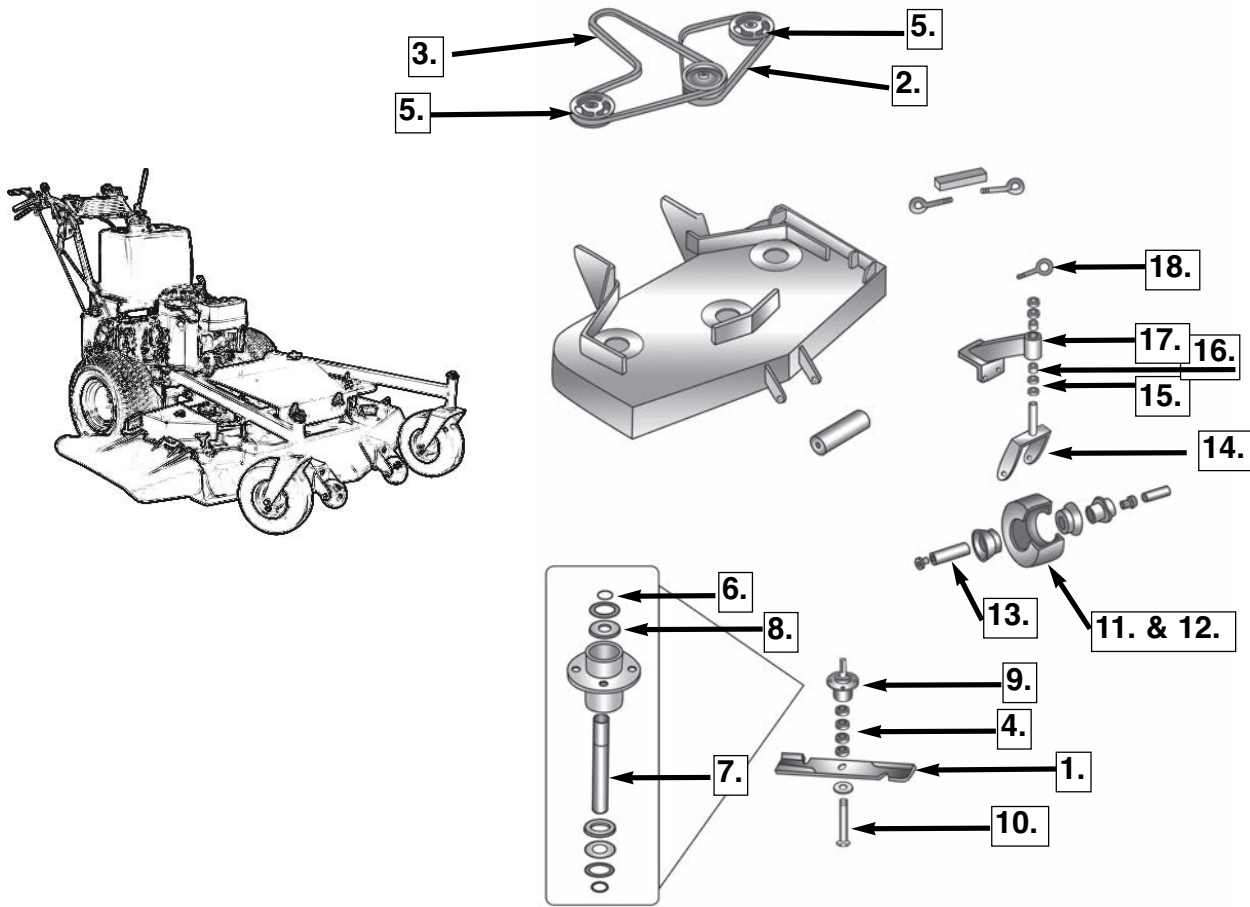

30

O.E.M.

Ref. No.	Order No.	Deck Size	Description/Replaces	Ref. No.	Order No.	Deck Size	Description/Replaces	
1.	15-3403	32",48"	Blade/Scag 48110	4.	10-8372		Spacer/Scag 43038	
	15-6300	32",48"	Commercial Mulcher Blade		5.	13-5988		Deck Pulley/Scag 48127-01
	15-6009	32",48"	Blade/Scag A48184		6.	10-5706		Snap Ring/Scag
	15-3404	36",52"	Blade/Scag 482462		7.	10-5999		Spindle Shaft/Scag 41001-02
	15-3442	36",52"	Blade/Scag 481711		8.	09-3217		Bearing/Scag 48101-01
	15-10173	36",52"	Flat Lift Blade		9.	10-5722		Spindle Assembly/Scag 46020
	15-9229	36",52"	Commercial Mulcher Blade		10.	10-8343		Blade Bolt/Scag 04001-41
	15-6294	36",52"	Commercial Mulcher Blade		11.	08-3276		Tire Assembly /Scag 48006-01
	15-9968	36",52"	Low Lift Blade		12.	08-3268		Tube/Scag 48006-03
2.	12-7598	48"	Blade Belt/Scag 48087	13.	09-7262		Bushing/Scag 43022	
	12-7601	52"	Blade Belt/Scag 48285	14.	10-7125		Yoke/Scag 45006	
	12-7608	61"	Blade Belt/Scag 48265	15.	10-8190		Yoke Spacer /Scag 43037-01	
3.	12-5236	36"	Deck Belt/Scag 48204	16.	10-5713		Bearing /Scag 48100-01	
	12-7790	48"	Deck Belt/Scag 48089	17.	10-8189		Support Arm /Scag 46082	
	12-7638	52"	Deck Belt/Scag 48286	18.	10-7181		Lynch Pin/Scag 04066-01	
	12-10318	61"	Deck Belt/Scag 48264					



**COMMERCIAL REPLACEMENT PARTS BREAK-DOWN FOR SCAG
REPLACEMENT PARTS FOR 61", 72" SCAG**

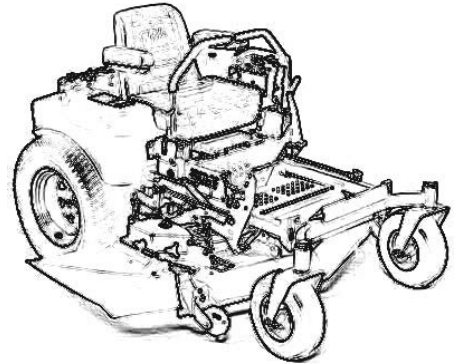
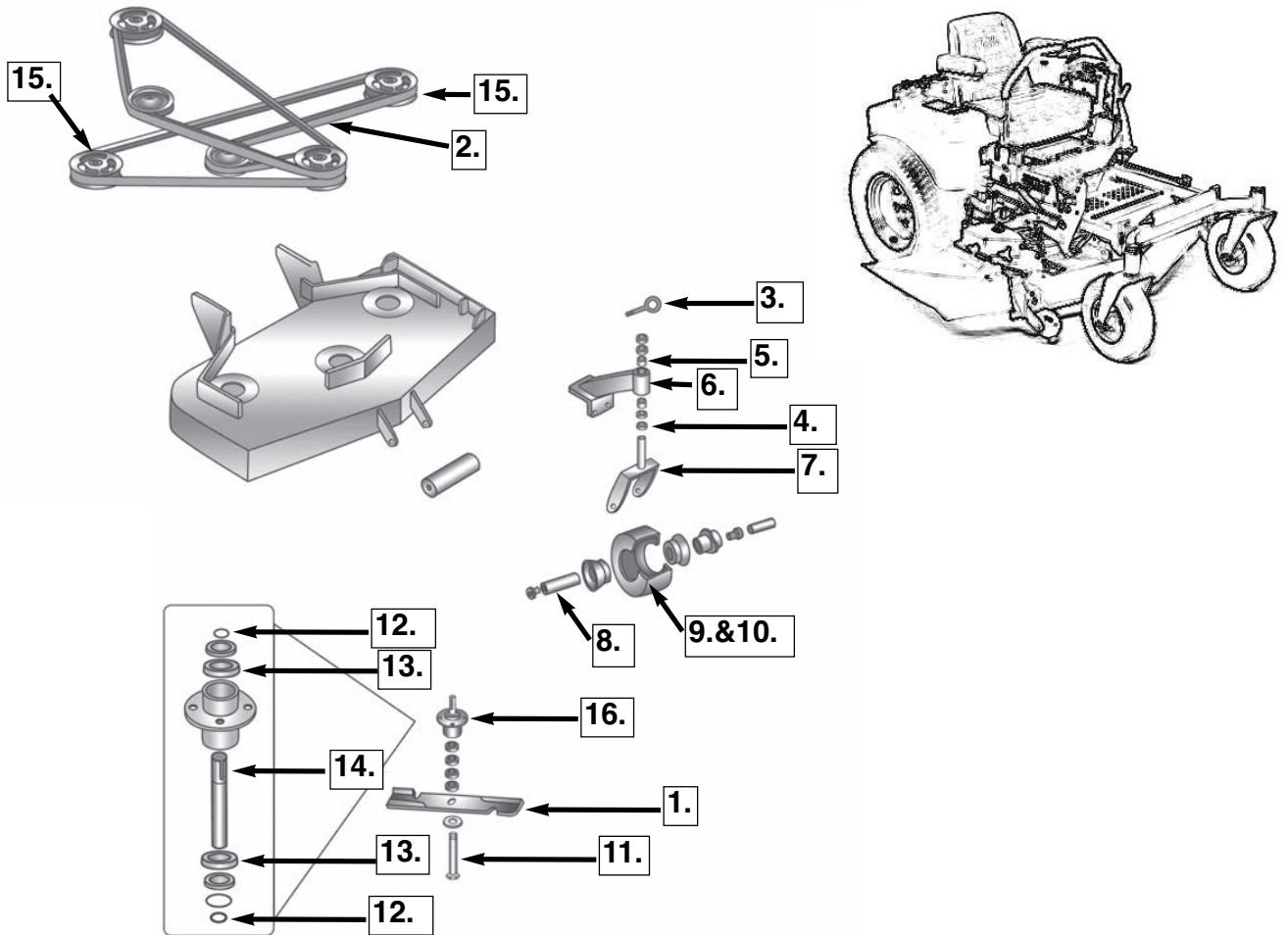

30
O.E.M.

Ref. No.	Order No.	Deck Size	Description/Replaces	Ref. No.	Order No.	Deck Size	Description/Replaces
1.	15-3434	61"	Blade/Scag 48111	6.	10-8189		Support Arm /Scag 46082
	15-6299	61"	Commercial Mulcher Blade	7.	10-7125		Yoke/Scag 45006
	15-10174	61"	Flat Lift Blade	8.	09-7262		Bushing/Scag 43022
	15-9969	61"	Low Lift Blade	9.	08-3276		Tire Assembly /Scag 48006-01
	15-6026	72"	Blade/Scag 48112	10.	08-3268		Tube/Scag 48006-03
	15-9883	72"	Commercial Mulcher Blade	11.	10-8343		Blade Bolt/Scag 04001-41
2.	12-7633	61"	Engine To Deck Belt/Scag 48083	12.	10-5706		Snap Ring
	12-5221	72"	Engine To Deck Belt/Scag 48359	13.	09-7178		Bearing/Scag 48101-02
3.	10-7181		Lynch Pin/Scag 04066-01	14.	10-5999		Spindle Shaft/Scag 43001-02
4.	10-8190		Yoke Spacer /Scag 43037-01	15.	13-5989		Spindle Pulley /Scag 48127
5.	10-5713		Bearing /Scag 48100-01	16.	10-5722		Spindle Assembly /Scag 46020

O.E.M. REPLACEMENT



COMMERCIAL REPLACEMENT PARTS BREAK-DOWN FOR SCAG
REPLACEMENT PARTS FOR SM 52" SCAG

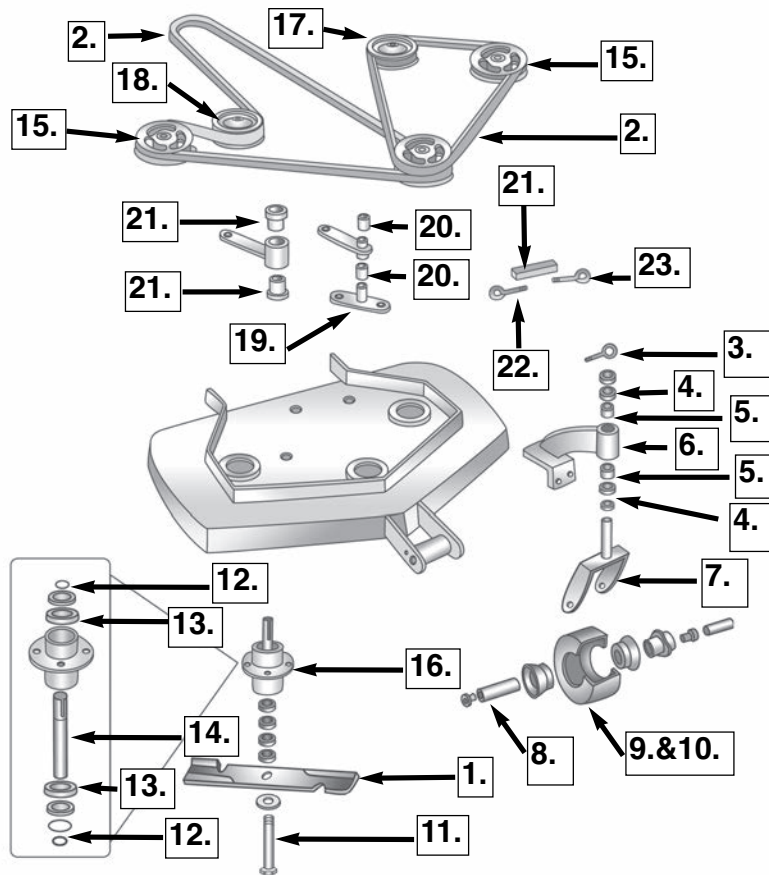
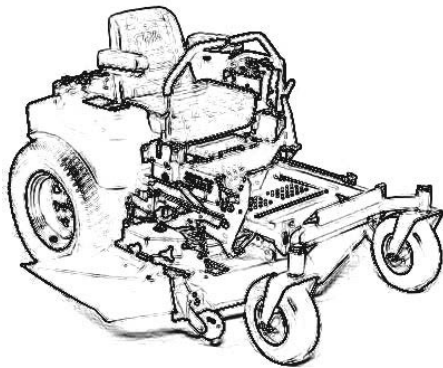

30

O.E.M.

Ref. No.	Order No.	Deck Size	Description/Replaces
1.	15-3404 15-6294 15-10173 15-3442		Blade/Scag 48108 Commercial Mulcher Blade Flat Lift Blade High Lift Blade
2.	12-6645 12-7601		Drive Belt/Scag 48530 Blade Belt/Scag 48285
3.	10-7181		Lynch Pin/Scag 04066-01
4.	10-8190		Yoke Spacer /Scag 43037-01
5.	10-5713		Bearing /Scag 48100-01
6.	10-8189		Support Arm /Scag 46082
7.	10-7125		Yoke/Scag 45006
8.	09-7262		Bushing/Scag 43022
9.	08-3276		Tire Assembly /Scag 48006-01
10.	08-3268		Tube/Scag 48006-03

Ref. No.	Order No.	Deck Size	Description/Replaces
11.	10-8343		Blade Bolt/Scag 0402-09
12.	10-5706		Snap Ring
13.	09-7178		Bearing/Scag 48101-02
14.	10-5999		Spindle Shaft/Scag 43001-02
15.	13-5988		Deck Pulley /Scag 48127-01
16.	10-5722		Spindle Assembly /Scag 46020
17.	13-7918		Idler Pulley /Scag 48181
18.	13-6572		Idler Pulley /Scag 48269
19.	10-8356		Idler Arm /Scag 45037
20.	10-8304		Idler Arm Spacer /Scag 48100-5
21.	10-8985		Turnbuckle /Scag 43025
22.	10-8689		Eyebolt RH /Scag 04070-01
23.	10-8690		Eyebolt LH /Scag 04070-02



**COMMERCIAL REPLACEMENT PARTS BREAK-DOWN FOR SCAG
REPLACEMENT PARTS FOR 52", 61" SCAG TIGER**

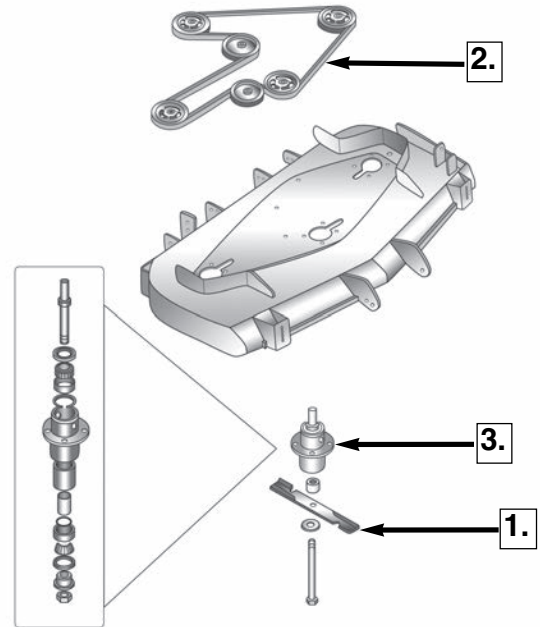
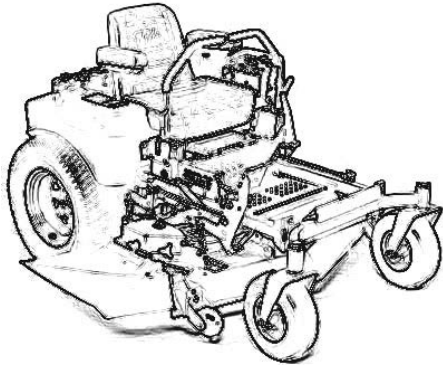

30
O.E.M.

Ref. No.	Order No.	Deck Size	Description/Replaces
1.	15-3404	52"	Blade/Scag 48108
	15-3442	52"	Blade/48185
	15-10173	52"	Flat Lift Blade
	15-9968	52"	Low Lift Blade
	15-6294	52"	Commercial Mulcher Blade
	15-3434	61"	Blade/Scag 48111
	15-6299	61"	Commercial Mulcher Blade
	15-9230	61"	Mulching Blade
	15-10174	61"	Flat Blade
	15-9969	61"	Low Lift Blade

Ref. No.	Order No.	Deck Size	Description/Replaces
2.	12-10411	52"	Drive Belt/Scag 481557
	12-10044	61"	Drive Belt/Scag 481558
3.	10-9153		Spindle/Scag 46631

COMMERCIAL REPLACEMENT PARTS BREAK-DOWN FOR SCAG
REPLACEMENT PARTS FOR 2005 - 2013 SCAG

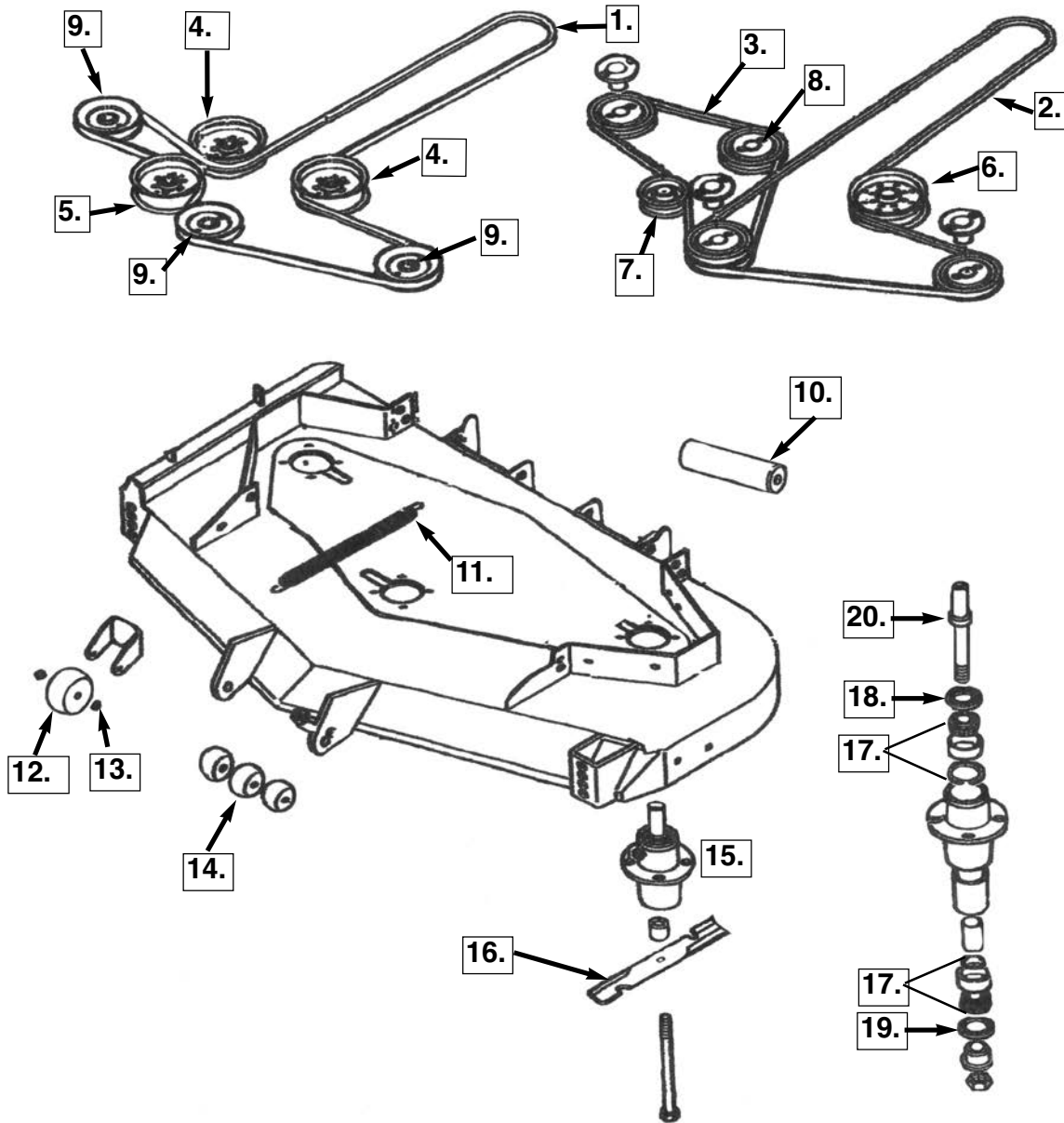

30

O.E.M.



COMMERCIAL REPLACEMENT PARTS BREAK-DOWN FOR SCAG

Ref. No.	Order No.	Deck Size	Model Years	Description/Replaces
1.	12-12718	48"	08-12	Blade Belt /483325
	12-10365	48"	05-08	Blade Belt /482529
	12-12719	52"	08-12	Blade Belt /483326
	12-10048	52"	07-12	Blade Belt /482281
	12-12233	72"	07-12	Blade Belt /481980
	12-12371	52"	05-10	Blade Belt /482530
2.	12-12071	48"	05-12	Primary Belt /483241
	12-12072	52"	05-12	Primary Belt /483242
	12-12073	61"	05-12	Primary Belt /483243
3.	12-12069	48"	05-12	Secondary Belt /483239
	12-12070	52"	05-12	Secondary Belt /483240
	12-12067	61"	05-12	Secondary Belt /483157
4. & 5.	13-11657	52"	07-12	Idler Pulley /483215
	13-11657	61"	07-12	Idler Pulley /483215
	13-11657	72"	07-12	Idler Pulley /483215
	13-11464	36",42"	05-10	Idler Pulley /483210
	13-11464	52",61"	05-10	Idler Pulley /483210
	13-11657	36",42"	05-08	Idler Pulley /483215
6.	13-11464	48",52"	05-12	Primary Idler /483210
	13-11464	61",72"	05-12	Primary Idler /483210
7. & 8.	13-10414	48"-72"	05-12	Secondary Idler /48181
	13-12712	61"-72"	10-12	Secondary Idler /483415
9.	13-11228	52"	07-12	Spindle Pulley /482744
	13-11209	61"	07-12	Spindle Pulley /482745
	13-11211	72"	07-12	Spindle Pulley /482747
10.		All	All	Rear Roller /48038
11.		48",52"	05-12	Secondary Spring/483247
		61",72"	05-12	Secondary Spring/483703
12.	07-10225	All	All	Anti-Scalp Wheel/481632
13.				Bushing/48100-15
14.	07-12245	All	All	Anti-Scalp Wheel/482295
15.	10-9153	42"-72"	05-12	Spindle Assembly/461663
16.	15-3404	36"&52"	05-12	Blade/482878
	15-3403	48"	05-12	Blade/482877
	15-3434	61"	05-12	Blade/482881
	15-6026	72"	05-12	Blade/482882
17.	10-3217	All	08-12	Spindle Bearing/483303
	10-13092	All	05-12	Spindle Bearing/481022
18.	10-13524	All	05-12	Grease Seal/481024
19.				Grease Seal/481025
20.				Spindle Shaft/43695

O.E.M. REPLACEMENT



COMMERCIAL REPLACEMENT PARTS BREAK-DOWN FOR SCAG
REPLACEMENT PARTS FOR 2005 - 2013 SCAG

O.E.M. 30

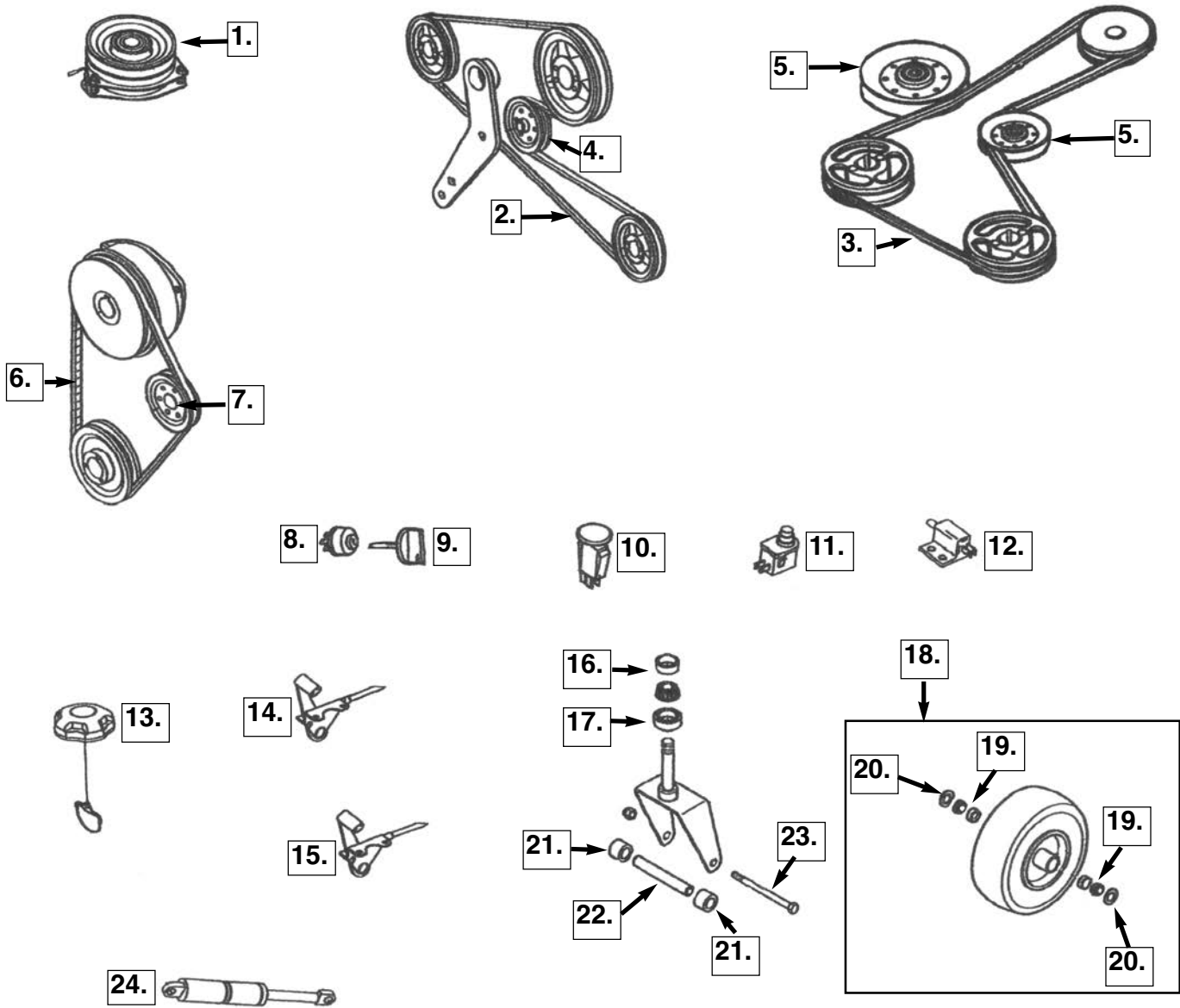



Ref. No.	Order No.	Year Model	Description/Replaces
1.			PTO Clutch/Scag 462012
2.	12-12085	06-12	Trans Pump Belt/Scag 483314
3.	12-13257	07-12	Trans Pump Belt/Scag 483165
	12-12067	05	Trans Pump Belt / Scag 483084
	12-12068	06-13	Trans Pump Belt / 483172
4.	13-13615	06-12	Trans Idler / Scag 483214
5.	13-11464	05-13	Trans Idler / Scag 483215
	13-13614	05	Trans Idler / Scag 481048
	13-12930	06-07	Trans Idler / Scag 483173
	13-12712	08-13	Trans Idler / Scag 483415
6.	12-12249	05-12	Deck Drive Belt /Scag 482876
7.	13-10414	05-12	Deck Drive Idler/Scag 48181
8.	31-7804	05-13	Ignition Switch/Scag 48798
9.	31-2932	05-13	Ignition Key /Scag 48017-02
	31-10794	07-13	Ignition Key/Scag 483366
10.	31-13248	05-13	PTO Switch/Scag 483957
11.	31-9663	05-13	Seat Switch/Scag 481638
12.	31-14247	07-12	Safety Switch/Scag 483473
	31-9660	05-13	Safety Switch /Scag 481637
13.	20-9650	05-13	Fuel Cap /Scag 483792

Ref. No.	Order No.	Year Model	Description/Replaces
14.	03-11521	05-13	Choke Cable /Scag 481544
15.	03-11521	05-13	Throttle Cable /Scag 481544
	03-11640	05-13	Throttle Cable /Scag 481662
16.	09-814	05-13	Caster Bearing /Scag 48668
	09-7162	07-13	Caster Bearing /Scag 483466
18.	08-10288	05-13	Wheel Asm. /Scag 482503
	08-10286	05-13	Wheel Asm. /Scag 482504
	08-10288	05-13	Wheel Asm. /Scag 9277
	08-10286	05-13	Wheel Asm. /Scag 9278
19.	09-813	05-13	Wheel Bearing / Scag 482621
20.	10-10013	05-13	Wheel Seal / Scag 482622
21.	09-10064	05-13	Wheel Spacer / Scag 43584
22.	09-9992	05-13	Wheel Spanner / Scag 43583
	09-10017	05-13	Wheel Spanner / Scag 43581
23.	10-11040	05-13	Wheel Bolt / Scag 04001-134
23.	10-11041	05-13	Wheel Bolt / Scag 04001-167
24.	10-11954	05-13	Gas Dampener / Scag 482794



O.E.M. REPLACEMENT

SCAG (Cont.)



Conduit 38-1/4"
Inner Wire 40"
Wire Travel 1-9/32"

Order No. 03 - 6992

Throttle control replaces Scag 48206. Fits models SW32-12B, SW36-8J, SW36-12B, SW36-13K, SW48-12B, SW48-13K, SW-13K, SW-18KH.



Conduit 41"
Inner Wire 43-1/2"
Wire Travel 1-1/4"

Order No. 03 - 9169

Throttle control replaces Scag 48394. Fits Scag model SW248 walk behind. Negative action control Z bend.



Conduit 33-1/8"
Inner Wire 35"
Wire Travel 1-1/2"

Order No. 03 - 10748

Choke control cable replaces Scag 482314. Fits 48" & 52" SW & SWZ walkbehind units.



Conduit 51"
Inner Wire 57"
Wire Travel 2"

Order No. 03 - 9693

Choke control replaces Scag 48780. Fits Scag push-pull design.

Order No. 03 - 9695
Winch cable replaces Scag 48045. Fits 61" & 72" riders, with front deck lift. Models STHM.



Length 52"

Order No. 03 - 11521
Throttle & Choke control replaces Scag 481544.

Conduit 37"
Inner Wire 40-1/2"
Wire Travel 1-5/8"

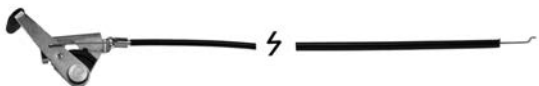

Order No. 03 - 11521

Throttle & Choke control replaces Scag 481544.

Order No. 03 - 11640
Throttle & Choke control replaces Scag 481662.

Conduit 66 -1/4"
Inner Wire 70"
Wire Travel 1-5/8"

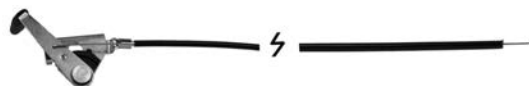

Order No. 03 - 11640

Throttle & Choke control replaces Scag 481662.

Order No. 05 - 9694
Steering cable replaces Scag 48828. Fits 61" & 72" cut riders, models ST17KA & 19KH.

Length 67-1/2"



Order No. 05 - 9694

Steering cable replaces Scag 48828. Fits 61" & 72" cut riders, models ST17KA & 19KH.

Order No. 05 - 7787
Brake band replaces Scag 48210. For 36", 40", 48", 52", 61" mid size mowers.

Diameter 7"
Width 3/4"



Order No. 05 - 7787

Brake band replaces Scag 48210. For 36", 40", 48", 52", 61" mid size mowers.

Order No. 05 - 9757
Brake drum replaces Scag 48209. Included in our 13-9758 assembly.

ID 2-1/4"
OD 6"
Width 1-1/2"



Order No. 05 - 9757

Brake drum replaces Scag 48209. Included in our 13-9758 assembly.

Order No. 05 - 8970
Adjusting nut replaces Murray 21920. Fits bolt size 3/8" - 16. Also fits Scag 43032.

Length 1-5/16"



Order No. 05 - 8970

Adjusting nut replaces Murray 21920. Fits bolt size 3/8" - 16. Also fits Scag 43032.

30

O.E.M.



SCAG (Cont.)



Order No. 42 - 9579

Coupler with cover replaces Scag 481581. Fits 5 speed mowers. Comes with grease fitting & cover. 9-spline center. Used with our 05-9580 drive shaft.



Order No. 42 - 8250

Jackshaft coupler with safety cover replaces Scag 46513 and 48226. For 36", 48", 52" and 61" walk behind mowers. Comes with grease fitting and safety sleeve.



Order No. 42 - 14176

Pro-Gear T7510 transmission replaces Peerless 700-070A, Scag 481580.



Order No. 42 - 14179

Pro-Gear 30-1017 Drive Shaft. Replaces Peerless 771842 & Scag 481582. 6-1/4" Long, 9-Spline



ID 3/8"
Width 3"
Height 4-1/2"

Order No. 07 - 10225

Anti-Scalp wheel replaces Scag 481632. Fits most Scag units including Turf Tiger. Includes bushings.

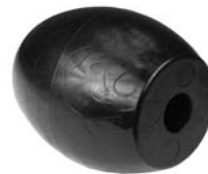

ID 11/16"
Width 3-5/16"
Height 3"

Order No. 07 - 12245

Anti scalp deck wheel replaces Scag 482295. Fits Turf Tiger.



Order No. 08 - 8098

9 x 350 x 4 smooth tread 4 ply tubeless tire, 3 piece rim, 4" centered hub with 5/8" open cage roller bearing and zerk fitting. Replaces Scag 48307, 48006-1. Uses our 09-5812 bearing kit. (painted red)



Order No. 08 - 3276

9 x 350 x 4 Caster Wheel Assembly for Scag. Smooth tread 4-ply tubeless tire. 4" centered 3-piece rim, zerk fitting with 5/8" open cage roller bearing. Replaces Scag 48307, 48006-01. Uses our 09-5812 & 09-7780 bearing kit. (painted orange)



Order No. 08 - 9605

Caster wheel replaces Scag 481551. 13 x 500 x 6, 4 ply smooth tread tubeless tire, 1 piece rim, 5/8" open cage roller bearing and zerk fitting. Uses our 08-8949 tire. Uses our 09-11720 bearing & our 09-9613 spanner bushing. (painted gold)



Order No. 08 - 10711

13 x 650 x 6, 4 ply smooth tread, tubeless tire, 1piece rim, Caster wheel assembly replaces Scag 482504. 5-5/8" centered hub with 3/4" cups pressed in for tapered roller bearings and zerk fittings. Uses our 09-813 bearing or our 09-9944 bearing kit. Fits Turf Tiger units. With Bearings (Gold)

30

O.E.M.



O.E.M. REPLACEMENT
SCAG (Cont.)



Solid Foam Tire
Flat Free

Order No. 08 - 8580

Caster Wheel Assembly for Scag, 9 x 350 x 4 Smooth Tread Solid foam tire with 3 piece rim. 4" centered hub with 5/8" open cage roller bearing and zerk fitting. Fits 32", 36", 48", 52", 61" & 72" cut mid size walk behind mowers. Assembly used on our 08-8264 Solid foam tire. (painted orange)



- 1 Piece Rim
- Flat Proof
- Semi Pneumatic

Order No. 08 - 10286

13 x 650-6 Reliance tire mounted on a 6 x 4.50" steel wheel. 7.25" centered hub with 3/4" cups pressed in for tapered roller bearings. Replaces Scag 482504. (Painted White) Uses our 09-813 bearing or our 09-9944 bearing kit.

Order No. 08 - 10288

13 x 500-6 Reliance tire mounted on a 6 x 3.25" steel wheel. 5.625" centered hub with 3/4" cups pressed in for tapered roller bearings. Replaces Scag 482503. (Painted White) Uses our 09-813 bearing or our 09-9944 bearing kit.



- 1 Piece Rim
- Flat Proof
- Semi Pneumatic

Order No. 08 - 11522

9 x 350-4 Reliance tire mounted on 4 x 2.25" steel wheel painted white. 3.25" centered hub and 5/8" roller bearings. Smooth tread tire. Replaces Scag 48006-1.



Order No. 08 - 8573

Caster wheel assembly replaces Scag 48192. 13 x 650 x 6, 2 ply traction tread tubeless tire, 1 piece rim, 8-1/2" off set hub, 1" bearing. Includes 8" pulleys & 6" brake drum. Fits 36", 48", 52", 61" & 72" cut mid size mowers with double belt drive. (painted gold)



Order No. 08 - 908

9 x 350 x 4 smooth tread 4-ply tubeless tire. Replaces Scag 481774, 48307-02.



Order No. 08 - 14556

23 x 9.50 - 12, 4-ply tubeless, K500 Super Turf tire. Replaces Scag 484466. Fits Cub, Cheetah & Freedom Z.



Order No. 08 - 10016

Wheel assembly replaces Scag 48537. 410 x 350 x 5, saw-tooth tread 4-ply tubeless tire. 4" centered, 1- piece rim, zerk fitting and a 5/8" open cage roller bearing. (painted orange)



Order No. 08 - 12879

18.00 X 7.00 - 8, 4-ply tubeless, Multi-Trac tread tire from Carlisle. Replaces Scag 483659 fits Freedom Z.



ID 5/8" (15.88 mm)
OD 1-9/16" (39.69 mm)
Height 15/32" (11.91 mm)

Order No. 09 - 8861

Spindle bearing for Scag 48102. Lower bearing.



ID 5/8" (15.88 mm)
OD 1-3/8" (34.93 mm)
Height 7/16" (11.11 mm)

Order No. 09 - 8198

Reduction gear bearing. Replaces Scag 48224. Bearing No. 99502H-2RS

30

O.E.M.



SCAG (Cont.)



ID 63/64" (25.00 mm)
OD 2-7/16" (61.91 mm)
Height 21/32" (16.67 mm)

Order No. 09 - 7178

Spindle Bearing replaces Scag 48101. Used on our spindle 10-5722. Bearing 6305-Z, sealed one side.



ID 1" (25.40 mm)
OD 2" (50.80 mm)
Height 9/16" (14.29 mm)

Order No. 09 - 6534

Wheel Bearing. Replaces Scag 481858, 48193-01. Used on Scag Mid Size Walk mowers.



ID 1" (25.40 mm)
OD 1-31/32" (50.01 mm)
Height 19/32" (15.08 mm)

Order No. 09 - 814

Replaces Scag 48668. Bearing No. L44610, L44643.



ID 5/8" (15.88 mm)
OD 1-3/8" (34.93 mm)
Height 7/16" (11.11 mm)

Order No. 09 - 8199

High speed bearing, double sealed replaces Scag 48224. May be used with or without retaining clip. Bearing No. 99502H-2RSNR.



ID 3/4" (19.05mm)
OD 1-1/8" (28.58mm)
Width 5/8" (15.88mm)

Order No. 09 - 10064

Front wheel spacer replaces Scag 43584. Fits our 08-9803, 08-9804 & 08-9809 wheels. Spacer for front wheel, bearing & seal.



ID 1-1/8" (28.58 mm)
OD 1-3/8" (34.93 mm)
Height 1" (25.40 mm)

Order No. 09 - 8476

Yoke bushing replaces Toro 28-9290, Scag 48100-02. Fits Toro midsize mowers 36", 37", 44", 52", 62" cut. Deck models 30136, 30137, 30144, 30152, 30162.



ID 7/8" (22.23 mm)
OD 1-1/8" (28.58 mm)
Height 1-1/4" (31.75 mm)
Flange OD 1-1/2" (38.10 mm)

Order No. 09 - 8305

Caster yoke support arm bushing replaces Exmark 1-303514, 1-303044, Snapper 76514, Kees 363194, Scag 48100-01.



ID 7/8" (22.23 mm)
OD 1-1/8" (28.58 mm)
Height 1" (25.40 mm)
Flange OD 1-1/2" (38.10 mm)

Order No. 09 - 5713

Replaces Scag 48100-01. Used on our 10-8189 support arm.



ID 1/2"
OD 5/8"
Height 4"

Order No. 09 - 7262

Spanner Bushing replaces Scag 43022. Used in our wheel bearing assembly 09-5812.



ID 1/2" (12.70 mm)
OD 5/8" (15.86 mm)
Length 6" (152.4 mm)

Order No. 09 - 9613

Spanner bushing replaces Scag 43430. Fits Scag turf tiger mowers. Used with our 08-9605 wheel assembly.



ID 1/2" (12.70mm)
OD 3/4" (19.05mm)
Length 7-1/2" (190.50mm)

Order No. 09 - 9992

Spacer replaces Exmark 1-633959 & Scag 43583. Fits Exmark Laser Z 13 x 650 x 6 wheels. Used with our 08-10075 wheel.



ID 1/2" (12.70mm)
OD 3/4" (19.05mm)
Length 5-7/8" (149.22mm)

Order No. 09 - 10017

Spacer replaces Exmark 1-633579, Scag 43581. Fits Exmark Laser Z 13 x 500 x 6 wheels. Used with our 08-9804 wheel.

30

O.E.M.



O.E.M. REPLACEMENT

SCAG (Cont.)



Order No. 09 - 7780

Replacement wheel bearing kit for our Bobcat, Grasshopper and Scag wheel assembly **08-3276**. Comes with (2) **09-481** high speed 5/8" (15.88 mm) bearings, (2) **10-7779** 2 1/32" (16.67 mm) x 1-1/8" (28.58 mm) washer and (1) **09-7262** 5/8" OD (15.88 mm) x 4-1/16" (103.19 mm) bushing.



ID 1.0625"
OD 1.99"
Height .578"

Order No. 09 - 13092

Tapered roller bearing replaces Scag 481022, replacement bearings for our **10-9153** spindle. Fits models MAG111, SCR, SM, SMST, STR, STT, SW, SWZ, SWLU, SWZU, Sabre Tooth Tiger and Turf Tiger; for 48A, 52A decks. Use 2 per spindle assembly. L44610 & L44649, cup & cone.



Order No. 09 - 10665

Caster yoke grease cap replaces Scag 481559. Also fits Dixie Chopper 10220 dust cap for 1"ID bearings.



ID 5/8" (15.88mm)
OD 1-1/4" (31.75mm)
Length 15/16" (23.81mm)

Order No. 09 - 9463

Roller cage bearing replaces Scag 481846. Used with our **08-9605** wheel assembly.

Overall ID 5/8" (15.88 mm)
Overall OD 1-27/64" (36.12 mm)
Overall Length 5-8/3" (136.53 mm)



Order No. 09 - 11720

Wheel bearing kit for Scag. Fits our **08-9605** Wheel.

Overall ID 5/8" (15.88 mm)
Overall OD 1-3/8" (34.93 mm)
Overall Length 3-7/16" (87.33 mm)



Order No. 09 - 5812

Open cage roller bearing with flanged bushings for our Scag Wheel Assembly **08-3276**. Replaces Scag 48006-06, 48006-07. Bearings are 5/8" ID (15.86 mm) x 1-3/8" OD (34.93 mm), 3-1/4" length (82.55 mm). Bushings are 5/8" (15.86 mm) x 1-3/8" OD (34.93 mm).

Order No. 09 - 8318

Wheel bearing kit for Scag. Used on our Scag wheel assembly **09-3276**. Contains our **09-5812** open cage roller bearing and **09-7262** bushing. Fits our **08-3276** & **08-8580** Wheels.

Overall ID 1/2" (12.70 mm)
Overall OD 1-3/8" (34.93 mm)
Overall Length 4-1/16" (103.19 mm)

Order No. 09 - 8994

Roller cage bearing only for Scag. Used on our Scag wheel assembly **08-3276**. OD 1-3/8" (34.93 mm), ID 5/8" (15.86 mm), Length 3-1/4" (82.55 mm).



Order No. 09 - 8995

Retainer bushing only for Scag. Used on our Scag wheel assembly **08-3276**. OD 1-3/8" (34.93 mm), ID 5/8" (15.86 mm).

Order No. 09 - 9701

Wheel bearing kit for Scag. Fits Scag 481551 front caster wheel assembly. Used on "ZERO TURN" Turf Tiger Model. Kit contains our **09-9702** roller cage bearing with retainer bushings and our **09-9613** spanner bushing.

Over all ID 21/32" (16.67mm)
Over all OD 1-3/8" (34.93mm)
Over all Length 6" (152.4mm)

Order No. 09 - 9702

Roller cage bearing with bushings only. Fits Scag 481551 front caster wheel assembly. Roller cage bearing OD 1-1/4" (31.75mm), ID 21/32" (16.66mm), Length 15/16" (23.81mm). Retainer bushings OD 1-3/8" (34.93mm), ID 5/8" (15.86mm), Height 1/2" (12.70mm)



30

O.E.M.



SCAG (Cont.)

Order No. 10 - 8985

Turn buckle replaces Scag 43025. Fits right hand front decks on 32", 36", 48", 52" & 61" cut mowers. 5/16" - 18 RH & LH threads.



Length 2-3/4"



ID 5/8"
OD 1-1/2"
Thickness 1/4"

Order No. 10 - 8372

Blade spacer replaces Scag 43278. Fits all Scag blades.



ID 21/32"
OD 1-1/8"
Thick. 1/16"

Order No. 10 - 7779

Wheel washer used in our wheel bearing kit 09-7780 and with our 08-3276 wheel assembly.



ID 1/2"
OD 1"
Height 1/2"

Order No. 10 - 7249

1/2" Blade spacer used on Scag.



ID 5/8"
OD 1"
Height 1/4"

Order No. 10 - 1191

Blade spacer replaces Scag 43038.



ID 3/4"
OD 7/8"
Height 1/2"

Order No. 10 - 8304

Idler arm shaft spacer replaces Scag 48100-05. Fits 32", 36", 40", 48", 52", 61" and 72" decks. MIN010



ID 7/8"
OD 1-1/2"
Height 1/2"

Order No. 10 - 8190

Caster yoke spacer replaces Scag 43037-01. Used with our 10-8189 support arm.



Order No. 10 - 8343

Blade Bolt replaces Scag 04001-41. Fits Scag mid size mower 32", 40", 48", 52", 61", 72" cut. 5/8" x 9-1/2" overall length.



Size 1/2"-7-1/2"

Order No. 10 - 11040

Wheel bolt replaces Scag 04001-134. Fits midsize mowers. Turf Tiger & Turf Cubs. Uses our 10-11076 nut.



Size 1/2"-9-1/2"

Order No. 10 - 11041

Wheel bolt replaces Scag 04001-167. Fits midsize mowers. Turf Tiger & Turf Cubs. Uses our 10-11076 nut.



ID 5/8"
OD 1"
Length 7-3/16"
Keyway 1/4"

Order No. 10 - 5999

7-3/16" Spindle Shaft Only. Replaces Scag 43001-02. Fits our 10-5722.



Size 1/2"- 13

Order No. 10 - 11076

Hex nut replaces Scag 0421-07. Used on our 10-1140 & 10-11041 wheel bolts. MIN010



Order No. 10 - 11565

Blade bolt nut replaces Scag 04020-09. 5/8" x 11 tread. Used with our 10-8343 blade bolt.

Order No. Description

10 - 6891 7/8" Foam Grips

10 - 6892 1" Foam Grips

Used on Scag, and other mid size mowers. Sold and priced in pairs.



30

O.E.M.

O.E.M. REPLACEMENT



SCAG (Cont.)



Size 5/16" - 18
Length 2-1/4"

Open Length 12-3/4"
Closed Length 10-1/4"

Order No. 10 - 8689

Right hand thread eyebolt replaces Scag 04070-01. Fits right hand front deck on 32", 36", 48", 52" & 61" cut models.

MIN010

Order No. 10 - 8690

Left hand thread eyebolt replaces Scag 04070-02. Fits left hand front deck on 32", 36", 48", 52" & 61" cut models.

MIN010



Order No. 10 - 11562

Gas damper replaces Scag 461090. 5/16" - 18 ball studs



Order No. 10 - 11954

Damper replaces Scag 482794.



Order No. 10 - 6974

Belt Clutch Spring replaces Scag 48051.



Order No. 10 - 7181

7/16" Lynch Pin replaces Scag 04066-01. Fits Scag 45006, 4-1/8" Yoke, our 10-7125.



Order No. 10 - 10358

Three Prong Clamping Knob. 3/8" - 16 Male thread clamping knob. Replaces Scag 481625-01.

Order No. 10 - 13524

Spindle grease seal replaces Scag 481024. Fits our 10-9153 spindle. OD 2" x 1-1/2" ID x .312".



Order No. 10 - 5722

7-3/16" Spindle Assembly. Replaces Scag 46020.



Order No. 10 - 9153

7-5/16" Spindle assembly replaces Scag 461663. Fits on models 1995 - present. New style with taper roller bearings. Uses our 09-13092 bearing set. Cast iron assembly.

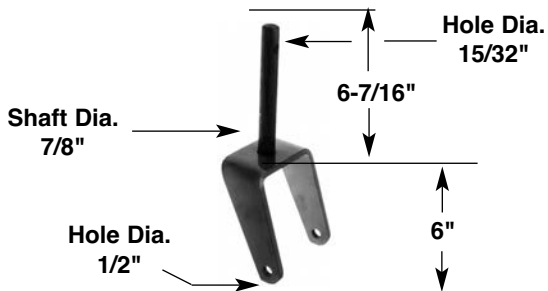

Order No. 10 - 7125

4-1/8" Caster Yoke. Replaces Scag 45006. Fits 36", 48" and 60" mowers. Used with our 10-8189 support arm.



Order No. 10 - 12977

Electric PTO clutch replaces Scag 461395, 461716, 481530. 6" Dia. Pulley, 5/8" Belt, shaft size 1-1/8". Fits Lazer Z.

30

O.E.M.



SCAG (Cont.)



Order No.

Description

12 - 7789	Blade Belt. Replaces Scag 48087. 5/8" (15.88 mm) x 52.9" (1343.66 mm), *Aramid fiber Used on Scag 48" cut mid size mowers.
12 - 10403	Blade Drive Belt. Replaces Scag 48799. 11/16" (17.5 mm) x 115" (2921 mm). Fits models SWZ-48. *Aramid cord construction, raw edge belt.
12 - 10404	Blade Drive Belt. Replaces Scag 48752. 21/32" (16.7 mm) x 120-3/8" (3057.5 mm). Fits models SMTZ-61. *Aramid cord construction, wrapped belt.
12 - 10405	Blade Drive Belt. Replaces Scag 48996. 21/32" (16.6 mm) x 135-1/2" (3441.7 mm). Fits model SMZ-61. Wrapped, *Aramid cord construction.
12 - 10407	Blade Drive Belt. Replaces Scag 481001. 21/32" (16.6 mm) x 128-13/32" (3267.9 mm). Fits model SMZ-52. Wrapped, *Aramid cord construction.
12 - 10411	Blade Drive Belt. Replaces Scag 481557. 21/32" (16.6 mm) x 123-15/16" (3148 mm). Fits model STT-52. Raw edge, *Aramid cord construction.
12 - 7631	Blade Drive Belt. Replaces Scag 48207. 86-1/8" (2187.58 mm) x 5/8" (15.88 mm). For 48" and 60" decks.
12 - 8714	Drive Belt. Replaces Scag 48912. 5/8" (15.88 mm) x 117.5" length (2984.5 mm). Fits models STHM with CV20 & CV22 hp. For 1994 & newer 61" cut models.
12 - 14593	 Deck Belt. Replaces Scag 483741 . 5/8" (15.87 mm) x 137" (3479.8 mm). Fits models SCZ61V, SCZ72V Cheetah, SMT-72V, STT-28CAT-SS, STT61V Turf Tiger. Wrapped molded, Aramid cord construction, double cover, clutching brown.
12 - 10043	Deck Belt. Replaces Scag 481461. 1/2" (12.7 mm) x 60.86" (1546 mm). Deck belt fits 52" & 61" Turf Tiger units. *Aramid fiber.
12 - 12824	Deck Belt. Replaces Scag 482652 , Ferris 5022061 5/8" (15.87 mm) x 175-29/32" (4468.1 mm). Fits Scag Tiger Cub SMTC-61, Wildcat 61" deck. Also fits Ferris ISZ Zero turn 61" deck. Wrapped-molded, aramid cord construction, double cover, clutching, salt/pepper color.
12 - 10046	Deck Drive Belt. Replaces Scag 482137. 21/32" (16.67 mm) x 116.75" (2965 mm). Deck drive belt for 48" Turf Tiger units. *Aramid fiber.
12 - 10047	Deck Drive Belt. Replaces Scag 482138. 21/32" (16.67 mm) x 50" (1270 mm). Deck drive belt for 48" RH cutter deck Turf Tiger units. *Aramid fiber.
12 - 10048	Deck Drive Belt. Replaces Scag 482139. 21/32" (16.67 mm) x 120" (3048 mm). Deck drive belt for 52" Turf Tiger units. *Aramid fiber.
12 - 10049	Deck Drive Belt. Replaces Scag 482140. 21/32" (16.67 mm) x 55" (1397 mm). Deck drive belt for 52" RH cutter deck Turf Tiger units. *Aramid fiber.
12 - 10317	Deck Drive Belt. Replaces Scag 481460. 5/8" (15.87 mm) x 43" (1092 mm). Fits Turf Tiger 52" & 61" decks. *Aramid Cord, cogged, raw edge belt.
12 - 10044	Deck Drive Belt. Replaces Scag 481558. 5/8" (15.9 mm) x 139.95" (3555 mm). Deck drive belt fits 61" Turf Tiger units. *Aramid fiber.
12 - 12069	Deck Drive Belt. Replaces Scag 483239. 43/64" (17.06 mm) x 50" (1270 mm). Fits SMTC 48V. Raw edge, cogged, aramid cord construction.

30

O.E.M.

O.E.M. REPLACEMENT



SCAG (Cont.)



Description

Order No.

12 - 12070	Deck Drive Belt. Replaces Scag 483240. 43/64" (17.06 mm) x 54-1/2" (1384.3 mm). Fits SMWC 52V. Raw edge, cogged, aramid cord construction.
12 - 12071	Deck Drive Belt. Replaces Scag 483241. 5/8" (15.875 mm) x 117-1/2" (2984.5 mm). Fits STC 48V. Wrapped, aramid cord construction.]
12 - 12072	Deck Drive Belt. Replaces Scag 483242. 5/8" (15.875 mm) x 125-1/2" (3187.7 mm). Fits STC & STWC 52V. Wrapped, aramid cord construction.
12 - 12073	Deck Drive Belt. Replaces Scag 483243. 5/8" (15.875 mm) x 135-1/2" (3441.7 mm). Fits STWC 61V. Wrapped, aramid cord construction.
12 - 12233	Deck Drive Belt. Replaces Scag 481980. 5/8" (15.875 mm) x 162-1/2" (4127.5 mm). Fits 72" Turf Tiger. Wrapped molded, aramid cord construction.
12 - 12371	Deck Belt. Replaces Scag 482530. 5/8" (15.875 mm) x 154-7/8" (3933.8 mm). Fits 52" up to 2005. Fits models SMTC-52' cut Tiger Cub.Raw edge, laminated, aramid cord construction.
12 - 12719	Deck Belt. Replaces Scag 483326 . 5/8" (15.875mm) x 148.255" (3765.7 mm). Fits model Freedom Z 52" deck. Wrapped-molded, neoprene, aramid cord construction, double cover, wrapped, clutching-white.
12 - 12718	Deck Belt. Replaces Scag 483325 . 5/8" (15.875mm) x 140.755" (3575.2 mm). Fits model Freedom Z 48" deck. Wrapped-molded, neoprene, aramid cord construction, double cover, wrapped, clutching-white.
12 - 10318	Pump Drive Belt. Replaces Scag 482641. 1/2" (12.70 mm) x 79-13/16" (2027 mm). Fits Turf Tiger. *Aramid Cord, laminated, raw edge belt.
12 - 10319	Pump Drive Belt. Replaces Scag 482716. 1/2" (12.70 mm) x 61.5/8" (1565 mm). Fits Tiger Cub. *Aramid Cord, laminated, raw edge belt.
12 - 10402	Pump Drive Belt. Replaces Scag 48587. 17/32" (13.5 mm) x 57" (1447.8 mm). Fits models SWZ-52 & 61. *Aramid cord construction, raw edge belt.
12 - 10050	Pump Drive Belt. Replaces Scag 482171. 1/2" (12.7 mm) x 60" (1524 mm). Fits Scag 52" & 61" cut Turf Tiger.
12 - 7790	Engine to Blade. Replaces Scag 48089. "B" section belt, 89.6" (2275.84 mm), *Aramid fiber. Used on Scag 48" cut mid size mowers.
12 - 10045	Transmission Drive Belt. Replaces Scag 482009. 1/2" (12.7 mm) x 52" (1321 mm). Transmission drive belt fits 40", 48" & 52" Turf Tiger units. *Aramid fiber.
12 - 7791	Transmission Drive Belt. Replaces Scag 48203. 1/2" (12.70 mm) x 39.8" (1010.92 mm), *Aramid fiber. Used on Scag 32", 36", 48", 52" and 61" cut mid size mowers.
12 - 10409	LH Transmission Drive Belt. Replaces Scag 481498. 1/2" (12.7 mm) x 41-3/4" (1060.5 mm). Fits model STR. Raw edge, *Aramid cord construction.
12 - 10410	RH Transmission Drive Belt. Replaces Scag 481499. 1/2" (12.7 mm) x 34 (863.6 mm). Fits model STR. Raw edge, *Aramid cord construction.
12 - 10914	Pump Drive Belt. Replaces Scag 481749. 1/2" (12.7 mm) x 59" (1498.6 mm). Fits Turf Tiger models. Raw edge, laminated, aramid cord construction.
12 - 12049	Pump Drive Belt. Replaces Scag 48553. 1/2" (12.7 mm) x 50-1/2" (1282.7 mm). Fits

30

O.E.M.



SCAG (Cont.)



Order No.	Description
12 - 12067	SWZ. Raw edge, laminated, aramid cord construction. Pump Drive Belt. Replaces Scag 483157. 43/64" (17.06 mm) x 65" (1651 mm). Fits STC. Raw edge, cogged, aramid cord construction.
12 - 12068	Pump Drive Belt. Replaces Scag 483172. 43/64" (17.06 mm) x 65-5/8" (1666.87 mm). Fits STC. Raw edge, cogged, aramid cord construction.
12 - 12085	Pump Drive Belt. Replaces Scag 483165. 5/8" (15.875 mm) x 80" (2032 mm). Fits Turf Tiger. Raw edge, cogged, aramid cord construction.
12 - 12248	Pump Drive Belt. Replaces Scag 482873. 1/2" (12.7 mm) x 79-1/2" (2019.3 mm). Fits 52" Turf Tiger. Raw edge, laminated, aramid cord construction.
12 - 12249	Pump Drive Belt. Replaces Scag 482876. 5/8" (15.875 mm) x 43-3/4" (1111.25 mm). Fits Turf Tiger. Raw edge, cogged, aramid cord construction.
12 - 13257	Pump Drive Belt. Replaces Scag 483314 . 1/2" (12.7 mm) x 80.755" (2051.2mm). Laminated, Aramid cord construction.
12 - 10365	Cutter Deck Belt. Replaces Scag 482529. 21/32" (16.6 mm) x 148" (3759.2 mm). Fits 48" Tiger Cub. *Aramid Cord, wrapped clutching cover.
12 - 5236	Cutter Deck Belt. Replaces Scag 48204. "B" Section Belt, 82" length (2082.80 mm). (Fits Belt Drive Walk Behind 36" cut).
12 - 5235	Wheel Drive Belt. Replaces Scag 48202A, 48202. Double "A" Section Belt, 51.5" length (1308.10 mm). (Fits Belt Drive Walk Behind)

*Made with KEVLAR® or non-trade marked Aramid fiber.

 <p data-bbox="667 1318 846 1402">ID 3/8" OD 5-3/16" Height 1-3/16"</p> <p data-bbox="180 1535 846 1619">Order No. 13 - 5712 Idler Pulley. Replaces Scag 48269, 48198. Traction Belt Pulley 32", 36", 48", 52" and 61" decks.</p>	 <p data-bbox="1373 1318 1536 1402">ID 3/8" OD 5-7/8" Height 1-1/4"</p> <p data-bbox="873 1535 1544 1619">Order No. 13 - 6572 Idler pulley replaces Scag 48269. Deck Idler on 40" and 48" decks.</p>
 <p data-bbox="680 1667 846 1751">ID 3/8" OD 3-3/4" Height 1-1/4"</p> <p data-bbox="180 1940 553 2003">Order No. 13 - 12930 Idler pulley replaces Scag 483173.</p>	 <p data-bbox="1382 1667 1536 1751">ID 3/8" OD 5" Height 2-1/2"</p> <p data-bbox="873 1913 1536 2003">Order No. 13 - 11464 Flat idler pulley replaces Scag 483210, 481962. Fits models with floating cutter deck SWZU & SWU. Heavy duty. Fits 06 models.</p>

30

O.E.M.

**O.E.M. REPLACEMENT
SCAG (Cont.)**



ID 3/8"
OD 3-5/16"
Height 1-1/4"
Flat Width 3/4"

Order No. 13 - 13614

Idler pulley replaces Scag 483208, 481048 & Encore 363169.



ID 3/8"
OD 4-1/4"
Height 1-1/4"
Flat Width 3/4"

Order No. 13 - 13615

Idler pulley replaces Scag 483214, 482655. Fits LT models.



ID 3/8"
OD 3-3/4"
Height 1-5/8"

Order No. 13 - 12712

Idler pulley replaces Scag 483415.



ID 1-5/8"
OD 5-3/4"
Height 7/8"

Order No. 13 - 11228

Spindle pulley replaces Scag 482744, 48924, 48127. Fits STHM, SW & SWZU models. Uses our 13-9600 hub. Also replaces Encore 363216 & Ferris 1520814.



ID 3/8"
OD 5"
Height 7/8"

Order No. 13 - 10414

Pump drive idler pulley replaces Scag 48181. Fits models SSZ, SWZ & Turf Tiger. 5/16" offset reducer bushing. Also replaces AYP 101344L, Bunton PL8540A & Encore 483025.



ID 1-5/8"
OD 5-29/64"
Height 7/8"

Order No. 13 - 11208

Pump shaft pulley replaces Scag 482649. Fits 2005 SWZ walkbehinds, 2005 SCZ zero turn riders 36" & 42" cut & SWZU walkbehind 36" thru 61" cut models.



ID 1-5/8"
OD 6-11/32"
Height 7/8"

Order No. 13 - 11209

Spindle pulley replaces Scag 482745. Fits 2005 SWZ walkbehinds, & 2005 Turf Tiger model #31BSD.



ID 1-5/8"
OD 6-61/64"
Height 7/8"

Order No. 13 - 11211

Spindle pulley replaces Scag 482747. Fits 2005 Turf Tiger model 31BSD.



ID 1-5/8"
OD 5-3/4"
Height 2"

Order No. 13 - 11212

Spindle pulley replaces Scag 482748. Double groove pulley. Fits 2005 SWZ walkbehinds.



ID 1-5/8"
OD 6-1/4"
Height 7/8"

Order No. 13 - 11213

Deck drive pulley replaces Scag 482752. Fits 2005 Turf Tiger model 31BSD.



ID 1"
OD 4"
Height 1-3/4"
Keyway 1/4"

Order No. 13 - 11214

Deck drive pulley replaces Scag 482754. Fits 2005 SWZU walkbehind 36" thru 61" cuts.

30

O.E.M.



SCAG (Cont.)



ID 1-9/16"
OD 5-3/4"
Height 7/8"

Order No. 13 - 10412

Idler pulley replaces Scag 48062. Deck idler pulley fits 48" & 61" decks, 1999 and older STHM models.



ID 1-9/16"
OD 4"
Height 41/64"

Order No. 13 - 10413

Idler pulley replaces Scag 48065. Engine deck idler pulley fits OST & STHM models.



ID 1"
OD 4"
Height 1-3/4"
Keyway 1/4"

Order No. 13 - 11215

Pump drive engine pulley replaces Scag 482755. Fits 2005 SWZ walkbehinds.



ID 1-1/8"
OD 5-1/2"
Height 1-43/64"
Keyway 1/4"

Order No. 13 - 11216

Deck drive pulley replaces Scag 482791. Fits 2005 Turf Tiger model 31BSD.



ID 9/16"
OD 5-1/2"
Height 1-1/2"
Keyway 3/16"

Order No. 13 - 10764

Pump pulley replaces Scag 48586. Fits SWZ, Turf Tiger, Cougar mowers.



ID 1"
OD 5-9/16"
Height 7/8"
Keyway 1/4"

Order No. 13 - 10418

Engine pump pulley replaces Scag 48792. Fits 61" & 72" deck models STC & STHM.



ID 1"
OD 4-3/4"
Height 1-3/8"
Keyway 1/4"

Order No. 13 - 10769

Blower housing and grass catcher pulley replaces Scag 482298. Fits models GC-STC & GC-SST.



ID 3/8"
OD 4-1/2"
Height 1-1/4"

Order No. 13 - 9844

Idler pulley replaces Scag 48473. Composite; glass filled nylon.



ID 3/8"
OD 3-7/16"
Height 1-3/16"

Order No. 13 - 7983

Transmission idler pulley replaces Scag 481048 & 48201. Fits 36", 46" and 52" gear drive commercial mowers.



ID 3/8"
OD 4"
Height 15/16"

Order No. 13 - 10417

V-Idler pulley replaces Scag 482062. Fits units with the built on blower system for grass catchers.



ID 2-1/4"
OD 8"
Height 1/2"

Order No. 13 - 9758

Pulley and brake drum assembly replaces Scag 48992. Includes our 05-9757 brake drum & 2 pulleys.



ID 3/8"
OD 4-5/8"
Height 11/16"

Order No. 13 - 5714

Mower Blade Deck Idler. Replaces Scag 48068 Belt Guide Idler.

30

O.E.M.



O.E.M. REPLACEMENT
SCAG (Cont.)



ID 5/8"
OD 3-1/4"
Height 1-3/4"
Keyway 3/16"

Order No. 13 - 7124

Double Pulley replaces Scag 48199. Fits 36", 48", 60" and 72" mid size mowers.



ID 3/8"
OD 3-1/4"
Height 1"
Keyway 3/16"

Order No. 13 - 8587

Heavy duty transmission idler pulley replaces Scag 481048. Fits 36", 46" & 52" gear drive commercial mowers.



ID 5/8"
OD 7-1/2"
Height 21/32"
Keyway 3/16"

Order No. 13 - 7786

Input shaft pulley replaces Scag 48197.



ID 1"
OD 2-3/4"
Height 1-1/2"
Keyway 1/4"

Order No. 13 - 10768

Engine pulley replaces Scag 481666. Fits models SW & SWU walkbehinds.



ID 15mm
OD 2"
Height 1-1/4"
Keyway 3/16"

Order No. 13 - 10773

Tapered hub replaces Scag 482085. Includes 2 screws.



ID 17mm
OD 2-1/2"
Height 1-1/4"
Keyway 3/16"

Order No. 13 - 10774

Tapered hub replaces Scag 481884. Includes 2 screws.



ID 1"
OD 3-3/16"
Height 1-5/16"
Keyway 1/4"

Order No. 13 - 10775

Tapered hub replaces Scag 481536.



ID tapered 1-19/32" to 1-19/32"
OD 6-1/4"
Height 7/8"

Order No. 13 - 9601

Spindle pulley replaces Scag 48753. Fits Turf Tiger spindles. Used with our 10-9153 spindle assembly & our 13-9600 tapered hub. Fits left hand spindle.



ID tapered 1-19/32" to 1-19/32"
OD 7"
Height 7/8"

Order No. 13 - 9602

Spindle pulley replaces Scag 48967. Fits Turf Tiger spindles. Used with our 10-9153 spindle assembly & our 13-9600 tapered hub. Fits right hand spindle.



ID 1-1/8"
OD 2-15/32"
Height 1-1/4"
Keyway 1/4"

Order No. 13 - 9600

Tapered hub replaces Scag 48926. Fits Turf Tiger spindles. Used with our 10-9153 spindle assembly & our 13-9601 & 13-9602 spindle pulleys.

Order No. 13 - 6532

Taper Hub Only. Replaces Scag 48141-01. Used with our 13-5988.



ID 1-1/16"
OD 2-1/2"
Height 1-3/16"
Keyway 1/4"

30

O.E.M.



O.E.M. REPLACEMENT

SCAG (Cont.)



ID 1-1/16"
OD 5-3/4"
Height 1-3/16"













ID taper 1-9/16" to 1-5/8"
OD 5-3/4"
Height 7/8"

Order No. 13 - 5989

Spindle Pulley with taper hub. Replaces Scag 48127.

Order No. 13 - 5988

Pulley only. Replaces Scag 48127-01. Used with our 13-6532 Taper Hub.

ORDER NO.	REPLACES O.E.M. NO.	LENGTH	CENTER HOLE DIAM.	OUTSIDE HOLE DIAM.	CENTER TO CENTER	WIDTH	STEEL THICK.	APPLICATION
15 - 3403 	482461	16-1/2"	5/8"	419.1mm	15.9mm	2-1/2"	.204"	(2) blades for 32" cut & (3) blades for 48" cut
	481706							
	481110							
15 - 6009 	481710	16-1/2"	5/8"	419.1mm	15.9mm	3"	.204"	(2) blades for 32" cut & (3) blades for 48" cut High Lift
	48184							
15 - 6300 	A48184	16-1/2"	5/8"	419.1mm	15.9mm	2-1/2"	.204"	Mulching Blade PATENTED
	A48110							
15 - 3404 	482878	18"	5/8"	457.2mm	15.9mm	2-1/2"	.204"	STD Lift (2) blades for 36" cut & (3) blades for 52" cut
	482462							
	481707							
	48108							
15 - 3442 	481711	18"	5/8"	457.2mm	15.9mm	3"	.204"	(2) blades for 36" cut & (3) blades for 52" cut High Lift
	48185							
15 - 10173 	48185	18"	5/8"	457.2mm	15.8mm	2-1/2"	.204"	Flat Blade Sharpened - 4-sides
15 - 9229 	482235	18"	5/8"	457.2mm	15.9mm	2-1/2"	.204"	Mulching Blade PATENTED
15 - 6294 	481707	18"	5/8"	457.2mm	15.9mm	2-1/2"	.204"	Mulching Blade PATENTED
	48185							
	48108							
15 - 9968 	48185	18"	5/8"	457.2mm	15.8mm	2"	.240"	Low-Lift Blade Sharpened - 4-sides
15 - 6008 	48109	20"	5/8"	508mm	15.9mm	2-1/2"	.204"	(2) blades for 40" cut

30
O.E.M.

O.E.M. REPLACEMENT
SCAG (Cont.)



30
O.E.M.

ORDER NO.	REPLACES O.E.M. NO.	LENGTH	CENTER HOLE DIAM.	OUTSIDE HOLE DIAM.	CENTER TO CENTER	WIDTH	STEEL THICK.	APPLICATION
15 - 3434	482879 481708 48111	21" 533.4mm	5/8" 15.9mm			2-1/2" 63.5mm	.204" 5.2mm	(3) blades for 61" cut
15 - 6299	A48111	21" 533.4mm	5/8" 15.9mm			2-1/2" 63.5mm	.204" 5.2mm	Mulching Blade PATENTED
15 - 9230	482237	21" 533.4mm	5/8" 15.9mm			2-1/2" 63.5mm	.204" 5.2mm	Mulching Blade PATENTED
15 - 10930	481712	21" 533.4mm	5/8" 15.8mm			3" 76.2mm	.204" 5.2mm	(3) Blades for 61" cut. High Lift Blade.
15 - 10174	A48111	21" 533.4mm	5/8" 15.8mm			2-1/2" 63.5mm	.204" 5.2mm	Flat Blade Sharpened - 4-sides
15 - 9969	A48111	21" 533.4mm	5/8" 15.8mm			2" 50.8mm	.240" 6.1mm	Low-Lift Blade Sharpened - 4-sides
15 - 6026	481709 48112	24-1/2" 622.3mm	5/8" 15.9mm			2-1/2" 63.5mm	.204" 5.2mm	(3) blades for 72" cut
15 - 9883	48112	24-1/2" 622.3mm	5/8" 15.9mm			2-1/2" 63.5mm	.204" 5.2mm	Mulching Blade PATENTED



Order No. 19 - 9380

Transmission oil filter replaces Scag 48758. Also fits Steiner, Bobcat and Land Pride. Thread size 1" - 12, mounting seal OD 2-3/4", OD 3-11/16", Height 5-1/4", 10 Micron.



Order No. 19 - 12374

Oil filter replaces Hydro Gear HG52114. Fits (Transmission Model ZT2800). Replaces Scag HG52114.



Order No. 19 - 8631

Hydro filter replaces Scag 48462-01. 10 microns.



SCAG (Cont.)



Order No. 20 - 12566

Gas cap replaces Scag 481661. Fits Turf Tiger with 2-1/4" fuel tank neck.



Order No. 20 - 12567

Gas cap replaces Scag 482497. Fits Turf Tiger with 3-1/2" fuel tank neck.



ID 3-1/2"

Order No. 20 - 9650

Vented fuel cap replaces Scag 482547.



Order No. 20 - 6000

Fuel Filter round in-line, for 1/4" fuel line. Replaces Scag 48057-02. 150 micron element. For engines without fuel pumps. MIN010



Order No. 20 - 11273

Two-Way Fuel cut-off valve. 1/4" barb fitting. Fits Zero Turn riders with two tanks. Also replaces Exmark 1-633347 & Hustler 745059, Scag 482-212.



Order No. 23 - 12111

Oil drain valve (Metric M16 x 1.5) threads. Replaces Scag 482351.



Order No. 23 - 12112

Oil drain valve (Metric M20 x 2.5) threads. Replaces Scag 482349.



Order No. 23 - 12259

Oil drain valve (3/8" - 18 NPTF) threads. 2-1/8" longer version of our 23-12260. Replaces Scag 482352.



Order No. 31 - 9663

Plunger interlock switch replaces Scag 481638. Single post, right angle snap mounted. Normally open.



Order No. 31 - 9664

Plunger Interlock switch replaces Scag 48717. Single post, right angle snap in mounted. Normally closed.

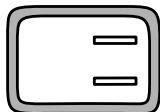

Order No. 31 - 9660

Plunger Interlock switch replaces Scag 481637. Single pole, normally open.

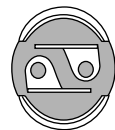

Order No. 31 - 9622

Multi-application ignition switch. Fits single stage Scag. Includes key, lockwasher nut. 2 terminals/ 2 positions.

30

O.E.M.

O.E.M. REPLACEMENT
SCAG (Cont.)



Order No. 31 - 2922
Ignition Switch Scag 48017. (Magneto)

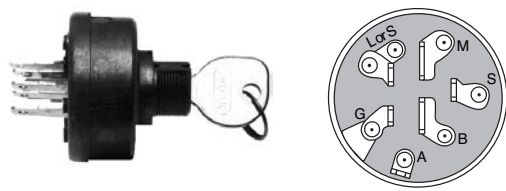

Order No. 31 - 7804
Ignition Switch replaces Scag 48798.

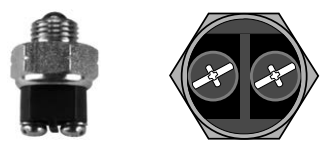

Order No. 31 - 8911
Safety switch replaces Scag 48021. Fits walkbehind mowers for "G" series PTO & "G" series PRO. 2 terminal, 9/16" mounting stem, normally open contact.

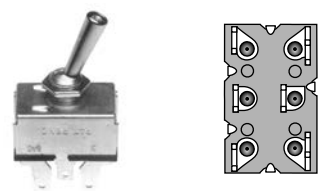

Order No. 31 - 7922
PTO switch replaces Scag 48787. Includes mounting hardware.

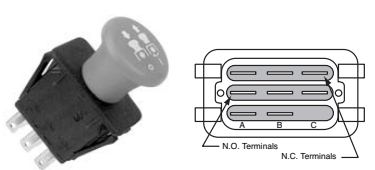

Order No. 31 - 9656
PTO switch replaces Scag 481687, 27328. Push-pull/Snap in mount. Corner terminal blank. Red Knob.

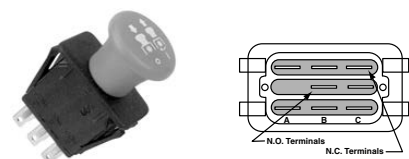

Order No. 31 - 9657
PTO switch replaces Scag 481635, 700675. Middle terminal blank. Push-pull/Snap in mount. Red Knob.

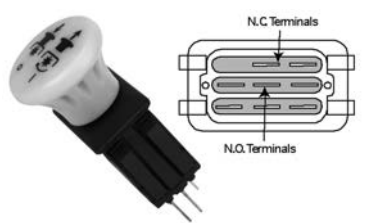

Order No. 31 - 13248
PTO switch replaces Scag 483957. 10 amp PTO switch.



Order No. 31 - 12839
Ignition switch replaces Scag 483472. Plastic snap bezel. 3 position 5 terminals.

Order No. 31 - 14427
Solenoid replaces Scag 483278.



30
O.E.M.



SNAPPER

Order No. 02 - 9492

Retaining ring/snap ring replaces Snapper 7010746. Fits Snapper front end mowers. Also included in our **10-8322** front end repair kit.
MIN010



Order No. 03 - 239

Throttle. Replaces Snapper 7018186. Positive action. Rear detent for stop position. Used on automatic choke carburetor. Adjustable friction.



Conduit 48-3/4"
Inner Wire 52-3/16"
Wire Travel 1-1/8"

Order No. 03 - 7812

Throttle. Replaces Snapper 7060916. Fits B&S 3-1/2 hp, 21" self propelled model T21357B.



Conduit 45-1/2"
Inner Wire 47-3/4"
Wire Travel 1-1/2"

Order No. 03 - 234

Replaces Snapper 7011991. Positive Action Control.



Conduit 59-3/16"
Inner Wire 62-5/8"
Wire Travel 1-5/8"

Order No. 03 - 231

Throttle. Replaces Snapper 7018889. Negative Action Control. Used on Briggs & Stratton equipped riding mowers.



Conduit 11-25/32"
Inner Wire 14-3/32"
Wire Travel 1-9/16"

Order No. 03 - 241

Throttle. Replaces Snapper. Positive Action Lever Control. Plastic knob with steel lever.



Conduit 71-1/4"
Inner Wire 74-1/8"
Wire Travel 1-5/8"

Order No. 03 - 233

Throttle. Replaces Snapper 7012061. Control for use on Tecumseh equipped Snapper riding mowers. Fits 8 hp Tecumseh and 5 hp Briggs & Stratton.



Conduit 56-3/16"
Inner Wire 59-1/2"
Wire Travel 1-11/16"

30
O.E.M.

**O.E.M. REPLACEMENT
SNAPPER (Cont.)**



Conduit 40"
Inner Wire 50-5/16"
Wire Travel 1-7/32"



Order No. 03 - 244

Throttle. Replaces many models of Roper, Snapper, Yardman, Jacobsen and Southland Mowers. Positive Action Lever Control. Plastic knob with steel lever.

Conduit 49"
Inner Wire 51-1/8"
Wire Travel 1-1/2"



Order No. 03 - 867

Replaces Snapper 7018188. Positive Action Control.

Conduit 13-1/2"
Inner Wire 15-5/8"
Wire Travel 1-1/2"



Order No. 03 - 5805

Replaces Snapper 7018889. Used on 8, 10, 11 and 12 hp B&S equipped riders. (Heavy Duty)

Conduit 45"
Inner Wire 47"
Wire Travel 1-1/2"



Order No. 03 - 6589

Throttle Control. Replaces Snapper 7019254. Fits 1990 & 91 V-21 Snapper with 5 hp Quantum engines.



Order No. 05 - 2699

Clutch Cable. Replaces Snapper 7012605 for 33" rear engine riders. Length 55". (Black)

Order No. 05 - 2700

Clutch Cable. Replaces Snapper 7012425 for 26", 28" and 30" rear engine riders. Length 51-3/4". (Yellow)

Length 50"



Order No. 05 - 8294

Brake cable replaces Snapper 7015477. Fits Snapper rear engine riders with 33" and 41" decks and one brake/clutch pedal.

Length 47"



Order No. 05 - 8293

Brake cable replaces Snapper 7015476. Fits Snapper rear engine riders with 28" and 30" decks and one brake/clutch pedal.

Cable Length 42"



Order No. 05 - 12075

Drive cable replaces Snapper 70034604. Fits 21" self propelled units. Eye & Z Bend endings.

30

O.E.M.



SNAPPER (Cont.)



Order No. 05 - 14173

Transfer rod replaces Snapper 7023790. Fits 21" self propelled walk-behind mowers. Used with our 05-6880 & 05-14174.



Order No. 05 - 14174

Transfer rod connector replaces Snapper 7032831, 7031874, 7032831. Fits 21" self propelled walkbehind mowers. Used with our **05-6880** & **05-14173**.

Order No. 41 - 7678

Drive disc for snowblowers replaces Snapper 7017226. Fits Snapper 4, 5, & 8 hp Snowthrower models 4222, 5222, 5242, 7222, 7242 & 8264.



Order No. 05 - 10169

Disc with liner replaces Snapper 7057423, 7053103. Contains our **05-300** disc and **05-345** liner.



ID 3"
OD 6"

Order No. 05 - 300

Drive Disc. Replaces Snapper 7010765.

30

O.E.M.



Order No. 05 - 345

Lining Only. Replaces liner in Snapper 7057423. Non-Asbestos. MIN005



Order No. 05 - 8632

Oil seal replaces Snapper 7011817. Rear axle oil seal for rear engine riders. ID 1-1/16", OD 1-13/16. MIN010

Order No. 05 - 8665

Oil seal replaces Snapper 7014662. Left rear wheel oil seal on 25", 26", 28", 30" & 33" cut rear engine riders. ID 11/16", OD 1-27/32". MIN010



ID 3/4"
OD 1"

Order No. 05 - 8816

Shim washer replaces Snapper 7010121. Fits Snapper 57444 driven disc assembly. MIN010



ID 3"
OD 4"

Order No. 05 - 301

Driven Ring replaces Snapper 7023364 and 7010927.

Order No. 05 - 6880

Driven Disc Assembly replaces Snapper 7053225, 7053225, 7057444. Used on Snapper self-propelled mowers.



O.E.M. REPLACEMENT



SNAPPER (Cont.)



Order No. 05 - 5952

Long Oil Seal Boot for Snapper Riders. Replaces Snapper 7011011, 7075115, 17084. Length 10-1/2".



Order No. 05 - 5951

Short Oil Seal Boot for Snapper Riders. Replaces Snapper 7018555, 7017083. Length 8-1/4".



Order No. 05 - 6931

Drive Plate Bushing Only. Replaces Snapper 7013893.

MIN010



Order No. 05 - 8603

Drive plate bushing replaces Snapper 7017696. Bushing for 1993 & later models. Used in our 05-6930 assembly.

MIN010



Order No. 05 - 3244

Oil Fill & Check Plug. Replaces Snapper 7011024.

MIN010



Order No. 05 - 6930

Drive Plate and Bushing replaces Snapper 7061275, 7061275, 7060710. Used on Snapper self-propelled mowers.



Order No. 05 - 5803

Hex Shaft. Replaces Snapper 7072284, 7023744, 7021745. For Snapper 21" self propelled walk behind mowers. Length 8-1/4".



Order No. 05 - 3245

Transmission Case Gasket. Replaces Snapper 7018060.

MIN010



Order No. 05 - 3246

Chain Case Gasket. Replaces Snapper 7028761, 7018059.

MIN010



Order No. 05 - 3247

Transmission Gasket. Replaces Snapper 7011774. For all 21" self-propelled mowers.

MIN010

30

O.E.M.



SNAPPER (Cont.)



Order No. 05 - 7255

Thrust washer replaces Snapper 7014523. Used on Snappers Smooth Clutch Assembly between disc and plate.

MIN010



Diameter 7"
Width 3/4"

Order No. 05 - 7787

Brake band replaces Snapper 7017048, 7074810. For 36", 40", 48", 52", 61" mid size mowers.



Order No. 42 - 7097

Gear Box Assembly. Replaces Snapper 7076380 & 70362025. (12.5 to 1 gear ratio)



ID 5-1/4"

Order No. 05 - 8276

Brake assembly replaces Snapper 7076340, 70322042. Fits 32", 36" and 48" variable and 5 speed mower decks (left side).



Order No. 06 - 8262

8" x 1-5/8" offset hub, radial tread, 7/16" bearing, replaces Snapper 7026182. Fits 21" commercial CP model, Solid Tire. (painted gray)



Order No. 06 - 8263

9" x 1-5/8" offset hub, radial tread, 7/16" bearing, replaces Snapper 7022800. Fits 21" pushmower. (painted gray)



Order No. 06 - 271

8" x 1.75", 1-5/8" offset hub. Steel Wheel. Repl. Snapper 7011082. 7/16" bearing. Used as a rear wheel on 21" models. (painted white)

Order No. 06 - 272

7" x 1.50", 1-5/8" offset hub. Steel Wheel. Repl. Snapper 7011083. 7/16" bearing. Used as a front wheel on 21" models. (painted white)

Order No. 06 - 2985

7" x 1.75" Steel Wheel. Replaces Snapper 7011083, 7011083, 7012347. Has 7/16" Ball Bearing. 1-5/8" offset hub. (front) (painted white)

Order No. 06 - 2986

9" x 1.75" Steel wheel. Replaces Snapper 70146071, 7012603, 7012603. Has 7/16" Ball Bearing. 1-5/8" offset hub. (rear) (painted white)



Order No. 06 - 286

9" x 1.95", Steel Wheel replaces Snapper 7014604, 7012345. 1-3/4" offset hub. 9/16" oblong center hole. Fits self-propelled drive wheel on commercial models. (rear) (painted white)



Order No. 06 - 6709

9" x 2.00", 1-3/4" offset hub, 9/16" oblong center hole. Replaces Snapper 1709201, 7019198. New "S" tread design, solid rubber tire. Fits self-propelled drive wheel on commercial models. (rear) (painted gray)

Order No. 06 - 9612

Steel wheel replaces Snapper 7046678. 10 x 1.75, diamond tread. Fits 21" walkbehind mowers. 7/16" ball bearing, 1-5/8" offset hub. (painted gray)



30

O.E.M.

O.E.M. REPLACEMENT
SNAPPER (Cont.)



Order No. 07 - 9559

Deck wheel replaces Snapper 7019190. 2-27/32" height, 2-15/16" width, 5/8" ID.



ID 1/2"
Width 2-3/4"
Height 5"

Order No. 07 - 6916

Deck Wheel. Replaces Snapper 7029264. 2-1/2" offset hub.



ID 1/2"
Width 1-1/2"
Height 4"

Order No. 07 - 6914

4" x 1-1/2" Deck Wheel. Replaces Snapper 7026122. 1-1/2" offset hub.



Order No. 07 - 2990

9" x 1.75" Plastic. 9/16" x 7/16" oblong C.H. wheel. Replaces Snapper 7014604, 7012496. For self-propelled. 1-3/4" hub. (painted white)



Order No. 06 - 9875

Steel wheel replaces Snapper 7011082, 7011082, 7035727. 8" x 1-3/4", ball bearing, 7/16" bore. Diamond tread, painted gray.



Order No. 07 - 8930

9" x 1.75", spline drive bushing. Replaces Snapper 7022797. Fits 21" walk behind mowers. 7/16" x 9/16" oblong center hole. (Gray)

Order No. 07 - 8932

10" x 1.75", spline drive bushing. Replaces Snapper 7035740. Fits 21" walk behind mowers. (Gray)



Order No. 07 - 8928

7" x 1.50", 9/16" C.H., 1-5/8" hub. Replaces Snapper 7022795. Fits 21" walk behind mowers. (Gray)

Order No. 07 - 8927

8" x 1.75", 9/16" C.H., 1-5/8" hub. Replaces Snapper 7022374. Fits 21" walk behind mowers. (Gray)

Order No. 07 - 8929

9" x 1.75", 9/16" C.H., 1-5/8" hub. Replaces Snapper 7022796. Fits 21" walk behind mowers. (Gray)

Order No. 07 - 8931

10" x 1.75", 9/16" C.H., 1-5/8" hub. Replaces Snapper 7035739. Fits 21" walk behind mowers. (Gray)



Order No. 07 - 855

9" x 1.75" Plastic Wheel. Replaces Snapper 7012579. 9/16" center hole, 1-5/8" hub. Rear wheels on steel and aluminum deck push mowers. (painted white)

Order No. 07 - 2991

7" x 1.50", 9/16" center hole. Plastic Wheel. Replaces Snapper 7018189. 1-5/8" hub. (front) (painted white)

Order No. 07 - 2992

8" x 1.75" Plastic Wheel. Replaces Snapper 7018190. 9/16" center hole, 1-5/8" hub (rear). Also has 30 to 35 lbs. load rating. (painted white)

Order No. 08 - 341

4.10" x 3.50" x 4" Stud Tire, 2 ply tube type. Repl. Snapper 7010820. (front tire)

Order No. 08 - 344

4.80" x 4.00" x 8" Stud Tire, 2 ply tube type. Repl. Snapper 7010524. Used as rear tire on 25" and 26" cut Snapper riders.



30

O.E.M.



SNAPPER (Cont.)



Order No. 08 - 7328

410 x 350 x 4 Turf Tire, 2 ply tubeless. Replaces Snapper 7052267, 7010820.



Order No. 08 - 347

16 x 6.50 x 8 Turf Tread, 2 ply tubeless. Replaces Snapper 7015968, 7011097. Used as rear tire for 28", 30" and 33" cut Snapper riders.



Order No. 08 - 905

13 x 650 x 6 Drive Wheel Assembly. 6-1/2" offset hub length, 7/8" bearings (roller), 4 ply tubeless. Replaces Snapper/Kees 7076409.



Order No. 08 - 9151

Wheel assembly replaces Snapper 7052270, 7050713. 16 x 650 x 8, 2 ply tubeless turf saver tread tire, one piece rim. Fits rear engine rider. 3 hole bolt pattern. (White)



Order No. 08 - 10106

11 x 400 x 4, 4 ply front wheel assembly. Replaces Snapper 7058943 & 7053304. One piece rim with 3/4" bearing, zerk fitting, tubeless turf tire. Fits rear engine riders. (Gray)



Order No. 08 - 9155

Wheel assembly replaces Snapper 7050294. 16 x 650 x 8, 2 ply tubeless turf saver tread tire, one piece rim. Fits rear engine rider. 4 hole bolt pattern. (White)

Order No. 08 - 7285

410 x 4 Wheel Assembly replaces Snapper 7052267, 7052305, 7050618. One piece rim & 3-1/4" hub length, zerk fitting, tubeless turf tread. For Series 7 & up. Replacement tire **08-7328**. 10-1/2" Height (painted gray)



Order No. 08 - 10892

Wheel assembly replaces Snapper 7052267. 410 x 350 x 4. One piece rim, zerk fitting, tubeless turf tread tire from Carlisle. 11" Height. (Painted Gray).



Order No. 08 - 8278

410 x 350 x 4, 2 ply stud tread tubeless tire, 3-1/4" offset hub with zerk fitting and 3/4" bearings. Replaces Snapper 7052268, 7052267, 7050618 and 7051449. 1 piece rim & hub. (painted white).

30

O.E.M.



**O.E.M. REPLACEMENT
SNAPPER (Cont.)**

**Puncture Proof Tire
Wheel Assemblies**



Order No. 08 - 9947

4" centered hub with 5/8" open cage roller bearing and zerk fitting. Replaces Snapper 7059065. Fits 32", 36", 48", 54" & 61" cut midsize walk behind mowers. Uses our 09-5812 bearing kit. (painted white)



Order No. 08 - 352

Tube. 4.10 x 3.50 x 4. Replaces Snapper 7010821.

Order No. 08 - 355

Tube. 4.80 x 4.00 x 8. Replaces Snapper 7010525.

Order No. 08 - 358

Tube. 16 x 6.50 x 8. Replaces Snapper 7010525.



Order No. 08 - 13662

22 X 10.00 - 10, 4-ply tubeless, K500 Super Turf tread tire from Kenda. Replaces Snapper 5100006X1. Fits model 5900696, S150X series (48" models only).



Order No. 08 - 10112

Rear wheel assembly replaces Snapper 7058520. 20 x 1000 x 8, 4 ply tubeless turf tread tire, one piece rim. Fits front engine rider. 3/4" Keyway. (Gray)

Order No. 08 - 10111

Rear wheel assembly replaces Snapper 7058519. 18 x 950 x 8, 4 ply tubeless turf tread tire, one piece rim. Fits front engine rider. 3/4" Keyway. (Gray)

Order No. 08 - 10110

Rear wheel assembly replaces Snapper 7058518. 18 x 850 x 8, 4 ply tubeless turf tread tire, one piece rim. Fits front engine rider. 3/4" Keyway. (Gray)

Order No. 08 - 10107

Rear wheel assembly replaces Snapper 7058951. 16 x 650 x 8, 4 ply tubeless turf tread tire, one piece rim. Fits front engine rider. 3 hole bolt pattern. (Gray)

Order No. 08 - 10115

Rear wheel assembly replaces Snapper 7052270. 16 x 650 x 8, 4 ply tubeless turf tread tire, one piece rim. Fits rear engine rider. 3 hole bolt pattern. (Gray)

Order No. 08 - 10114

Rear wheel assembly replaces Snapper 7052671 / 7058951. 16 x 750 x 8, 2 ply tubeless turf tread tire, one piece rim. Fits rear engine rider. 3 hole bolt pattern. (Gray)



ID 3/4"
Height 2-3/4"

Order No. 08 - 7745

Left hand wheel hub replaces Snapper 7040434. Used on Snapper 25"-41" rear engine riders.



ID 1-1/8"
Height 2-3/4"

Order No. 08 - 7744

Right hand wheel hub replaces Snapper 7040433. Used on Snapper 25"-41" rear engine riders.

30

O.E.M.



SNAPPER (Cont.)



ID 5/8" (15.88 mm)
OD 1-3/8" (34.93 mm)
Height 1/2" (11.11 mm)

Order No. 09 - 7950

Front wheel bearing replaces Snapper 7012390. Bearing No. 44F40P.



Order No. 09 - 484

Spindle Bearing. Replaces Snapper 7013313, 7010696. 3/4" ID (19.05 mm), 1-25/32" OD (45.24 mm), 19/32" Height (15.08 mm). Bearing No. 9504-ZZ.

Order No. 09 - 442

Bearing. Replaces Snapper 7012828. .787" ID (19.98 mm), 1-850" OD (46.99 mm), 9/16" Height (14.29 mm). Bearing No. 6204-2RS.

Order No. 09 - 3229

Replaces Snapper 7012304. Hex Shaft Bearing on 21" Self-Propelled Mowers.



ID 3/8" (9.53 mm)
OD 1" (25.40 mm)
Height 5/16" (7.94 mm)

Order No. 09 - 3228

Homeowner / Commercial bearing. Replaces Snapper 7018767, Wheel Arm Assembly Bearing.



ID 9/16" (14.29 mm)
OD 1-3/8" (34.93 mm)
Height 7/16" (11.11 mm)



ID 5/8" (15.88 mm)
OD 1-3/8" (34.93 mm)
Height 7/16" (11.11 mm)

Order No. 09 - 8199

High speed bearing, double sealed replaces Snapper 7010756 (chain case bearing). Bearing No. 99502H-2RSNR.

Order No. 09 - 18199

High speed bearing. (carded)

MIN005

Order No. 09 - 481

499502H Precision High Speed Bearing. Double Sealed. Replaces Snapper 7010756. Bearing No. 99502H-2RS (NR).



ID 5/8" (15.88 mm)
OD 1-3/8" (34.93 mm)
Height 7/16" (11.11 mm)



Order No. 09 - 327

Replaces Snapper 7011807, 3/4" ID (19.05mm) x 1-3/8" (34.93mm) OD.

Order No. 09 - 328

Sealed Bearing. Replaces Snapper 7011807. 3/4" (19.05mm) ID x 1-3/8" (34.93mm) OD.

Order No. 09 - 2703

7/16" (11.11mm) x 1-1/8" (28.58mm) Back to Back Bearing for Snapper Wheels. Snapper 7011125.

Order No. 09 - 8198

Reduction gear bearing. Replaces Snapper 7077324. Bearing No. 99502H-2RS.



ID 5/8" (15.88 mm)
OD 1-3/8" (34.93 mm)
Height 7/16" (11.11 mm)

Order No. 09 - 6573

Bearing replaces Snapper 15474. Fits Driven Disc Assembly 7057444 on self-propelled models.



ID 3/4" (19.05 mm)
OD 1-3/8" (34.93 mm)
Height 1/2" (12.70 mm)



ID 63/64" (25.00 mm)
OD 2-7/16" (61.91 mm)
Height 21/32" (16.67 mm)

Order No. 09 - 3217

Sealed Shaft bearing. Replaces Snapper 7019125 and 7076510. Bearing No. 6305-2RS.

30

O.E.M.



O.E.M. REPLACEMENT SNAPPER (Cont.)



ID 3/4" (19.05 mm)
OD 1-3/4" (44.45 mm)
Height 1-7/16" (36.51 mm)

Order No. 09 - 6536

Rear Axle Bearing. Replaces Snapper 7014624. Used on Snapper Extra Tough Rider. Left hand side (small bearing).



ID 3/4" (19.05 mm)
OD 1-25/32" (45.24 mm)
Height 21/32" (16.67 mm)

Order No. 09 - 813

Replaces Snapper 7012931.



ID 21/32" (17 mm)
OD 1-9/16" (40 mm)
Height 15/32" (12 mm)

Order No. 09 - 7917

Bearing replaces Snapper 7026808. Used in 10-1172 quill assembly. Bearing No. 6203ZZ.



ID 5/8" (15.88 mm)
OD 11/16" (17.46 mm)
Height 5/8" (15.88 mm)
Flange OD 1" (25.40 mm)

Order No. 09 - 2939

Replaces Snapper 7010694 Steering Bushing (bottom) Nylon. MIN010



ID 3/4" (19.05 mm)
OD 13/16" (20.64 mm)
Height 9/16" (14.29 mm)
Flange OD 1-1/4" (31.75 mm)

Order No. 09 - 854

King Pin Bushing. Replaces Snapper 7010986.

MIN010



ID 3/8" (9.53 mm)
OD 1/2" (12.70 mm)
Height 3/8" (9.53 mm)
Flange OD 5/8" (15.88 mm)

Order No. 09 - 853

Tie Rod Bushing. Replaces Snapper 7013321.

MIN010



ID 29/32" (23.02 mm)
OD 31/32" (24.61 mm)
Height 5/8" (15.88 mm)
Flange OD 1-1/4" (31.75 mm)

Order No. 09 - 2940

Replaces Snapper 7012617 Steering Bushing (top) Nylon.

MIN010



ID 7/8" (22.23 mm)
OD 1-1/8" (28.58 mm)
Height 1" (25.40 mm)
Flange OD 1-1/2" (88.10 mm)

Order No. 09 - 5713

Replaces Snapper 7076514. Used on our 10-8189, support arm.



ID 1" (25.40 mm)
OD 1-1/4" (31.75 mm)
Height 1" (25.40 mm)
Flange OD 1-3/4" (44.45 mm)

Order No. 09 - 8240

Caster bushing replaces Snapper 7023556. Fits all mid size hydro and belt driven mowers.



ID 7/8" (22.23 mm)
OD 1-1/8" (28.58 mm)
Height 1-1/4" (31.75 mm)

Order No. 09 - 5703

Replaces Snapper/Kees 7076515.

Order No. 09 - 5812

Open cage roller bearing with flanged bushings. Replaces Snapper 7022394, 7022395. Bearings are 5/8" ID (15.86 mm) x 1-3/8" OD (34.93 mm), 3-1/4" length (82.55 mm). Bushings are 5/8" ID (15.86 mm) x 1-3/8" OD (34.93 mm).

Overall ID 5/8" (15.88 mm)
Overall OD 1-3/8" (34.93 mm)
Overall Length 3-15/16" (100.01 mm)



30

O.E.M.



SNAPPER (Cont.)

ID 1/2" (12.70 mm)
OD 5/8" (15.88 mm)
Height 4-1/16" (103.19 mm)



Order No. 09 - 7262

Wheel Bushing. Replaces Snapper 7022151. Used in our wheel bearing assembly **09-5812**.

ID 7/16"
OD 9/16"
Length 1-5/8"



Order No. 09 - 2907

Replaces Snapper 7012309. Wheel Bushing for our **07-2991, 07-2992, 07-855, 07-8928, 8927, 8929, 8931.** MIN010



ID 3/4"
OD 1"
Length 7/8"

Order No. 10 - 9513

Left hand spacer replaces Snapper 7032114. Fits Snapper extra tough series. For 28", 30", 33" & 41" rear engine riders.



ID 3/4" (19.05 mm)
Top OD 1-3/4" (44.45 mm)
Bottom OD 1-5/8" (41.26 mm)
Top Height 1" (25.40 mm)
Overall Height 1-3/4" (44.45 mm)

Order No. 09 - 6863

Left side Rear Axle Bushing with grease fitting. Replaces Snapper 7050918. For 26" thru 33" rear engine riders.



ID 1-1/8" (28.58 mm)
OD 1-5/8" (41.28 mm)
Height 1-1/2" (38.10 mm)
Flange 1/4" (6.35 mm)

Order No. 09 - 6864

Right side Rear Axle Bushing, replaces Snapper 7012296. For 26" thru 33" rear engine riders.



ID 3/4" (19.05 mm)
OD 1-5/16" (33.34 mm)
Height 17/32" (13.50 mm)

Order No. 09 - 8726

Bearing collar with set screw replaces Snapper 7014625. Fits 25", 26", 28", 30" & 33" cut rear engine riders.



Order No. 10 - 8322

Front end repair kit for Snapper rear engine riders.



ID 3/4"
OD 1-1/8"
Thickness 1/16"

Order No. 10 - 8493

Washer replaces Snapper 7010935. Fits 25", 26", 28", 30" & 33" rear engine riders. Used in our **10-8322** front end repair kit. MIN010



Order No. 09 - 8661

Right hand bearing kit replaces Snapper 7060278. Fits 26" thru 33" cut riding mowers. Kits includes our **09-6864** rear axle bearing, **20-3453** clamp, **10-7919** seal cap & **05-8632** oil seal.



Order No. 10 - 7919

Seal cap replaces Snapper 7031732.



Order No. 10 - 10701

Deck lift cable replaces Snapper 7027427. **4-7/8"** overall length, Fits 25" - 41" decks. For 8, 9, 10, & 11 series engine riders. Heavy duty "T" slug.



Order No. 10 - 10702

Deck lift cable replaces Snapper 7027429. **6-1/2"** overall length, Fits 25" - 33" decks. For 14, 15, 16 & 18 series engine riders. Heavy duty "T" slug.

30

O.E.M.



**O.E.M. REPLACEMENT
SNAPPER (Cont.)**



Order No. 10 - 10703

Deck lift cable replaces Snapper 7016844.5-5/8" overall length, Fits 33" - 42" decks model LT120-160. For 1 & 2 series lawn tractors. Heavy duty eyelet.



Order No. 10 - 10704

Deck lift cable replaces Snapper 7023180.6-1/2" overall length, Fits 33" - 42" decks model LT120-160. For 0, 1 & 2 series lawn tractors. Heavy duty eyelet. Threaded.



Order No. 10 - 9911

Electric PTO clutch replaces Snapper 7653740, 7053740. 1" ID x 3" Height, 5.375 pulley, 5/8" belt.



Order No. 10 - 12227

Electric PTO clutch replaces Snapper 7016343. 1" ID x 5.345" Pulley, 5/8" belt. Warner 5215-59.



Order No. 10 - 11828

Electric PTO clutch replaces Snapper 7014022. 1" ID x 5.395" pulley, 1/2" belt. Warner 5215-129.



Order No. 10 - 11857

Electric PTO clutch replaces Snapper 7029678. 1" ID x 6" pulley, A/B belt. Warner 5215-13.



Order No. 10 - 11858

Electric PTO clutch replaces Snapper 7017063. 1" ID x 6" pulley, A/B Belt type. Warner 5215-14.



Order No. 10 - 11070

Electric PTO clutch replaces Snapper 7079197 & 7079446. Warner 5215-88.



Order No. 10 - 2208

Ball Joint Assembly. 1/4"-28. Right hand threads. Replaces Snapper 7015753.



Order No. 10 - 14495

Electric clutch replaces Snapper 35520, 58925, 7058925YP. Warner 5218-58, 5218-26. 1-1/8" ID, 3-1/2" height, 1/2" belt, 4-7/8" pulley.



Order No. 10 - 2210

Ball Joint Assembly. Replaces Snapper 1700745. 3/8" - 24. (Right hand threads)



Order No. 10 - 7747

Yoke lift replaces Snapper 7047843. Used on all Snapper rear engine riders.

30

O.E.M.



SNAPPER (Cont.)

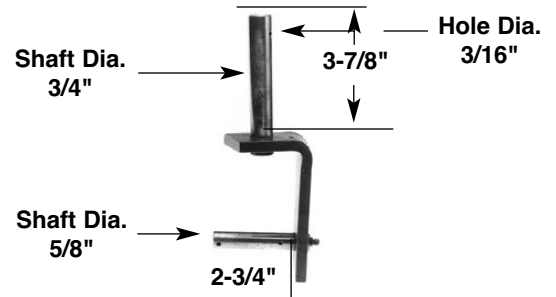

Order No. 10 - 2243

6" Caster Yoke. Replaces Snapper 7076400. Used with our support arm 10-2218.



Order No. 10 - 6891

7/8" Foam Grips.

Order No. 10 - 6892

1" Foam Grips.

Used on Snapper, midsize mowers. Sold and priced in pairs.



Order No. 10 - 7154

Spindle Shaft replaces Snapper 7044785, 21742. Fits 25", 26", 28", 30" and 33" deck rear engine riders.



ID 5/8"
OD 1"
Height 1/2"

Order No. 10 - 7249

1/2" Blade spacer used on Snapper.



Order No. 10 - 2224

Bell Crank Spring. Replaces Snapper 7076439 & 363039.



Order No. 10 - 6973

Clutch/Brake Spring replaces Snapper 7013885. Used on rear engine riders.



Order No. 10 - 3223

Wheel Drive Spring. Replaces Snapper 7029025, 7017326.



Order No. 10 - 3306

Clutch Spring. Replaces Snapper 7012122.



Order No. 10 - 10357

5/16" - 18 Female thread clamping knob. Replaces Snapper 7023735.

Order No. 10 - 14226

Spindle assembly replaces Snapper 1735326. Includes housing 1735573, bearings (2) 1735399, Spacers (2) 1735328, Shaft 1735326, Shield (2)1735323, Locking Ring (2) 1967066.



30

O.E.M.

**O.E.M. REPLACEMENT
SNAPPER (Cont.)**



Order No.	Description
10 - 1226	5-1/8" Spindle Assembly. Replaces Snapper 70362024, (new #) 59759, (old #)76379. For 32" and 36" decks. (short shaft).
10 - 1227	6-1/8" Spindle Assembly. Replaces Snapper 7059964/76645. For 48" deck. (long shaft).
10 - 1191	Blade Spacer. 1/4" Thick, 5/8" Bore. Replaces Snapper 7076436.



Order No. 10 - 7886
Hub bolt replaces Snapper 7011013. For right hand side, used with our **08-7744** wheel hub. Fits 25" thru 33" Snapper rear engine riders.
MIN010



Order No. 10 - 7885
Hub bolt replaces Snapper 7011035. For left hand side, used with our **08-7745** wheel hub. Fits 25" thru 33" Snapper rear engine riders.
MIN010



Order No. 10 - 8448
Hub bolt lock nut replaces Snapper 7011201. Lock nut for our hub bolts **10-7885** & **10-7886**. 5/16" (7.94mm) - 24 lock nut.
MIN010



Order No. 10 - 2225
5/16" x 1-5/8" Length. Quick Pin. Replaces Snapper 7076967 & 903798.



Order No. 10 - 2909
Replaces Snapper 7011815. Clutch Pedal Pad.



Order No. 10 - 2908
Replaces Snapper 7011747. Brake Pedal Pad.



Order No. 10 - 8302
Wheel height adjuster replaces Snapper 7051815. Uses our **09-3228** bearing. Fits Rear (Left Hand)



Order No. 10 - 8303
Wheel height adjuster replaces Snapper 7051814. Uses our **09-3228** bearing. Fits Rear (Right Hand)



Order No. 10 - 9510
Height adjuster replaces Snapper 7051885. Fits 21" walk-behind mowers. Left hand. Square



Order No. 10 - 9511
Height adjuster replaces Snapper 7051886. Fits 21" walk-behind mowers. Right hand. Round

30

O.E.M.



SNAPPER (Cont.)

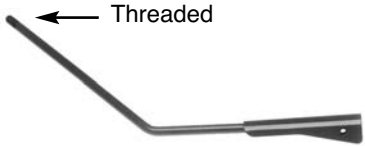

Order No. 10 - 8301

Shift handle replaces Snapper 7040284. Fits on rear engine riders.



Order No. 10 - 2219

Traction Control Lever. Snapper 7076405 & 362109.



Order No. 10 - 13665

Damper replaces Snapper 1727918, 1727918SM, shock absorber damper. Fits 150 Z & Craftsman ZTS 7500.



Order No. 10 - 2910

Clevis Pin for Traction Control Lever. Used with our **10-2219**. Comes complete with cotter pin. MIN010



Order No. 10 - 3307

Rear bumper. Replaces Snapper 7030798. Made 2" longer. Sold in pairs.



Order No. 11 - 8472

Chaincase chain replaces Snapper 7010941. Fits all 25", 26", 28", 30" & 33" rear engine riders. #35 chain, 23 drive links.

30

O.E.M.



Order No.	Description
12 - 669	Replaces Snapper 7012508 and 7011887. Used on V-21's. 24-1/2" long (622.30 mm), 3/8" wide (9.53 mm). For 3-1/2 - 4 hp mowers.
12 - 670	Replaces Snapper 7012353. Fits 5 hp commercial, cogged.
12 - 673	Replaces AA68 Snapper 7010749. For 25", 26", 28" and 30" cut mowers 1991 & older 68" long (1727.20 mm), 6 sided. Oil and heat resistant
12 - 675	Replaces AA73 Snapper 7022252, 7018236. For 25", 26", 28", 30" & 33" cut decks 1991 & newer. 73" long (1854.20 mm), 6 sided. Oil and heat resistant.
12 - 870	Replaces Snapper 7014525 (For 48" Deck 1992 & older). AA-105.
12 - 869	Transmission Belt. Replaces Snapper 7012354. 22-3/8" long (31.52 mm). Poly grooved belt.
12 - 7129	Blade Belt. Replaces Snapper 7014799. 103-3/32" length (2618.58 mm). Fits series 1 & 2, models LT11, LT16, YT12D, YT18H, GT180H.
12 - 8768	Blade Belt. Replaces Snapper 7028784. 5/8" (15.86 mm) x 110.28" (2801.11 mm). Fits 42" rear engine riders. V-belt, *Aramid fiber.
12 - 9483	Blade Drive Belt. Replaces Snapper 7043844. "AA" x 73-3/4" (1390.65 mm). Fits 28", 30" & 33" cut rear engine riders, series 16. General purpose, *Aramid fiber. Clutching cover



**O.E.M. REPLACEMENT
SNAPPER (Cont.)**



Order No.	Description
12 - 14166	Deck Belt. Replaces Snapper 7103789 . 1/2" (12.7 mm) x 158.0" (4013.2 mm). Fits Snapper model RZT 52". Wrapped-molded, aramid cord construction, double cover, clutching, brown color.
12 - 8075	Deck Belt. Replaces Snapper 7014800. 1/2" section belt (12.70 mm), 139" length (3530.60 mm). Fits series 1 & 2, models LT, YT, YT12D, YT16D, YT18H, GT180H.
12 - 11677	Drive Belt. Replaces Snapper 7046784. 3/8" Hex (9.5 mm) x 24-1/2" (622.3 mm). General Purpose, Aramid cord construction, double cover, clutching.
12 - 7838	Engine to Blade Belt. Replaces Snapper 7022252. AA section belt, 73" length (1854.20 mm), fits 26" thru 33" cut models 7-9 series, Snapper rear engine riders. *Aramid fiber
12 - 5233	Wheel Drive Belt. Replaces Snapper 7076497, cogged.
12 - 8767	Spindle Belt. Replaces Snapper 7044637, 7028619. 5/8" (15.86 mm) x 75.18" (1909.57 mm). Fits 28", 30" & 33" rear engine riders. V-belt, *Aramid fiber.

*Made with KEVLAR® or non-trade marked Aramid fiber



ID 1"
OD 2-1/8"
Height 7/8"
Keyway 5/32"

Order No. 13 - 9787

Crankshaft pulley replaces Snapper 7021759. Fits 21" self-propelled mowers.



ID 25mm
OD 2-1/8"
Height 7/8"
Keyway 1/4"

Order No. 13 - 9806

25 mm crankshaft pulley replaces Snapper 7022106. Fits 21" self-propelled mowers.



ID 7/8"
OD 1-7/8"
Height 7/8"
Keyway 5/32"

Order No. 13 - 8547

Crankshaft pulley replaces Snapper 7021707. Fits self propelled walkbehind mowers.



ID 1"
OD 2-1/4"
Height 7/8"
Keyway 5/32"

Order No. 13 - 5949

1" Crankshaft Pulley. Replaces Snapper 7022043. Used on B&S equipped Snapper walkbehind mowers for greater ground speed.



ID 7/8"
OD 2-1/4"
Height 7/8"
Keyway 5/32"

Order No. 13 - 5950

7/8" Crankshaft Pulley. Replaces Snapper 7022044. Used on Wisconsin equipped Snapper walk behind mowers for greater ground speed.



ID 7/8"
OD 2-1/8"
Height 7/8"
Keyway 5/32"

Order No. 13 - 8193

Engine pulley for Snapper with Honda engines. Replaces Snapper 7021764.

30

O.E.M.



SNAPPER (Cont.)



Order No. 13 - 438

Engine Pulley. Replaces Snapper 7010987. 5" OD.



ID 3/8"
OD 2"
Height 1-1/4"

Order No. 13 - 9508

Drive pulley replaces Snapper 7024521, 7012140. Fits 21" self-propelled Snapper walkbehind mowers. Die cast aluminum material.



Order No. 13 - 436

Steel Pulley. Replaces Snapper 7018781. 6-7/8" Dia. Hub Length 1", C.H. 3/4".

Order No. 13 - 776

Deck spindle pulley. Replaces Snapper 7014397. 5-3/4" OD x 3/4" ID.



Order No. 13 - 2186

Jackshaft Pulley. Replaces Snapper 7057582/7077285. 5/8" ID, 3-1/2" OD, 3/16" Keyway.



ID 1"
OD 5-3/4"
Height 1-5/8"
Keyway 1/4"

Order No. 13 - 2185

Spindle Pulley. Replaces Snapper 7076398.



ID 3/8"
OD 4-1/8"
Height 1-11/16"

Order No. 13 - 8245

Flat Idler pulley replaces Snapper 7024725. Tension Idler for 12 and 14 hp front engine riders with 38" decks.



ID 3/8"
OD 4-1/8"
Height 27/32"

Order No. 13 - 9856

Idler pulley replaces Snapper 7018574.



ID 1/4"
OD 2-1/4"
Thickness 27/32"

Order No. 13 - 8478

Idler pulley replaces Snapper 7012124. Fits self propelled 21" commercial series mowers.



Order No.

Description

- 13 - 718** Flat Idler. Replaces Snapper 7010948.
- 13 - 734** V-Idler. Replaces Snapper 7011029.
- 13 - 777** Idler Pulley. Replaces Snapper 7023966, 7018585.
- 13 - 2188** Flat Idler. Replaces Snapper/Kees 7076520.
- 13 - 5870** Deck Idler. Replaces Snapper 7018651.
- 13 - 2189** Flat Idler. Replaces Snapper 7057582.
- 13 - 5714** Blade Deck Idler. Replaces Snapper/Kees 7076500, 7076688.

For More Information See Section 13.















30

O.E.M.

O.E.M. REPLACEMENT
SNAPPER (Cont.)













O.E.M.
30

ORDER NO.	REPLACES O.E.M. NO.	LENGTH	CENTER HOLE DIAM.	OUTSIDE HOLE DIAM.	CENTER TO CENTER	WIDTH	STEEL THICK.	APPLICATION
 15 - 7010	539-1032-74	14-7/8" 377.8mm	5/8" 15.8mm			2-1/2" 63.5mm	.204" 6.2mm	(3) blades for 42" cut. Fits Husqvarna, Yazoo/Kees commercial mowers.
 15 - 13481	1737228BZ	16-3/32" 408.8mm	.805" 20.4mm			2-1/2" 63.5mm	.204" 5.18mm	(3) blades for a 46" cut. Fits 46" Zero Turn mowers. Simplicity, Massey Ferg.
 15 - 1009	7017036 7076675	16-1/4" 412.8mm	5/8" 15.9mm	1/4" 6.4mm	1-5/8" 41.3mm	2-1/2" 63.5mm	.150" 3.8mm	(2) blades for 32" cut (3) blades for 48" cut
 15 - 6500	539-100-340	16-1/4" 412.8mm	5/8" 15.8mm			2-1/2" 63.5mm	.204" 5.2mm	(3) blades for 48" cut. Fits Husqvarna, Yazoo, Kees, commercial mowers.
 15 - 2172	7017036 7077378	16-1/4" 412.8mm	5/8" 15.9mm	11/32" 8.7mm	1-5/8" 41.3mm	2-1/2" 63.5mm	.240" 6.1mm	(Heavy Duty) (2) blades for 32" cut (3) blades for 48" cut
 15 - 10172	7077378	16-1/4" 412.8mm	5/8" 15.8mm			2-1/2" 63.5mm	.204" 5.2mm	Flat Blade Sharpened - 4-sides
 15 - 6296	483011 7076675 7077378	16-1/4" 412.8mm	5/8" 15.9mm			2-1/2" 63.5mm	.204" 5.2mm	Mulching Blade PATENTED
 15 - 9967	7077378	16-1/4" 412.8mm	5/8" 15.8mm			2" 50.8mm	.240" 6.1mm	Low-Lift Blade Sharpened - 4-sides
 15 - 6472	7029247	16-1/2" 419.1mm	5/8" 16mm			2-1/2" 63.5mm	.204" 5.2mm	Fits Yardcruiser model HZS 1848 2BVE homeowner model.
 15 - 6300	7017043	16-1/2" 419.7mm	5/8" 15.9mm			2-1/2" 63.5mm	.204" 5.2mm	Mulching Blade PATENTED
 15 - 2169	7019733	16-1/2" 419.1mm	3/8" 9.5mm			2-3/4" 69.9mm	.160" 4.1mm	(3) blades on LT48 Steel Deck
 15 - 6185	7079369	16-13/16" 427mm	1/2" 12.7mm			2-1/2" 63.5mm	.204" 5.2mm	(3) blades for 48" cut



SNAPPER (Cont.)













ORDER NO.	REPLACES O.E.M. NO.	LENGTH	CENTER HOLE DIAM.	OUTSIDE HOLE DIAM.	CENTER TO CENTER	WIDTH	STEEL THICK.	APPLICATION
 15 - 6035	7079388	17" 431.8mm	1/2" 12.7mm			2-1/2" 63.5mm	.204" 5.2mm	48" deck For Snapper "ZERO TURN" machine Hi Lift Blade
 15 - 6426	7079388	17" 431.8mm	1/2" 12.7mm			2-1/2" 63.5mm	.204" 5.2mm	Mulching Blade PATENTED
 15 - 9968	7077344	18" 457.2mm	5/8" 15.8mm			2" 50.8mm	.240" 6.1mm	Low-Lift Blade Sharpened - 4-sides
 15 - 6294	7077344 7076450 363055 482462 7017037 7029246	18" 457.2mm	5/8" 15.9mm			2-1/2" 63.5mm	.204" 5.2mm	Mulching Blade PATENTED
 15 - 6014	7029246	18" 457.2mm	5/8" 15.9mm			2-1/2" 63.5mm	.204" 5.2mm	Fits Snapper Pro Series. (2) blades for 36" cut (3) blades for 52" cut
 15 - 1010	7017037 363055	18" 457.2mm	5/8" 15.9mm	1/4" 6.4mm	1-5/8" 41.3mm	2-1/2" 63.5mm	.150" 3.8mm	(2) blades for 36" cut
 15 - 2173	7017037 7077344	18" 457.2mm	5/8" 15.9mm			2-1/2" 63.5mm	.240" 6.1mm	(Heavy Duty) (2) blades for 36" cut (3) blades for 54" cut.
 15 - 10173	7077344	18" 457.2mm	5/8" 15.8mm			2-1/2" 63.5mm	.204" 5.2mm	Flat Blade Sharpened - 4-sides
 15 - 13482	1737252BZ	18-1/2" 469.9mm	.805" 20.4mm			2-1/2" 63.5mm	.204" 5.18mm	(3) blades for a 52" cut Fits 52" Zero Turn mowers. Simplicity, Massey Ferg.
 15 - 6197	7024466 7042998	19-41/64" 498.9mm	1" 25.4mm			2-1/4" 57.2mm	.204" 5.2mm	(2) blades for 38" cut front engine rider models LT1438H & Black Hawk model BH120G38A
 15 - 2007	7019795	20-11/16" 525.5mm	3/8" 9.5mm	3/8" 9.5mm	2-3/4" 69.9mm	2-3/4" 69.9mm	.160" 4.1mm	Uses 15-910 Air lifts Steel Deck

30
O.E.M.

O.E.M. REPLACEMENT SNAPPER (Cont.)















O.E.M. 30

ORDER NO.	REPLACES O.E.M. NO.	LENGTH	CENTER HOLE DIAM.	OUTSIDE HOLE DIAM.	CENTER TO CENTER	WIDTH	STEEL THICK.	APPLICATION
 15 - 6110	7017168 7041939	20-11/16" 525.5mm	3/8" 9.5mm	3/8" 9.5mm		2-3/4" 69.9mm	.160" 4.1mm	Mulcher blade for 21" Steel Decks
 15 - 6317	7019645 7019795 7017168	20-11/16" 525.5mm	3/8" 9.5mm			2-3/4" 69.9mm	.160" 4.1mm	Mulching Blade PATENTED
 15 - 2006	7017002 7019702 7019645 7026691	20-3/4" 527.1mm	3/8" 9.5mm	3/8" 9.5mm	2-3/4" 69.9mm	2-3/4" 69.9mm	.160" 4.1mm	Used on 21" & 41" Steel Deck
 15 - 1087	7018193	20-7/8" 530.2mm	7/8" 22.2mm			2-3/4" 69.9mm	.187" 4.8mm	V-series
 15 - 6167	7079222	21" 533.4mm	1/2" 12.7mm			2-1/2" 63.5mm	.240" 6.1mm	(Heavy Duty) (3) Blades for 61" cut Regular lift
 15 - 6168	7079222	21" 533.4mm	1/2" 12.7mm			2-1/2" 63.5mm	.240" 6.1mm	(Heavy Duty) (3) Blades for 61" cut High lift
 15 - 9969	101733	21" 533.4mm	5/8" 15.8mm			2" 50.8mm	.240" 6.1mm	Low-Lift Blade Sharpened - 4-sides
 15 - 10174	101733	21" 533.4mm	5/8" 15.8mm			2-1/2" 63.5mm	.204" 5.2mm	Flat Blade Sharpened - 4-sides
 15 - 6277	7026428	21" 533.4mm	13/16" 20.6mm	3/8" 9.5mm	2-1/2" 63.5mm	2-1/4" 57.2mm	.134" 3.4mm	New 21" blade for Snapper walkbehinds. For Platinum series mowers.
 15 - 12852	1731898	21-3/16" 538.1mm	.975" 24.7mm			2-1/4" 57.2mm	.170" 4.3mm	Fits LT-200 series & Zero Turn 150Z series 42" cut.
 15 - 11868	7100851A 1101823	21-5/8" 549.3mm	13/32" 10.3mm	13/32" 10.3mm	1-7/8" 47.6mm	2-1/4" 57.2mm	.135" 3.5mm	3 in 1 blade
 15 - 1103	7019518	25" 635mm	1-1/16" 27mm	35/64" 13.9mm	7-1/2" 190.5mm	2-3/4" 69.9mm	.187" 4.8mm	New Style Uses the 3 bolt hole High air lift 15-1136



SNAPPER (Cont.)

ORDER NO.	REPLACES O.E.M. NO.	LENGTH	CENTER HOLE DIAM.	OUTSIDE HOLE DIAM.	CENTER TO CENTER	WIDTH	STEEL THICK.	APPLICATION
 15 - 1091	7018068	26" 660.4mm	1-1/16" 27mm	35/64" 13.9mm	7-1/2" 190.5mm	2-3/4" 69.9mm	.187" 4.8mm	New Style Uses the 2 bolt hole Regular air lifts 15-1131
 15 - 6108	7016980	28" 711.2mm	1-1/16" 27mm	35/64" 13.9mm	7-1/2" 190.5mm	2-3/4" 69.9mm	.160" 4.1mm	Mulching blade For 28" rear engine riders
 15 - 1098	7019515	28" 711.2mm	1-1/16" 27mm	35/64" 13.9mm	7-1/2" 190.5mm	2-3/4" 69.9mm	.187" 4.8mm	New Style Uses the 3 bolt hole High air lifts 15-1136
 15 - 6302	7019515	28" 711.2mm	1-1/16" 27mm	35/64" 13.9mm	7-1/2" 190.5mm	2-3/4" 69.9mm	.187" 4.8mm	Mulching Blade PATENTED
 15 - 11238	7019515	28" 711.2mm	1-1/16" 27mm			2-3/4" 69.9mm	.187" 4.8mm	Blade without air lift holes.
 15 - 1092	7018069	30" 762mm	1-1/16" 27mm	35/64" 13.9mm	7-1/2" 190.5mm	2-3/4" 69.9mm	.187" 4.8mm	New Style Uses the 2 bolt hole Regular air lifts 15-1131
 15 - 6029	7018069	30" 762mm	1-1/16" 27mm	35/64" 13.9mm	7-1/2" 190.5mm	2-3/4" 69.9mm	.187" 4.8mm	No air lift holes New Style
 15 - 6297	7018069	30" 762mm	1-1/16" 27mm	35/64" 13.9mm	7-1/2" 190.5mm	2-3/4" 69.9mm	.187" 4.8mm	Mulching Blade PATENTED
 15 - 1089	7060332 7018038	30" 762mm	7/8" 22.2mm	35/64" 13.9mm	7-1/2" 190.5mm	2-3/4" 69.9mm	.187" 4.8mm	Old Style Will fit Dixon 30" rider (without bagger). Also uses 15-1131 Air Lifts
 15 - 11239	7019523	33" 838.2mm	1-1/16" 27mm			2-3/4" 69.9mm	.187" 4.8mm	Blade without air lift holes.
 15 - 6109	7016982	33" 838.2mm	1-1/16" 27mm	35/64" 13.9mm	7-1/2" 190.5mm	2-3/4" 69.9mm	.160" 4.1mm	Mulching blade For 33" rear engine riders
 15 - 1060	7019523	33" 838.2mm	1-1/16" 27mm	35/64" 13.9mm	7-1/2" 190.5mm	2-3/4" 69.9mm	.187" 4.8mm	New Style Uses the 3 bolt hole. High Air Lifts 15-1136

30 O.E.M.



O.E.M. REPLACEMENT SNAPPER (Cont.)

ORDER NO.	REPLACES O.E.M. NO.	LENGTH	CENTER HOLE DIAM.	OUTSIDE HOLE DIAM.	CENTER TO CENTER	WIDTH	STEEL THICK.	APPLICATION
15 - 6301	7019523	33" 838.2mm	1-1/16" 27mm	35/64" 13.9mm	7-1/2" 190.5mm	2-3/4" 69.9mm	.187" 4.8mm	Mulching Blade PATENTED

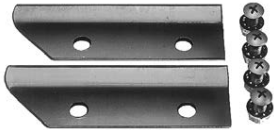

Order No. 15 - 1131

Complete Air Lift Kit for Snapper. Used on our 15-1088, 15-1089, 15-1091, 15-1092 & 15-1097.

Order No. 15 - 1132

Air Lift Only. Replaces Snapper 31724.

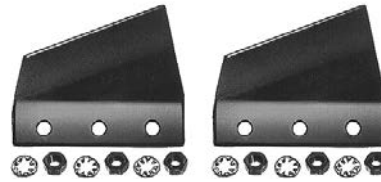

Order No. 15 - 1136

Air Lift. Replaces Snapper 60480. Used on our 15-1060, 15-1098 and 15-1103.



Order No. 15 - 909

Hardware only. Screw, Lock Washer and Nut for all our Snapper air lifts. Replaces Snapper 90228, 90391 and 90223. Packaged 25 sets per bag.



Order No. 15 - 909

Air Lift Kit. Replaces Snapper 7060785. Used with our 15-2007 Blade. Fits 21" walkbehind.

Drive Kits for Snapper

INCLUDES BLADE, DISC & BELT



Order No. **Size**

- 15 - 3529** 25" Kit
- 15 - 3527** 26" Kit
- 15 - 3528** 28" Kit
- 15 - 3526** 30" Kit
- 15 - 3524** 33" Kit

For units made before 1991

Order No. **Size**

- 15 - 9941** 25" Kit
- 15 - 9942** 26" Kit
- 15 - 9943** 28" Kit
- 15 - 9938** 30" Kit

For units made after 1991

Order No. 17 - 1160

Replaces Snapper 12927. Clutch assembly includes blade bolt, key and washer. Fits 7/8" shaft. Has 5/32" keyway. Weight 14 oz.

Order No. 17 - 1178

Hub only.

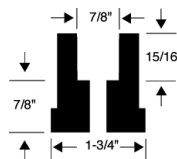

Length 12-1/2"



Order No. 17 - 5847

Blade Holder Bar with adjustment bolt holes. Replaces Snapper 37751.



Size 1/2" - 20

Order No. 17 - 8454

Blade bar nut replaces Snapper 90559. Fits our blade bar 17-5847. MIN10



SNAPPER (Cont.)



Size 1/2" - 20 x 1-1/4"

Order No. 17 - 12268

Blade bar bolt replaces Snapper 7090491. Used with our 17-5847 blade bar.
MIN010



Size 1/2" - 20 - 1"

Order No. 17 - 8453

Blade bar bolt replaces Snapper 90392. Fits our blade bar 17-5847.
MIN010



ID 1/2"
Internal Slotted

Order No. 17 - 8455

Blade bar washer replaces Snapper 90509. Fits our blade bar 17-5847.
MIN010



Order No. 18 - 7239

Muffler replaces Snapper 51996. Fits 12 & 12-1/2 hp Briggs on Snapper Riders.



Order No. 18 - 13625

Muffler replaces Snapper 7074453. Used on OHV single cylinder Briggs & Stratton engines on rear engine riders.



Order No. 18 - 2289

Pipe for 11 hp. Replaces Snapper 18214.



Order No. 18 - 2290

Complete Muffler Kit for Snapper 8 hp Rider. Replaces 60316.



Order No. 18 - 2288

Pipe for 8 hp. Replaces Snapper 18197.

Order No. 18 - 2300

Hardware only for Snapper 60316 (Our 18-2290).

Order No. 18 - 2281

Muffler. Replaces Snapper 18198. For 8 hp Briggs & Stratton and Tecumseh Engines.



Order No. 20 - 2235

Replaces Snapper 19378/12515. Vented gas cap.



Order No. 20 - 8000

Fuel cap replaces Snapper 12515, 19378. Fits 7 - 12-1/2 hp vert. engines



Order No. 20 - 8935

Fuel cap replaces Snapper 14363.

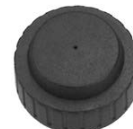

Order No. 20 - 2232

Gas Cap. Replaces Snapper 12155. ID 1-11/16", OD 1-7/8".

30

O.E.M.



**O.E.M. REPLACEMENT
SNAPPER (Cont.)**



Diameter 3-1/2"

Order No. 20 - 9650

Vented fuel cap replaces Snapper 28903



Order No. 20 - 1357

In-Line Fuel Filter. 1/4" nipple. Replaces Snapper 14359/11777. 85 Microns MIN010



ID 3/8"
Top OD 17/32"
Height 5/8"
Bottom OD 1-1/16"

Order No. 20 - 7730

Fuel tank bushing replaces Snapper 12337. MIN010



Low-Back
Seat

Order No. 21 - 6622

Low Back Seat Cover. Fits seat size: 6" high, 14-1/2" deep, 16-3/4" wide.



Medium Back
Seat

Order No. 21 - 2227

Seat. Replaces Snapper 19978. Larger and more comfortable than our 21-2229.

Order No. 21 - 6623

Medium Back Seat Cover. For our 21-2227 seat.

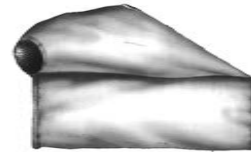

Order No. 28 - 1999

Replaces Snapper 23774, 12321. 8" longer than standard bag.

Order No. 28 - 1995

Rear bagger. Replaces Snapper 22319, 12320.



Order No. 28 - 1998

Snapper Rear bag for riders. Replaces 19251/18177.



Order No. 28 - 1997

Closure Kit. Replaces Snapper 50711.



Order No. 29 - 482

Oil Seal. Replaces Snapper No. 13681. MIN010

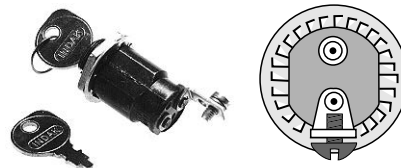

Order No. 31 - 1930

On-Off Switch for Manual Star Riders. Single Pole. Replaces Snapper 11853.

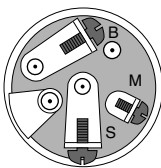

Order No. 31 - 6545

Replaces Snapper No. 11155. For Snapper rear engine riders.



Order No. 31 - 7179

Ignition Switch replaces Snapper 18816.

30

O.E.M.



O.E.M. REPLACEMENT

SNAPPER (Cont.)



Order No. 31 - 1939

Replaces Snapper 12623, starter switch.

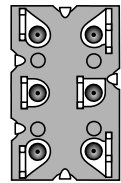

Order No. 31 - 7922

PTO switch replaces Snapper 7029175. Fits 936 series YT tractor models 936002, 936003, 936004, 936005, 936006, 936008, 936009, 936010, 936011 & 936012. Includes mounting hardware.

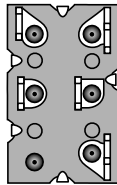

Order No. 31 - 7675

Replaces Snapper 19545, PTO switch. Mounting hardware included.

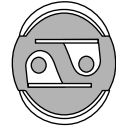

Order No. 31 - 9622

Multi-application Ignition switch. Fits single stage Snapper snowthrowers. Includes key, lockwasher nut & cover. 2 terminals/ 2 positions.

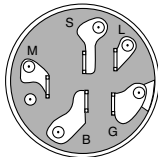

Order No. 31 - 2922

Ignition Switch replaces Snapper 27698. (Magneto)

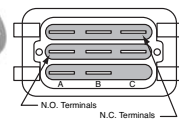

Order No. 31 - 9656

PTO switch replaces Snapper 35658. Push-pull/Snap in mount. Corner terminal blank. Red Knob

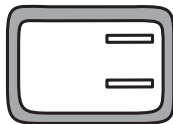

Order No. 31 - 9658

Plunger Interlock switch replaces Snapper 27225. Single pole, normally closed.

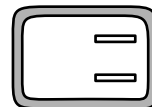

Order No. 31 - 9660

Plunger interlock switch replaces Snapper 14847. Single pole, snap in mount. Normally open.

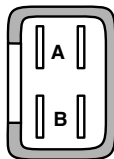

Order No. 31 - 9665

Plunger Interlock switch replaces Snapper 22886. Double pole, snap in mount. Normally open/normally closed.

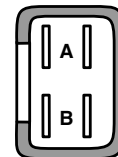

Order No. 31 - 9659

Plunger Interlock switch replaces Snapper 23355. Double pole, normally open / normally closed.



Order No. 31 - 9663

Plunger Interlock switch replaces Snapper 15707. Single post, right angle snap in mounted. Normally open.



Order No. 31 - 12839

Ignition switch replaces Snapper 7072684YP. Plastic snap bezel. 3 position 5 terminals.

30

O.E.M.

**O.E.M. REPLACEMENT
SNAPPER (Cont.)**



Order No. 31 - 9666

Twist lock seat switch replaces Snapper 292112. Single pole, twist lock mount. Normally closed.



Order No. 31 - 3319

Replaces Snapper 18817.



Order No. 31 - 5933

Universal solenoid replaces Snapper 18604.



Order No. 31 - 10771

Universal starter solenoid 3 pole, 12 volt. Terminal post will accommodate both 5/16" & 1/4" terminal connectors, Mounting bracket will accommodate both chassis and wall mount configurations. Replaces Snapper 18817.



Order No. 31 - 10772

Universal starter solenoid 4 pole, 12 volt. Terminal post will accommodate both 5/16" & 1/4" terminal connectors, Mounting bracket will accommodate both chassis and wall mount configurations. Replaces Snapper 18604.



Order No. 41 - 5514

Scraper Bar replaces Snapper 28427, 18764. Fits model 3201. 19-1/4" length x 2" width x 1/4" mounting holes.



Order No. 41 - 5528

Scraper Bar replaces Snapper 28425, 24619, 28425. Fits model LE317. 16-3/8" length x 2" width x 1/4" mounting holes.



Order No. 41 - 5529

Scraper Bar replaces Snapper 35948, 28426, 24365. Fits model LE319. 18-1/2" length x 2" width x 1/4" mounting holes.



Order No. 41 - 8635

Universal snowblower shoe fits Snapper



Order No. 41 - 5585

Universal snowblower skid shoes set. Fits most Snapper. 2 stage snowthrowers. Eccentric washers allow mounting to a variety of mounting dimensions. Mounting width (min 2", max 3", 5/16" bolt holes. Similar to our 41-8635.



Order No. 41 - 13170

Snowblower paddle set replaces Snapper 7061215, 70761215. Fits 17" model LE-17 snowthrowers.

30

O.E.M.



O.E.M. REPLACEMENT

STIGA



Order No. 05 - 50215

Steering cable replaces Stiga 1134-9022-01. Fits Stiga Park 2002. Fittingmarked centerpoint. Length 115" (2921 mm).

Order No. 05 - 50216

Steering cable replaces Stiga 1134-9023-01. Fits Stiga Villa 808E. Fittingmarked centerpoint. Length 134-1/2" (3416.3 mm).

Conduit 48-1/4" 1226MM
Length Extension 8-27/32" 225MM

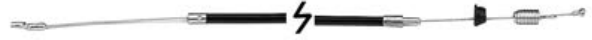

Order No. 03 - 10219

Drive control cable replaces Stiga NV 329-496-185-00. Fits Stiga NV walkbehind mowers.

Conduit 52-1/4" 1326MM
Length Extension 11" 280MM



Order No. 03 - 10220

Drive control cable replaces Stiga NV 329-496-187-00. Fits Stiga NV walkbehind mowers.

Top ID 11/16" (16.50 mm)
Bottom ID 2-9/16" (65.15 mm)
Top OD 2-1/2" (63.50 mm)
Bottom OD 2-3/4" (69.85 mm)
Length 4-1/2" (114.3 mm)



Order No. 07 - 50221

Guard roller. Fits Stiga Park and Stiga Villa.

ID 5/8" (15.87 mm)
OD 3-7/8" (98.43 mm)
Height 2" (50.80 mm)



Order No. 07 - 50222

Deck wheel. Fits Stiga Park and Stiga Villa.

ID 3/4" (19.05mm)
OD 1" (25.4mm)
Height 1" (25.4mm)



Order No. 09 - 9109

Front wheel bushing replaces Stiga 1134-1875-01. Bronze.

Coil Dia. 41/64" (16.27 mm)
Length Overall 3-9/64" (79.77 mm)
Length of Coil 1-51/64" (45.64 mm)
Thickness 1/8" (3.18 mm)



Order No. 10 - 50212

Braking spring replaces Stiga 1134-1242-02.

Coil Dia. 3/4" (19.05 mm)
Length Overall 9" (228.60 mm)
Length of Coil 3-61/64" (100.41 mm)
Thickness 7/64" (2.78 mm)



Order No. 10 - 50213

Spring with loop replaces Stiga 1134-1322-01.



Order No. 10 - 9541

Shaft spacer replaces Stiga 1134-0051-05. 2" (50mm) length, 11/16" (17mm) OD.



Order No. 10 - 9721

Center shaft replaces Stiga 1134-3767-02. 7-1/4" (180mm) length, 11/16" (17mm) OD.

30

O.E.M.



O.E.M. REPLACEMENT

STIGA (Cont.)



Order No. 10 - 9696

Outer shaft replaces Stiga 1134-3767-01. Used with our 10-9722 outer spindle housing. 6-3/8" (162mm) length, 11/16" (17mm) OD.



Order No. 10 - 9722

Outer spindle housing replaces Stiga 1134-3841-02. Uses our 10-9696 outer shaft.



ID 21/32"
OD 4-1/2"
Height 1"

Order No. 13 - 10152

Idler pulley replaces Stiga 1134-3053-01. Composite idler pulley with precision bearing with no insert.



Insert ID 13/32"
OD 3-1/2"
Height 1-1/2"

Order No. 13 - 50261

Idler pulley replaces Stiga 1134-3043-01. Composite idler pulley with precision bearing with insert.



Top OD 43/64" (16.80 mm)
Length 1-3/64" (26.38 mm)

Order No. 17 - 50205

Blade adaptor bolt with locking replaces Stiga 9990-1020-19. Fits Stiga Park and Stiga Villa.



Top ID 7/8" (21.80 mm)
Top OD 1-17/32" (38.82 mm)
Bottom OD 2-37/64" (65.50 mm)
Height 2-11/32" (59.24 mm)

Order No. 17 - 50206

Blade adaptor for Stiga. Fits Multiclip. Has 3/16" (4.15 mm) keyway.



Top ID 63/64" (24.95 mm)
Top OD 1-45/64" (43 mm)
Bottom OD 2-37/64" (65.50 mm)
Height 1-63/64" (50.20 mm)

Order No. 17 - 50209

Blade adaptor for Stiga. Fits Pro 48. Has 3/16" (4.75 mm) keyway.



Top ID 7/8" (21.90 mm)
Top OD 1-17/32" (38.82 mm)
Bottom OD 2-37/64" (65.50 mm)
Height 1-63/64" (50.21 mm)

Order No. 17 - 50208

Blade adaptor for Stiga. Fits Flandria Turbo. Has 3/16" (4.51 mm) keyway.

Order No. 17 - 50204

Blade adaptor key replaces Stiga 1134-0323-00. Fits Stiga Park 2000-2002, Stiga Villa, and Stiga Garden. Fits our 17-50203. MIN010



30

O.E.M.





STIGA (Cont.)

ORDER NO.	REPLACES O.E.M. NO.	LENGTH	CENTER HOLE DIAM.	OUTSIDE HOLE DIAM.	CENTER TO CENTER	WIDTH	STEEL THICK.	APPLICATION
 15 - 50150	1111-9003-01	5-1/2" 139.70mm	5/16" 7.94mm			2" 50.80mm		Fits Stiga Kommun & Multiclip.
 15 - 14172	1134-5073-01 1134-9123-01	6-39/64" 168mm	21/64" 8.2mm					Fits Park Models 107M, Villa 92M, 107M.
 15 - 50027	1134-1452-01 Stiga Villa	12-1/4" 312mm	.397" 10.32mm	.335" 8.73mm	3.25" 82.55mm	2.0" 50.80mm	.150" 3.97mm	
 15 - 50247	1111-2759-01	12-11/16" 322.27mm	3/4" 19.05mm			1-9/16" 40.09mm	.095" 2.3mm	
 15 - 50007	1134-1903-00 Stiga Park	14-1/2" 370mm	.399" 10.32mm	.334" 8.73mm	3.24" 82.55mm	2.0" 50.80mm	.150" 3.97mm	
 15 - 50026	1134-0456-00 Stiga Villa	14-1/2" 370mm	.397" 10.32mm	.335" 8.73mm	3.25" 82.55mm	2.0" 50.80mm	.150" 3.97mm	
 15 - 50061	1134-2450-01	15" 382mm	13/32" 10.3mm	11/32" 8.5mm	3-9/32" 83.3mm	2" 50mm	.150" 4mm	Fits Park Models 100M, 102M & Villa.
 15 - 50295	 1134-9124-01	16-11/16" 406.4mm	3 lobed			2.362" 60mm	.134" 3.4mm	Mulching Blade (Export Only)
 15 - 50030	1111-1530 Stiga Multiclip	18-1/8" 457mm	.385" 10.32mm	.326" 8.73mm	2.12" 53.98mm	2.0" 50.80mm	.134" 3.57mm	
 15 - 50296	 1134-9125-01	18-1/8" 465mm	3 lobed			2.52" 64mm	.134" 3.4mm	Mulching Blade (Export Only)
 15 - 50139	1111-2442-02 1111-9076-01	20-1/8" 511.2mm	.411" 10.4mm	.341" 8.7mm	2.135" 54.2mm	2" 50.8mm	.160" 4.1mm	

30
O.E.M.



O.E.M. REPLACEMENT STIGA (Cont.)

ORDER NO.	REPLACES O.E.M. NO.	LENGTH	CENTER HOLE DIAM.	OUTSIDE HOLE DIAM.	CENTER TO CENTER	WIDTH	STEEL THICK.	APPLICATION
 15 - 10739	1111-9109-01	20-1/8" 511.2mm	.411" 10.4mm	.442" 11mm	2.135" 54.2mm	2" 50.8mm	.160" 4.1mm	Fits Stiga model Multiclip Pro 5/S
 15 - 50246	1111-2598-01	20-13/16" 528.64mm	13/32" 10.31mm	5/16" 8.33mm	2-1/8" 53.98mm	3-5/16" 84.14mm	.095" 2.3mm	



ID 47/64" (18.65 mm)
OD 11/32" (8.73 mm)
Length 4" (101.60 mm)
Height 37/64" (14.68 mm)

Order No. 17 - 50203

Blade adaptor replaces Stiga 1134-2082-01. Fits Stiga Park 2000-2002, Stiga Villa, and Stiga Garden. Has 3/16" (4.76 mm) keyway.



Order No. 31 - 10710



Ignition switch replaces Stiga 1134-4093-01. Fits models Stiga Park 2000-and Stiga Villa 2001.



Order No. 31 - 50239

Solenoid replaces Stiga 1134-2946-02.

THATCHER

ORDER NO.	REPLACES O.E.M. NO.	LENGTH	CENTER HOLE DIAM.	OUTSIDE HOLE DIAM.	CENTER TO CENTER	WIDTH	STEEL THICK.	APPLICATION
 15 - 50071		16" 406.40mm	3/8" 9.53mm					Includes our 14-2008 Thatcher Hardware.
 15 - 50109		16" 406.40mm	5/8" 15.88mm			2.25" 63.50mm	150" 3.97mm	Hardware Not Included Uses our 14-2008 Thatcher Hardware.

THATCHER HARDWARE

Order No. 14 - 2008

Thatcher hardware fits our 15-50071, 15-50072, 15-50107, 15-50109 blades. Contains replacement Springs and Hardware.





TORO/WHEEL HORSE

Conduit 49-25/32"
Inner Wire 52-9/32"
Wire Travel 2-27/32"



Order No. 03 - 8765

Throttle control replaces Toro 70-1061. Fits old style 21" Toro rear bagger.

Conduit 41"
Inner Wire 43"
Wire Travel 2"



Order No. 03 - 9135

Throttle control replaces Wheel Horse 102119. Locking push-pull cable. "T" marked for throttle. 9/16" mount hole.

Conduit Length 62"
Overall Length 67-1/2"
Wire Travel 4-1/2"

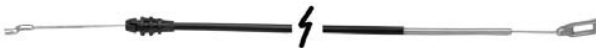

Order No. 05 - 14306

Brake cable replaces Toro 103-2683. Fits HD Recycler models 22162-22190.



Conduit Length 32-1/4"
Total Length 47-1/4"



Order No. 05 - 14620

Traction cable replaces Toro 106-8300. Fits super recycler mower.

Conduit 62"
Inner Wire 68-3/8"
Wire Travel 8-7/8"



Order No. 05 - 13436

Blade brake cable replaces Toro 99-6291. Fits commercial Pro-Line mower.

Conduit 35-1/4"
Inner Wire 45-1/4"
Wire Travel 10"

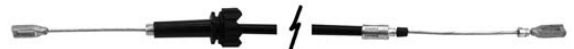

Order No. 05 - 13437

Drive cable replaces Toro 70-1080. Fits commercial Pro-Line mower.

Conduit 31-1/4"
Inner Wire 37-1/2"
Wire Travel 6-1/4"



Order No. 05 - 13430

Drive cable replaces Toro 84-9120 traction transmission. Fits commercial Pro-Line mower.

Conduit 34-5/8"
Inner Wire 43-1/2"
Wire Travel 8-7/8"



Order No. 05 - 13431

Drive cable replaces Toro 74-1791 traction transmission. Fits commercial Pro-Line mower.



Order No. 05 - 13433

Output shaft replaces Toro 74-1890 & 66-7330, self propelled gear box. Fits commercial Proline 21" models 22166, 22167, 22168.



1/8" x 2"

Order No. 05 - 7177

Square Key replaces Toro 39-7842. Fits 21" self-propelled walk behind mowers. Used on short shaft in gear case.

MIN010

30

O.E.M.

**O.E.M. REPLACEMENT
TORO/WHEEL HORSE (Cont.)**



.125" x .187" x .452"

Order No. 05 - 8770

Wheel drive key replaces Toro 39-9680. Fits Toro Proline 21" self propelled mowers. Used with our **05-8207** wheel drive gear. MIN010



Order No. 05 - 8207

Drive Gear replaces Toro 39-9160. Fits models 22020, 22030, 22035 and 20680 rear wheel drive models.



Order No. 42 - 8250

Jackshaft coupler replaces Toro 51-4260. For 36", 48", 52" and 61" walk behind mowers. Comes with grease fitting and safety sleeve.



Order No. 05 - 7920

Wheel drive gear replaces Toro 18-9690. Fits side discharge, front wheel drive self propelled models.



Order No. 05 - 8265

Brake band replaces Toro 51-4700. Fits 32" thru 61" deck walk behind mowers.



Order No. 05 - 8296

Brake drum replaces Toro 51-4180. Fits Proline Z models.



ID 1"
OD 4-3/8"

Order No. 41 - 7678

Drive disc replaces Toro 37-6570.



Order No. 42 - 14176

Pro-Gear T7510 transmission replaces Peerless 700-070A, Toro/Exmark 1-323500.



Order No. 42 - 14185

Pro-Gear 30-1001 Coupler. Replaces Peerless 786177, Toro 98-0789. 9-Spline



Order No. 06 - 5873

6" x 1.75" Deck Wheel. Replaces Toro 5303, Wheel Horse 110506. 1/2" grafoil bushing, 1-11/16" offset hub length. (painted red)

Order No. 06 - 11956

Deck wheel replaces Toro 63-8400. 3/4" OCRB, centered white wheel 6-1/4" x 3.00, 3/4" bore, rib tread. Painted white.



30
O.E.M.



TORO/WHEEL HORSE (Cont.)



Order No. 06 - 2983

8" x 1.75", 1/2" Ball Bearing. Self-Propelled, 42 teeth **thin gear** (1/4") T-2 wheel. Replaces 26-2960, 11-1309, 11-1389. Supercedes Toro 26-2960. Rear bagger. 1-3/8" offset hub with zerk fitting. (painted white)

Order No. 06 - 2984

8" x 1.75", Self-Propelled, 42 teeth **wide gear** (3/8") T-3 wheel. Replaces 38-2930. For side bagger. 1-5/8" offset hub, 1/2" ball bearing, and zerk fitting. (painted white)

Order No. 06 - 2988

Toro Front Drive Self-Propelled Wheel, 8" x 1.75", 1/2" ball bearing, 1-3/4" offset Hub and zerk fitting. Solid 42 teeth **wide gear** wheel. (painted white)



Order No. 06 - 13432

Steel wheel with gear replaces Toro 74-1720 & Exmark 100-2860. Fits rear commercial proline 21" mower model 22166, 22167, 22168. Exmark Metro 21" & Toro 21" Recycler. 3/8" bore, diamond tread, 8 x 2.00, 1-1/4" centered hub. Rear wheel (used with our front wheel **06-13403**)



Order No. 06 - 13403

Front wheel assembly replaces Toro 100-2870. 8". Fits Toro commercial mowers (used with our rear wheel **06-13432**)



Order No. 07 - 282

8" x 1.75", 1/2" C.H, 1-3/8" offset hub, Diamond tread. Fits Toro 10-9680.



Order No. 07 - 13491

12" x 2.00", 1-7/8" hub length, 1/2" bore, radial tread, ball bearings, replaces Toro 105-1816. Rear wheel, fits Toro self-propelled 22" recycler lawnmower models 20012, 20016, 20019.



Order No. 07 - 13492

8" x 2.00", 1-3/4" hub length, 1/2" bore, radial tread, bushing, replaces Toro 105-1815. Front drive wheel, fits Toro self-propelled 22" recycler lawnmower models 20001, 20003, 20005, 20007, 20012, 20016, 20019, 20064, 20065, 20069, 20071, 20072, 20072A, 20086, 20087, 20094, 20110, 20111.



Order No. 07 - 14424

8" x 1-3/4" x 1/2" bore, plastic wheel replaces Toro 105-1814. Radial Tread tire.



ID 1/2"
Width 1-3/8"
Height 5"

Order No. 07 - 6915

Deck Wheel replaces Toro 61-9760. 1-1/2" centered hub, steel bushing.



ID 1/2"
Width 3-1/4"
Height 2-15/16"

Order No. 07 - 8201

Deck wheel replaces Toro 94-1599, Wheel Horse 108798. Used on 36", 42" and 48" decks. Deck models 300, 400 and 500 series. 3-1/2" centered hub.

30

O.E.M.



**O.E.M. REPLACEMENT
TORO/WHEEL HORSE (Cont.)**



ID 5/8"
Width 2-3/4"
Height 5"

Order No. 07 - 6917

Deck Wheel replaces Toro 1-603299, 68-2730. 2-1/2" offset hub.



ID 1/2"
Width 2-3/4"
Height 5"

Order No. 07 - 6916

Deck Wheel. Replaces Toro 112-0677. 2-1/2" offset hub.



Order No. 08 - 8684

Caster wheel assembly replaces Toro 68-8970. 8 x 300 x 4, 4 ply tube type turf tread tire, 3 piece rim, 3-1/4" centered hub with 3/4" open cage roller bearing and zerk fitting. Fits all Toro midsize units. (painted white). Uses our **08-8582** tire, & our **08-8195** tube. Used our **09-8439** bearing.



Order No. 08 - 8582

8 x 300 x 4, 4 ply turf tread tube type tire replaces Toro 68-8960. Fits Toro 68-8970 caster wheel on all mid size units.



- 3 Piece Rim
- Solid Foam Tire
- Flat Free

Order No. 08 - 8866

3-1/4" centered hub with 3/4" open cage roller bearing with zerk fitting. Fits Toro midsize units. Uses our **08-8864** tire & **09-8439** wheel bearing kit. (Painted white)

Order No. 08 - 8864

8 x 300 x 4 Solid foam tire is maintenance free, flat free, long lasting resists cracking, oil and chemical resistant. Constructed of micro-cellular polyurethane insures that it will never lose its form. Used with our **08-8866** wheel assembly.



Order No. 08 - 13337

Front wheel and tire assembly replaces Toro 105-3471. 4.10/3.50-4 Sawtooth tread tubeless tire, 3/4" ID x 4-1/4" hub length with zerk fitting. Fits Time Cutter Z.



Order No. 08 - 13422

Front wheel and tire assembly replaces Toro 117-7386. 4.10/3.50-4 ribbed tread tubeless tire, 3/4" ID x 4-1/4" hub length with zerk fitting. Fits Time Cutter Z, models 74360, 65, 66, 80, 81 & 74398, 42" & 50" units.



- 1 Piece Rim
- Flat Proof
- Semi Pneumatic

Order No. 08 - 10286

13 x 650-6 Reliance tire mounted on a 6 x 4.50" steel wheel. 7.25" centered hub with 3/4" cups pressed in for tapered roller bearings. Replaces Toro 63397. (Painted White) Uses our **09-813** bearing or our **09-9944** bearing kit.

Order No. 08 - 10288

13 x 500-6 Reliance tire mounted on a 6 x 3.25" steel wheel. 5.625" centered hub with 3/4" cups pressed in for tapered roller bearings. Replaces Toro 633582. (Painted White) Uses our **09-813** bearing or our **09-9944** bearing kit.



Order No. 08 - 13421

Front wheel and tire assembly replaces Toro 110-6785. 4.10/3.50-4 smooth tread tubeless tire, 3/4" ID x 4-1/4" hub length with zerk fitting. Fits Time Cutter Z.

30

O.E.M.



TORO/WHEEL HORSE (Cont.)



- 1 Piece Rim
- Flat Proof
- Semi Pneumatic

Order No. 08 - 10742

11x400-5 Reliance tire. Wheel assembly replaces Toro 104-1170 & John Deere AM101589. 5" centered hub length, 3/4" roller bearings. Includes grease zerk. Painted white.



Order No. 08 - 12913

Wheel assembly replaces TORO 104-1170 & John Deere AM101589. 11x400-5, 4 ply tube type smooth tread tire. 5" centered hub length, 3/4" roller bearings. Includes grease zerk. Painted white, 1 piece rim.



Order No. 08 - 3277

280 x 250 x 4, 4 ply Saw Tooth Tire and Tube mounted on a 3-1/4" centered 3 piece rim, with 1" open cage roller bearing. Replaces Toro/Wheel Horse 54-8820. (painted red)



Order No. 08 - 12671

18 x 7.50 - 8, 4-ply tubeless Turf Saver tread tire. Used on Toro models.



Order No. 08 - 13402

Tire skin 8" new style replaces Toro 53-7740. Front and rear tire only for commercial mowers.



ID 1" (25.40 mm)
OD 1-31/32" (50.01 mm)
Height 19/32" (15.08 mm)

Order No. 09 - 814

Replaces Toro 468530, for 36", 44" & 52" front spindle bearing. Bearing No. L44610, L44643.



ID 3/4" (19.05 mm)
OD 1-3/8" (34.93 mm)
Height 1/2" (12.70 mm)

Order No. 09 - 327

Replaces Toro 110513, 251-210.



ID 3/4" (19.05 mm)
OD 1-25/32" (45.24 mm)
Height 19/32" (15.08 mm)

Order No. 09 - 484

Replaces Toro 251-8. Used on our 10-7154 shaft. Bearing No. 9504-ZZ.



ID 3/4" (19.05 mm)
OD 1-3/8" (34.93 mm)
Height 1/2" (12.70 mm)

Order No. 09 - 6573

Caster Wheel Bearing. Replaces Toro 251-210.



ID 1/2" (12.70 mm)
OD 1-1/8" (28.58 mm)
Height 5/16" (7.94 mm)

Order No. 09 - 6625

Wheel bearing for Toro. Replaces Toro 52-2450. Used on 21" Toro Commercial Mowers. Bearing No. R8-2RS.

30

O.E.M.

O.E.M. REPLACEMENT



TORO/WHEEL HORSE (Cont.)



ID .787" (19.98 mm)
OD 1.850" (46.99 mm)
Height 9/16" (14.29 mm)

Order No. 09 - 442

Bearing. Replaces Toro 251-318, 251-297.



ID 3/4" (19.05 mm)
OD 1-25/32" (45.24 mm)
Height 21/32" (16.67 mm)

Order No. 09 - 813

Replaces Toro 254-78, 254-79.



ID 21/32" (17 mm)
OD 1-9/16" (40 mm)
Height 15/32" (12 mm)

Order No. 09 - 7210

Spindle bearing replaces Toro/Wheel Horse 109966. Fits 42" & 48" decks. Bearing 6203-RS, sealed one side.



ID 63/64" (25 mm)
OD 2-3/64" (51.99 mm)
Height 19/32" (15.08 mm)

Order No. 09 - 7162

Bearing replaces Toro/Wheel Horse 113514. Fits Wheel Horse 50" & 60" cut "ZERO TURN" 500 series mowers. Bearing 6205-RS, sealed one side.



ID 3/4" (19.05 mm)
OD 2-3/64" (51.99 mm)
Height 1-1/16" (26.99 mm)

Order No. 09 - 3274

Rear Axle Bearing. Replaces Toro 47-1490. For rear engine rider models 725, 832, 1132 and 1232.



ID 5/8"
OD 2-1/2"
Height 3/4"

Order No. 09 - 12651

Flange bearing replaces Toro 51-4270. Also replaces Bobcat 38213 & Encore 363292. Fits mid-size models with Peerless Transmissions. Two 9/32" mounting holes, 2-1/2" center to center.



ID 1-1/8" (28.58 mm)
OD 1-3/8" (34.93 mm)
Height 1" (25.40 mm)

Order No. 09 - 8476

Yoke bushing replaces Toro 28-9290. Fits Toro mid size mowers 36", 37", 44", 52", 62" cut. Deck models 30136, 30137, 30144, 30152, 30162.



ID 33/64" (13.10 mm)
OD 11/16" (17.46 mm)
Height 1/2" (12.70 mm)

Order No. 09 - 7674

Needle bearing replaces Toro 48-2060. Fits 21" self propelled commercial transmission and wheel bracket bearing.



ID 3/4" (19.05 mm)
OD 1-9/16" (39.69 mm)
Height 15/32" (11.91 mm)

Order No. 09 - 6535

Spindle Bearing. Replaces Toro 37-0200. Used on Toro front engine rider mulcher unit model 57380 & 57385. Bearing no. 6203-2RS.



ID 1/2"
OD 3/4"
Length 4"

Order No. 09 - 8434

Spanner bushing replaces Toro 62-4340. Fits Toro Groundmaster models 322-D, 325-D & 327-D with 72" decks. For Toro 62-4330 front caster wheel assembly.

O.E.M. 30



TORO/WHEEL HORSE (Cont.)



Overall ID 1/2" (12.70 mm)
 Overall OD 1-3/8" (34.93 mm)
 Overall Length 3-11/32" (84.93 mm)

Order No. 09 - 8441

Wheel bearing kit for Toro. Fits Toro wheel 68-8970 front caster wheel assembly. Fits Toro mid size mower 36", 37", 44", 52" & 62" cut decks, models 30136, 30137, 30144, 30152, 30162. Kit contains our **09-8440** bearing, **09-9003** retainer bushings and **09-8420** spanner bushing.

Order No. 09 - 8440

Roller cage bearing with retainer bushings only. Replaces Toro bearing 62-5570 & bushing 62-5580. Roller cage bearing OD 1-1/4" (31.75 mm), ID 3/4" (19.05 mm), Length 1-11/16" (42.86 mm). Retainer bushings OD 1-3/8" (34.93 mm), ID 3/4" (19.05 mm), Height 5/8" (15.88 mm).

Order No. 09 - 9002

Roller cage bearing only for Toro. Replaces Toro 62-5570. Used on Toro 68-8970 front caster wheel assembly. OD 1-1/2" (38.10 mm), ID 3/4" (19.05 mm), Length 1-11/16" (42.86 mm).

Order No. 09 - 9003

Retainer bushing only for Toro. Replaces Toro 62-5580. Used on Toro 68-8970 front caster wheel assembly. OD 1-3/8" (34.93 mm), ID 3/4" (19.05 mm).

Order No. 09 - 8420

Spanner bushing only. Replaces Toro 68-8980. OD 3/4" (19.05 mm), ID 1/2" (12.70 mm), Length 3-11/32" (84.93 mm).



Thread Size 1/2"
 Length 5-1/4"

Order No. 10 - 8419

Wheel bolt replaces Toro 325-19. Fits Toro commercial mid size 36", 37", 44", 52", 62" cut deck, models 30136, 30137, 30144, 30152, 30162. Fits Toro wheel 68-8970.



Size 1/2" - 13

Order No. 10 - 8447

Wheel bolt nut replaces Toro 32153-5. Size 1/2" -13 hex nut. Fits our wheel bolt **10-8411** & **10-8419**. MIN010



OD 5/8"
 Length 4-1/4"

Order No. 10 - 9874

Wheel spacer replaces Toro 99-2842. Fits Toro Z Master anti-scalp roller wheel bolt.



Bearing OD 1-1/2"
 Shaft OD 3/4"
 Overall Length 4-17/32"

Order No. 10 - 3309

Spindle Shaft. Replaces Wheel Horse 103119.



ID 1-3/16"
 OD 1-3/4"
 Thickness 1/8"

Order No. 10 - 8418

Yoke washer replaces Toro 3-6781. Fits Toro mid size mowers 36", 37", 44", 52" & 62" cut decks. Models 30136, 30137, 30144, 30152, 30162. Used with our **10-8477** yoke. MIN010



ID 1-1/2"
 OD 2.125"
 Height .312"

Order No. 10 - 12756

Oil seal replaces Toro 253-139. Fits Groundmaster 217 & 220 with 52" & 62" deck spindles. Double lip, spring loaded, metal outer. MIN005



Order No. 10 - 13406

Front spring arm assembly replaces Toro 66-7560. Fits commercial mowers.



Order No. 10 - 13407

Rear pivot arm assembly replaces Toro 66-7561. Fits commercial mowers.

30

O.E.M.



O.E.M. REPLACEMENT
TORO/WHEEL HORSE (Cont.)



Order No. 10 - 13405

Rear pivot arm assembly replaces Toro 74-1851 / 74-1841. Fits commercial mowers.



Order No. 10 - 13404

Front pivot arm assembly replaces Toro 61-8300. Fits commercial mowers.



Order No. 10 - 12219

Spindle assembly replaces Toro model LX420 or 13ZX60RG544, part number 112-0460. Comes complete with our 13-12682 pulley. Pulley dia. 6-5/16, spindle height 6-3/8".



Order No. 10 - 12926

Spindle shaft replaces MTD 738-1010A & Toro 112-0884. Fits 42" & 50" decks. Fits our 10-12219 spindle assemblies. 6-3/8" long.



Order No. 10 - 13620

Spindle assembly replaces Toro 105-1688. Used with our 10-13621 spindle assembly. Fits Toro 62 Z center spindle.



Order No. 10 - 13621

Spindle assembly replaces Toro 99-4640. Used with our 10-13620 spindle assembly. Fits Toro 62 Z right hand & left hand spindle.



Order No. 10 - 14121

Spindle assembly replaces Toro 80-4341. Fits Time Cutter Z. Models 71180-71428 & 74301-74403. Long shaft. Includes 88-4510 housing with bearings, 80-4341 shaft, 80-4380 spacer.



Order No. 10 - 14122

Spindle assembly replaces Toro 117-1192. Fits Time Cutter Z. Models 74330-74399 & 74820. Z5060 & ZX5000. Short shaft. Replaces Toro 88-4510 housing, 117-1192 with shaft (110-6866 old PN), 80-4380 spacer & 80-4360 shield.



Order No. 10 - 14132

Spindle housing with bearings and spacer replaces Toro 107-9161. Included in our 10-14121 & 10-14122. Includes (2) Toro 100-1048 bearings our 09-7210, spacer 62-3661 & 88-4510 housing only.



Order No. 10 - 13631

Spindle assembly replaces Toro 112-6063. Pulley Dia. 5.75".

30

O.E.M.



TORO/WHEEL HORSE (Cont.)

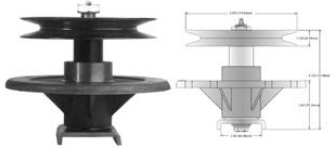

Order No. 10 - 13009

Spindle assembly replaces Toro 100-3976. Fits Z-Master with 52" deck.



Order No. 10 - 11074

Electric PTO clutch replaces Toro 94-4632 & 105-1671. Fits A320 - Z325. 4.875" Dia. Pulley. 1/2" Belt, shaft size 1-1/8". Warner 5218-33. Double pulley.



Order No. 10 - 12227

Electric PTO clutch replaces Toro 99-8012. 1" ID x 5.345" Pulley, 5/8" belt. Warner 5215-59.



Order No. 10 - 11075

Electric PTO clutch replaces Toro 105-3630. Warner 5218-44.



Order No. 10 - 11237

Electric PTO clutch replaces Toro 103-0501. Fits models 1600,000 & Higher. For 25hp engines. Warner 5218-65.



Order No. 10 - 11071

Electric PTO clutch replaces Toro 94-6136. Warner 5218-10.

Order No. 10 - 9913

Electric PTO clutch replaces Ariens 03090800, Cub Cadet WD-C38410, Grasshopper 388766/604182, Toro 93-3160. Double Pulley. 1-1/8" x 3-3/4" Height, 5" dia pulley, 1/2" belt. Warner No. 5215-62



30
O.E.M.



Order No.

Description

12 - 5015

Replaces Toro 5-4505/3-7274. For Self-propelled 21" side chute. 32" (812.8 mm) long, 3/8" (9.53 mm) wide.

12 - 5820

Replaces Toro 47-1410. Transmission Belt. "A" Section Belt, 47-1/2" length (1206.50 mm). For 32" rear engine rider.

12 - 5821

Replaces Toro 47-1420. Deck Belt. "A" section belt, 65.54" length (1664.72 mm). For 32" rear engine rider.

12 - 5231

Wheel Drive Belt. Replaces Toro 51-4290. Double "A" Section Belt, 50.375" length (1279.53 mm). For 32", 36", 44" & 52".

12 - 6837

Blade to Blade Belt. Replaces Toro 27-1160. "AA" section belt, 103.5" length (2628.90 mm). Fits 44" & 52" mid size decks.

12 - 8887

Blade Brake Belt. Replaces Toro 42-0884. 1/2" (12.7 mm) x 23.92" (607.57 mm). Fits Toro Homeowner models 20624, 20684, 20695. Raw edge, cogged, *Aramid fiber.

O.E.M. REPLACEMENT



TORO/WHEEL HORSE (Cont.)



Order No.

Description

- 12 - 6972** **Engine to Blade Belt.** Replaces Toro 55-7660. Fits 52" mid size decks.
- 12 - 7171** **Engine to Deck Belt.** Replaces Toro/Wheel Horse 102742. 103" length (2616.20 mm), Polyester cord constr. Fits 42" and 48" cut side discharge. Rear engine riders (older Wheel Horse models.)
- 12 - 10051** **Engine to Deck Belt.** Replaces Toro 99-4647. 21/32" (16.67 mm) x 142.10" (3609 mm). Fits 62" Z-Master. *Aramid fiber.
- 12 - 12730** **Engine PTO to Deck Belt.** Replaces Toro **106-7350**. 5/8" (15.875mm) x 264" (6705.6 mm). Fits model Z500 Z-Master 72" deck. Wrapped-molded, aramid cord construction, double cover, wrapped.
- 12 - 12729** **Engine PTO to Deck Belt.** Replaces Toro **105-8783**. 5/8" (15.875mm) x 242" (6146.8 mm). Fits model Z500 Z-Master 60" deck. Wrapped-molded, aramid cord construction, double cover, wrapped.
- 12 - 10746** **V Belt.** Replaces Toro 26-9671. 1/2" (12.7 mm) x 39-5/16" (998.53 mm). Raw edge, laminated, aramid cord construction.
- 12 - 12672** **V Belt.** Replaces Toro **110-6892**. 1/2" (12.7mm) x 140.1" (3558.5mm). Fits Timecutter Z5000-Z5040. Wrapped molded Aramid cord construction double cover, clutching, white.
- 12 - 13247** **V Belt.** Replaces Toro **93-0232**. 3/8" (9.5 mm) x 31.939" (811.2mm). Fits 21" Recycler. Fiberglass cord construction, single cover, clutching white.
- 12 - 12867** **V Belt.** Replaces Toro **106-7369**. 5/8" (15.875mm) x 176" (4470.4mm). Fits Z-Master Z400 series. Aramid double clutching cover, white.
- 12 - 12916** **Pump Belt.** Replaces Toro **1-633749**. .687" (17.5mm) x 57.19" (1452.6mm). Accessory drive, pump belt, used on Z-Master. 5 rib belt.
- 12 - 13573** **Pump Drive Belt.** Replaces Toro **110-5049**. 1/2" (12.7 mm) x 46-15/16" (1192.2mm). Fits 30000 series commercial walk behind. Wrap molded, Aramid cord construction, double cover, friction.
- 12 - 13408** **Pump Belt.** Replaces Toro **1-653283**. 1/2" (12.7 mm) x 52-1/4" (1327.2mm). Fits models 74170, Z147 Z Master. Raw edge, Aramid cord construction.
- 12 - 14319**  **Pump Belt.** Replaces Toro **115-9613**. 1/2" (12.7 mm) x 75-3/8" (2222.5 mm). Fits models Titan & Exmark Quest (42", 48" & 52") Raw edge cogged belt.
- 12 - 5119** **Spindle Belt.** Replaces Wheel Horse 6738 for 42" cut units. 1/2" (12.70 mm) x 86" (2184.4 mm).
- 12 - 13572** **Spindle Drive Belt.** Replaces Toro **108-2716**. 1/2" (12.70 mm) x 105-19/64" (2674.5mm). Fits 30000 series commercial walk behind with 48" deck.Wrap molded, Aramid cord construction, double cover, friction.
- 12 - 13570** **Spindle Drive Belt.** Replaces Toro **108-2694**. 1/2" (12.70 mm) x 111" (2819.4mm). Fits 30000 series commercial walk behind with 52" deck Wrap molded, Aramid cord construction, double cover, semi-dry black.
- 12 - 13571** **PTO/Deck Drive Belt.** Replaces Toro **108-2715**. 5/8" (15.8 mm) x 78-21/64" (1989.5mm). Fits 30000 series commercial walk behind with 48" deck. Wrap molded, Aramid cord construction, double cover, friction.

30

O.E.M.



TORO/WHEEL HORSE (Cont.)



Order No.

Description

12 - 13569

PTO/Deck Drive Belt. Replaces Toro **108-2693**. 5/8" (15.8 mm) x 81-3/4" (2076.4mm). Fits 30000 series commercial walkbehind with 52" deck. Wrap molded, Aramid cord construction, double cover, clutching white.

12 - 12805

Drive Belt. Replaces Toro **105-7790**. 5/8" (15.875mm) x 226" (5740.4 mm). Fits model Z587, 60" deck. Wrapped-molded, aramid cord construction, double cover, wrapped.

12 - 14365

 **Drive Belt.** Replaces Toro **88-6250**. 1/2" (12.7 mm) x 87-1/2" (1905 mm). Fits models 71193, 14-38HXL lawn tractor. Also replaces John Deere GX21986, M40223, 6996. Traction drive belt for 100 series with 54" deck. Wrapped molded, Aramid cord construction, double friction cover.

12 - 14129

 **Drive Belt.** Replaces Toro **110-6774**. 1/2" (12.7 mm) x 62-1/2" (1587.5 mm). Hydro pump drive belt. Fits Time Cutter Z4200, Z4220, Z4235, Z5000, Z5020, Z5030, Z5035, Z5040, Z5060. Cogged belt.

12 - 14042

 **Drive Belt.** Replaces Toro **91-2258**. 3/8" (9.5 mm) x 35" (889 mm). Fits Recycler and Super Recycler self-propelled belt for walk-behind mowers. Covered belt.

12 - 14318

 **Deck Belt.** Replaces Toro **115-4971**. 5/8" (15.87 mm) x 175-7/8" (4445 mm). Fits 54" ZX5400 Titan deck belt. Wrapped belt.

12 - 14130

 **Deck Belt.** Replaces Toro **110-6871**. 1/2" (12.7 mm) x 112-1/8" (2844.8 mm). Fits Z4200 42" TimeCutter Z. Wrapped belt.

12 - 7952

Snowblower Belt. Replaces Toro 25-6430. 3/32" section belt (2.38 mm), 33" length (838.20 mm), poly "V" belt, fits Snowmaster S200, & S620.

12 - 10090

Snowthrower Belt. Replaces Toro 71-5381. 3/8" (9.53 mm) x 34-1/2" (876.3 mm). Fits model CCR1000. Raw edge. *Aramid fiber.

12 - 12687

Snowthrower Auger Belt. Replaces Toro **75-9010**. 3/8" (9.5mm) x 29.218" (742.1 mm). Fits Power Life Snowthrowers 1997-2010. Raw edge, laminated, Aramid cord construction.

* Made with KEVLAR® or non-trade marked Aramid fiber.



ID 3/8"
OD 4-1/8"
Height 1-1/2"

Order No. 13 - 12901

Idler pulley replaces Toro 106-2175.



ID 1"
OD 2-7/8"
Height 27/32"

Order No. 13 - 7278

Idler Pulley replaces Toro 46-5650. Fits all 21" BBC models.



ID 3/4"
OD 4"
Height 1-1/8"

Order No. 13 - 8373

Flat idler pulley replaces Toro/Wheel Horse 104975. Fits garden Tractors 300, 400, and 500.

30

O.E.M.



O.E.M. REPLACEMENT TORO/WHEEL HORSE (Cont.)

Flat Idlers with Flange



Order No. 13 - 719

Replaces Toro 3-4244.

Order No. 13 - 718

Replaces Toro 7-0056.

Order No. 13 - 722

Replaces Toro 244-63, Wheel Horse 112426.

Order No. 13 - 723

Replaces Wheel Horse 112425.

Order No. 13 - 727

Replaces Wheel Horse 112895.

Order No. 13 - 721

Replaces Wheel Horse 105874.

Order No. 13 - 2193

Flat Idler without Flanges. Replaces Toro 25-5880.

Note: See Section 13 for Idler Measurements.

V-Belt Idlers



Order No. 13 - 728

Replaces Toro 3-4243, Wheel Horse 8205.

Order No. 13 - 733

Replaces Toro 7-0431.

Order No. 13 - 731

Replaces Toro 62-4530.

Order No. 13 - 729

Replaces Toro 12-5820.

Order No. 13 - 734

Replaces Wheel Horse 7451.

Order No. 13 - 2182

Replaces Wheel Horse 8510.

Note: See Section 13 for Idler Measurements.



ID 7/16"
OD 2-5/8"
Height 1"

Order No. 13 - 13434

Transmission gear case pulley replaces Toro 39-6740. Fits Commercial Proline 21" model 22166, 22167, 22168.



ID 2"
OD 7-5/8"
Height 1"

Order No. 13 - 13639

Spindle pulley replaces Toro 105-7734. Fits Z Master models 74238, 24244, 74245, 74246, 74249, 74250, 74251, 74253, 74255, 74262, 74265, 74267, 74268, 74272, 74283, 74292, 74915, 74925, 74935, 74945.



ID 2-1/4"
OD 8"
Height 1/2"
Mounting Holes 11/32"

Order No. 13 - 9397

Drive wheel pulley replaces Toro 51-4160 & Scag 48200. Fits our 08-8241 & 08-8573 wheel assembly. Fits Scag/Encore rear wheel drive 36", 48", 52" & 61" cut mowers.



ID 3/4"
OD 4-1/4"
Height 13/16"

Order No. 13 - 8829

V-Idler pulley replaces Toro 92-7103 & 104974. Fits garden tractor models 300, 400 & 500.



ID 5/8"
OD 4-3/8"
Height 1"

Order No. 13 - 9895

V-Belt Idler pulley replaces Toro 65-5940. Heavy duty riveted pulley.



ID 5/8"
OD 2-3/4"
Height 1-11/16"
Keyway 3/16"













Order No. 13 - 9805

Double pulley replaces Toro 74-0480/99-5878. Fits belt drive for commercial midsize walkbehind units.

O.E.M. 30



TORO/WHEEL HORSE (Cont.)

ORDER NO.	REPLACES O.E.M. NO.	LENGTH	CENTER HOLE DIAM.	OUTSIDE HOLE DIAM.	CENTER TO CENTER	WIDTH	STEEL THICK.	APPLICATION
 15 - 6137	72-7690	10-1/2" 266.7mm	5/8" 15.9mm			2-1/2" 63.5mm	.134" 3.4mm	Fits 48" midsize recycler takes (1) 15-6137 (1) 15-6136 & (1) 15-6135 Center Blade
 15 - 2000	117192	13-7/8" 352.4mm	3/4" 19.1mm			2" 50.8mm	.187" 4.8mm	For 42" cut side discharge (set of 3 # 3-11620)
 15 - 1108	100200	14" 355.6mm	3/4" x 5/8" 19.1mm	1/4" 6.4mm	1-5/8" 41.3mm	2" 50.8mm	.187" 4.8mm	42" cut, WH set of (3) No. 3-6693. For side discharge models R1-426, 5-1000 thru 5-1001, 5-1010, 5-1011, 5-1421, thru 5-14 and 65-42 MSOL from 1966 - 1976
 15 - 6267	14-4879 79-2920	14-1/2" 368.3mm	3/4" 19.1mm			2-1/2" 63.5mm	.187" 4.8mm	(3) blades for 42" cut. Fits 42" cut "ZERO TURN" mower with 42" deck. Mulching blade.
 15 - 851	10610	14-1/2" 368.3mm	3/4" 19.1mm			2" 50.8mm	.204" 5.2mm	For 42" cut, Rear discharge WH set 106635
 15 - 1030	112-0302	14-13/16" 376.2mm	"H" Pattern	3/8" 9.5mm	2-1/2" 63.5mm	2-1/2" 63.5mm	.150" 3.8mm	Takes (1) 15-1030 & (2) 15-1029 for 46" cut. Mulching blade.
 15 - 3393	55-4940	15-1/2" 393.7mm	5/8" 15.9mm			2-1/2" 63.5mm	.187" 4.8mm	Fits Model 30144 44" Midsize Cutting Mower High Lift
 15 - 3441	54-0010	15-1/2" 393.7mm	5/8" 15.9mm			2-1/2" 63.5mm	.187" 4.8mm	(3) blades for 44" cut Deck 57358, Groundsmaster model 117 and 1144 rider tractor
 15 - 9885	54-0010	15-1/2" 393.7mm	5/8" 15.9mm			2-1/2" 63.5mm	.187" 4.8mm	.187" Mulching Blade PATENTED
 15 - 6326	92-7952	15-1/2" 393.7mm	5/8" 15.9mm			2-1/2" 63.5mm	.187" 4.8mm	(3) blades for 44" cut Recycle Blade.
 15 - 2001	106637	16" 406.4mm	3/4" 19.1mm			2" 50.8mm	.187" 4.8mm	For 48" cut side discharge Wheel Horse set (3-10607)
 15 - 1029	112-0304	16-1/4" 412.8mm	"H" Pattern	3/8" 9.5mm	2-1/2" 63.5mm	2-1/2" 63.5mm	.150" 3.8mm	Takes (1) 15-1030 & (2) 15-1029 for 46" cut. Mulching blade.

30
O.E.M.

O.E.M. REPLACEMENT











TORO/WHEEL HORSE (Cont.)

O.E.M. 30

ORDER NO.	REPLACES O.E.M. NO.	LENGTH	CENTER HOLE DIAM.	OUTSIDE HOLE DIAM.	CENTER TO CENTER	WIDTH	STEEL THICK.	APPLICATION
15 - 6187	93-0107 84-4370	17" 428.6mm	21/32" 16.7mm			2-1/2" 63.5mm	.187" 3.2mm	Fits 37" deck
15 - 3372	113579	17" 431.8mm	5/8" 15.9mm			2" 50.8mm	.204" 5.2mm	(3) blades for 50" cut. Fits Wheel Horse 718Z & 724Z Also replaces Dixie Chopper 30227
15 - 6224	113579	17" 431.8mm	5/8" 15.9mm			2-1/2" 63.5mm	.204" 5.2mm	(3) blades for 50" cut Toro "ZERO TURN" (Heavy Duty)
15 - 6298	113579	17" 431.8mm	5/8" 15.9mm			2-1/2" 63.5mm	.204" 5.2mm	Mulching Blade PATENTED
15 - 6013	113579	17" 431.8mm	5/8" 15.8mm			2" 50.8mm	.240" 6.1mm	Low-Lift Blade Sharpened - 4-sides
15 - 12273	110-6837-03	17-1/2" 444.5mm	5/8" 15.9mm			2-1/4" 57.2mm	.170" 4.3mm	High Lift Blade. Fits model Timecutter Z (3) blades for a 50" cut.
15 - 12362	112-9759-03 110-6837-03	17-1/2" 444.5mm	5/8" 15.9mm			2-1/4" 57.2mm	.187" 4.8mm	Commercial Mulcher Fits model Timecutter Z (3) blades for a 50" cut.
15 - 3361	27-0990	18" 457.2mm	1/2" 12.7mm			2-1/2" 63.5mm	.187" 4.8mm	(3) blades for 52" cut Groundsmaster Std. Lift
15 - 3405	56-2390	18" 457.2mm	1/2" 12.7mm			2-1/2" 63.5mm	.187" 4.8mm	(2) blades for 36" cut & (3) blades for 52" cut High Lift
15 - 3394	55-4210	18" 457.2mm	5/8" 15.9mm			2" 50.8mm	.187" 4.8mm	Fits model 30136 and 30152. For 36" and 52" cut. Midsize mowers
15 - 10173	55-4210	18" 457.2mm	5/8" 15.8mm			2-1/2" 63.5mm	.204" 5.2mm	Flat Blade Sharpened - 4-sides
15 - 6410	56-2390	18" 457.2mm	1/2" 12.7mm			2-1/2" 63.5mm	.187" 4.8mm	Mulching Blade PATENTED

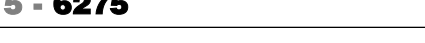
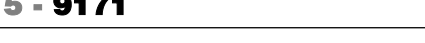

TORO/WHEEL HORSE (Cont.)

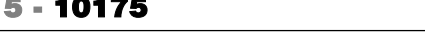
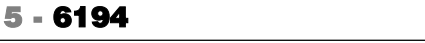
ORDER NO.	REPLACES O.E.M. NO.	LENGTH	CENTER HOLE DIAM.	OUTSIDE HOLE DIAM.	CENTER TO CENTER	WIDTH	STEEL THICK.	APPLICATION
 15 - 9968	55-4210	18" 457.2mm	5/8" 15.8mm			2" 50.8mm	.240" 6.1mm	Low-Lift Blade Sharpened - 4-sides
 15 - 3468	109918	18-3/4" 476.3mm	3/4" 19.1mm			2" 50.8mm	.204" 5.2mm	Takes (2) for 37" cut Wheel Horse Set 109079
 15 - 1011	8-5240	19" 482.6mm	7/16" 11.1mm			2-1/2" 63.5mm	.125" 3.2mm	New Toro Whirlwind and Guardian
 15 - 6184	79-3061 14-7799	19-1/4" 489mm	5/8" 15.9mm			2-1/2" 63.5mm	.187" 4.8mm	(2) blades for 38" cut "ZERO TURN" models 616 & 620 mulching blade
 15 - 3395	57-4700	19-5/16" 490.5mm	5/8" 15.9mm			2-1/2" 63.5mm	.187" 4.8mm	38" cut Fits 612, 616 and 620 ZT unit. Also fits 200 series side discharge
 15 - 6270	69-6920	20" 508mm	5/8" 15.9mm			2-1/2" 63.5mm	.240" 6.1mm	Fits Toro 580D mower. (11) blades for 16' deck Groundmaster
 15 - 6275	93-0241	20-1/4" 514.4mm	7/16" 11.1mm			2-1/2" 63.5mm	.134" 3.4mm	Fits 21" Toro recycler with 4.5 hp motor. Fits model 20444.
 15 - 9171	112947	20-1/2" 520.7mm	5/8" 15.8mm			2-1/2" 63.5mm	.204" 5.2mm	Fits Wheel Horse
 15 - 10667	103-2530	20-1/2" 520.7mm	5/8" 15.9mm			2-1/2" 63.5mm	.204" 5.2mm	Notched High Lift blade. (3) blades for a 60" cut. Fits Ground Master
 15 - 10175		20-1/2" 520.7mm	5/8" 15.8mm			2-1/2" 63.5mm	.204" 5.2mm	Flat Blade Sharpened - 4-sides
 15 - 6194		20-1/2" 520.7mm	5/8" 15.8mm			2" 50.8mm	.240" 6.1mm	Low-Lift Blade Sharpened - 4-sides
 15 - 10928	93-4106-03 108-3762-03	20-27/32" 531mm	7/16" 11mm	3/8" 9.5mm	2-7/16" 61.9mm	2-1/4" 57.2mm	.150" 3.8mm	Fits 21" Recycler Walkbehind mower.

30
O.E.M.

O.E.M. REPLACEMENT
TORO/WHEEL HORSE (Cont.)













O.E.M. 30

ORDER NO.	REPLACES O.E.M. NO.	LENGTH	CENTER HOLE DIAM.	OUTSIDE HOLE DIAM.	CENTER TO CENTER	WIDTH	STEEL THICK.	APPLICATION
 15 - 6256	91-2256-03 14-9419 75-9420	20-15/16" 531.9mm	7/16" 11.1mm	3/8" 9.5mm	2-7/16" 61.9mm	2-9/16" 65.1mm	.134" 3.4mm	Blade only Fits Toro 21" Recycler without saddle
 15 - 6465	80-0510-03							Blade stiffener. Used with our 15-6256 Blade.
 15 - 13260	108-0954-03	21" 533.4mm	7/16" 11.1mm			2-1/4" 57.2mm	.150" 4mm	Replaces Toro Atomic Bld. Mulching Blade Patented.
 15 - 6308	75-9420	21" 533.4mm	7/16" 11.1mm	3/8" 9.5mm	2-7/16" 61.9mm	2-1/2" 63.5mm	.160" 3.8mm	Mulching Blade PATENETED
 15 - 1006	20-2720	21" 533.4mm	7/16" 11.1mm			2-5/8" 66.7mm	.125" 3.2mm	Guardian
 15 - 1012	8-5230	21" 533.4mm	7/16" 11.1mm			2-5/8" 66.7mm	.125" 3.2mm	New Toro Whirlwind
 15 - 1008	26-0880 42-1000	21" 533.4mm	7/16" 11.1mm	3/8" 9.5mm	2-7/16" 61.9mm	2-5/8" 66.7mm	.125" 3.2mm	Toro rear bagger and Grassmaster
 15 - 6002	62-7700	21-1/16" 534.99mm	7/16" 11.1mm	3/8" 9.5mm	2-7/16" 61.9mm	2-3/4" 69.9mm	.134" 3.4mm	Vac-U Deck For 21" Rear Bagger model 26622
 15 - 6251	44-6250	21-1/2" 546.1mm	1/2" 12.7mm			2-1/2" 63.5mm	.187" 4.8mm	(3) blades for 62" cut Fits Toro 62" cut Groundmaster
 15 - 10209	55-4210	21-1/2" 546.1mm	1/2" 12.7mm			2-1/2" 63.5mm	.204" 4.8mm	Flat Blade Sharpened - 4-sides
 15 - 13129	110-1857-03 110-6568-03 106-8744-03 106-2247-03	21-5/8" 549.2mm	5/8" 15.9mm			2-1/4" 57.2mm	.160" 4.1mm	(2) blades for a 42" cut. Mulching Blade. PATENTED
 15 - 11821	106-2247-03	21.675" 550.5mm	5/8" 15.8mm			2-1/4" 57.2mm	.160" 4.1mm	Fits model Time Cutter Z Standard Blade (2) blades for a 42" cut.



TORO/WHEEL HORSE (Cont.)

ORDER NO.	REPLACES O.E.M. NO.	LENGTH	CENTER HOLE DIAM.	OUTSIDE HOLE DIAM.	CENTER TO CENTER	WIDTH	STEEL THICK.	APPLICATION
 15 - 10929	104-8697-03 108-9764-03	21-23/32" 551.7mm	7/16" 11mm			2-1/4" 57.2mm	.150" 3.8mm	Fits 22" Recycler Walkbehind mower.
 15 - 12649	108-9764-03	21-23/32" 551.6mm	7/16" 11.1mm			2-1/4" 57.2mm	.150" 3.8mm	Fits 22" Recycler Mulching Blade. PATENTED
 15 - 6135	72-7740	23" 584.2mm	5/8" 15.9mm			2-1/2" 63.5mm	.187" 4.8mm	Fits 48" midsize recycler Takes (1) 15-6135 , (1) 15-6136 and (1) 15-6137 Right hand blade (RH cut)
 15 - 6136	72-7730	23" 584.2mm	5/8" 15.9mm			2-1/2" 63.5mm	.187" 4.8mm	Fits 48" mid size recycler Takes (1) 15-6136 , (1) 15-6135 and (1) 15-6137 Left hand blade (LH cut)
 15 - 9986	94-1861	24-3/4" 628.7mm	1/2" 12.7mm			2-1/2" 63.5mm	.204" 5.2mm	(3) blades for 72" cut. Fits 72" Grounds Master.
 15 - 3362	29-5530	25" 635mm	3/4" 19.1mm			2-1/2" 63.5mm	.240" 6.1mm	(3) for 72" cut Groundsmaster Left hand cut
 15 - 6271	85-6040	25-3/16" 639.8mm	1/2" 12.7mm			2-1/2" 63.5mm	.240" 6.1mm	72" recycler deck blade. Used on Groundmaster models 322D, 322, 325D, 325.
 15 - 6001	67-0200	25-7/32" 640.6mm	5/8" 15.9mm			2-1/2" 63.5mm	.187" 4.8mm	
 15 - 2171	33-4750	31-3/8" 796.9mm	5/8" 15.9mm			2-1/2" 63.5mm	.187" 4.8mm	High Lift
 15 - 6118	80-4430	31-3/8" 796.9mm	5/8" 15.9mm			2-1/2" 63.5mm	.187" 4.8mm	Mulching blade for 32" rear engine rider.

30
O.E.M.



**O.E.M. REPLACEMENT
TORO/WHEEL HORSE (Cont.)**



Order No. 18 - 1282

Muffler. Replaces Toro Kit 2-9319. Painted, bolt-on type. Comes complete with bolts, gasket and lock. Heavy-gauge steel. 1-11/16" height. For push mowers.



Height 2-3/4"

Order No. 18 - 1280

Muffler. Replaces Toro Kit 5-4769. Painted, bolt-on type. Comes complete with bolts, lock and gasket. 2-3/4" height. For self-propelled mowers.



Order No. 18 - 891

Muffler replaces Wheel Horse 110774 and 110771. With bolts and heat shield.



Order No. 19 - 6991

Replaces Toro 63-9380. Used on 2-cycle Suzuki equipped Toro mowers.

30

O.E.M.

Order No. 19 - 2782

Filter. Replaces Toro 81-0100. For 2-cycle Suzuki engines.



Length 6-3/4"
Width 3-5/8"
Thickness 1-1/4"

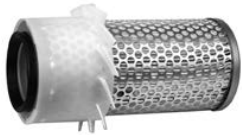

ID 1-11/16"
OD 3-9/32"
Height 7-1/4"

Order No. 19 - 8279

Air filter replaces Toro 33-1300, 108-3808. Fits models B5100, B5200, B6100, B6100DT, B6100HST, B7100, B7100DT, B7100HST, B8200HST, L225, L225DT, L235, L245, L245DT, L245H, L260H (21 & 24 hp), L275.



ID 2-1/2"
OD 4"
Height 10-1/4"

Order No. 19 - 8328

Filter replaces Toro 27-7110. Fits models L275, 285, 295, 295DT, 305, 345, 345Dt, 355SS, 2250, 2550, 2850, 2650, 2950, 3450, 3650, M4000, 4050, 4500, 4500C, 4500DT.



Wire Reinforced



Order No. 19 - 6567

Filter and Prefilter replaces Wheel Horse KW10017. Fits 12-1/2 hp.

Order No. 19 - 5861

Prefilter.



Order No. 19 - 2803

Filter and Prefilter replaces Wheel Horse KW10017. Fits 12-1/2 hp.

Order No. 19 - 5861

Prefilter.



OD 3-1/2"
ID 1-27/32"
Length 7-1/4"

Order No. 19 - 9550

Air filter replaces Toro 93-2195. Fits Toro "Z" series mowers with Kawasaki 22 hp engines. Fits our 19-9616 assembly. Also Fits Kawasaki 12 hp on John Deere Gator M113621 & Kohler 26 hp on Walker.



Order No. 19 - 2843

Replaces Toro 81-4120 for Toro/Suzuki OHV 4-cycle engines.



TORO/WHEEL HORSE (Cont.)



ID 3-1/8" -1"
OD 4-1/8" -2"
Height 3-3/4"

Order No. 19 - 6584

Filter replaces Wheel Horse NN10872. Fits model E125V, (12-1/2 hp) engines.

Order No. 19 - 7419

Prefilter replaces Wheel Horse NN10898

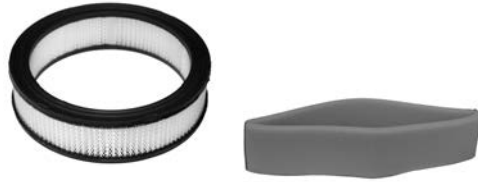

ID 6-1/2"
OD 8-1/4"
Height 2"

Order No. 19 - 2790

Filter replaces Wheel Horse NN10774. Fits models NHA, NHB, B43, P216, P220, P224, NHC, T260 and P218. (16-20 hp) engines.

Order No. 19 - 7050

Prefilter replaces Wheel Horse NN10176.



Order No. 19 - 6680

Replaces Wheel Horse 108335.



Order No. 19 - 9464

Transmission filter replaces Toro E63-3752. Hydrostatic transmission filter has 3/4" - 16 thread, 40 micron, 3-7/8" Height, 3" OD.



Order No. 19 - 9361

Transmission filter replaces Toro E63-3750. Hydrostatic transmission filter has 3/4" - 16 thread, 10 micron, 3-7/8" Height, 3" OD.



Order No. 21 - 2228

Has 7.5" x 7" Hole Mounting. 4 Hole pattern - 5/16" - 18 weld set.

Order No. 21 - 6624

High Back Seat Cover. For our 21-2228 seat.



Order No. 20 - 2235

Vented Fuel Cap. Replaces Toro and Wheel Horse.



Order No. 21 - 13998

Arm rest replaces Hustler 797480, Ariens/Gravely 01552900/715095 kit, Exmark/Toro 107-1887, 110-6569, 108-6163 & 69-1180.



Order No. 20 - 7730

Fuel Tank Bushing replaces Wheel Horse 104047 & Toro 46-6560. MIN010



Order No. 20 - 9700

Oil tank cap replaces Toro E513167.

30

O.E.M.

O.E.M. REPLACEMENT
TORO/WHEEL HORSE (Cont.)



Order No. 20 - 9146

Fuel filter replaces Kubota 12581-43012, Toro 18-1520, Grasshopper 101005. Fits larger horse power models. 10 micron. Fits 5/16" fuel line.



Order No. 20 - 1358

Large in-line two step filter, 1/4" and 5/16" 20-25 Micron. Replaces Toro 71-5960.

Order No. 20 - 11358

Fuel filter. (carded)

MIN005



Order No. 20 - 1349

Fuel Filter replaces Toro No. 56-6360. 75 micron element, 1/4". MIN010



Overall Length 8"

Order No. 20 - 7172

Replaces Toro/Wheel Horse 106945. For 7" tank depth, 2-1/4" diameter.



Order No. 26 - 13037

Starter gear pinion replaces Toro 28-9110. For 2-cycle snowthrower models S200 & S620. 16 tooth.



Order No. 27 - 6966

Replaces Toro 46-3960. For most trimmers using Kioritz engines.



Order No. 28 - 8644

Grass bag replaces Toro 8-2759. Fits Toro 21" heavy duty commercial rear bag.



Order No. 26 - 8769

Starter dog spring replaces Toro 81-1220. Fits 21" Toro walk-behind mowers. MIN010



Order No. 27 - 9226

Replacement spool with line replaces Toro 88192.



Order No. 31 - 8943

Universal Solenoid. Replaces Toro 28-4210, Wheel Horse 110116, 110162 & 110167.

30

O.E.M.



TORO/WHEEL HORSE (Cont.)



Order No. 31 - 5933

Universal Solenoid. Replaces Toro 47-1910, Wheel Horse 110116.

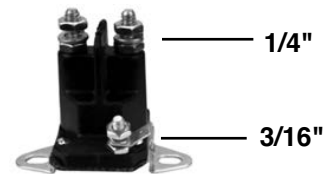

Order No. 31 - 3319

Solenoid. Replaces Wheel Horse 111674



Order No. 31 - 10772

Universal starter solenoid 4 pole, 12 volt. Terminal post will accommodate both 5/16" & 1/4" terminal connectors, Mounting bracket will accommodate both chassis and wall mount configurations. Replaces Toro 47-1910, 110116, 1101162, 110167.



Order No. 31 - 10771

Universal starter solenoid 3 pole, 12 volt. Terminal post will accommodate both 5/16" & 1/4" terminal connectors, Mounting bracket will accommodate both chassis and wall mount configurations. Replaces Toro 111674.

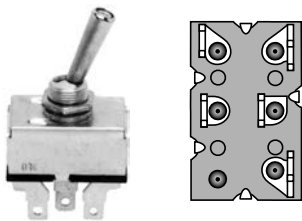

Order No. 31 - 7675

Replaces Toro 92-6328, 37-2610. Mounting hardware included



Order No. 31 - 7976

Switch replaces Toro 29-5560. Fits 32", 36", 37", 44", 52", mid size commercial mowers with pull start. Fits models S200, S620 Snowblowers. Hardware includes 1 nut and 1 lockwasher.



Order No. 31 - 14454

Ignition switch replaces Toro 116-0050. Fits Z500 Z Master. Plastic snap in bezel. 3 position, 5 terminals. Keys not included. Uses our 31-2932 or 31-10794 keys.



Order No. 31 - 14652

Ignition switch replaces Toro 117-2221. Fits most Z Master 2010 and newer, TimeCutter ZS-SS, Titan zero turn mowers. Quest models. Plastic snap in bezel. 3 position, 6 terminals. Keys not included.



Order No. 31 - 14291

Seat switch replaces Toro 92-6282. Normally Open.

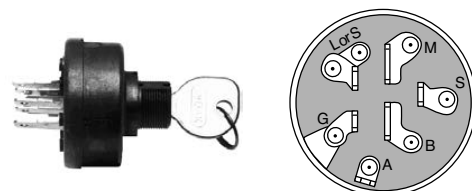

Order No. 31 - 7804

Ignition switch replaces Toro 83-0020.



**O.E.M. REPLACEMENT
TORO/WHEEL HORSE (Cont.)**



Order No. 31 - 9663

Plunger interlock switch replaces Toro 82-2190. Single post, right angle snap mounted. Normally open.

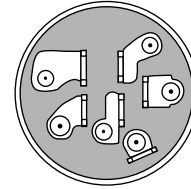

Order No. 31 - 11822

Ignition switch replaces Exmark 103-0206. Also replaces Toro 104-2541 & 88-9830. Fits Lazer Z 60" & 72" Lazer Z XP. 3 position, 6 terminals.

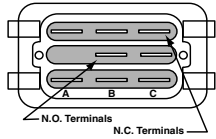

Order No. 31 - 9657

PTO switch replaces Toro 93-9999, 93-9998, 95-4108, 95-7489. Middle terminal blank. Push-pull/Snap in mount. Red Knob.

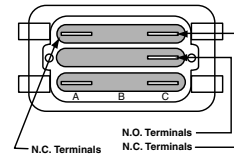

Order No. 31 - 11470

PTO switch replaces Exmark 103-5221. Fits Lazer Z, Turf Tracer, & Turf Ranger Models. Also replaces Ariens 1545600 & Toro 95-7489. Red Knob.

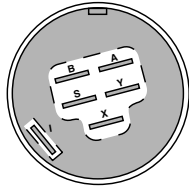

Order No. 31 - 11018

Ignition switch replaces Toro 27-2360. Fits Toro Groundmaster models: 3, 52, 62, 72, 322, 325, 327, 400, 500, RM223D, 450D, 335D, 5100D. Ignition type: Battery, 3 positions, 6 terminals. 9/16" mounting stem.

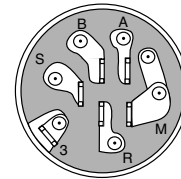

Order No. 31 - 7280

Ignition Switch replaces Toro/Wheel Horse 103991.

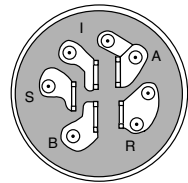

Order No. 31 - 1931

12V Battery Switch-Plug in replaces Wheel Horse 103990.

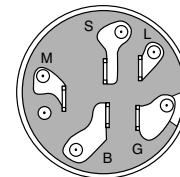

Order No. 31 - 2922

5 Terminal Ignition Switch. Replaces Toro 23-0660. Magneto.

Order No. 41 - 5524

Scraper Bar replaces Toro 55-8760. Fits model CCR2000. 19-1/8" length x 1-15/16" width x 7/8" height x 1/4" mounting holes.



O.E.M. 30



TORO/WHEEL HORSE (Cont.)



Order No. 41 - 5525

Scrapers Bar replaces Toro 71-5390. Fits model CCR1000. 19-5/8" length x 2-1/2" width x 1-1/8" height x 1/4" mounting holes.

Order No. 41 - 5527

Scrapers Bar replaces Toro 75-8780. Fits Toro Powerlite models. 15-3/8" length x 2-1/8" width x 1/4" mounting holes.



Order No. 41 - 5509

Snowblower Paddle replaces Toro 23-3730. Fits models S-200 and 620. 17-5/8" length x 2-5/8" width x 1/4" mounting holes.



Order No. 41 - 5596

Snowblower paddle replaces Toro 84-1980. Made of TICOR material from recycled tires. Resist aging and abrasion, long lasting. Can withstand extreme temperatures. Environmentally friendly construction. USA Made. Similar to our 41-5534.



Order No. 41 - 5597

Snowblower paddle replaces Toro 99-9313. Made of TICOR material from recycled tires. Resist aging and abrasion, long lasting. Can withstand extreme temperatures. Environmentally friendly construction. USA Made. Similar to our 41-5539.



Order No. 41 - 5532

Snowblower Paddle replaces Toro 54-9921. Fits model CCR1000. 21" length x 14-1/8" width x .025 thickness.



Order No. 41 - 5520

Snowblower Paddle replaces Toro 55-9251. Fits model CCR2000. 21-7/8" length x 14-3/8" width x .025 thickness.



Order No. 41 - 5534

Snowblower Paddle replaces Toro 80-0660 & 84-1980. Fits Toro powerlite snowthrowers.



Order No. 41 - 5539

Rotor blade paddle replaces Toro 99-9313. Fits CCR 3000 snowblowers.



Order No. 41 - 8993

Air vane replaces Toro 52-7060. Fits snowblower models S-200 & S-620. Takes 7 per unit.



Order No. 41 - 5585

Universal snowblower skid shoes set. Fits most Toro 2 stage snowthrowers. Eccentric washers allow mounting to a variety of mounting dimensions. Mounting width (min 2", max 3", 5/16" bolt holes. Similar to our 41-8635.

30

O.E.M.



O.E.M. REPLACEMENT
VELKE



ID 7/8" (22.23 mm)
OD 1-1/8" (28.58 mm)
Height 1" (25.40 mm)
Flange OD 1-1/2" (88.10 mm)

Order No. 09 - 5713

Bushing replaces Velke VPIVOT pivot bushing. Used on our 10-8189 support arm.



ID 1/2" (12.70 mm)
OD 3/4" (19.05 mm)
Height 1" (25.4 mm)
Flange OD 15/16" (23.81 mm)

Order No. 09 - 8654

Hitch bushing replaces Velke VHITCHBUSH. Fits Velke 9 x 350 x 4 caster wheel on all one wheel mowers.



Order No. 08 - 9260

Caster wheel for Velke replaces VKXwheel. 9 x 350 x 4, 4 ply traction tread tire with tube. 2-1/4" off centered hub, 3 piece rim, 1" roller cage bearing with zerk fitting. Fits all two wheel Velke's.



Order No. 08 - 8575

Caster Wheel for Velke VKWHEEL. 9 x 350 x 4, 4 ply traction tread tire with tube, 3-1/2" centered hub, 3 piece rim, 3/4" open cage roller bearing, with spanner bushing and zerk fitting. Fits all one wheel Velke's. Uses our replacement tire 08-8636. (painted white)



Order No. 08 - 8694

9 x 350 x 4 L stem tube replaces Velke VK Tube. Fits all Velke one wheel mowers.



Order No. 08 - 8636

9 x 350 x 4, 4 ply tubeless traction tread tire. Replacement tire for our 08-8575 Velke caster wheel.



- 3 Piece Rim
- Solid Foam Tire
- Flat Free

Order No. 08 - 8867

3-1/2" centered hub with 3/4" open cage roller bearing with zerk fitting. Fits all one wheel Velke's. Uses our 08-8865 tire & 09-8670 wheel bearing kit. (Painted white)

Order No. 08 - 8865

9 x 350 x 4 Solid foam traction tread tire is maintenance free, flat free, long lasting, resists cracking, oil and chemical resistant. Made in USA. Constructed of micro-cellular polyurethane insures that it will never loose its form. Used with our 08-8867 wheel assembly.



Order No. 08 - 10816

Solid foam wheel assembly replaces Velke vkxwheel. 9 x 350 x 4. 2-1/4" off set hub, 3 pce rim, 1" roller cage bearings with zerk fitting. Fits 2 wheel Velke's.



OD 1/2"
Length 4-29/32"

Order No. 10 - 8671

Clevis pin replaces Velke VKPIN2-2. Attaches Velke to mower bracket. Fits all one wheel Velkes.



Order No. 10 - 14221

Clevis hitch pin replaces Velke VKPIN2-2. Similar to our 10-8671. OD 1/2" x 4-1/4" length.

30

O.E.M.



VELKE (Cont.)

Size 1/2" - 20
Overall Length 4-29/32"

Order No. 10 - 8651

Wheel bolt kit replaces Velke VKAXLE2-2. Fits 9 x 350 x 4 caster wheel on all one wheel Velkes. Kits includes our **10-8412** washers, **10-8652** wheel bolt, **10-8653** lock nut.



Order No. 10 - 8652

Wheel bolt only for Velke. Fits 9 x 350 x 4 caster wheel on all one wheel Velkes. 1/2" - 20 x 4-29/32"

Order No. 10 - 8653

Lock nut only for Velke. Fits 9 x 350 x 4 caster wheel on all one wheel Velkes. Nylon insert lock nut, zinc plated. 1/2" - 20

MIN010

Order No. 09 - 8670

Wheel bearing kit fits Velke "Sulky" VKBRGKIT midsize commercial mowers. Kit contains our **10-8434** spacer, **09-8668** roller bearing with (2) retainer bushings. Fits our **08-8575** wheel assembly.

Order No. 09 - 8668

Roller cage bearing with retainer bushings only. Roller cage bearing ID 25/32" (19.84 mm), OD 1-11/32" (34.13 mm), Length 2-45/64" (68.66 mm). Retainer bushings ID 49/64" (19.45 mm), OD 1-25/64" (35.32 mm), Height 3/8" (9.53 mm).



Order No. 09 - 9117

Roller cage bearing only for Velke. Replaces Velke VKRLBRG. Used on our **08-8575** wheel assembly. OD 1-11/32" (34.13 mm), ID 25/32" (19.84 mm), Length 2-45/64" (68.65 mm).

Order No. 09 - 8434

Spanner bushing only replaces Velke VKSPNNR. ID 1/2" (12.70 mm), OD 47/64" 18.65 mm), Length 4" (101.6mm).

Overall ID 3/4" (19.05 mm)
Overall OD 1-3/4" (44.45 mm)
Overall Length 2-1/4" (57.15 mm)

Order No. 09 - 9276

Wheel bearing kit replaces Velke VKXGBRGKIT. Fits Velke (2) wheel mowers. Kit contains our **09-9275** roller cage bearing, **09-9009** retainers & **09-9274** spanner bushing. Fits our **08-9260** wheel assembly.



Order No. 09 - 9275

Roller cage bearing only replaces Velke VKXRLBRG. Fits our **08-9260** wheel assembly. ID 1" (25.4 mm), OD 1-3/8" (34.93 mm), Length 1-1/2" (38.1 mm).

Order No. 09 - 9274

Spanner bushing only replaces Velke VKXSPNNR. Fits our **08-9260** wheel assembly. ID 3/4" (19.05 mm), OD 1" (25.4 mm), Length 2-3/4" (44.4 mm).

O.E.M. REPLACEMENT



WALKER



Order No. 08 - 8949

13 x 500 x 6, 4 ply tubeless smooth tread tire. Replaces Walker 7035-1. Fits Walker commercial mowers.



Order No. 08 - 7982

8 x 300 x 4, 4 ply smooth tread tire and tube, 3-1/2" centered hub, zerk fitting with 5/8" open cage roller bearing, our 09-8319. Replaces Walker 5715-4, front wheel on "ZERO TURN". (painted white)

Order No. 08 - 10162

8 x 300 x 4, solid foam tire, 3-1/2" centered hub, zerk fitting with 5/8" open cage roller bearing. Replaces Walker 5715-3. Uses our 08-8864 solid foam tire. (painted white)

Order No. 08 - 8864

8 x 300 x 4, Solid foam tire is maintenance free, flat free, long lasting resists cracking, oil and chemical resistant. Used with our 08-10162 wheel assembly. Replaces Walker 5715-11. **Tire Only.**



30

O.E.M.



Order No. 08 - 11062

13 x 500 -6 Reliance wheel assembly. Mounted on a 6" x 3.25" steel wheel painted silver with 3.75" centered hub length, without bearings. Replaces Walker 4815-4. **No Bearings Included.**



Order No. 09 - 7950

Front wheel bearing replaces Walker 5037. Bearing No. 44F40P.



Order No. 09 - 8211

Caster bushing replaces Walker 5683. Fits all 36", 42", 48", 54" and 62" Walker "ZERO TURN" mowers. (metal)



ID 5/8"
OD 1"

Order No. 09 - 11833

Deck pin bushing replaces Walker 5740-2. Fits 36", 42", 48" & 54" decks. Takes 4 per unit. MIN004



ID 3/4"
OD 1-1/4"

Order No. 09 - 11834

Deck pin bushing replaces Walker 8740. Fits 52" & 62" decks. Takes 4 per unit. MIN004



ID 3/8"
OD 5/8"
Length 3-1/2"

Order No. 09 - 8076

Wheel spacer replaces Walker 5714-3, 5414-3. Used in our 09-8319 wheel bearing kit.



WALKER (Cont.)

Overall ID 5/8" (15.88 mm)
 Overall OD 1-3/8" (34.93 mm)
 Overall Length 3-7/16" (87.33 mm)

Order No. 09 - 8210

Wheel bearing replaces Walker 5714-5. Open cage roller bearing fits front wheel on 36", 42", 48" and 54" "ZERO TURN" machines. Bearings are 5/8" ID (15.88 mm) x 1-3/8" OD (34.93 mm), 2-5/8" length (66.68 mm), bushings are 5/8" ID (15.88 mm) x 1-3/8" OD (34.93 mm). Fits our **08-7982** wheel assembly.



Order No. 09 - 8319

Wheel bearing kit for Walker. Fits front wheel on 36", 42", 48" and 54" "ZERO TURN" machines. Kit contains our **09-8210** bearing and **09-8076** spacer. Fits our **08-7982** wheel assembly and **08-10162** Wheel.

Overall ID 3/8" (9.53 mm)
 Overall OD 1-3/8" (34.93 mm)
 Overall Length 3-9/16" (90.49 mm)

Order No. 09 - 8995

Retainer bushing only for Scag. Used on our Scag wheel assembly **08-3276**. OD 1-3/8" (34.93 mm), ID 5/8" (15.86 mm).

Order No. 09 - 8996

Roller cage bearing only for Walker. Replaces Walker 5714-5. Used on our Walker wheel assembly **08-7982**. OD 1-3/8" (34.93 mm), ID 5/8" (15.86 mm), Length 2-5/8" (66.68 mm).



30

Coil Length 5"
 Overall Length 6-1/8"

Order No. 10 - 8503

Steering lever control return spring replaces Walker 5223. Fits on all Walker "ZERO TURN" mowers.



O.E.M.

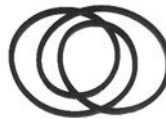

Order No.	Description
12 - 8798	Ground Drive Belt. Replaces Walker 7235. 1/2" (12.70 mm) x 47.08" (1195.83 mm). Fits Hydro Pro model T. V-belt, double cogged, Dacron cord construction.
12 - 10322	Ground Drive Belt. Replaces Walker 7248. 9/16" (14.3mm) x 47" (1193.8 mm). Fits hydros after 1996. 4 Rib poly-belt, polyester cord.
12 - 8819	Blower Belt. Replaces Walker 7234. 3/8" (9.53 mm) x 28" (711.2 mm). Fits model T blower. Cogged belt, Polyester cord construction.
12 - 10321	Blower Belt. Replaces Walker 7234-1. 9/16" (14.3mm) x 28-17/32" (724.7 mm). Fits new style blowers. 4 Rib poly, *Aramid Cord.
12 - 8820	PTO Belt. Replaces Walker 6231. 3/8" (9.53 mm) x 35.5" (901.7 mm). Fits model T. Cogged belt, Polyester cord construction.
12 - 10323	PTO Drive Belt. Replaces Walker 8230. 1-1/4" (31.75mm) x 40-7/16" (1031 mm). Triple belt fits T models. Laminated Aramid cord construction.
12 - 10320	PTO Triple Belt. Replaces Walker 7230. 1-1/4" (31.75mm) x 38" (965.2 mm). Fits Diesel units. *Aramid Cord, wrapped clutching cover.
12 - 12246	PTO Drive Belt. Replaces Walker 6250. 3/8" (9.53 mm) x 37-1/2" (952.5 mm). Raw edge cog, polyester cord construction.



O.E.M. REPLACEMENT

WALKER (Cont.)



ID 3/8"
OD 3-1/4"
Height 7/8"

Order No. 13 - 9537

Idle pulley replaces Walker 5245. Fits model MT.



10 - 24

Order No. 17 - 8802

Nut replaces Walker F002. Fits our 17-6793 blade hub. Used with our 17-8801 bolt. Zinc plated, low carbon steel. MIN010



Order No. 17 - 6793

Blade Hub. Replaces Walker 5706.



10 - 24 x 5/8"

Order No. 17 - 8801

Bolt replaces Walker F202. Fits our 17-6793 blade hub. Used with our 17-8802 nut. Stainless steel. MIN010



Order No. 17 - 10019

Blade adapter kit fits Walker. Kit contains our (1) 17-6793, (2) 17-8802, (2) 17-8801.

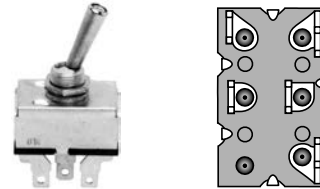

Order No. 31 - 7675

PTO switch. Replaces Walker 6950. Mounting hardware included.

Order No. 31 - 9369



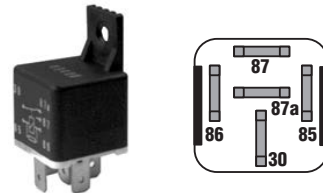

Relay replaces Walker 6942. Open to run.



ORDER NO.	REPLACES O.E.M. NO.	LENGTH	CENTER HOLE DIAM.	OUTSIDE HOLE DIAM.	CENTER TO CENTER	WIDTH	STEEL THICK.	APPLICATION
15 - 3423	5705-0	20" 508mm	5/8" 15.9mm	3/16" 4.8mm	3" 76.2mm	2-3/4" 69.9mm	.160" 4.1mm	Uses (3) blades for 54" side discharge Right hand
15 - 6176	5705-10	21" 533.4mm	5/8" 15.9mm	7/32"	3" 76.2mm	2-3/4" 69.9mm	.160" 4.1mm	(2) 15-6176 & (2) 15-6177 for 42" cut Mulcher Lower blade.
15 - 6177	5705-11	21-15/16" 533.4mm	5/8" 15.9mm	7/32"	3" 76.2mm	2-3/4" 69.9mm	.160" 4.1mm	(3) 15-6177 & (3) 15-3446 for 62" Mulcher cut (2) 15-6176 & (2) 15-6177 for 42" cut. Milled bottom Mulcher, Upper blade
15 - 3445	5705-4	22" 558.8mm	5/8" 15.9mm	3/16" 4.8mm	3" 76.2mm	2-3/4" 69.9mm	.187" 4.8mm	(1)15-3445 & (1) 15-3446 (G.H.S.) Grass Handling System. Fits 42" cut rear discharge Left hand





WALKER (Cont.)

ORDER NO.	REPLACES O.E.M. NO.	LENGTH	CENTER HOLE DIAM.	OUTSIDE HOLE DIAM.	CENTER TO CENTER	WIDTH	STEEL THICK.	APPLICATION
 15 - 3446	5705-3	22" 558.8mm	5/8" 15.9mm	3/16" 4.8mm	3" 76.2mm	2-3/4" 69.9mm	.187" 4.8mm	(3) 15-6177 & (3) 15-3446 for 62" mulcher cut. Fits 42" cut. Rear and side discharge Right hand. Also fits (3) blades for 62"
 15 - 6414	5705-3	22" 558.8mm	5/8" 15.9mm	3/16" 4.8mm	3" 76.2mm	2-3/4" 69.9mm	.160" 4.1mm	Mulching Blade PATENTED
 15 - 6169	7705-2	25-1/16" 636.6mm	5/8" 15.9mm	7/32" 5.6mm	3" 76.2mm	2-3/4" 69.9mm	.160" 4.1mm	(1) 15-6169 & (1) 15-6170 for 48" cut Left hand cut
 15 - 6170	7705-1	25-1/16" 636.6mm	5/8" 15.9mm	7/32" 5.6mm	3" 76.2mm	2-3/4" 69.9mm	.160" 4.1mm	(1) 15-6169 & (1) 15-6170 for 48" cut Right hand cut

30

O.E.M.

WIKOV-SLAVIA

ORDER NO.	REPLACES O.E.M. NO.	LENGTH	CENTER HOLE DIAM.	OUTSIDE HOLE DIAM.	CENTER TO CENTER	WIDTH	STEEL THICK.	APPLICATION
 15 - 50241	DO226	20-9/16" 522.28mm	25/64" 9.92mm	9/32" 7.14mm	2-29/32" 73.81mm	2-3/16" 55.56mm	.160" 4.00mm	Rear discharge blade- (1) 50241 & (1) 50241 makes a set. Left hand.
 15 - 50245	DO225	20-9/16" 522.28mm	25/64" 9.92mm	9.32" 7.14mm	2-29/32" 73.81mm	2-3/16" 55.56mm	.160" 4.00mm	Rear discharge blade- (1) 50241 & (1) 50241 makes a set. Right hand.

O.E.M. REPLACEMENT



WOODS



ID 1" (25.40 mm)
OD 2" (50.80 mm)
Height 27/32" (21.43 mm)

Order No. 09 - 8488

Bearing replaces Woods 70006. Fits spindle assembly on 50", 42", 30" cut "ZERO TURN". Bearing No. RA100RR.



Order No. 10 - 14495

Electric clutch replaces Woods 73558, 74075. Warner 5218-58, 5218-26. 1-1/8" ID, 3-1/2" height, 1/2" belt, 4-7/8" pulley.



OD 1-1/8"
ID 1/2"
Length 3-3/8"

Order No. 20 - 13536

Fuel filter replaces Kubota 15231-443560, Woods 70666, Grasshopper 101000, Jacobsen 550489, Walker 70221. Fits models G4200, G5200, G6200, B1550, B20, B1500, B1750-B7100; all B series and older G series 29 tractor models.

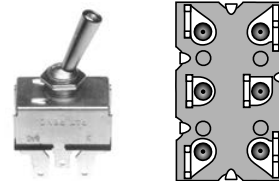

Order No. 31 - 7922

PTO switch. Replaces Woods 70422. Fits 936 series YT tractor models 936002, 936003, 936004, 936005, 936006, 936008, 936009, 936010, 936011, & 936012. Mounting hardware included.







30

O.E.M.

ORDER NO.	REPLACES O.E.M. NO.	LENGTH	CENTER HOLE DIAM.	OUTSIDE HOLE DIAM.	CENTER TO CENTER	WIDTH	STEEL THICK.	APPLICATION
15 - 3377	70014	15" 381mm	1/2" 12.7mm			2" 50.8mm	.204" 5.2mm	(3) blades for 44" cut Standard Lift
15 - 3378	70062	15" 381mm	1/2" 12.7mm			2" 50.8mm	.204" 5.2mm	(3) blades for 44" cut High Lift
15 - 3379	70104	18" 457.2mm	1/2" 12.7mm			2" 50.8mm	.204" 5.2mm	(3) blades for 52" cut Standard Lift
15 - 6309		18" 457.2mm	1/2" 12.7mm			2-1/2" 63.5mm	.204" 5.2mm	Mulching Blade PATENTED
15 - 3380	70117	18" 457.2mm	1/2" 12.7mm			2" 50.8mm	.204" 5.2mm	(3) blades for 52" cut High Lift
15 - 3421	23825	20-5/32" 512mm	5/8" 15.9mm			2" 50.8mm	.204" 5.2mm	(3) blades for 60" cut For models RM-59 & L-59 Left hand cut (ccw)
15 - 6467	6950	20-3/16" 512.7mm	5/8" 15.8mm			2" 50.8mm	.204" 5.2mm	(3) blades for 60" cut. Fits model 59C2. Medium Lift.
15 - 6432	31359	20-1/4" 514.4mm	5/8" 15.9mm			2" 50.8mm	.204" 5.2mm	(3) blades for 60" cut. Fits models RM59, RM500, L59 & F35. High Lift Blade. Left hand cut.





WOODS (Cont.)

ORDER NO.	REPLACES O.E.M. NO.	LENGTH	CENTER HOLE DIAM.	OUTSIDE HOLE DIAM.	CENTER TO CENTER	WIDTH	STEEL THICK.	APPLICATION
 15 - 6433	34615	20-11/16" 525.5mm	5/8" 15.9mm			2-1/2" 63.5mm	.240" 6.1mm	(3) blades for 60" cut. Fits new Tunnel Deck. Models RM360 & RM550. High lift. Right hand cut.
 15 - 3424	70142	21" 533.4mm	1/2" 12.7mm			2" 50.8mm	.204" 5.2mm	(3) blades for 61" cut High Lift
 15 - 6167	70134	21" 533.4mm	1/2" 12.7mm			2-1/2" 63.5mm	.240" 6.1mm	(Heavy Duty) (3) blades for 61" cut Regular Lift
 15 - 6168	70142	21" 533.4mm	1/2" 12.7mm			2-1/2" 63.5mm	.240" 6.1mm	(Heavy Duty) (3) blades for 61" cut High Lift
 15 - 6311		21" 533.4mm	1/2" 12.7mm			2-1/2" 63.5mm	.204" 5.2mm	Mulching Blade PATENTED
 15 - 6210	13404 31306	24-1/2" 622.3mm	1" 25.4mm			2-1/2" 63.5mm	.204" 5.2mm	Left hand cut (3) blades for 72" cut. Fits models L306, RM306, RM600
 15 - 6434	15127	24-11/16" 635mm	5/8" 22.2mm			2-1/2" 63.5mm	.240" 6.1mm	(3) blades for 72" cut. Fits new Tunnel Deck. Models RM372 & RM660. High lift.

30
O.E.M.

WOLF

 15 - 50121	171051	19-31/32" 507.21mm	1.278" 32.54mm	.21" 5.56mm	1.92" 48.82mm	3" 76.20mm	.095" 2.77mm	
 15 - 50122	171046	460 mm	1.278" 32.54mm	.21" 5.56mm	1.92" 48.82mm		.095" 2.77mm	

O.E.M. REPLACEMENT



YAZOO



Order No. 06 - 6675

6 x 1.66, replaces Yazoo 2302-023. 1/2 ball bearing; offset hub. Fits 20", 22", 24" and 26" High Wheel Mowers. (painted yellow)



ID 5/8"
Width 2-3/4"
Heigh 5"

Order No. 07 - 6917

Deck Wheel replaces Yazoo. 2-1/2" offset hub.



ID 1/2"
Width 1-1/2"
Heigh 4"

Order No. 07 - 6914

Deck Wheel replaces Yazoo 2302-126. 1-1/2" offset hub.



3/8" Axle
3-1/2" Hub Length

Order No. 07 - 5900

16" Mag Wheel. Replaces Yazoo 2302-100.

Order No. 07 - 5899

20" Mag Wheel. Replaces Yazoo 2302-099.

Order No. 09 - 5901

Axle Kit for 16" & 20" Yazoo Mag Wheel.



ID 3/4" (19.05 mm)
OD 1-25/32" (45.24 mm)
Height 19/32" (15.08 mm)

Order No. 09 - 484

Replaces Yazoo 204-060. 3/4" ID x 1-25/32" OD, 19/32" wide. Used on our 10-7154 shaft. Bearing No. 9504-ZZ.



ID 5/8" (15.88 mm)
OD 1-9/16" (39.69 mm)
Height 15/32" (11.91 mm)

Order No. 09 - 483

Replaces Yazoo 204-019. Bearing No. 6203-2RS.



Order No. 17 - 2947

Replaces Yazoo 101-002. Blade Adaptor. OD 1-3/4"



Order No.

Description

12 - 7894

Engine to Blade Belt replaces Yazoo 205-505. AA section belt, length 80-1/8". Red Rider rear engine rider. *Aramid fiber.

12 - 10823

Deck Belt. Replaces Yazoo/Kees 104335. 5/8" (15.9 mm) x 163-1/2" (4152.9 mm). Fits 52" Max 2 series "ZERO TURN" also replaces Husqvarna 539-104335 XP large frame mowers. Raw edge, laminated, aramid cord construction.

12 - 10824

Deck Belt. Replaces Yazoo/Kees 104336. 5/8" (15.9 mm) x 183-3/8" (4657.7 mm). Fits 61" Max 2 series "ZERO TURN" & Husqvarna 539-104336 XP large frame mowers. Raw edge, laminated, aramid cord construction.

12 - 10825

Deck Belt. Replaces Yazoo/Kees 105477. 5/8" (15.9 mm) x 198-1/2" (5041.9 mm). Fits 72" Max 2 series "ZERO TURN" & Husqvarna 539-105477 large frame mowers. Raw edge, laminated, aramid cord construction.





YAZOO (Cont.)

ID 3/8"
OD 2-3/4"
Height 1-3/8"



Order No. 13 - 9753

Idler pulley replaces Exmark 323285. Also replaces Yazoo Kees 639-19087.

ORDER NO.	REPLACES O.E.M. NO.	LENGTH	CENTER HOLE DIAM.	OUTSIDE HOLE DIAM.	CENTER TO CENTER	WIDTH	STEEL THICK.	APPLICATION
 15 - 824	206-760	20-7/8" 530.2mm	1-1/4" x 3/4"	5/16" 7.9mm	3" 76.2mm	2-1/4" 57.2mm	.240" 6.1mm	(3) blades for 60" cut Left hand cut
 15 - 6284	206-660	20-3/4" 527.1mm	1-1/4" x 3/4"			2-1/4" 57.2mm	.240" 6.1mm	(3) blades for 60" RH cut
 15 - 9176	206-622	22" 558.8mm	1-1/4" x 3/4"		57.2mm	2-1/4" 6.1mm	.240"	Fits 22" walkbehind.

30
O.E.M.



Order No. 19 - 9361

Transmission filter replaces Yazoo-Kees 101164. Hydrostatic transmission filter has 3/4" - 16 thread, 10 micron, 3-7/8" Height, 3" OD.

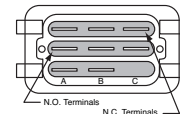

Order No. 31 - 9656

PTO switch replaces Yazoo 101768. Push-pull/Snap in mount. Corner terminal blank. Red knob.

O.E.M. REPLACEMENT



VIKING

30
O.E.M.

Conduit 54"
Inner Wire 56-1/4"
Wire Travel 2-1/4"



Order No. 03 - 12218

Throttle cable replaces Exmark 1-633696. Fits Metro HP, Turf Tracer, Viking, Lazer & Turf Ranger models.

ID 21/32" (16.67 mm)
OD 1-9/16" (39.69 mm)
Height 15/32" (11.91 mm)



Order No. 09 - 8507

Bearing replaces Viking 6109-001-2008. Homeowners model. Bearing No. 6203-2RS.



Order No. 10 - 8548

Mandrel housing replaces Viking 6109-004-2009. Housing only for our 10-8479 quill assembly.



Order No. 10 - 8549

Mandrel shaft replaces Viking 6109-004-2010. 3/4" OD Shaft, 7" long. Comes with our 09-442 bearing.



Order No. 12 - 6900

Replaces Viking 6109-004-1009. 80" length (2032 mm) x 1/2" (12.70 mm) Covered.

Order No. 12 - 6901

Blade Drive Belt. Replaces Viking 6109-004-1003. 79.10" length (2006.60 mm) x 17/32" (13.49 mm). Fits 18 hp rider tractors with electric clutch. Also fits 36", 38" & 44". Covered.

Order No. 12 - 6902

Transmission Belt. Replaces Viking 6109-004-1012. 90" length (2286 mm) x 1/2" (12.70 mm). Fits 38" cut. Covered.

Order No. 12 - 7536

Replaces Viking 6109-004-1011. 93" length (2362.20 mm) x 1/2" (12.70 mm) "A" series belt A091. *Aramid fiber.

Order No. 12 - 8463

Deck Belt. Replaces Viking 6109-004-2131. 1/2" length (12.70 mm) x 78-1/2" (1993.90 mm). Fits 10 hp 36" cut & 11 hp 36" cut. Front engine riders. Covered.

Order No. 12 - 8463

Deck Belt. Replaces Viking 6109-004-2007. 1/2" length (12.70 mm) x 92-1/2" (2349.50 mm). Fits 12, 12.5 & 14 hp 42" cut. Front engine riders. Covered.

Order No. 12 - 8784

Deck Belt. Replaces Viking 6109-004-2736. 1/2" length (12.70 mm) x 95.25" (2419.4 mm). Secondary deck drive belt for 50" cut. *Aramid fiber. Covered.

*Made with KEVLAR® or non-trade marked Aramid fiber.



VIKING (Cont.)

ORDER NO.	REPLACES O.E.M. NO.	LENGTH	CENTER HOLE DIAM.	OUTSIDE HOLE DIAM.	CENTER TO CENTER	WIDTH	STEEL THICK.	APPLICATION
 15 - 6195	6109-004-1006	17-3/8" 441.3mm	3/8" 9.5mm			2-1/4" 57.2mm	.187" 4.8mm	(3) blades for 50" cut front engine lawn tractor
 15 - 6123	6109-004-2127	18" 457.2mm	5 point star			2-1/4" 57.2mm	.150" 3.8mm	(2) blades for 36" cut
 15 - 6120	6109-004-1002	18-1/4" 462mm	3/8" 9.5mm			2-1/4" 57.2mm	.187" 4.8mm	(2) blades for 36" cut
 15 - 6105	6109-004-1001	19-1/4" 489mm	3/8" 9.5mm			2-1/4" 57.2mm	.187" 4.8mm	(2) blades for 38" cut
 15 - 6099	309070 303065	20-1/4" 514.4mm	3/8" 9.5mm			2-3/4" 69.9mm	.134" 3.4mm	Fits model A4016-030 (2) blades for 40" cut
 15 - 6125	6109-004-2012	21" 533.4mm	5 point star			2-1/4" 57.2mm	.150" 3.8mm	(2) blades for 42" cut
 15 - 6468	325751	29-7/8" 758.8mm	2-1/2" 63.5mm	390x.940"	2.708" 68.3mm	2-3/4" 69.9mm	.187" 4.8mm	

30
O.E.M.

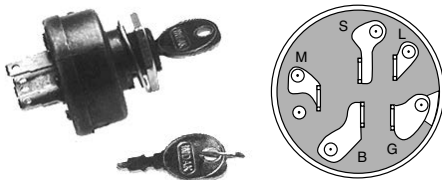

Order No. 31 - 2922

Ignition Switch replaces Viking 6109-004-1033. (magneto).

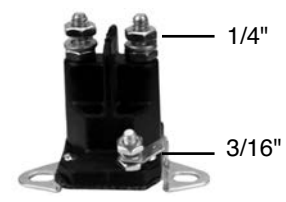

Order No. 31 - 3319

Solenoid, replaces Viking 6120-430-0500.

Order No. 31 - 9664

Plunger interlock switch replaces Viking 6120-430-0220.
Single post, right angle snap mounted. Normally closed.



O.E.M. REPLACEMENT



AYP - SEARS/ROPER/HUSKY/POULAN (Cont.)

30
O.E.M.

ORDER NO.	REPLACES O.E.M. NO.	LENGTH	CENTER HOLE DIAM.	OUTSIDE HOLE DIAM.	CENTER TO CENTER	WIDTH	STEEL THICK.	APPLICATION
15 - 6106	103524X	21-3/4" 553.5mm	3/8" 9.5mm			2-1/2" 63.5mm	.150" 3.8mm	For 22" walk behind
15 - 1044	56401 8021	21-3/4" 553.5mm	5/8" 15.9mm			2-1/2" 63.5mm	.150" 3.8mm	
15 - 6236	406713 192682 157101 335256 114886 141114	22" 558.8mm	5/8" 15.9mm	3/8" 9.5mm	1-7/8" 47.6mm	2-1/4" 57.2mm	.134" 3.4mm	Blade for 22" cut, side discharge mulching mower. Fits models HW706D, HW906D, HWRBSP22525A, HWT450A, HWT450B, J455SDE, J555RDEB.
15 - 13023	420463 421825	22" 558.8mm	5 point star			2-1/2" 63.5mm	.134" 3.4mm	Fits Craftsman/Husqvarna. 22" Walk behind mowers.
15 - 12242	405380	23" 584.2mm	5 point star			2-3/4" 69.9mm	.150" 3.8mm	Fits 2007 models (2) blades for a 46" cut. Standard Lift Blade
15 - 12721	403107	23" 584.2mm	5 point star			2-1/4" 57.2mm	.150" 3.8mm	(2) blades for a 46" cut. Mulching Blade. PATENTED
15 - 12974	403107	23" 584.2mm	5 point star			2-1/4" 57.2mm	.187" 4.8mm	(2) blades for a 46" cut. (Heavy Duty) Blade.
15 - 12957	419274	29-5/8" 752.47mm	5 point star			2-1/4" 57.2mm	.170" 4.3mm	Fits 30" model PXT12530 960460008.

Order No. 17 - 8752

Blade adapter replaces AYP 850977. Fits models 1B101C, 3H302C, 2A271D and AYP 2033A59. For 20" & 22" walk behind mowers.

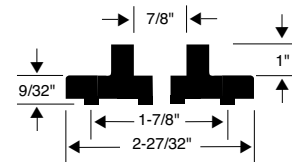

Order No. 17 - 8753

Blade adapter replaces AYP 851514. Fits models 4H472C, WE9656RD, 3M402A, 44W4B2A and YSC7K402C. For 22" self propelled mowers. Also fits Noma, Sears, Wizard and Husky

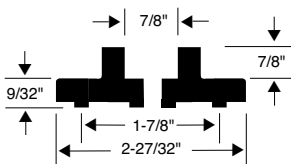

ID 5/8"
Length 2-27/32"
Width 2"

Order No. 17 - 1152

Replaces Sears 87711X00, 87711X004, 69226, 84918, 80104.



AYP - SEARS/ROPER/HUSKY/POULAN (Cont.)



3/8" - 24 x 1-1/4" LH

Order No. 17 - 12728

Blade Adapter replaces AYP 193707, 184590. 25mm.



Length ID 7/8"
Width ID 5/8"
OD 1-7/8"

Order No. 17 - 423

Safety washer. Replaces Sears 1044-R.



Order No. 17 - 9586

Blade bolt replaces AYP 165484. Blade bolt for our 10-9574 spindle assembly. Left hand thread.



Size 7/16"

Order No. 17 - 12280

Blade bolt with washer replaces AYP 174365. Used with our 10-11014 & 10-11590 spindles. MIN005



Order No. 17 - 14457

Blade bolt with washer replaces AYP 193003, Husqvarna 532-1930-03. Fits our 10-11014, 10-11590 & 10-12734 spindle assemblies. 1-1/4" x 7/16"-20.



Order No. 20 - 12440

Primer assembly with plate replaces Poulan 530-038874. Fits models 111, 114, 115, 165, 175, 176, 185, 185R, 195, 196, BC2400, BC24W, BC308, BC3100, GT115, thru 19, 52, LT17, HP22, 28, XT125, 20, 30, 40, 45, 50, 85, 7000 and 7500 series gas trimmers. Mounting plate size: 1-5/16" L x 1" W, (2) line primer.



Order No. 20 - 12642

Primer assembly with plate replaces Poulan 530-071835. Mounting plate size: 1-3/8" L x 13/16" W, (2) line primer.

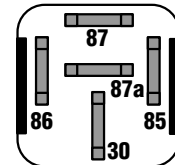

Order No. 31 - 9369

Relay replaces AYP 109748X. Fits several AYP riders.



Order No. 31 - 12091

Seat switch replaces AYP 401545. Used on 2006-up riders.



Order No. 31 - 9733

Headlight switch replaces AYP 110712X.

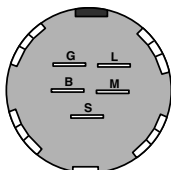

Order No. 31 - 9654

Multi-application ignition switch replaces AYP 178744, 144921, 163088. Thread mounted. With running lights. Uses our 31-9668 nut & our 31-9667 key.



Order No. 31 - 2922

Ignition Switch replaces AYP STD365402. (Magneto).

30

O.E.M.

O.E.M. REPLACEMENT



AYP - SEARS/ROPER/HUSKY/POULAN (Cont.)



Order No. 31 - 2942

Replaces Roper/Sears 365401R. Also replaces Switch 74R, 2210R, 5797H, 7486H, 9541H, 21037, 71577, 72841 and 511404.



Order No. 31 - 2941

Replaces Roper/Sears 14615, 73232. (Magneto)

30

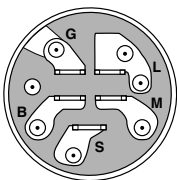

Order No. 31 - 9158

Ignition switch kit replaces AYP 158913.

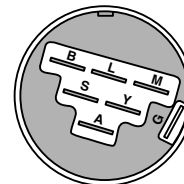

Order No. 31 - 9623

Ignition switch replaces Murray 92556, MTD 725-1717 and AYP 140301. For engines equipped with fuel shut-off solenoid built since 1994. Used on Murray mowers. Includes key, lock-washer nut & cover, 6 post.

O.E.M.

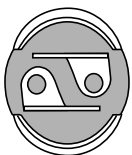

Order No. 31 - 9622

Multi-application start ignition switch only fits AYP. Includes key, lockwasher nut. 2 terminals/ 2 positions.

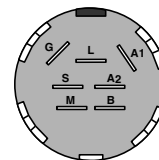

Order No. 31 - 7015

Ignition switch replaces AYP 175566, 163968.

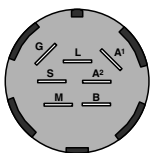

Order No. 31 - 12327

Ignition switch replaces AYP 193350. Used on 2006 - up riders.



Order No. 31 - 12685

Heavy duty ignition switch with keys replaces AYP 175566 & 163968. Similar to our 31-7015 but heavy duty.



Order No. 31 - 9664

Plunger Interlock switch replaces AYP 121305X. Single post, right angle snap in mounted. Normally closed.

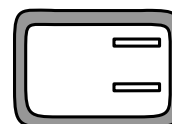

Order No. 31 - 9658

Plunger Interlock switch replaces AYP 109869X Single pole, normally closed.



AYP - SEARS/ROPER/HUSKY/POULAN (Cont.)



Order No. 29 - 8620

Tiller tine set. Set contains (8) of our 29-8610 left hand & 29-8611 right hand tiller tines, (32) of our 29-8621 cap screw, 29-8622 hex nut, 29-8623 lock washer.

Order No. 29 - 8610

Left hand tiller tine replaces Roper 449J/6554J. Three 3/8" bolt holes, 2-5/8" or 3-1/8" center to center, 12" bolo tine.

Order No. 29 - 8611

Right hand tiller tine replaces Roper 4460J/6555J. Three 3/8" bolt holes, 2-5/8" or 3-1/8" center to center, 12" bolo tine.



Order No. 29 - 8621

Cap screw for our 29-8620 tiller tine set. 3/8" - 1, grade 5 cap screw. **Packaged in lots of 10.** MIN010



Order No. 17 - 141

Lock washer for our 29-8620 tiller tine set. 3/8" zinc lock washer. **Packaged in lots of 10.** MIN010



Order No. 29 - 8622

Hex nut for our 29-8620 tiller tine set. 3/8" - 16 zinc hex nut. **Packaged in lots of 10.** MIN010

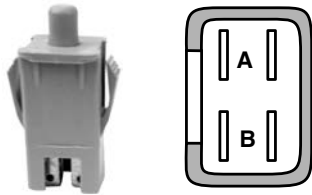

Order No. 31 - 9665

Plunger Interlock switch replaces AYP 161343, 176138, 153664. Double pole, snap in mount. Normally open/normally closed.

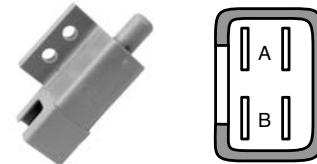

Order No. 31 - 9659

Plunger Interlock switch replaces AYP 109553X. Double pole, normally open / normally closed.



Order No. 31 - 9777

PTO switch retaining ring replaces AYP 140405. Used with our 31-9656. **Packaged in lots of 5.** MIN005

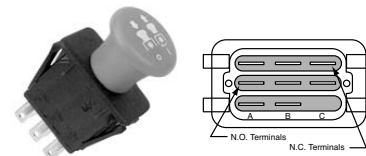

Order No. 31 - 9656

PTO switch replaces AYP 174651, 174652, 174653, 146283, 140404, 154959, 154963, 169416, 169417. Push-pull/Snap in mount. Corner terminal blank. Red Knob.

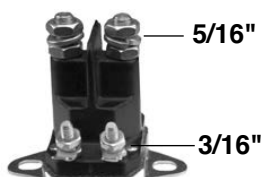

Order No. 31 - 8943

Universal Solenoid. Replaces AYP 146154.



Order No. 31 - 5933

Universal Solenoid. Replaces AYP 146154.

30

O.E.M.

O.E.M. REPLACEMENT



AYP - SEARS/ROPER/HUSKY/POULAN (Cont.)

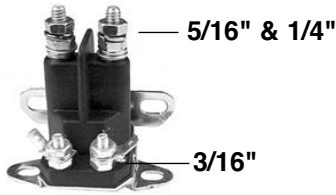

Order No. 31 - 10772

Universal starter solenoid 4 pole, 12 volt. Terminal post will accommodate both 5/16" & 1/4" terminal connectors, Mounting bracket will accommodate both chassis and wall mount configurations. Replaces AYP 109081X, 109946, 146154.



Order No. 31 - 14222

Solenoid starter replaces Husqvarna/AYP 192507. No hardware, 1/4" terminal studs.

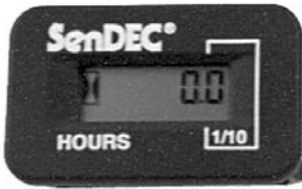

Order No. 33 - 10408

Sendec digital hour meter. Small panel mount. Used on several riders. Replaces AYP 169642, 177501, 110940X.



Order No. 39 - 12748

Starter pulley replaces Poulan 530-069313. Fits gas saw models 2200, 2500, 255, 2600, 2750, 2900, 295, 3050, 310, 315. Also fits Husqvarna models 136 & 141.



Order No. 41 - 5589

Snowblower skid replaces AYP 174762X431 & 532174762. Left hand.



Order No. 41 - 5590

Snowblower skid replaces AYP 178777X431 & 532178777. Right hand.



Order No. 41 - 13169

Snowblower paddle set for Sears/Noma. Fits Craftsman and all Sears 22" model numbers: 536.88150, 538.885210 that do not have replacement paddles.



Order No. 41 - 5585

Universal snowblower skid shoes set. Fits most AYP. 2 stage snowthrowers. Eccentric washers allow mounting to a variety of mounting dimensions. Mounting width (min 2", max 3", 5/16" bolt holes. Similar to our 41-8635.

Order No. 41 - 13397

Shear bolt and nut set replaces AYP 188243. Also replaces 192090, 198636, 179828, 187494, 532179828, 532187494, 532188243. 1/4 - 20 threads, 2" long. Set of 6.



30
O.E.M.



O.E.M. REPLACEMENT

BAD BOY



ID 5/8"
Width 2-3/4"
Height 5"

Order No. 07 - 6917

5" x 2-3/4" Deck Wheel. Replaces Bad Boy 022-5234-98. Uses our **09-8586** bushing.



- 1 Piece Rim
- Flat Proof
- Semi Pneumatic

Order No. 08 - 10286

13 x 650-6 Reliance tire mounted on a 6 x 4.50" steel wheel. 7.25" centered hub with 3/4" cups pressed in for tapered roller bearings. Replaces Bad Boy. (Painted White) Uses our **09-813** bearing or our **09-9944** bearing kit. **No bearings Included.**

Order No. 09 - 814

Replaces Bad Boy 010-7001-000. Bearing No. L44610, L44643.



ID 1" (25.40 mm)
OD 1-31/32" (50.01 mm)
Height 19/32" (15.08 mm)



ID 5/8" (15.88 mm)
OD 1-3/8" (34.93 mm)
Height 7/16" (11.11 mm)

Order No. 09 - 8199

High speed bearing, double sealed replaces Bad Boy 022-7009-00 / 022-70090-00. Bearing No. 99502H-2RSNR.

Order No. 09 - 18199

High speed bearing. (carded) MIN005



ID 5/8" (15.88 mm)
OD 1-3/8" (34.93 mm)
Height 7/16" (11.11 mm)

Order No. 09 - 481

Premium High Speed Bearing, double sealed. Replaces Bad Boy 022-7009-00 / 022-70090-00. Bearing No. 99502H-2RS (NR)



ID 5/8" (15.88 mm)
OD 1-3/8" (34.93 mm)
Height 7/16" (11.11 mm)

Order No. 09 - 8831

Spindle bearing replaces Bad Boy 022-7009-00 / 022-70090-00.



Order No. 10 - 11237

Electric PTO clutch replaces Bad Boy 070-5035-00, For 25hp engines. 6.25" Dia. Pulley. 5/8" Belt, shaft size 1-1/8". Warner 5218-65.

Spindle Assembly for BAD BOY



Order No. 10 - 13090

Spindle assembly replaces Bad Boy 037-6016-00. Long shaft, fits models 2004 and Up.



Order No. 10 - 13089

Spindle assembly replaces Bad Boy 037-6015-00 / 037-6015-50. Old style, fits CZT models 2010-2012.

30

O.E.M.

O.E.M. REPLACEMENT



BAD BOY

Order No. 12 - 7659

114" (2895.60mm) x 5/8" (15.88mm). Replaces Bad Boy 041-5200-00.



ID 1/2"
OD 5-3/4"
Height 2-23/64"



ID 1/2"
OD 4-3/4"
Height 1-1/4"

Order No. 13 - 12722









Idler pulley replaces Bad Boy 033-5001-00.

Order No. 13 - 9891

Idler pulley replaces Bad Boy 033-6001-00. Heavy Duty.



30

O.E.M.

ORDER NO.	REPLACES O.E.M. NO.	LENGTH	CENTER HOLE DIAM.	OUTSIDE HOLE DIAM.	CENTER TO CENTER	WIDTH	STEEL THICK.	APPLICATION
 15 - 2172	038-4820-00	16-1/4" 412.8mm	5/8" 15.9mm	11/32" 8.7mm	1-5/8" 41.3mm	2-1/2" 63.5mm	.240" 6.1mm	(Heavy Duty) (2) blades for 32" cut. (3) blades for 48" cut.
 15 - 6300	038-5350-0050	16-1/2" 419.1mm	5/8" 15.8mm			2-1/2" 63.5mm	.204" 5.2mm	Commercial Mulching Blade (3) blades for 50" cut
 15 - 6294		18" 457.2mm	5/8" 15.9mm			2-1/2" 63.5mm	.204" 5.2mm	Commercial Mulching Blade
 15 - 2173	038-3000-00	18" 457.2mm	5/8" 15.9mm			2-1/2" 63.5mm	.240" 6.1mm	(Heavy Duty) (2) blades for 36" cut (3) blades for 52" cut
 15 - 10667	038-6060-00 038-6050-00 038-2007-00	20-1/2" 520.7mm	5/8" 15.9mm			2-1/2" 63.5mm	.204" 5.2mm	Notched High Lift blade. (3) blades for a 60" cut.
 15 - 6303		20-1/2" 520.7mm	5/8" 15.9mm			2-1/2" 63.5mm	.204" 5.2mm	Commercial Mulching Blade
 15 - 6180	9383	20-1/2" 520.7mm	5/8" 15.9mm			2-1/2" 63.5mm	.240" 6.1mm	(3) blades for 60" cut
 15 - 6404	038-7202-00	24" 609.6mm	5/8" 15.9mm			2-1/2" 63.5mm	.240" 6.1mm	(3) blades for 72" cut.
 15 - 6833	038-7202-00	24" 609.6mm	5/8" 15.9mm			3" 76.2mm	.240" 6.1mm	(3) blades for 72" cut. (Heavy Duty)



BAD BOY (Cont.)

ORDER NO.	REPLACES O.E.M. NO.	LENGTH	CENTER HOLE DIAM.	OUTSIDE HOLE DIAM.	CENTER TO CENTER	WIDTH	STEEL THICK.	APPLICATION
15 - 6026 	038-7220-00	24-1/2"	5/8"			2-1/2"	.204"	(3) blades for 72" cut
	038-7230-00	622.3mm	15.9mm			63.5mm	5.2mm	
15 - 9883 	038-7220-00	24-1/2"	5/8"			2-1/2"	.204"	Commercial Mulching Blade
	038-7230-00	622.3mm	15.9mm			63.5mm	5.2mm	



OD 4"
ID 2-13/32"
Height 10-1/2"

Order No. 19 - 9583

Filter replaces Bad Boy 063-8019-00.

Order No. 19 - 9728

Prefilter replaces Bad Boy 063-8020-00. Fits our 19-9583 air filter.



Order No. 19 - 11865

Safety filter element replaces Bad Boy 063-8020-00. Used with our 19-9583 & 19-11841. Import version of our 19-9728 filter.



Center Hole 5-15/16"
Diameter 7-7/8"
Height 2-13/16"

Order No. 19 - 10881

Air filter & Prefilter replaces Bad Boy 063-8016-00. Prefilter included. Uses our 19-10882 prefilter.



Order No. 19 - 6929

Oil Filter, replaces Bad Boy 063-2004-00. 25/30 Micron. Height 2.707", OD 2.921", Thread size 3/4 - 16.



Order No. 19 - 6600

Oil Filter, Replaces Bad Boy 063-2090-00, 063-8015-00. 25/30 Micron. 2.977" Height, 2.685" OD, Thread size 3/4 - 16.



Order No. 19 - 5909

Oil Filter, Replaces Bad Boy 063-2010-00, 063-5400-00 25.5 Micron. 3.404" Height, 2.921" OD, Thread size 3/4 - 16.

30

O.E.M.

O.E.M. REPLACEMENT
BAD BOY (Cont.)



Order No. 19 - 6677

Oil Filter, Replaces Bad Boy 063-2010-00, 063-5400-00. 25/30 Micron. 3.529" height, 2.966" OD, Thread size 3/4 -16.



Order No. 19 - 7916

Oil Filter, Replaces Bad Boy 063-2010-00, 063-5400-00. 25/30 Micron. 2.707" height, 2.921" OD, Thread size 3/4 - 16.



Order No. 19 - 8631

Transmission Filter, Replaces Bad Boy 063-8014-00. 10 Microns. 3.790" height, 3.66" OD, Thread size 1 - 12.

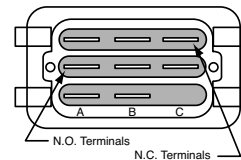

Order No. 31 - 9656

PTO switch replaces Bad Boy 056-8058-00. Push-pull/snap mount. Corner terminal blank. Red knob.

O.E.M. 30



Order No. 31 - 11219

Ignition key. Replaces Bad Boy 042-9000-00. Plastic covered. Fits Delta switches. MIN010

BERNARD

ORDER NO.	REPLACES O.E.M. NO.	LENGTH	CENTER HOLE DIAM.	OUTSIDE HOLE DIAM.	CENTER TO CENTER	WIDTH	STEEL THICK.	APPLICATION
15 - 50125	12806	20-7/8" 530.23mm	.412" 10.71mm			3.00" 76.20mm	.125" 3.18mm	



ID 1-15/32" (37.30 mm)
OD 2-7/8" (73.02 mm)
Height 3" (76.20 mm)

Order No. 19 - 50243

Filter replaces Bernard 364. Comes with rubber insert and hose clamp.



ID 4-1/4" (107.95 mm)
OD 6" (152.40 mm)
Height 2" (50.80 mm)

Order No. 19 - 50242

Filter replaces Bernard 20062.



BLUE BIRD



ID 3/4" (19.05 mm)
OD 1-27/32" (46.83 mm)
Height 27/32" (21.43 mm)

Order No. 09 - 8863

Shaft bearing with locking collar & set screw replaces Blue Bird 0315. Fits models F20 & F20B. Used with our **15-6324** flail blade set & our **10-8755** shaft set & our **10-8741** spacer set.











Order No. 10 - 8741

Rubber space set replaces Bluebird 5004. Fits lawn comber rotor, models F20 & F20B. Used with our **15-6324** flail blade set, **10-8755** shaft set & **09-8863** bearing. **48 pieces per set.**

Order No. 10 - 8755

Shaft with clip set replaces Bluebird 5002. Fits Bluebird Thatchers. **4 shafts & 8 clips per set.** Used with our **15-6324** flail blade set, **10-8741** spacer set & **09-8863** bearing.



ORDER NO.	REPLACES O.E.M. NO.	LENGTH	CENTER HOLE DIAM.	OUTSIDE HOLE DIAM.	CENTER TO CENTER	WIDTH	STEEL THICK.	APPLICATION
 15 - 10780	5970							Fits model P18. 20 blades per set.
 15 - 8720 MIN052	5201	3-17/32" 89.9mm	17/32" 13.5mm			1" 25.4mm	.125" 3.2mm	Flail blades. Fits F20 & F20B.
 15 - 6324 MIN052	5001 350100	4" 101.6mm	1/2" 12.7mm			1" 25.4mm	.125" 3.2mm	Flail blades. Fits Blue Bird Lawn comber-rotor Used with our 10-8755 shaft, 09-8863 bearing & 10-8741 spacer set.
 15 - 10968 MIN052	5001	4" 101.6mm	1/2" 12.7mm			1" 25.4mm	.125" 3.2mm	(NHT) Fits lawn Comber-Roter. 52 Blades per set.
 15 - 11643 MIN024	5601	3-17/32" 89.7mm	17/32" 13.5mm			1" 25.4mm	.125" 3.17mm	Also replaces Stiga 1621-0050-01 Fits 300 RSC & VB38 (NHT) Minimum 24
 15 - 11645 MIN052	5201	3-17/32" 89.7mm	17/32" 13.5mm			1" 25.4mm	.125" 3.17mm	(NHT) Minimum 52
 15 - 11644 MIN052	5401	4" 101.6mm	17/32" 13.5mm			1" 25.4mm	.125" 3.17mm	Fits models TLC-240 (48 pcs), 405 (36 pcs), 720 (52 pcs) (NHT) Minimum 52
 15 - 12714	71910	7-5/8" 178.4mm						Requires the following: (30)for Lawnaire IV plus. (42)for Lawnaire V plus Fits models 424, 530A & 742. Aerator Tine.

O.E.M. REPLACEMENT



BOBCAT

Pro-Gear Transmission
5 Speed



Order No. 42 - 14176

Pro-Gear T7510 transmission replaces Peerless 700-070A, Bobcat 412720.

Pro-Gear Drive Shaft



Order No. 42 - 14183

Pro-Gear 30-1021 Drive Shaft. Replaces Peerless 776456 & Bobcat/Bunton 4130099. 7" Long, 9-Spline

30

O.E.M.



Order No. 42 - 14182

Pro-Gear 30-1020 Drive Shaft. Replaces Peerless 771846 & Bobcat/Bunton 2308134. 6-5/8" Long, 9-Spline

Pro-Gear Coupler



Order No. 42 - 14184

Pro-Gear 30-1000 Coupler. Replaces Peerless 771834, Bobcat/Bunton 2308135, Husqvarna 539102164, 102164, Exmark 1-323501, 1-324340 & Wright 3949003. 9-Spline

Made in USA

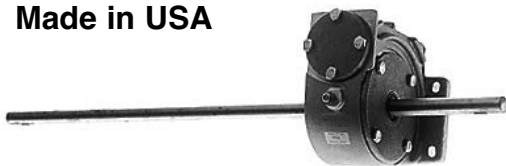

Order No. 42 - 7097

Gear Box Assembly. Replaces Bobcat 38008-1N. (12.5 to 1 gear ratio)

6" Dia.
3/4" Width



Order No. 05 - 7788

Brake band replaces Bobcat 138008. For 36", 48", 54" & 61" mid size mowers.

Thread Size 3/8"-18"
OD (Pin) 5/16"
Shoulder Length 1/2"



Order No. 05 - 10810

Swivel replaces Bobcat 33103.



Order No. 05 - 8099

Control rod linkage swivel replaces Bobcat 33004A.



ID 5/8"
Width 2-3/4"
Height 5"

Order No. 07 - 10715

Deck wheel replaces Bobcat 2721512. 3-5/16" centered hub.



Order No. 06 - 2998

Replaces Bobcat 76096-01, 76167. 8" x 1.75" Heavy Duty Steel Wheel, 1/2" bearing, 2" off set hub and zerk fitting. (painted red)



BOBCAT (Cont.)



Order No. 06 - 2999

Replaces Bobcat 76096-2C, 76168. 10" x 1.75" Heavy Duty Steel Wheel, 1/2" bearing, 2" off set hub and zerk fitting. (painted red)



Order No. 06 - 3239

Replaces Bobcat 38012N. 6" x 2.00" Heavy Duty Soild Steel Deck Wheel, 5/8" roller bearing, 2-1/4" centered hub and zerk fitting. Uses our **09-5848** Bearing Kit. (painted red)

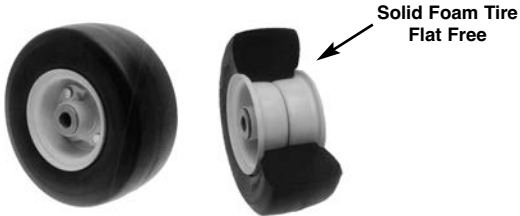

Order No. 08 - 8581

Caster Wheel Assembly for Bobcat, 9 x 350 x 4 Smooth Tread Solid Foam Tire with 3 Piece Rim. 4" centered hub with 5/8" open cage roller bearing and zerk fitting. Fits 32", 36", 48", 54" & 61" cut midsize walk behind mowers. Assembly uses our **08-8264** solid foam tire. (painted red)



Order No. 08 - 905

13 x 650 x 6 Drive Wheel Assy., replaces Bobcat 38096C & 36479, 4 ply tubeless, 7/8" roller bearing, 6-1/2" offset hub.



Order No. 08 - 3277

280/250 x 4 ply Saw tooth tire and tube replaces Bobcat 38209, mounted on a 3-1/4" centered hub, 3 piece rim, 1" open cage roller bearing.



Order No. 08 - 8098

9 x 350 x 4 Caster Wheel, smooth tread 4 ply tubeless tire, 3 piece rim, 4" centered hub with 5/8" open cage roller bearing and zerk fitting. Replaces Bobcat 38510. Uses our **09-5812** bearing kit. (painted red)



Order No. 08 - 3276

9 x 350 x 4 smooth tread 4-ply tubeless tire. 4" centered 3-piece rim and zerk fitting, 5/8" open cage roller bearing. Bobcat 38510, 38264. Uses our **09-5812** bearing kit.

Overall ID 5/8" (15.88 mm)
Overall OD 1-3/8" (34.93 mm)
Overall Length 3-15/16" (100.01 mm)



Order No. 09 - 5812

Open cage roller bearing with flanged bushings for our Bobcat 38273, 38274. Wheel Assembly **08-3276**.

Order No. 09 - 7262

Wheel Bushing replaces Bobcat 14380. Used in our wheel bearing assembly **09-5812**.



ID 1/2"
OD 5/8"
Length 4"

30

O.E.M.

O.E.M. REPLACEMENT



BOBCAT (Cont.)

Order No. 09 - 7780

Replacement wheel bearing kit for our Bobcat wheel assembly **08-3276**. Comes with (2) **09-481** high speed 5/8" bearings, (1) **10-7779** 21/32" x 1-1/8" washer and (1) **09-7262** 5/8" OD x 4-1/16" bushing.



ID 7/8" (22.23 mm)
OD 1-3/8" (34.93 mm)
Overall Length 6-7/16" (163.51 mm)

Order No. 09 - 8664

Wheel bearing kit replaces Bobcat 38058N (roller cage bearing) & 38025N (retainers). Fits Bobcat 38096C wheel assembly. Fits our **08-905** wheel assembly.

Order No. 09 - 9041

Roller cage bearing only for Bobcat. Replaces Bobcat 38058N. Used on our **08-905** wheel assembly. OD 1-3/8" (34.92 mm), ID 7/8" (22.22 mm), Length 2-1/2" (63.50 mm).



Order No. 09 - 9011

Retainer bushing only for Bobcat. Replaces Bobcat 38025N. Used on our **08-905** wheel assembly. OD 1-1/2" (38.10 mm), ID 7/8" (22.22 mm).

Order No. 09 - 5848

Open cage roller bearing with flanged bushings for our Bobcat Wheel Assembly **06-3239**. Bearing 38069N, Cap 38042N.

Overall ID 5/8" (15.88 mm)
Overall OD 1-13/32" (35.72 mm)
Overall Length 2-7/32" (56.36 mm)

Order No. 09 - 9006

Roller cage bearing only for Bobcat. Used on our Bobcat **06-3239** wheel assembly. OD 1-21/64" (33.73 mm), ID 21/32" (16.66 mm), Length 1-7/16" (36.51 mm).



Order No. 09 - 9007

Retainer bushing only for Bobcat. Used on our Bobcat **06-3239** wheel assembly. OD 1-1/2" (38.10 mm), ID 5/8" (15.87 mm).

Order No. 09 - 3217

Sealed Spindle Bearing. Replaces Bobcat 35008N. Bearing No. 6305-2RS.



ID 63/64" (25.00 mm)
OD 2-7/16" (61.91 mm)
Height 21/32" (16.67 mm)



ID 1/2" (12.70 mm)
OD 1-5/8" (41.27 mm)
Height 1" (25.40 mm)

Order No. 09 - 8375

Bearing replaces Bobcat 78113. Bearing used in our **06-2998** & **06-2999** wheels.



ID 1" (25.40 mm)
OD 2" (50.80 mm)
Height 27/32" (21.43 mm)

Order No. 09 - 8488

Bearing replaces Bobcat 38348-01, bearing No. RA100RR.

30

O.E.M.



BOBCAT (Cont.)



ID 5/8" (15.88 mm)
OD 1-9/16" (34.93 mm)
Height 7/8" (22.23 mm)

Order No. 09 - 8077

Output shaft support bracket bearing replaces Bobcat 35062B, used with our 10-8184 flange.



ID 5/8" (15.88 mm)
OD 1-3/8" (34.93 mm)
Height 7/16" (11.11 mm)

Order No. 09 - 8198

Reduction gear bearing. Replaces Bobcat 3846N. Five (5) bearings used in our Gear Box Assembly 05-7097. Bearing No. 99502H-2RS.



ID 3/4" (19.05 mm)
OD 1" (25.40 mm)
Height 1-3/16" (30.16 mm)

Order No. 09 - 5721

Replaces Bobcat 33050. Used on our support arm 10-2218.



ID 1" (25.40 mm)
OD 1-1/4" (31.75 mm)
Height 3/4" (19.05 mm)
Flange OD 1-5/8" (41.26 mm)

Order No. 09 - 5707

Replaces Bobcat 48053-2A. Used on our support arm 10-6580 and 10-8181. (Bronze)



ID 1" (25.40 mm)
OD 1-1/4" (31.75 mm)
Height 1" (25.40 mm)
Flange OD 1-3/4" (44.45 mm)

Order No. 09 - 8240

Caster bushing replaces Bobcat 48053-2A. Fits all mid size hydro and belt driven mowers.



ID 5/8" (15.88 mm)
OD 1-3/8" (34.93 mm)
Height 7/16" (11.11 mm)

Order No. 09 - 8199

High speed bearing, double sealed replaces Bobcat 38046N. May be used with or without retaining clip. Bearing No. 99502H-2RSNR.



ID 5/8"
OD 2-1/2"
Height 3/4"

Order No. 09 - 12651

Flange bearing replaces Bobcat 38213. Fits mid-size models with Peerless Transmissions. Two 9/32" mounting holes, 2-1/2" center to center.



ID 3/4" (19.05 mm)
OD 1-1/8" (28.58 mm)
Height 3/4" (19.05 mm)
Flange OD 1-1/4" (31.75 mm)

Order No. 09 - 2935

Replaces Bobcat 148048-01. Graphite Impregnated.



Order No. 10 - 2224

Bell Crank Spring. Replaces Bobcat 35010A.



ID 3/4"
OD 1-1/4"
Thick 1/4"

Order No. 10 - 2238

Caster Yoke Spacer. Replaces Bobcat 64163-71, 64163-14. Used on our 10-2243 caster yoke.



ID 1"
OD 1-11/16"
Thick 1/2"

Order No. 10 - 6886

Caster Yoke Spacer. Replaces Bobcat 64163-22. Used on our 10-6581 & 10-6582 caster yoke.



ID 1"
OD 1-3/4"
Thick 1/4"

Order No. 10 - 6885

Caster Yoke Spacer. Replaces Bobcat 64163-07. Used on our 10-6581 & 10-6582 caster yoke.

30

O.E.M.

O.E.M. REPLACEMENT
BOBCAT (Cont.)



Order No. 10 - 9142

Universal adjustable yoke ends. 5/16" - 24 female, for 5/16" pin. Replaces Bobcat 38020.



Order No. 10 - 9311

Rod end replaces Bobcat 128079. Female 1/4" - 28 rod end assembly.



Order No. 10 - 2221

Bell Crank. Replaces Bobcat 31007A. Left Hand (53°).



Order No. 10 - 2222

Bell Crank. Replaces Bobcat 2306019, 31005A. Variable Speed (90°).



Order No. 10 - 2223

Bell Crank. Replaces Bobcat 31006A. Right Hand (53°).



Order No. 10 - 2218

Caster Yoke Support Arm. Replaces Bobcat 36129. Comes with bushing and grease fitting.



Order No. 10 - 6580

Support Arm. Replaces Bobcat 36482. Used with 10-6582 & 10-6581 yokes.



Order No. 10 - 10757

Damper assembly replaces Bobcat 2721246. Fits Bobcat "ZERO TURN" rider mowers. Size 8 x 22. Extended length 10.08"

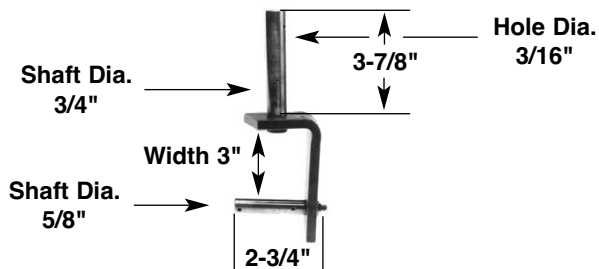

Order No. 10 - 2243

Caster Yoke replaces Bobcat 36306 & 36013A.

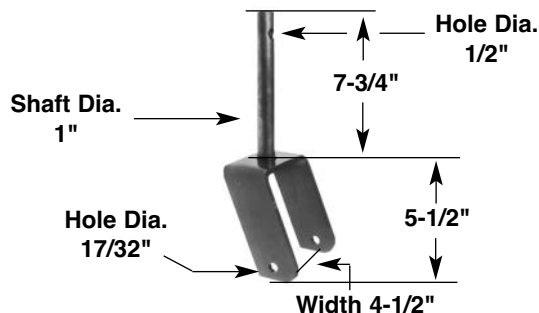

Order No. 10 - 6581

4" Yoke replaces Bobcat 36411/36526.

30

O.E.M.



BOBCAT (Cont.)



Order No. 10 - 5706

1" Snap Ring. Replaces Bobcat 64144-12.

MIN010



Order No. 10 - 1191

1/4" Blade Spacer. Replaces Bobcat 64163-12.

Order No. 10 - 7249

1/2" Blade Spacer. Used on Bobcat.



Order No. 10 - 2219

Traction Control Lever. Replaces Bobcat 36068N.



Order No. 10 - 2910

Clevis Pin, Cotter Pin. Replaces Bobcat 64188-21 & 64140-2.

MIN010



Order No. 10 - 6670

Replaces Bobcat 32344. Used on all 36" & 48" cut gear drive units. Holds belt on engine pulley. (2 per unit)



Order No. 10 - 6671

Replaces Bobcat 32345-01. Used on all variable speed new models. Holds belt on engine pulley. (2 per unit).



Order No. 10 - 6672

Replaces Bobcat 32345-02. Used on older model single belt variable speed mowers. Uses 2 on engine pulley and 4 on wheel drive pulley. (6 per unit)



Order No. 10 - 11444

Electric PTO clutch replaces Bobcat 2188151. 6-5/16" pulley, 5/8" belt, shaft size 1-1/8". Warner 5218-5.



Order No. 10 - 11237

Electric PTO clutch replaces Bobcat 2721337. For 25hp engines. Warner 5218-65.



Order No. 10 - 11858

Electric PTO clutch replaces Bobcat 188019. 1" ID x 6" pulley, A/B Belt type. Warner 5215-14.

30

O.E.M.

**O.E.M. REPLACEMENT
BOBCAT (Cont.)**



ID 3/4"
OD 1"
Length 3-1/2"



Order No. 09 - 7839

Spanner bushing replaces Bobcat 43037A. Fits our **08-3277** and **06-3278** wheel assemblies.



Order No. 10 - 1226

5-1/8" Spindle Assembly. Replaces Bobcat 36006N. For 32" and 36" decks. (short shaft).



Order No. 10 - 9375

Spindle assembly replaces Bobcat 36567. Fits 36" & 48" XM series mowers.

Order No. 10 - 1227

6-1/4" Spindle Assembly. Replaces Bobcat 36082N. For 48" decks. (long shaft).



Order No. 10 - 5708

3/4-10x5 Wheel Bolt. Replaces Bobcat 64123-86. For 8" caster wheel.



Order No. 10 - 2225

5/16" Quick Pin. Replaces Bobcat 64173-01. 1-1/2" Length

Order No. 10 - 2226

3/16" Quick Pin. Replaces Bobcat 64173-02, 64173-05. 1-5/8" Length.

**Order No.
10 - 6891**

Size

7/8" Foam Grips

10 - 6892

1" Foam Grips



Used on Bobcat and other midsize mowers. Sold and priced in pairs.

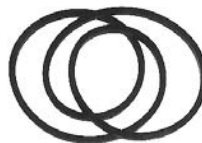

Order No.

Description

12 - 5823

Engine to Blade Belt. Replaces Ransomes/Bobcat 38030N. "B" Section Belt, 93" length (2362.2 mm). For 48" deck.

12 - 5241

Wheel Drive Belt. Replaces Ransomes/Bobcat 38017N. "B" Section Belt, 44.125" length (1120.76 mm). 36" and 48" decks, cogged.

12 - 5242

Variable Speed Belt. Replaces Ransomes/Bobcat 38016N. "B" Section Belt, 35.6" length (904.24 mm). 32" and 36" decks.



BOBCAT (Cont.)

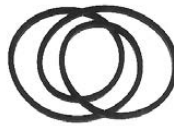

Order No.

Description

12 - 6836

Variable Speed Wheel Drive Belt. Replaces Bobcat 38249. Double "A" section, 44.700".

12 - 6969

Gear Drive Belt. Replaces Bobcat 38212. Double "A" section, 55.95" length (1421.13 mm).

12 - 8803

Deck Belt. Replaces Bobcat 38440. 42/64" (16.66 mm) x 82.25" (2089.15 mm). Fits new style 48" deck, Hydro mowers. Wrap molded *Aramid fiber.

12 - 8808

Engine to Hydro Pump Belt. Replaces Bobcat 2188128. 1/2" (12.70 mm) x 63" (1600.2 mm). Fits 61"cut "O" turn models. Raw edge. *Aramid fiber.

12 - 8809

Engine to Center Spindle Belt. Replaces Bobcat 38442. 21/32" (16.67 mm) x 67.75" (1720.85 mm). Fits new style 48" cut models. Engine to center spindle for gear drive units. Wrap molded. *Aramid fiber.

12 - 8810

Gear Drive Belt. Replaces Bobcat 38523. 1-1/8" (28.58 mm) x 54" (1371.6 mm) cogged belt for all 94, 95, 96 Bobcats. Raw edge, cogged. *Aramid fiber. 2 rib band belt.

12 - 8811

Transmission Belt. Replaces Bobcat 128099. 1/2" (12.70 mm) x 36.12" (917.45 mm). Trans. belt on newer gear drive machines. Raw edge. *Aramid fiber.

12 - 11468

Engine to Deck Belt. Replaces Bobcat 2188134. 5/8" (15.8 mm) x 101" (2565.4 mm). Fits 61" ZTR rider. Laminated, aramid cord construction.

12 - 11853

Cutter Deck Belt. Replaces Bobcat 128003. 5/8" (15.8 mm) x 132-3/4" (3353.55 mm), Aramid cord construction.

*Made with KEVLAR® or non-trade marked Aramid fiber.

ID 1/2" to 1"
OD 5"
Height 3-1/2"
Keyway 1/4"



Order No. 13 - 2184

Variable Speed Pulley. Replaces Bobcat 38140 & 38089N

ID 1"
OD 5-3/4"
Height 1-3/16"
Keyway 1/4"



Order No. 13 - 5991

Engine Pulley. Replaces Bobcat 31012A without set screws and 31008B with (2) set screws.

ID 5/8"
OD 3-7/16"
Height 1-13/16"
Keyway 3/16"



Order No. 13 - 6608

Double pulley replaces Bobcat 38183. Fits 48" Mid-size. Transmission to wheel.

ID 5/8"
OD 3-7/16"
Height 1-1/4"
Keyway 3/16"



Order No. 13 - 6607

Double pulley. Replaces Bobcat 38232. Fits 36" Mid-size. Transmission to wheel.

30

O.E.M.

O.E.M. REPLACEMENT
BOBCAT (Cont.)



ID 5/8"
OD 3-1/2"
Height 1-5/16"
Keyway 3/16"

Order No. 13 - 2186

Jackshaft Pulley. Replaces Bobcat 38456, 38018N.



ID 5/8"
OD 5"
Height 1-5/16"
Keyway 3/16"

Order No. 13 - 2187

Transmission Pulley. Replaces Bobcat 38022B.

30



ID 1"
OD 5-3/4"
Height 1-5/16"
Keyway 1/4"

Order No. 13 - 2185

Spindle Pulley. Replaces Bobcat 31011B.

O.E.M.



ID 3/8"
OD 3-1/32"
Height 7/8"

Order No. 13 - 2188

Flat Idler. Replaces Bobcat 38010-2A.



Order No. 13 - 5714

Deck Idler. Replaces Bobcat 38010-1A.



ID 3/8"
OD 4"
Height 1-9/16"

Order No. 13 - 7813

Idler pulley. Replaces Bobcat 38184-2. Idler for double "V" drive wheel pulley to gear and positive drive. Fits 36", 48", 54" and 61" mid size.

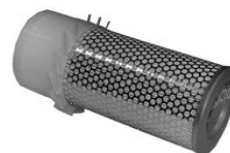

ID 3/8"
OD 4-5/8"
Height 11/16"

Order No. 19 - 8328

Filter replaces Bobcat 48426.

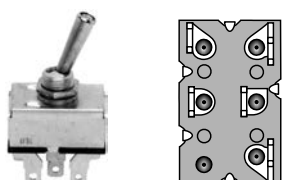

ID 2-1/2"
OD 4"
Height 10-1/4"

Order No. 31 - 7675

Replaces Bobcat 128009. Mounting hardware included.

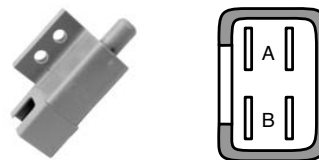













Order No. 31 - 9659

Plunger interlock switch replaces Bobcat 108208. Double pole, snap in mounting. Normally open/normally closed.



BOBCAT (Cont.)











ORDER NO.	REPLACES O.E.M. NO.	LENGTH	CENTER HOLE DIAM.	OUTSIDE HOLE DIAM.	CENTER TO CENTER	WIDTH	STEEL THICK.	APPLICATION
 15 - 1009	32061A	16-1/4" 412.8mm	5/8" 15.9mm			2-1/2" 63.5mm	.150" 3.8mm	(2) blades for 32" cut (3) blades for 48" cut.
 15 - 2172	32061A	16-1/4" 412.8mm	5/8" 15.9mm	11/32" 8.7mm	1-5/8" 41.3mm	2-1/2" 63.5mm	.240" 6.1mm	(Heavy Duty) (2) blades for 32" cut. (3) blades for 48" cut.
 15 - 10172	32061A	16-1/4" 412.8mm	5/8" 15.8mm			2-1/2" 63.5mm	.204" 5.2mm	Flat Blade Sharpened - 4-sides
 15 - 6296	32061A	16-1/4" 412.8mm	5/8" 15.9mm			2-1/2" 63.5mm	.204" 5.2mm	Mulching Blade PATENTED
 15 - 9967	32061A	16-1/4" 412.8mm	5/8" 15.8mm			2" 50.8mm	.240" 6.1mm	Low-Lift Blade Sharpened - 4-sides
 15 - 3400	112111-01	16-1/4" 412.8mm	5/8" 15.9mm			2-1/2" 63.5mm	.204" 5.2mm	(2) blades for 32" cut (3) blades for 48" cut
 15 - 1010	32022A	18" 457.2mm	5/8" 15.9mm	1/4" 6.4mm	1-5/8" 41.3mm	2-1/2" 63.5mm	.150" 3.8mm	(2) blades for 36" cut (3) blades for 54" cut
 15 - 2173	32022A	18" 457.2mm	5/8" 15.9mm			2-1/2" 63.5mm	.240" 6.1mm	(Heavy Duty) (2) blades for 36" cut (3) blades for 54" cut
 15 - 10173	32022A	18" 457.2mm	5/8" 15.8mm			2-1/2" 63.5mm	.204" 5.2mm	Flat Blade Sharpened - 4-sides
 15 - 6294	32022A	18" 457.2mm	5/8" 15.9mm			2-1/2" 63.5mm	.204" 5.2mm	Mulching Blade PATENTED
 15 - 9968	32022A	18" 457.2mm	5/8" 15.8mm			2" 50.8mm	.240" 6.1mm	Low-Lift Blade Sharpened - 4-sides
 15 - 3401	112111-02	18" 457.2mm	5/8" 15.9mm			2-1/2" 63.5mm	.204" 5.2mm	(2) blades for 36" cut

30
O.E.M.

O.E.M. REPLACEMENT
BOBCAT (Cont.)

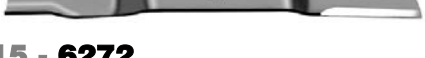

30
O.E.M.

ORDER NO.	REPLACES O.E.M. NO.	LENGTH	CENTER HOLE DIAM.	OUTSIDE HOLE DIAM.	CENTER TO CENTER	WIDTH	STEEL THICK.	APPLICATION
 15 - 13016	112111-02	18" 457.2mm	5/8" 15.9mm			2-1/2" 63.5mm	.204" 5.2mm	(2) blades for a 36" cut. Mulching Blade. PATENTED
 15 - 6183	112243-02	18" 457.2mm	5/8" 15.9mm			2-1/2" 63.5mm	.204" 5.2mm	(2) blades for 36" cut (3) blades for 54" cut Low lift
 15 - 10174	42180B	21" 533.4mm	5/8" 15.8mm			2-1/2" 63.5mm	.204" 5.2mm	Flat Blade Sharpened - 4-sides
 15 - 9969	42180B	21" 533.4mm	5/8" 15.8mm			2" 50.8mm	.240" 6.1mm	Low-Lift Blade Sharpened - 4-sides
 15 - 1036	72039B	21" 533.4mm	3/8" 9.5mm	3/8" 9.5mm	2" 50.8mm	2-1/2" 63.5mm	.150" 3.8mm	
 15 - 2174	42180B	21" 533.4mm	5/8" 15.9mm			2-1/2" 63.5mm	.240" 6.1mm	(Heavy Duty) (3) blades for 61" cut
 15 - 6299	42180B	21" 533.4mm	5/8" 15.9mm			2-1/2" 63.5mm	.204" 5.2mm	Mulching Blade PATENTED
 15 - 3402	112111-03	21" 533.4mm	5/8" 15.9mm			2-1/2" 57.2mm	.240" 6.1mm	
 15 - 13017	112111-03	21" 533.4mm	5/8" 15.9mm			2-1/2" 63.5mm	.240" 6.1mm	(3) blades for a 61" cut. Mulching Blade PATENTED
 15 - 6272	112243-03	21" 533.4mm	5/8" 15.9mm			2-1/2" 57.2mm	.240" 6.1mm	(3) blades for 60" cut
 15 - 3329	112111-04 42139B	25" 635mm	5/8" 15.9mm			2-1/2" 57.2mm	.240" 6.1mm	(Heavy Duty) (3) blades for 74" cut.



BOLENS

ID 1/2"
Width 1-3/8"
Height 5"



Order No. 07 - 6915

Deck Wheel replaces Bolens 1735583. 1-1/2" centered hub, steel bushing.



ID 5/8"
Width 2"
Height 6"

Order No. 07 - 6919

Deck Wheel replaces Bolens 1737807. 2-1/8" offset hub.



ID 25/32" (19.84 mm)
OD 1-27/32" (21.43 mm)
Height 9/16" (14.29 mm)

Order No. 09 - 442

Replaces Bolens 1728225. Bearing No. 6204DU.



ID 3/4" (19.05 mm)
OD 1-25/32" (45.24 mm)
Height 19/32" (15.08 mm)

Order No. 09 - 484

Replaces Bolens 1185828. Bearing No. 9504-ZZ.



ID 3/4" (19.05 mm)
OD 1-25/32" (45.24 mm)
Height 21/32" (16.67 mm)

Order No. 09 - 813

Replaces Bolens 9401, 1185275. Bearing No. LM11949 & LM11910

Flat Idlers with flange



Order No.
13 - 718
13 - 719
13 - 720
13 - 721
13 - 2192

Description
Replaces Bolens 1728440.
Replaces Bolens 1710556.
Replaces Bolens 1715340.
Replaces Bolens 1713803.
Replaces Bolens 1717584.
(13-2192 - flat idler without flange)

Note: See Section 13 for Idler measurements.

"V" Belt Idlers



Order No.
13 - 728
13 - 729

Description
Replaces Bolens 1710567.
Replaces Bolens 1727978.

Note: See Section 13 for Idler measurements.

30

O.E.M.

**O.E.M. REPLACEMENT
BOLENS (Cont.)**



ORDER NO.	REPLACES O.E.M. NO.	LENGTH	CENTER HOLE DIAM.	OUTSIDE HOLE DIAM.	CENTER TO CENTER	WIDTH	STEEL THICK.	APPLICATION
15 - 6066	172-7926	15-5/16" 388.9mm	3/8" 9.5mm	3/8" 9.5mm	2-3/4" 69.9mm	2" 50.8mm	.204" 5.2mm	(3) blades for 42" cut Fit models 18300, 30042R & 30042S center mount mower
15 - 6068	177-2145 173-8571	17" 431.8mm	3/8" 9.5mm	3/8" 9.5mm	2-3/4" 69.9mm	2" 50.8mm	.204" 5.2mm	(3) for 48" cut attachment models 30048S, 30048E, 18336 & 192111
15 - 6069	177-2335 174-7640	18-1/2" 469.9mm	3/4" 19.1mm	13/32" 10.3mm	2-9/16" 65.1mm	2" 50.8mm	.187" 4.8mm	(2) blades for 36" cut models 30036S & 31036S Fits Troy Bilt

30

O.E.M.

Order No. 20 - 7730

Fuel tank bushing replaces Bolens 1738433. Packaged in lots of 10. MIN010



Order No. 20 - 2235

Vented fuel cap. Used on Bolens.



Order No. 31 - 3319

Solenoids. Replaces Bolens 1751569.



Order No. 31 - 8943

Universal Solenoid. Replaces Bolens 1752137 & 1753539.

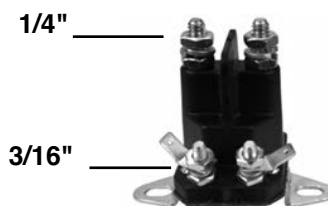

Order No. 31 - 5933

Universal Solenoid. Replaces Bolens 1752137, 1753539.

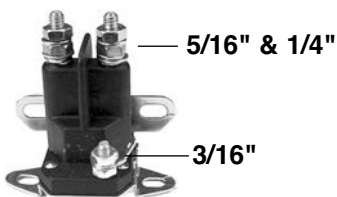

Order No. 31 - 10771

Universal starter solenoid 3 pole, 12 volt. Terminal post will accommodate both 5/16" & 1/4" terminal connectors, Mounting bracket will accommodate both chassis and wall mount configurations. Replaces Bolens 1751569.

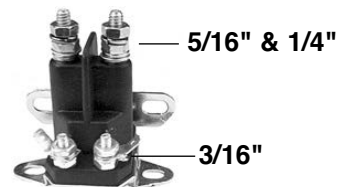

Order No. 31 - 10772

Universal starter solenoid 4 pole, 12 volt. Terminal post will accommodate both 5/16" & 1/4" terminal connectors, Mounting bracket will accommodate both chassis and wall mount configurations. Replaces Bolens 1752137, 1753539.



BOLENS (Cont.)



Order No. 31 - 9666

Twist lock seat switch replaces Bolens 1768882. Single pole, twist lock mount. Normally closed.



Order No. 31 - 12752

Ignition switch replaces Bolens 1754183.



Order No. 41 - 5568

Snowblower shoe fits Bolens.



Order No. 41 - 5134

Double sided, reversible runner fits Bolens. Painted orange.



Order No. 41 - 5511

Scraper bar replaces Bolens 1741179. Fits models 225, 300 & 350. 19-3/8" length x 1-5/8" width x 1/4" mounting holes.



Order No. 41 - 5503

Scraper bar replaces Bolens 1737488. Fits models 225, 225E, 300, 300E, 350, 350E & 520. 18" length x 2-1/4" width x 1/4" mounting holes.

30

O.E.M.



O.E.M. REPLACEMENT

BUNTON

Conduit 50"
Inner Wire 52-1/4"
Wire Travel 2-1/4"



Order No. 03 - 8766

Throttle control replaces Bunton PJ-5019-50. Fits Bunton mid-size Commercial Hydro mower 36", 48", 52" & 60" cut. Used with our 03-8800 T-Knob.



Order No. 03 - 8800

T - knob replaces Bunton PL4020. Fits our 03-8766 throttle control.

Made in USA



Order No. 42 - 7097

Gear Box Assembly. Replaces Bunton PLA0965. (12.5 to 1 gear ratio)

Pro-Gear Drive Shaft



Order No. 42 - 14183

Pro-Gear 30-1021 Drive Shaft. Replaces Peerless 776456 & Bobcat/Bunton 4130099. 7" Long, 9-Spline

O.E.M. 30



Order No. 42 - 14182

Pro-Gear 30-1020 Drive Shaft. Replaces Peerless 771846 & Bobcat/Bunton 2308134. 6-5/8" Long, 9-Spline

Pro-Gear Coupler



Order No. 42 - 14184

Pro-Gear 30-1000 Coupler. Replaces Peerless 771834, Bobcat/Bunton 2308135, 9-Spline.



ID 5/8"
Width 2-3/4"
Height 5"

Order No. 07 - 6917

5" x 2-3/4" Deck Wheel. Replaces Bunton PL7540. 2-1/2" offset hub. Uses our 09-8586 bushing.



Order No. 08 - 8196

Tubeless caster wheel assembly. Replaces Bunton PAL0942A. 410 x 350 x 5, 2 ply sawtooth tread tire. 2-15/16" centered hub, 3/4" ID bearing and zerk fitting. Used on 36", 48", 52" and 61" Mulch and Turf decks. (Painted Yellow).



Order No. 06 - 3239

6 x 2.00 Heavy Duty solid deck wheel. Replaces Bunton PLO642. 5/8" roller bearing, 2-1/4" centered hub and zerk fitting. Uses our 09-5848 bearing kit. (painted red).



Order No. 08 - 905

13 x 650 x 6 Drive Wheel Assembly. Replaces Bunton PAL 1075A. 6-1/2" offset hub length, 7/8" roller bearing, 4 ply tubeless.



O.E.M. REPLACEMENT

BUNTON (Cont.)



ID 7/8" (22.23 mm)
OD 1-1/8" (28.58 mm)
Height 1-1/4" (31.75 mm)

Order No. 09 - 5703

Replaces Bunton PLO928. Used on our Bunton Support Arm 10-2218.



ID 1" (25.40 mm)
OD 1-1/4" (31.75 mm)
Height 1" (25.40 mm)
Flange OD 1-3/4" (44.45 mm)

Order No. 09 - 8240

Caster bushing replaces Bunton PJH 1060. Fits all midsize hydro and belt driven mowers.



ID 5/8" (15.88 mm)
OD 1-3/8" (34.93 mm)
Height 7/16" (11.11 mm)

Order No. 09 - 8198

Reduction Gear bearing replaces Bunton PLO678. Uses 5 bearings for our Gear Box Assembly 05-7097. Bearing No. 99502H-2RS



ID 63/64" (25.00 mm)
OD 2-7/16" (61.91 mm)
Height 21/32" (16.67 mm)

Order No. 09 - 3217

Spindle Bearing. Replaces Bunton PL4611, PLO609. Bearing No. 6305-2RS



ID 3/4"
OD 1-1/4"
Thickness 3/32"

Order No. 10 - 8412

Wheel washer replaces Bunton Z35010. Fits Bunton 36", 48", 52" & 61" cut midsize front cut riders. MIN010



Order No. 10 - 1191

1/4" blade spacer. Replaces Bunton PLO617.

Order No. 10 - 7249

1/2" blade spacer used on Bunton.



ID 3/4"
Thick 1/4"

Order No. 10 - 2238

Caster Yoke Spacer. Replaces Bunton PLO417.



Order No. 10 - 2218

Caster Yoke Support Arm. Replaces Bunton PLO457.



Order No. 10 - 8187

Spindle assembly replaces Bunton PL6139, PAL0806A, PL6140A, PL4606A. Fits 36", 40", 48", 52" and 61" cut. (6-1/2" spindle shaft). (25mm Dia.)



Order No. 10 - 8188

Spindle shaft replaces Bunton PL6139, PL4607. Shaft only for our 10-8187 assembly. 6-1/2" Length, 25mm Dia.

30

O.E.M.

O.E.M. REPLACEMENT



BUNTON (Cont.)

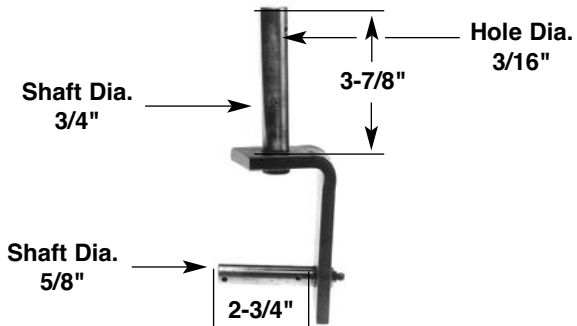

Order No. 10 - 2243

Caster Yoke. Replaces Bunton PLO 556AL.



Order No. 10 - 2219

Traction Control Lever. Replaces Bunton PLO371.



Order No. 10 - 2910

Clevis Pin. Used with Traction Control Lever 10-2219.

MIN010



Order No. 10 - 5706

1" Snap Ring. Replaces Bunton PLO410.

MIN010



Order No. 10 - 5704

Blade Bolt. 5/8" x 9" overall length. Replaces Bunton PLO 815.



Order No. 10 - 5705

Hex Nut. Replaces Bunton Z32008 (5/8-18).



Order No. 12 - 5237

Code

Description

Blade to Blade Belt. Replaces Bunton PLO643. "A" Section Belt, 49.875" length (1266.83 mm). For 36" deck.

12 - 5238

Variable Speed Belt. Replaces Bunton PLO848. "B" Section Belt, 39.875" length (1012.83 mm). For 36", 48" & 52" decks, cogged.

12 - 5241

Wheel Drive Belt. Replaces Bunton PLO619. "B" Section belt, cogged, 44.125" length (1120.76 mm), 36" & 48" decks.

12 - 7913

Wheel Drive Belt. Replaces Bunton PL 4275. Double belt, 45-13/32" length (1153.32 mm), fits 36", 48" and 52" cut mid size.

*Made with KEVLAR® or non-trade marked Aramid fiber.



ID 3/8"
OD 5"
Height 7/8"

Order No. 13 - 10414

Pump drive idler pulley replaces Bunton PL8540A. Fits models SSZ, SWZ & Turf Tiger. 5/16" offset reducer bushing.



ID 5/8"
OD 3-1/2"
Height 1-5/16"
Keyway 3/16"

Order No. 13 - 2186

Jack Shaft Pulley. Replaces Bunton PLO 636.



O.E.M. REPLACEMENT

BUNTON (Cont.)



ID 3/8"
OD 3-1/32"
Height 7/8"

Order No. 13 - 2188

Flat Idler with Flange. Replaces Bunton PAL0368A.



ID 3/8"
OD 4"
Height 1"

Order No. 13 - 5869

"V" belt Idler. Replaces Bunton PLO 786.



ID 3/8"
OD 3-1/2"
Height 1-1/2"

Order No. 13 - 8005

Idler pulley replaces Bunton PL 4274. Fits Bunton, mid size commercial mowers with double wide drive belt.



ID 3/8"
OD 4-7/8"
Height 1-5/32"

Order No. 13 - 7918

Idler pulley replaces Bunton PL 8540A. Fits Bunton 61" & 71" cut Hydro Rider Commercial Machine models.



ID 3/8"
OD 4-9/32"
Height 1"

Order No. 13 - 7861

Blade belt Idler replaces Bunton PL 8036A. Fits 48" and 52" mid size hydro and BHC front engine riders.









30
O.E.M.

ORDER NO.	REPLACES O.E.M. NO.	LENGTH	CENTER HOLE DIAM.	OUTSIDE HOLE DIAM.	CENTER TO CENTER	WIDTH	STEEL THICK.	APPLICATION
15 - 3373	PL4055	16" 406.4mm	5/8" 15.9mm			2-1/2" 63.5mm	.204" 5.2mm	(3) blades for 48" cut Standard lift
15 - 6115	PL4855	16-1/2" 419.1mm	5/8" 15.9mm			2-1/2" 63.5mm	.204" 5.2mm	Low lift blade (3) blades for 48" cut gear drive & hydro drive midsize V-deck models
15 - 6116	PL4205	16-1/2" 419.1mm	5/8" 15.9mm			2-1/2" 63.5mm	.204" 5.2mm	High lift blade (3) blades for 48" cut gear drive & hydro drive midsize V-deck models
15 - 6300	PL4205 PL4855	16-1/2" 419.1mm	5/8" 15.9mm			2-1/2" 63.5mm	.204" 5.2mm	Mulching Blade PATENTED
15 - 6013	PL7329	17" 431.8mm	5/8" 15.8mm			2" 50.8mm	.240" 6.1mm	Low-Lift Blade Sharpened - 4-sides
15 - 3374	P2005	18" 457.2mm	5/8" 15.9mm			2-1/2" 63.5mm	.204" 5.2mm	(3) blades for 52" cut Standard lift

O.E.M. REPLACEMENT
BUNTON (Cont.)



30
O.E.M.

ORDER NO.	REPLACES O.E.M. NO.	LENGTH	CENTER HOLE DIAM.	OUTSIDE HOLE DIAM.	CENTER TO CENTER	WIDTH	STEEL THICK.	APPLICATION
 15 - 6014	PL4206	18" 457.2mm	5/8" 15.9mm			2-1/2" 63.5mm	.204" 5.2mm	(2) blades for 36" cut (3) blades for 52" cut High lift
 15 - 10173	PL4206	18" 457.2mm	5/8" 15.8mm			2-1/2" 63.5mm	.204" 5.2mm	Flat Blade Sharpened - 4-sides
 15 - 6294	PL4206	18" 457.2mm	5/8" 15.9mm			2-1/2" 63.5mm	.204" 5.2mm	Mulching Blade PATENTED
 15 - 9968	PL4206	18" 457.2mm	5/8" 15.8mm			2" 50.8mm	.240" 6.1mm	Low-Lift Blade Sharpened - 4-sides
 15 - 6141	PC005	21" 533.4mm	5/8" 15.9mm			2-1/2" 63.5mm	.204" 5.2mm	(3) blades for 61" cut
 15 - 10174	PC005	21" 533.4mm	5/8" 15.8mm			2-1/2" 63.5mm	.204" 5.2mm	Flat Blade Sharpened - 4-sides
 15 - 6299	PC005	21" 533.4mm	5/8" 15.9mm			2-1/2" 63.5mm	.204" 5.2mm	Mulching Blade PATENTED
 15 - 9969	PC005	21" 533.4mm	5/8" 15.8mm			2" 50.8mm	.240" 6.1mm	Low-Lift Blade Sharpened - 4-sides



ID 1-1/8"
Width 4-1/4"
Height 4"
Length 9-1/2"

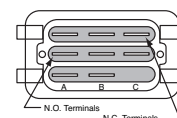

Order No. 18 - 8002

Muffler for Bunton. Fits 12 hp series 252762 muffler.

Order No. 31 - 9656

PTO switch replaces Bunton PL7994. Push-pull/Snap in mount. Corner terminal blank. Red knob



CASTELGARDEN

Total Length 32" (812.8 mm)

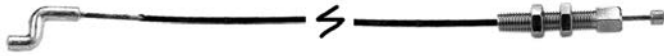

Order No. 10 - 50167

Deck Lift Cable replaces Castlegarden 82004600/0. Bolt Length 2" (50.8 mm), Z bend Length 1-1/4" (31.75 mm)



Order No. 10 - 50257

Spindle assembly replaces Castlegarden 82207201/0. Right hand spindle



Order No. 10 - 50256

Spindle assembly replaces Castlegarden 82207200/0. Left hand spindle.



Order No. 10 - 12706

Spindle assembly replaces Castlegarden 82207202/0. Fits TC92, left hand threads. 92CM Decks.

Spindle Assembly for CASTLEGARDEN



Order No. 10 - 12966



Spindle assembly replaces Castlegarden 82207203/0, right hand fits TC92. Left hand threads fits 92CM decks. For Castlegarden Twin Cut TC102 + 122. (1,02m/40 + 1,22m/48)

Electric PTO Clutch for CASTLE GARDEN



Order No. 10 - 14316

Electric PTO clutch replaces Castlegarden 19399060/0, 18399065/1, 1136-0837-01. TC 102/122. Warner 5217-38, 5217-20. 1" ID, 5.20" pulley for 5/8" belt.

ORDER NO.	REPLACES O.E.M. NO.	LENGTH	CENTER HOLE DIAM.	OUTSIDE HOLE DIAM.	CENTER TO CENTER	WIDTH	STEEL THICK.	APPLICATION
 15 - 50146	81004396/0	16-5/64" 406.59mm	47/64" 18.26mm	23/64" 9.00mm	2-9/16"2-13/64" 64.80mm	55.95mm	.125" 3.17mm	
 15 - 50145	81004397/0	18-3/64" 458.39mm	47/64" 18.26mm	23/64" 9.00mm	2-9/16"2-13/64" 64.80mm	55.95mm	.125" 3.17mm	









30

O.E.M.

O.E.M. REPLACEMENT
CASTELGARDEN (Cont.)



O.E.M.
30

ORDER NO.	REPLACES O.E.M. NO.	LENGTH	CENTER HOLE DIAM.	OUTSIDE HOLE DIAM.	CENTER TO CENTER	WIDTH	STEEL THICK.	APPLICATION
 15 - 11310	82004345/0	18-3/16" 462mm	.710" 18.3mm	.340" 8.7mm	2-1/2" 63.5mm	2-1/4" 57mm	.117" 3.0mm	Left Hand Blade
 15 - 11311	82004344/0	18-3/16" 462mm	.710" 18.3mm	.340" 8.7mm	2-1/2" 63.5mm	2-1/4" 57mm	.117" 3.0mm	Right Hand Blade
 15 - 50144	81004395	18-27/32" 478.63mm	47/64" 18.25mm	23/64" 9.00mm	2-9/16" 64.80mm	2-13/64" 55.95mm	.160" 4.00mm	
 15 - 13215	81004398/0	20" 508mm	.714 18mm			2-3/16" 55.5mm	.150" 3.8mm	Fits RL534, NP534TR, CA534TR, AL534TRE, TD534TRE, High Lift Blade.
 15 - 50142	82004340/0	20-1/2" 520.70mm	23/32" 18.25mm	23/64" 9.00mm	2-35/64" 64.80mm	2-13/64" 55.95mm	.160" 4.00mm	Takes (1) 50142 right hand cut and (1) 50143 blade. Comes as a set.
 15 - 50143	82004341/0	20-1/2" 520.70mm	23/32" 18.25mm	23/64" 9.00mm	2-9/16" 64.80mm	2-13/64" 55.95mm	.160" 4.00mm	Takes (1) 50143 left hand cut and (1) 50142 blade. Comes as a set.
 15 - 50162	82004343/0	24-7/16" 620.71mm	.714" 18.00mm	.343" 8.73mm	2.549" 64.69mm	2.165" 54.80mm	.160" 4.00mm	Left Hand Cut
 15 - 50163	82004342/0	24-7/16" 620.71mm	.741 18.00mm	.343" 8.73mm	2.549" 64.69mm	2.165" 54.80mm	.160" 4.00mm	Right Hand Cut



CASTELGARDEN (Cont.)

Size 3/8"-24 x 1-1/2"



Order No. 17 - 50166

Blade bolt replaces Castlegarden 12735695/0. Hex head, grade 8. Plain finish, left handed threads.

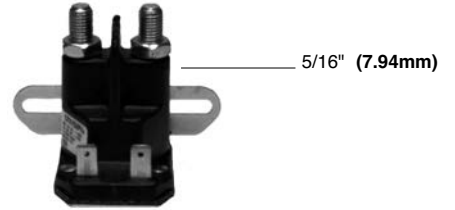

Order No. 31 - 50237

Solenoid replaces Castlegarden 18736100/0.



Order No. 31 - 13349

Neutral start switch replaces Castlegarden 19410611/0, 19410608/1, FC72/TC92. Transmission neutral start switch.

30

O.E.M.

O.E.M. REPLACEMENT



COMMERCIAL REPLACEMENT PARTS BREAK-DOWN FOR CUB CADET
REPLACEMENT PARTS FOR 42" CUB CADET DECK MOWERS, LT1000 SERIES

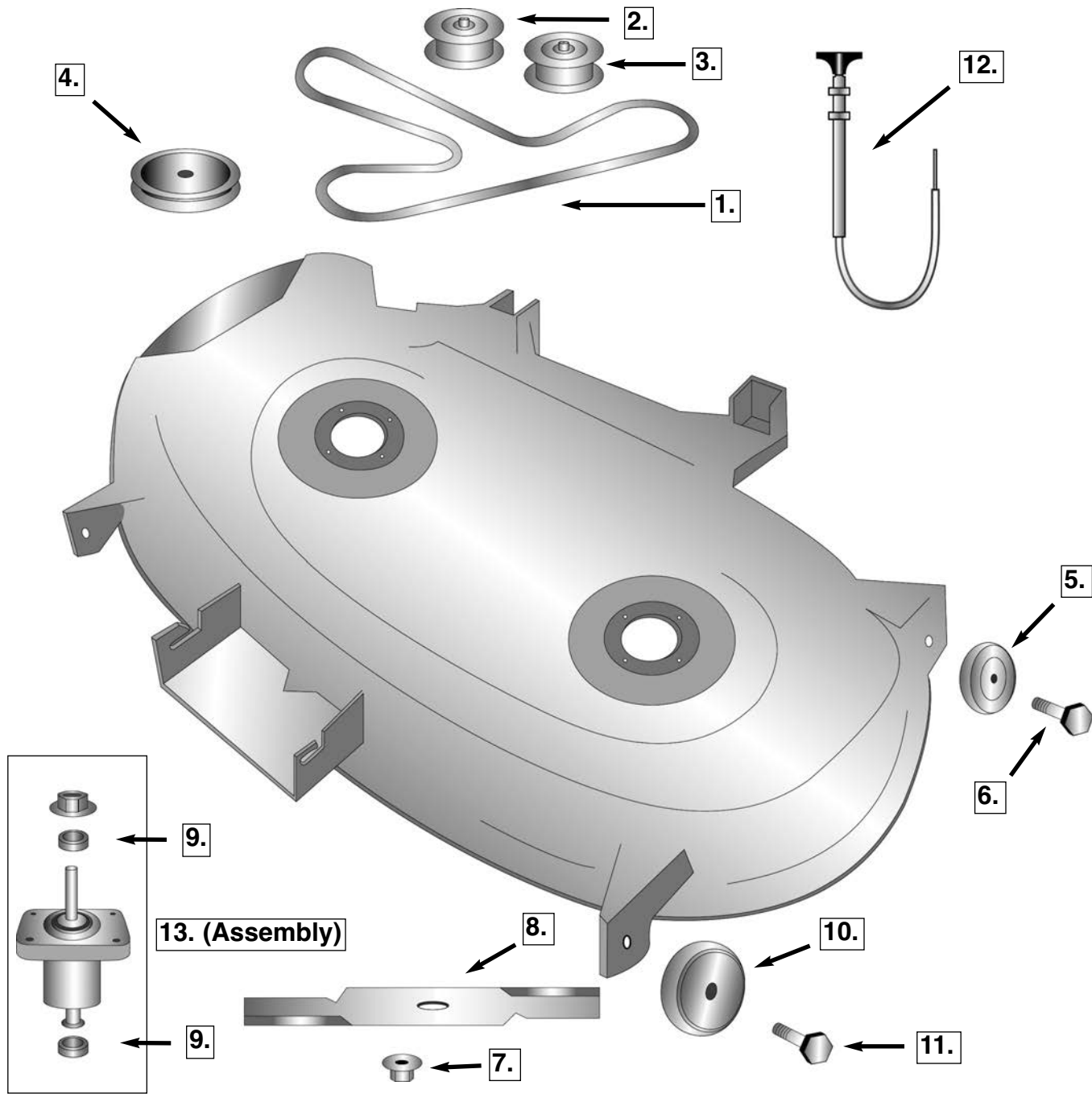

O.E.M. 30

Ref. No.	Order No.	Deck Size	Description/Replaces
1.	12-11660	42"	Belt / 954-04060B
2.	13-9377	42"	Idler Pulley / 756-04129B
3.	13-9377	42"	Idler Pulley / 756-04129B
4.	13-12682	42"	Spindle Pulley / 956-1227
5.	07-430	42"	Deck Wheel / 734-0973
6.	10-314	42"	Wheel Bolt / 938-0373
7.	10-10228	42"	Blade Nut / 712-0417A
8.	15-1031	42"	Blade / 942-04312

Ref. No.	Order No.	Deck Size	Description/Replaces
9.	09-442	42"	Bearing / 941-0919
10.	07-12648	42"	Deck Wheel / 734-04155
11.	10-7115	42"	Deck Wheel Bolt / 938-3056
12.		42"	PTO Cable / 946-04618
13.		42"	Spindle Assembly / 918-04822



**COMMERCIAL REPLACEMENT PARTS BREAK-DOWN FOR CUB CADET
REPLACEMENT PARTS FOR 46" CUB CADET DECK MOWERS, LT1000 SERIES**

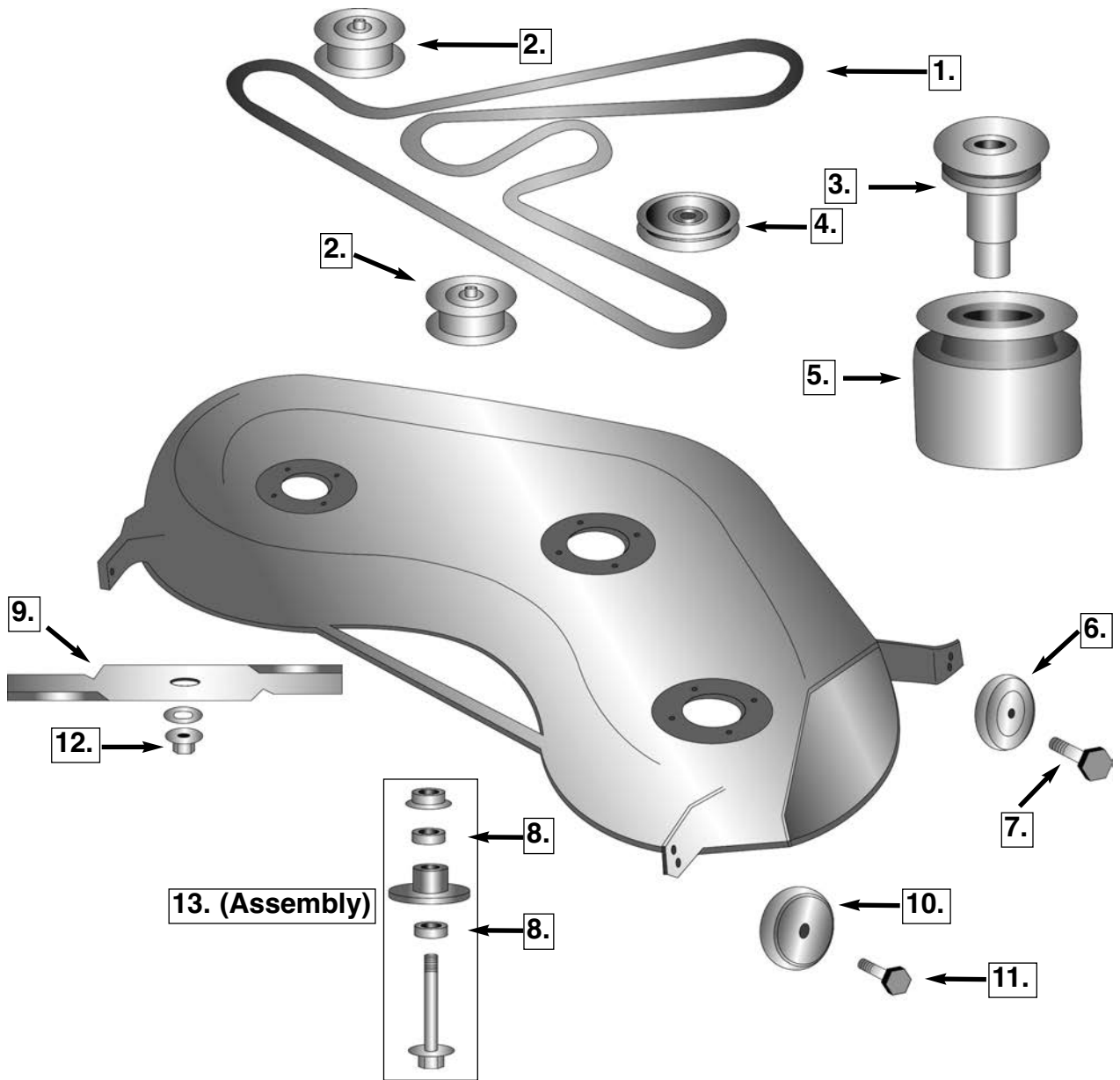

30
O.E.M.

Ref. No.	Order No.	Deck Size	Description/Replaces
1.	12-12790	46"	Belt / 954-04219
2.	13-9377	46"	Idler Pulley / 756-04129B
3.	13-12854	46"	Engine Pulley / 956-04067A
4.		46"	Spindle Pulley / 756-04356
5.	10-14229	46"	PTO Clutch / 917-04552
6.	07-430	46"	Deck Wheel / 734-0973
7.	10-314	46"	Wheel Bolt / 938-0373
8.	09-442	46"	Bearing / 941-0919

Ref. No.	Order No.	Deck Size	Description/Replaces
9.	15-12596	46"	Blade / 942-04244A
10.	07-12648	46"	Deck Wheel / 734-04155
11.	10-7115	46"	Deck Wheel Bolt / 938-3056
12.	10-10228	46"	Blade Nut / 712-0417A
13.	10-13029	46"	Spindle Assembly / 918-04865A

O.E.M. REPLACEMENT



COMMERCIAL REPLACEMENT PARTS BREAK-DOWN FOR CUB CADET
**REPLACEMENT PARTS FOR 50" & 54" CUB CADET DECK MOWERS,
 LT/GT1000 SERIES**

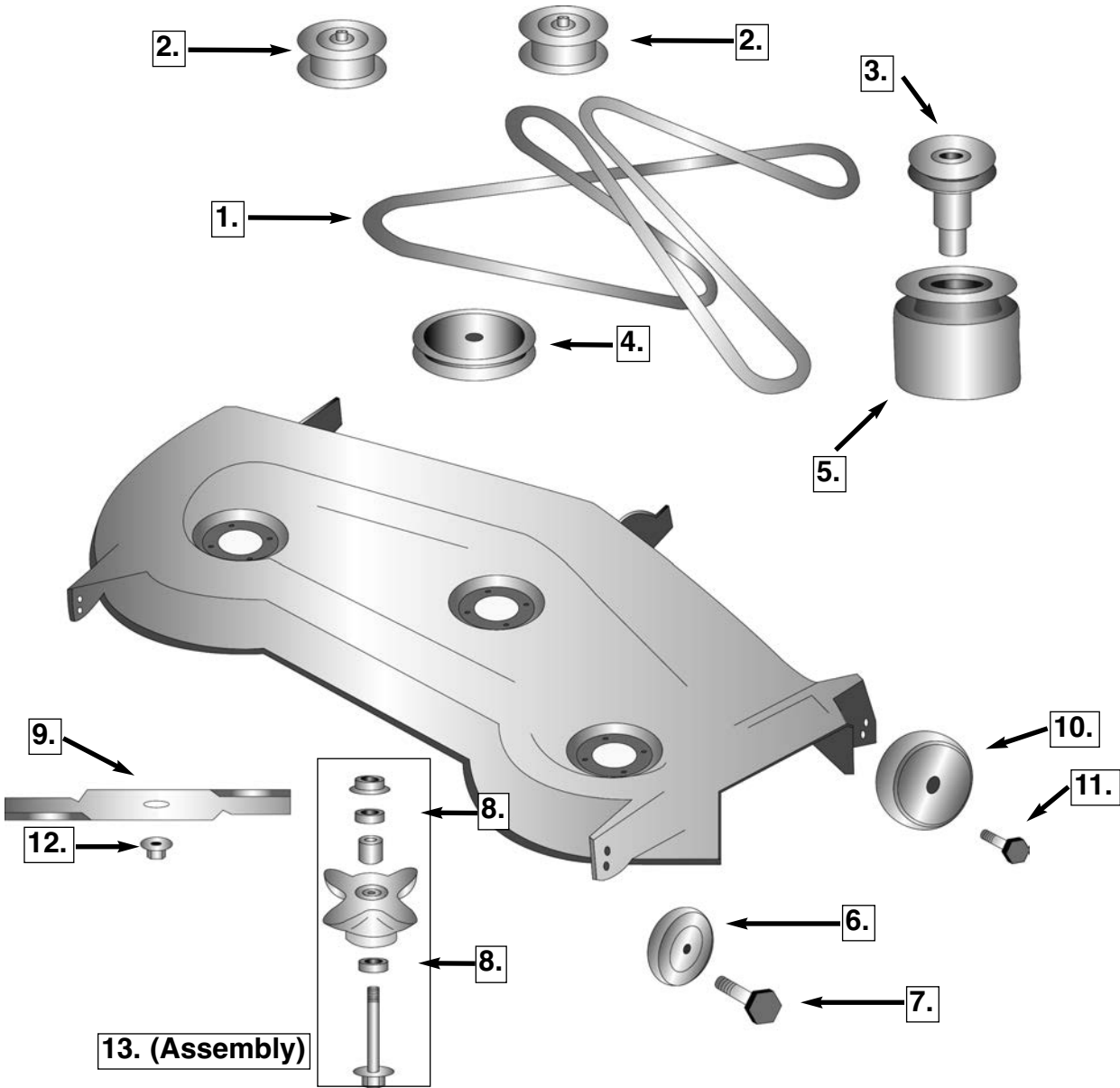

O.E.M. 30

Ref. No.	Order No.	Deck Size	Description/Replaces
1.	12-7583	50"	Belt / 942-0240
	12-11847	50"	Belt / 954-04077
1.	12-11661	54"	Belt / 942-00642
	12-11661	54"	Belt / 954-04083
2.	13-9377	50" & 54"	Idler Pulley / 756-04129B
3.		50" & 54"	Engine Pulley / 756-0978B
4.		50" & 54"	Spindle Pulley /
5.	10-14229	50"	PTO Clutch / 917-04552
	10-12621	50"	PTO Clutch / 917-04174A
5.	10-12424	54"	PTO Clutch / 917-1774C
6.	07-430	50"	Deck Wheel / 734-0973
7.	10-314	50"	Wheel Bolt / 938-0373
8.	09-442	50" & 54"	Bearing / 941-0919

Ref. No.	Order No.	Deck Size	Description/Replaces
9.	15-11507	50"	Blade / 942-4053C
9.	15-11719	54"	Blade / 942-0677B
10.	07-12648	50" & 54"	Deck Wheel / 734-04155
11.	10-7115	50" & 54"	Deck Wheel Bolt / 938-3056
12.	10-10228	50" & 54"	Blade Nut / 712-0417A
13.	10-11962	50"	Spindle Assembly / 918-04125B
		50"	Spindle Assembly / 918-05016
13.	10-11962	54"	Spindle Assembly / 918-04125B
	10-12612	54"	Spindle Assembly / 918-04608A



**COMMERCIAL REPLACEMENT PARTS BREAK-DOWN FOR CUB CADET
REPLACEMENT PARTS FOR CUB CADET DECK MOWERS,
LT1000 SERIES**

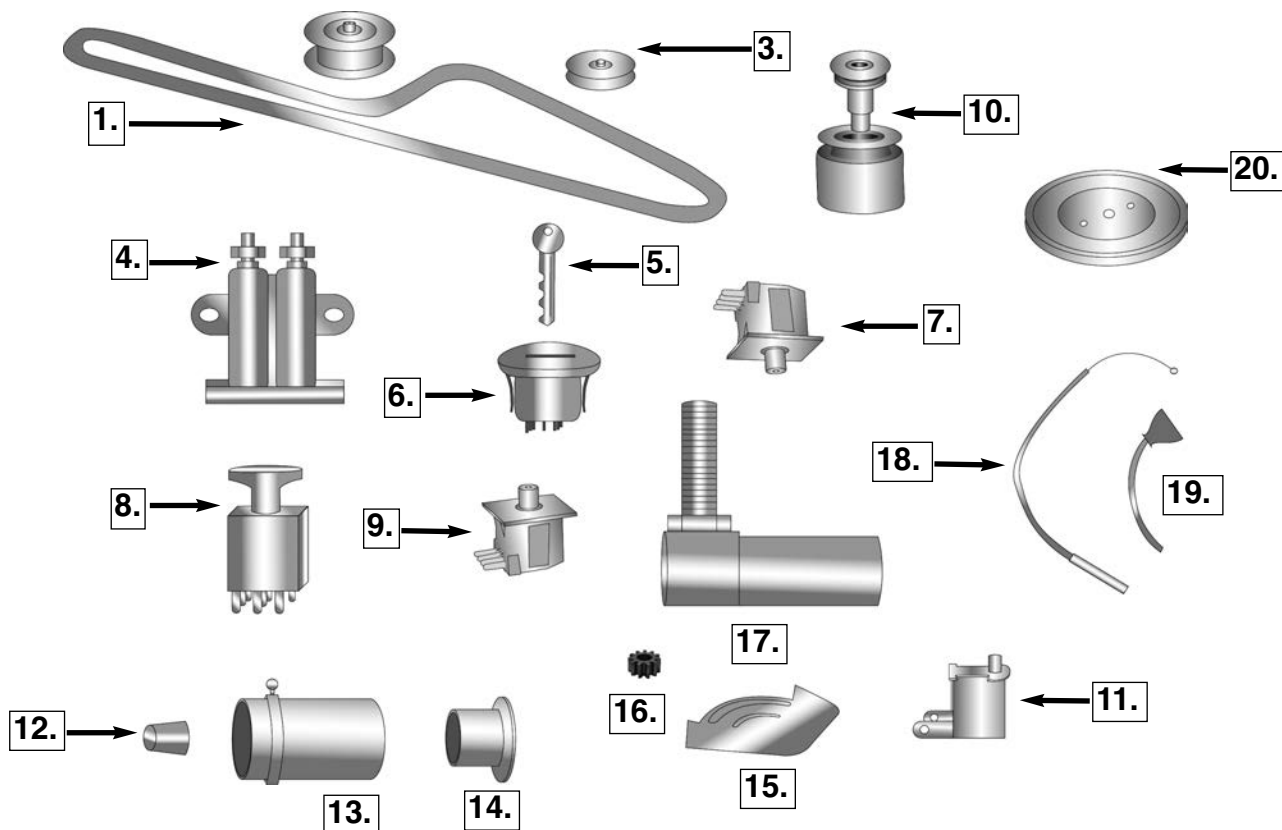

30
O.E.M.

Ref. No.	Order No.	Deck Size	Description/Replaces
1.	12-7483 12-12770 12-7528 12-11482		Belt / 942-0244 Belt / 954-04207 Belt / 954-04297 Belt / 954-0467A
2.	13-2188		Idler Pulley / 756-04224
3.	13-731		Idler Pulley / 756-04325
4.	31-14220		Solenoid / 725-04439
5.	31-11219		Key / 925-2054A
6.	31-7015		Ignition Switch / 925-04227B
7.			Safety Switch / 725-04363
8.			PTO Switch / 725-04258
9.			Safety Switch / 725-04232
10.	09-12854		Engine Pulley / 956-04067A

Ref. No.	Order No.	Deck Size	Description/Replaces
11.	31-14246		Seat Switch / 925-04040 Seat Switch / 925-05013
12.			Hub Cap / 731-0564
13.	09-12857		Bearing W Fitting / 741-0990B
14.			Bearing / 741-0516B
15.			Steering Sector / 717-1550F
16.	10-13360		Pinion Gear / 717-1554
17.	10-9159		Ball Joint / 923-0448A
18.			Kaw Throttle Control / 946-1100 Koh Choke Control / 946-04556 Koh Choke Control / 946-04617
19.			Kaw Choke / 746-04120
20.	13-12810		Trans Pulley / 956-04002

O.E.M. REPLACEMENT



COMMERCIAL REPLACEMENT PARTS BREAK-DOWN FOR CUB CADET
REPLACEMENT PARTS FOR RZT CUB CADET DECK MOWERS

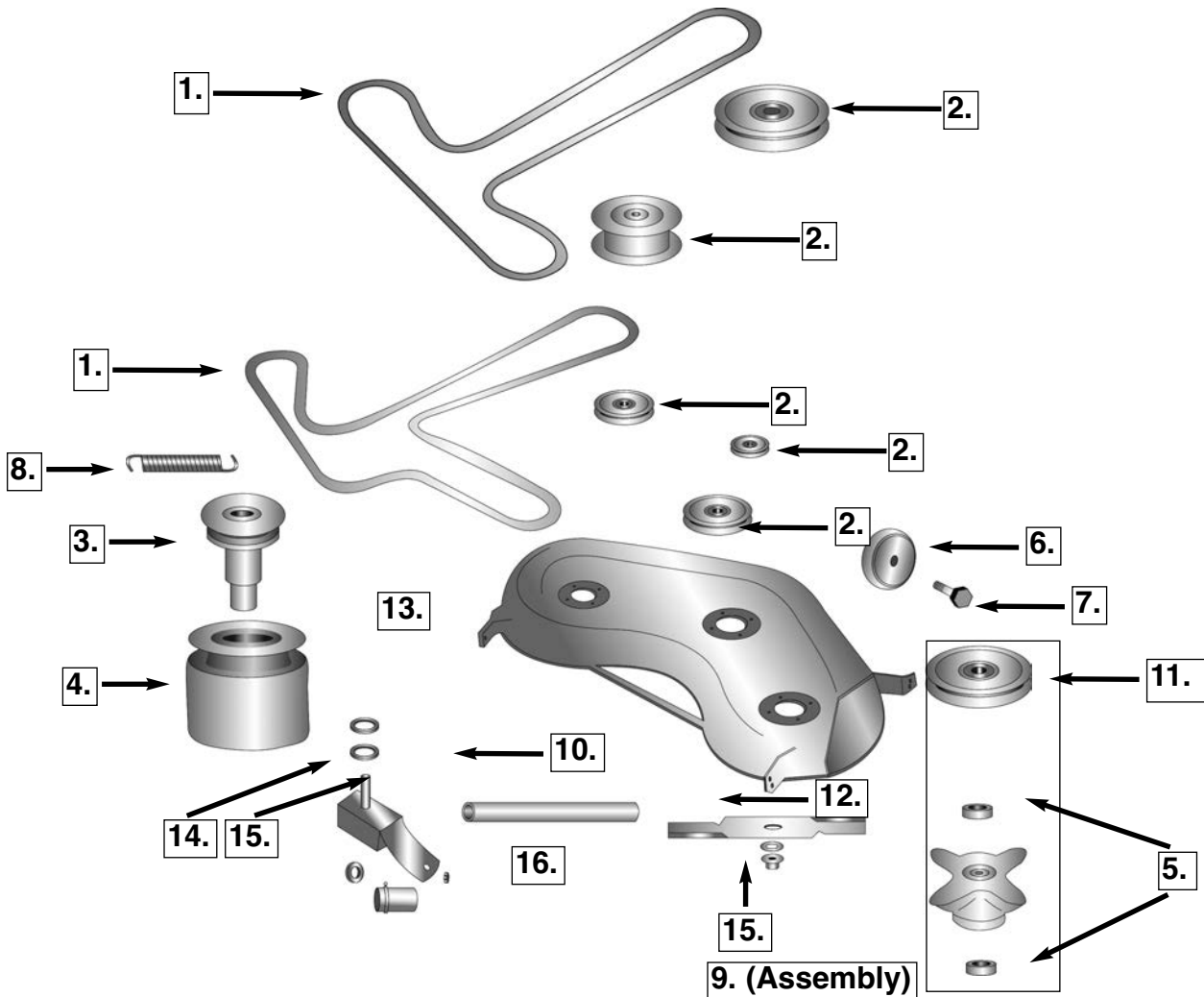

O.E.M. 30

Ref. No.	Order No.	Deck Size	Description/Replaces
1.	12-11845	42"	Belt / 954-04045
	12-12423	42"	Belt / 954-04137
	12-11844	50"	Belt / 954-04044A
	12-12768	54"	Belt / 954-04138A
2.	13-12675	42"	Idler / 756-04129B
	13-11144	42"	Idler / 756-0627D
	13-12675	50", 54"	Idler / 756-04129B
	13-13409	50"	Idler / 756-04141
	13-13409	50"	Idler / 756-1229
3.		42", 50	Engine Pulley / 756-04102A
		42", 50	Engine Pulley / 756-0978
		42", 50", 54"	Engine Pulley / 756-04376
4.		42"	PTO Clutch / 917-04127
		42", 50"	PTO Clutch / 917-04622
		42"	PTO Clutch / 917-04376A
	10-14229	50"	PTO Clutch / 917-04552
	10-12424	54"	PTO Clutch / 917-1774C
5.	09-442	42", 50", 54"	Bearing / 941-0919
6.	07-6916	42", 50", 54"	Deck Wheel / 753-04856A
	07-12648		Deck Wheel / 734-0155
7.	10-11142	42", 50", 54"	Bolt / 938-3056
	10-314	42", 50", 54"	Bolt / 938-0373
8.		42", 50", 54"	Deck Spring / 732-0459C
		42", 50", 54"	Deck Spring / 732-04609

Ref. No.	Order No.	Deck Size	Description/Replaces
9.	10-12883	42"	Spindle Assm. / 918-04197A
	10-12219	42"	Spindle Assm. / 918-0624A
		42	Spindle Assm. / 918-04822A
	10-11962	50"	Spindle Assm. / 918-04125B
	10-12612	54"	Spindle Assm. / 918-04608A
10.	10-8447	42", 50"	Nut / 712-3022
	10-9296	42", 50", 54"	Nut / 912-0239, 912-3058
11.	13-12884	42"	Pulley / 756-1188
	13-12682	42"	Pulley / 956-1227
		50", 54"	Pulley / 756-04216
12.	15-1031	42"	Blade / 942-04308, 942-0616A
	15-11570	50"	Blade / 942-04053C
	15-11719	54"	Blade / 942-0677B
13.		42", 50", 54"	Bushing / 731-05500, 931-0374
14.		42"	Wheel Bearing / 741-0516B
		50", 54"	Wheel Bearing /
15.	09-12857	42"	Wheel Bearing / 741-0990B
		50", 54"	Wheel Bearing /
		50", 54"	Spanner / 750-04775A
16.		50", 54"	Spanner / 750-04775A
17.	10-10228	42", 50", 54"	Blade Nut / 712-0417A



COMMERCIAL REPLACEMENT PARTS BREAK-DOWN FOR CUB CADET
REPLACEMENT PARTS FOR RZT CUB CADET DECK MOWERS

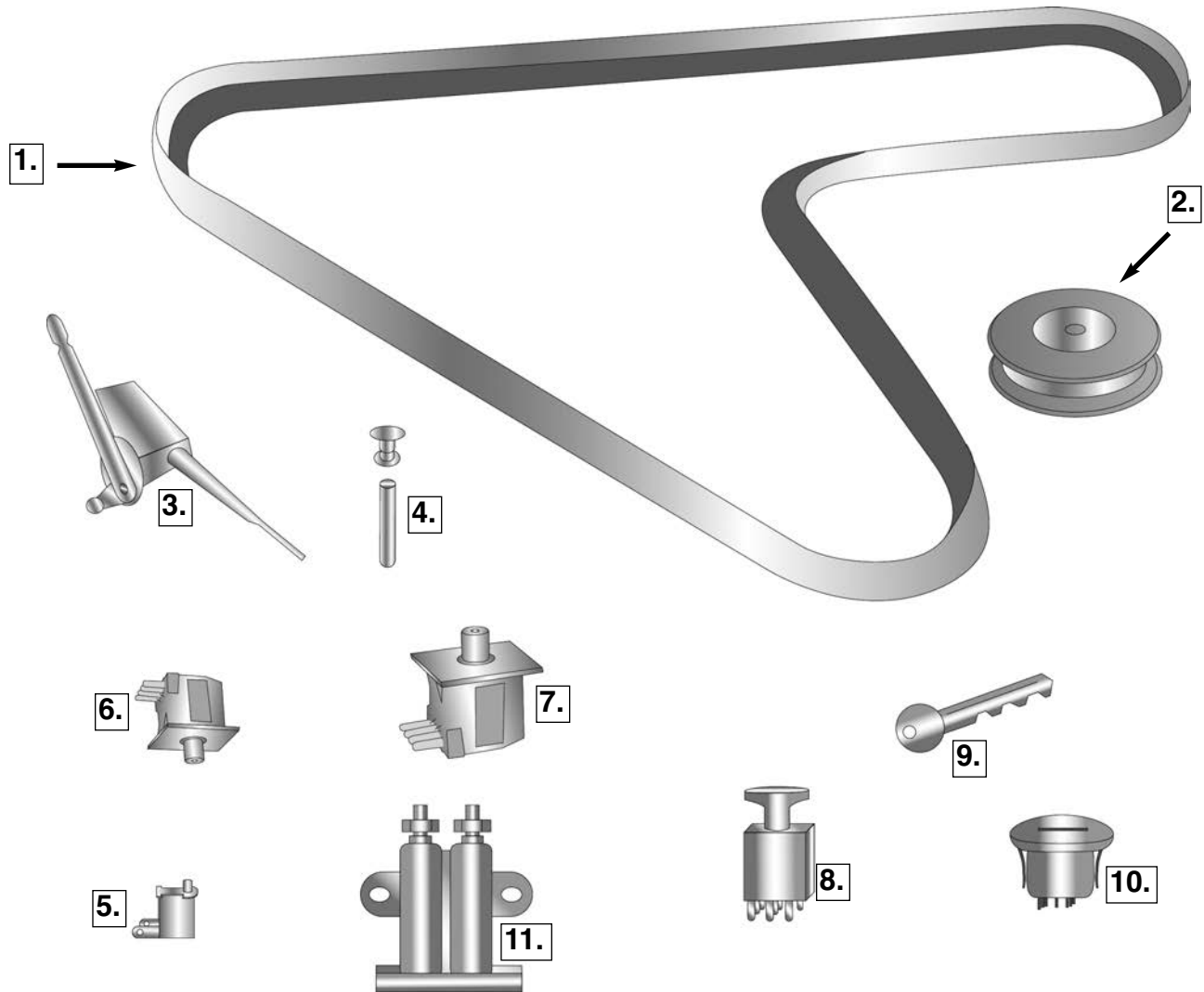

30
O.E.M.

Ref. No.	Order No.	Deck Size	Description/Replaces
1.	12-12382	42",50",54"	Belt / 954-4043A
2.	13-12675		Idler Pulley / 756-04129B
3.	03-10685	42"	Throttle / 756-04539
		42"	Throttle / 946-04161
		50", 54"	Throttle / 746-04539
		50", 50"	Throttle / 746-04066
		50", 54"	Throttle / 946-04581
4.		42",50",54"	Choke / 946-1086

Ref. No.	Order No.	Deck Size	Description/Replaces
5.	31-14246	42",50",54"	Seat Switch / 725-1439
	31-9664	42",50",54"	Seat Switch / 925-04040
6.		42",50",54"	Safety Switch / 725-04232 Safety Switch / 725-04363
7.	31-14247	42",50",54"	Ntrl Switch / 925-04165
8.	31-9657	42",50",54"	PTO Switch / 925-04174
9.	31-11219	42",50",54"	Ignition Key / 925-1745A
10.	31-9655	42",50",54"	Ignition Switch / 925-04228
11.	31-7935	42", 50"	Solenoid / 925-1426A
	31-10771	54"	Solenoid / 925-0771



O.E.M. REPLACEMENT

CUB CADET

Choke Control Cable for CUB CADET

Conduit 40-1/2"
Inner Wire 42-1/2"
Wire Travel 2"

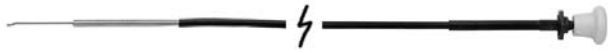

Order No. 03 - 14324

Choke control cable replaces Cub Cadet 746-04120. Push/Pull choke control. Fits models I1046, I1050, GT1222, GT1554, SLT1550, SLT1554, LT1018, LT1022, LT1024, LT1042, LT1045, LT1046 & LT1050.

Conduit 34"
Inner Wire 36-1/4"
Wire Travel 1-1/2"

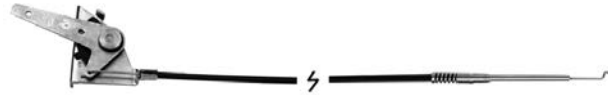

Order No. 03 - 14325

Choke control cable replaces Cub Cadet 746-04066. Fits models RZT 50/54 & GT1222.

30



Conduit 61"
Inner Wire 63"
Wire Travel 2"



Order No. 03 - 14621

Choke control cable replaces Cub Cadet 746-04214, 946-04214. Fits RZT50/54 mowers.



Conduit 37"
Inner Wire 39"
Wire Travel 1-3/4"



Order No. 03 - 14624

Choke control cable replaces MTD/Cub Cadet 746-1085A. Fits models 1170, 1180, 1212, 1800, LT1042, LT1045, LT1046 & LT1050.

O.E.M.

Pro-Gear Transmission 5 Speed



Order No. 42 - 14178

Pro-Gear T7512 5-Speed transmission replaces Peerless 700-083 & 794727, MTD Pro/Cub Cadet Commercial 01000152.

Pro-Gear Drive Shaft



Order No. 42 - 14179

Pro-Gear 30-1017 Drive Shaft. Replaces Peerless 771842. MTD Pro/Cub Cadet 00030352. 6-1/4" Long, 9-Spline.

Pro-Gear Coupler

Order No. 42 - 14185

Pro-Gear 30-1001 Coupler. Replaces Peerless 786177, MTD/Cub Cadet Commercial Turf 00030353. 9-Spline.



Order No. 06 - 11956

Deck wheel replaces Cub Cadet 734-3195. 3/4" OCRB, centered white wheel 6-1/4" x 3.00, 3/4" bore, rib tread. Painted white.



ID 1/2"
Width 2-3/4"
Height 5"

Order No. 07 - 6916

Deck wheel replaces Cub Cadet 734-3058B. 2-1/2" offset hub.



CUB CADET (Cont.)



Order No. 07 - 12648

5" Deck wheel replaces Cub Cadet 734-04155. 5" x 2-3/8" ID, 1/2" offset hub. 2-1/2" length, smooth tread.



ID 1/2"
Width 1-3/8"
Height 6"

Order No. 07 - 6918

Deck Wheel. Replaces Cub Cadet 734-3000. 1-1/2" centered hub.



Order No. 07 - 14446

5" x 2-5/8" x 5/8" plastic bushing, deck wheel replaces Cub Cadet / MTD 634-3159. 2-7/8" centered hub with grease fitting.



ID 1-1/4"
OD 1.874"
Height .25"

Order No. 10 - 12535

Oil seal replaces Cub Cadet 921-3018A / 721-3018A. Fits our **10-11961** spindle.



Order No. 10 - 11961

Spindle assembly replaces Cub Cadet 618-3129C. Fits series models 2130, 2146, 2155, 2164 & 2166, for 38", 42" & 44" cut decks. Includes upper and lower bearings and seals, spacer & housing. 3/4" bore. Uses our **09-813** bearings. Fits our **10-11963** Spindle assembly.



Order No. 10 - 11963

Spindle assembly replaces Cub Cadet 618-04129C. Fits 54" decks. CC models-LT1024, LT1050, SLT-1554. (tapered bearing and grease fitting). Fits our **10-11961** Housing.



Order No. 10 - 12871

Spindle housing replaces Cub Cadet 619-04183A / 619-04199 Fits LTX1042 Timed Deck & LTX1045 46" standard deck. Fits 2009-Up 46" decks with 2 blades. Fits our **10-13029** Spindle Assembly.



Order No. 10 - 13029

Spindle assembly replaces Cub Cadet 918-04865A, 918-04636, 618-04636. Fits 2009-up models LTX1045 series 46" decks with 2 blades. New style 6 pt star. Pulley Dia 6-1/2".

Order No. 10 - 12972

Spindle assembly replaces Cub Cadet 618-0595A, 618-0595B, 918-0595B, 918-0595A. Fits later model 46" deck - 800 series. Double pulley. Fits star hole blades.



30

O.E.M.

**O.E.M. REPLACEMENT
CUB CADET (Cont.)**



Order No. 10 - 13220

Spindle assembly replaces MTD 918-3167 / 618-3167 (2013), Troy Bilt 14115, 38" decks (GW-6183167). Also fits Cub Cadet model 250.



Order No. 10 - 11962

Spindle assembly replaces Cub Cadet 618-04126. Fits some 50" cut decks. Fits series 1000. Model LT1050.

30

O.E.M.



Order No. 10 - 12883

Spindle assembly replaces Cub Cadet 918-04197, 618-04197, 618-0427C, 918-0427C. Fits models 1170, 1600, 1800 and RZT mowers with 42" decks using star hole blades. Uses Cub Cadet 756-1188 & 618-0324, 5-9/16" pulley.



Order No. 10 - 12973

Spindle assembly replaces Cub Cadet 918-0659, 618-0659. Fits models LT1040, LT1042 & RTZ mowers with 42" decks using star hole blades.



Order No. 10 - 13001

Spindle assembly replaces Cub Cadet 918-04124A, 618-04124A. Fits models LT series mowers with 42" decks using round hole blades.

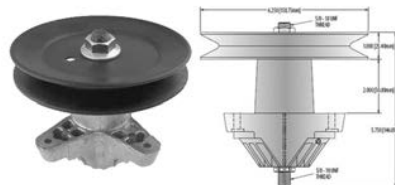

Order No. 10 - 13131

Spindle assembly replaces Cub Cadet 618-04461, 918-04461, 717-04461. Fits models LT series mowers with 42" decks using star hole blades.

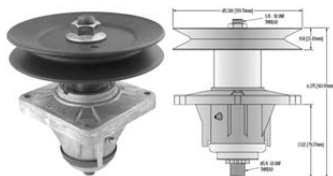

Order No. 10 - 12967

Spindle assembly replaces Cub Cadet 918-0660, 618-0660. Fits models LT1045, LT1046 and I1046 series mowers with 46" decks using star hole blades.



Order No. 10 - 12236

Spindle assembly replaces Cub Cadet 918-04123B, 618-04123B. Fits models LT series mowers with 46" decks using round hole blades.



Order No. 10 - 12659

Spindle assembly replaces Cub Cadet 918-0428A, 918-0268, 618-0428, 618-0428A, 618-0268, 618-0268A. Fits mowers with 50" decks.



Order No. 10 - 12660

Spindle assembly replaces Cub Cadet 918-0429, 618-0429, 618-0269, 918-0269. Fits mowers with 50" decks.



CUB CADET (Cont.)



Order No. 10 - 14328

Spindle assembly replaces Cub Cadet 918-04889A, 918-04822A, 618-04822A, 618-04950. Fits LTX1040 tractor (2010 & after), 13AX90AS010, 13RX90AS056, 13AX90AS009, 13WX90AS010, 13WX90AS009, 13AX90AS209, 13RX90AS256, 13WX90AS209. LTX1042 tractor (2010 & after), 13AX9124010 (2010), 13WX91AS010 (2010)

Order No. 10 - 14329

Spindle assembly replaces Cub Cadet 918-04825B, 918-05016, 618-04825, 618-05016. Fits LTX1050VT tractor (2010 & after), 13VR91AP010 (2010), 13WR91AP010 (2010), 13VR91AP009 (2010), 13WR91AP009 (2010). PULLEY DIA. 5.3". Uses our 13-11711 pulley.



Order No. 10 - 14229

Electric PTO clutch replaces Cub Cadet 917-04552A, 717-04552. Fits LTX1042, LTX1045, LTX1046, LTX1050, 2008 and newer RZT 50, FMZ50. Warner 5219-98. 1" ID, 6" pulley for 1/2" belt.

Order No. 10 - 14045

Electric PTO clutch replaces Cub Cadet 917-3390, 717-3390. Fits 2185 tractor. Also replaces Warner 5215-69. 1-1/8" ID 6" pulley, Direction: Counter Clockwise, 5/8" belt.



Order No. 10 - 9910

Electric PTO clutch replaces Cub Cadet 717-0949/917-0949 & 717-1434/917-1434. 1" ID, Keyed Hub, 5.304 Dia. Pulley. Warner No. 5215-51.

Order No. 10 - 12899

Electric PTO clutch replaces Cub Cadet 917-04180. Fits GT2500 series & LT2042, GT2544, GT2550, GT2554. 1-1/8" x 6" pulley, 5/8" belt. Warner 5219-52.



Order No. 10 - 11859

Electric PTO clutch replaces Cub Cadet 917-04163. 1" x 5.923" pulley, type A/B belt. Warner 5217-32.

Order No. 10 - 9913

Electric PTO clutch replaces Cub Cadet WD-C38410. Double Pulley, 1-1/8" ID x 3-3/4" Height, 5" dia Pulley, 1/2 belt. Warner No. 5215-62.



Order No. 10 - 9911

Electric PTO clutch replaces Cub Cadet 717-1459/917-1459. 1" ID x 3" Height, 5.375 Pulley, 5/8" belt.

Order No. 10 - 11072

Electric PTO clutch replaces Cub Cadet 01002108P. Fits Tank models. Also fits Lesco. Warner 5218-14.

30

O.E.M.

O.E.M. REPLACEMENT
CUB CADET (Cont.)



Order No. 10 - 12227

Electric PTO clutch replaces Cub Cadet 917-3497. Also replaces Jacobsen 990947, Toro 99-8012, Simplicity 1703816, Snapper 16343. 1" ID x 5.345" Pulley, 5/8" belt. Warner 5215-59.



Order No. 10 - 12228

Electric PTO clutch replaces Cub Cadet 917-3403. 1-1/8" ID x 6" pulley, uses type B belt. Warner 5218-6.



Order No. 10 - 12621

Electric PTO clutch replaces Cub Cadet 717-04174/917-04174. Warner 5219-51. Shaft size 1", 6" pulley diameter, 5/8" Belt. Fits models LT1045, LT1050.



Order No. 10 - 12309

Electric PTO clutch replaces Cub Cadet 917-3375, 717-3384. 1.11" ID x 4.825" height, 5.31" pulley diameter, 1/2" Belt. Warner 5215-73. Clockwise direction.



Order No. 10 - 12230

Electric PTO clutch replaces Cub Cadet 917-3389, 717-3384, 717-3389, 717-3375. 1" ID x 4.825" HT 6" pulley, uses type B belt. Warner 5215-68.



Order No. 10 - 12231

Electric PTO clutch replaces Cub Cadet 717-3385A. Fits 2000 series models 2130, 2135, 2146, 2150, 2155, 21665, 38" & 42" cut decks. 1" x 5.345" pulley, A/B belt. Warner 5217-14.



Order No. 10 - 12247

Electric PTO clutch replaces Cub Cadet 717-04080 / 917-04080. 1" x 6" pulley. Uses type B belt 5/8". Warner 5215-142.



Order No. 10 - 11445

Electric PTO clutch replaces Cub Cadet 717-3044. 5.375" Dia. Pulley. 5/8" Belt, shaft size 1-1/8". Warner 5218-110.



Order No. 10 - 13973

Electric PTO clutch replaces Cub Cadet 917-3446 / 717-3446. Warner 5218-29. 6" Dia. Pulley, 5/8" Belt, shaft size 1". Fits models 2160, 2164, 2165, GT2521, LT2180 serial no. 326,006 and up. Mfg date B037G3 and after.

Overall 3-5/8"



Order No. 10 - 11142

Shoulder bolt replaces AYP 184219 / 137644, 193406, Cub Cadet 938-3056, John Deere 193406. Fits deck wheels on riders 2003 & up. MIN010

30

O.E.M.



CUB CADET (Cont.)



Order No. 10 - 12622

Blade bolt replaces Cub Cadet 710-04226. Fits LT 1000 series riders and Cub Cadet 618-04123B spindle assembly. For 38", 42", 46" & 50" decks. Size 3/4" - 16 x 5.85"



Order No. 10 - 14437

Damper replaces Cub Cadet 02003622. Fits Cub Cadet, MTD commercial turf.

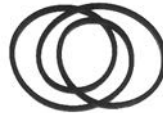

Order No.

Description

12 - 10563	V Belt. Replaces Cub Cadet 954-3038. 1/2" (12.7 mm) x 60-1/2" (1536.7 mm). Fits 1000 series, 38"decks. Wrapped molded, aramid cord construction.
12 - 10563	V Belt. Replaces Cub Cadet 954-3038. 1/2" (12.7 mm) x 60-1/2" (1536.7 mm). Fits 1000 series, 38"decks. Wrapped molded, aramid cord construction.
12 - 10783	Deck Belt. Replaces Cub Cadet 954-0644. 1/2" (12.7 mm) x 60" (1524 mm). Fits 42" decks. Wrapped molded, aramid cord construction.
12 - 10784	Deck Belt. Replaces Cub Cadet 954-0645. 1/2" (12.7 mm) x 67" (1721.9 mm). Fits 42" decks. Wrapped molded, aramid cord construction.
12 - 10783	Deck Belt. Replaces Cub Cadet 954-0644. 1/2" (12.7 mm) x 60" (1524 mm). Fits 42" decks. Wrapped molded, aramid cord construction.
12 - 10784	Deck Belt. Replaces Cub Cadet 954-0645. 1/2" (12.7 mm) x 67" (1721.9 mm). Fits 42" decks. Wrapped molded, aramid cord construction.
12 - 10782	Deck Belt. Replaces Cub Cadet 954-3073. 1/2" (12.7 mm) x 62" (1574.8 mm). Fits 2000 series, model 190-142, 42" deck A62 spindle. Wrapped molded, aramid cord construction.
12 - 12609	Deck Belt. Replaces Cub Cadet 754-04118 / 954-04118 . 1/2" (12.7 mm) x 122-1/2" (3111.5 mm). Fits new 46" deck, model L1046, LT1045 & LT1046. Wrapped molded, aramid cord construction, double cover clutching, color white.
12 - 12768	Deck Belt. Replaces Cub Cadet 754-04138 . 5/8" (15.875 mm) x 143" (3606.8 mm). RTZ54. General purpose, aramid cord construction.
12 - 12769	Deck Belt. Replaces Cub Cadet 754-04153 . 1/2" (12.7 mm) x 122" (3632.2 mm). Fits LT1045 & LT1046. General purpose, aramid cord construction.
12 - 12708	Deck Belt. Replaces Cub Cadet 02000154 . 1/2" (12.7 mm) x 83.4" (2118.36 mm). General purpose, aramid cord construction.
12 - 11820	Deck Drive Belt. Replaces Cub Cadet 754-3068. 5/8" (15.875 mm) x 110.9" (2816.8 mm). Fits 44" deck, 2500 series models.
12 - 11843	Deck Drive Belt. Replaces Cub Cadet 754-04033. 1/2" (12.70 mm) x 118-1/4" (3003.5 mm). Fits 46" deck LT1045 & LT1046 models.
12 - 11844	Deck Drive Belt. Replaces Cub Cadet 754-04044. 1/2" (12.70 mm) x 134" (3149.6 mm). Fits 50" deck models. Aramid, double cover, clutching belt.

**O.E.M. REPLACEMENT
CUB CADET (Cont.)**



Description

30

O.E.M.

Order No.	Description
12 - 11845	Deck Drive Belt. Replaces Cub Cadet 754-04045 & Toro 112-5800. 1/2" (12.7 mm) x 109.10" (2771.14 mm). Fits 42" decks. Wrapped molded general purpose, aramid cord, double clutching cover.
12 - 11997	Deck Drive Belt. Replaces Cub Cadet 754-3055A. 5/8" (15.875 mm) x 112-1/2" (2857.5 mm). Fits 38" & 42" decks on Cub Cadet 2000 series. Wrapped molded general purpose, polyester cord construction, double cover.
12 - 11850	Deck Drive Belt. Replaces Cub Cadet 754-0641/954-0641. 1/2" (12.7 mm) x 105" (2667 mm). Fits 1500 series lawn tractors with 38" deck. Aramid, double clutching cover.
12 - 11846	Blade Drive Belt. Replaces Cub Cadet 754-04062. 1/2" (12.7 mm) x 77-3/4" (1974.85 mm). Fits most 2005-2006 38" riding mowers. Aramid, double cover.
12 - 11847	Blade Drive Belt. Replaces Cub Cadet 754-04077/954-04077. 5/8" (15.875 mm) x 133.7" (3395.98 mm) Fits LT1050 50" riding mowers. Aramid, double clutching cover.
12 - 11849	Blade Drive Belt. Replaces Cub Cadet 754-0640 / 954-0640. 5/8" (15.875 mm) x 79.24" (2012.69 mm) Fits 1500 series riding mowers, with 46" deck. Drive belt fits LT1000 series. Aramid, double cover.
12 - 12051	Blade Drive Belt. Replaces Cub Cadet 954-3039. 1/2" (12.7 mm) x 103" (2616.2 mm). Fits 2000 series with 46" deck & 2000 series with 48" deck. Aramid, double cover.
12 - 11840	PTO Belt. Replaces Cub Cadet 754-04064. 5/8" (15.875 mm) x 68-1/4" (1733.5 mm). Fits 600 series riding mowers. Aramid Cord, Double wrapped clutching cover.
12 - 10901	PTO Belt. Replaces Cub Cadet 754-3084 / 954-3084. 1/2" (12.7 mm) x 37-5/8" (955.7 mm). Fits 3000 series. Matched set of 2 belts. Sold as set. Aramid, double cover.
12 - 10830	PTO Deck Drive Belt. Replaces Cub Cadet 490489-R2. 1/2" (12.7 mm) x 81-1/2" (2070.1 mm). Fits 38", 42", & 48" cut on models 70, 86, 123 & 169. Wrapped polyester cord construction.
12 - 12873	PTO V-Belt. Replaces Cub Cadet 754-04185 . 1/2" (12.7 mm) x 89.24" (2266.6 mm). Fits Craftsman Revolution tractor model 247.28933. Also fits. Cub Cadet i series zero turn tractors. MTD model 17AK9TKR099. Raw edge belt.
12 - 10781	Spindle Drive Belt. Replaces Cub Cadet 954-3036. 1/2" (12.7 mm) x 63" (1600.2 mm). Fits model 190-331, 38" ,manual PTO mower decks. Wrapped molded, aramid cord construction.
12 - 10781	Spindle Drive Belt. Replaces Cub Cadet 954-3036. 1/2" (12.7 mm) x 63" (1600.2 mm). Fits model 190-331, 38" ,manual PTO mower decks. Wrapped
12 - 12850	Transmission PTO Belt. Replaces Cub Cadet 01007015 . 1/2" (12.7mm) x 51.2"(1300.5 mm). Fits models M48-M72. Aramid cord clutching cover, white.

*Made with KEVLAR® or non-trade marked Aramid fiber.



CUB CADET (Cont.)



ID 3/8"
OD 5"
Height 1-1/8"

Order No. 13 - 12275

Idler pulley replaces Cub Cadet 756-3045.



ID 3/8"
OD 4-1/4"
Height 3/4"

Order No. 13 - 12276

Idler pulley replaces Cub Cadet 01004081.



ID 3/8"
OD 4.88"
Height 1"

Order No. 13 - 12277

Idler pulley replaces Cub Cadet 01004101.



ID 5/8"
OD 6-5/16"
Height 5/8"

Order No. 13 - 12682

Idler pulley replaces Cub Cadet 756-1227. Fits 42" decks on models LT1000 series 2007 and after. Fits Cub Cadet 618-0624 spindle.



ID 12 point Hex"
OD 5-9/16"
Height 5/8"

Order No. 13 - 12884

Spindle pulley replaces Cub Cadet 756-1188. Fits our 10-12883 Spindle.



ID 3/8"
OD 4-29/32"
Height 1-13/64"

Order No. 13 - 13409

Idler pulley replaces Cub Cadet 756-1229. Also replaces 2005077 & 1004081. Fits LT series and RZT series decks.



ID 3/8"
OD 4"
Height 1-3/8"

Order No. 13 - 14091

Idler pulley replaces MTD/Cub Cadet 756-0542. Fits Cub Cadet Z-Force models with 42" decks.



ID 3/8"
OD 5"
Height 1-7/16"

Order No. 13 - 14090

Idler pulley replaces MTD/Cub Cadet 756-3062.



ID 12 pt
OD 4"
Height 1"

Order No. 13 - 11711

Spindle pulley replaces Cub Cadet 756-04216. S9G-545 x 12 pt Hex Ch. Fits our 10-14329 spindle.













30

O.E.M.















O.E.M. REPLACEMENT
CUB CADET (Cont.)

O.E.M. 30

ORDER NO.	REPLACES O.E.M. NO.	LENGTH	CENTER HOLE DIAM.	OUTSIDE HOLE DIAM.	CENTER TO CENTER	WIDTH	STEEL THICK.	APPLICATION
 15 - 6075	759-3848/759-3844 477-598-R3 490-471-R1	11" 279.4mm	3/4" 19.1mm			2-1/2" 63.5mm	.204" 5.2mm	1968 to 1973 models Takes (2) 15-6075 & (1) 15-6077 for 42" cut
 15 - 1030	942-04126 742-04126 742-04124 942-04124 942-0612 742-0612	14-13/16" 376.2mm	"H" Pattern	3/8" 9.5mm	2-1/2" 63.5mm	2-1/2" 63.5mm	.150" 3.8mm	Take (1) 15-1030 & (2) 15-1029 for 46" cut. Fits models 600 & 800 series. 1997 & after, side discharge tractors. Mulching blades.
 15 - 11476	742-04016	14-7/8" 377.8mm	3/4" 19.1mm			2-1/2" 63.5mm	.204" 5.2mm	3 in 1 blade. Center blade for 46" cut. Fits deck series 1500, 1529, LT1045 & 1046. Uses (1) 15-11476 & (2) 15-11478 .
 15 - 6081	759-8312 742-3002	15-1/8" 384.2mm	3/4" 19.1mm			2-1/2" 63.5mm	.204" 5.2mm	(3) for 44" cut Current models
 15 - 11805	01008616	15.94" 405mm	3/4" 19.1mm			3" 76.2mm	.204" 5.2mm	Fits Z Force Zero Turn Rider. High Lift Blade (3) blades for a 44" cut.
 15 - 10636	759-3939	16" 406.4mm	3/4" 19.05mm	5/16" 7.94mm	2-1/2" 63.5mm	2-1/2" 63.5mm	.204" 5.2mm	(3) blades for a 44" cut. Used on mowers from 2001 to present.
 15 - 11478	742-04015	16-1/4" 412.75mm	3/4" 19.1mm			2-1/2" 63.5mm	.204" 5.2mm	3 in 1 blade. Outer blade for 46" cut. Fits deck series 1500, 1529, LT1045 & 1046. Uses (1) 15-11476 & (2) 15-11478 .
 15 - 11564	1004772	16-1/2" 419.1mm	3/4" 19.05mm			3" 76.2mm	.204" 5.2mm	Fits Zero Turn Rider (3) blades for 48" cut.
 15 - 6240	742-3025 759-3825 742-3019	16-1/2" 419.1mm	3/4" 19.1mm	5/16" 7.9mm	2-1/2" 63.5mm	2-1/2" 63.5mm	.204" 5.2mm	(3) blades for 48" cut garden tractor model 2000 & Pro mid size walk behind
 15 - 10361	01005336	17" 431.8mm	3/4" 19.1mm			3" 76.2mm	.204" 5.2mm	(3) blades for 48" cut. High Lift Blade Fits Tanks Models
 15 - 6082	759-3813 742-3003	17-3/16" 436.6mm	3/4" 19.1mm			2-1/2" 63.5mm	.204" 5.2mm	(3) blades for 50" cut
 15 - 11479	759-04047 742-04068	17.9" 454.6mm	3/4" 19.05mm			2-1/2" 63.5mm	.150" 3.8mm	Fits 1000 series Hydro- static lawn tractors. Model LT1024. (3) blades for 50" cut.

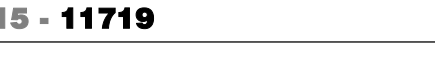

CUB CADET (Cont.)

ORDER NO.	REPLACES O.E.M. NO.	LENGTH	CENTER HOLE DIAM.	OUTSIDE HOLE DIAM.	CENTER TO CENTER	WIDTH	STEEL THICK.	APPLICATION
 15 - 11506	742-04068	17.9" 454.6mm	3/4" 19.05mm			2-1/2" 63.5mm	.187" 4.8mm	Fits 1000 series Hydrostatic lawn tractors. Model LT1024. Heavy Duty (3) blades for 50" cut.
 15 - 11480	742-04056 742-04053A	17.9" 454.6mm	Star			2-1/2" 63.5mm	.150" 3.8mm	Fits RZT series Tractors. Model RZT50 (3) blades for 50" cut.
 15 - 11507	742-04053A	17.9" 454.6mm	Star			2-1/2" 63.5mm	.187" 4.8mm	Fits RZT series Tractors. Heavy Duty Model RZT50 (3) blades for 50" cut.
 15 - 12809	742-04053A 942-04053A	17.9" 454.66mm	star			2-1/2" 63.5mm	.187" 4.8mm	Mulching Blade PATENTED Fits RTZ series tractors.
 15 - 12909	742-04154	17.9" 454.6mm	59/64" X 11/16"			2-1/2" 63.5mm	.160" 4.0mm	(2) blades for a 33" cut walk behind.
 15 - 11250	01010168	17-29/32" 454.8mm	3/4" 19.05mm			2-1/2" 63.5mm	.204" 5.2mm	High Lift Blade (3) blades for a 50" cut. Fits Tank Commercial.
 15 - 6239	759-3841 759-3820 742-3013	18-1/2" 469.9mm	3/4" 19.1mm			3" 76.2mm	.204" 5.2mm	(3) blades for 54" cut garden tractor and Pro mid size walk behind
 15 - 11719	742-0677 942-0677	18-1/2" 469.9mm	"H" Pattern			3" 76.2mm	.204" 5.2mm	(3) blades for 54" cut. Fits 2002 and newer models 54" riders.
 15 - 12893	742-0739 942-0739	19" 482.6mm	59/64" X 11/16"			2-1/4" 57.2mm	.125" 3.18mm	Mulching Blade Fits 19" Walk behinds mowers.
 15 - 10362	01005337	19" 482.6mm	3/4" 19.1mm			3" 76.2mm	.204" 5.2mm	(3) blades for 54" cut. High Lift Blade Fit tank models
 15 - 6147	759-3816 742-3008	19-5/16" 490.5mm	3/4" 19.1mm			3" 76.2mm	.204" 5.2mm	(2) blades for 38" cut High lift
 15 - 11477	759-3829 742-3032	19-3/8" 492.3mm	3/4" 19.1mm			2-3/4" 69.85mm	.204" 5.2mm	3 in 1 blade. Fits deck series 2315 & 2146. (2) blades for a 38" cut.V

30
O.E.M.

O.E.M. REPLACEMENT
CUB CADET (Cont.)



O.E.M. 30

ORDER NO.	REPLACES O.E.M. NO.	LENGTH	CENTER HOLE DIAM.	OUTSIDE HOLE DIAM.	CENTER TO CENTER	WIDTH	STEEL THICK.	APPLICATION
15 - 6238	759-3817 742-3009	19-3/8" 492.1mm	3/4" 19.1mm	5/16" 7.9mm	2-1/2" 63.5mm	3" 76.2mm	.204" 5.2mm	(2) blades for 38" cut front engine rider models 1015, 1020, 1030, 1715 & 1720
15 - 10383	1004719	20-1/2" 520.7mm	3/4" 19.05mm			3" 76.2mm	.204" 5.2mm	(3) blades for a 60" cut. Fits Cub Cadet & MTD Pro "ZERO TURN"s with stamped steel decks.
15 - 10363	01005338	21" 533.4mm	3/4" 19.1mm			3" 76.2mm	.204" 5.2mm	(3) blades for 60" cut. High Lift Blade Fits Tanks models
15 - 6237	759-3824 742-3018	21-3/16" 538.2mm	3/4" 19.1mm	5/16" 7.9mm	2-1/2" 63.5mm	3" 76.2mm	.204" 5.2mm	(2) blades for 42" cut garden tractor models 2000 & 1440
15 - 6078	759-3853 547-191-R1	21-1/4" 539.8mm	3/8" 9.5mm	17/32" 5.6mm	4-1/2" 114.3mm	2-1/2" 63.5mm	.204" 5.2mm	(3) for 60" cut
15 - 11475	759-3830 742-3033 742-04101	21-1/4" 539.75mm	3/4" 19.1mm			2-3/4" 69.85mm	.204" 5.2mm	3 in 1 blade. Fits deck series 1500 & 1517. (2) blades for a 42" cut.
15 - 6077	759-3850/759-3843 477-597-R3 490-473-R1	22-3/16" 563.6mm	3/4" 19.1mm			2-1/2" 63.5mm	.204" 5.2mm	1968 to 1973 models Takes (1) 15-6077 & (2) 15-6075 for 42" cut.



Order No. 18 - 8284

Muffler replaces Cub Cadet 393840-R91 garden tractors. Fits 7, 10 & 12 hp engines.



Order No. 19 - 2774

Filter replaces Cub Cadet 117210C1/759-3547.



ID 4-3/4"
OD 6"
Height 3"

Order No. 19 - 1388

Filter replaces Cub Cadet 759-3359, 61606C1.



Order No. 19 - 2844

Prefilter for our filter 19-1388.



CUB CADET (Cont.)



Order No. 19 - 6680

Transmission filter. Replaces Cub Cadet 923-3014 & 723-3014 & 759-3605. 25/30 Micron. 3.79" height, 3.660" OD, Thread size 3/4-16

Order No. 19 - 8631

Hydro filter replaces Cub Cadet 723-04032A. 10 Microns. 3.790" height, 3.66" OD, Thread size 1 - 12



Order No. 19 - 5863

Prefilter for our filter 19-2774.



Order No. 20 - 2235

Vented Fuel Cap. Replaces Cub Cadet



Order No. 26 - 13473

Electric starter. Used on Cub Cadet zero-turn mowers.



Order No. 26 - 13379

Electric starter. Used on Cub Cadet 23-27 hp engines.



Order No. 31 - 9622

Multi-application Start ignition switch only fits Cub Cadet. Includes key, lockwasher nut. 2 terminals/ 2 positions. "Spring Back"



Order No. 31 - 12752

Ignition switch replaces Cub Cadet 725-3163A / 925-3163A. Also replaces Troy Bilt & Bolens 1754183.

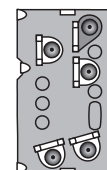

Order No. 31 - 12757

PTO toggle switch replaces Cub Cadet 725-0893 / 925-0893. Fits most box-frame electric clutch applications.

30

O.E.M.

**O.E.M. REPLACEMENT
CUB CADET (Cont.)**



Order No. 31 - 12762

PTO switch replaces Cub Cadet 725-3233 / 925-3233. Fits models Z42-Z54, 364365, 1515-1529, 2130-2186 & GT2000. Yellow Knob.



Order No. 31 - 14331

Seat switch replaces Cub Cadet / MTD 925-05013, 725-05013.

30



Order No. 31 - 14246

Plunger safety switch replaces MTD/Cub Cadet 925-04040, 725-04040. Low profile double pole plunger switch N.C./N.C. 4 terminal.



Order No. 31 - 14247

Plunger safety switch replaces Cub Cadet 01008386, 01008386P. Fits Cub Cadet LT1000, SLT1500, GT1500, ZTR and Z-Force. Low profile double pole plunger switch. 4 terminal switch in NC/NO.

O.E.M.



Order No. 31 - 14323

PTO switch replaces Cub Cadet / MTD 925-04175, 725-04175. Fits Cub Cadet models GT1554, GT2542, GT2544, GT2550, GT2554, SLT1550, SLT1554 and Z-force. 7 terminals.



Order No. 31 - 13106

PTO switch replaces Cub Cadet / MTD 725-04258, 925-04258. Fits models GT1054, GT1554, GT33100, GT3200, GTX1054, L1042, L1046, L1050, LT1040, LT1042, LT1045, LT1046, LT1050, LTX1042, LTX1045, LTX1046, LTX1050, SLTX1050, SLTX1054, Craftsman 247.28672, 247.288800, 247.288881, 247.289800, 247.289810, 247.289840, 247.289841.

Order No. 31 - 12792

Starter solenoid relay replaces Cub Cadet 725-3001 / 925-3001. 12 volt, 3-terminal, (2) 5/16 - 18 terminals (1) 10-32 terminal.





COMMERCIAL REPLACEMENT PARTS BREAK-DOWN FOR DIXIE CHOPPER
REPLACEMENT PARTS FOR 42", 50", 60" DIXIE CHOPPER DECK MOWERS

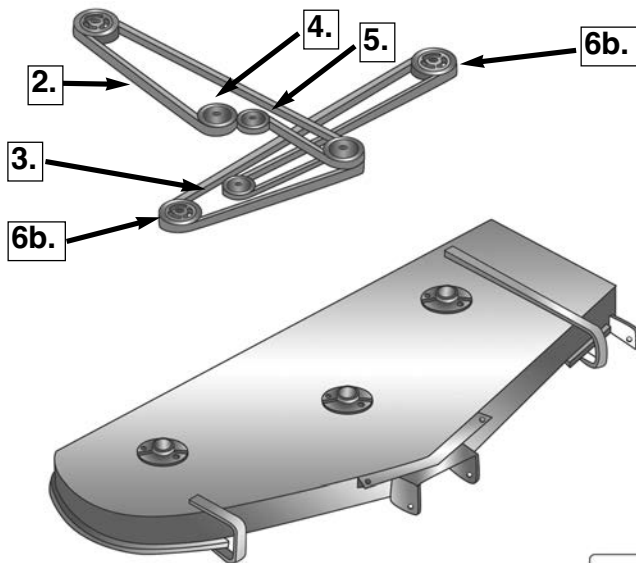
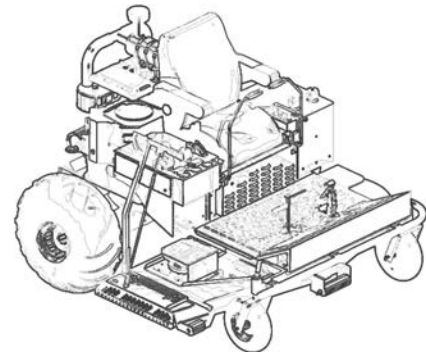

Fits Engine Type	Rotary Oil Filter	Rotary Pre Filter	Rotary Air Filter	Rotary Fuel Filter
27 hp Kohler	19-6676	19-9728	19-9583	
27 hp Generac		19-9728	19-9583	
23 hp Kohler	19-7916	19-2844	19-1388	

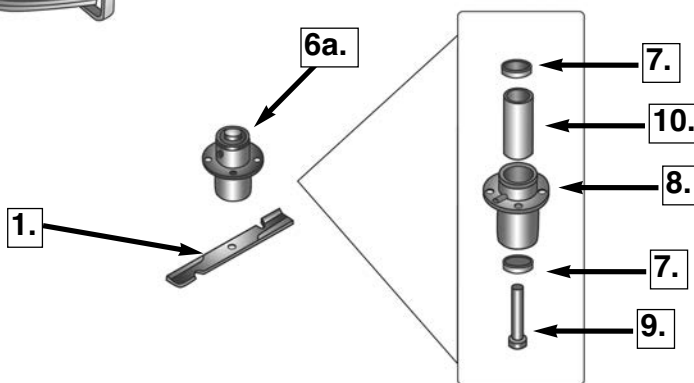

Ref. No.	Order No.	Deck Size	Description/Replaces
1.	15-6020	42"	Blade/Dixie Chopper 30227-42
	15-6316	42"	Commercial Mulcher Blade
	15-3372	50"	Blade/Dixie Chopper 30227-50
	15-6790	50"	Blade/Dixie Chopper 30227-50V
	15-6224	50"	Blade/Dixie Chopper 30227-50H
	15-6442	50"	High Lift Blade
	15-6013	50"	Low Lift Blade
	15-6316	50"	Commercial Mulcher Blade
	15-6194	60"	Blade/Dixie Chopper 30227-60
	15-6083	60"	Blade/Dixie Chopper 30227-60V
	15-6441	60"	Blade/Dixie Chopper 30227-60H
	15-10175	60"	Flat Blade
	15-6303	60"	Commercial Mulcher Blade

Ref. No.	Order No.	Deck Size	Description/Replaces
2.	12-10029	42"	Belt/Dixie Chopper 65080
	12-10027	50"	Belt/Dixie Chopper 30204
	12-10029	60"	Belt/Dixie Chopper 65080
3.	12-10035	42"	Belt/Dixie Chopper 63203
	12-10036	50"	Belt/Dixie Chopper 30203
	12-10011	60"	Belt/Dixie Chopper 30236
4.	13-9895	42",50",60"	Pulley/Dixie Chopper 30234
5.	13-9891	42",50",60"	Pulley/Dixie Chopper 30224
6a.	10-10179	42",50",60"	Spindle/Dixie Chopper 10161L
6b.	10-10178	42",50",60"	Spindle/Dixie Chopper 10161
7.	09-8488	42",50",60"	Bearing/Dixie Chopper 30218
8.	10-10177	42",50",60"	Housing/Dixie Chopper 30241
9.	10-9950	42",50",60"	Shaft/Dixie Chopper 30217L
	10-9949	42",50",60"	Shaft/Dixie Chopper 30217
10.	10-10081	42",50",60"	Spacer/Dixie Chopper 30219

O.E.M. REPLACEMENT



DIXIE CHOPPER (Cont.)

Conduit 45"
Inner Wire 50"
Wire Travel 4-1/4"



Order No. 03 - 12053

Throttle cable replaces Dixie Chopper 68249.

Conduit 42-1/2"
Inner Wire 45-1/4"
Wire Travel 2-3/4"



Order No. 03 - 10951

Throttle control replaces Dixie Chopper 68250.



Order No. 05 - 11508

Brake band replaces Dixie Chopper 65244. Fits parking brake on all mowers.



Order No. 05 - 12092

Hydrostatic Pump replaces Dixie Chopper 65070. Also replaces Hydro-Gear BDP-10A-313, 301, 302 & 308. (Right)



Order No. 05 - 12093

Hydrostatic Pump replaces Dixie Chopper 65071. Also replaces Hydro-Gear BDP-10A-207 & 201 217. (Left)



Order No. 08 - 9763

Wheel assembly replaces Dixie Chopper 10202. 13 x 500 x 6, 4 ply tubeless rib tread tire, 3-1/2" centered hub, 1 piece rim with zerk fitting. Fits units with 42", 50", 60" & 72" decks. (Silver) Bearings not included. Uses our 09-9719 wheel bearing kit.



Order No. 08 - 10915

Caster wheel assembly replaces Dixie Chopper 400130. 13 x 650 x 6, Painted silver. Uses our 09-9719 Bearing Kit. (Bearing not Included).



Order No. 08 - 10789

Wheel assembly replaces Dixie Chopper 400053. 15 x 600 x 6, 4 ply tubeless rib tread tire, 3-1/2" centered hub, 1 piece rim with zerk fitting. (Silver) Bearings not included. Uses our 09-9719 wheel bearing kit.



Order No. 08 - 9501

Solid wheel assembly replaces Dixie Chopper 10202. 13 x 500 x 6 rib tread solid wheel assembly. Fits units with 42", 50", 60" & 72" decks. Bearings not included. (Silver). Uses 9719 Bearing Kit

30

O.E.M.



DIXIE CHOPPER (Cont.)



Order No. 08 - 9573

Wheel assembly replaces Dixie Chopper 10202, 97166. 13 x 650 x 6, 4 ply rib tread tubeless tire, 3-3/4" centered hub, 1 piece rim. Fits Dixie Chopper "Zero Turn" commercial mowers 1999 - later. (Silver). Bearings not included. Uses our **09-9606** spanner bushing.



Order No. 08 - 11062

13 x 500 -6 Reliance wheel assembly. Mounted on a 6" x 3.25" steel wheel painted silver with 3.75" centered hub length, with-out bearings. Replaces Dixie Chopper 10202. **No Bearings Included.**



Order No. 08 - 12310

22 x 12.00 - 8, 3-ply tubeless Field Trax tread tire. Used on Dixie Choppers.



Order No. 08 - 14002

22 X 10.50 - 12, 4-ply tubeless, Turf Master tread tire from Carlisle. Fits Dixie Chopper.



Order No. 08 - 11061

15 x 600 x 6, Reliance tire mounted on a 6" x 4.5" steel wheel painted silver with 3-3/4" centered hub length. Replaces Dixie Chopper 400053 / 400129.



Order No. 08 - 10430

13 x 6.50 x 6, 4 ply tubeless turf pro tire. Rib Tread Tire. Fits Dixie Chopper.



Order No. 08 - 10700

1 piece rim replaces Dixie Chopper 10239. 6" diameter, 3-1/4" rim width, 3-1/2" hub length. Fits 13x500-6 & 13x650-6 tires. Fits 1-3/8" bearings, Uses our 09-9719 bearing kit.



ID 5/8" (15.88 mm)
OD 1-3/8" (34.93 mm)
Height 7/16" (11.11 mm)

Order No. 09 - 8199

High speed bearing, double sealed replaces Dixie Chopper 67205. May be used with or without retaining clip. Fits McLane and Star Clipper edgers. Bearing No. 99502H-2RSNR.



ID 1" (25.40 mm)
OD 2" (50.80 mm)
Height 27/32" (21.43 mm)

Order No. 09 - 8488

Bearing replaces Dixie Chopper 30218. Fits spindle assembly on 30", 42", 50" cut "Zero Turn". Bearing No. RA100RR.



ID 5/8" (15.86 mm)
OD 7/8" (22.23 mm)
Length 1" (25.4 mm)

Order No. 09 - 9606

Wheel bushing replaces Dixie Chopper 10203. Fits our **08-9573** wheel assembly.

30

O.E.M.



**O.E.M. REPLACEMENT
DIXIE CHOPPER (Cont.)**



Order No. 10 - 12835

Electric PTO clutch replaces Dixie Chopper 500012. Warner 5218-210. Replaces Warner 5218-140 & 5218-107. 200 lbs. torque. Shaft size 1-1/8", 7" pulley diameter, 5/8" Belt. Uses our 10-12923 pigtail.



Order No. 10 - 11070

Electric PTO clutch replaces Dixie Chopper 50300. Warner 5215-88.



ID 5/8" (15.8mm)
OD 7/8" (22.2mm)
Length 2" (50.8mm)

Order No. 09 - 9709

Inner wheel spacer replaces Dixie Chopper 67204. Fits Dixie Chopper wheel assembly models 10202 & 97166. Also used on our 08-9573 & 08-9501 wheel assemblies. Included in our 09-9719 wheel bearing kit.



Over all ID 5/8" (15.88mm)
Over all OD 1-3/8" (34.93mm)
Over all Length 4" (101.6mm)

Order No. 09 - 9719

Wheel bearing kit for Dixie Chopper. Fits Dixie Chopper 10202 & 97166 wheel assemblies. Also fits our 08-9501 & 08-9573 wheel assemblies. Kit contains (2) 09-7950 bearings, and (2) 09-8198 bearings, and (1) 09-9709 wheel bushing.



ID 1" (25.4mm)
OD 2" (50.8mm)
Height 7/8" (22.23mm)

Order No. 09 - 9937

Bearing replaces Dixie Chopper 30218.



ID 1.063" (27mm)
OD 1.9805" (50.30mm)
Height 5/8" (15.86mm)

Order No. 09 - 9951

Roller bearing replaces Dixie Chopper 97171. Fits caster yoke. Bearing No. LM44610 & LM44649.



ID 1" (25.40mm)
OD 1-31/32" (50.01mm)
Height 19/32" (15.08mm)

Order No. 09 - 814

Bearing replaces Dixie Chopper 10207.



ID 1"
OD 1-1/4"
Length 2-3/4"

Order No. 10 - 10081

Spindle bearing spacer replaces Dixie Chopper 30219.



ID 1"
OD 2"
Thickness .120"

Order No. 10 - 10560

Belleville Washer replaces Dixie Chopper W-137. Used in Dixie Chopper 10161 & 10161L spindle assemblies. (2) per assembly, (6) per unit. MIN010



Coil Dia. 7/8"
Total Length 6-1/4"
Length of Coil 4-1/8"
Thickness 1/8"

Order No. 10 - 9908

Idler arm spring replaces Dixie Chopper 10222.



ID 1"
OD 1-1/2"

Order No. 10 - 10559

Hex nut replaces Dixie Chopper N-167. Used in Dixie Chopper 10161 & 10161L spindle assemblies. (1) per assembly, (3) per unit. MIN005



OD 1.98" (50.3 mm)

Order No. 09 - 10665

Caster yoke grease cap replaces Dixie Chopper 10220 dust cap for 1"ID bearings.



Order No. 10 - 13296

1/2" -13 Stud, replaces Dixie Chopper S-114.

30

O.E.M.



DIXIE CHOPPER (Cont.)



Order No. 10 - 12808

Spindle assembly replaces Dixie Chopper 300442. Spindle housing with bearings, seals, long shaft.



Order No. 10 - 12807

Spindle assembly replaces Dixie Chopper 300441. Spindle housing with bearings, seals, short shaft.



Length 8"
OD 1"

Order No. 10 - 9949

Spindle shaft replaces Dixie Chopper 30217.



Length 9-1/2"
OD 1"

Order No. 10 - 9950

Spindle shaft replaces Dixie Chopper 30217-L.



Order No. 10 - 12806

Spindle housing replaces Dixie Chopper 300440. Spindle housing with bearings, seals.



Order No. 10 - 14353

Electric PTO clutch replaces Dixie Chopper 500056. Fits Excalibur series & Classic series with 1-1/8" engine shafts. Warner 5218-254. 1-1/8" ID, 7-1/2" pulley for 5/8" belt.

30

O.E.M.



Order No.

Description

12 - 10022

Deck Belt. Replaces Dixie Chopper 9907A96 (**A96**). 1/2" (12.7 mm) x 98.3" (2497 mm). Polyester cord construction.

12 - 10029

Deck Belt. Replaces Dixie Chopper 65080 (**B80**). 21/32" (16.67 mm) x 82.9" (2106 mm). Fits 34", 50" & 60" cut models. Polyester cord construction.

12 - 10033

Deck Belt. Replaces Dixie Chopper 9907B112 (**B112**). 21/32" (16.67 mm) x 114.8" (2916 mm). Polyester cord construction.

12 - 10034

Deck Belt. Replaces Dixie Chopper 9907B130 (**B130**). 21/32" (16.67 mm) x 132.8" (3373 mm). Polyester cord construction.

12 - 10035

Deck Belt. Replaces Dixie Chopper 63203 (**A89**). 1/2" (12.7 mm) x 91.3" (2319 mm). Polyester cord construction.

12 - 10036

Deck Belt. Replaces Dixie Chopper 30203 (**B103**). 21/32" (16.67 mm) x 105.8" (2687 mm). Polyester cord construction.

12 - 10010

Deck Belt . Replaces Dixie Chopper 68162 (**B162**). 21/32" (16.7 mm) x 164.8" (4185.84 mm). Fits 72" Mowers. Polyester cord construction.

**O.E.M. REPLACEMENT
DIXIE CHOPPER (Cont.)**



Order No.	Description
12 - 10011	Deck Belt . Replaces Dixie Chopper 30236-0 (B128). 21/32" (16.7 mm) x 130.8" (3323 mm). Fits 60" Mowers. Polyester cord construction.
12 - 12443	Deck Belt . Replaces Dixie Chopper 2006B144R (B144) 5/8" (15.87mm) x 146-1/4" (3714.7 mm). Fits 66" Xcaliber model.
12 - 12442	Deck Belt . Replaces Dixie Chopper 2006B98R (B98) 5/8" (15.87mm) x 101" (2565.4 mm). Fits 66" Xcaliber model.
12 - 11226	Deck Belt . Replaces Dixie Chopper 9907B94 (B94). 5/8" (15.8 mm) x 96.9 (2461.3 mm). Fits models LT44. Raw edge, Laminated, Polyester cord construction.
12 - 13456	Deck Belt . Replaces Dixie Chopper 2008B100R . 5/8" (15.8 mm) x 102-7/8" (2613 mm) Fits Iron Eagle. Belt- Engine -Deck 44" 60" decks (B100).Raw edge belt.
12 - 10030	Engine Belt . Replaces Dixie Chopper 68081 (B81). 21/32" (16.67 mm) x 83.8" (2129 mm). Polyester cord construction.
12 - 10027	Engine to Deck Belt . Replaces Dixie Chopper 30204 (B78). 21/32" (16.67 mm) x 80.9" (2052 mm). Polyester cord construction. Raw Edge
12 - 10031	Engine to Deck Belt . Replaces Dixie Chopper 68082 (B82). 21/32" (16.67 mm) x 84.8" (2154 mm). Polyester cord construction. Raw Edge
12 - 10032	Engine to Deck Belt . Replaces Dixie Chopper 9907B85 (B85). 21/32" (16.67 mm) x 87.8" (2230 mm). Polyester cord construction. Raw Edge
12 - 10814	Engine to Deck Drive Belt Replaces Dixie Chopper 9907B84 (B84). 5/8" (15.8 mm) x 6.9" (2207.3 mm). Raw edge, polyester cord construction.
12 - 11225	Engine To Deck Belt . Replaces Dixie Chopper 9907B92 (B92). 5/8" (15.8 mm) x 94.9 (2410.5 mm). Fits models LT44. Raw edge, Laminated, Polyester cord construction.
12 - 11502	Engine to Deck Belt . Replaces Dixie Chopper 2006B88 (B88). 5/8" (15.8 mm) x 90.9" (1308.8 mm). Fits 2006 models X2703-60, XG2703-60, XWF2700-60, XFG2700-60, SP2800-60, XT3300-060, LP3000-60, XXG2703-72 & XT3300-72. Raw edge, Laminated, polyester cord construction.
12 - 12238	Engine to Deck Belt . Replaces Dixie Chopper 2006B99W (B99). 5/8" (15.87mm) x 102" (2590.8 mm). Fits 74" Xcaliber model.
12 - 12452	Engine to Deck Belt . Replaces Dixie Chopper 2006 B160R . 5/8" (15.875 mm) x 162.8" (4135.12 mm). Fits 72" models. Raw edge, laminated, aramid cord construction.
12 - 12751	Engine to Deck Belt . Replaces Dixie Chopper 2006 B87R & 2008 B87W . (Super II B87) 5/8" (15.875 mm) x 87" (2209.8 mm). Fits 72" models. Raw edge, laminated, aramid cord construction.
12 - 12983	Engine to Deck Belt . Replaces Dixie Chopper 2008B89 . 5/8" (15.875mm) x 89" (2260.6 mm). Fits Extreme 3372. Raw Edge Belt.
12 - 13219	Engine to Deck Drive Belt . Replaces Dixie Chopper 2008B97R . 5/8" (15.875mm) x 100" (2540 mm).

30

O.E.M.



DIXIE CHOPPER (Cont.)



Order No.

Description

- 12 - 10023** **Engine to Transmission Belt.** Replaces Dixie Chopper 20256 (**B38**). 21/32" (16.67 mm) x 40.9" (1039 mm). Polyester cord construction. Raw Edge
- 12 - 10024** **Engine to Transmission Belt.** Replaces Dixie Chopper 97345 (**B40**). 21/32" (16.67 mm) x 42.8" (1087 mm). Polyester cord construction. Raw Edge
- 12 - 10025** **Engine to Transmission Belt.** Replaces Dixie Chopper 9907B41 (**B41**). 21/32" (16.67 mm) x 43.8" (1113 mm). Polyester cord construction. Raw Edge
- 12 - 10026** **Engine to Transmission Belt.** Replaces Dixie Chopper 63204 (**B42**). 21/32" (16.67 mm) x 44.8" (1138 mm). Polyester cord construction. Raw Edge
- 12 - 11503** **Engine to Transmission Belt.** Replaces Dixie Chopper 20000B64 (**B64**). 5/8" (15.8 mm) x 66.9" (1699 mm). Fits 2006 series LT2000-50D, LT2500-50D & LT2700-60D. Raw edge, Laminated, polyester cord construction.
- 12 - 12239** **Engine to Transmission Belt.** Replaces Dixie Chopper 2006B44R (**B44**). 5/8" (15.87mm) x 47" (1193.8 mm). Fits 74" Xcaliber model.
- 12 - 13366** **Engine -Transmission V-Belt.** Replaces Dixie Chopper **2006A62R** 1/2" (12.7 mm) x 64-1/2" (1638.3 mm). Fits Iron Eagle 2350 model. Raw edge belt.
- 12 - 10815** **Mule Drive Belt** Replaces Dixie Chopper 97346C158 (**C158**). 7/8" (22.2 mm) x 162-1/8" (4118 mm). Fits 72" cut with Yanmar diesel engines. Polyester cord construction.
- 12 - 11223** **Pump to Engine Belt.** Replaces Dixie Chopper 9907B57 (**B57**). 5/8" (15.8 mm) x 59.9" (1521.5 mm). Fits models LT36 & 44. Raw edge, Laminated, Polyester cord construction.

*Made with KEVLAR® or non-trade marked Aramid fiber.



ID 1/2"
OD 4-3/4"
Height 1-1/4"

Order No. 13 - 9891

Idler pulley replaces Dixie Chopper 30224. Heavy Duty.



ID 5/8"
OD 4-3/8"
Height 1"

Order No. 13 - 9895

V-Belt Idler pulley replaces Dixie Chopper 30234. Heavy duty riveted pulley.



ID 1"
OD 6"
Height 1-1/8"

Order No. 13 - 13426

Deck pulley replaces Dixie Chopper 300037.



ID 5/8"
OD 5-1/4"
Height 1-1/4"

Order No. 13 - 13502

Idler pulley replaces Dixie Chopper 97319. Deck drive tensioner/stationary idler, c-section v-idler pulley. Fits XWD series diesel units.



ID 1"
OD 5-1/4"
Height 1-13/32"

Order No. 13 - 13427

Deck pulley replaces Dixie Chopper 9907525X100S. Fits 60" decks.

30

O.E.M.

O.E.M. REPLACEMENT
DIXIE CHOPPER (Cont.)



ID 23/32"
OD 4"
Height 41/64"

Order No. 13 - 13413

Deck pulley replaces Dixie Chopper 300401.



ID 19/32"
OD 5-3/4"
Height 1-3/4"

Order No. 13 - 13423

Pump pulley replaces Dixie Chopper 200031. Fits LT models.



ID 5/8"
OD 3-3/4"
Height 1"

Order No. 13 - 13424

Idler pulley replaces Dixie Chopper 200238. Fits Iron Eagle 2044, 2350, 2560.



ID 1/2"
OD 3-3/4"
Height 1-1/4"

Order No. 13 - 13425

Idler pulley replaces Dixie Chopper 200239. Fits LT models.













30

O.E.M.

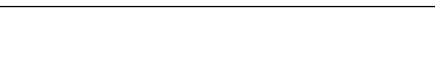
ORDER NO.	REPLACES O.E.M. NO.	LENGTH	CENTER HOLE DIAM.	OUTSIDE HOLE DIAM.	CENTER TO CENTER	WIDTH	STEEL THICK.	APPLICATION
15 - 6020	30227-42	14-1/2" 368.3mm	5/8" 15.9mm			2-1/2" 63.5mm	.203" 5.2mm	(3) blades for 42" cut
15 - 6316	30227-42	14-1/2" 368.3mm	5/8" 15.9mm			2-1/2" 63.5mm	.204" 5.2mm	Mulching Blade PATENTED
15 - 3372	30227-50	17" 431.8mm	5/8" 15.9mm			2" 50.8mm	.204" 5.2mm	(3) blades for 50" deck
15 - 6790	30227-50V	17" 431.8mm	5/8" 15.9mm			2-1/2" 63.5mm	.240" 6.1mm	(3) blades for 50" cut. High lift for wet grass.
15 - 6224	30227-H	17" 431.8mm	5/8" 15.9mm			2-1/2" 63.5mm	.204" 5.2mm	(3) blades for 50" cut "ZERO TURN"
15 - 6442	30227-N	17" 431.8mm	5/8" 15.8mm			3" 76.2mm	.240" 6.1mm	(3) blades for 50" cut. Fits "Zero Turn" models. High Lift
15 - 6298	30227-50 30227-50V	17" 431.8mm	5/8" 15.9mm			2-1/2" 63.5mm	.204" 5.2mm	Mulching Blade PATENTED
15 - 6013	30227-50	17" 431.8mm	5/8" 15.8mm			2" 50.8mm	.240" 6.1mm	Low-Lift Blade Sharpened - 4-sides
15 - 13986	30227-56	20" 508mm	5/8" 15.9mm			2-1/4" 57.2mm	.240" 6.1mm	Mulching Blade

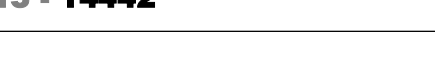



DIXIE CHOPPER (Cont.)

ORDER NO.	REPLACES O.E.M. NO.	LENGTH	CENTER HOLE DIAM.	OUTSIDE HOLE DIAM.	CENTER TO CENTER	WIDTH	STEEL THICK.	APPLICATION
 15 - 13419	30227-56H	20" 508mm	5/8" 15.9mm			2-1/4" 57.2mm	.240" 6.1mm	(3) blades for 56" cut.
 15 - 6083	30227-60-V	20-1/2" 520.7mm	5/8" 15.9mm			2-1/2" 63.5mm	.240" 6.1mm	(3) blades for 60" cut High lift for wet grass
 15 - 6441	30227-60H	20-1/2" 520.7mm	5/8" 15.9mm			3" 76.2mm	.240" 6.1mm	(3) blades for 60" cut. High Lift.
 15 - 10175	30227-60	20-1/2" 520.7mm	5/8" 15.8mm			2-1/2" 63.5mm	.204" 5.2mm	Flat Blade Sharpened - 4-sides
 15 - 6303	30227-60 30227-60-V	20-1/2" 520.7mm	5/8" 15.9mm			2-1/2" 63.5mm	.204" 5.2mm	Mulching Blade PATENTED
 15 - 6194	30227-60	20-1/2" 520.7mm	5/8" 15.8mm			2" 50.8mm	.240" 6.1mm	Low-Lift Blade Sharpened - 4-sides
 15 - 6180	9383	20-1/2" 520.7mm	5/8" 15.9mm			2-1/2" 63.5mm	.240" 6.1mm	(3) blades for 60" cut
 15 - 14442	 30227-62X 30227-62T	21-3/8" 533.4mm	5/8" 15.8mm			2-1/2" 63.5mm	.240" 6.1mm	
 15 - 14467	 30227-62X 30227-62T	21-3/8" 533.4mm	5/8" 15.8mm			2-1/2" 63.5mm	.240" 6.1mm	Mulching Blade PATENTED
 15 - 13987	30227-66	23-5/16" 592.14mm	5/8" 15.9mm			2-1/4" 57.2mm	.240" 6.1mm	Mulching Blade (3) blades for 60" cut
 15 - 12616	30227-66H	23-5/16" 592.14mm	5/8" 15.9mm			2-1/4" 57.2mm	.240" 6.1mm	(3) blades for 66" cut.

30 O.E.M.

O.E.M. REPLACEMENT
DIXIE CHOPPER (Cont.)



ORDER NO.	REPLACES O.E.M. NO.	LENGTH	CENTER HOLE DIAM.	OUTSIDE HOLE DIAM.	CENTER TO CENTER	WIDTH	STEEL THICK.	APPLICATION
 15 - 6404	30227-72H	24" 609.6mm	5/8" 15.9mm			2-1/2" 63.5mm	.240" 6.1mm	(3) blades for 72" cut.
 15 - 6833	30227-72N	24" 609.6mm	5/8" 15.9mm			3" 76.2mm	.240" 6.1mm	(3) blades for 72" cut. (Heavy Duty)

30

O.E.M.



OD 2-1/4"
ID 5/8"
Thickness 1/8"

Order No. 17 - 9531

Fibre spacer replaces Dixie Chopper W101.

MIN010

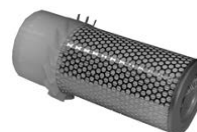

ID 2-1/2"
OD 4"
Height 10-1/4"

Order No. 19 - 8328

Filter replaces Dixie Chopper 90122



Order No. 19 - 9464

Transmission filter replaces Dixie Chopper 68140. Hydrostatic transmission filter has 3/4" - 16 thread, 40 micron, 3-7/8" Height, 3" OD.



Order No. 20 - 12074

Gas cap gauge replaces Dixie Chopper 40222. Fits 300 series tractors. For 9" tank depth, 2-1/4" dia.



Order No. 20 - 12084

Locking vent gas cap replaces Dixie Chopper 600035. 2-1/4" dia.



Order No. 20 - 12313

Fuel filter replaces Dixie Chopper 97392. Fuel filter, gas & water separator. 10 micron



Order No. 21 - 12512

Turf Glider seat with terrain jockey suspension, armrest, seat switch & adjusting sliders. Replaces Dixie Chopper 400293.



Order No. 21 - 12521

Turf Glider seat without suspension. Seat with arms, seat switch, sliders. Can be used with our 21-12522 suspension. Replaces Dixie Chopper 400200.



O.E.M. REPLACEMENT

DIXON



Order No. 08 - 10461

11 x 400 x 5, 4 ply smooth tread Caster wheel assembly replaces Dixon 17080. Mounted on a 5 x 3.25 steel wheel with 5" centered hub length, 3/4" angular contact heavy duty ball bearings. Fits 90 series riders with front cut 50", 60" & 72" decks. (Yellow)



- 1 Piece Rim
- Flat Proof
- Semi Pneumatic

Order No. 08 - 10742

Wheel assembly replaces Dixon 17080. 11x400-5 Reliance rib tread tire. 5" centered hub length, 3/4" roller bearings. Includes grease zerk. Painted white.



Order No. 08 - 8551

Caster wheel replaces Dixon 17080. 11 x 400 x 5, 2 ply smooth tread tubeless tire, 1 piece. rim, 5" centered hub, 3/4" open cage roller bearing and zerk fitting. Uses our 09-8707 spanner bushing. (painted yellow)



ID 1" (25.40 mm)
OD 2" (50.80 mm)
Height 27/32" (21.43 mm)

Order No. 09 - 8488

Bearing replaces Dixon 1701, 539115279. Fits spindle assembly on 50", 42", 30" cut ZTR. Also fits wheel hubs on Dixon ZTR with chain drive. Bearing No. RA100RR.



ID 5/8" (15.88 mm)
OD 1-9/16" (39.69 mm)
Height 15/32" (11.91 mm)

Order No. 09 - 484

Bearing replaces Dixon 6011. Used on our 10-7154 Shaft. Bearing No. 9504-ZZ.



ID 5/8" (15.88 mm)
OD 1-9/16" (40.00 mm)
Height 15/32" (11.91 mm)

Order No. 09 - 8437

Bearing replaces Dixon 5249, 539116898. Fits in transaxle on Dixon ZTR mowers. Models 4422, 4421, 3361, 3302, 2301. Bearing No. NTN6203LU. Sealed both sides.

Order No. 09 - 8433

Roller cage bearing with retainer bushings replaces Dixon 8179, 539116801. Fits 42" & 50" cut Dixon ZTR with single arm caster wheel. Fits Dixon wheel 8178.

Order No. 09 - 9008

Roller cage bearing only for Dixon. Used on Dixon 8178, 53916800. Wheel assembly. OD 1-3/8" (34.92 mm), ID 1" (25.40 mm), Length 2-1/2" (63.50 mm).

Order No. 09 - 9009

Retainer bushing only for Dixon. Used on Dixon 8180, 539116802. Wheel assembly. OD 1-3/8" (34.92 mm), ID 1" (25.40 mm).

Overall ID 1" (25.40 mm)
Overall OD 1-3/8" (34.93 mm)
Overall Length 3-3/16" (80.96 mm)



Order No. 10 - 9911

Electric PTO clutch replaces Dixon 3579 Warner 5217-9, 5217-6. 1" x 3" Height, 5.375" Pulley. 5/8" Belt, Shaft size 1".



Order No. 10 - 11071

Electric PTO clutch replaces Dixon 61516, 539128711. Warner 5218-10.

30

O.E.M.

O.E.M. REPLACEMENT
DIXON (Cont.)



Order No.
12 - 8509

Description

Drive Belt. Replaces Dixon 6111, 539116200. 5/8" (15.88 mm) width x 78" (1981.20 mm) length. Fits 42" & 50" deck, models 501, 503 & 542.

*Made with KEVLAR® or non-trade marked Aramid fiber.



ID 1/2"
OD 4-1/2"
Height 1"



ID 1/2"
OD 2"
Height 1"

Order No. 13 - 9378









Flat idler pulley replaces Dixon 1687, 539115278. Main drive pulley on Dixon mowers.

Order No. 13 - 9379

Chain idler pulley replaces Dixon 1713, 539124278. Used on Dixon cone drive models. Plastic

30

O.E.M.

ORDER NO.	REPLACES O.E.M. NO.	LENGTH	CENTER HOLE DIAM.	OUTSIDE HOLE DIAM.	CENTER TO CENTER	WIDTH	STEEL THICK.	APPLICATION
 15 - 1100	6092	14-3/8" 365.1mm	11/16" 17.5mm			2" 50.8mm	.187" 4.8mm	(3) blades for 42" cut Low lift
 15 - 6312	6092/6013 8600	14-7/16" 366.71mm	45/64" 17.9mm			2-1/2" 63.5mm	.187" 4.8mm	Mulching Blade
 15 - 6086	6236	14-1/2" 368.3mm	11/16" 17.5mm			2-1/2" 63.5mm	.187" 4.8mm	For "ZERO TURN" models 428 & 429 (3) blades for 42" cut Low lift
 15 - 6087	8688	14-1/2" 368.3mm	11/16" 17.5mm			2-1/2" 63.5mm	.187" 4.8mm	For "ZERO TURN" models 428 & 429 (3) blades for 42" cut High lift
 15 - 1066	9229	17" 431.8mm	5/8" 15.9mm			2" 50.8mm	.204" 5.2mm	Std. deck (3) blades for 50" cut
 15 - 6088	9265	17" 431.8mm	5/8" 15.9mm			2-1/2" 63.5mm	.187" 4.8mm	For "ZTR" models 502 & 503. (3) blades for 50" deck High lift
 15 - 6298	9258 9265	17" 431.8mm	5/8" 15.9mm			2-1/2" 63.5mm	.204" 5.2mm	Mulching Blade PATENTED
 15 - 6782	9443	17" 431.4mm	11/16" 17.9mm			2-1/2" 63.5mm	.187" 4.8mm	(3) blades for 50" cut. Low lift.
 15 - 6766	9444	17" 431.4mm	11/16" 17.9mm			2-1/2" 63.5mm	.187" 4.8mm	(3) blades for 50" cut. High lift.



DIXON (Cont.)

ORDER NO.	REPLACES O.E.M. NO.	LENGTH	CENTER HOLE DIAM.	OUTSIDE HOLE DIAM.	CENTER TO CENTER	WIDTH	STEEL THICK.	APPLICATION
 15 - 6785	6897	17" 431.8mm	11/16" 17.9mm			2-1/2" 63.5mm	.204" 5.2mm	Mulching Blade PATENTED
 15 - 6084	1351	18-7/16" 468.3mm	3/4" 19.1mm	13/32" 10.3mm	2-9/16" 65.1mm	2-3/4" 69.9mm	.187" 4.8mm	For ZTR 361 W/Catcher
 15 - 6101	1324	18-1/2" 469.9mm	11/16" 17.46mm			2" 50.8mm	.187" 4.8mm	For ZTR model 361 only Takes (2) blades for 36" cut
 15 - 6180	9383	20-1/2" 520.7mm	5/8" 15.9mm			2-1/2" 63.5mm	.240" 6.1mm	(3) blades for 60" cut
 15 - 6303	9383	20-1/2" 520.7mm	5/8" 15.9mm			2-1/2" 63.5mm	.204" 5.2mm	Mulching Blade PATENTED
 15 - 6784	9445	20-1/2" 520.7mm	11/16" 17.9mm			2-1/2" 63.5mm	.240" 6.1mm	(3) blades for 60" cut. High lift.
 15 - 1089	8278 30-2406	30" 762mm	7/8" 22.2mm			2-3/4" 69.9mm	.187" 4.8mm	

30
O.E.M.

Order No. 19 - 9464

Transmission filter replaces Dixon 7252, 539125960. Hydrostatic transmission filter has 3/4" - 16 thread, 40 micron, 3-7/8" Height, 3" OD.

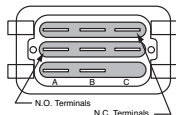

Order No. 31 - 9656

PTO switch replaces Dixon 596, 539117238. Push-pull/Snap in mount. Corner terminal blank. Red Knob.

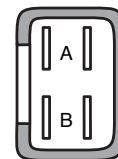



Order No. 31 - 9659

Plunger Interlock switch replaces Dixon 4242, 539115802. Double pole, normally open / normally closed.

**O.E.M. REPLACEMENT
ELECTROLUX**



ORDER NO.	REPLACES O.E.M. NO.	LENGTH	CENTER HOLE DIAM.	OUTSIDE HOLE DIAM.	CENTER TO CENTER	WIDTH	STEEL THICK.	APPLICATION
 15 - 50034	6448400	18" 457.2mm	.394" 10.3mm	.331" 8.7mm	2.56" 65.1mm	3.0" 76.2mm	.095" 2.8mm	
 15 - 50060	6445800	18.7"	.400" 10.3mm	.337" 8.7mm	2.56" 65.1mm	2.5" 63.5mm	.134" 3.6mm	

30

O.E.M.



**COMMERCIAL REPLACEMENT PARTS BREAK-DOWN FOR EXMARK
REPLACEMENT PARTS FOR 36",48",52" EXMARK VIKING DECK MOWERS**

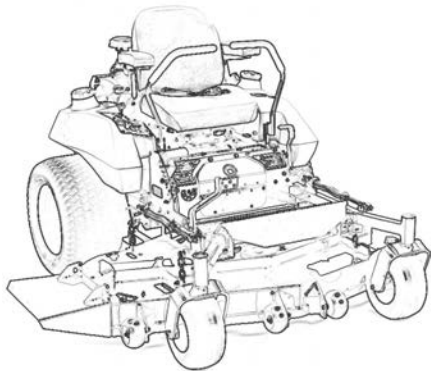

Fits Engine Type	Rotary Oil Filter	Rotary Pre Filter	Rotary Air Filter	Rotary Fuel Filter

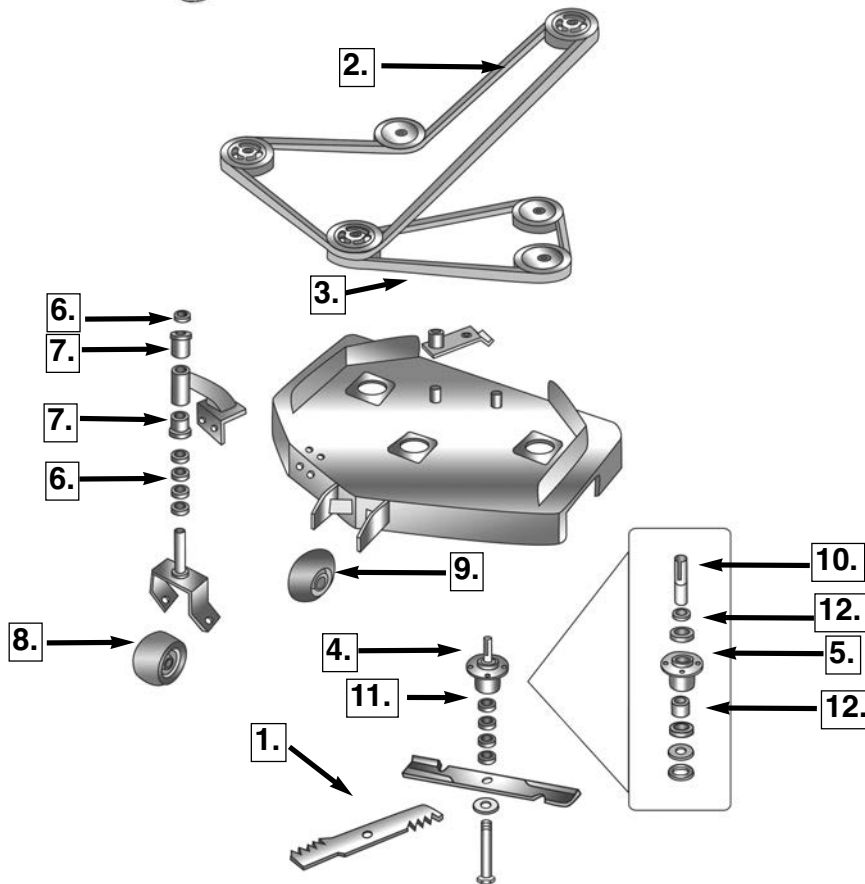

Ref. No.	Order No.	Deck Size	Description/Replaces
1.	15-9487	48"	Blade/Exmark 323515
	15-1010	36", 52"	Blade/Exmark 633483
	15-6296	48"	Commercial Mulcher Blade
	15-9487	48"	Blade/Exmark 323515
	15-6294	52"	Commercial Mulcher Blade
	15-10173	52"	Flat Blade
	15-10719	52"	Low Lift Blade
2.	12-5217	52"	Belt
3.	12-8092	48"	Belt/Exmark 403025
	12-5183	52"	Belt

Ref. No.	Order No.	Deck Size	Description/Replaces
4.	10-1226		Spindle/Exmark 302030
	10-1227		Spindle/Exmark 402006
5.	10-1209		Housing/Exmark 303189
6.	10-8190		Spacer/Exmark 303314
7.	09-8305		Bushing/Exmark 303044
8.	08-9898		Wheel Assembly
9.	07-6917		Deck Wheel/Exmark 603299
10.	10-1230		Center Shaft/Exmark 402075
11.	10-1191		Blade Spacer/Exmark 303164
12.	09-3217		Bearing/Exmark 303057

30

O.E.M.

O.E.M. REPLACEMENT

**COMMERCIAL REPLACEMENT PARTS BREAK-DOWN FOR EXMARK
REPLACEMENT PARTS FOR 52",60",72" EXMARK LAZER Z DECK MOWERS**

Fits Engine Type	Rotary Oil Filter	Rotary Pre Filter	Rotary Air Filter	Rotary Fuel Filter

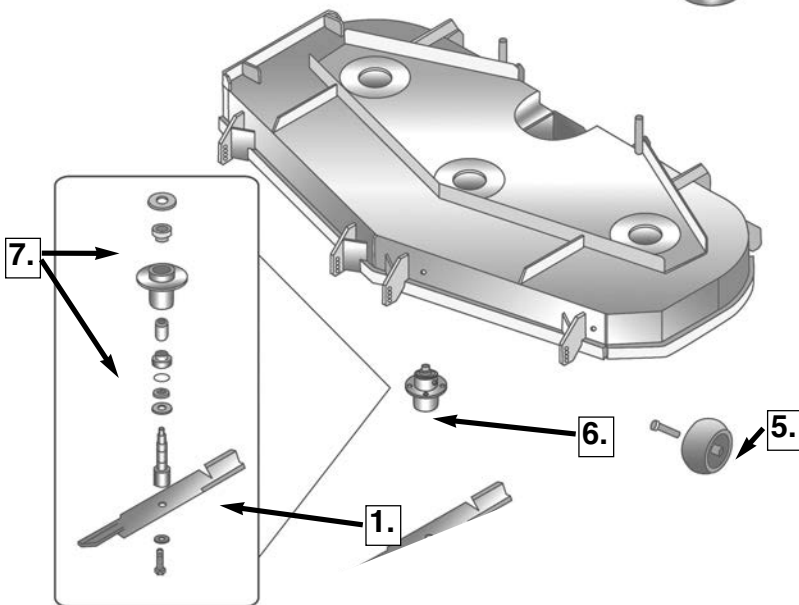
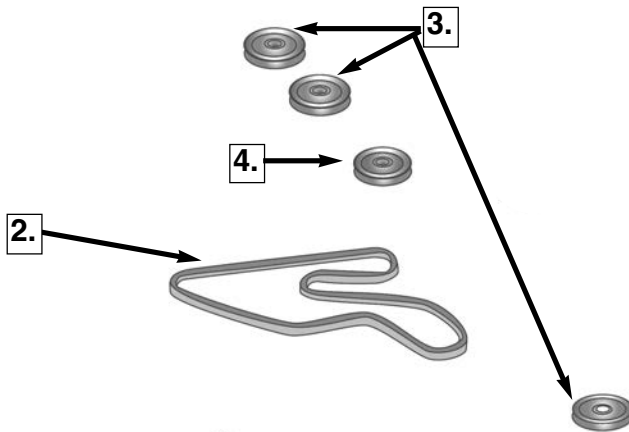
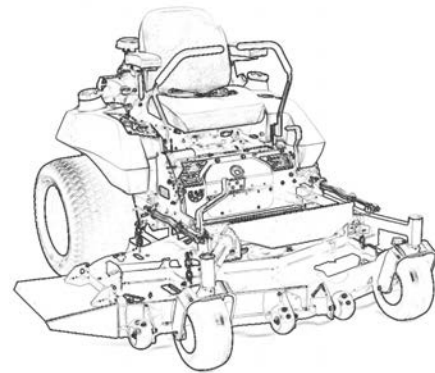

30

O.E.M.

Ref. No.	Order No.	Deck Size	Description/Replaces
1.	15-6291	52"	Blade/Exmark 633484
	15-6083	60"	Blade/Exmark 633483
	15-6290	60"	Blade/Exmark 613112
	15-10175	60"	Flat Blade
	15-6194	60"	Low Lift Blade
	15-10667	60"	High Lift Blade (Notched)
	15-6303	60"	Commercial Mulcher Blade
	15-6481	72"	Blade/Exmark 643006
	15-9882	72"	Blade/Exmark 643097
	15-10421	72"	Blade/Exmark 103-1581

Ref. No.	Order No.	Deck Size	Description/Replaces
2.	12-9014	52" & 60"	Drive Belt/Exmark 633173
	12-9862	52"	Belt/Exmark 633366
	12-9016	60"	Belt/Exmark 633127
	12-10041	72"	Belt/Exmark 643052
3.	13-9864	50",60",72"	Pulley/Exmark 633109
	13-9772	50",60",72"	Pulley/Exmark 603805
5.	07-6917	50",60",72"	Wheel/Exmark 603299
	07-10301	50",60",72"	Wheel & Hardware Kit
6.	10-10353	50",60",72"	Spindle/Exmark 634972
7.	09-8488	42",50",60"	Bearing/Exmark 303543



**COMMERCIAL REPLACEMENT PARTS BREAK-DOWN FOR EXMARK
REPLACEMENT PARTS FOR 46",50",56", 60", 66", 72", EXMARK
LAZER Z TRITON DECK**

Fits Engine Type	Rotary Oil Filter	Rotary Pre Filter	Rotary Air Filter	Rotary Fuel Filter
19 hp Kawasaki				
23 hp Kawasaki				
27 hp Kawasaki				
28 hp Kawasaki				
23 hp Kohler				
27 hp Kohler				
28 hp Kohler				
31 hp Briggs & Stratton				

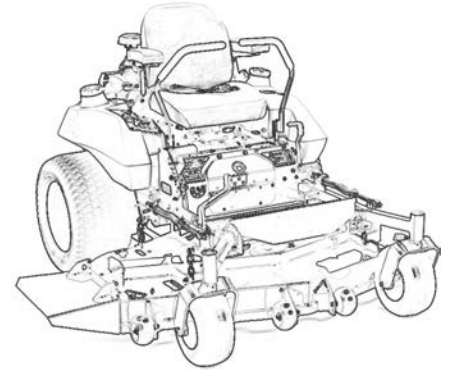

30

O.E.M.

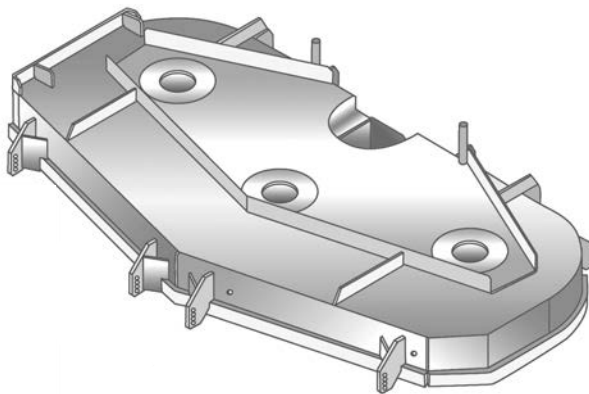

Ref. No.	Order No.	Deck Size	Description/Replaces
1.	15-11769	46"	Blade/Exmark 103-8290 & 103-8296
	15-11773	50"	Blade/Exmark 103-9598
	15-11779	56"	Blade/Exmark 103-9611
	15-9016	60"	Blade/Exmark 633127
	15-11787	66"	Blade/Exmark 103-9612
	15-10041	72"	Blade/Exmark 643052

O.E.M. REPLACEMENT



EXMARK

Conduit 54"
Inner Wire 58-3/4"



Order No. 03 - 13014

Choke control cable replaces Exmark 1-603336. Fits models 52" & 60" Turf Tracer Hydro drive units with floating decks.

Made in USA



Order No. 42 - 7097

Gear Box Assembly. Replaces Exmark 1-302029. (12.5 to 1 gear ratio).

30

O.E.M.



Order No. 42 - 9579

Coupler with cover replaces Exmark 1-323501, 1-324340. Fits 5 speed mowers. Comes with grease fitting & cover. 9-spline center. Used with our 05-9580 drive shaft.



Order No. 42 - 8250

Jackshaft coupler replaces Exmark 1-324157. Comes with grease fitting and safety sleeve.



Length 6"
Keyway 3/16"

Order No. 42 - 9580

Drive shaft replaces Exmark 1-323502. Fits 5 speed mowers. 9-spline. Used with our 05-9579 coupler with cover.



Order No. 42 - 14180

Pro-Gear 30-1018 Drive Shaft. Replaces Peerless 771841 & Exmark 1-323502. 6-1/8" Long, 9-Spline



Order No. 42 - 14185

Pro-Gear 30-1001 Coupler. Replaces Peerless 786177, Exmark 1-323680. 9-Spline



Order No. 42 - 14184

Pro-Gear 30-1000 Coupler. Replaces Peerless 771834, Exmark 1-323501, 1-324340. 9-Spline



Diameter 6-5/8"
Width 3/4"

Order No. 05 - 8266

Brake band replaces Exmark 1-302036. Fits 32" and 48" variable and 5 speed decks, removable brake bands. Used on our 05-8274 brake assembly (left side).



Diameter 7"
Width 3/4"

Order No. 05 - 7787

Brake band replaces Exmark 1-513048.



Diameter 6-5/8"
Width 3/4"

Order No. 05 - 10415

Brake band replaces Exmark 1-323262. Fits Metro walkbehind mowers.



O.E.M. REPLACEMENT

EXMARK



ID 2-1/4"
OD 6"
Width 1-1/4"

Order No. 05 - 9752

Brake drum replaces Exmark 1-323261. Fits Metro units. Included in our 13-9751 assembly.



Bore Size 11/32"
OD (Pin) 5/16"
Shoulder Length 1/2"
Total Length 1-7/32"

Order No. 05 - 10813

Short swivel replaces Exmark 603676.



Order No. 06 - 3239

6" x 2.00" Heavy Duty Solid Tire, Deckwheel. 5/8" roller bearing and zerk fitting. 2-1/4" centered hub length. Replaces Exmark 303201. Uses our 09-5848 Bearing Kit. (painted red)



Order No. 06 - 13432

Steel wheel with gear replaces Exmark 100-2860. Fits rear commercial proline 21" mower model 22166, 22167, 22168. Exmark Metro 21". 3/8" bore, diamond tread, 8 x 2.00, 1-1/4" centered hub. Rear wheel (used with our front wheel 06-13403)



ID 5/8"
Width 2-3/4"
Height 5"

Order No. 07 - 6917

Deck Wheel replaces Exmark 1-603299. 2-1/2" offset hub.



ID 5/8"
Width 2-3/4"
Height 5"

Order No. 07 - 10301

Wheel and hardware kit for Exmark 103-3168. Contains our 07-6917 deck wheel and 10-10007 anti-scalp roller kit.



ID 5/8"
Width 3-1/4"
Height 5"

Order No. 07 - 12015

Deck wheel replaces Exmark 103-8415. Anti scalp roller. Fits Triton decks.



ID 5/8"
Width 3-1/4"
Height 5"

Order No. 07 - 12018

Wheel and hardware kit replaces Exmark 109-2098. Includes our 07-12015 wheel & 10-12016 hardware kit.



Order No. 08 - 9803

Caster wheel without bearings replaces Exmark 1-633582. 13 x 500 x 6, 4 ply smooth tread tubeless tire, 1 piece rim, 5-5/8" centered hub, with zerk fitting. Painted white. Fits Exmark Lazer Z. Uses our 09-813 bearings.



Order No. 08 - 9804

Caster wheel with bearings replaces Exmark 1-634662. 13 x 500 x 6, 4 ply smooth tread tubeless tire, 1 piece rim, 5-5/8" centered hub, 3/4" bearings with zerk fitting. Painted white. Fits Exmark Lazer Z. Includes our 09-813 bearings.

30
O.E.M.



O.E.M. REPLACEMENT

EXMARK (Cont.)



Order No. 08 - 9809

Solid wheel assembly with bearings replaces Exmark 1-634662. 13 x 500 x 6, solid wheel, 1 piece rim, 5-5/8" centered hub, 3/4" bearings with zerk fitting. Painted white. Fits Exmark Lazer Z & Toro Master. Includes our **09-813** bearings. Flat Free.



Order No. 08 - 10075

Caster wheel with bearings replaces Exmark 103-0069. 13 x 650 x 6, 4 ply smooth tread tubeless tire, 1 piece rim, 7" centered hub, 3/4" bearings with zerk fitting. Fits Lazer Z 52", 60" & 72" models. Uses **09-9944** Bearing Kit. (painted white)



Order No. 08 - 8550

Caster wheel replaces Exmark 103-1224. 9 x 350 x 4, 4 ply smooth tread tubeless tire, 1 piece rim, 3/4" open cage roller bearing and zerk fitting. 4" hub length. Uses our **09-8706** spanner bushing. (painted yellow)



Order No. 08 - 9898

9 x 350 x 4 Puncture Proof Tire Wheel Assembly, replaces Exmark 1031224. 1 piece rim, Smooth Tread, Flat Proof, and Extraordinary Rubber Composition. 4-1/2" centered hub with 3/4" open cage roller bearing and zerk fitting. (painted white)



- 1 Piece Rim
- Flat Proof
- Semi Pneumatic

Order No. 08 - 10286

13 x 650-6 Carlisle Reliance Wheel Assembly tire mounted on a 6 x 4.50" steel wheel. 7.25" centered hub with 3/4" cups pressed in for tapered roller bearings. Replaces Exmark 103-0065. (Painted White). Uses our **09-813** bearing or our **09-9944** bearing kit.



- 1 Piece Rim
- Flat Proof
- Semi Pneumatic

Order No. 08 - 10288

13 x 500 x 6 Carlisle Reliance Wheel Assembly tire mounted on a 6 x 3.25" steel wheel. 5.625" centered hub with 3/4" cups pressed in for tapered roller bearings. Replaces Exmark 103-0064. (Painted White) Uses our **09-813** bearing or our **09-9944** bearing kit.



Order No. 08 - 10620

24 X 9.50 X 12, 4-ply tubeless Carlisle Multi-Trac tread tire. Fits Exmark Lazars.



Order No. 08 - 905

13 x 650 x 6 Drive Wheel Assembly, replaces Exmark 1-304173, 302016. 6-1/2" offset hub length, 7/8" roller bearing, 4 ply tubeless tire.



Order No. 08 - 12879

18.00 X 7.00 - 8, 4-ply tubeless, Multi-Trac tread tire from Carlisle. Replaces Exmark 109-2594. Fits Exmark Phazer series.



Order No. 08 - 13245

22 x 9.50 - 12, 4-ply tubeless Turf Master tread tire. Fits Exmark Laser Advantage series.

30

O.E.M.



EXMARK (Cont.)



ID 5/8" (15.88 mm)
OD 1-3/8" (34.93 mm)
Height 7/16" (11.11 mm)

Order No. 09 - 8198

Reduction gear bearing. Replaces Exmark 1-303051. Uses 5 bearings in our Gear Box Assembly 05-7097. Bearing No. 99502H-2RS.



ID 1" (25.40mm)
OD 2.0475" (52mm)
Height .708" (18mm)

Order No. 09 - 12119

Spindle bearing replaces Exmark 103-2477.



ID 63/34" (25.00 mm)
OD 2-7/16" (61.91 mm)
Height 21/32" (16.67 mm)

Order No. 09 - 3217

Sealed bearing replaces Exmark 1-303543, 1-303057. Bearing No. 6305-2RS.



ID 1-1/8"
OD 2-3/16"
Height 1-1/4"

Order No. 09 - 13259

Spindle bearing replaces Exmark 109-2064. Without O-ring. Fits Exmark Lazer Z Triton decks.



ID 1/2" (12.70 mm)
OD 1-3/8" (34.93 mm)
Height 1/2" (12.70 mm)

Order No. 09 - 8351

Bearing replaces Exmark 1-631560 & 1-513009. Fits front caster wheels.



ID 5/8" (15.88 mm)
OD 1-9/16" (34.93 mm)
Height 7/8" (22.23 mm)

Order No. 09 - 8077

Output shaft support bracket bearing replaces Exmark 1-303067. Used with our 10-8184 Flange.



ID 1"
OD 2"
Height 1-3/4"

Order No. 09 - 11060

Jackshaft spindle bearing replaces Exmark 1-513012. Includes locking collar and set screw.



ID 3/4"(19.05mm)
OD 1-25/32" (45mm)

Order No. 09 - 9944

Wheel bearing kit for Exmark. Includes (2) 09-813 bearings, (2) 10-10013 seals, (2) 08-10064 spacers. Fits Laser Z units. Used in our 08-9803, 08-9804 & 08-9809 wheel assembly.

30

O.E.M.



O.E.M. REPLACEMENT EXMARK (Cont.)



ID 3/8" (9.53 mm)
OD 5/8" (15.88 mm)
Length 2-13/16" (71.44 mm)
Flange OD 1" (25.40 mm)

Order No. 09 - 8586

Wheel bushing replaces Exmark 1-603602. Fits in wheel 1-603299 on Exmark commercial mowers. Models Turf Ranger, Turf Tracer Explorer.



ID 15/16" (23.81 mm)
OD 1-1/4" (31.75 mm)
Height 11/16" (17.46 mm)
Flange OD 1-5/8" (41.28 mm)

Order No. 09 - 8984

Deck support bushing replaces Exmark 1-513336. Fits models Turf Ranger. (nylon) (black)

30

Order No. 09 - 10064

Front wheel spacer replaces Exmark 1-633581. Fits Lazer Z units. Fits our 08-9803, 08-9804 & 08-9809 wheels. Spacer for front wheel, bearing & seal.



ID 3/4" (19.05mm)
OD 1-1/8" (28.58mm)"
Width 5/8" (15.88mm)

O.E.M.



ID 7/8" (22.23 mm)
OD 1-1/8" (28.56 mm)
Height 1-1/4" (31.75 mm)
Flange OD 1-1/2" (38.10 mm)

Order No. 09 - 8305

Caster yoke support arm bushing replaces Exmark 1-303514, 303044.



ID 7/8" (22.23 mm)
OD 1-1/8" (28.58 mm)
Height 1-1/4" (31.75 mm)

Order No. 09 - 5703

Replaces Exmark 1-303041.



ID 1/2" (12.70mm)
OD 3/4" (19.05mm)
Length 7-1/2" (190.50mm)

Order No. 09 - 9992

Spacer replaces Exmark 1-633959. Fits Exmark Laser Z 13 x 650 x 6 wheels. Used with our 08-10075 wheel.



ID 1/2" (12.70mm)
OD 3/4" (19.05mm)
Length 5-7/8" (149.22mm)

Order No. 09 - 10017

Spacer replaces Exmark 1-633579. Fits Exmark Laser Z 13 x 500 x 6 wheels. Used with our 08-9804 wheel.

Order No. 09 - 8438

Wheel bearing kit for Exmark. Fits Exmark midsize mowers with 36", 48", 52", 60" decks. Fits Exmark wheel 1-322154. Fits Turf Ranger, Turf Tracer & Viking metro models from 80000 series and higher. Kit contains our 09-8408 roller cage bearing with retainer bushings and 09-8409 spanner bushing.

Order No. 09 - 8408

Roller cage bearing with retainer bushings only. Replaces Exmark 1-513809. Roller cage bearing OD 1-1/4" (31.75 mm), ID 49/64" (19.45 mm), Length 3-23/32" (94.46 mm). Retainer bushings OD 1-1/2" (38.10 mm), ID 3/4" (19.05 mm), Height 3/8" (9.53 mm).

Order No. 09 - 8998

Roller cage bearing only for Exmark. Replaces Exmark 1-513809. OD 1-1/4" (31.75 mm), ID 49/64" (19.45 mm), Length 3-23/32" (94.46 mm).

Overall ID 1/2" (12.70 mm)
Overall OD 1-3/8" (34.93 mm)
Overall Length 4-21/32" (118.27 mm)



Order No. 09 - 8999

Retainer bushing only for Exmark. Used on Exmark 1-3322154 wheel assembly & our 08-8197 wheel assembly for Gravely. OD 1-1/2" (38.10 mm), ID 3/4" (19.05 mm).

Order No. 09 - 8409

Spanner bushing only. Replaces Exmark 1-513547. OD 3/4" (19.05 mm), ID 1/2" (12.70 mm), Length 4-5/8" (117.48 mm).



EXMARK (Cont.)



Order No. 10 - 9142

Universal adjustable yoke ends. 5/16" - 24 female, for 5/16" pin. Replaces Exmark 1-303105.

Order No. 10 - 9143

Universal adjustable yoke ends. 3/8" - 24 female, for 3/8" pin. Replaces Exmark 1-633131.



ID 1-1/8"
OD 1-3/4"
Width 7/16"

Order No. 10 - 10013

Front seal wheel bearing replaces Exmark 633580. Fits Lazer Z units. MIN005

Order No. 10 - 10014

Front caster yoke bearing seal replaces Exmark 543511.



ID 1-1/4"
OD 2"
Width 1/4"



Order No. 10 - 8190

Caster Yoke Spacer replaces Exmark 1-303314. ID 7/8", OD 1-1/2", 1/2" thick. Used with our **10-8189** Support Arm.



Order No. 10 - 5706

1" Snap Ring.



Order No. 10 - 2226

3/16" Quick Pin. Replaces Exmark 1-809006. 1-1/2" Length



Order No. 10 - 7181

Lynch Pin replaces Exmark 1-80920. 4-1/8" yoke our **10-7125**. Diameter 7/16"



Order No. 10 - 9972

Dampener replaces Exmark 1-523027. Fits Lazer Z riders. Closed - 6-5/8", Open - 9-1/2"



Order No. 10 - 13470

Damper motion control replaces Exmark 116-0027. Fits Lazer Z & Toro Z Master.



Order No. 10 - 13664

Damper replaces Exmark 109-2339, 1-523027, 103-4079, 103-2913.



Order No. 10 - 12565

Axle nut replaces Exmark 3296-39. 3/8" - 16 nylock. Used in our **10-12016 & 10-12018** deck wheel kits. MIN010

30

O.E.M.

**O.E.M. REPLACEMENT
EXMARK (Cont.)**



Order No. 10 - 10007 **\$9.80**
Anti-Scalp Roller Kit Hardware. Replaces Exmark 603602 bushing, 98-5961 bolt, 3290-357 nut, 373034 pivot washer & 98-5975 spring washer. Consists of 1 each of the above items. Used with our **07-6917** deck wheel.



Order No. 10 - 12016
Deck wheel hardware kit for Exmark. Included in our **07-12018** wheel kit.



Order No. 10 - 12564
Axle screw replaces Exmark 3211-46. 3/8" - 24 x 2. Used in our **10-12016** & **10-12018** deck wheel kits. Grade 8 MIN010



Order No. 10 - 12017
Anti scalp wheel axle replaces Exmark 103-5364. Included in our **07-12018** wheel kit and our **10-12016** hardware kit.



Order No. 10 - 8411
Wheel bolt replaces Exmark 1-800334. Fits Exmark midsize mowers with 36", 48", 52" & 60" Decks. For Models Turf Ranger, Turf Tractor, Viking & Metro models from 80000 series and higher. Used with our **10-8447** wheel bolt nut.

Thread Size 1/2"
Length 6"



Order No. 10 - 8447
Wheel bolt nut replaces Exmark 1-804509. Size 1/2" -13 hex nut. Fits our wheel bolt **10-8411** & **10-8419**. MIN010

Size 1/2" - 13



Order No. 10 - 8419
Wheel bolt replaces Exmark 800334.

Thread Size 1/2"
Length 5-1/4"



Order No. 10 - 11039
Locknut replaces Exmark 3296-51. 3/4" -10. Used with our **10-10194** Yoke. MIN005

Size 3/4"-10



Order No. 10 - 11040
Wheel bolt replaces Exmark 325-36. Used with our **10-11076** nut.

Size 1/2" - 7-1/2"



Order No. 10 - 11566
Blade bolt replaces Exmark 103-0862. 5/8" -18 thread x 2-3/4", cap screw, yellow zinc. MIN010

30

O.E.M.



EXMARK (Cont.)



Order No. 10 - 12633

Screw/Blade bolt replaces Exmark 3213-6. 1/2" -20 x 2-1/4", Grade 8. Fits Triton blades. MIN010

Order No. 10 - 13240

Screw/Blade bolt replaces Exmark 3213-5. 1/2" -20 x 2", Grade 8. MIN010

Order No. 10 - 13504

Screw/Blade bolt replaces Exmark 103-1026. 5/8" - 11 x 1", Grade 8. MIN010



Order No. 10 - 10357

5/16" - 18 Female thread clamping knob. Replaces Exmark 1323385



Order No. 10 - 1191

1/4" Blade Spacer.

Order No. 10 - 7249

1/2" Blade Spacer.



Order No. 10 - 2218

Caster Yoke Support Arm. Replaces Exmark 302122. (Used with our cast yoke **10-2243**). Comes complete with bushing and grease fitting. Uses our bushing **09-5721**.

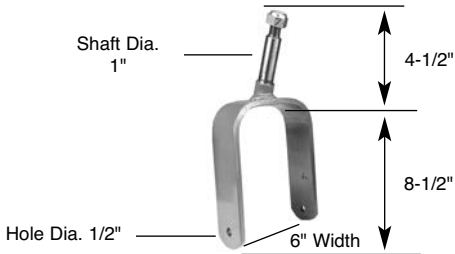

Order No. 10 - 10194

6" Caster yoke replaces Exmark 1-632511-01. Fits 13 x 5.00 - 6 wheel. Used on 52" Lazer Z HP. (Red). Uses our **10-11039** 3/4" nylon nut, Exmark #3296-51.

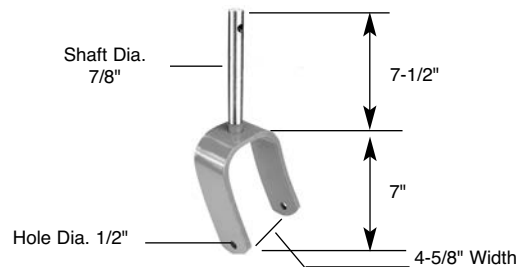

Order No. 10 - 10307

Caster yoke replaces Exmark 1-322145-01. Fits Metro and Viking walkbehinds with serial 102000 and higher.

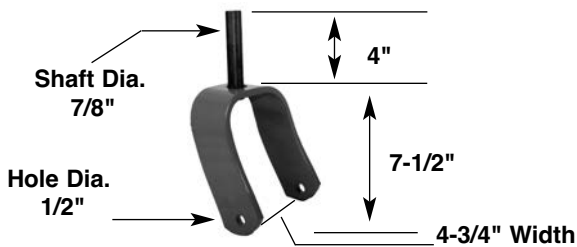

Order No. 10 - 8625

4-1/2" yoke replaces Exmark 1-522143-01. Fits models Turf Ranger & Turf Tracer 52" & 60" cut & Explorer 44" & 52" cut models. (Red)



Order No. 10 - 12668

Spindle housing with bearing. Replaces Exmark 103-2547. Fits models Lazer Z HP 44", 48" & 52" cut decks.

30

O.E.M.

O.E.M. REPLACEMENT
EXMARK (Cont.)



Order No. 10 - 1227

6-1/4" Spindle Assembly. Replaces Exmark 1-402006.



Order No. 10 - 1227

6-1/4" Spindle Assembly. Replaces Exmark 1-402006.



Order No. 10 - 1226

5-1/8" Spindle Assembly. Replaces Exmark 1-302030.

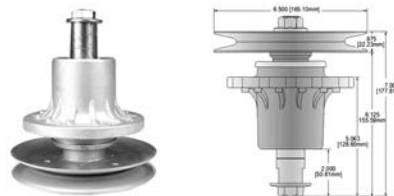

Order No. 10 - 10353

Spindle Assembly replaces Exmark 1-634972. Fits Lazer Z model numbers 150000 thru 259999. **Uses our 13-10960.**

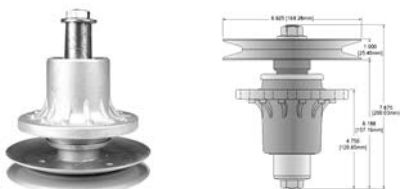

Order No. 10 - 10785

Spindle assembly replaces Exmark 103-1184. Fits Lazer Z HP 52" decks.

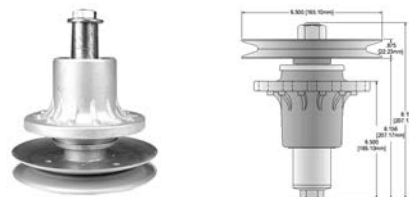

Order No. 10 - 10872

Spindle assembly replaces Exmark 103-3200. Fits Lazer Z HP 60" decks.



Order No. 10 - 13003

Spindle assembly replaces Exmark 103-1105. Fits 48" decks on Lazer Z HP models.



Order No. 10 - 13004

Spindle assembly replaces Exmark 103-1183. Fits 44" decks on Lazer Z HP models.



Order No. 10 - 13005

Spindle assembly replaces Exmark 103-9081. Fits 48" decks on Lazer CT, Lazer HP models.



Order No. 10 - 13006

Spindle assembly replaces Exmark 1-644092. Fits newer model Lazer Z, Meteor, Viking, Turf Trace, Turf Ranger decks.

30

O.E.M.



EXMARK (Cont.)



Order No. 10 - 13007

Spindle assembly replaces Exmark 103-8323 & 103-3206. Fits 72" decks on Laser Z, XP series models. Serial number 252,000 and up.

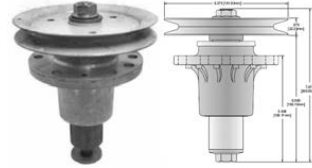

Order No. 10 - 13130

Spindle assembly replaces Exmark 103-1140. Fits 48" decks on Laser Z, HP models.



Order No. 10 - 13540

Spindle assembly replaces Exmark 109-2102. Fits 46", 48", 50", new style Triton Decks. Also fits Lazer Z hp.



Order No. 10 - 12977

Electric PTO clutch replaces Exmark 103-0665, 1-631732, 1-641300, 631732, 614300. 6" Dia. Pulley, 5/8" Belt, shaft size 1-1/8". Fits Lazer Z.



Order No. 10 - 11133

Electric PTO clutch replaces Exmark 103-0661. Fits Lazer Z 18-23 hp Kohler units below 160,000 & 160,000 - 369,999. Also replaces Scag 461397. Fits STHM 3-wheel models. 6-5/16" pulley Diameter, 1" ID, Uses 5/8" belt. Warner 5218-76.



Order No. 10 - 11444

Electric PTO clutch replaces Exmark 103-0664. Also replaces Bobcat 2188151, Ferris 1522040, Husqvarna 102603. Warner 5218-5



Order No. 10 - 11237

Electric PTO clutch replaces Exmark 1-631732, 641300, 103-0665. Fits models 1600,000 & Higher. Warner 5218-65.



Order No. 10 - 11075

Electric PTO clutch replaces Exmark 1653048 & 103-0690. Warner 5218-44.



Order No. 10 - 11857

Electric PTO clutch replaces Exmark 1-611223 & 603539. Fits Turf Tracer models. 1" ID x 6" pulley, A/B belt. Warner 5215-13.



Order No. 10 - 11825

Electric PTO clutch replaces Exmark. Similar to our 10-11075 except with a 1-1/8" bore. Used on Exmarks with larger engines and crankshafts. 1-1/8" ID x 7.385" pulley, 5/8" Belt. Warner 5218-54.

30

O.E.M.

O.E.M. REPLACEMENT



EXMARK (Cont.)



Order No. 10 - 12517

Electric PTO clutch replaces Exmark 109-9276/109-2916. Warner 5218-205. 200 lbs. torque. Shaft size 1", 7-1/8" pulley diameter, 5/8" Belt.



Order No. 10 - 12835

Electric PTO clutch replaces Exmark 109-9275. Warner 5218-210. Replaces Warner 5218-140 & 5218-107. 200 lbs. torque. Shaft size 1-1/8", 7.2" pulley diameter, 5/8" Belt.



Order No. 10 - 11858

Electric PTO clutch replaces Exmark 1-551054, 1-543259, fits Turf Ranger Models. 1" ID x 6" pulley, A/B Belt type. Warner 5215-14.



Order No. 10 - 12261

Electric PTO clutch replaces Exmark 103-0690, 1-653048, 1-653292. Fits Lazer Z hp. Serial numbers 260,000 and higher. 1" ID x 7-3/8" pulley, 5/8" belt. Warner 5218-80.



Order No. 10 - 12262

Electric PTO clutch replaces Exmark 103-0281 & 103-1364. 1-1/8" ID x 6.313" pulley, 5/8" belt. Warner 5218-73.



Order No. 10 - 12403

Electric PTO clutch replaces Exmark 103-3246, fits 27 & 30 hp Kohler Lazer Z units. Warner 5218-99. Shaft size 1-1/8", 7-11/32" pulley diameter, 5/8" Belt.

Order No. 10 - 12981

Electric PTO clutch replaces Exmark 103-3245. 1" ID x 7-1/8" pulley, 5/8" belt. Warner 5218-243 w/pigtail, 5218-228 w/o pigtail, & Warner 5218-100.



Order No.

Description

12 - 9014

Drive Belt. Replaces Exmark 1-633173. 5/8" (15.88 mm) x 111.44" (2830.58 mm). Fits 52" & 60" deck, Lazer models. Wrap molded. *Aramid fiber.

12 - 10885

Drive Belt. Replaces Exmark 1-603306. 5/8" (15.8 mm) x 81-1/4" (2063.8 mm). Fits 52" & 60" Turf Tracer serial numbers 84,000 and above. Wrapped, aramid cord construction.

12 - 13108

Drive Belt. Replaces Exmark 1-323344. 5/8" (15.875mm) x 48.83" (1240.3 mm). Fits 32" Metro walkbehind. Cogged, raw edge, polyester cord construction.

12 - 13454

Drive V-Belt. Replaces Exmark 1-403174. 5/8" (15.87 mm) x 115-9/32" (2928 mm). Fits main deck model Metro 48". Wrapped-molded, aramid cord construction, double cover, clutching, salt/pepper color.

O.E.M. 30



EXMARK (Cont.)



Order No.	Description
12 - 13254	Drive V-Belt. Replaces Exmark 103-6317 . 5/8" (15.87 mm) x 38" (965.2 mm). Fits Metro HP & Turf Tracer Blade Clutch. Aramid cord construction, double cover, clutching, white color.
12 - 13255	Drive V-Belt. Replaces Exmark 109-4199 . 5/8" (15.87 mm) x123" (3124.2 mm). Fits male drive diesel units. Aramid cord construction, double cover, clutching, white color.
12 - 13256	Drive V-Belt. Replaces Exmark 109-5018 . 5/8" (15.87 mm) x158" (4013.2 mm). Fits 66" Lazer Z-XS deck drive. Aramid cord construction, laminated.
12 - 9016	Blade Belt. Replaces Exmark 1-633127. 5/8" (15.88 mm) x 146.17" (3712.72 mm). Fits 60" deck, Lazer models. Raw edge
12 - 10037	Blade Belt. Replaces Exmark 413093. 5/8" (15.9 mm) x 136.64" (3471 mm). *Aramid fiber. Fits 48" Turf Tracer units.
12 - 5867	Blade Drive Belt. Replaces Exmark 1-303080. 5/8" (15.88 mm) x 88.8" (2255.52). For 36" front cut mowers, 14000 series and higher.
12 - 9862	Blade Drive Belt. Replaces Exmark 1-633366. 5/8" (15.9 mm) x 128-13/16" (3271.8 mm). Fits 52" Lazer Z. Raw Edge, *Aramid fiber.
12 - 10251	Blade Drive Belt. Replaces Exmark 1-413308. 5/8" (15.9 mm) x 141-1/4" (3587.75 mm). Fits 52" Turf Tracer and 48" Lazer HP.
12 - 10886	Blade Drive Belt. Replaces Exmark 1-603045. 1/2" (12.7 mm) x 112-1/2" (2857.5 mm). Fits 60" deck Turf Tracer. Raw edge, laminated, aramid cord construction.
12 - 12425	Blade Drive Belt. Replaces Exmark 109-5364 . 1/2" (12.7mm) x 146.1" (3710.9 mm). Fits models Exmark Quest & Toro Titan. Aramid cord, construction, double cover, clutching-white.
12 - 14638	 Deck Belt. Replaces Exmark 103-2240 . 5/8" (15.87 mm) x 83-3/4" (2127.3 mm). Fits 52" Turf Tracer Hydro Wide area walk mowers. Wrapped molded, Aramid cord construction, double cover, white.
12 - 14209	Deck Belt. Replaces Exmark 116-3455 . 5/8" (15.87 mm) x 154.875" (3933.82 mm). Fits 48" decks. Wrapped molded, Aramid cord construction, double cover, clutching, brown.
12 - 14167	Deck Belt. Replaces Exmark 109-8073 . 5/8" (15.87 mm) x 198.75" (5048.25 mm). Fits Lazer Z 60" decks. Wrapped molded, Aramid cord construction, double cover, clutching, brown.
12 - 14165	Deck Belt. Replaces Exmark 109-4994 . 5/8" (15.87 mm) x 186.00" (4724.4 mm). Fits Lazer Z 52" decks. Wrapped molded, Aramid cord construction, double cover, clutching, brown.
12 - 14217	Deck Belt. Replaces Exmark 109-8070 . 5/8" (15.87 mm) x 175.75" (4464.05 mm). Fits Lazer Z 48" decks. Wrapped molded, Aramid cord construction, double cover, clutching, brown.
12 - 10038	Deck Belt. Replaces Exmark 523175. 1/2" (12.7 mm) x 134-1/4" (3410 mm). *Aramid fiber. Fits 60" deck Lazer Z.

O.E.M. REPLACEMENT



EXMARK (Cont.)



Description

Order No.

12 - 10041	Deck Belt. Replaces Exmark 643052. 5/8" (15.88 mm) x 169.46" (4304 mm). Deck belt for 72" Lazer Z units. *Aramid fiber.
12 - 12405	Deck Belt. Replaces Exmark 1-413096. 5/8" (15.87mm) x 36.081" (916.4 mm). Neoprene, Aramid cord construction, double-cover, clutching.
12 - 12783	Deck Belt. Replaces Exmark 103-6506 . 5/8" (15.875 mm) x 118-3/4" (3016.25 mm). Fits Lazer Z XS, 66" deck. Raw edge, laminated, aramid cord construction.
12 - 12256	Deck Drive Belt. Replaces Exmark 1-603576. 1/2" (12.7mm) x 101-1/4" (2571.8 mm). Fits Turf Tracer & Turf Ranger models. Raw edge laminated aramid cord construction.
12 - 8091	Engine to Blade Belt. Replaces Exmark 1-323299. "B" Section Belt, 82-11/32" length (2091.53 mm), fits 5 speed and variable speed with 48" decks.
12 - 8092	Engine to Blade Belt. Replaces Exmark 1-403025. 5/8" (15.88 mm) width x 51-29/32" (1318.42 mm) length. For 48" deck models. *Aramid fiber.
12 - 8370	Engine to Blade Belt. Replaces Exmark 1-403024. 5/8" width (15.88 mm) x 93.9 length (2385.1 mm). For 48" deck models. *Aramid fiber.
12 - 8805	Engine to Blade Belt. Replaces Exmark 1-323300. 5/8" (15.88 mm) x 87.92" (2233.17 mm). Fits Exmark 48" cut metro units. Raw edge. *Aramid fiber.
12 - 13109	Engine to Blade Belt. Replaces Exmark 1-323733 . 5/8" (15.875mm) x 82.6" (2098 mm). Fits 36" Metro walkbehind. Wrapped molded, aramid cord construction, double cover, white.
12 - 13110	Engine to Blade Belt. Replaces Exmark 1-323734 . 5/8" (15.875mm) x 80.95" (2056 mm). Fits 32" Metro walkbehind. Wrapped molded, aramid cord construction, double cover, white.
12 - 8812	Engine to Gear Box Belt. Replaces Exmark 1-323280. 1/2" (12.7 mm) x 39.64" (1006.86 mm). Fits Exmark 32", 36", 48" & 52" metro units. Raw edge. *Aramid fiber.
12 - 5865	Wheel Drive Belt. Replaces Exmark 1-323051. 5/8" (15.88 mm) x 44-7/8" length (1139.83 mm) For 32" decks, 5 speed transmission 10000 series and higher. cogged.
12 - 9257	Wheel Drive Belt. Replaces Exmark 1-323288. Double "A" section 1/2" (12.7 mm) x 48-13/16" (1239.8 mm). Fits 36", 48" & 52" cut mowers. Raw edge. *Aramid fiber.
12 - 10167	Blower Belt. Replaces Exmark 1-653332. 1/2" (12.7 mm) x 37-3/4" (958.8 mm). Polyester cord construction. Fits 44" mowers.
12 - 10039	Blower Belt. Replaces Exmark 1-653333. 1/2" (12.7 mm) x 38-1/2" (977.9 mm). Polyester cord construction. Fits 48" mowers.
12 - 10716	Blower Belt. Replaces Exmark 103-0866. 1/2" (12.7 mm) x 40-13/32" (1026.32 mm). Wrapped-molded, general purpose, polyester cord construction.
12 - 10717	Blower Belt. Replaces Exmark 653438. 1/2" (12.7 mm) x 39-13/32" (1000.92 mm). Wrapped-molded, general purpose, polyester cord construction.

30 O.E.M.



EXMARK (Cont.)

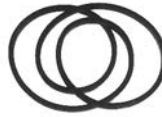

Order No.	Description
12 - 9863	Pump Drive Belt Replaces Exmark 633569. 5/8" (15.9 mm) x 57.19" (1452.6 mm). Fits Exmark Lazer mowers. 5 Rib, general purpose, polyester cord construction.
12 - 10252	Pump Drive Belt. Replaces Exmark 1-653163. .1/2" (12.7 mm) x 52-1/4" (1327.2 mm) Fits 44" & 48 " Lazer ZHP. Raw Edged Cogged.
12 - 10253	Pump Drive Belt. Replaces Exmark 1-653416, 1-653283. 1/2" (12.7 mm) x 51-3/8" (1304.9 mm). Fits 52" Lazer HP.
12 - 10255	Pump Drive Belt. Replaces Exmark 103-0882. 17/32" (13.49 mm) x 70-3/4" (1797.05 mm). Fits Lazer ZXP.
12 - 10256	Pump Drive Belt. Replaces Exmark 103-1297. .700" (17.46 mm) x 25" (635 mm). Fits Lazer ZXP.
12 - 10257	Pump Drive Belt. Replaces Exmark 1-633162. 3/4" (19.05 mm) x 58" (1473.2 mm). Fits Lazer Z. 8 rib.
12 - 10884	Pump Drive Belt. Replaces Exmark 1-613271. 1/2" (12.7 mm) x 58" (1473.2 mm). Fits Turf Tracer. Raw edge, laminated, aramid cord construction.
12 - 10887	Pump Drive Belt. Replaces Exmark 1-413095. 1/2" (12.7 mm) x 50-1/2" (1282.7 mm). Fits Turf Tracer & Viking units. Raw edge, laminated, aramid cord construction.
12 - 12799	Pump Drive Belt. Replaces Exmark 109-7582 . 5K ribbed x 68.8" (1747.52 mm). Raw edge, laminated, aramid cord construction.
12 - 12426	Pump Drive Belt. Replaces Exmark 109-3388 . 1/2" (12.7mm) x 75.392" (1914.9 mm). Fits models Exmark Quest & Toro Titan. Aramid cord, construction, double cover, clutching-brown.
12 - 12641	Pump Drive Belt. Replaces Exmark 103-4761 . 1/2" (12.7mm) x 52-3/4" (1339.8 mm). Raw edge cogged belt.
12 - 10040	Mule Drive Belt. Replaces Exmark 653368. 21/32" (16.67 mm) x 154" (3912 mm). *Aramid fiber. Fits Lazer Z
12 - 10254	Mule Drive Belt. Replaces Exmark 103-0881. 17/32" (13.49 mm) x 120-5/16" (3055.93 mm). Fits Lazer XP.
12 - 12237	Mule Drive Belt. Replaces Exmark 103-4014. 5/8" (15.87mm) x 116-1/8" (3000.4 mm). Fits 60" & 72" Lazer Z mule drive. Wrapped molded, laminated aramid cord construction.

Made with KEVLAR® or non-trade marked Aramid fiber.



Order No. 13 - 5714
Deck Idler. Replaces Exmark 1-403009.



Order No. 13 - 11815
Idler pulley replaces Exmark 1-413099.

ID 11/16"
OD 5-3/4"
Height 2-1/2"

30

O.E.M.

O.E.M. REPLACEMENT



EXMARK (Cont.)



ID 3/8"
OD 2-3/4"
Height 1-3/8"

Order No. 13 - 9753

Idler pulley replaces Exmark 1-323285. Also replaces Yazoo Kees 639-19087.



ID 3/8"
OD 3-1/8"
Height 1-3/16"

Order No. 13 - 9794

Idler pulley replaces Exmark 1-633167. Pump drive belt idler for Lazer Z model.



ID 11/16"
OD 6"
Height 1-1/8"

Order No. 13 - 9793

Idler pulley replaces Exmark 1-633166.



ID 11/16"
OD 5"
Height 7/8"

Order No. 13 - 9772

Idler pulley replaces Exmark 1-603805. Deep V idler pulley fits Lazer Z.



ID 21/32"
OD 6-3/4"
Height 1-3/16"

Order No. 13 - 9864

Idler pulley replaces Exmark 1-633109. Fits 52", 60" & 72" deck belts on Lazer Z units.

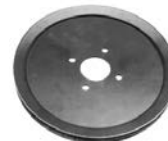

ID 1-21/32"
OD 9"
Height 13/16"

Order No. 13 - 7711

Wheel Drive pulley. Replaces Exmark 1-303464. Fits Exmark 48" mid size.



ID 11/16"
OD 5-1/2"
Height 1-1/8"

Order No. 13 - 10397

Flat Idler pulley replaces Exmark 1-613098. Fits floating deck walkbehind units.



ID 7/8"
OD 6-1/2"
Height 1-1/4"

Order No. 13 - 10960

Spindle pulley replaces Exmark 1633701. Fits Lazer Z model numbers 150000 thru 259999. Fits our 10-10353 spindle assembly.



ID 1"
OD 5-3/4"
Height 1-5/8"
Keyway 1/4"

Order No. 13 - 2185

Spindle Pulley. Replaces Exmark 303073.



ID .985"
OD 6-3/4"
Height 1"

Order No. 13 - 12793

Spindle pulley replaces Exmark 1-653386. Fits Lazer Z CT 52" spindles.



ID .985"
OD 6"
Height 1"

Order No. 13 - 12715

Spindle pulley replaces Exmark 1-653099. Fits Lazer Z CT 44" spindles.

30

O.E.M.



EXMARK (Cont.)



ID .985"
OD 6-1/4"
Height 1"

Order No. 13 - 12317

Spindle pulley replaces Exmark 1-413424. Fits Lazer Z CT 48" spindles.



ID 1"
OD 6-1/4"
Height 1-1/4"
Keyway 1/4"

Order No. 13 - 9770

Engine pulley replaces Exmark 1-303498. Fits 36" commercial walkbehind mowers. Uses a 5/8" belt. 2 set screws.



ID 1"
OD 2-3/4"
Height 1-1/8"
Keyway 1/4"

Order No. 13 - 9771

Transmission pulley replaces Exmark 1-323256. Fits 36" & 48" commercial walkbehind mowers. Uses a 1/2" belt. 1 set screw.



ID 1"
OD 4-1/2"
Height 1-1/4"
Keyway 1/4"

Order No. 13 - 9262

Transmission drive pulley replaces Exmark 1-323070. Fits 36, 48 & 52" cut, 5 speed Viking & Metro series, commercial mid-size walkbehind mowers. Cast iron pulley.



ID 11/16"
OD 3-1/8"
Height 3/4"

Order No. 13 - 12301

Idler pulley replaces Exmark 109-3397. Fits Quest models.



ID 11/16"
OD 4"
Height 3/4"

Order No. 13 - 12302

Idler pulley replaces Exmark 109-4077. Fits Quest models.



ID 3/8"
OD 2-3/4"
Height 1"

Order No. 13 - 12300

Idler pulley replaces Exmark 109-4076. Fits Laser Z & Frontrunner models.



ID 3/8"
OD 3-15/16"
Height 29/32"

Order No. 13 - 13013

V-Idler pulley replaces Exmark 1-303516.













30

O.E.M.

O.E.M. REPLACEMENT
EXMARK (Cont.)















30
O.E.M.

ORDER NO.	REPLACES O.E.M. NO.	LENGTH	CENTER HOLE DIAM.	OUTSIDE HOLE DIAM.	CENTER TO CENTER	WIDTH	STEEL THICK.	APPLICATION
 15 - 6279 MIN028	1-503031	4-1/4" 108mm	17/32" 13.5mm			1" 25.4mm	.117" 3mm	Finger Blades. Fits Encore Power Thatcher model 25T100. Fits our 10-8524 shaft. 28 blades per set.
 15 - 6834	1-513264	7" 177.8mm	1/2" 12.7mm			2-1/2" 63.5mm	.160" 4.1mm	Sweeper Blade. For 44" Exmark "ZERO TURN". Used with our 15-6089 & 15-6090
 15 - 6820	1-653102	15-1/4" 387.4mm	5/8" 15.9mm			2-1/2" 63.5mm	.204" 5.2mm	(3) blades for 44" cut. Mulching Blade
 15 - 10420	103-1579	15-1/4" 387.4mm	5/8" 15.9mm			2-1/2" 63.5mm	.204" 5.2mm	(3)blade for 44" cut Solid Air Foil Hi-Lift.
 15 - 11269	103-6400	15-1/4" 387.4mm	15/16" 23.8mm			2-1/2" 63.5mm	.204" 5.2mm	Notched Air Foil Blade (3) blades for 44" cut. High Lift Blade.
 15 - 11243	103-6395	15-1/4" 387.4mm	15/16" 23.8mm			2-1/2" 63.5mm	.204" 5.2mm	Patented (3) blades for 44" cut. Mulching Blade.
 15 - 11500	103-6390	15-1/4" 387.4mm	15/16" 23.8mm			2-1/2" 63.5mm	.204" 5.2mm	Commercial Mulcher (3) blades for 44" cut.
 15 - 6821	1-653101	15-5/16" 388.9mm	5/8" 15.9mm			2-1/2" 63.5mm	.204" 5.2mm	(3) blades for 44" cut. High lift.
 15 - 9884	1-653101	15-5/16" 388.9mm	5/8" 15.8mm			2-1/2" 63.5mm	.204" 5.2mm	Mulching Blade PATENTED
 15 - 1009	1-403026	16-1/4" 412.8mm	5/8" 15.9mm	1/4" 6.4mm	1-5/8" 41.3mm	2-1/2" 63.5mm	.150" 3.8mm	(3) blades for 48" cut
 15 - 2172	1-403059	16-1/4" 412.8mm	5/8" 15.9mm	11/32" 8.7mm	1-5/8" 41.3mm	2-1/2" 63.5mm	.240" 6.1mm	(3) blades for 48" cut (Heavy Duty)
 15 - 10718	103-2507	16-1/4" 412.8mm	5/8" 15.9mm			2-1/2" 63.5mm	.204" 5.2mm	Low Lift blade. (3) blades for a 48" cut.
 15 - 9487	1-323515	16-1/4" 412.8mm	5/8" 15.8mm			2-1/2" 63.5mm	.204" 5.2mm	(3) blades for 48" cut. Fits Turf Tracer, HP Metro, & Viking units.



EXMARK (Cont.)

ORDER NO.	REPLACES O.E.M. NO.	LENGTH	CENTER HOLE DIAM.	OUTSIDE HOLE DIAM.	CENTER TO CENTER	WIDTH	STEEL THICK.	APPLICATION
 15 - 6175	1-403086	16-1/4" 412.8mm	5/8" 15.9mm			2-1/2" 63.5mm	.160" 4.1mm	(3) blades for 48" cut Mulching blade
 15 - 9988	1036581 1-403148	16-1/4" 412.8mm	5/8" 15.9mm			2-1/2" 63.5mm	.204" 5.2mm	(3) blades for 48" cut. Mulching Blade Heavy Duty
 15 - 10419	103-1577	16-1/4" 412.8mm	5/8" 15.9mm			2-1/2" 63.5mm	.204" 5.2mm	(2)blade for 32" cut (3)blade for 48" cut Solid Air Foil Hi-Lift.
 15 - 10172	1-403026 1-403059 1-403086	16-1/4" 412.8mm	5/8" 15.8mm			2-1/2" 63.5mm	.204" 5.2mm	Flat Blade Sharpened - 4-sides
 15 - 6296	1-403026 1-403059 1-403086	16-1/4" 412.8mm	5/8" 15.9mm			2-1/2" 63.5mm	.204" 5.2mm	Mulching Blade PATENTED
 15 - 9967	1-403026 1-403059 1-403086	16-1/4" 412.8mm	5/8" 15.8mm			2" 50.8mm	.240" 6.1mm	Low-Lift Blade Sharpened - 4-sides
 15 - 11494	103-6386	16-1/4" 412.7mm	15/16" 23.8mm			2-1/2" 63.5mm	.204" 5.2mm	Low Lift Blade (2) blades for 32" cut. (3) blades for 48" cut.
 15 - 11493	103-6381	16-1/4" 412.7mm	15/16" 23.8mm			2-1/2" 63.5mm	.204" 5.2mm	High Lift Blade (2) blades for 32" cut. (3) blades for 48" cut.
 15 - 11231	103-6401	16-1/4" 412.7mm	15/16" 23.8mm			2-1/2" 63.5mm	.204" 5.2mm	Notched Air Foil Blade. (3) blades for 48" cut. High Lift Blade.
 15 - 11240	103-6391	16-1/4" 412.7mm	15/16" 23.8mm			2-1/2" 63.5mm	.204" 5.2mm	(3) blades for 48" cut. Mulching Blade.
 15 - 11279	103-6396	16-1/4" 412.7mm	15/16" 23.8mm			2-1/2" 63.5mm	.204" 5.2mm	Patented (3) blades for 48" cut. Mulching Blade.
 15 - 12002	103-8251	16-1/4" 412.75mm	15/16" 23.8mm			3" 76.2mm	.204" 5.2mm	High Lift Blade (3) blades for a 46" cut.

30
O.E.M.

O.E.M. REPLACEMENT
EXMARK (Cont.)















30
O.E.M.

ORDER NO.	REPLACES O.E.M. NO.	LENGTH	CENTER HOLE DIAM.	OUTSIDE HOLE DIAM.	CENTER TO CENTER	WIDTH	STEEL THICK.	APPLICATION
 15 - 11770	103-8296 103-8370	16-1/4" 412.75mm	15/16" 23.8mm			3" 76.2mm	.204" 5.2mm	Med. Lift Blade (3) blades for a 46" cut.
 15 - 11769	103-8296 103-8390	16-1/4" 412.75mm	15/16" 23.8mm			3" 76.2mm	.204" 5.2mm	Low Lift Blade (3) blades for a 46" cut.
 15 - 11771	103-8296 103-8288	16-1/4" 412.75mm	15/16" 23.8mm			3" 76.2mm	.204" 5.2mm	Mulching Blade (3) blades for a 46" cut.
 15 - 11772	103-9614 103-8296	16-1/4" 412.75mm	15/16" 23.8mm			3" 76.2mm	.204" 5.2mm	Mulching Blade PATENTED (3) blades for a 46" cut.
 15 - 12003	103-9605	17-1/2" 444.5mm	15/16" 23.8mm			3" 76.2mm	.204" 5.2mm	High Lift Blade (3) blades for a 50" cut.
 15 - 11774	103-9600	17-1/2" 444.5mm	15/16" 23.8mm			3" 76.2mm	.204" 5.2mm	Med Lift Blade (3) blades for a 50" cut.
 15 - 11773	103-9598	17-1/2" 444.5mm	15/16" 23.8mm			3" 76.2mm	.204" 5.2mm	Low Lift Blade (3) blades for a 50" cut.
 15 - 11775	103-9510	17-1/2" 444.5mm	15/16" 23.8mm			3" 76.2mm	.204" 5.2mm	Mulching Blade (3) blades for a 50" cut.
 15 - 11776	103-9615	17-1/2" 444.5mm	15/16" 23.8mm			3" 76.2mm	.204" 5.2mm	Mulching Blade PATENTED (3) blades for a 50" cut.
 15 - 6291	1-633484	17-29/32" 454.8mm	5/8" 15.9mm			2-1/2" 63.5mm	.204" 5.2mm	(3) blades for 52" cut Mulching blade
 15 - 6178	1-303495	17-15/16" 455.6mm	5/8" 15.9mm			2-1/2" 63.5mm	.160" 4.1mm	(2) blades for 36" cut Mulching blade
 15 - 1010	1-303146	18" 457.2mm	5/8" 15.9mm	1/4" 6.4mm	1-5/8" 41.3mm	2-1/2" 63.5mm	.150" 3.8mm	(2) blades for 36" cut



EXMARK (Cont.)













ORDER NO.	REPLACES O.E.M. NO.	LENGTH	CENTER HOLE DIAM.	OUTSIDE HOLE DIAM.	CENTER TO CENTER	WIDTH	STEEL THICK.	APPLICATION
 15 - 2173	1-303283	18" 457.2mm	5/8" 15.9mm			2-1/2" 63.5mm	.240" 6.1mm	(3) blades for 52" cut (2) blades for 36" cut (Heavy Duty)
 15 - 6217	1-603844	18" 457.2mm	1/2" 12.7mm			2-1/2" 63.5mm	.204" 5.2mm	(3) blades for 52" cut Fits model FMD52 Low lift
 15 - 10719	103-2508	18" 457.2mm	5/8" 15.9mm			2-1/2" 63.5mm	.204" 5.2mm	Low Lift blade. (3) blades for a 52" cut.
 15 - 10071	1-303527	18" 457.2mm	5/8" 15.9mm			2-1/2" 63.5mm	.204" 5.2mm	(3) blades for 52" cut. High Lift Blade. Fits Lazer Z units.
 15 - 10173	1-303146	18" 457.2mm	5/8" 15.8mm			2-1/2" 63.5mm	.204" 5.2mm	Flat Blade Sharpened - 4-sides
 15 - 6294	1-303146	18" 457.2mm	5/8" 15.9mm			2-1/2" 63.5mm	.204" 5.2mm	Mulching Blade PATENTED
 15 - 9968	1-303146	18" 457.2mm	5/8" 15.8mm			2" 50.8mm	.240" 6.1mm	Low-Lift Balde Sharpened - 4-sides
 15 - 11267	103-6397	18" 457.2mm	15/16" 23.8mm			2-1/2" 63.5mm	.204" 5.2mm	(3) blades for 52" cut. Mulching Blade.
 15 - 11241	103-6392	18" 457.2mm	15/16" 23.8mm			2-1/2" 63.5mm	.204" 5.2mm	(2) blades for 36" cut. (3) blades for 52" cut. Mulching Blade.
 15 - 11495	103-6402	18" 457.2mm	15/16" 23.8mm			2-1/2" 63.5mm	.204" 5.2mm	High Lift Blade (2) blades for 36" cut. (3) blades for 52" cut.
 15 - 11450	103-6382	18" 457.2mm	15/16" 23.8mm			2-1/2" 63.5mm	.204" 5.2mm	High Lift Blade (3) blades for 52" cut.
 15 - 11451	103-6387	18" 457.2mm	15/16" 23.8mm			2-1/2" 63.5mm	.204" 5.2mm	Low Lift Blade (3) blades for 52" cut.

30
O.E.M.

O.E.M. REPLACEMENT
EXMARK (Cont.)















O.E.M.
30

ORDER NO.	REPLACES O.E.M. NO.	LENGTH	CENTER HOLE DIAM.	OUTSIDE HOLE DIAM.	CENTER TO CENTER	WIDTH	STEEL THICK.	APPLICATION
 15 - 12004	103-9606	19-1/2" 495.3mm	15/16" 23.8mm			3" 76.2mm	.204" 5.2mm	High Lift Blade (3) blades for a 56" cut.
 15 - 11778	103-9607	19-1/2" 495.3mm	15/16" 23.8mm			3" 76.2mm	.204" 5.2mm	Med Lift Blade (3) blades for a 56" cut.
 15 - 11777	103-9603	19-1/2" 495.3mm	15/16" 23.8mm			3" 76.2mm	.204" 5.2mm	Low Lift Blade (3) blades for a 56" cut.
 15 - 11779	103-9611	19-1/2" 495.3mm	15/16" 23.8mm			3" 76.2mm	.204" 5.2mm	Mulching Blade (3) blades for a 56" cut.
 15 - 11780	116-5498 103-9628	19-1/2" 495.3mm	15/16" 23.8mm			3" 76.2mm	.204" 5.2mm	Mulching Blade PATENTED (3) blades for a 56" cut.
 15 - 10928	93-4106-03 108-3762-03	20-27/32" 531mm	7/16" 11mm	3/8" 9.5mm	2-7/16" 61.9mm	2-1/4" 57.2mm	.150" 3.8mm	Fits 21" Recycler Walkbehind mower.
 15 - 6250	1-603283	20-1/2" 520.7mm	1/2" 12.7mm			2-1/2" 63.5mm	.204" 5.2mm	Std. high lift for models Explorer, Explorer II, Turf Ranger & Turf Tracer. (3) blades for 60" cut.
 15 - 6216	1-603661	20-1/2" 520.7mm	1/2" 12.7mm			2-1/2" 63.5mm	.204" 5.2mm	(3) blades for 60" cut Fits model FMD60 Low lift
 15 - 6180	9383	20-1/2" 520.7mm	5/8" 15.9mm			2-1/2" 63.5mm	.240" 6.1mm	(3) blades for 60" cut
 15 - 10249		20-1/2" 520.7mm	5/8" 15.9mm			2-1/2" 63.5mm	.204" 5.2mm	60" deck. Low lift sand blade 20-1/2" x 5/8" center hole. Same as our 15-6216 but with a 5/8" center hole.
 15 - 11242	103-6393	20-1/2" 520.7mm	15/16" 23.8mm			3" 76.2mm	.204" 5.2mm	Fits Lazer model. (3) blades for 60" cut. Mulching Blade.
 15 - 11249	103-6383	20-1/2" 520.7mm	15/16" 23.8mm			2-1/2" 63.5mm	.240" 6.1mm	Air Foil Blade (3) blades for 60" cut. High lift blade.



EXMARK (Cont.)







ORDER NO.	REPLACES O.E.M. NO.	LENGTH	CENTER HOLE DIAM.	OUTSIDE HOLE DIAM.	CENTER TO CENTER	WIDTH	STEEL THICK.	APPLICATION
 15 - 11248	103-6403	20-1/2" 520.7mm	15/16" 23.8mm			2-1/2" 63.5mm	.240" 6.1mm	(3) blades for 60" cut. Notched High lift blade
 15 - 11224	103-6403	20-1/2" 520.7mm	15/16" 23.8mm			2-1/2" 63.5mm	.204" 5.2mm	High lift blade (3) blades for 60" cut. Notched Air lift blade.
 15 - 11139	103-0301 1-613112	20-1/2" 520.7mm	5/8" 15.8mm			3" 76.2mm	.204" 5.2mm	(3) blades for 60" cut. Mulching Blade.
 15 - 9465	1-603283	20-1/2" 520.7mm	1/2" 12.7mm			2-1/2" 63.5mm	.204" 5.2mm	Mulching Blade PATENTED
 15 - 10667	103-2530	20-1/2" 520.7mm	5/8" 15.9mm			2-1/2" 63.5mm	.204" 5.2mm	Notched High Lift blade. (3) blades for a 60" cut.
 15 - 6083	1-633483	20-1/2" 520.7mm	5/8" 15.9mm			2-1/2" 63.5mm	.240" 6.1mm	(3) blades for 60" cut. High lift for wet grass
 15 - 6290	1-613112	20-1/2" 520.7mm	5/8" 15.9mm			2-1/2" 63.5mm	.204" 5.2mm	(3) blades for 60" cut. Mulching Blade
 15 - 10175	1-613112	20-1/2" 520.7mm	5/8" 15.8mm			2-1/2" 63.5mm	.204" 5.2mm	Flat Blade Sharpened - 4-sides
 15 - 6303	1-613112	20-1/2" 520.7mm	5/8" 15.9mm			2-1/2" 63.5mm	.204" 5.2mm	Mulching Blade PATENTED
 15 - 6194	1-613112	20-1/2" 520.7mm	5/8" 15.8mm			2" 50.8mm	.240" 6.1mm	Low-Lift Blade Sharpened - 4-sides
 15 - 11496	103-6388	20-1/2" 520.7mm	15/16" 23.8mm			2-1/2" 63.5mm	.204" 5.2mm	Formed Low Lift Blade (3) blades for 60" cut.
 15 - 11469	103-6398	20-1/2" 520.7mm	15/16" 23.8mm			2-1/2" 63.5mm	.204" 5.2mm	Commercial Mulcher (3) blades for 60" cut.

30
O.E.M.

O.E.M. REPLACEMENT
EXMARK (Cont.)















O.E.M. 30

ORDER NO.	REPLACES O.E.M. NO.	LENGTH	CENTER HOLE DIAM.	OUTSIDE HOLE DIAM.	CENTER TO CENTER	WIDTH	STEEL THICK.	APPLICATION
 15 - 12005	103-8244	20-3/4" 527.1mm	15/16" 23.8mm			3" 76.2mm	.204" 5.2mm	High Lift Blade (3) blades for a 60" cut.
 15 - 11782	103-8396	20-3/4" 527.1mm	15/16" 23.8mm			3" 76.2mm	.204" 5.2mm	Med Lift Blade (3) blades for a 60" cut.
 15 - 11781	103-8240	20-3/4" 527.1mm	15/16" 23.8mm			3" 76.2mm	.204" 5.2mm	Low Lift Blade (3) blades for a 60" cut.
 15 - 11783	103-8107	20-3/4" 527.1mm	15/16" 23.8mm			3" 76.2mm	.204" 5.2mm	Mulching Blade (3) blades for a 60" cut.
 15 - 11784	103-9629	20-3/4" 527.1mm	15/16" 23.8mm			3" 76.2mm	.204" 5.2mm	Mulching Blade PATENTED (3) blades for a 60" cut.
 15 - 13260	108-0954-03	21" 533.4mm	7/16" 11.1mm			2-1/4" 57.2mm	.150" 4mm	Replaces Toro Atomic Bld Mulching Blade PATENTED
 15 - 14491	 116-1037-S	22-1/4" 558.8mm	15/16" 23.8mm			2-1/2" 63.5mm	.187" 4.7mm	(2) blades for 44" cut Fits Quest mowers.
 15 - 12027	103-9618	22-3/4" 577.85mm	15/16" 23.8mm			3" 76.2mm	.204" 5.2mm	High Lift Blade (3) blades for a 66" cut.
 15 - 11786	103-9619	22-3/4" 577.85mm	15/16" 23.8mm			3" 76.2mm	.204" 5.2mm	Med Lift Blade (3) blades for a 66" cut.
 15 - 11785	103-9616	22-3/4" 577.85mm	15/16" 23.8mm			3" 76.2mm	.204" 5.2mm	Low Lift Blade (3) blades for a 66" cut.
 15 - 11787	103-9612	22-3/4" 577.85mm	15/16" 23.8mm			3" 76.2mm	.204" 5.2mm	Mulching Blade (3) blades for a 66" cut.
 15 - 11788	103-9630	22-3/4" 577.85mm	15/16" 23.8mm			3" 76.2mm	.204" 5.2mm	Mulching Blade PATENTED (3) blades for a 66" cut.



EXMARK (Cont.)



ORDER NO.	REPLACES O.E.M. NO.	LENGTH	CENTER HOLE DIAM.	OUTSIDE HOLE DIAM.	CENTER TO CENTER	WIDTH	STEEL THICK.	APPLICATION
 15 - 6481	1-643006 103-2531	24-13/32" 619.9mm	5/8" 15.9mm			3" 76.2mm	.204" 5.2mm	(3) blades for 72" cut. Fits model Lazer Z.
 15 - 9882	103-2521 1-643097	24-1/2" 622.3mm	5/8" 15.9mm			3" 76.2mm	.204" 5.2mm	(3) blades for 72" cut. Mulching blade. Fits Lazer Z units.
 15 - 10421	103-1581	24-1/2" 622.3mm	5/8" 15.9mm			3" 76.2mm	.204" 5.2mm	(3) blades for 72" cut Solid Air Foil Hi-Lift.
 15 - 11498	103-6384	24-1/2" 622.3mm	15/16" 23.8mm			3" 76.2mm	.204" 5.2mm	Solid Air Foil High Lift (3) blades for 72" cut.
 15 - 11501	103-6399	24-1/2" 622.3mm	15/16" 23.8mm			2-1/2" 63.5mm	.204" 5.2mm	Commercial Mulcher (3) blades for 72" cut.
 15 - 11244	103-6394	24-1/2" 622.3mm	15/16" 23.8mm			3" 76.2mm	.204" 5.2mm	Fits 72" Lazer model. (3) blades for 72" cut. Mulching Blade.
 15 - 11229	103-6404	24-1/2" 622.3mm	15/16" 23.8mm			3" 76.2mm	.204" 5.2mm	Fits 72" Lazer model. (3) blades for 72" cut. Air Foil Lift High Blade.
 15 - 12028	103-9624	24-3/4" 628.7mm	15/16" 23.8mm			3" 76.2mm	.204" 5.2mm	High Lift Blade (3) blades for a 72" cut.
 15 - 11790	103-9625	24-3/4" 628.7mm	15/16" 23.8mm			3" 76.2mm	.204" 5.2mm	Med Lift Blade (3) blades for a 72" cut.
 15 - 11789	103-9622	24-3/4" 628.7mm	15/16" 23.8mm			3" 76.2mm	.204" 5.2mm	Low Lift Blade (3) blades for a 72" cut.
 15 - 11791	103-9613	24-3/4" 628.7mm	15/16" 23.8mm			3" 76.2mm	.204" 5.2mm	Mulching Blade (3) blades for a 72" cut.
 15 - 11792	103-9631	24-3/4" 628.7mm	15/16" 23.8mm			3" 76.2mm	.204" 5.2mm	Mulching Blade PATENTED (3) blades for a 72" cut.

30
O.E.M.

O.E.M. REPLACEMENT



EXMARK (Cont.)

ORDER NO.	REPLACES O.E.M. NO.	LENGTH	CENTER HOLE DIAM.	OUTSIDE HOLE DIAM.	CENTER TO CENTER	WIDTH	STEEL THICK.	APPLICATION
 15 - 6406	1-513876	26" 660.4mm	1/2" 12.7mm			2-1/2" 63.5mm	.204" 5.2mm	Fits Right Hand side of Exmark Explorer 52" cut. Left hand cutting edge Used with our 15-6405 & 15-6407.
 15 - 6407	1-513875	26" 660.4mm	1/2" 12.7mm			2-1/2" 63.5mm	.204" 5.2mm	Fits Left Hand side of Exmark Explorer 52" cut. Right hand cutting edge Used with our 15-6405 & 15-6406.

30 O.E.M.

Splined Blade Bushing for EXMARK



ID 1/2"
Flange OD 1-3/4"
Height 1"



Order No. 17 - 14440

Splined blade bushing replaces Exmark 103-3037. Bushing fits all Exmark blades with .94" center hole. Fits our **10-13005 & 10-13540** spindle assemblies.



ID 5/8"
OD 1-3/4"
Thickness .117"

Order No. 17 - 14050

Blade bellville washer replaces Exmark 1-513208.

MIN005



Order No. 19 - 9464

Transmission filter replaces Exmark 1-523541. Hydrostatic transmission filter has 3/4" - 16 thread, 40 micron, 3-7/8" Height, 3" OD.



Order No. 19 - 9361

Transmission filter replaces Exmark 513211. Hydrostatic transmission filter has 3/4" - 16 thread, 10 micron, 3-7/8" Height, 3" OD.



Order No. 19 - 12374

Oil filter replaces Hydro Gear HG52114. Fits (Transmission Model ZT2800). Replaces Exmark 109-3321.



Order No. 20 - 11273

Two-Way Fuel cut-off valve. 1/4" barb fitting. Fits Zero Turn riders with two tanks. Also replaces Exmark 1-633347.



Order No. 20 - 9700

Oil tank cap replaces Toro E513167. Also replaces Exmark 1-513167. 2" Dia.



Order No. 21 - 13998

Arm rest replaces Exmark/Toro 107-1887, 110-6569, 108-6163 & 69-1180.



EXMARK (Cont.)



Order No. 28 - 8979
Grass bag replaces Exmark 1-352009. (Black)

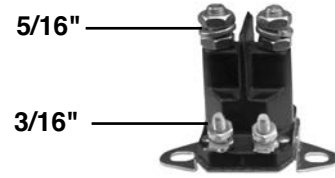

Order No. 31 - 8943
Universal Solenoid. Replaces Exmark 1-513075.



Order No. 31 - 10772
Universal starter solenoid 4 pole, 12 volt. Terminal post will accommodate both 5/16" & 1/4" terminal connectors, Mounting bracket will accommodate both chassis and wall mount configurations. Replaces Exmark 1-513075.

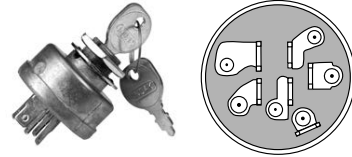

Order No. 31 - 11822
Ignition switch replaces Exmark 103-0206. 3 position, 6 terminals.



Order No. 31 - 9158
Ignition switch replaces Exmark 1-543070. Fits Exmark Laser "ZERO TURN" models.



Order No. 31 - 9622
Multi-application ignition switch fits Exmark. Includes key, lock-washer nut. 2 terminals/ 2 positions.

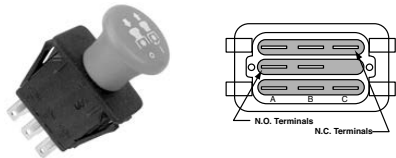

Order No. 31 - 9657
PTO switch replaces Exmark 1-633673. Middle terminal blank. Push-pull/Snap in mount. Red Knob.

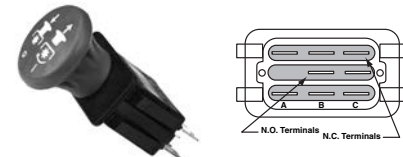

Order No. 31 - 12624
PTO switch replaces Exmark 116-0124. Electrical rating 10A@12-14VDC. Number life at rated load: 100,000 cycles resistive. (High Current). Red Knob.

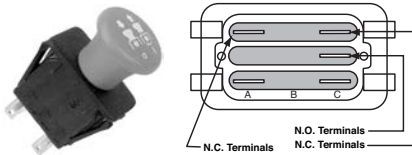

Order No. 31 - 11470
PTO switch replaces Exmark 103-5221. Fits Lazer Z, Turf Tracer, & Turf Ranger Models.Red Knob.

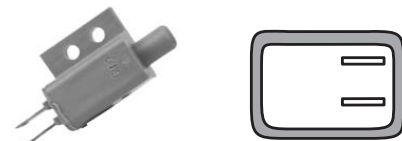

Order No. 31 - 9658
Plunger Interlock switch replaces Exmark 1-513152. Single pole, normally closed.



Order No. 31 - 9659
Plunger Interlock switch replaces Exmark 1-633111. Double pole, normally open / normally closed.



Order No. 31 - 9664
Plunger Interlock switch replaces Exmark 1-740275. Single post, right angle snap in mounted. Normally closed.

30

O.E.M.



O.E.M. REPLACEMENT

FLYMO



Order No. 07 - 9671

7" Plastic wheel replaces Flymo 5138636-02. 7" wheel, 1-1/2" (38mm) hub, .475" (12.1mm) center hole. Geared self propelled wheel. Black hub cover. Used with our inside white hub cover **07-9672**.

Order No. 07 - 9672

7" Plastic white hub cover replaces Flymo 5127526-69. Inside white hub cover for our **07-9670 & 07-9671**.

Order No. 07 - 9676

9" Plastic wheel replaces Flymo 6823809. 9" wheel, 1-5/8" (41mm) hub, .475" (12.1mm) center hole. Black hub cover. Used with our inside white hub cover **07-9678**.

Order No. 07 - 9677

9" Plastic wheel replaces Flymo 6824900. 9" wheel, 1-5/8" (41mm) hub, .475" (12.1mm) center hole. Geared self propelled wheel. Black hub cover. Used with our inside white hub cover **07-9678**.

Order No. 07 - 9678

9" Plastic white hub cover replaces Flymo. Inside white hub cover for our **07-9676 & 07-9677**.



Order No. 07 - 9673

8" Plastic wheel replaces Flymo 51275188. 8" wheel, 1-1/2" (38mm) hub, .475" (12.1mm) center hole. Black hub cover. Used with our inside white hub cover **07-9675**.

Order No. 07 - 9674

8" Plastic wheel replaces Flymo 5138640-02. 8" wheel, 1-1/2" (38mm) hub, .475" (12.1mm) center hole. Geared self propelled wheel. Black hub cover. Used with our inside white hub cover **07-9675**.

Order No. 07 - 9675

8" Plastic white hub cover replaces Flymo 5138644. Inside white hub cover for our **07-9673 & 07-9674**.



30

O.E.M.

ORDER NO.	REPLACES O.E.M. NO.	LENGTH	CENTER HOLE DIAM.	OUTSIDE HOLE DIAM.	CENTER TO CENTER	WIDTH	STEEL THICK.	APPLICATION
 15 - 1033	1911	18-1/2" 469.9mm	5/8" 9.5mm	11/32" 8.7mm	1-3/8" 34.9mm	2-1/4" 57.2mm	.150" 3.8mm	

GAVILAN



Order No. 27 - 50173

Gavilan Brush Cutter Blade. 12" (**304.80mm**) Length, 2.75" (**69.85mm**) Width, .095" (**2.4mm**) Thickness. 1" Center Hole.



Order No. 27 - 50174

Gavilan Brush Cutter Blade. 14" (**355.60mm**) Length, 2.75" (**69.85mm**) Width, .095" (**2.4mm**) Thickness. 1" Center Hole.



GILSON (also see LAWN-BOY)



ID 3"
OD 6"

Order No. 05 - 300

Drive Disc replaces Gilson 32222.



ID 1/2"
Width 1-3/8"
Height 5"

Order No. 07 - 6915

Deck Wheel replaces Gilson 210453. 1-1/2" centered hub, steel bushing.



ID 1/2"
Width 1-3/8"
Height 6"

Order No. 07 - 6918

Deck Wheel replaces Gilson 208919, 1-1/2" centered hub.



ID 5/8"
Width 2"
Height 6"

Order No. 07 - 6919

Deck Wheel replaces Gilson 208736, 2-1/8" offset hub.



ID 5/8"
Width 2-3/4"
Height 5"

Order No. 07 - 6917

Deck Wheel replaces Gilson 710138. 2-1/2" offset hub.



ID 1/2"
Width 1-1/2"
Height 4"

Order No. 07 - 6914

Deck Wheel replaces Gilson 245946, 1-1/2" offset hub.



ID 3/4" (19.05 mm)
OD 1-25/32" (45.24 mm)
Height 21/32" (16.67 mm)

Order No. 09 - 813

Replaces Gilson 1044, 1140.



ID 1" (25.40 mm)
OD 1-31/32" (50.01 mm)
Height 19/32" (15.08 mm)

Order No. 09 - 814

Replaces Gilson 1045, 1046.



Order No. 12 - 5071

1/2" (12.70 mm) x 38" (965.2 mm). Replaces Gilson 14790.

Order No. 12 - 5070

1/2" (12.70 mm) x 37" (939.8 mm). Replaces Gilson 16366.

Order No. 12 - 5074

1/2" (12.70 mm) x 41" (1041.4 mm). Replaces Gilson 17569.



Order No. 13 - 718

Flat Idler. Replaces Gilson 7714.

Order No. 13 - 721

Flat Idler. Replaces Gilson 6588.



Order No. 13 - 729

V Belt Idler. Replaces Gilson 23486.

Order No. 13 - 734

V Belt Idler. Replaces Gilson 24445.

30

O.E.M.

**O.E.M. REPLACEMENT
GILSON (Cont.)**



Order No. 13 - 435

Idle Pulley Assembly. Replaces Gilson 33632.

ORDER NO.	REPLACES O.E.M. NO.	LENGTH	CENTER HOLE DIAM.	OUTSIDE HOLE DIAM.	CENTER TO CENTER	WIDTH	STEEL THICK.	APPLICATION
 15 - 2030	37059	14-19/32" 370.7mm	1-1/8" 28.6mm	25/64" 9.9mm	3-1/4" 82.6mm	2-1/2" 63.5mm	.134" 3.4mm	(3) blades for 42" cut

30

O.E.M.



Order No. 20 - 2235

Vented Fuel Cap. Replaces Gilson.



Order No. 29 - 820

Replaces Gilson 1024 bushing.

ID 3/4"
Width 7/8"
Height 1"



Order No. 29 - 450

Oil Seal. Replaces Gilson 1054. 1" x 1-1/2" x 1/4".

MIN010

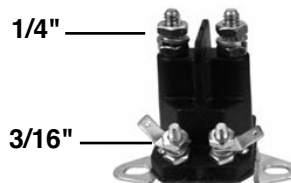

Order No. 31 - 5933

Universal Solenoid. Replaces Gilson 212655

Order No. 31 - 10772

Universal starter solenoid 4 pole, 12 volt. Terminal post will accommodate both 5/16" & 1/4" terminal connectors, Mounting bracket will accommodate both chassis and wall mount configurations. Replaces Gilson 212655.



Order No. 41 - 5512

Scraper Bar replaces Gilson 201879. Fits model Snow Cannon. 20-1/8" length x 1-1/2" width x 1/4" mounting holes.



Order No. 41 - 5504

Replaces Gilson 207527 (4 ea.) and 207141 (2 ea.). Fits models 55190, 55185, 55131, 55203, 55312. (6 piece set)



GRASSHOPPER

Order No. 07 - 10715

Deck wheel replaces Grasshopper 484230. 3-5/16" centered hub.



ID 5/8"
Width 2-3/4"
Height 5"



ID 5/8"
Width 2"

Order No. 07 - 13280

Deck roller replaces Grasshopper 426122. Fits 52", 61" & 72" decks.



ID 5/8"
Width 6-1/8"

Order No. 07 - 13281

Deck roller replaces Grasshopper 603725.



Order No. 08 - 3276

9 x 350 x 4 Caster Wheel Assembly smooth tread, 4 ply tubeless tire. Replaces Grasshopper 483800, 603925, 603927, 603971 on 52" and 60" decks. 5/8" open cage roller bearing, 4" centered, 3 piece rim and zerk fitting. (uses our 09-5812 and 09-7780 bearings) (painted orange).



Order No. 08 - 908

9 x 350 x 4, 4 ply tubeless tire.

Order No. 08 - 3268

9 x 350 x 4 tube with 90° stem.



Solid Foam Tire
FLAT FREE

Order No. 08 - 8577

Caster Wheel Assembly for Grasshopper. 9 x 350 x 4 Smooth tread solid foam tire with 3 piece rim. 3-1/2" centered hub with 5/8" semi-sealed bearing and zerk fitting. Fits 44", 52", 61" & 72" cut, models 2144, 6144, 6152 & 6161. (painted tan). Assembly uses our 08-8264 Solid foam tire.



Order No. 08 - 8553

Caster wheel replaces Grasshopper 483861. 13 x 500 x 6, 4 ply rib tread tubeless tire, 3-3/4" centered hub, 1 piece rim with bead lock, semi sealed ball bearing and zerk fitting. Fits 44", 52", 61" & 72" cut models. Rear wheel on "ZERO TURN" mowers. (painted tan)



Order No. 08 - 8552

Caster wheel replaces Grasshopper 483800, 603925, 603927, 603971, 603924. 9 x 350 x 4, 4 ply smooth tread tubeless tire, 1 piece rim, 3-1/2" centered hub, 5/8" semi-sealed bearing and zerk fitting. Fits 44", 52", 61" & 72" cut. Models 2144, 6144, 6152, 6161. (painted tan)



Order No. 08 - 9500

13 x 650 x 6, 4 ply tubeless rib tread tire. Fits Grasshopper 603975 wheel assembly.

30

O.E.M.

O.E.M. REPLACEMENT



GRASSHOPPER (Cont.)



Order No. 08 - 8896

21 x 11 x 8 tire replaces Grasshopper 482480. 4 ply tubeless Power Trac II tread. Fits Grasshopper "ZERO TURN" mowers.



Order No. 08 - 9189

20 x 10.00 x 8. Turf Master / 4 Ply Tubeless Tire. Replaces Grasshopper 482472.



ID 1" (25.4mm)
OD 2" (52mm)
Height 19/32" (15mm)

Order No. 09 - 10303

Spindle bearing replaces Grasshopper 833210. Sealed one-sided.



ID 1" (25.40 mm)
OD 2" (50.80 mm)
Height 27/32" (21.43 mm)

Order No. 09 - 8488

Bearing replaces Grasshopper 120081. Fits spindle assembly on 30", 42", 50" cut "ZERO TURN". Bearing No. RA100RR.



ID 5/8" (15.88 mm)
OD 1-3/8" (34.93 mm)
Height 1/2" (11.11 mm)

Order No. 09 - 7950

Front wheel bearing replaces Grasshopper 120050. Bearing No. 44F40P.



ID 63/64" (25 mm)
OD 2-3/64" (51.99 mm)
Height 19/32" (15.08 mm)

Order No. 09 - 7162

Spindle Bearing replaces Grasshopper 833210. Bearing No. 6205-RS, Sealed one side.



ID 1" (25.40 mm)
OD 1-1/4" (31.75 mm)
Height 3-1/16" (77.79 mm)
Flange OD 1-1/2" (38.10 mm)

Order No. 09 - 8513

Caster yoke bushing replaces Grasshopper 833260. Fits rider models 612, 616, 2144, 6144, 9044, 9148, 9048, 9052, 9061, 9244, 9252, 9261, 9372, 9272. Oil impregnated.



ID 1" (25.40mm)
Length 5-1/2" (139.70mm)
Overall Height 2-3/4" (69.85mm)

Order No. 09 - 9160

Pillow block bearing replaces Grasshopper 122044. Fits series 700.



Order No. 09 - 7780

Replacement wheel bearing kit for our wheel assembly 08-3276 Comes with (2) 09-481 premium high speed 5/8" bearings, (2) 10-7779 21/32" x 1-1/8" washer and (1) 09-7262 5/8" OD x 4-1/16" bushing.

Overall ID 5/8" (15.88 mm)
Overall OD 1-3/8" (34.93 mm)
Overall Length 3-15/16" (100.01 mm)



Order No. 09 - 5812

Open cage roller bearing with flanged bushings for our Grasshopper Assembly 08-3276.

30

O.E.M.



GRASSHOPPER (Cont.)

Tube Bearing for GRASSHOPPER

ID 3/8" (9.5mm)
OD 5/8" (15.8mm)
Length 3.44" (87.4mm)



Order No. 09 - 14060

Tube bearing replaces Grasshopper 942137.

Spacer Roller for GRASSHOPPER

ID 3/8" (9.5mm)
OD 5/8" (15.8mm)
Length 2.04" (51.8mm)



Order No. 09 - 14059

Spacer roller mount replaces Grasshopper 902284.



Order No. 10 - 13451

Left hand ball joint replaces Grasshopper 265616. Plated steel, female 5/16" - 24 LH.



Order No. 10 - 2209

Ball Joint Assembly. 5/16"-24, replaces Grasshopper 265615. Right hand threads.



Order No. 10 - 9142

Universal adjustable yoke ends. 5/16" - 24 female, for 5/16" pin. Replaces Grasshopper 265537.

Order No. 10 - 9143

Universal adjustable yoke ends. 3/8" - 24 female, for 3/8" pin. Replaces Grasshopper 265545.



Length 1-5/8"
Width 3/4"
Height 1-1/4"

Order No. 10 - 12361

Deck mount bushing replaces Grasshopper 282575.



Order No. 10 - 14495

Electric clutch replaces Grasshopper 606242 & 388767. Warner 5218-58, 5218-26. 1-1/8" ID, 3-1/2" height, 1/2" belt, 4-7/8" pulley.



Order No. 10 - 12114

Electric PTO clutch replaces Grasshopper 606242 / 388769. Warner 5218-214. Replaces Warner 5218-67 & 5217-147. 200 lbs. torque. Shaft size 1-1/8", 4.875" pulley diameter, 2A Belt. Fits most 700 series mowers. Rotation cw-rev, Connector: integral.



Order No. 10 - 9913

Warner Electric PTO clutch replaces Grasshopper 388766/604182. Double Pulley, 1-1/8" ID x 3-3/4" Height, 5" Dia. Pulley, 1/2" belt. Warner No. 5215-62



Order No. 10 - 11237

Electric PTO clutch replaces Grasshopper 388740. Fits models 1600,000 & Higher. Warner 5218-65.

30
O.E.M.

**O.E.M. REPLACEMENT
GRASSHOPPER (Cont.)**



ID 1/2"
OD 4-5/8"
Height 31/32"

Order No. 13 - 7937

Idler pulley replaces Grasshopper 393225. Fits models from 1984 thru 1994, 44", 48" and 52" decks (2 per deck). Composite: glass filled nylon.



ID 1"
OD 5-1/2"
Height 1-29/32"
Keyway 1/4"

Order No. 13 - 8093

PTO pulley replaces Grasshopper 415650. Fits models 718, 720, 721 and 725. Cast Iron.



ID 3/8"
OD 5"
Height 1-1/8"

Order No. 13 - 13417

Idler pulley replaces Grasshopper 393376.



ID 3/8"
OD 2-1/2"
Height 1"

Order No. 13 - 13622

Idler pulley replaces Grasshopper 393312. Fits Grasshopper models 718, 720, 725, 725K and 928D. Composite plastic Idler pulley. Belt groove 1/2".

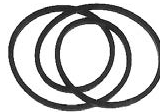

Order No.

Description

12 - 10743

V Belt. Replaces Grasshopper 382035.. 5/8 (15.8 mm) x 65-3/4" (1670 mm). Fits 61" mid mount deck, diesel engine. Wrapped molded polyester cord construction.

12 - 8731

Drive Belt. Replaces Grasshopper 382037. 5/8" (15.88 mm) x 64" (1625.6 mm). Fits 52" decks. Cog V-belt, raw edge. *Aramid fiber.

12 - 8733

Drive Belt. Replaces Grasshopper 381914. 1/2" (12.70 mm) x 36" (914.4 mm). Fits P.T.O. Belt models 720, 721, 721D & 725. "A" section, Cog V-belt, raw edge and Dacron cord construction.

12 - 14363

Deck Belt. Replaces Grasshopper 382093. 5/8" (15.87 mm) x 145.5" (3695.7 mm). Fits 124-52 Mule Drive for 329B & 335B. Wrapped-molded, aramid cord construction, double cover, clutching, Brown.

12 - 12106

Deck Belt. Replaces Grasshopper 382098. 5/8" (15.875 mm) x 158" (4013.2 mm). Fits M172 deck and Mule Drive Belt 321D & 325 models (2005 and earlier). Wrapped, aramid cord construction.

12 - 12095

Deck Belt. Replaces Grasshopper 382080. 5/8" (15.875 mm) x 112-1/2" (2857.5 mm). Fits M148 deck (2003 and earlier). Wrapped, aramid cord construction.

12 - 12096

Deck Belt. Replaces Grasshopper 382082. 5/8" (15.875 mm) x 120-1/2" (3060.7 mm). Fits M152 deck. Wrapped, aramid cord construction.

12 - 12097

Deck Belt. Replaces Grasshopper 382084. 5/8" (15.875 mm) x 135-1/2" (3441.7 mm). Fits 3452 & 9852. Wrapped, aramid cord construction.

12 - 12099

Deck Belt. Replaces Grasshopper 382090. 5/8" (15.875 mm) x 141" (3581.4 mm). Fits 3461 & 9861. Wrapped, aramid cord construction.

O.E.M. 30



GRASSHOPPER (Cont.)

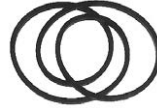

Order No.	Description
12 - 10744	Mule Drive Belt. Replaces Grasshopper 382085.. 5/8" (15.8 mm) x 137-1/2" (3492.5 mm). Fits 61" mid mount deck, diesel engine. Wrapped molded, aramid cord construction, clutching cover.
12 - 10745	Mule Drive Belt. Replaces Grasshopper 382095.. 5/8" (15.8 mm) x 147-1/2" (3746.5 mm). Fits 61" mid mount deck, diesel engine. Wrapped molded, aramid cord construction, clutching cover.
12 - 12098	Mule Drive Belt. Replaces Grasshopper 382086. 5/8" (15.875 mm) x 110-1/2" (2806.7 mm). Fits 428D diesel. Wrapped, aramid cord construction.
12 - 12100	Mule Drive Belt. Replaces Grasshopper 382097. 5/8" (15.875 mm) x 153-1/2" (3898.9 mm). Fits 428 diesel. Wrapped, aramid cord construction.
12 - 12107	Mule Drive Belt. Replaces Grasshopper 382099. 5/8" (15.875 mm) x 163" (4140.2 mm). Fits 428D diesel. Wrapped, aramid cord construction.
12 - 12108	Mule Drive Belt. Replaces Grasshopper 382110. 5/8" (15.875 mm) x 150" (3810 mm). Fits 322D diesel. Wrapped, aramid cord construction.
12 - 12109	Mule Drive Belt. Replaces Grasshopper 382111. 5/8" (15.875 mm) x 151-1/2" (3848.1 mm). Fits 329 models. Wrapped, aramid cord construction.
12 - 12094	Hydro Belt. Replaces Grasshopper 382034. 5/8" (15.875 mm) x 60-1/2" (1536.7 mm). Fits Kohler mid mount mowers. Models 218, 220, 223, 225, 227. Raw edge, aramid cord construction.

*Made with KEVLAR® or non-trade marked Aramid fiber..













30

O.E.M.

O.E.M. REPLACEMENT
GRASSHOPPER (Cont.)









O.E.M. 30

ORDER NO.	REPLACES O.E.M. NO.	LENGTH	CENTER HOLE DIAM.	OUTSIDE HOLE DIAM.	CENTER TO CENTER	WIDTH	STEEL THICK.	APPLICATION
 15 - 3377	320231	15" 381mm	1/2" 12.7mm			2" 50.8mm	.204" 5.2mm	Takes (1) 15-3377 & (2) 15-3379 for 48" cut (3) blades for 44" cut Standard lift
 15 - 6415	320231	15" 381mm	1/2" 12.7mm			2-1/2" 63.5mm	.204" 5.2mm	Mulching Blade PATENTED
 15 - 3378	320232	15" 381mm	1/2" 12.7mm			2" 50.8mm	.204" 5.2mm	Takes (1) 15-3378 & (2) 15-3380 for 48" cut (3) blades for 44" cut High lift
 15 - 6330	320233	15" 381mm	1/2" 12.7mm			2-1/2" 63.5mm	.240" 6.1mm	Takes (1) 15-6330 & (2) 15-6323 for a complete set. Fits 48" deck models 9548, 9548S, 9348, 9348S. Contour blade.
 15 - 11033	320236	18" 457.2mm	1/2" 12.7mm			2-1/2" 63.5mm	.240" 6.1mm	(3) blades for a 52" cut. Standard Lift Blade.
 15 - 3379	320236	18" 457.2mm	1/2" 12.7mm			2" 50.8mm	.204" 5.2mm	Takes (2) 15-3379 & (1) 15-3377 for 48" cut (3) blades for 52" cut Standard lift
 15 - 3380	320237 320239	18" 457.2mm	1/2" 12.7mm			2" 50.8mm	.204" 5.2mm	Takes (2) 15-3380 & (1) 15-3378 for 48" cut. (3) blades for 52" cut High lift
 15 - 6309	320236 320237	18" 457.2mm	1/2" 12.7mm			2-1/2" 63.5mm	.204" 5.2mm	Mulching Blade PATENTED
 15 - 13463	320239	18" 457.2mm	1/2" 12.7mm			2-1/2" 63.5mm	.240" 6.1mm	(3) blades for 52" cut
 15 - 6323	320238	18" 457.2mm	1/2" 12.7mm			2-1/2" 63.5mm	.240" 6.1mm	Takes (2) 15-6323 & (1) 15-6330 for a complete set. Fits 48" deck models 9548, 9548S, 9348, 9348S. Contour blade.
 15 - 10102	320244	21" 533.4mm	1/2" 12.7mm			2-1/2" 63.5mm	.240" 6.1mm	Contour Blade (3) blades for a 61" cut.
 15 - 6167	320242	21" 533.4mm	1/2" 12.7mm			2-1/2" 63.5mm	.240" 6.1mm	(Heavy Duty) (3) blades for 61" cut Standard lift



GRASSHOPPER (Cont.)

ORDER NO.	REPLACES O.E.M. NO.	LENGTH	CENTER HOLE DIAM.	OUTSIDE HOLE DIAM.	CENTER TO CENTER	WIDTH	STEEL THICK.	APPLICATION
 15 - 3424	320243	21" 533.4mm	1/2" 12.7mm			2" 50.8mm	.204" 5.2mm	(3) blades for 61" cut High lift
 15 - 6168	320243	21" 533.4mm	1/2" 12.7mm			2-1/2" 63.5mm	.240" 6.1mm	(Heavy Duty) (3) blades for 61" cut High lift
 15 - 6401	320242	21" 533.4mm	1/2" 12.7mm			2-1/2" 63.5mm	.240" 6.1mm	(3) blades for 61" cut Med lift.
 15 - 13464	320245	21" 533.4mm	1/2" 12.7mm			2-1/2" 63.5mm	.240" 6.1mm	(3) blades for 61" cut
 15 - 6311	320243 320242	21" 533.4mm	1/2" 12.7mm			2-1/2" 63.5mm	.204" 5.2mm	Mulching Blade PATENTED
 15 - 6402	320250	25" 381mm	1/2" 12.7mm			2-1/2" 63.5mm	.240" 6.1mm	(3) blades for 72" cut Low lift.
 15 - 6403	320251	25" 381mm	1/2" 12.7mm			2-1/2" 63.5mm	.240" 6.1mm	(3) blades for 72" cut High lift.

30
O.E.M.

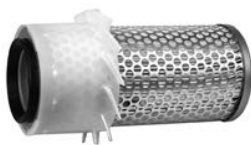

Order No. 19 - 8279
Filter replaces Grasshopper 100940.

ID 1-11/16"
OD 3-9/32"
Height 7-1/4"



Order No. 20 - 9146
Fuel filter replaces Grasshopper 101005. Fits larger horse power models. 10 micron. Fits 5/16" fuel line.



Order No. 20 - 13536
Fuel filter replaces Grasshopper 101000. Fits models G4200, G5200, G6200, B1550, B20, B1500, B1750-B7100; all B series and older G series 29 tractor models.

OD 1-1/8"
ID 1/2"
Length 3-3/8"



Order No. 31 - 14291
Seat switch replaces Grasshopper 183870. Fits models (Grasshopper) 120, 220, 225, 321D; 600, 700 and 900 series. Normally Open.

Order No. 31 - 9210
Voltage regulator replaces Grasshopper 185530. Fits models 1822D, 718D, 721D and 721G. Also fits Kubota 15531-64603.





O.E.M. REPLACEMENT
GRASSHOPPER (Cont.)

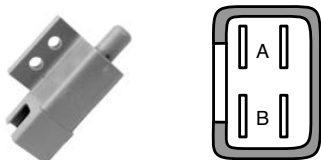

Order No. 31 - 9659

Plunger interlock switch replaces Grasshopper 183894. Double pole, snap in mounting. Normally open/normally closed.

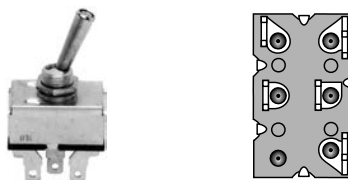

Order No. 31 - 7675

PTO switch. Replaces Grasshopper 604796, 184082. Mounting hardware included.



Order No. 31 - 9622

Multi-application ignition switch. Fits Grasshopper. Includes key, lockwasher nut. 2 terminals/ 2 positions. "Spring Back".

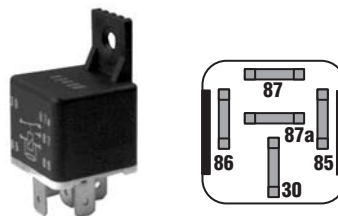

Order No. 31 - 9369

Relay replaces Grasshopper 104-026-401. Fits model 325 (2 required)



Order No. 31 - 8943

Universal Solenoid. Replaces Grasshopper 184251.

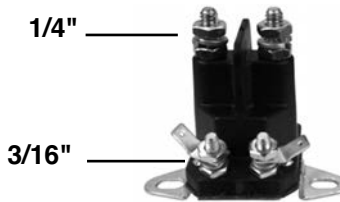

Order No. 31 - 5933

Universal Solenoid. Replaces Grasshopper 184251.

Order No. 31 - 10772

Universal starter solenoid 4 pole, 12 volt. Terminal post will accommodate both 5/16" & 1/4" terminal connectors, Mounting bracket will accommodate both chassis and wall mount configurations. Replaces Grasshopper 184251.

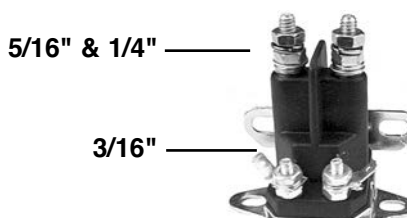

GRAVELY



Order No. 42 - 14177

Pro-Gear T7511 5-Speed transmission replaces Peerless 700-079, Ariens/Gravely 04901000/49010.



Order No. 42 - 14181

Pro-Gear 30-1019 Drive Shaft. Replaces Peerless 776468 & Ariens/Gravely 04923100. 6-1/8" Long, 9-Spline

30

O.E.M.



GRAVELY (Cont.)



Order No. 08 - 8494

Caster Wheel Assembly for Gravelly, 9 x 350 x 4 smooth tread solid foam tire with 3 piece rim. Replaces Gravelly 52586 & 45205. 3-1/4" centered hub with 3/4" open cage roller bearing and zerk fitting. Fits standard Promaster 50" & 60" decks. Assembly uses our **08-8264** Solid foam tire. (painted white)



Order No. 08 - 8197

9 x 350 x 4 castor wheel smooth tread 4 ply tire with tube, 3 piece rim, 3-1/4" centered hub with 3/4" open cage roller bearing and zerk fitting. Replaces Gravelly 45205, fits standard Promaster 50 and 60 decks. (painted white). Uses our 09-8439 bearing kit.



Order No. 08 - 11217

9 x 350 -4 Reliance smooth tread wheel assembly. Mounted on a flat base 4" x 2.25" steel wheel painted white with 3.25" centered hub length and 3/4" roller bearings. Replaces Gravelly 52586 / 45205, Ariens 71301.



Order No. 06 - 5915

6 x 2.00 wheel assembly replaces Gravelly 11386. For 40" and 50" decks. 2-1/2" centered hub, 3/4" bushing and zerk fitting. (painted gray)



Order No. 08 - 11062

13 x 500 -6 Reliance rib tread wheel assembly. Mounted on a 6" x 3.25" steel wheel painted silver with 3.75" centered hub length, without bearings. Replaces Gravelly 52586 / 45205.



Order No. 06 - 5874

6" x 2.00" wheel assembly and zerk fitting. Replaces Gravelly 34426. New Style Gravelly Wheel. For 40" and 50" decks. 1-3/4" offset hub, 3/4" ball bearing. (painted gray). Uses our 09-327 bearing kit.



Order No. 08 - 3277

280 x 250 x 4, 4 ply saw tooth tire and tube mounted on a 3-1/4" centered 3 piece rim, with 1" open cage roller bearing. Replaces Gravelly 37797. (painted red)



Order No. 08 - 8376

9 x 350 x 4 wheel and hub assembly for Gravelly. Used in our **08-8197** and our **08-8464** wheel assemblies. (painted white)

Order No. 09 - 6573

Caster Wheel Bearing. Replaces Gravelly 11193, 37823. Removable back seal.



ID 3/4" (19.05 mm)
OD 1-3/8" (34.93 mm)
Height 1/2" (12.70 mm)

30

O.E.M.



O.E.M. REPLACEMENT GRAVELY (Cont.)



ID 3/4" (19.05 mm)
OD 1-25/32" (45.24 mm)
Height 19/32" (15.08 mm)

Order No. 09 - 484

Spindle Bearing replaces Gravelly 11641. Bearing No. 9504-ZZ.



ID 1" (25.40 mm)
OD 1-3/8" (34.93 mm)
Height 3/4" (19.05 mm)
Flange OD 1-3/4" (44.45 mm)

Order No. 09 - 8522

Yoke bushing replaces Gravelly 18355. Yoke bushing on models Promaster, Pro 40, Pro 50, Pro 200, Pro 100. Nylon.

MIN010



ID 3/4" (19.05 mm)
OD 1-1/8" (28.58 mm)
Length 1" (25.4 mm)

Order No. 09 - 8971

Roller cage bearing replaces Gravelly 54228. Used on Gravelly 71352 wheel assembly.



ID 3/4" (19.05mm)
OD 1-1/2" (38.10mm)
Height 3/8" (9.53mm)

Order No. 09 - 9563

Bearing end cap replaces Gravelly 92027. Fits Gravelly Promaster 200 commercial walkbehind mower. Uses 2 per wheel. Used with our **09-8971** bearing.

30

O.E.M.

Order No. 09 - 8485

Wheel bushing replaces Gravelly 11387. Fits 40" commercial center mount mower models. Used on our **06-5915** wheel assembly. ID 1/2" (12.70 mm), OD 3/4" (19.05 mm), Length 2-5/8" (66.68 mm).



Order No. 09 - 8439

Wheel bearing kit for Gravelly. Fits Gravelly 45205 front caster wheel assembly. Fits 40" & 50" cut mowers. Kit contains our **09-8404** roller cage bearing with retainer bushings and **09-8420** spanner bushing. Fits our **08-8197** wheel assembly.

Overall ID 1/2" (12.70 mm)
Overall OD 1-3/8" (34.93 mm)
Overall Length 3-21/64" (84.53 mm)

Order No. 09 - 8404

Roller cage bearing with retainer bushings only for Gravelly 45205 front caster wheel assembly. Roller cage bearing OD 1-1/4" (31.75 mm), ID 3/4" (19.05 mm), Length 2-1/2" (63.50 mm). Retainer bushings OD 1-3/8" (34.93 mm), ID 3/4" (19.05 mm), Height 3/8" (9.53 mm).



Order No. 09 - 9000

Roller cage bearing only for Gravelly. Used on our Gravelly wheel assembly **08-8197**. OD 1-1/4" (31.75 mm), ID 3/4" (19.05 mm), Length 2-1/2" (63.50 mm).

Order No. 09 - 8999

Retainer bushing only for Exmark. Used on Exmark 3322154 wheel assembly & our **08-8197** wheel assembly for Gravelly. OD 1-1/2" (38.10 mm), ID 3/4" (19.05 mm).

Order No. 09 - 8420

Spanner bushing only. Replaces Gravelly 11950. OD 3/4" (19.05 mm), ID 1/2" (12.70 mm), Length 3-11/32" (84.93 mm).

Order No. 10 - 9307

Rod end replaces Gravelly 44941. Female 1/2" - 20 rod end assembly. Right hand thread. Fits Gravelly 18G & 20G. Also replaces John Deere AM103052.





GRAVELY (Cont.)



Order No. 10 - 11071

Electric PTO clutch replaces Ariens/Gravely 9225400, Country Clipper E-6247, Dixon 61516, 539128711, Toro 94-6136. 5.345" Dia. Pulley. 5/8" Belt, shaft size 1-1/8". Warner 5218-10.



Order No. 10 - 14009

Electric PTO clutch replaces Ariens 09232700, Gravely 00389900, 09232700, Great Dane GDA10122, Wood Mizer P604, Warner 5218-94. 1-1/8" ID, 6" OD, for 5/8" belt.

Spindle Assembly for GRAVELY



Order No. 10 - 14230

Spindle assembly replaces Gravely 59202600. Fits models GR, HR, PM & ZT series. Center spindle. Includes mounting hardware.

Spindle Assembly for GRAVELY



Order No. 10 - 14252

Spindle assembly replaces Gravely 59201000. Fits models GR, HR, PM series. Outer, left & right spindle. Includes mounting hardware.

Order No. 13 - 5714

Flat Idler with Flange. Replaces Gravely 21060. ID 3/8", OD 4-5/8", Height 11/16"

Order No. 13 - 2189

Flat Idler with Flange. Replaces Gravely 34286. ID 3/8", Height 2-1/4".



ID 3/8"
OD 4-3/4"
Height 2"

Order No. 13 - 12411

Idler pulley replaces Gravely 073278.



ID 1/2"
OD 6-3/4"
Height 3/4"

Order No. 13 - 7176

Deck Idler replaces Gravely 22063. Fits Pro Master 60" cut mowers.



Inlet ID 1-5/16"
Outlet ID 1-1/4"

Order No. 18 - 2286

Muffler replaces Gravely 18543.

30

O.E.M.

O.E.M. REPLACEMENT



GRAVELY (Cont.)



Order No. 19 - 9464

Transmission filter replaces Gravely 09246900, 100850. Hydrostatic transmission filter has 3/4" - 16 thread, 40 micron, 3-7/8" Height, 3" OD.



Order No. 19 - 12374

Oil filter replaces Hydro Gear HG52114. Fits (Transmission Model ZT2800). Replaces Gravely 21545100

30

Order No. 19 - 1388

Filter replaces Gravely 34776/43644.



Order No. 19 - 2844

Prefilter replaces Gravely 34768/46346.

O.E.M.



Order No.

Description

12 - 7837

Cutter Deck Belt. Replaces Gravely 722660 & 51213, 11216. "A" Section Belt. 26.75" length (3219.45 mm). Cogged, for 50" deck.

12 - 8760

PTO Belt. Replaces Gravely 72250. 1/2" (12.70 mm) x 37.6" (955.04 mm). Fits Pro Master 100, 200 & Pro 200, 300. Also fits 36", 38", 40" & 50" cut models. V-belt, raw edge, *Aramid fiber.

12 - 8717

Drive Belt. Replaces Gravely 72224 & 49029. 1/2" (12.70 mm) x 46.6" (1183.64 mm). Fits 2 per wheel on all Pro series walk behind. "A" section, *Aramid fiber.

12 - 8711

Wheel Drive Belt. Replaces Gravely 7225800. 1/2" (12.70 mm) x 52.8" (1341.44 mm). For Pro 150 series.

*Made with KEVLAR® or non-trade marked Aramid fiber.



GRAVELY (Cont.)







ORDER NO.	REPLACES O.E.M. NO.	LENGTH	CENTER HOLE DIAM.	OUTSIDE HOLE DIAM.	CENTER TO CENTER	WIDTH	STEEL THICK.	APPLICATION
 15 - 1065	34984 14668	13-7/8" 352.4mm	5/8" 15.9mm			2" 50.8mm	.204" 5.2mm	(3) blades for 40" cut
 15 - 1066	8861651 88616 111234	17" 431.8mm	5/8" 15.9mm			2" 50.8mm	.204" 5.2mm	(3) blades for 50" cut
 15 - 6214	21285051 212850	17" 431.8mm	5/8" 15.9mm			2-1/2" 63.5mm	.240" 6.1mm	(3) blades for 50" cut "ZERO TURN"
 15 - 6181	8779251 87792 046998	17" 433.4mm	5/8" 15.9mm			2-1/2" 63.5mm	.240" 6.1mm	(3) blades for 50" cut "ZERO TURN" High lift
 15 - 6204	8866851 52928	17" 431.8mm	5/8" 15.9mm			2-1/2" 63.5mm	.240" 6.1mm	(3) blades for 50" cut Fits Pro 50 & Pro Master 50 Mulching Blade
 15 - 6298	046998	17" 433.4mm	5/8" 15.9mm			2-1/2" 63.5mm	.204" 5.2mm	Mulching Blade PATENTED
 15 - 6013	046998	17" 431.8mm	5/8" 15.8mm			2" 50.8mm	.240" 6.1mm	Low-Lift Blade Sharpened - 4-sides
 15 - 3381	88166 42124	17-11/16" 449.3mm	5/8" 15.9mm			2" 50.8mm	.240" 6.1mm	(2) blades for 36" cut High Lift
 15 - 6203	8866751 52927	17-11/16" 449.3mm	5/8" 15.9mm			2-1/2" 63.5mm	.240" 6.1mm	(2) blades for 36" cut Fits Pro 36 mower Mulching Blade
 15 - 2164	20034751 200347 9212P2	20-1/2" 520.7mm	1" 25.4mm			2-1/4" 57.2mm	.250" 6.4mm	(2) blades for 40" Commercial deck
 15 - 3339	8904651 89046 25124	20-1/2" 520.7mm	5/8" 15.9mm			2" 50.8mm	.240" 6.1mm	(2) blades for 40" cut (3) blades for 60" cut
 15 - 13624	 09081200	20-1/2" 520.7mm	5/8" 15.8mm			2-1/2" 63.5mm	.240" 6.1mm	(3) blades for 60" cut

30
O.E.M.

O.E.M. REPLACEMENT
GRAVELY (Cont.)



30
O.E.M.

ORDER NO.	REPLACES O.E.M. NO.	LENGTH	CENTER HOLE DIAM.	OUTSIDE HOLE DIAM.	CENTER TO CENTER	WIDTH	STEEL THICK.	APPLICATION
 15 - 6180	8979651 89796 046999	20-1/2" 520.7mm	5/8" 15.9mm			2-1/2" 63.5mm	.240" 6.1mm	(3) blades for 60" cut
 15 - 6285	8781851 48864	20-1/2" 520.7mm	5/8" 15.9mm			2-1/2" 63.5mm	.240" 6.1mm	(3) blades for 60" cut Fits 60" mower with fabricated deck. Mulching blade
 15 - 6213	52929	20-1/2" 520.7mm	5/8" 15.9mm			2-1/2" 63.5mm	.240" 6.1mm	(3) blades for 60" cut Fits Pro Master 300 & Pro 40, Mulching Blade
 15 - 10175	46999	20-1/2" 520.7mm	5/8" 15.8mm			2-1/2" 63.5mm	.204" 5.2mm	Flat Blade Sharpened - 4-sides
 15 - 6303	46999	20-1/2" 520.7mm	5/8" 15.9mm			2-1/2" 63.5	.204" 5.2mm	Mulching Blade PATENTED
 15 - 6194	46999	20-1/2" 520.7mm	5/8" 15.8mm			2" 50.8mm	.240" 6.1mm	Low-Lift Blade Sharpened - 4-sides
 15 - 6171	8983851 89838 047685	24-1/2" 622.3mm	5/8" 15.9mm			2-1/2" 63.5mm	.240" 6.1mm	(3) blades for 72" cut



GRAVELY (Cont.)



Order No. 20 - 2235

Vented Fuel Cap. Replaces Gravelly.



Order No. 21 - 13998

Arm rest replaces Hustler 797480, Ariens/Gravelly 01552900/715095 kit, Exmark/Toro 107-1887, 110-6569, 108-6163 & 69-1180.



Order No. 31 - 8943

Universal Solenoid. Replaces Gravelly 45071.



Order No. 31 - 5933

Universal Solenoid. Replaces Gravelly 45071.

Order No. 31 - 10772

Universal starter solenoid 4 pole, 12 volt. Terminal post will accommodate both 5/16" & 1/4" terminal connectors, Mounting bracket will accommodate both chassis and wall mount configurations. Replaces Gravelly 45071.

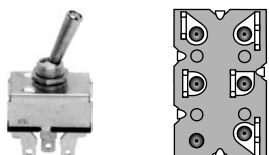

Order No. 31 - 7675

PTO switch replaces Gravelly 45848. Mounting hardware included.



Order No. 31 - 8910

Safety switch replaces Gravelly 34640. 9/16" mounting stem, normally closed, neutral safety.

Order No. 31 - 8601

Key switch replaces Gravelly 19223. Fits Gravelly Promaster 20H. For battery ignition, 9/16" mounting stems.



30
O.E.M.



O.E.M. REPLACEMENT

GREAT DANE



ID 2-1/4"
OD 6"
Width 1-1/2"
Bolt Center 2-5/8"

Order No. 05 - 9757

Brake drum replaces Great Dane D48003. Included in our 13-9758 assembly.



Order No. 10 - 11858

Electric PTO clutch replaces Great Dane D18000. 1" ID x 6" pulley, A/B Belt type. Warner 5215-14.



Order No. 10 - 12658

Electric PTO clutch replaces Great Dane GDA10017 & D38155. Warner 5219-4. Fits Chariot models. Shaft size 1", 6" pulley diameter, 5/8" Belt.



Order No. 10 - 14009

Electric PTO clutch replaces Ariens 09232700, Gravely 00389900, 09232700, Great Dane GDA10122, Wood Mizer P604, Warner 5218-94. 1-1/8" ID, 6" OD, for 5/8" belt.



Order No. 10 - 12778

Spindle assembly replaces Great Dane 200262, D18030. Fits latest models. New heavy duty style with mounting studs. Shaft length 6".



Order No. 10 - 12383

Spindle shaft replaces Great Dane D18048 old style. Fits our 10-9754 spindle which has been discontinued.

30
O.E.M.

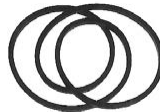

Order No.

Description

12 - 10623

Blade Drive Belt. Replaces Great Dane D18087. 5/8" (15.8 mm) x 77-1/2" (1968.5 mm). Fits 48" Surfer. Raw edge, laminated, aramid cord construction.

12 - 10624

Blade Drive Belt. Replaces Great Dane D18005. 5/8" (15.8 mm) x 82-1/4" (2089.2 mm). Fits 52" Surfer. Raw edge, laminated, aramid cord construction.

12 - 10625

Blade Drive Belt. Replaces Great Dane D18007. 5/8" (15.8 mm) x 88-3/4" (2254.3 mm). Fits 61" Surfer. Raw edge, laminated, aramid cord construction.

12 - 10627

Blade Drive Belt. Replaces Great Dane D28029. 5/8" (15.8 mm) x 108-1/4" (2749.6 mm). Fits Chariot. Raw edge, laminated, aramid cord construction.

12 - 10626

Blade to Blade Belt. Replaces Great Dane D28028. 5/8" (15.8 mm) x 134-5/16" (3411.5 mm). Fits 61" Chariot. Wrap molded, general purpose, aramid cord construction.

12 - 10629

Blade to Blade Belt. Replaces Great Dane D28031. 5/8" (15.8 mm) x 120.3" (3055.6 mm). Fits 52" Chariot. Wrap molded, general purpose, aramid cord construction. Double "V" or Hex or BB Belt.



GREAT DANE (Cont.)

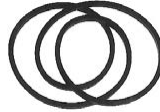

Order No.	Description
12 - 10893	Engine Pump Belt. Replaces Great Dane D18303. 1/2" (12.7 mm) x 68-1/2" (1739.9mm). Fits Super Surfer. Raw edge, aramid cord construction.
12 - 10894	Engine Blade Belt. Replaces Great Dane D118348. 5/8" (15.8 mm) x 108" (2743 mm). Fits 48" Super Surfer. Raw edge, aramid cord construction.
12 - 10628	Hydro Pump Drive Belt. Replaces Great Dane D28030. 1/2" (12.7 mm) x 76" (1930.4mm). Fits Chariot. Raw edge, laminated, aramid cord construction.

*Made with KEVLAR® or non-trade marked Aramid fiber.

30

 <p data-bbox="711 787 849 877">ID 3/8" OD 5-3/4" Height 3/4"</p> <p data-bbox="180 1050 500 1079">Order No. 13 - 9755</p> <p data-bbox="180 1087 846 1142">Idler pulley replaces Great Dane D18048, D18044. Idler pulley with welded 12 point hub used with our 10-9754 spindle.</p>	 <p data-bbox="1360 787 1542 877">ID 7/8" splined OD 5-3/4" Height 3/4"</p> <p data-bbox="870 1079 1190 1108">Order No. 13 - 9756</p> <p data-bbox="870 1117 1317 1146">Idler pulley replaces Great Dane D18314.</p>
 <p data-bbox="711 1197 849 1287">ID 3/8" OD 5" Height 3/4"</p> <p data-bbox="180 1423 521 1453">Order No. 13 - 10160</p> <p data-bbox="180 1461 846 1516">Idler pulley replaces Great Dane D18031. Fits Surfer, Chariot & Scamper models.</p>	 <p data-bbox="1382 1207 1542 1297">ID 3/8" OD 4" Height 1-3/8"</p> <p data-bbox="870 1444 1203 1474">Order No. 13 - 10161</p> <p data-bbox="870 1482 1446 1512">Drive pulley replaces Great Dane D18083. Short hub.</p>
 <p data-bbox="686 1575 849 1665">ID 3/8" OD 5-7/8" Height 3-1/8"</p> <p data-bbox="180 1913 521 1942">Order No. 13 - 10168</p> <p data-bbox="180 1950 846 2005">Blade drive idler pulley replaces Great Dane D28105. Fits Chariot models.</p>	 <p data-bbox="1360 1585 1542 1675">ID 7/8" splined OD 5-3/4" Height 1-1/8"</p> <p data-bbox="870 1934 1206 1963">Order No. 13 - 10079</p> <p data-bbox="870 1971 1466 2001">Spindle pulley replaces Great Dane D18084. Long hub.</p>

O.E.M.

O.E.M. REPLACEMENT
GREAT DANE (Cont.)



ID 3/8"
OD 5-7/8"
Height 1-25/32"

Order No. 13 - 13127

Idler pulley replaces Great Dane D18032.

30
O.E.M.

ORDER NO.	REPLACES O.E.M. NO.	LENGTH	CENTER HOLE DIAM.	OUTSIDE HOLE DIAM.	CENTER TO CENTER	WIDTH	STEEL THICK.	APPLICATION
15 - 3403	D18086	16-1/2" 419.1mm	5/8" 15.8mm				.204" 5.2mm	(3) blades for 48" cut
15 - 3404	D18037	18" 457.2mm	5/8" 15.8mm				.204" 5.2mm	(3) blades for 52" cut
15 - 10173	D18037	18" 457.2mm	5/8" 15.8mm			2-1/2" 63.5mm	.204" 5.2mm	Flat Blade Sharpened - 4-sides
15 - 9968	D18037	18" 457.2mm	5/8" 15.8mm			2" 50.8mm	.240" 6.1mm	Low-Lift Blade Sharpened - 4-sides
15 - 3434	C-39949	21" 533.4mm	5/8" 15.8mm				.204" 5.2mm	(3) blades for 61" cut
15 - 10174	C-39949	21" 533.4mm	5/8" 15.8mm			2-1/2" 63.5mm	.204" 5.2mm	Flat Blade Sharpened - 4-sides
15 - 9969	C-39949	21" 533.4mm	5/8" 15.8mm			2" 50.8mm	.240" 6.1mm	Low-Lift Blade Sharpened - 4-sides



Diameter 3-1/2"

Order No. 20 - 9650

Vented fuel cap replaces Great Dane D18097.



Order No. 31 - 9622

Multi-application ignition switch. Fits Great Dane. Includes key, lockwasher nut. 2 terminals/ 2 positions.

Order No. 31 - 9663

Plunger interlock switch replaces Great Dane D38001. Single post, right angle snap mounted. Normally open.





HONDA

Conduit 48-3/4"
Inner Wire 52"
Wire Travel 3"



Order No. 03 - 8832

Throttle control replaces Honda 17910-VA4-800, code 1663483. Fits 21" mower.



Order No. 05 - 8568

Transmission cable replaces Honda 54510-VB5-800. Fits Honda 21" walk behind mowers, models HRA216 from 1988 to 1991, HRC216 from 1992 to present with a 2 speed transmission. Conduit length 44-3/4", wire length 49-7/8".

Conduit 58"
Inner Wire 58"
Wire Travel 3-3/8"



Order No. 03 - 10118

Throttle cable replaces Honda 17910-VA3-003. Fits models HR194, HR215 & HR216.

Conduit 54"
Inner Wire 65"
Wire Travel 11"

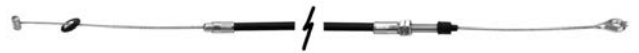

Order No. 03 - 10122

Blade stop cable replaces Honda 54530-VA3-J03. Fits models HR215SXA, HXA, K1SXA, K1HXA, HRC215, K1SDKA, HRC216HXA, SXA, K1HXA and K1SXA

Conduit 45"
Inner Wire 54-3/4"
Wire Travel 9-1/4"

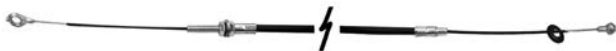

Order No. 03 - 10123

Blade stop cable replaces Honda 54530-VE0-003. Fits models HRB215XA, HRB215K15XR, HRB215K2HXA.

Conduit 53"
Inner Wire 68-1/2"
Wire Travel 15-1/2"



Order No. 03 - 10124

Blade stop cable replaces Honda 54530-VB3-802. Fits models HR214SXA, HRA214SXA.

Conduit 42-1/8"
Inner Wire 44-3/4"
Wire Travel 1-1/2"

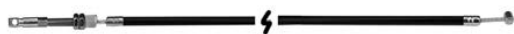

Order No. 03 - 10119

Transmission cable replaces Honda 54520-VA3-801. Fits model HR214 walkbehind mower.

Conduit 42-1/2"
Inner Wire 47-1/2"
Wire Travel 5"



Order No. 03 - 10120

Transmission cable replaces Honda 54520-VA3-P03. Fits models HR1215HXA & HR215K1HXA .

Conduit 42-3/4"
Inner Wire 47-5/8"
Wire Travel 4-7/8"



Order No. 03 - 10121

Transmission cable replaces Honda 54520-VB5-P00. Fits models HRC216R1HXA & HR216HXA walkbehind mowers.



Order No. 03 - 10855

Conduit clip replaces Honda 16516-891-000. Fits GX 110, 120, 140, 160.

30

O.E.M.



O.E.M. REPLACEMENT
HONDA



Order No. 05 - 10862

Blade brake clutch plate replaces Honda 75150-VA3-J01. Fits Honda walkbehind mowers.



ID 1.409"
OD 1.978"

Order No. 05 - 12477

Wheel ratchet holder replaces Honda 23511-VB3-801. Fits models HRC215, HRC216, SXA & HXA. For Honda 21" cut decks, commercial units. Code 2756716.



Order No. 05 - 13371

Ratchet holder **right** replaces Honda 23510-VB5-803. Used with our **05-12477** wheel ratchet holder. Fits mower models HRC215, HRC216, SXA and HXA, 21" cut decks commercial units.



Order No. 05 - 13372

Ratchet holder **left** replaces Honda 23520-VB5-803. Used with our **05-12477** wheel ratchet holder. Fits mower models HRC215, HRC216, SXA and HXA, 21" cut decks commercial units.

Order No. 05 - 12126

Drive joint assembly replaces Honda 22100-VB5-804. Fits models HRA216SXA, 215SXA & HRC216HXA.



Order No. 07 - 13399

Rear wheel assembly replaces Honda 42700-VK6-020ZA / 42700-VK6-010ZA. Fits model HRC216.



Order No. 07 - 13398

Front wheel assembly replaces Honda 44700-VK6-010ZA. Fits model HRC216.



Order No. 08 - 13400

Tire skin 9" **new style** replaces Honda 42751-VK6-010. Front and rear tire only fits models HRC216K2. Fits our Wheel Assembly **07-13399** and **07-13398**.



Order No. 08 - 13401

Tire skin 9" **old style** replaces Honda 42861-VB5-J00. Front and rear tire only fits models HRC216.



ID 37/64" (15 mm)
OD 1-1/4" (31.75 mm)
Height 23/64" (9.13 mm)

Order No. 09 - 8525

Wheel bearing replaces Honda 96150-60020-10, code 0876904. Fits 21" commercial mowers. Sealed 2 sides. Bearing No. 6002-2RS.



Order No. 10 - 12749

Handle knob replaces Honda 53125-VA4-K10, code 3338076. 8mm 5-star. Fits walkbehind mowers.

30

O.E.M.



HONDA (Cont.)



Order No. 08 - 10795

350 x 400 x 7, straight stem tube. Fits Honda tillers.



Coil Length 1-1/4"
Overall Length 7"

Order No. 10 - 8504

Transmission Clutch Lever spring for BBC handle replaces Honda 54411-VB3-800, code 2456069. Fits S/P walkbehind 21" mowers. Models HRA 216 (88-91) & HRC216 (92-present).



ID 3/4"
OD 1-1/4"
Thickness 3/32"

Order No. 10 - 8412









Wheel washer replaces fits Honda HRC 7013, 36" & 48" mid-size. Also replaces Honda 4034054, 4034062, 4034112, 4033106. MIN010



Size M10 x 1.25

Order No. 17 - 8640











Blade bolt replaces Honda 90105-960-710, code 1663665. Fits 21" mower models HR214, HRA214, HR215, HRA215, HR216, HRA216, HRC215, HRC216, HRM215, HRB215 & HRS21. Hex flange bolt.

ORDER NO.	REPLACES O.E.M. NO.	LENGTH	CENTER HOLE DIAM.	OUTSIDE HOLE DIAM.	CENTER TO CENTER	WIDTH	STEEL THICK.	APPLICATION
 15 - 6131	72513-758-N00 code #3389285	14-9/16" 369.9mm	.630" 16mm			2-3/4" 69.9mm	.187" 4.8mm	(3) blades for 42" cut Fits model 4213
 15 - 50102	72511 VA9-010	16-1/2" 419.10mm	1.09" 27.78mm	.24" x .33"	1.96" 28.18mm	2.25" 57.15mm	.095" 2.77mm	
 15 - 50098	72511 VA5-700	18-3/16" 461.96mm	.831" 21.43mm	.416" 10.71mm	3.45" 87.71mm	2.25" 57.15mm	.150" 3.97mm	
 15 - 50101	72511 VA5-840	18-7/16" 468.31mm	.836" 21.43mm	.564" 14.68mm	3.469" 88.20mm	3.375" 85.73mm	.150" 3.97mm	
 15 - 50113	425-1196004	18-5/8" 473.06mm	.831" 21.43mm	.416" 10.71mm	3.45" 87.71mm	2.25" 57.15mm	.150" 3.97mm	
 15 - 6787	72511-VA5-J00 code # 3451820	18-7/16" 468.3mm	.831" 21.4mm	.416" 10.7mm	3-7/16" 87.7mm	2-1/4" 57.2mm	.150" 3.8mm	Fits 19" walkbehind. Models HR-194 & HR-195.
 15 - 3437	72513-750-305 code #2685113	19-7/16" 493.7mm	.825" 21mm	.413" 10.5mm	3-15/32" 88.1mm	2-1/4" 57.2mm	.150" 3.8mm	High lift (narrow) Left side fit models 3810 K1 and 3813 SA
 15 - 3438	72512-750-305 code #2685105	19-7/16" 493.7mm	.825" 21mm	.413" 10.5mm	3-15/32" 88.1mm	2-3/4" 69.9mm	.160" 4.1mm	High lift (wide) Right side fit models 3810 K1 and 3813 SA

O.E.M. REPLACEMENT
HONDA (Cont.)



O.E.M. 30

ORDER NO.	REPLACES O.E.M. NO.	LENGTH	CENTER HOLE DIAM.	OUTSIDE HOLE DIAM.	CENTER TO CENTER	WIDTH	STEEL THICK.	APPLICATION
 15 - 6150	72531-758-L00	19-1/2" 495.3mm	.630" 16mm			2-3/4" 69.9mm	.187" 4.8mm	Fits 38" deck models 4514, 4518, 3013 & 4013 takes (1) 15-6150 & (1) 15-6151 Left hand blade
 15 - 6151	72511-758-L00 72511-771-L00	19-1/2" 495.3mm	.630" 16mm			2-3/4" 69.9mm	.187" 4.8mm	Fit models 4514, 4518, 3013 & 4013. Takes (1) 15-6151 & (1) 15-6150 Right hand blade
 15 - 6428	72511-V63-000 72511-VE1-020 code 4513511	20-5/16" 532mm	.804" 20mm	13/32" 10.3mm	3-15/32" 88.1mm	2-1/4" 57.2mm	.134" 3.4mm	Fits 21" walkbehind. Models HRB215, HRM215 High Lift. Lower Blade.
 15 - 50106	72511VB3-B51	20-5/8" 523.88mm	.831" 21.43mm	.416" 10.71mm	3.45" 87.71mm	2.25" 57.2mm	.150" 3.97mm	(Export Only)
 15 - 50160	72511-VB3-E41	20.674" 525.04mm	.844" 21.43mm	.563" 14.28mm	3.469" 88.10mm	2.25" 57.15mm	.160" 4.00mm	
 15 - 10180		20-7/8" 530.2mm	27/32" 21.4mm	.415" 10.5mm	3-7/16" 87.3mm	2-1/4" 57.2mm	.150" 3.8mm	De-Thatcher Plus Fits 21" Honda Uses our 27-94222 line.
 15 - 6458	08750-960-333	20-7/8" 530.2mm	.845" 21.5mm	.415" 10.5mm	3-7/16" 87.3mm	2-1/4" 57.2mm	.160" 4.1mm	Off set blade. Fits 21" cut models.
 15 - 6431	72511-VE2-000 code 4010609	20-7/8" 530.2mm	.830" 27.3mm	13/32" 10.3mm	3-15/32" 88.1mm	2-1/4" 57.2mm	.095" 2.4mm	Lower blade. Use with our 15-6430 upper blade. Fits 21" walkbehind.
 15 - 6092	72511-VA4-641 code #3504230	20-7/8" 530.2mm	.845" 21.5mm	.415" 10.5mm	3-7/16" 87.3mm	2-1/4" 57.2mm	.150" 3.8mm	Fits all Honda 21" cut from 1981-1991, 21" Mulcher
 15 - 2160	72511-VA2-690 72511-960-004 code #2801595	20-7/8" 530.2mm	.845" 21.5mm	.415" 10.5mm	3-7/16" 87.3mm	2-1/4" 57.2mm	.150" 3.8mm	Fits HR 214, HRA 214 and HRA 216
 15 - 50153	72511-VE1-652	20-29/32" 531mm	.780" 19.8mm	.535" 13.6mm	3.60" 91.67mm	4.125" 12.7mm	.095" 2.4mm	Fits 1988-1994 Models HRB535, 536, HRD535, 536, HRG536C, HRH536



HONDA (Cont.)

ORDER NO.	REPLACES O.E.M. NO.	LENGTH	CENTER HOLE DIAM.	OUTSIDE HOLE DIAM.	CENTER TO CENTER	WIDTH	STEEL THICK.	APPLICATION
 15 - 14657	 72531-VK6-010	21" 533.4mm	1-3/4" 44.5mm	19/32" 15mm		2-5/8" 66.6mm	.134" 3.4mm	Fits 21" model HRC216K2 PDA upper blade. Used with our 15-12615 lower blade.
 15 - 6430	72531-VE2-020 code 4513529	21" 533.4mm	1-17/64" 32.1mm	13/32" 10.3mm	3-15/32" 88.1mm	2-5/8" 66.7mm	.095" 2.4mm	Upper blade 15-6428 Lower blade 15-6431 Fits 21" walkbehind.
 15 - 12615	72511-VK6-000	21-1/4" 539.75mm	.804" 20mm	.415" 10.5mm	3.373" 88mm	4-1/4" 108mm	.117" 3.0mm	Fits 21" Honda mower model HRC216K2. lower blade.
 15 - 6153	72511-763-A00 72511-772-L00	29-9/16" 750.9mm	.630" 16mm	.480" 12.2mm	4-5/16" 109.5mm	2-3/4" 69.9mm	.187" 4.8mm	Fits 30" rider model H3011 & HTR3009-K1. High lift
 15 - 2165	72513-751-020 code #2160372	29-3/4" 755.7mm	1.02" 25.9mm	.480" 12.2mm	4-5/16" 109.5mm	2-3/4" 69.9mm	.160" 4.1mm	Fits mid engine rider model HTR 3009.

30
O.E.M.



Order No. 18 - 10271

Muffler replaces Honda 18310-ZE2-W013. Fits GX240 & GX270 with 2 piece muffler shield. Shield not included.



Order No. 18 - 10272

Muffler replaces Honda 18310-ZE2-W00. Fits GX240 & GX270 with 1 piece muffler shield. Shield not included.



Order No. 18 - 9577

Muffler replaces Honda 18310-ZF1-000. Fits 5.5 hp engines. Model GX160. Heat shield included.



Length 6-3/4"
Width 2-1/4"
Height 2"

Order No. 18 - 9578

Muffler replaces Honda 18310-ZE3-003. Fits 8 hp engines. Model GX340. Also Fits 11-13 hp. Shield not included

Muffler Pipe for HONDA



Order No. 18 - 14594

Muffler pipe replaces Honda 18330-ZH9-N00, 18330-ZE2-W00, code 3682036. Fits GX240, GX340, GX390 series engines. Included with our **18-14449** Muffler.

Muffler for HONDA



Order No. 18 - 14449

Muffler pipe replaces Honda 18310-ZE2-W61. Fits GX340, GX390, muffler (100 db) for 11 & 13 hp engines with heat shield.

O.E.M. REPLACEMENT



HONDA (Cont.)

Muffler for HONDA



Order No. 18 - 14450

Muffler replaces Honda 18310-ZMO-000. Fits GCV135 AND GVC160 series engines, shield not included. Fits models GSV190 (A1G7, A2G7, N1G7, N2G7). Also fits models GX100VEA, GX100UBE14.

Muffler Protector for HONDA



Order No. 18 - 14451

Muffler protector replaces Honda 18320-ZE2-W62, 18320-ZE2-W61. Fits engines GX340 & 390 KBN#35-11 & Honda 18320-ZE3-W01.



Length 6-1/2"
Width 4-1/2"
Height 1-3/8"

Order No. 19 - 12801

Air filter replaces Honda 17211-899-000. Fits engine models, GX240, GX270, GX340, GX390. Generator models EB3000, 4000, 5000, 6500, EM3000, 3800, 4000, 5000, 6000, 6500, EMS4000, EMS4500, EW140, EW17.



Length 3"
Width 3-1/2"
Height 1/2"

Order No. 19 - 8905

Filter replaces Honda 17211-896-000. Fits model G100, 2 & 2.5 hp engines. Used on Honda pumps.



Length 9"
Width 6-1/2"
Height 1-1/4"

Order No. 19 - 10678

Air filter replaces Honda 17210-ZJ1-841. Fits models 610K1, 620K1, 670, GXV610K1, GXV620K1.



Length 8-1/2"
Width 6-1/2"

Order No. 19 - 10961

Pre filter replaces Honda 17218-ZJ1-840. Fits models 610K1, 620K2, 670, GXV610K1, GXV620K1. Prefilter for our 19-10678 air filter.



Length 8-5/8"
Width 4-3/4"
Height 7/8"

Order No. 19 - 10879

Air filter replaces Honda 17211-Z0A-013. Fits models GCV530 & GXV530, 16 hp V-twin vertical shaft units.



Length 8-3/8"
Width 4-3/8"
Height 3/8"

Order No. 19 - 12243

Prefilter replaces Honda 17218-Z0A-810. Prefilter for our 19-10879 air filter.



Length 5-1/4"
Width 2-1/4"
Height 1"

Order No. 19 - 8903

Filter & prefilter replaces Honda 17211-ZG9-800, code 4327383. Fits models GVX 140 engine, 5 hp vertical shaft.



Order No. 19 - 8906

Filter & prefilter replaces Honda 17211-ZE7-W03, code 5357389. Fits 5.5 hp vertical shaft.

Order No. 19 - 8904

Prefilter replaces Honda 17218-ZG9-800, code 4327391.

Order No. 19 - 8907

Prefilter.

30

O.E.M.



HONDA (Cont.)



Length 9-1/2"
Width 8"
Height 1-1/4"

Order No. 19 - 10679

Air filter replaces Honda 17010-ZJ1-000. Fits models GX610, 620, GXV610, GXV620.



Length 4-7/8"
Width 2-9/16"
Height 3-7/16"

Order No. 19 - 11793

Air filter replaces Honda 17211-ZF5-V01. Fits engine models GXV340 & GXV390.



Length 5-3/4"
Width 3-1/2"
Height 1"

Order No. 19 - 7980

Filter replaces Honda 17211-ZG9-MOO. Fits SX series, Harmony 215 model HRM215.

Order No. 19 - 7979

Precleaner replaces Honda 17218-ZG9-MOO. Length 5-1/2", Width 3-1/4", Thickness 1/4".



Length 7-1/2"
Width 2-1/2"
Height 1-5/8"

Order No. 19 - 7713

Filter & Prefilter replaces Honda 17210-ZE6-003 & 17210-ZE6-505, code 1495902. Fits (3-1/2, 4 and 5 hp), models GXV120, GV150, GV200, HR194 & HR195.

Order No. 19 - 7726

Prefilter replaces Honda 17218-888-003, code 1067149.

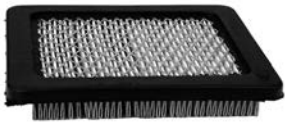

ID 4-1/2"
OD 5-1/4"
Height 3/4"

Order No. 19 - 9953

Air filter replaces Honda 17211-2L8-023, 17211-ZL8-000, code 5580402. Fits units GC 135, GCV 135 & GC160, GCV160.



Order No. 19 - 10477

Air cleaner base and cover replaces Honda 17231-ZM0-000 & 17220-ZM0-000. Fits models GCV 135/160. Uses our filter 19-9953.



Length 5"
Width 2-5/8"
Height 3-1/8"

Order No. 19 - 2808

Filter & Prefilter replaces Honda 17210-ZE8-013 & 17210-ZF5-505, code 2090207 for 8-1/2 -13 hp. Fits models GXV270, 340 & 390. Uses our 19-6707 & 19-6708 Grommet.

Order No. 19 - 2809

Prefilter.



Order No. 19 - 6708

Replaces Honda 17232-891-000.

MIN010



Order No. 19 - 6707

Old Style Rubber Grommet used on Honda filter.

MIN010

30

O.E.M.



O.E.M. REPLACEMENT

HONDA (Cont.)



Top OD 3-1/8"
Bottom OD 4-3/8"
Height 2-3/8"



Top OD 3-7/8"
Bottom OD 5-1/4"
Height 2-5/8"

Order No. 19 - 6686

Filter & Prefilter replaces Honda 172A-188-3902, code 2893915. Fits model G200 engines.

Order No. 19 - 6687

Prefilter replaces Honda 17218-883-901, code 1067131.

Order No. 19 - 6688

Filter & Prefilter replaces Honda 17211-890-023, code 102518. For 7, 10 & 11 hp engines. Fits model 3810 tractor and models G300 & G400.

Order No. 19 - 6689

Prefilter replaces Honda 17221-889-003.

O.E.M. 30



Length 4"
Width 2-7/8"
Height 2-5/8"



Length 4"
Width 3-1/2"
Height 3-1/8"

Order No. 19 - 6690

Filter & Prefilter replaces Honda 17210-ZE1-821 & 17210-ZE1-505, code 2893881. Fits model GX110, GX120, GX140, GX160 (3-1/2, 5 & 5-1/2 hp) engines.

Order No. 19 - 6691

Prefilter replaces Honda 17218-ZE1-821, code 2535029.

Order No. 19 - 6692

Filter & Prefilter replaces Honda 17210-ZE2-822 & 17210-ZE2-505, code 2893899. Fits model GX240, GX270 (8 & 9 hp) horizontal engines.

Order No. 19 - 6693

Prefilter replaces Honda 17218-ZE2-821, code 2538429.



Length 6-1/2"
Width 4-1/8"
Height 1-5/8"



Length 4"
Width 2-7/8"
Height 2-1/8"

Order No. 19 - 7042

Filter & Prefilter replaces Honda 17211-ZA0-702 & 17210-ZA0-506, code 2893923. Fits HT3813 and 4213 tractors, also fits GX360K1 vertical engines.

Order No. 19 - 7043

Prefilter.

Order No. 19 - 7044

Filter & Prefilter replaces Honda 17210-ZE0-822, code 2893873. Fits GX110 old 3-1/2 hp, GX120 new (4 hp) engines, also fits Tiller model 400, 401K1 horz. shaft.

Order No. 19 - 7045

Prefilter replaces Honda 17218-ZE0-821, code 2535011.



Length 8-1/2"
Width 2-1/2"
Height 2-3/8"



OD 7-1/4"
ID 5-1/8"
Height 2"

Order No. 19 - 2807

Prefilter replaces Honda 17218-891-003, code 1067164.

Order No. 19 - 13640

Air filter replaces Honda 17210-Z6L-010. Fits some GX630 & GX660, GX690 units.

Order No. 19 - 7712

Filter & Prefilter replaces Honda 17210-ZE3-010 & 17210-ZE3-505, code 2893907. Fits (8 thru 13 hp), models GX240, GX270, GX340 and GX390.

Order No. 19 - 7725

Prefilter replaces Honda 17218-ZE3-000 & 17218-ZE3-505, code 2577377.

Order No. 19 - 9473

Prefilter for our 19-7712 Air Filter.



Length 4-3/8"
Width 3-3/4"
Height 3-5/8"



HONDA (Cont.)

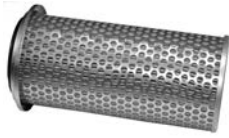

Length 9-1/2"
ID 2"
OD 3-5/8"

Order No. 19 - 10680

Air filter replaces Honda 17210-759-013. Fits models GX610, 620, with remote type air cleaner assembly.



Order No. 19 - 6681

Oil Filter. Replaces Honda 15410-MJO-004 & 15400-PFB-004, code 3481355, 15410-ZJ4-999AH, 15400-PR3-004. Fits model GX360K1 (water cooled) engines, tractor models 3810 & 4514. 25/30 Micron.



Order No. 19 - 13237

Oil filter replaces Honda 154-PLM-A01PE. Fits 18, 20 & 24 hp v-twins.



Order No. 19 - 10883

Oil filter replaces Honda 15410-MCJ-003. Fits model GXV530, 16 hp V-twin engine.



Order No. 20 - 9603

Fuel cap replaces Honda 17620-ZE2-W00 & 17620-ZH7-023. Fits 4-8 hp engines. Metal cap. Fits our **20-10906** & **20-11016** fuel tank.



Order No. 20 - 9604

Fuel cap replaces Honda 17620-2H7-013 code 3682028. Fits 4-8 hp engines. Plastic cap.



Order No. 20 - 12127

Fuel cap replaces Honda 17620-ZE7-000. Fits GXV120, GXV160K1, GXV340K1, GXV340K2, GXV390K. Mower models HR214SXAHR HRA HRC 215 & 216.



Order No. 20 - 10484

Fuel filter joint replaces Honda 16955-ZE1-000. Fits models GX 110, 120, 140, 160, 240, 270, 340 & 390.



Order No. 20 - 10478

Fuel line shut-off replaces Honda 16950-ZG9-MO2. Fits models GCV 135/160.



Order No. 20 - 13357

Fuel filter replaces Honda 16910-ZE4-S21.

MIN005



Order No. 20 - 10906

Fuel tank replaces Honda 17510-ZE1-020ZA. Fits model GX140/160.



Order No. 20 - 11016

Fuel tank replaces Honda 17510-ZE3-020ZA. Fits models GX340 & GX390, Honda code 7669757.

30

O.E.M.

O.E.M. REPLACEMENT



HONDA (Cont.)



Order No. 22 - 13200

Carburetor replaces Honda 16100-ZE6-055. Fits model GXV120.



Order No. 22 - 13192

Carburetor replaces Honda 16100-ZH7-W61. Fits model GX120.



Order No. 22 - 13193

Carburetor replaces Honda 16100-ZE1-825. Fits model GX140.



Order No. 22 - 13194

Carburetor replaces Honda 16100-ZH8-W61. Fits model GX160.



Order No. 22 - 13195

Carburetor replaces Honda 16100-ZL0-W51. Fits model GX200.



Order No. 22 - 13196

Carburetor replaces Honda 16100-ZE2-W71. Fits model GX240.



Order No. 22 - 13197

Carburetor replaces Honda 16100-ZH9-W21. Fits model GX270.



Order No. 22 - 13198

Carburetor replaces Honda 16100-ZE3-V01. Fits model GX340.



Order No. 22 - 13199

Carburetor replaces Honda 16100-ZF6-V01. Fits model GX390.



Order No. 22 - 13202

Carburetor replaces Honda 16100-ZE7-W21. Fits model GXV160.

Order No. 22 - 13203

Carburetor replaces Honda 16100-ZOD-003. Fits model GX100.



30

O.E.M.



HONDA (Cont.)



Order No. 22 - 13204

Carburetor replaces Honda 16100-ZM7-G17. Fits model GXH50.



Order No. 22 - 13205

Carburetor replaces Honda 16100-ZM5-803. Fits model GX31.



Order No. 22 - 13206

Carburetor replaces Honda 16100-ZN2-811. Fits model GX670.



Order No. 22 - 13207

Carburetor replaces Honda 16100-ZJ1-892. Fits model GX620.

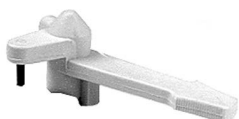

Order No. 22 - 10863

Choke lever replaces Honda 16610-ZE1-000. Fits models GX 110/120/140/160 & GX 240/270/340/390.



Order No. 22 - 10945

Needle valve replaces Honda 16155-883-005. Fits models G10, G150, G200, G300, GV150 and GV200. Code 0636282. MIN005



Order No. 22 - 10463

Needle valve replaces Honda 16011-ZE0-005. Fits models GX110, 120, 140, 160. Inlet needle only.



Order No. 22 - 10475

Needle valve replaces Honda 16011-ZA0-931. Fits models GX240, 270, 340, 390. Inlet needle only.



Order No. 22 - 10474

Float and Pin replaces Honda 16013-ZE0-005. Fits models GX110, 120, 140, 160.



Order No. 22 - 10476

Float replaces Honda 16013-ZA0-931. Fits models GX240, 270, 340, 390.



Order No. 22 - 10866

Carburetor float bowl replaces Honda 16015-ZE8-005. Fits models GX 240/270/340/390.



Order No. 22 - 10479

Float bowl replaces Honda 16015-ZE1-811. Fits models GX110, 120, 140, 160.

O.E.M. REPLACEMENT



HONDA (Cont.)

Carburetor Repair Kit for HONDA

Order No. 22 - 14272

Carburetor repair kit replaces Honda 16010-ZE2-812. Only includes bowl gasket and O-rings. Fits Honda engine models GX340 and GX390.

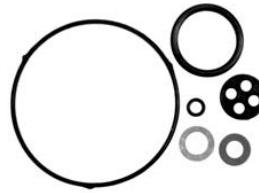

30

Order No. 22 - 10856

Throttle return spring replaces Honda 16562-ZE1-020. Fits models GX110/120/140/160.



Order No. 22 - 10857

Governor spring replaces Honda 16561-ZE1-810. Fits models GX 110/120/140/160.



O.E.M.

Order No. 22 - 10869

Throttle return spring replaces Honda 16562-ZE2-000. Fits models GX 240/270/340/390.



Order No. 22 - 10870

Throttle return spring replaces Honda 16562-ZM0-000. Fits models GXV 135/160.



Order No. 22 - 11838

Governor spring replaces Honda 16561-ZM0-000. Fits models GCV135/160.



Order No. 22 - 11839

Governor spring replaces Honda 16561-ZE3-000. Fits models GX240/340/390.



Order No. 23 - 10864

Oil fill cap replaces Honda 15600-ZG4-003. Fits models GX110/120/140/160, GX240/270/340/390.



Order No. 23 - 10471

Oil gauge and gasket replaces Honda 15600-ZE1-003. Fits models GX110, 120, 140, 160.



Order No. 23 - 10467

Oil gauge and gasket replaces Honda 15650-ZM0-801. Fits models GCV135/160.



Order No. 23 - 11989

Oil seal replaces Honda 91202-883-005. Front and rear seal. Fits G150-300, GV150-200, GX120-200. 25mm x 41mm x 6mm. Made of Viton.



Order No. 23 - 11990

Oil seal replaces Honda 91201-890-003. Front and rear seal. Fits G300-400, GV400, GX240-340. 30mm x 46mm x 8mm. Made of Viton.





HONDA (Cont.)



Order No. 23 - 11991

Oil seal replaces Honda 91201-ZE3-004. Front and rear seal. Fits GCV530, GX340-390, GXV340-530. 35mm x 52mm x 8mm. Made of Viton.



Order No. 23 - 12110

Oil drain valve (Metric M14 x 1.5) threads. Fits Honda 15558-ZJ1-010AH. For GX610 & 620.



Order No. 23 - 9834

Connecting rod replaces Honda 13200-ZE2-000 & 13200-ZE2-010. Fits model GX240.

Order No. 23 - 9837

Connecting rod replaces Honda 13200-ZE3-010, 13200-ZE3-000 & 13200-ZE3-020. Fits model GX340, GX390.

Order No. 23 - 9832

Connecting rod replaces Honda 13200-ZE0-000. Fits models GX110/GX120.

Order No. 23 - 9833

Connecting rod replaces Honda 13200-ZE1-000 & 13200-ZE2-010. Fits models GX140/GX160.



Order No. 23 - 9821

Exhaust valve replaces Honda 14721-ZE0-010. Fits GX110.

Order No. 23 - 9827

Exhaust valve replaces Honda 14721-ZF1-000. Fits GX160.

Order No. 23 - 9829

Exhaust valve replaces Honda 14721-ZE2-000. Fits GX240 & GX270.

Order No. 23 - 9831

Exhaust valve replaces Honda 14721-ZE3-000. Fits GX340.



Order No. 23 - 9820

Intake valve replaces Honda 14711-ZE0-010. Fits GX110.

Order No. 23 - 9822

Intake valve replaces Honda 14711-ZF0-000 & 14711-ZF0-010. Fits GX120.

Order No. 23 - 9826

Intake valve replaces Honda 14711-ZF1-000. Fits GX160.

Order No. 23 - 9830

Intake valve replaces Honda 14711-ZE3-000. Fits GX340.



Order No. 23 - 10480

Exhaust gasket replaces Honda 18381-ZL8-305. Fits models GCV135/165. MIN010



Order No. 23 - 10481

Intake insulator gasket replaces Honda 16212-ZL8-000. Fits models GCV135 / 160. MIN010



Order No. 23 - 10482

Intake carburetor gasket replaces Honda 16221-883-800. Fits models GCV135 / 160. MIN010



Order No. 23 - 10483

Carburetor gasket replaces Honda 16228-ZL8-000. Fits models GCV135 / 160. MIN010



Order No. 23 - 13250

Carburetor bowl gasket for Honda. Fits GX110/120/140/160. Included in our 22-10479 assembly. MIN005

30

O.E.M.

O.E.M. REPLACEMENT



HONDA (Cont.)



Order No. 23 - 13549

Carburetor bowl gasket replaces Honda 16010-ZE2-812. Fits GX240, GX270, GX340, GX390, GXV270, GXV340, GXV390. Not available separately from Honda. Included in OEM 16010-ZE2-812 gasket kit. Included in our 22-10866 assembly.
MIN010

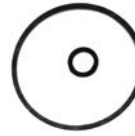

Order No. 23 - 7234

Carburetor Gasket Kit replaces Honda 16010-883-015. Fits models G-15, G-200, G-300 and G-400.



Order No. 23 - 13514

Head gasket replaces Honda 12251-ZF6-W00. Fits GX390 13hp engines.



Order No. 23 - 13515

Head gasket replaces Honda 12251-ZE7-000. Fits GXV160 5.5 hp engines.



Order No. 23 - 13516

Head gasket replaces Honda 12251-ZE7-800. Fits GXV120, 4 hp engines.



Order No. 23 - 14146

Cylinder Head gasket replaces Honda 12251-ZE6-000. Fits GXV120.



Order No. 23 - 13520

Exhaust gasket replaces Honda 18381-ZH8-800. Fits GX160, 5.5 hp engines.
MIN010



Order No. 23 - 13517

Exhaust gasket replaces Honda 18333-ZK6-Y00. Fits GX240, GX340, GX390. (Two bolt holes).
MIN010



Order No. 23 - 13518

Exhaust gasket replaces Honda 18381-ZE2-W10. Fits GX240, GX270, GX340 GX390. (Three bolt holes).
MIN010



Order No. 23 - 13519

Exhaust gasket replaces Honda 18381-ZE6-820. Fits models GXV120 / GXV160.
MIN010

Order No. 23 - 13650

Base gasket replaces Honda 11381-ZH8-801. Fits GX160 / GX200.
MIN010

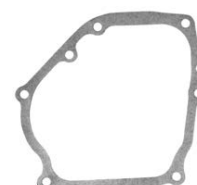

O.E.M. 30



HONDA (Cont.)



Order No. 23 - 11283

Piston ring set replaces Honda 13010-ZE6-013. Fits model GX120. Used in our **23-11282** Piston Assembly.

Order No. 23 - 11286

Piston ring set replaces Honda 130A1-ZE1-003. Fits model GX140. Used in our **23-11285** Piston Assembly.

Order No. 23 - 11290

Piston ring set replaces Honda 13010-ZF1-023. Fits model GX160. Used in our **23-11288** Piston Assembly.

Order No. 23 - 11302

Piston ring set replaces Honda 13010-ZF6-003. Fits model GX390. Used in our **23-11301** Piston Assembly.

Order No. 23 - 11296

Piston ring set replaces Honda 13010-ZE2-013. Fits model GX240. Used in our **23-11293** Piston Assembly.



Order No. 23 - 11282

Piston assembly replaces Honda 13101-ZE0-000. Fit model GX120. Includes piston, rings, wrist pin & keepers.

Order No. 23 - 11285

Piston assembly replaces Honda 13101-ZH7-010. Fit model GX140. Includes piston, rings, wrist pin & keepers.

Order No. 23 - 11288

Piston assembly replaces Honda 13101-ZE1-000. Fit model GX160. Includes piston, rings, wrist pin & keepers.

Order No. 23 - 11298

Piston assembly replaces Honda 13101-ZH8-010. Fit model GX340. Includes piston, rings, wrist pin & keepers.

Order No. 23 - 11301

Piston assembly replaces Honda 13101-ZF6-W00. Fit model GX390. Includes piston, rings, wrist pin & keepers.

Order No. 23 - 11293

Piston assembly replaces Honda 13101-ZE2-010. Fit model GX240. Includes piston, rings, wrist pin & keepers.



Order No. 23 - 12593

Gasket set replaces Honda 06111-ZE6-405. Fits models GXV120. Code 5296264.

Order No. 23 - 12314

Gasket set replaces Honda 06111-ZEZ-406 & 061A1-ZE7-801. Fits model GXV 160.

Order No. 23 - 9731

Gasket set replaces Honda 06111-ZH7-405. Fits model GX120.

Order No. 23 - 9732

Gasket set replaces Honda 06111-ZF6-406. Fits model GX390.

Order No. 23 - 9782

Gasket set replaces Honda 06111-ZH8-405. Fits model GX160K1, 5.5 hp.

Order No. 23 - 9783

Gasket set replaces Honda 06111-ZE2-405. Fits model GX240K1, 8 hp.

Order No. 23 - 9784

Gasket set replaces Honda 06111-ZE3-405. Fits model GX340, 11 hp.

Order No. 23 - 9842

Gasket set replaces Honda 061A1-ZE0-000. Fits model GX110.

Order No. 23 - 9843

Gasket set replaces Honda 061A1-ZE1-T010. Fits model GX140.

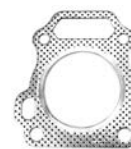

Order No. 23 - 9838

Head gasket replaces Honda 12251-ZE2-800. Fits model GX240. (metal)

Order No. 23 - 9839

Head gasket replaces Honda 12251-ZE0-800. Fits model GX110 & GX120. (metal)

Order No. 23 - 9785

Head gasket replaces Honda 12251-ZF1-800. Fits model GX160, 5.5 hp horz. (metal)

Order No. 23 - 9786

Head gasket replaces Honda 12251-ZE3-800 & 12251-ZE3-W00. Fits model GX340, 11 hp horz. (metal)

30

O.E.M.



O.E.M. REPLACEMENT

HONDA (Cont.)



Order No. 23 - 14335

Honda Tune-up Kit for 3.5 hp - 5.0 engines for older applications. Includes spark plug, air filter, 4 cycle oil, and fuel stabilizer. The handy package converts to an oil funnel and drain pan. MIN004

Order No. 23 - 14336

Honda Tune-up Kit for HRR, HRX applications 5.0 + mulcher engine. Includes spark plug, air filter, 4 cycle oil, and fuel stabilizer. The handy package converts to an oil funnel and drain pan. MIN004



Order No. 24 - 10865

Spark plug boot fits Honda models GX110/120/140/160, GX240/270/340/390.



Order No. 25 - 10871

Starter handle fits Honda models GX110, GX120, GX140, GX160.



Order No. 25 - 9065

Starter handle replaces Honda 28461-ZE1-003, code 1428747. For large Honda engines.



Order No. 25 - 9114

Starter handle replaces Honda 28461-ZGO-004, code 4186425. Fits Honda G100. For small Honda engines.

Order No. 25 - 10473

Starter handle replaces Honda 28461-ZL8-003. Fits models GCV135 / 160. Fits our 26-9985 recoil starter.



Order No. 26 - 11488

Electric starter replaces Honda 31210-ZE1-023. Used on 5.5 hp engines. 12-volt, 17-tooth, Models GX140 & GX 160.



Order No. 26 - 11489

Electric starter replaces Honda 31210-ZA1-003 & 31210-ZE8-801. Models GXV270, GXV340 & GXV390. CCW; 14-tooth. Fits EMS4000A, EMS4500A, Generators, ES4500K1A, EV4000A. G300 & G400K1 engines. HT3810SA & HT3810K1SA lawn tractors. 14 teeth.



Order No. 26 - 11490

Electric starter replaces Honda 31200-ZH9-003. Used on 9.9 hp engines. Models GX270. 12-volt, CW, 17-tooth.



Order No. 26 - 12065

Electric starter replaces Honda 31200-ZJ4-831. Used on models GXV610, 620 & 670 engines. 12 volt, cw, 12 tooth.

30

O.E.M.



HONDA (Cont.)



Order No. 26 - 12481

Electric starter replaces Honda 31200-ZF-5-L32 & 31200-ZF5-L31. Fits models GXV 340 & GXV 390, 12-volt, CCW, 10 tooth.



Order No. 26 - 12087

Electric starter replaces Honda 31200-ZJ1-841. Used on Honda GX610, 620, 670 engines. 12 volt, CW, 12 tooth.



Order No. 26 - 10674

Electric starter replaces Honda 31210-ZE3-013. Fits model GX340. 14 teeth



Order No. 26 - 12050

Solenoid replaces Honda 31204-ZA0-003. Used with our 26-10674 starter.



Order No. 26 - 10466

Recoil starter assembly replaces Honda 28400-ZM3-003. Fits GX22/3, 1B/C, 22/31CC, Zenoah G34/160.



Order No. 26 - 10469

Recoil starter assembly replaces Honda 28400-ZE2-W01ZA. Fits GX240, 270 & K1. 2 metal pawls.



Order No. 26 - 9064

Starter Recoil Assembly replaces Honda 28400-ZH8-0132A, 28400-ZE1-003ZA, code 3373768. Fits Honda series GX110, GX120, 140, 160. 2 plastic pawls.



Order No. 26 - 10379

Recoil starter assembly replaces Honda 28400-ZE3-W01ZA. Fits newer style model GX340 & GX390. 2 metal pawls.



Order No. 26 - 9063

Starter Recoil Assembly replaces Honda 28400-883-040ZB, code 3488467. Fits Honda G150 & G200 engines. 1 metal pawl.



Order No. 26 - 12079

Recoil starter assembly replaces Honda 28400-ZH8-023YA. Fits GX120, GX160K1, GX200. 2 metal pawls.

Order No. 26 - 12019

Recoil starter assembly replaces Honda 28400-ZG9-803, 28400-ZG9-802. Fits GXV140 & GXV160.



30

O.E.M.



O.E.M. REPLACEMENT

HONDA (Cont.)



Order No. 26 - 9998

Starter recoil assembly replaces Honda 28400-ZE8-8113A, code 3417292. Fits GX 340. 1 metal pawl.

Order No. 26 - 9985

Starter recoil assembly replaces Honda 28400-ZM0-003, code 6061204. Fits GC 130/160, GCV 130/160. 55" Rope.



Order No. 26 - 14643

Starter recoil assembly replaces Honda 28400-ZOL-V20ZA. Fits models GXV135 & GCV160. Similar to our **26-9985**, but with 82" of rope. Black



Order No. 26 - 13355

Starter pulley and spring replaces Honda 28415-ZG9-802. Fits model GXV140 & GXV160.



Order No. 26 - 10858

Recoil starter pulley replaces Honda 28451-ZH8-003. Fits models GX110, GX120, GX140, GX160.



Order No. 26 - 10867

Recoil starter pulley replaces Honda 28421-ZE2-W01. Fits models GX240 & GX270.



Order No. 26 - 10868

Recoil starter pulley replaces Honda 28421-ZE3-003. Fits models GX340 & GX390 newer style.



Order No. 26 - 10465

Pulley and spring assembly fits Honda. Fits models GCV135 & 160. Used on our **26-9985** recoil starter.



Order No. 26 - 12129

Recoil starter pulley replaces Honda 28421-ZH8-801 with 28442-ZH8-003 spring. Fits Honda GX120, GX160KI, GX200. Fits our **26-12079** recoil assembly.



Order No. 26 - 12221

Recoil repair kit for Honda. Fits Honda GX120, GX160KI, GX200. Fits our **26-12079**.

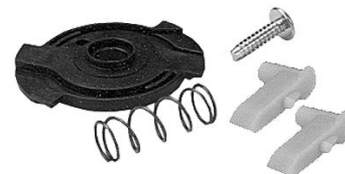

Order No. 26 - 10464

Starter pawl assembly for Honda. Fits models GCV135 / 160. Fits our recoil starter **26-9985**.

30

O.E.M.



HONDA (Cont.)



Order No. 26 - 10470

Pawl assembly replaces Honda 28444-ZE2-W01. Fits models GX240, 270, 340, 390.



Order No. 26 - 10472

Pawl assembly replaces Honda 28434-ZE1-711. Fits models GX340, 390. Fits our 26-9998 Starter Assembly.



Order No. 26 - 9180

Starter pulley repair kit for Honda engines. For Honda models GX110, 120, 140 & 160. Replaces Honda 28422-ZH8-013 (ratchet), 28443-ZH8-003 (spring), 28441-ZH8-003 (washer), 28433-ZH8-003 (guide ratchet).



Order No. 28 - 8666

Grass bag replaces Honda 81320-VB5-J00, code 333-6815. Fits newer commercial 21" models after 1990. (Black)



Order No. 26 - 2421

Replaces Honda 28442-896-700, Code 093310.

Order No. 26 - 2422

Replaces Honda 28442-883-000, Code 063667.

Order No. 26 - 2424

Replaces Honda 28447-878-810, Code 044186.



Order No. 26 - 9505

Starter rewind spring replaces Honda 28442-ZE6-003. Fits Honda model GX100QE multi fit starter.

Order No. 26 - 9526

Starter rewind spring replaces Honda 28442-ZE1-003. Fits Honda model GX110, GX140, GX160 multi fit starter. Single ratchet (before 1995).

Order No. 26 - 9527

Starter rewind spring replaces Honda 28442-ZH8-003. Fits Honda model GX120, GX160, multi fit starter. Twin ratchet (after 1995).

Order No. 26 - 9528

Starter rewind spring replaces Honda 28442-ZE1-713 & 28442-ZE1-711. Fits Honda model GX240, GX340, multi fit starter. Single ratchet (before 1995).

Order No. 29 - 8608

Left hand tiller tine replaces Honda 72461-723-700. Two 3/8" mounting holes, 3-1/8" center to center, 14" bolo tine.

Order No. 29 - 8609

Right hand tiller tine replaces Honda 72465-723-700. Two 3/8" mounting hole, 3-1/8" center to center, 14" bolo tine.



Order No. 31 - 9209

Regulator/Rectifier replaces Honda 31600-890-951. For Honda lawn tractors.



Order No. 31 - 10859

Stop engine switch replaces Honda 36100-ZE1-015. Fits models GX110, GX120, GX140, GX160, GX240, GX270, GX340, GX390.

**O.E.M. REPLACEMENT
HONDA (Cont.)**



Order No. 31 - 10462

Ignition coil replaces Honda 30500-ZE1-033. Fits models GX110, GX120, GX140, GX160.



Order No. 31 - 12083

Ignition coil replaces Honda 30500-ZF6-W02 / 30500-ZE2-023. Fits models GX240, GX270, GX340 and GX390. Supersedes 30500-ZF6-W01.



Order No. 41 - 5522

Scrapper Bar replaces Honda 76322-747-A10. Honda code 3526985. Fits model HS621. 19-5/8" length x 2-7/8" width x 1-3/16" mounting holes.



Order No. 41 - 5537

Rubber auger kit replaces Honda 76322-V10-020 code 6672448. Fits HS520 snowblowers.



Order No. 41 - 5536

Rubber auger kit replaces Honda 06720-V10-030 code 6813166. Fits HS520 snowblowers. 6 piece set.



Order No. 41 - 5526

Snowblower Paddles replaces Honda 72523-747-000 (1) pcs. & 72522-747-000 (2) pcs. & 72521-747-000 (3) pcs. Fits models 521 & 621. 6 piece set.



Order No. 41 - 5505

Rubber Paddles replaces Honda 103375 (4 ea.) and Honda 1003391. 8 piece set.



Order No. 41 - 5540

Shear Pin and Nut replaces Honda 90102-732-010 & 90114-SA0-000. Thread M6 x 1.0, Shoulder Dia. 10mm, Length 1-39/32".
MIN005

Order No. 41 - 13043

Snow blower skid replaces Honda 76153-736-010 & 76153-736-000 / 1878628. Fits HS55, HS55K1, HS55K2, HS70, HS80, HS80K1, HS50.



30

O.E.M.



**COMMERCIAL REPLACEMENT PARTS BREAK-DOWN FOR HUSTLER
REPLACEMENT PARTS FOR 44", 52" FAST TRACK, MINI Z & SUPER MINI Z
SUPER Z 52", 60" & 72" DECK MOWERS**

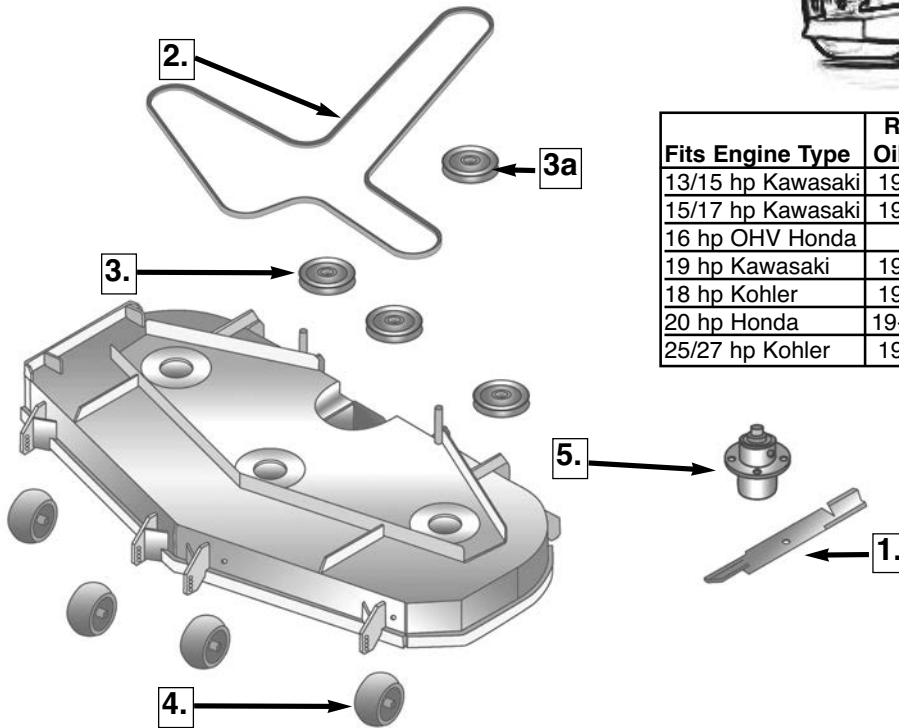
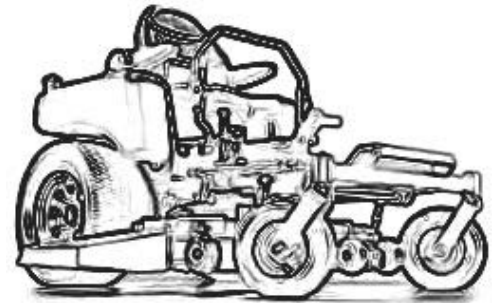

Fits Engine Type	Rotary Oil Filter	Rotary Pre Filter	Rotary Air Filter	Rotary Fuel Filter
13/15 hp Kawasaki	19-6600			
15/17 hp Kawasaki	19-6600			
16 hp OHV Honda				
19 hp Kawasaki	19-6600	19-9728	19-9583	20-7998
18 hp Kohler	19-7916		19-11466	20-10352
20 hp Honda	19-10883		19-10879	20-10352
25/27 hp Kohler	19-5909	19-9728	19-9583	20-10352

30

O.E.M.

Ref. No.	Order No.	Deck Size	Description/Replaces
FITS MODEL (FAST TRAK)			
1.	15-10371	44"	Blade/Hustler 784256
	15-10973	44"	Commercial Mulcher Blade
	15-11557	52"	Blade/Hustler 795526
	15-11556	52"	Commercial Mulcher Blade
2.	12-10861	44"	Belt/Hustler 784322
	12-10852	52"	Belt/Hustler 784249
3.	13-10156	44" & 52"	Pulley/Hustler 784504
4.	07-6916	44" & 52"	Deck Wheel/Hustler 031997
5.	10-11452	44" & 52"	Spindle/Hustler 783506
FITS MODEL (Mini Z & Super Mini Z)			
1.	15-10371	44"	Blade/Hustler 784256
	15-10973	44"	Commercial Mulcher Blade
	15-11557	52"	Blade/Hustler 795526
	15-11556	52"	Commercial Mulcher Blade
2.	12-10850	44"	Belt/Hustler 786491
	12-10849	52"	Belt/Hustler 786483
3.	13-10226	44" & 52"	Pulley/Hustler 781385
3a.	13-10227	44" & 52"	Pulley/Hustler 781856
4.	07-6917	44" & 52"	Deck Wheel/Hustler 031997
5.	10-11452	44" & 52"	Spindle/Hustler 783506

Ref. No.	Order No.	Deck Size	Description/Replaces
FITS MODEL (Super Z)			
1.	15-10372	52"	Blade/Hustler 781898
	15-11556	52"	Commercial Mulcher Blade
	15-10373	60"	Blade/Hustler 782516
	15-10971	60"	Commercial Mulcher Blade
	15-10797	72"	Blade/Hustler 783977
2.	12-10847	52"	Belt/Hustler 782292
	12-10845	60"	Belt/Hustler 781310
	12-10846	72"	Belt/Hustler 784207
3.	13-10226	44" & 52"	Pulley/Hustler 781385
3a.	13-10227	44" & 52"	Pulley/Hustler 781856
3.	13-10861	44" & 52"	Pulley/Hustler 784504
4.	07-6917	52", 60", 72"	Deck Wheel/Hustler 031997



**O.E.M. REPLACEMENT
HUSTLER/EXCEL**



ID 1/2"
Width 2-3/4"
Height 5"

Order No. 07 - 6916

Deck Wheel. Replaces Excel 031997. 2-1/2" offset hub.



Order No. 08 - 12635

20 x 12.00 - 10, 4-ply tubeless Turf Trac RS tread tire. Used on Hustler models.



Order No. 08 - 12795

18 x 8.50 - 10, 4-ply tubeless Multi-Trac tread tire. Used on Hustler models.



ID 1" (25.40 mm)
OD 2" (52 mm)
Height 27/32" (21.43 mm)

Order No. 09 - 8488

Bearing replaces Hustler 077123. Bearing No. RA100RR.



ID 3/4"
OD 1-3/4"
Height 1/2"

Order No. 09 - 11835

Flanged wheel bearing replaces Hustler 39677.



ID 3/4" (19mm)
OD 1" (25.4mm)
Length 6-1/4" (152mm)

Order No. 09 - 14133

Bearing spacer replaces Hustler 782771. Used with our 09-11835 bearings.



Order No. 10 - 11237

Electric PTO clutch replaces Midmounts Excel 787366. For 25hp engines. 6.25" Dia. Pulley. 5/8" Belt, shaft size 1-1/8". Warner 5218-65 & 51218-213.



Order No. 10 - 11445

Electric PTO clutch replaces Hustler 781039K 6-1/4" Dia. Pulley. 5/8" Belt, shaft size 1-1/8". Warner 5218-110.



Order No. 10 - 12454

Electric PTO clutch replaces Hustler 601311. Warner 5218-154 & 5218-222. Shaft size 1-1/8", 6-5/16" pulley diameter, 5/8" Belt.



Order No. 10 - 11452

Spindle assembly replaces Excel/Hustler 783506. Fits Fast Trak, Mini Z & Super Mini Z models.



Order No. 10 - 12833

Spindle shaft replaces Hustler 788547. Fits Super Z with 52", 60" & 72" decks. Fits our 10-12241 spindle assembly.

30

O.E.M.



HUSTLER/EXCEL



Order No. 10 - 12241

Spindle assembly replaces Excel 350595. Fits Super Z with 52", 60" & 72" decks. Cast iron housing. Used with our **10-14036**.



Order No. 10 - 12459

Spindle assembly replaces Hustler 796235. Fits Super Z with 52", 60" & 72" decks. Cast iron housing. Uses our **10-12491** replacement shaft. also uses our **10-14036** Housing.



Order No. 10 - 12491

Spindle shaft replaces Hustler 796227. Fits Super Z with 52", 60" & 72" decks. Fits our **10-12459** spindle assembly.



Order No. 10 - 14036

Spindle housing replaces Hustler 034843. Fits our **10-12241** & **10-12459** spindle assembly.

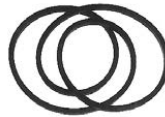

Order No.

Description

12 - 10834

Deck Belt. Replaces Husqvarna 539-107709. 5/8" (15.8 mm) x 143-1/2" (3644.9 mm). Fits 48" model CZ 4817. Raw edge, laminated, aramid cord construction.

12 - 10845

Deck Belt. Replaces Hustler 781310. 5/8" (15.8 mm) x 180" (4572 mm). Fits Z and Super Z 60" deck. Wrapped, aramid cord construction.

12 - 10846

Deck Belt. Replaces Hustler 784207. 5/8" (15.8 mm) x 195" (4953 mm). Fits Z and Super Z 72" deck. Wrapped, aramid cord construction.

12 - 10847

Deck Belt. Replaces Hustler 782292. 5/8" (15.8 mm) x 165-1/2" (4203.7 mm). Fits Z and Super Z 52" deck. Wrapped, aramid cord construction.

12 - 10849

Deck Belt. Replaces Hustler 786483. 5/8" (15.8 mm) x 148-1/2" (3771.9mm). Fits Mini Z and Super Z 52" deck. Wrapped, aramid cord construction.

12 - 10850

Deck Belt. Replaces Hustler 786491. 5/8" (15.8 mm) x 140" (3556 mm). Fits Mini Z and Super Z 44" & 48" deck. Wrapped, aramid cord construction.

12 - 10861

Deck Belt. Replaces Hustler 784322. 5/8" (15.8mm) x 138-1/4" (3511.6 mm). Fits 44" Fast Track models. Wrapped, aramid cord construction.

12 - 12323

Deck Belt. Replaces Hustler 797936. 5/8" (15.875 mm) x 184.79" (4693.6 mm). General purpose, Aramid cord construction, double cover, clutching.

12 - 12322

Deck Belt. Replaces Hustler 797720. 5/8" (15.875 mm) x 176.79" (4490.5 mm). General purpose, Aramid cord construction, double cover, clutching.

12 - 12321

Deck Belt. Replaces Hustler 797928. 5/8" (15.875 mm) x 160.2" (4069.1 mm). General purpose, Aramid cord construction, double cover, clutching.

O.E.M. REPLACEMENT
HUSTLER/EXCEL (Cont.)



Order No.	Description
12 - 12320	Deck Belt. Replaces Hustler 789388. 5/8" (15.875 mm) x 152" (3860.8 mm). General purpose, Aramid cord construction, double cover, clutching.
12 - 12319	Deck Belt. Replaces Hustler 791335. 5/8" (15.875 mm) x 143"(3632.2 mm). General purpose, Aramid cord construction, double cover, clutching.
12 - 12318	Deck Belt. Replaces Hustler 600726. 1/2" (12.7 mm) x 114.3" (2903.2 mm). General purpose, Aramid cord construction, double cover, clutching.
12 - 12264	Deck Belt. Replaces Hustler 600734. 1/2" (12.7 mm) x 132" (3352.8 mm). Fits 42" Mini Z model 928200. General purpose, Aramid cord construction, double cover, clutching.
12 - 12692	Deck Belt. Replaces Hustler 797167 . 5/8" (15.875mm) x 228.71" (5809.2 mm). Fits rear discharge Super Z only. Aramid cord construction.
12 - 12691	Deck Belt. Replaces Hustler 795781 . 5/8" (15.875mm) x 213.5" (5422.9 mm). Fits rear discharge Z and Super Z, 60" decks. Aramid cord construction.
12 - 12690	Deck Belt. Replaces Hustler 601015 . 5/8" (15.875mm) x 204.5" (5194.3 mm). Fits rear discharge Z and Super Z, 54" decks. Aramid cord construction.
12 - 12693	Deck Belt. Replaces Hustler 788737 . 1/2" (12.7mm) x 50.125" (1273.2 mm). Fits TriStar 36" walkbehind mowers. Aramid cord construction.
12 - 14000	Deck Belt. Replaces Hustler 602988 . 5/8" (15.87 mm) x 171-1/4" (4349.75 mm). Fits 60" X-One models. Wrapped molded, Aramid cord construction, double cover, clutching white.
12 - 12694	Deck Drive Belt. Replaces Hustler 797514 . 1/2" (12.7mm) x 66.378" (1686 mm). Fits TriStar 36" deck drive walkbehind mower. Aramid cord construction.
12 - 12695	Deck Drive Belt. Replaces Hustler 788729 . 5/8" (15.875mm) x 65.08" (1653 mm). Fits TriStar 48" deck drive walkbehind mower. Aramid cord construction.
12 - 12689	Pump Belt. Replaces Hustler 600979 . 1/2" (12.7mm) x 70.5" (1790.7 mm). Fits FasTrak Hydro pump belt for 48" & 54" decks. Aramid cord construction.
12 - 12688	Pump Belt. Replaces Hustler 788711 . 1/2" (12.7mm) x 47.382" (1203.5 mm). Fits TriStar walkbehind mowers. Aramid cord construction.
12 - 10844	Hydro Pump Belt. Replaces Hustler 781443. 1/2" (12.7 mm) x 62-1/4" (1581.2 mm). Fits Z and Super Z. Wrapped, polyester cord construction.
12 - 10848	Hydro Pump Belt. Replaces Hustler 786533. 1/2" (12.7 mm) x 57-3/8" (1457.3 mm). Fits Mini Z and Super Z 52" deck. Wrapped, aramid cord construction.
12 - 10851	Hydro Pump Belt. Replaces Hustler 784231. 1/2" (12.7mm) x 73-3/4" (1873.3 mm). Fits hydraulic for Fast Track models. Wrapped, aramid cord construction.
12 - 12414	Hydro Pump Belt. Replaces Hustler 788794. 1/2" (12.7 mm) x 64" (1625.6 mm). Fits MINI Z 36" & 42" units. Laminated, Aramid cord construction.

30

O.E.M.



HUSTLER/EXCEL (Cont.)

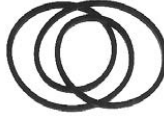

Order No.	Description
12 - 12413	Hydro Pump Belt. Replaces Hustler 793836. 1/2" (12.7 mm) x 63" (1600.2 mm). Fits MINI FASTTRAK models. General purpose, Aramid cord construction, double cover.
12 - 12417	Hydro Pump Belt. Replaces Hustler 788745. 5/8" (15.875 mm) x 86.306" (2192.2 mm). Fits 48" deck Trimstar Hydro walkbehind models. General purpose, Aramid cord construction, double cover, clutching.
12 - 12416	Hydro Pump Belt. Replaces Hustler 793893. 1/2" (12.7 mm) x 127.3" (3233.4 mm). Fits 42" deck Mini Fastrack models. General purpose, Aramid cord construction, double cover, clutching.
12 - 12415	Hydro Pump Belt. Replaces Hustler 793828. 1/2" (12.7 mm) x 116" (2946.4 mm). Fits 36" deck Mini Fastrack models. General purpose, Aramid cord construction, double cover, clutching.

*Made with KEVLAR® or non-trade marked Aramid fiber.

 <p>Splined ID 15/16" OD 5-13/16" Height 7/8"</p> <p>Order No. 13 - 11446 Deck drive pulley replaces Hustler 783571.</p>	 <p>Splined ID 15/16" OD 5-3/4" Height 1-13/32"</p> <p>Order No. 13 - 11447 Deck drive pulley replaces Hustler 486889.</p>
 <p>ID 11/16" OD 5-3/4" Height 1-5/16"</p> <p>Order No. 13 - 12696 Idler pulley replaces Hustler 781856. New style, replaces our 13-10227 pulley.</p>	 <p>ID 11/16" OD 6-3/4" Height 1-1/2"</p> <p>Order No. 13 - 10226 Flat idler pulley replaces Hustler 781385. Fits 52", 60" & 72" Super Z deck assembly.</p>
 <p>ID 11/16" OD 5-1/2" Height 1-5/16"</p> <p>Order No. 13 - 10227 Flat idler pulley replaces Hustler 781856. Fits 52", 60" & 72" Super Z drive units.</p>	 <p>ID 11/16" OD 5" Height 1-1/4"</p> <p>Order No. 13 - 12297 Idler pulley replaces Hustler 784504. Fits FasTrak & Mini FasTrak.</p>

30

O.E.M.



O.E.M. REPLACEMENT HUSTLER/EXCEL (Cont.)



ID 11/16"
OD 4"
Height 3/4"



ID 11/16"
OD 3-1/8"
Height 3/4"











Order No. 13 - 12298

Idle pulley replaces Hustler 784827. Fits FasTrak & Mini FasTrak

Order No. 13 - 12299













Idle pulley replaces Hustler 794404. Fits Mini FasTrak & Mini Z.

30 O.E.M.

ORDER NO.	REPLACES O.E.M. NO.	LENGTH	CENTER HOLE DIAM.	OUTSIDE HOLE DIAM.	CENTER TO CENTER	WIDTH	STEEL THICK.	APPLICATION
 15 - 9173	712224	4-11/16" 119.1mm	29/64" 11.5mm			1-1/4" 31.8mm	.095" 2.4mm	Takes 8 blades per unit. Shredder blade Used on 251K.
 15 - 9172	716886	6-7/16" 163.5mm	29/64" 11.5mm			1-1/4" 31.8mm	.095" 2.4mm	Takes 8 blades per unit. Shredder blade Used on 260K
 15 - 11870	794206	13-3/4" 349.3mm	5/8" 15.8mm			2-1/2" 63.5mm	.204" 5.2mm	Fits Mini Fastrak 36" side mulching. Used with our 15-6290 .
 15 - 11810	793802	13-3/4" 349.3mm	5/8" 15.8mm			2-1/2" 63.5mm	.204" 5.2mm	Fits 36" Hustler Mini Z & TrimStar. Used with our 15-10249 .
 15 - 10371	784256	15-5/8" 238.1mm	5/8" 15.8mm			2-1/2" 63.5mm	.204" 5.2mm	(3) blades for 44" cut. Fits models Hustler Z, Super Z & Short Cut.
 15 - 10973	785428	15-5/8" 396.9mm	5/8" 15.8mm			2-1/2" 63.5mm	.204" 5.2mm	Mulching Blade.
 15 - 6300	Bunton, Bad Boy John Deere Lesco, Scag Snapper	16-1/2" 419.1mm	5/8" 15.8mm			2-1/2" 63.5mm	.204" 5.2mm	Commercial Mulching Blade
 15 - 6436	767111	16-31/32" 431mm	1/2" 12.7mm			2-1/2" 63.5mm	.204" 5.2mm	(3) blades for 48" cut. Fits 48" cut Excel short cut.
 15 - 10972	782532 785436	17-7/8" 454mm	5/8" 15.8mm			3" 76.2mm	.204" 5.2mm	Mulching Blade.
 15 - 11557	795526	17-7/8" 454mm	5/8" 15.8mm			2-1/2" 63.5mm	.204" 5.2mm	(3) blades for a 52" cut. Fits Super Z. High Lift.



HUSTLER/EXCEL (Cont.)

ORDER NO.	REPLACES O.E.M. NO.	LENGTH	CENTER HOLE DIAM.	OUTSIDE HOLE DIAM.	CENTER TO CENTER	WIDTH	STEEL THICK.	APPLICATION
 15 - 11556	785436	17-7/8" 454mm	5/8" 15.8mm			2-1/2" 63.5mm	.204" 5.2mm	Mulching Blade PATENTED (3) blades for a 52" cut. Fits Super Z.
 15 - 10372	781898	17-7/8" 454.4mm	5/8" 15.8mm			3" 76.2mm	.240" 6.1mm	(3) blades for 52" cut. Fits models Hustler Z, Super Z & Short Cut.
 15 - 11856	797696	18-1/2" 401.3mm	5/8" 15.8mm			2-1/2" 63.5mm	.204" 5.2mm	Fits Z & Super Z 54 XR-7 side discharge (3) blades for a 54" cut.
 15 - 13623	797704	18-1/2" 401.3mm	5/8" 15.8mm			2-1/2" 63.5mm	.204" 5.2mm	Mulching Blade (3) blades for 54" cut
 15 - 12733	797704	18-1/2" 469.9mm	5/8" 15.9mm			2-1/2" 63.5mm	.204" 5.2mm	Mulching Blade. PATENTED (3) blades for a 54" cut.
 15 - 6435	770339	19" 482.6mm	1/2" 12.7mm			2-1/2" 63.5mm	.204" 5.2mm	(3) blades for 54" cut. Fits 54" cut Excel short cut.
 15 - 6180	794-685	20-1/2" 520.7mm	5/8" 15.9mm			2-1/2" 63.5mm	.240" 6.1mm	(3) blades for 60" cut. (2) 42" cut
 15 - 50106	72511VB3-B51	20-5/8" 523.88mm	.831" 21.43mm	.416" 10.71mm	3.45" 87.71mm	2.25" 57.2mm	.150" 3.97mm	(Export Only)
 15 - 10971	782557	21" 533.4mm	5/8" 15.8mm			3" 76.2mm	.204" 5.2mm	Mulching Blade.
 15 - 10373	782516	21" 533.4mm	5/8" 15.8mm			3" 76.2mm	.240" 6.1mm	"Does not fit RX7 decks". (3) blades for 60" cut. Fits models Hustler Z, Super Z & Short Cut.
 15 - 6441	602771	20-1/2" 520.7mm	5/8" 15.9mm			3" 76.2mm	.240" 6.1mm	(3) blades for 60" cut. High Lift.
 15 - 11721	798496	22-1/2" 571.5mm	5/8" 15.8mm			3" 76.2mm	.204" 5.2mm	(3) blades for a 66" cut.

30
O.E.M.



**O.E.M. REPLACEMENT
HUSTLER/EXCEL (Cont.)**

O.E.M. 30

ORDER NO.	REPLACES O.E.M. NO.	LENGTH	CENTER HOLE DIAM.	OUTSIDE HOLE DIAM.	CENTER TO CENTER	WIDTH	STEEL THICK.	APPLICATION
 15 - 6628	754879	23-7/8" 606.4mm	1/2" 12.7mm			2-3/4" 69.9mm	.240" 6.1mm	Fits 72" heavy duty dual trim deck takes (2) 15-6628 & (1) 15-6728 . Also fits Range Wing mowers takes (4) 15-6628 & (3) 15-6728 .
 15 - 6728	754853	23-7/8" 606.4mm	1/2" 12.7mm			2-3/4" 69.9mm	.240" 6.1mm	Fits models 2500, 72" deck 275, 285, 295, 305, 320, 340, 400, 3000, 3200, 3400, 4100, 4200, 4300, 4400, 4420, 4500 & 4600 units with 72" "Three way deck" or "Quad Cyclor" deck
 15 - 10797	783977	24" 609.6mm	5/8" 15.9mm			3" 76.2mm	.240" 6.1mm	(3) blades for a 72" cut. Fits Super Z.
 15 - 10421	798710 103-158	24-1/2" 622.3mm	5/8" 15.9mm			3" 76.2mm	.204" 5.2mm	(3)blade for 72" cut Solid Air Foil Hi-Lift.



OD 4"
ID 2-13/32"
Height 10-1/2"

Order No. 19 - 9583
Filter replaces Hustler 785261.



Length 9-1/2"
Width 8"
Height 1-1/4"

Order No. 19 - 10679
Air filter replaces Hustler 787226.

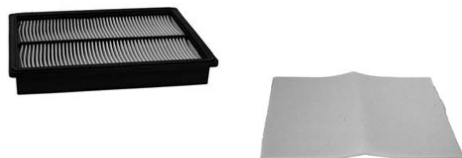

Length 9"
Width 6-1/2"
Height 1-1/4"

Order No. 19 - 10678
Air filter replaces Hustler 785600. Used with our **19-10961** pre-filter.

Order No. 19 - 10961
Prefilter replaces Hustler 785618. Prefilter for our **19-10678** air filter.



Order No. 19 - 9361
Transmission filter replaces Hustler 768341. Hydrostatic transmission filter has **3/4" - 16 thread, 10 micron, 3.404" Height, 2.921" OD, Thread size 3/4 - 16.**



Order No. 19 - 12374
Oil filter replaces Hydro Gear HG52114. Fits (Transmission Model ZT2800). Replaces Hustler 768341 & 600976.



Order No. 20 - 11273
Two-Way Fuel cut-off valve. 1/4" barb fitting. Fits Zero Turn riders with two tanks. Also replaces Exmark 1-633347 & Hustler 745059.



HUSTLER/EXCEL (Cont.)



Order No. 21 - 13998

Arm rest replaces Hustler 797480.



Order No. 31 - 14291

Seat switch replaces Hustler 782177. Hustler models Z, Mini Z, Super Mini Z and Super ZU. Normally Open.

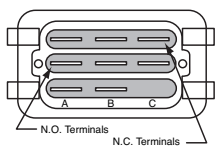

Order No. 31 - 9656

PTO switch replaces Hustler 771476. Corner terminal blank. Red knob.



Order No. 31 - 9660

Plunger interlock switch replaces Hustler 781211. Single pole, snap in mount. Normally open.

Order No. 31 - 9158

Ignition switch kit replaces Hustler 045898.

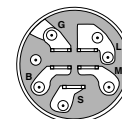

30

O.E.M.

HUSQVARNA / YAZOO/KEES

Over all Length 42-1/2" (1079.50 mm)



Order No. 05 - 8764

Steering cable replaces Husky 5065891-01.



Thread Size 3/16"-24"
OD (Pin) 3/16"
Shoulder Length 7/16"
Total Length 1"

Order No. 05 - 10812

Lower swivel replaces Husqvarna 539-109334. Also fits Yazoo/Kees.

Conduit Length 56"
Inner Wire 59-3/4"



Order No. 05 - 14623

Drive control & cable replaces Husqvarna 5321463-23, 5321845-96 . Fits 22" self-propelled mowers. Flexible inner-wire with spring on end Z-bend on spring.



ID 3-5/8"
OD 4-1/2"



Order No. 05 - 5620

Ring rubber wheel replaces Husqvarna 532-1798-31. Fits many units built since 2002.



Order No. 42 - 14184

Pro-Gear 30-1000 Coupler. Replaces Peerless 771834, Husqvarna 539102164. 9-Spline



ID 1/2"
Width 1-3/8"
Height 5"

Order No. 07 - 6915

Deck Wheel. Replaces Husqvarna 5321054-55. 1-1/2" centered hub, steel bushing.

O.E.M. REPLACEMENT



REPLACEMENT PARTS BREAK-DOWN FOR HUSQVARNA
REPLACEMENT PARTS FOR 38 & 42" SERIES

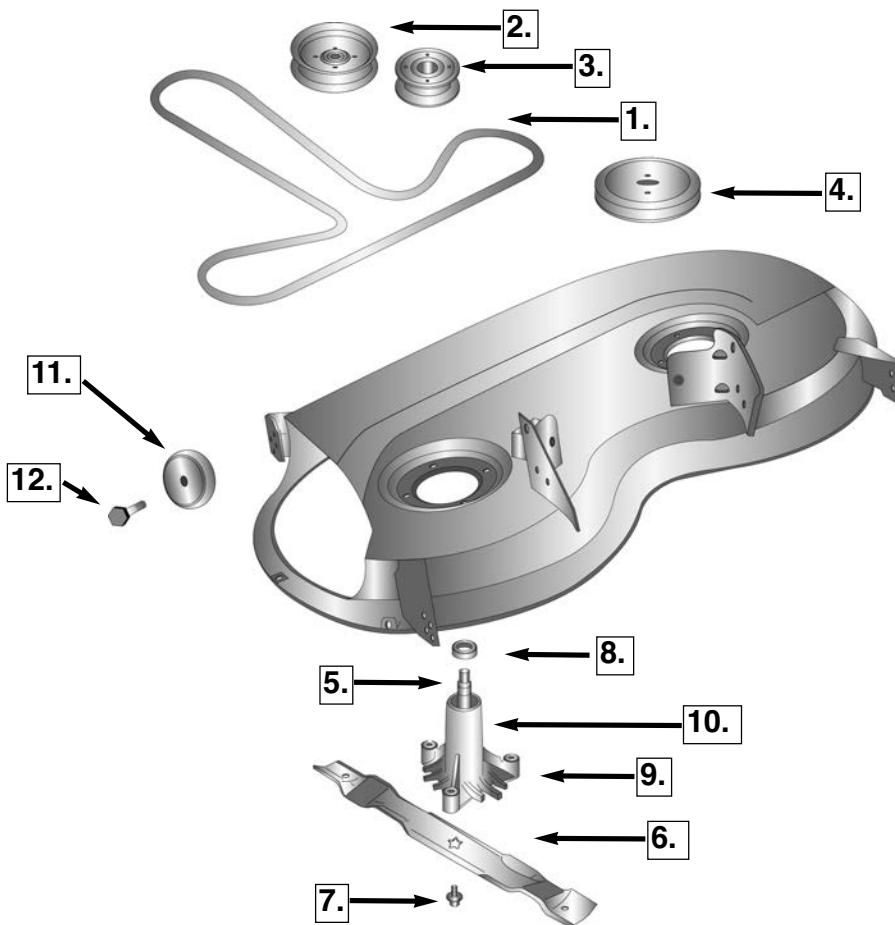

O.E.M. 30

Ref. No.	Order No.	Deck Size	Description/Replaces
1.	12-7531	38"	Belt / 532144200
	12-13501	38"	Belt / 532408381
	12-8516	38" & 42"	Belt / 532144200
	12-9697	42"	Belt / 532144959
	12-10232	42"	Belt / 532174883
	12-13251	42"	Belt / 532429636
	12-12286	42"	Belt / 532405143
	12-11867	42"	Belt / 532197253
2.	13-9376	38" & 42"	Idler / 532173438
	13-11634	38"	Idler / 532177968
	13-13175	42"	Idler / 532196106
3.	13-9376	38" & 42"	Idler / 532173438
	13-11634	38" & 42"	Idler / 532177968
	13-11632	42"	Idler / 532173437
4.	13-9148	38"	Spindle Pulley / 532173435
	13-7180	42"	Spindle Pulley / 532173436
	13-12378	42"	Spindle Pulley / 532195945
5.	10-8479	38" & 42"	Spindle Assm. / 532130794
	10-11590	38" & 42"	Spindle Assm. / 532192870

Ref. No.	Order No.	Deck Size	Description/Replaces
6.	15-6190	38"	Blade / 532134148
	15-6218		Blade / 532138497
	15-12240		Blade / 532193957
	15-6262	42"	Blade / 532134149
	15-6125		Blade / 532138498 / 532138971
	15-12563		Blade / 532139775
7.	17-12280	38" & 42"	Blade Bolt / 532193003
8.	09-8507	38" & 42"	Upper Bearing / 532110485
9.	09-442	38" & 42"	Lower Bearing / 738220419
10.	10-8549	38" & 42"	Spindle Shaft / 532137646
	10-11592	38" & 42"	Spindle Shaft / 532192872
11.	07-6916	42"	Deck Wheel / 532174873 532133957
12.	10-11142	42"	Gage Bolt / 532193406



REPLACEMENT PARTS BREAK-DOWN FOR HUSQVARNA
REPLACEMENT PARTS FOR 46 & 48" DECKS

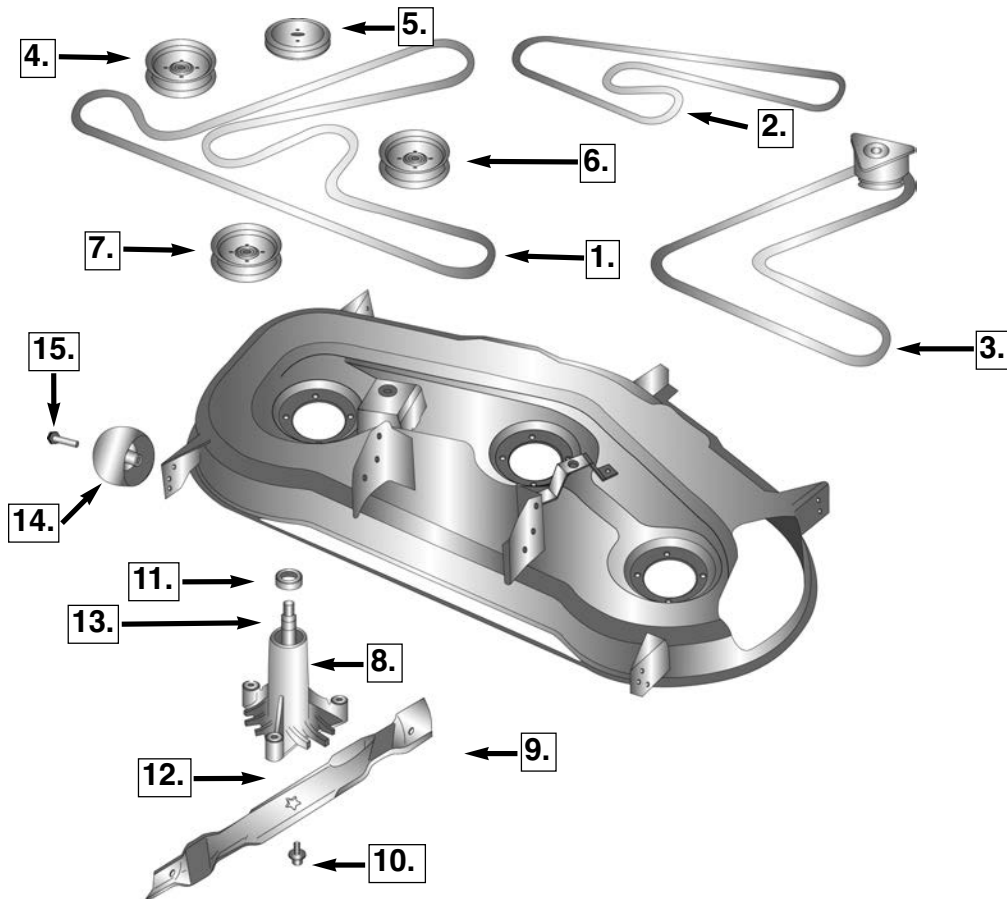

30
O.E.M.

Ref. No.	Order No.	Deck Size	Description/Replaces
1.	12-12286	46"	Belt / 532405143
	12-11864	48"	Belt / 532197242
2.	12-9697	46"	Deck Belt / 532144959
	12-10077	48"	Deck Belt / 532180808
3.	12-9698	46"	Eng. to Deck Belt / 532148763
	12-9368	46"	Eng. to Deck Belt / 532139573
	12-10076	48"	Eng. to Deck Belt / 532174368
4.- 6.	13-12620	46"	Idler/ 532146763
	13-9376	46"	Idler/ 532173438
	13-12661	46"	Idler/ 532173901
	13-11634	46"	Idler/ 532177968
	13-13175	46"	Idler/ 532196106
	13-11632	48"	Idler/ 532173437
	13-11633	48"	Idler/ 532175820
	13-11635	48"	Idler/ 532189993
	13-11634	48"	Idler/ 532177968
	13-13175	48"	Idler/ 532196106

Ref. No.	Order No.	Deck Size	Description/Replaces
7.	13-9121	46"	Spindle Pulley / 532173434
	13-12378	46"	Spindle Pulley / 532195945
	13-7180	48"	Spindle Pulley / 532173436
	13-9148	48"	Spindle Pulley / 532173435
	13-12513	48"	Spindle Pulley / 532174375
8.	13-9519	46"	Spindle Assm./ 532143651
	13-11590	46"& 48"	Spindle Assm./ 532192870
	13-11590		532174356 / 532187292
9.	15-9170	46"	Blade/ 532152443 / 532163819
	15-12974	46"	Blade/ 532403107
	15-12242	46"	Blade/ 532405380
	15-9907	48"	Blade/ 532180054
	15-12475	48"	Blade/ 532173921
10.	17-12280	46"& 48"	Blade Bolt/ 532193003
11.	09-8507	46"& 48"	Upper Bearing / 532110485
12.	09-442	46"& 48"	Lower Bearing / 738220419
13.	10-9520	46"	Spindle Shaft / 532137553
	10-11592	46"	Spindle Shaft / 532192872
	10-12308	48"	Spindle Shaft / 532174360
	10-11592	48"	Spindle Shaft / 532187291
14.	07-6916	46"& 48"	Deck Wheel / 532174873
			532133957
15.	10-11142	42"	Gage Bolt / 532193406



REPLACEMENT PARTS BREAK-DOWN FOR HUSQVARNA

REPLACEMENT PARTS FOR 54" DECK

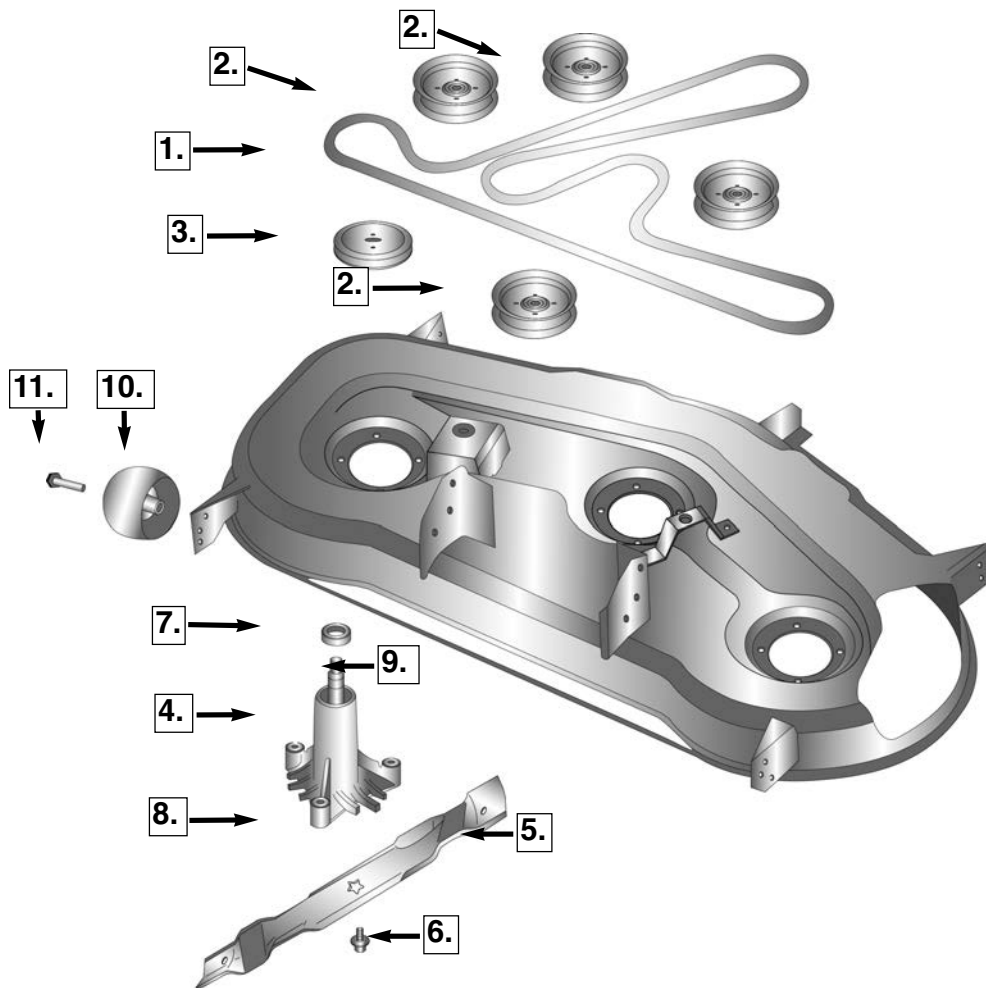

30
O.E.M.

Ref. No.	Order No.	Deck Size	Description/Replaces
1.	12-11863	54"	Belt / 532196103
2.	13-13175	54"	Idler Pulley / 532196106
3.	13-7180	54"	Spindle Pulley / 532173436
4.	10-11590	54"	Spindle Assm. / 532187292
5.	15-13239	54"	Blade / 532187254
	15-11180		Blade / 532187255
	15-12121		Blade / 532187256

Ref. No.	Order No.	Deck Size	Description/Replaces
6.	17-12280	54"	Blade Bolt / 532193003
7.	09-8507	54"	Upper Bearing / 532110485
8.	09-442	54"	Lower Bearing / 738220419
9.	10-11592	54"	Spindle Shaft / 532187291
10.	07-6916	54"	Deck Wheel / 532174873
11.	10-11142	54"	Gage Bolt / 532193406



REPLACEMENT PARTS BREAK-DOWN FOR HUSQVARNA

Zero Turn

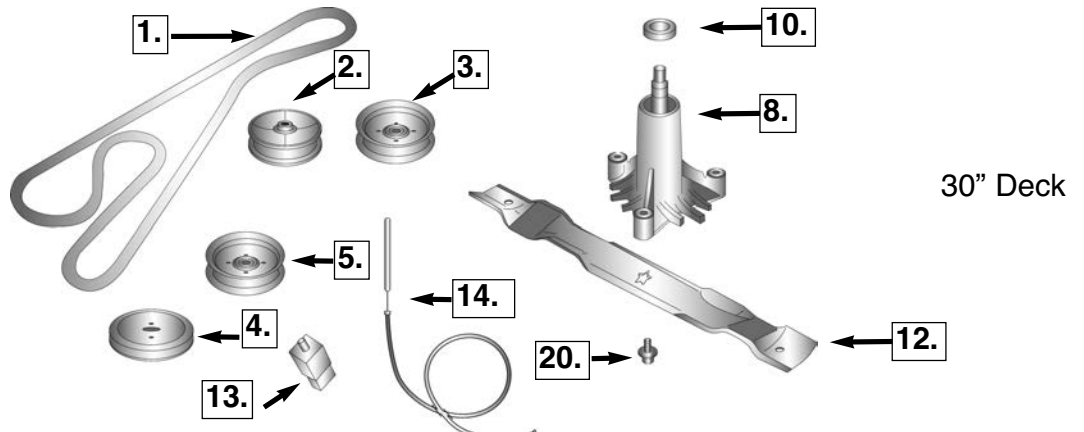

30" Deck

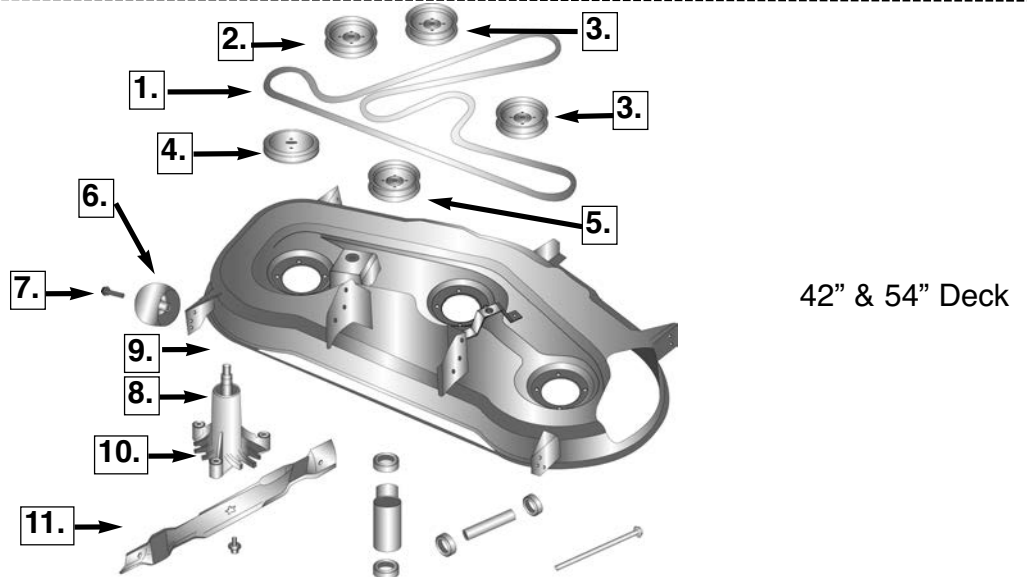

42" & 54" Deck

30

O.E.M.

Ref. No.	Order No.	Deck Size	Description/Replaces	Ref. No.	Order No.	Deck Size	Description/Replaces	
1.	12-7543	30"	Belt / 574173002	7.			Gage Bolt	
	12-11843	42"	Belt / 574173003		8.	10-11590	30" & 42"	Spindle Assm./ 532187292 532192870
	12-7658	42"	Belt / 532999901			10-12734	30" & 42"	Spindle Assm./ 532187292 532192870
	12-12100	54"	Belt / 539114557		10-11014		46"	Spindle Assm./ 532174356
2.	13-12891	42"	Idler Pulley / 539919078	10-11590	54"	Spindle Assm./ 532187292 532192870		
	13-11633	30"	Idler Pulley / 532175820	10-12734	54"	Spindle Assm./ 532187292 532192870		
3.	13-11634	42"	Idler Pulley / 532177968		9.	09-8507		Upper Bearing / 532110485
		46"	Idler Pulley / 539132728	10.	09-442		Lower Bearing / 738220419	
	13-13179	54"	Idler Pulley / 532196106	11.	15-12957	30"	Blade / 532419274	
4.	13-12378	42"	Spindle Pulley / 532195945		15-6262/15-6189	42"	Blade / 532134149	
	13-7180	54"	Spindle Pulley / 532173436	15-12122	42"	Blade / 539112078		
5.	13-12620	30"	Idler Pulley / 532146763 532173902	15-12242	46"	Blade / 532405380		
		42"	Idler Pulley / 539132728	15-13239	54"	Blade / 532187256		
	13-13179	54"	Idler Pulley / 532196106	12.	31-9665		Safety Switch / 532176138	
6.	07-6916	46" & 54"	Deck Wheel / 532133957		13.	05-13380	PTO Cable / 532193235	
				14.	17-12280		Blade Bolt / 532193003	



REPLACEMENT PARTS BREAK-DOWN FOR HUSQVARNA

Zero Turn Series

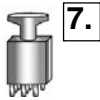
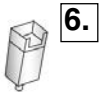
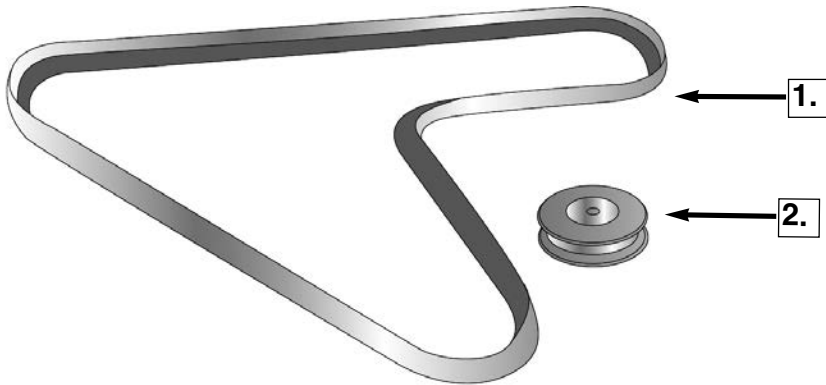

30

O.E.M.

Ref. No.	Order No.	Description/Replaces	Ref. No.	Order No.	Description/Replaces
1.	12-12400	Drive Belt / 539110411	10.		
2.		RH Idler Pulley / AM136693	11.		
3.			12.		
4.			13.		
5.					
6.	31-9659	Switch / 539101080			
7.					
8.	31-9656	PTO Switch / 539101768			
9.					



REPLACEMENT PARTS BREAK-DOWN FOR HUSQVARNA
REPLACEMENT PARTS

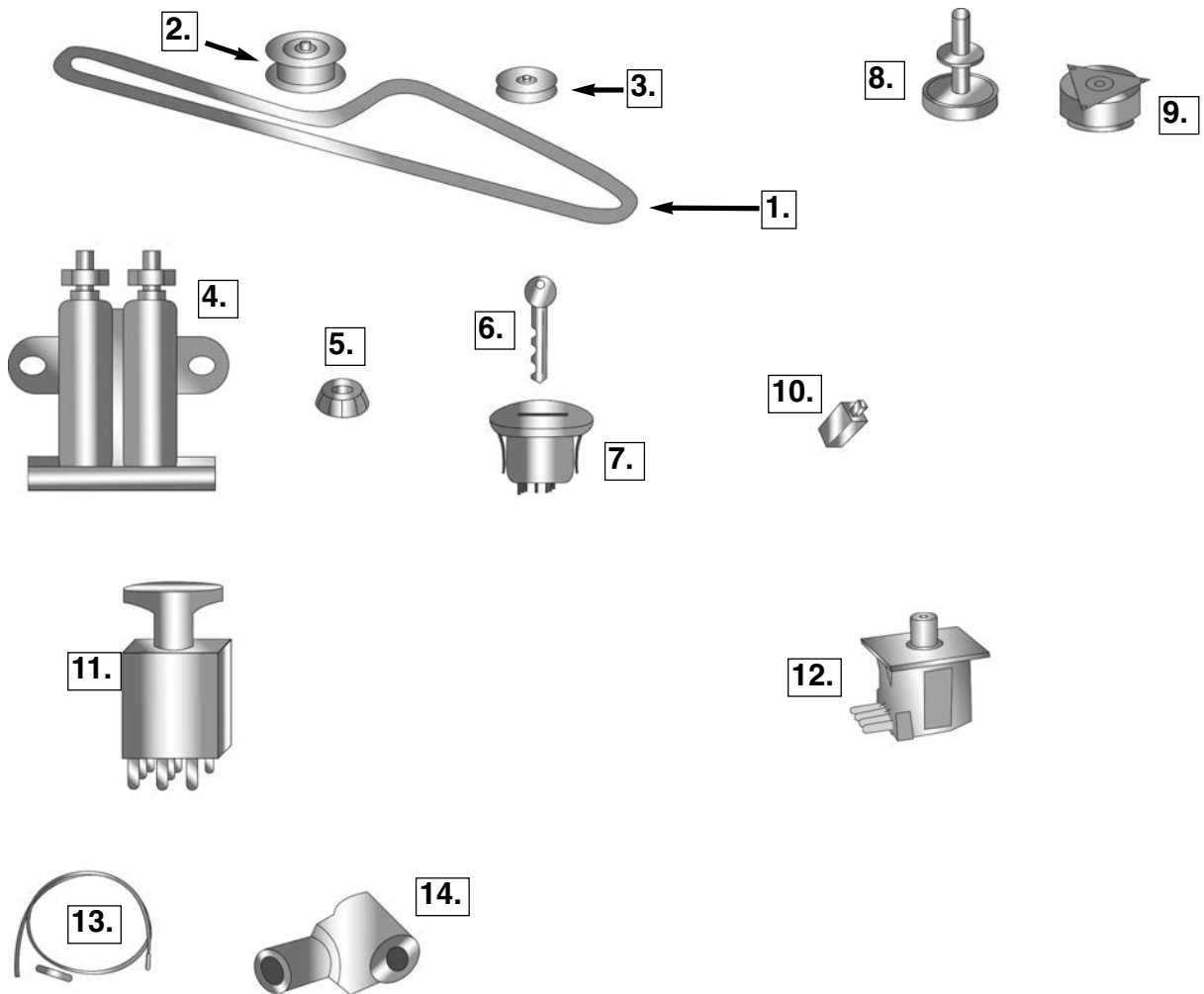

30
O.E.M.

Ref. No.	Order No.	Description/Replaces	Ref. No.	Order No.	Description/Replaces
1.	12-10830 12-9337 12-9336 12-12892 12-8511 12-8781	Belt / 532156971 Belt / 532141416 Belt / 532140294 Belt / 532178138 Belt / 532130969 Belt / 532140218	7.	31-9623 31-12685 31-7015 31-12327	Ignition Switch / 532140301 Ignition Switch / 532163968, 532175566 Ignition Switch / 532193350
2.- 3.	13-9849 13-9376 13-12644 13-13179 13-13178 13-10396	Idler Pulley / 532139245 Idler Pulley / 532131494 Idler Pulley / 532179114 Idler Pulley / 532194327 Idler Pulley / 532194326 Idler Pulley / 532139123	8.		Engine Pulley /
4.	31-14222 31-5933 31-8943	Solenoid / 532192507 Solenoid / 532192507 Solenoid / 532146154	9.	10-9910 10-9912 10-9911 10-12980	Elect. Clutch / 532142600 Elect. Clutch / 532145028 Elect. Clutch / 532160889 Elect. Clutch / 532174367
5.	20-8935 532197725, 532425162	Fuel Cap / 532140527, 6.	10.	31-9665 31-9659	Switch / 532153664, 532176138, 532176137 Switch / 532109553
31-2932	31-11219	Ignition Key / 532122147, 532141226 Ignition Key / 532140401 532411935, 532411933	11.	31-9656	PTO Switch / 532154959 532174651
			12.	31-9664 31-9663 31-12901	Seat Switch / 532121305 Seat Switch / 532160784 Seat Switch / 532401545
			13.	05-10891	PTO Cable / 532175067
			14.	10-13225	Shaft Support / 532124035 532160395

O.E.M. REPLACEMENT



HUSQVARNA / YAZOO/KEES (Cont.)



Order No. 07 - 14035

5" x 1-7/8" x 1/2" bore, deck wheel replaces Husqvarna 532188606.



Order No. 07 - 13495

12" x 1-3/4" hub length, radial tire, 6 spoke rim 1/2" sealed ball bearings, replaces Husqvarna 433499X460. Gray Plastic.

ID 3/4" (19mm)

Height 1-39/64" (25.4mm)



Order No. 09 - 5618

Auger bearing replaces Husqvarna 532-187925. 3-5/8" x 2" flange.



Order No. 10 - 11858

Electric PTO clutch replaces Husqvarna 917063. 1" ID x 6" pulley, A/B Belt type. Warner 5215-14.



Order No. 10 - 12980

Electric PTO clutch replaces Husqvarna 532174367. 1" ID x 6" pulley, 1/2" or 5/8" belt, 3-3/4" height. Warner 5215-134.



Order No. 10 - 11444

Electric PTO clutch replaces Husqvarna 102603. 6-5/16" Dia. Pulley. 5/8" Belt, shaft size 1-1/8". Warner 5218-5



Order No. 10 - 13091

Spindle assembly replaces Husqvarna 918-0429. Also replaces Husqvarna/Yazoo/Kees Spindle Assembly 966956101, 539114820 / 539131383. Fits 52" & 61" decks.

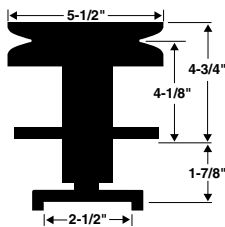

Order No. 10 - 1171

Quill Assembly Replaces Husqvarna 5321014-77. Weight is 3 lb. 14.5 oz. Pulley 5-1/2", Height 6-7/8", OD of Saddle is 3", ID of Saddle is 2-1/2", Clearance 1-7/8".

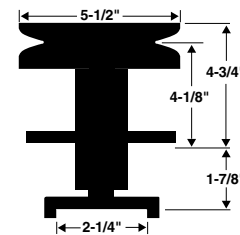

Order No. 10 - 6813

Quill Assembly replaces Husqvarna 5321216-87. Fits 38" & 44" decks.

O.E.M. 30



HUSQVARNA / YAZOO/KEES (Cont.)



Order No.	Description
12 - 10834	Deck Belt. Replaces Husqvarna 539-107709. 5/8" (15.8 mm) x 143-1/2" (3644.9 mm). Fits 48" model CZ 4817. Raw edge, laminated, aramid cord construction.
12 - 11032	Deck Belt. Replaces Husqvarna 539-103687. 5/8" (15.875mm) x 152.1" (3863.6 mm). Fits 48" zero turn riders. Raw edge, laminated, aramid cord construction.
12 - 13442	Deck Belt. Replaces Husqvarna 574845601 . 5/8" (15.87 mm) x 126.85" (3221.4 mm). Fits model YTH2242 & YTH23V42LS, 42" fabricated deck. Wrapped-molded, aramid cord construction, double cover, clutching, white color.
12 - 13443	Deck Belt. Replaces Husqvarna 574845602 . 5/8" (15.87 mm) x 135" (3429 mm). Fits model YTH2648 & YTH24V48LS, 48" fabricated deck. Wrapped-molded, aramid cord construction, double cover, clutching, white color.
12 - 13444	Deck Belt. Replaces Husqvarna 574845603 . 5/8" (15.87 mm) x 143-1/2" (3645 mm). Fits model GTH27V52LS, 52" fabricated deck. Wrapped-molded, aramid cord construction, double cover, clutching, white color.
12 - 14359	Deck Belt. Replaces Husqvarna 532-441597 . 1/2" (12.7 mm) x 72" (1828.8 mm). Fits 30" models PB30 & WELRVBA (532-44-15-97). Aramid cord, dry cover.
12 - 13499	Deck Belt. Replaces Husqvarna 532-429532 . 1/2" (12.7 mm) x 110" (2794 mm). Fits 38" rear discharge models CTH2038, CTH2238. Wrapped molded HAA x 110.0" Aramid cord construction, double cover,clutching-salt /pepper color.
12 - 13501	Deck Belt. Replaces Husqvarna 532-408381 . 1/2" (12.7 mm) x 96.4" (2448.56 mm). Fits 38" side discharge models LT19538, LTH2038. Wrapped molded HA x 96.4" Aramid cord construction, double cover,clutching-white color.
12 - 12686	Drive Belt. Replaces Husqvarna 539-110410 . 1/2" (12.7mm) x 105.1" (2669.5 mm). Aramid cord construction, double cover, semi-dry.
12 - 12653	Drive Belt. Replaces Husqvarna 510-201201 & 106884 . 5/8" (15.875mm) x 159.08" (4040.6 mm). Fits 52" deck models. Raw edge, Aramid cordconstruction, laminated.
12 - 13118	Drive Belt. Replaces Husqvarna & Partner 544 90 84-02 & 506 29 67-02 . Fits K750 cut off saws. Also replaces Shindaiwa 38010-64131 & fits models EC7500, EC7600. 9/16" (14.28mm) x 31.898" (810.2 mm). 6 rib, polyester cord construction.
12 - 13475	Blade Belt. Replaces Husqvarna 539-102549 . 5/8" (15.87 mm) x 143-1/4" (3638.5 mm). Fits 61" Deck, model ZTH6125A. Aramid cord construction, double cover. clutching, color white.
12 - 13476	Blade Belt. Replaces Husqvarna 539-102903 . 5/8" (15.87 mm) x 123-21/64" (3132.5 mm). Fits 52" Deck, model ZTH5223A, ZTH5225A. Aramid cord construction, double cover. clutching, color white.
12 - 10835	Transmission Belt. Replaces Husqvarna 539-107710. 1/2" (12.7 mm) x 64-1/4" (1657.4 mm). Fits 48" model CZ4817. Raw edge, laminated, aramid cord construction.



**O.E.M. REPLACEMENT
HUSQVARNA / YAZOO/KEES (Cont.)**



**Order No.
12 - 13474**

Description

Mule Drive Belt. Replaces Husqvarna **539-102548**. 5/8" (15.87 mm) x 112-1/4" (2851 mm). Fits ZTH5223A, ZTH5225A, ZTH6125A. V-Belt. Aramid cord construction, laminated.

12 - 10949

Pump Belt. Replaces Husqvarna **539-103241**. 1/2" (12.7mm) x 59-15/16" (1522.4 mm). Fits 48" zero turn riders. Also replaces Yazoo/Kees 103241. Raw edge, laminated, aramid cord construction.

12 - 13477

Pump Drive Rib Belt. Replaces Husqvarna **539-102442**. 5/8" (15.87 mm) x 57-15/32" (1459.7 mm). Fits models ZTH5223A, ZTH5225A, ZTH6125A. "K" section, 5 ribs, Neoprene, Polyester cord construction.

12 - 14513

 **Snowthrower Belt.** Replaces Husqvarna **532428454**. 1/2" (12.7 mm) x 29.44" (747.8 mm). Fits models 1827 EXLT, 1830 EXLT Snowthrowers. Wrapped molded, Aramid cord construction, single cover.

12 - 14512

 **Snowthrower Belt.** Replaces Husqvarna **532408019**. 5/8" (15.8 mm) x 38.97" (989.8 mm). Fits models 1130 SBE OV, 11524E, 14527E, 145270 Snowthrowers. Raw edge, Aramid cord construction.

12 - 14116

 **Snowthrower Belt.** Replaces Husqvarna **532408007**. 5/8" (15.8 mm) x 38" (965.2 mm). Fits models PP1150E27, PP208E24, PP208EPS24 Snowthrowers. Raw edge, Aramid cord construction.

12 - 14117

 **Snowthrower Belt.** Replaces Husqvarna **532408010**. 5/8" (15.8 mm) x 37-3/4" (939.8 mm). Fits models 10527SB, 10527SBE, 10530SBE, 1130SBLS, 1130SBE, 5224STE, 924SB, 924SBE, 927SB Snowthrowers. Raw edge, Aramid cord construction.

*Made with KEVLAR® or non-trade marked Aramid fiber.



ID 3/8"
OD 2-1/2"
Height 1"

Order No. 13 - 13622

Idler pulley replaces Husqvarna 532165626. Composite plastic Idler pulley. Belt groove 1/2".



ID 5/8"
OD 5"
Height 1-1/4"

Order No. 13 - 9868

Idler pulley replaces Husqvarna 539102652. Fits mid mount "ZERO TURN" commercial riders. Also replaces Yazoo/Kees 102652.



ID 5/8"
OD 5-3/4"
Height 1-3/4"

Order No. 13 - 12473

Idler pulley replaces Husqvarna 539-103257.



ID 5/8"
OD 5-3/4"
Height 2"















Order No. 13 - 12474

Idler pulley replaces Husqvarna 539-103258.

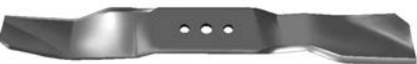
30
O.E.M.



HUSQVARNA / YAZOO/KEES (Cont.)

ORDER NO.	REPLACES O.E.M. NO.	LENGTH	CENTER HOLE DIAM.	OUTSIDE HOLE DIAM.	CENTER TO CENTER	WIDTH	STEEL THICK.	APPLICATION
 15 - 6093	531-00-50-11 506-67-6501 506-6687-01	11-7/8" 304.9mm	.395" 10mm	.330" 8.4mm	2-3/8" 60.3mm	2" 63.5mm	.150" 3.8mm	(3) for 34" cut Fits Husky model 850-12
 15 - 6466	506-6687-01 506-67-6501 531-00-50-11	11-7/8" 304.9mm	.395" 10mm	.330" 8.4mm	2-3/8" 60.3mm	2-1/2" 63.5mm	.187" 4.8mm	Mulching Blade PATENTED
 15 - 50111	5067515-01	13-3/4" 349.25mm	.403" 10.31mm	.331" 8.73mm	2.375" 60.33mm	2.00" 50.80mm	.150" 3.97mm	
 15 - 13333	505544501	14-1/8" 358.8mm	3/8" 9.5mm			2" 50.8mm	.160" 4.06mm	Mulching Blade.
 15 - 50293	 505544601	14-1/8" 359mm	.472" 12mm			2.36" 60mm	.160" 4.06mm	Mulching Blade PATENTED (Export Only)
 15 - 12122	539-112078	14-5/8" 371.5mm	5 point star			2-1/2" 63.5mm	.204" 5.2mm	EZ-Series 4216 & 4217 models (3) blades for a 42" cut.
 15 - 7010	539-1032-74	14-7/8" 377.8mm	5/8" 15.8mm			2-1/2" 63.5mm	.204" 6.2mm	(3) blades for 42" cut. Fits Husqvarna, Yazoo/Kees commercial mowers.
 15 - 13334	504188201	15-1/4" 387.4mm	3/8" 9.5mm			2" 50.8mm	.160" 4.06mm	Mulching Blade.
 15 - 50292	 504190401	15-5/16" 390mm	.472" 12mm			2.36" 60mm	.160" 4.06mm	Mulching Blade PATENTED (Export Only)
 15 - 6489	506-96-63-01	16-3/16" 411.2mm	.972" 24.69mm	.323" 8.2mm	1.899" 48.23mm	2" 50.8mm	.150" 3.8mm	
 15 - 1009	17036 76675	16-1/4" 412.8mm	5/8" 15.9mm	1/4" 6.4mm	1-5/8" 41.3mm	2-1/2" 63.5mm	.150" 3.8mm	(2) blades for 32" cut (3) blades for 48" cut
 15 - 6500	539-100-340	16-1/4" 412.8mm	5/8" 15.8mm			2-1/2" 63.5mm	.204" 5.2mm	(3) blades for 48" cut. Fits Husqvarna, Yazoo, Kees, commercial mowers.















30

O.E.M.

O.E.M. REPLACEMENT
HUSQVARNA / YAZOO/KEES (Cont.)

















30
O.E.M.

ORDER NO.	REPLACES O.E.M. NO.	LENGTH	CENTER HOLE DIAM.	OUTSIDE HOLE DIAM.	CENTER TO CENTER	WIDTH	STEEL THICK.	APPLICATION
 15 - 2172	17036 77378	16-1/4" 412.8mm	5/8" 15.9mm	11/32" 8.7mm	1-5/8" 41.3mm	2-1/2" 63.5mm	.240" 6.1mm	(Heavy Duty) (2) blades for 32" cut (3) blades for 48" cut
 15 - 10172	483011	16-1/4" 412.8mm	5/8" 15.8mm			2-1/2" 63.5mm	.204" 5.2mm	Flat Blade Sharpened - 4-sides
 15 - 6296	483011 76675 77378	16-1/4" 412.8mm	5/8" 15.8mm			2-1/2" 63.5mm	.204" 5.2mm	Mulching Blade PATENTED
 15 - 9967	483011	16-1/4" 412.8mm	5/8" 15.8mm			2" 50.8mm	.240" 6.1mm	Low-Lift Blade Sharpened - 4-sides
 15 - 12123	539-113425	16-1/4" 412.8mm	5 point star			2-1/2" 63.5mm	.204" 5.2mm	EZ-Series 4819 model (3) blades for a 48" cut.
 15 - 13335	504188101	16-1/2" 419.1mm	3/8" 9.5mm			2" 50.8mm	.160" 4.06mm	Mulching Blade.
 15 - 6300	17043	16-1/2" 419.7mm	5/8" 15.9mm			2-1/2" 63.5mm	.204" 5.2mm	Mulching Blade PATENTED
 15 - 50297	 544102701	16-1/2" 420mm	.472" 12mm			2.36" 60mm	.160" 4.06mm	Mulching Blade PATENTED (Export Only)
 15 - 50290	 522449503	17" 430mm	.472" 12mm			2.36" 60mm	.134" 3.4mm	Mulching Blade PATENTED (Export Only)
 15 - 50141	506-88-52	17-1/4" 438.1mm	.405" 10.2mm			2.345" 59.5mm	.204" 5.2mm	(2) blades for 36" cut
 15 - 13367	574870801	17-3/4" 450.8mm	5 point star			2-1/2" 63.5mm	.204" 5.18mm	Mulching Blade Patented. (3) 52" cut
 15 - 13361	574870801	17-3/4" 450.8mm	5 point star			2-1/2" 63.5mm	.204" 5.18mm	(3) 52" cut



HUSQVARNA / YAZOO/KEES (Cont.)

ORDER NO.	REPLACES O.E.M. NO.	LENGTH	CENTER HOLE DIAM.	OUTSIDE HOLE DIAM.	CENTER TO CENTER	WIDTH	STEEL THICK.	APPLICATION
 15 - 50287	 535429401	17-7/8" 431.8mm	1/2" 12.7mm			2.36" 60mm	.204" 5.2mm	Mulching Blade (Export Only)
 15 - 50289	 531211017	18" 457.2mm	.68" 17.3mm			2.25" 57.2mm	.125" 3.2mm	Mulching Blade PATENTED (Export Only)
 15 - 1010	17037 363055	18" 457.2mm	5/8" 15.9mm	1/4" 6.4mm	1-5/8" 41.3mm	2-1/2" 63.5mm	.150" 3.8mm	(2) blades for 36" cut
 15 - 2173	17037 77344	18" 457.2mm	5/8" 15.9mm			2-1/2" 63.5mm	.240" 6.1mm	(Heavy Duty) (2) blades for 36" cut (3) blades for 54" cut.
 15 - 10173	77344	18" 457.2mm	5/8" 15.8mm			2-1/2" 63.5mm	.204" 5.2mm	Flat Blade Sharpened - 4-sides
 15 - 6294	77344 363055 76450	18" 457.2mm	5/8" 15.9mm			2-1/2" 63.5mm	.204" 5.2mm	Mulching Blade PATENTED
 15 - 9968	77344	18" 457.2mm	5/8" 15.8mm			2" 50.8mm	.240" 6.1mm	Low-Lift Blade Sharpened - 4-sides
 15 - 12124	539-112079	18" 457.2mm	5 point star			2-1/2" 63.5mm	.204" 5.2mm	EZ Series 5221 Model (3) blades for a 52" cut.
 15 - 50031	516400500	18-5/8" 473.1mm	.403" 10.2mm	.337" 8.5mm	2.56" 65.02mm	2.50" 63.5mm	.134" 3.4mm	(Export Only)
 15 - 14391	 521981501	18" 457.2mm	5 point star			2.50" 63.5mm	.204" 5.2mm	Mulching Blade PATENTED (3) blades for 54" cut
 15 - 6488	506-96-97-01	18-15/16" 481mm	.950" 24mm	.322" 8.3mm	1.899" 48.2mm	2" 50.8mm	.150" 3.8mm	
 15 - 13498	532427984	19" 482.6mm	5 point star			2-1/4" 57.2mm	.150" 3.8mm	LH Blade. Fits 38" Center rear discharge models CTH2038, CTH2238 CT 151/131.













30

O.E.M.

O.E.M. REPLACEMENT
HUSQVARNA / YAZOO/KEES (Cont.)



30
O.E.M.

ORDER NO.	REPLACES O.E.M. NO.	LENGTH	CENTER HOLE DIAM.	OUTSIDE HOLE DIAM.	CENTER TO CENTER	WIDTH	STEEL THICK.	APPLICATION
 15 - 13500	532427985	19" 482.6mm	5 point star			2-1/4" 57.2mm	.150" 3.8mm	RH Blade. Fits 38" Center rear discharge models CTH2038, CTH2238 CT 151/131.
 15 - 14076	575265901	19" 482.6mm	5/8" 15.8mm			2-1/2" 63.5mm	.240" 6.1mm	Hi-Lift Blade (3) blades for 54" cut Fits PZ series, Zero Turn Riders.
 15 - 14077	574481101	19" 482.6mm	5/8" 15.8mm			2-1/2" 63.5mm	.240" 6.1mm	Low-Lift Blade (3) blades for 54" cut Fits PZ series, Zero Turn Riders.
 15 - 14078	525525901	19" 482.6mm	5/8" 15.8mm			2-1/2" 63.5mm	.240" 6.1mm	Mulching Blade (3) blades for 54" cut Fits PZ series, Zero Turn Riders.
 15 - 50294	 544175701	19-1/8" 482mm	.472" 12mm			2.36" 60mm	.240" 6.1mm	Mulching Blade (Export Only)
 15 - 6299	539-10-1733	21" 533.4mm	5/8"			2-1/2" 63.5mm	.204" 5.2mm	Commercial Mulching Blade
 15 - 10720	539-10-17-33	21" 533.4mm	5/8" 15.9mm			2-1/2" 63.5mm	.204" 5.2mm	(3) blades for a 61" cut.
 15 - 12125	539-113312	21" 533.4mm	5 point star			2-1/2" 63.5mm	.204" 5.2mm	EZ-Series, 6124 model (3) blades for a 61" cut.
 15 - 14392	 521981601	21" 533.4mm	5 point star			2.50" 63.5mm	.204" 5.2mm	Mulching Blade PATENTED (3) blades for 61" cut
 15 - 50291	 544175801	22-3/16" 558.8mm	.489" 12.4mm			2.362" 60mm	.240" 6.1mm	Mulching Blade (Export Only)

Blade Bolt with Washer for AYP

Order No. 17 - 14457

Blade bolt with washer replaces Husqvarna 532-1930-03. Fits our 10-11014, 10-11590 & 10-12734 spindle assemblies. 1-1/4" x 7/16"-20.





HUSQVARNA / YAZOO/KEES (Cont.)



Order No. 20 - 9561

Oil cap replaces Husqvarna 501765602.



Order No. 20 - 9562

Fuel cap replaces Husqvarna 501819602 & 537215202. Fits models 234 & 238.



Order No. 20 - 13363

Fuel cap replaces Husqvarna 501-43-14-02. Fits saw models 225, 266, 268, 272, 44, 61, 66, 298, 2100, 2101.



Order No. 20 - 12982

Premium .094" x .203" fuel line, .054 wall thickness. Replaces Husqvarna. 25 foot box, color yellow.



Order No. 22 - 13285

Carburetor replaces Husqvarna 503-28-10-19, 503-17-32-01, Walbro HDA-98. Fits 42, 238, 242, 246 chainsaws.



Order No. 22 - 13286

Carburetor replaces Husqvarna 503-28-13-20, 503-10-03-03, Walbro WT-99. Fits 40 & 244 chainsaws.



Order No. 22 - 13287

Carburetor replaces Walbro HDA-86, Husqvarna 503-28-10-16. Fits PS50, 51, 250R, 250RX clearing saw/brush cutter.



Order No. 25 - 7290

Starter Handle. Replaces Husqvarna 50354-39-01, 5015514-02. Fits model 40 chain saw.



Order No. 26 - 13473

Electric starter replaces Kawasaki 21163-7035, 21163-7024, 21163-7034. Fits FR391V-AS04 engines. Used on Cub Cadet zero-turn mowers. Also fits Husqvarna LGTH2454.



Order No. 26 - 13533

Recoil spring replaces Husqvarna 503-85-99-01. Fits models 333, 335, 340, 345, 346, 350, 351, 3536.

Order No. 26 - 13584

Recoil spring replaces Husqvarna 537-09-31-01. Fits models 340, 345, 346, 350, 351, 353, 357, 359, Jonsered models CS2141, CS2145, CS2150.



30

O.E.M.



O.E.M. REPLACEMENT
HUSQVARNA / YAZOO/KEES (Cont.)

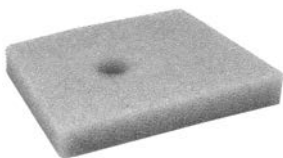

Length 2-1/4"
 Width 1-7/8"
 Height 3/8"

Order No. 27 - 12520

Air filter replaces Husqvarna 537186301. Fits models 123, 223, 322, 323, 325 & 326 trimmers. MIN005



Order No. 27 - 30055

10mm x 1.25mm LHF counter sunk arbor bolt. Fits European made straight shaft trimmers.



Order No. 31 - 13349

Neutral start switch replaces Husqvarna 786201. Transmission neutral start switch.



Order No. 31 - 14222

Solenoid starter replaces Husqvarna/AYP 192507. No hardware, 1/4" terminal studs.

Piston Ring Assembly Tool for HUSQVARNA



Order No. 32 - 14626

Piston ring assembly tool kit. Replaces Husqvarna 502-50 70-01. Useful for assembling pistons and cylinders on chainsaws. 4 sizes of clamps. Give yourself a third hand with this kit. This kit will compress piston rings ranging from 30mm to 60mm in diameter. Includes a piston support block and piston stop.



Order No. 35 - 10840

14" Bar & Chain Combination fits Echo, Homelite, Husqvarna, & Poulan.

Order No. 35 - 10828

16" Bar & Chain Combination fits Echo, Homelite, Husqvarna, & Poulan.



Order No. 35 - 13330

GB UHL 18-50SH bar used on Husqvarna & Jonsered mid size chainsaws. 18 x .325 x .050, 72DL.



Order No. 36 - 10819

.325 x 7 Tooth chain saw sprocket. Fits Husqvarna models 340, 345, 350, 351, & 346XP.



Order No. 36 - 13585

Rim sprocket replaces Husqvarna 503-9800-71. Fits models 340, 345, 346XP, 350, 351, 353 & Jonsered models 2141, 2145, 2149, 2150, 2151, 2152, 2159, 2245, 2250.



Order No. 37 - 13056

Recoil spring replaces Husqvarna 506-25-89-01. Fits models K750 & K960 cut off saws.

30

O.E.M.



HUSQVARNA / YAZOO/KEES (Cont.)



Order No. 38 - 9227

Fuel filter replaces Husqvarna 503-443-201. Fits husky models 36, 40, 41, 42, 45, 50, 51, 61, 66 & 394 Pro. Also fits Poulan Pro saws. MIN005



Order No. 39 - 13588

Starter pulley replaces Husqvarna 506016401 & 537201901. Fits models 40, 45 & 335 XPT.



Order No. 39 - 13095

Starter pulley replaces Husqvarna 537-09-25-01. Fits models 340/345/346/350/45, 350, 351, 353, 445, 455, 460, 2141, 2149.



Order No. 39 - 13586

Chain adjuster kit replaces Husqvarna 537044102. Fits models 362XP, 365, 372, 385, 570, 575, 576.



Order No. 39 - 12629

Piston & Cylinder set replaces Husqvarna 503-609171. Fits Husqvarna model 51.



Order No. 39 - 12630

Piston & Cylinder set replaces Husqvarna 503-611071. Fits Husqvarna model 268 (50mm) cylinder made after 1991.



Order No. 39 - 12631

Piston & Cylinder set replaces Husqvarna 503-609108 & 503-609102. Fits Husqvarna model 55.



Order No. 39 - 12632

Piston & Cylinder set replaces Husqvarna 503-758172 & 503-758171. Fits Husqvarna model 272 & 272XP.



Order No. 39 - 13015

Cylinder & Piston Assembly replaces Husqvarna 506-15-55-06. Fits K950.



Order No. 39 - 13616

Cylinder & Piston assembly replaces Husqvarna 503-69-10-73, 503-93-90-03, 503-93-90-05, 48mm. Fits model 365. Includes piston, cylinder, rings, pin & clips. Also replaces Jonsered model 2165.

30

O.E.M.

O.E.M. REPLACEMENT



HUSQVARNA / YAZOO/KEES (Cont.)



Order No. 39 - 10778

Air filter replaces Husqvarna 503-81-45-03. Fits models 365 & 371 chainsaws.



Order No. 39 - 12485

Air filter replaces Husqvarna 530-029811. Fits Chain Saw models 136, 137, 141, 142, 36, 41.



Order No. 39 - 10779

Air filter replaces Husqvarna 506-26-34-01. Fits models 371K Cut-off saws.



Order No. 39 - 11588

Stop switch assembly replaces Husqvarna 503-08-97-021 / 503-71-79-01. Fits models 36 / 41 / 50 / 51 / 55 / 61 / 266 / 268 / 272 / 340 / 345 / 394 / 395.



Order No. 39 - 13132

Pre-filter replaces Husqvarna 506269101. Fits models K371 & K375 Pre-oiled.



Order No. 39 - 13133

Pre-filter replaces Husqvarna 506268601. Fits 3120K pre-oiled.



Order No. 39 - 9919

Piston ring replaces Husqvarna 5032890-11. Fits Husqvarna 254-254XP chain saw. Used with our 39-9638 piston assembly.

Order No. 39 - 9917

Piston ring replaces Husqvarna 5016998-01/503289017. Fits Husqvarna 266-266XP chain saw. Used with our 39-8339 piston assembly.

Order No. 39 - 9918

Piston ring replaces Husqvarna 5032890-05. Fits Husqvarna 242-242XP chain saw. Used with our 39-9637 piston assembly.



Order No. 39 - 12887

Filter replaces Husqvarna 506367202. Fits K750 cut off saws.



Order No. 39 - 12888

Pre-Filter replaces Husqvarna 506367101. Fits K750 cut off saws. Used with our 38-12887 filter.



Length 10-3/4"
Width 5-1/2"
Height 13/16"

Order No. 39 - 12516

Pre-filter replaces Husqvarna 506231901. Fits models K950 & K960 Active.



Order No. 41 - 5541





Shear Pin and Nut replaces Husqvarna 531002513 & 506714001. MIN005

30

O.E.M.



ISEKI

 15 - 50062	FM-041-40	410 mm 410 mm	.79" 20.24mm			2.25" 57.15mm	.187" 4.76mm	(Export Only)
 15 - 50063	8595-306-06-10-0	16-27/32" 427.8 mm	.554" 14.29mm			2.0" 50.80mm	.150" 3.97mm	(Export Only)
 15 - 11312	2500-220-0001-00	20-5/8" 523.9mm	.985" 25mm	.530" 13.5mm	3-1/2" 88.9mm	2-1/4" 57.2mm	.160" 4.1mm	(Export Only)
 15 - 13593	3495550M4	24-3/4" 628.7mm	.792" 20mm			2-1/2" 63.5mm	.295" 7.5mm	Fits SF300,330, 303, 333 & TM217 Tractors W/SSM 72 Deck 1999 - up. (3) Blades for a 72" cut.

30

O.E.M.

O.E.M. REPLACEMENT



REPLACEMENT PARTS BREAK-DOWN FOR JOHN DEERE

REPLACEMENT PARTS FOR 42" 100 SERIES

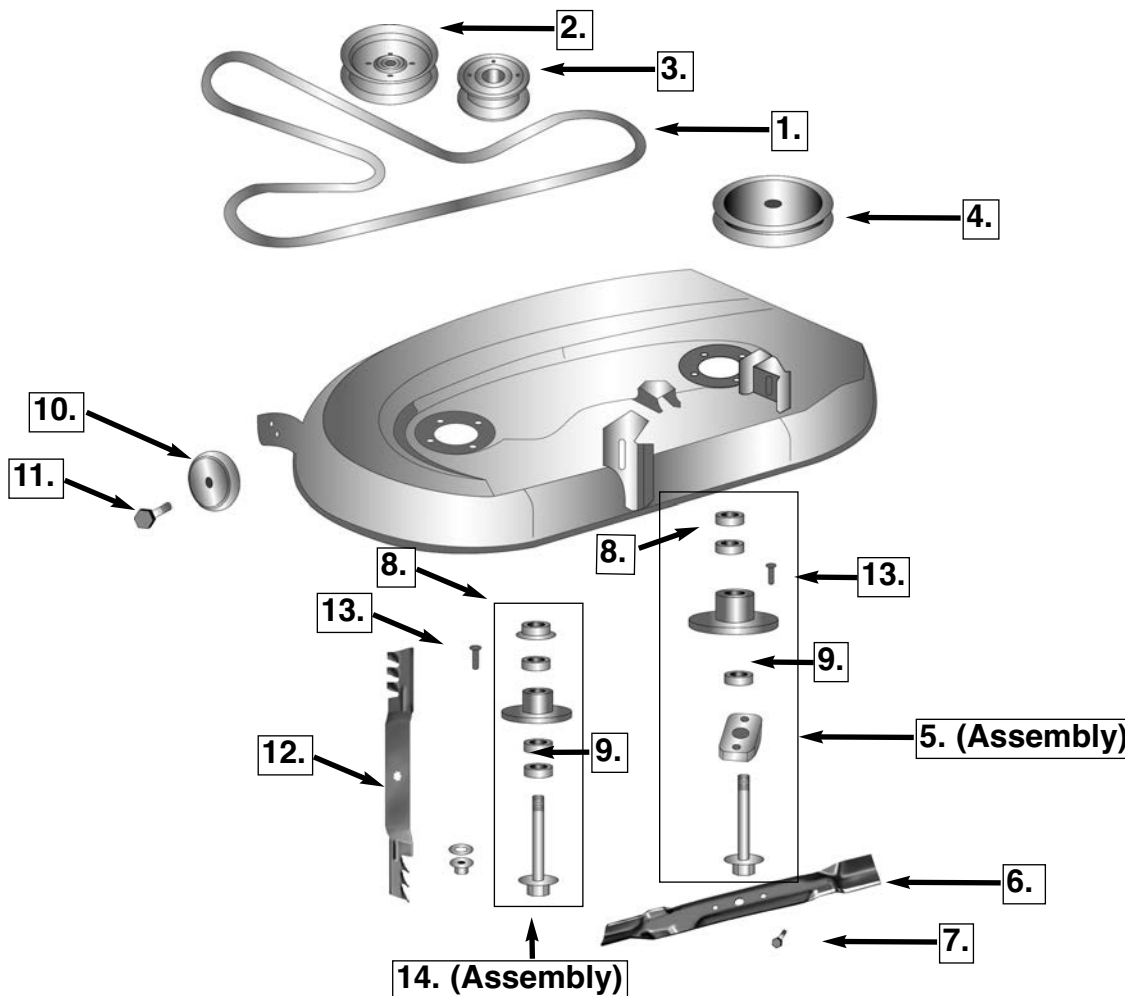

O.E.M. 30

Ref. No.	Order No.	Deck Size	Description/Replaces
1.	12-10436	42"	Belt / GX20072
2.	13-11207	42"	Idler Pulley / GY20629
	13-10737	42"	Idler Pulley / GY20110
3.	13-10741	42"	Idler Pulley / GY20067
4.	13-11449	42"	Spindle Pulley / GY20367
5.	10-11206	42"	Spindle Assembly / GY20785a
6.	15-10635	42"	Blade / GX20249
7.		42"	Bolt / 19M7786
8.	09-8198 09-1265 09-8831	42"	Bearing / GX20818

Ref. No.	Order No.	Deck Size	Description/Replaces
9.	09-8198 09-1265 09-8831	42"	Bearing / GX21510 (Same as above less 1-Seal) (Same as above less 1-Seal)
10.	07-11819	42"	Gauge Wheel / GX10168
11.		42"	Deck Wheel Bolt / GX21012
12.	15-11593	42"	Blade / GX22151
12.	15-11594	42"	Mulching Blade / GX22151
13.		42"	Screw / GX20234
14.	10-12910	42"	Spindle Assembly / GY21098
15.		42"	Blade Nut / GX21694



REPLACEMENT PARTS BREAK-DOWN FOR JOHN DEERE

REPLACEMENT PARTS FOR 48" 100 SERIES

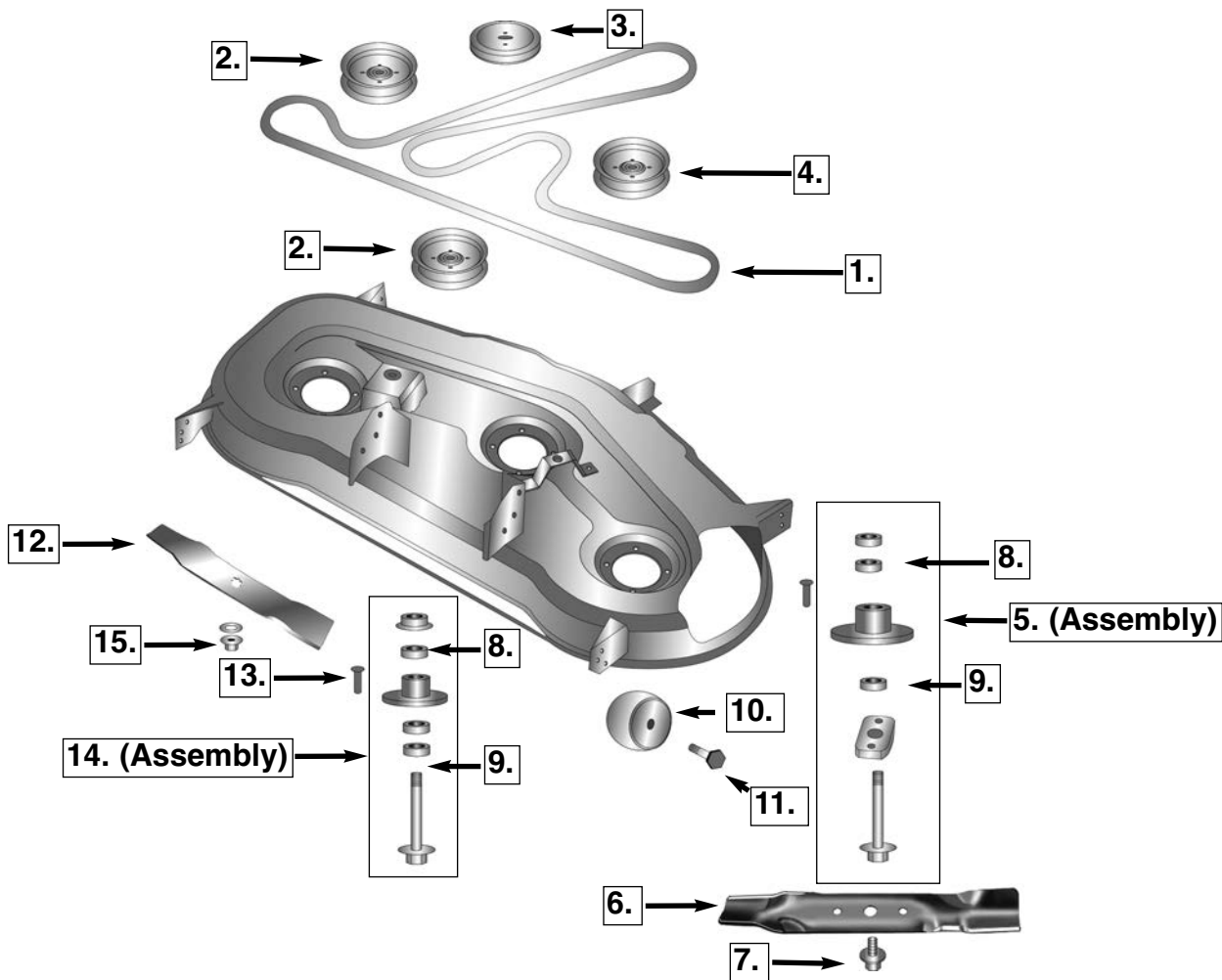

30

O.E.M.

Ref. No.	Order No.	Deck Size	Description/Replaces
1.	12-10437	48"	Belt / GX20305
	12-12461	48"	Belt / GX21833
2.	13-11207	48"	Idler Pulley / GY20629
	13-10737	48"	Idler Pulley / GY20110
3.	13-10741	48"	Idler Pulley / GY20067
4.		48"	Spindle Pulley / M155979
5.	10-11206	48"	Spindle Assembly / GY20785a
6.	15-10634	48"	Blade / GX20250
		48"	Blade / GX20819
7.		48"	Blade Bolt / 19M7786
8.	09-8198	48"	Bearing / GX20818 (Same as above less 1-Seal) (Same as above less 1-Seal)
	09-1265		
	09-8831		

Ref. No.	Order No.	Deck Size	Description/Replaces
9.	09-8198	48"	Bearing / GX21510 (Same as above less 1-Seal) (Same as above less 1-Seal)
	09-1265		
	09-8831		
10.	07-11819	48"	Gauge Wheel / GX10168
11.		48"	Deck Wheel Bolt / GX21012
12.	15-11595	48"	Blade / GX21784
	15-11596	48"	Blade / GX21786
13.		48"	Screw / GX20234 & GX22456
14.	10-12910	48"	Spindle Assembly / GY21098
15.		48"	Blade Nut / GX21694

O.E.M. REPLACEMENT



REPLACEMENT PARTS BREAK-DOWN FOR JOHN DEERE

REPLACEMENT PARTS FOR 54" 100 SERIES

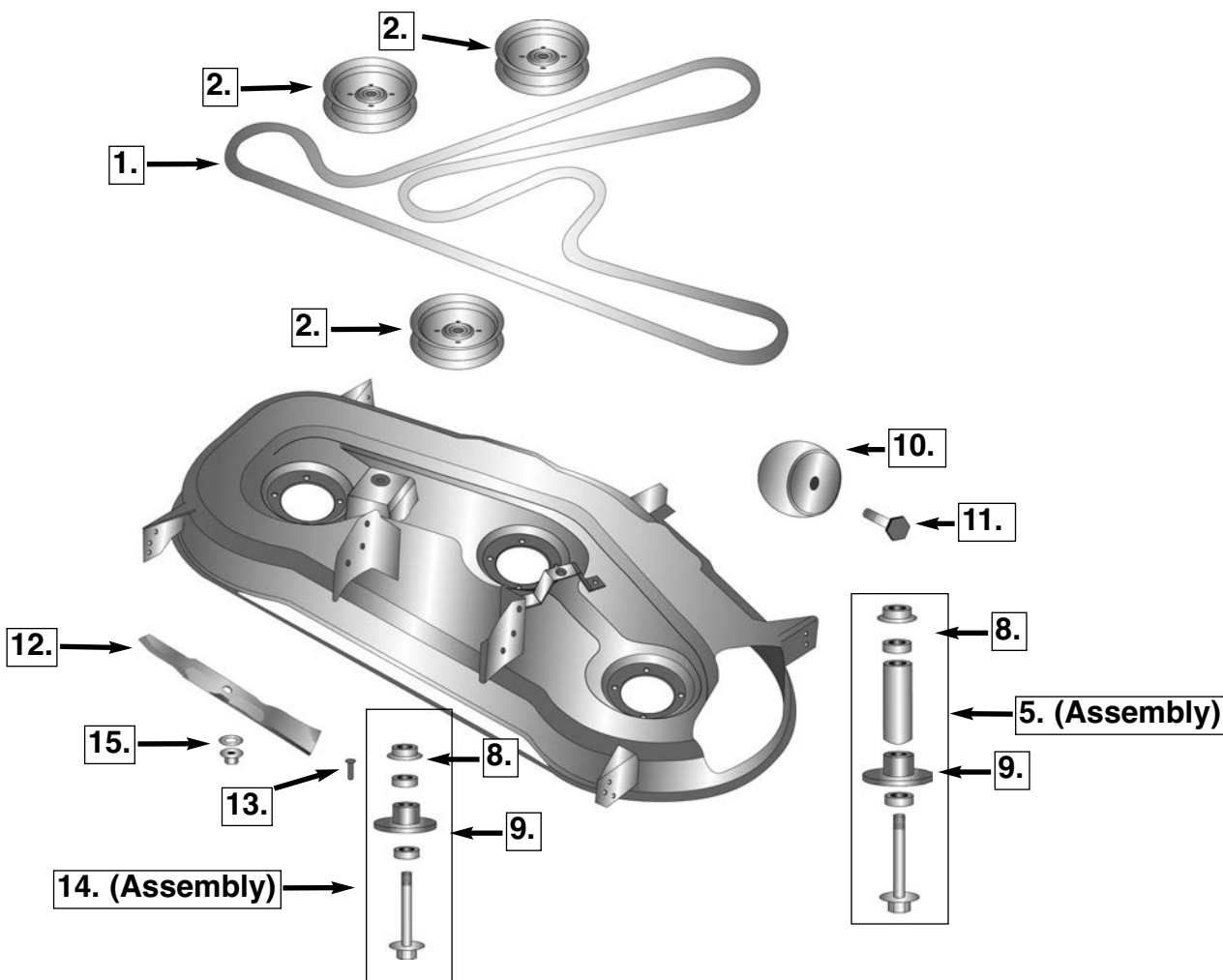

O.E.M. 30

Ref. No.	Order No.	Deck Size	Description/Replaces
1.		54"	Belt / GX21395
2.	13-11207	54"	Idler Pulley / GY20629
5.	10-12495	54"	Spindle Assembly / GX21099
8.	09-8198 09-1265 09-8831	54"	Bearing / GX20818 (Same as above less 1-Seal) (Same as above less 1-Seal)
9.	09-8198 09-1265 09-8831	54"	Bearing / GX21510 (Same as above less 1-Seal) (Same as above less 1-Seal)

Ref. No.	Order No.	Deck Size	Description/Replaces
10.	07-11819	54"	Gauge Wheel / GX10168
11.		54"	Deck Wheel Bolt / GX21012
12.	15-11491	54"	Blade / GX21380, GY20679 GY20684
13.		54"	Screw / GX20234 & GX22456
14.	10-12495	54"	Spindle Assembly / GY20867
15.		54"	Blade Nut / GX21694



REPLACEMENT PARTS BREAK-DOWN FOR JOHN DEERE

REPLACEMENT PARTS FOR L-100 SERIES

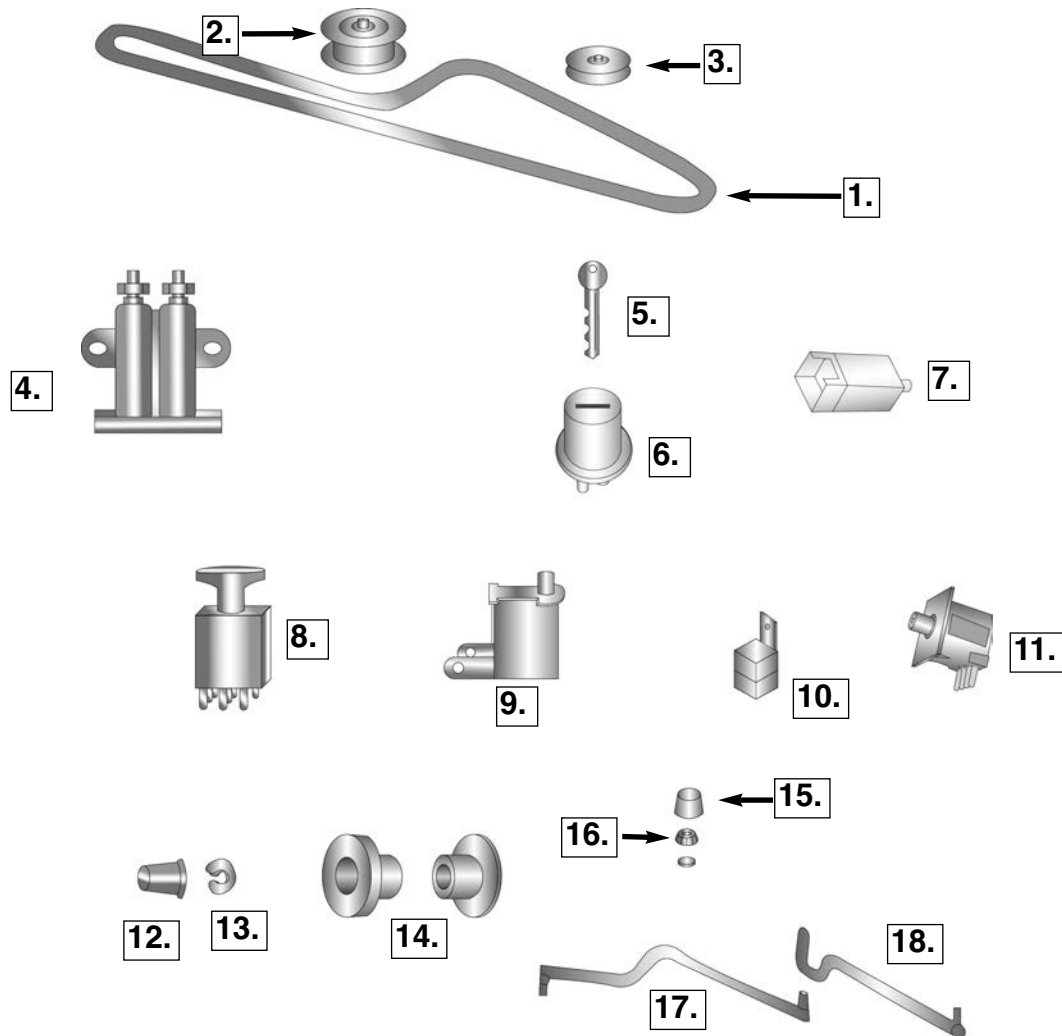

30

O.E.M.

Ref. No.	Order No.	Description/Replaces
1.	12-10435	Belt - Gear / GX22036
	12-10434	Belt - Hydro / GX20006
2.	13-9544	Flat Idler Pulley / GX20287
3.	13-10738	V-Idler Pulley / GX20286
4.	31-10677	Solenoid / AM133094, AM138497
5.	31-11219	Key / GY20680
6.	31-12685	Ignition Switch / GY20074
	31-7015	
7.	31-9662	Safety Switch / GY20094
8.	31-9657	PTO Switch / AM131966, GY20939

Ref. No.	Order No.	Description/Replaces
9.		Safety Switch / GY20157
10.		Relay Switch / AT75769, GY20437
11.		Safety Switch / GY20073
12.		Hub Cap / M143338
13.	02-78	HD E-Clip / R27434
14.	09-13359	Frnt. Wheel Bearing / M123811
15.		Steering Bushing / GX21994
16.		Pinion Gear / GX20053
17.	10-13440	LH Drag Link / GY21250, GY20491
18.	10-13441	RH Drag Link / GY21251, GY20492

O.E.M. REPLACEMENT



REPLACEMENT PARTS BREAK-DOWN FOR JOHN DEERE

REPLACEMENT PARTS FOR 42" & 48" ZTR SERIES

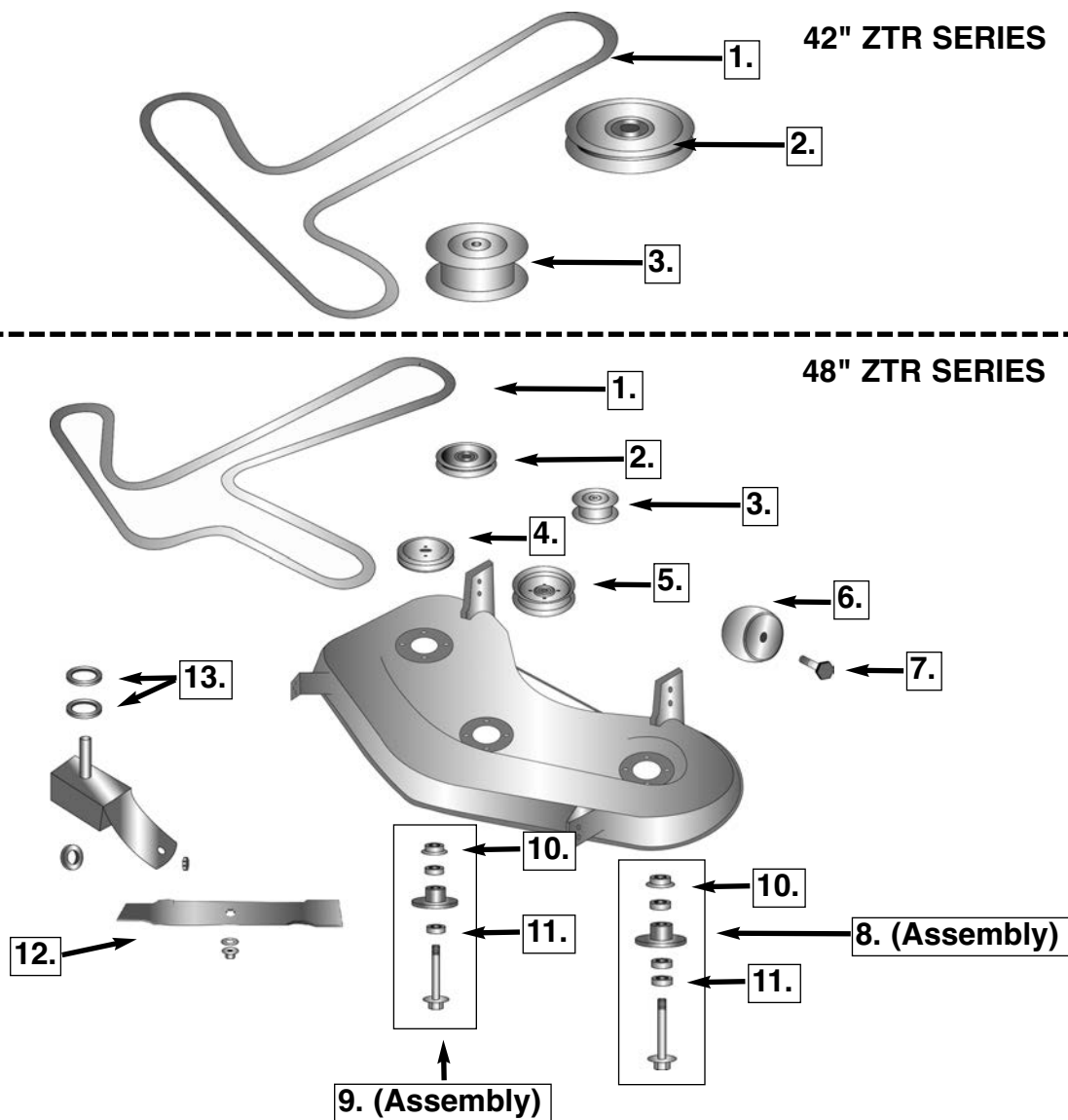

30

O.E.M.

Ref. No.	Order No.	Deck Size	Description/Replaces
1.	12-12560	42"	Belt / M154294
		48"	Belt / M154621
		48"	Belt / M158130
2.			RH Idler Pulley / AM136693
3.	13-11207	42"	Adj. Idler Pulley / GX20286
		48"	Adj. Idler Pulley / AM128118
4.	13-11448	48"	Spindle Pulley / M155979
5.		48"	LH Fixed Idler / AM135526
6.	07-11819	42" 48"	Deck Wheel / GX10168
7.		42" 48"	Wheel Bolt / GX21012.
8.	10-13234	42"	Spindle Assem. / AM136733
9.		48"	Spindle Assem. / AM137483

Ref. No.	Order No.	Deck Size	Description/Replaces
10.	09-8198 09-1265 09-8831	42" 48"	Bearing / GX20818 (Same as above less 1-Seal) (Same as above less 1-Seal)
11.	09-8198 09-1265 09-8831	42" 48"	Bearing / GX21510 (Same as above less 1-Seal) (Same as above less 1-Seal)
12.	15-11593 15-11594	42"	Blade / AM137333
		42"	Mulching Blade / AM137328
		42"	Bagging Blade / AM137329
	15-11595	48"	Blade / AM137333
	15-11596	42"	Mulching Blade /
		42"	Bagging Blade /
13.			Caster Bearing. / AM102888, AM131046, AM137758



REPLACEMENT PARTS BREAK-DOWN FOR JOHN DEERE

REPLACEMENT PARTS FOR UP TO 100000 & 100001 + ABOVE ZTR SERIES

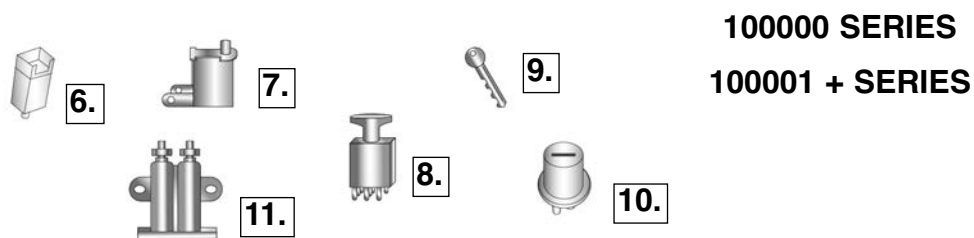
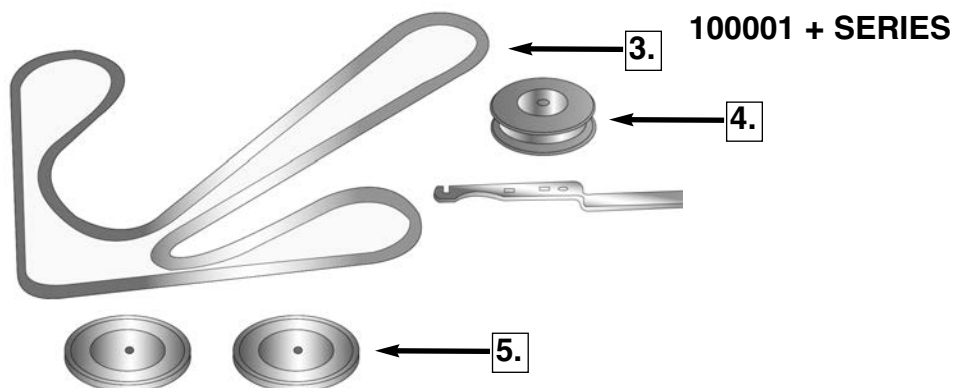
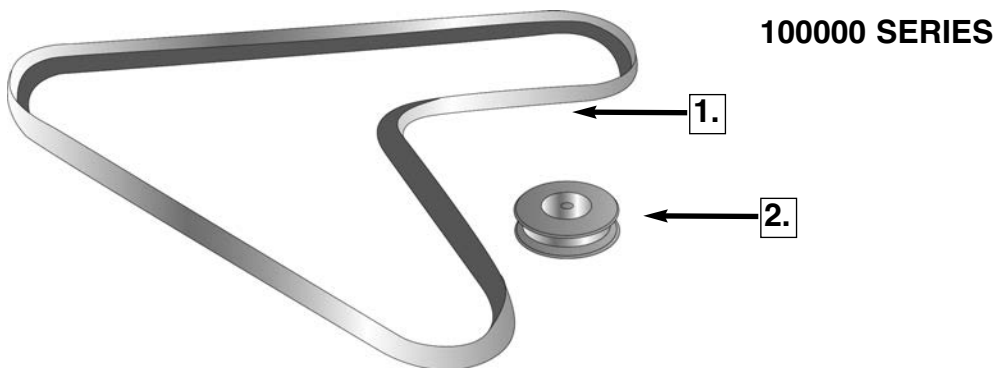

30

O.E.M.

Ref. No.	Order No.	Description/Replaces	Ref. No.	Order No.	Description/Replaces
1.	12-5903 12-7503	Belt / M155343	7.		Seat Switch / AM131968
2.		Idler Pulley / AM115459	8.	31-9657	PTO Switch / AM131966
3.		Belt / M160571	9.	31-12128	Key / AM125504
4.		Idler / AM115460	10.	31-10723	Starter Switch / TCA15075
5.	13-12419	Idler / AM106627	11.	31-10677 31-10772	Solenoid / AM138497
6.	31-9662	Brake Switch / GY20094			

O.E.M. REPLACEMENT
JOHN DEERE



Conduit 43"
Inner Wire 46"
Wire Travel 3"



Order No. 05 - 14622

Shift cable replaces John Deere GC00578 and AM107139.
Fits 21" walk behind mowers JA65, JE75, JX75 & JX85.



ID 3"
OD 6"

Order No. 05 - 300

Drive Disc replaces John Deere 122115.



ID 2-1/4"
OD 4-7/16"

Order No. 05 - 7018

Driven Disc. Replaces John Deere AM123355. Fits 21" SP mowers.



Order No. 42 - 7097

Gear Box Assembly. Replaces John Deere PT8640. (12.5 to 1 Gear Ratio).



Width 2"
Height 5"

Order No. 07 - 10724

Deck wheel. Replaces John Deere M111489. Used in our 07-10250 wheel kit.



ID 1/2"
Width 1-1/4"
Height 4"

Order No. 07 - 6913

Deck Wheel replaces John Deere M81716. 1-13/32" centered hub.



ID 1/2"
Width 1-1/2"
Height 4"

Order No. 07 - 6914

Deck Wheel replaces John Deere M89339. 1-1/2" offset hub.



ID 1/2"
Width 1-3/8"
Height 5"

Order No. 07 - 6915

Deck Wheel replaces John Deere AM33718. 1-1/2" centered hub, steel bushing.



ID 1/2"
Width 1-3/8"
Height 6"

Order No. 07 - 6918

Deck Wheel replaces John Deere AM32639. 1-1/2" centered hub.

30

O.E.M.



JOHN DEERE (Cont.)



ID 9/16"
Width 1-1/2"
Height 6"

Order No. 07 - 8244

Deck wheel replaces John Deere AM107560. Used on 48", 54", 60" and 72" mower decks. 1-7/8" centered hub. Comes complete with roller bearing, reducer bushing, spacers and zerk fitting.



ID 17/32"
Width 1-3/8"
Height 5-3/4"

Order No. 07 - 3320

Deck Wheel. Replaces John Deere 32639. 1-3/8" offset hub.



ID 5/8"
Width 2"
Height 5"

Order No. 07 - 11819

Deck wheel replaces John Deere GX10168. Fits L100 & G100 series riders.



ID 11/16"
Width 3"
OD 2-17/32"

Order No. 07 - 13279

Deck roller replaces John Deere M113955.



ID 1/2"
Width 2-3/4"
Height 5"

Order No. 07 - 6916

Deck Wheel replaces John Deere M84690. 2-1/2" offset hub.



ID 5/8"
Width 2"
Height 8"

Order No. 07 - 8216

Deck wheel replaces JD AM107561. Used on 60" & 72" front cut and 50", 60" & 72" standard decks. 2-7/16" centered hub. Complete with roller bearing, reducer bushing, spacers and zerk fitting.



ID 17/32"
Width 2"
Height 5"

Order No. 07 - 8214

Deck wheel replaces John Deere AM104126. Used on 50", 60" and 72" front cut mowers. 2-7/16" centered hub. Comes complete with roller bearing, reducer bushing, spacers and zerk fitting.



ID 5/8"
Width 2"
Height 6"

Order No. 07 - 8215

Deck wheel replaces John Deere AM107558. Used on 60" and 72" front cut mowers. 2-7/16" centered hub. Comes complete with roller bearing, reducer bushing, spacers and zerk fitting.



ID 5/8"
Width 2"
Height 5"

Order No. 07 - 10250

Wheel kit replaces John Deere AM116299. Fits John Deere riders with 38" and 48" deck. Includes bushings and hardware. Uses 8mm bolts.



ID 5/8"
Width 3-7/8"
Height 3-13/16"

Order No. 07 - 8224

Deck wheel replaces John Deere M115245. Used on all 48", 54" and 60" cut mid size walk behinds and tractors. 3-7/8" centered hub.

30

O.E.M.

**O.E.M. REPLACEMENT
JOHN DEERE (Cont.)**



Order No. 08 - 8551

Caster wheel replaces John Deere AM101589. 11 x 400 x 5, 2 ply smooth tread tubeless tire, 1 piece rim, 5" centered hub, 3/4" open cage roller bearing, and zerk fitting. For 900 series riders with front cut 50", 60", 72" cut. (painted yellow)



Order No. 08 - 8550

Caster wheel replaces John Deere AM115510. 9 x 350 x 4, 4 ply smooth tread tubeless tire. 1 piece rim, 3/4" open cage roller bearing, and zerk fitting. For 700 series riders with 48", 54" cut models. Also fits midsize walk behind mowers with 38", 48", 54" cut. Models F500, F700, FS510, FS525, F710, F725. Uses **09-8668** Bearing Kit. (painted yellow)



Order No. 08 - 10461

11 x 400 x 5, 4 ply smooth tread Caster wheel assembly replaces John Deere AM101589. Mounted on a 5 x 3.25 steel wheel with 5" centered hub length, 3/4" angular contact heavy duty ball bearings. Fits 90 series riders with front cut 50", 60" & 72" decks. Also replaces Ariens 1588100, Dixon 17080. (White)



Order No. 08 - 8579

Caster Wheel Assembly, 9 x 350 x 4 Smooth tread solid foam tire with 3 piece rim. Replaces John Deere AM115510. 4" centered hub with 3/4" open cage roller bearing and zerk fitting. For 7001 series riders 48", 54" cut. Also fits midsize walk behind mowers with 38", 48", 54" cut. Models F500, F700, FS510, FS525, F710, F725. Assembly uses our **08-8264** Solid foam tire. (painted yellow). Uses **09-8668** Bearing Kit.

Order No. 08 - 10742

11x400-5 Reliance tire. Wheel assembly replaces John Deere AM101589. 5" centered hub length, 3/4" roller bearings. Includes grease zerk. Painted white.



- 1 Piece Rim
- Flat Proof
- Semi Pneumatic



Order No. 08 - 10756

15 X 6.00 -6, 4-ply tubeless Turf Tread tire. Fits John Deere Gators.



Order No. 08 - 11141

15 x 600 - 6, 2 ply super turf tread tire. Replaces John Deere M123810.



Order No. 08 - 10735

22.5 X 10.00 -8, 3-ply tubeless Turf Tamer tread tire. Used on John Deere Gators **front** tire. Replaces John Deere R90798.

Order No. 08 - 10736

25 X 12.00 -9, 3-ply tubeless Turf Tamer tread tire. Used on John Deere Gators **rear** tire. Replaces John Deere R90796.



Order No. 08 - 10725

24 X 9.50 -10, 4-ply tubeless All Trail II tire. Used on John Deere Gators.

Order No. 08 - 10726

24 X 10.50 -10, 4-ply tubeless All Trail II tire. Used on John Deere Gators.

O.E.M. 30



JOHN DEERE (Cont.)

Order No. 08 - 10660

22.5 X 10 -8, 3-ply tubeless HD Field Trax tread tire. Fits John Deere Gators.

Order No. 08 - 10661

25 X 13 -9, 3-ply tubeless HD Field Trax tread tire. Fits John Deere Gators.

Order No. 08 - 12310

22 x 12.00 - 8, 3-ply tubeless Field Trax tread tire. Used on Dixie Choppers and also fits John Deere AM11820.



Order No. 08 - 12478

15 x 6.50 - 8, 2-ply tubeless Turf Master tread tire. Fits 2008 John Deere models X320, 340 & 360. Replaces John Deere M149202.



Order No. 08 - 10732

24 X 9.50 -10, 4-ply tubeless AT489 tire. Fits John Deere Gators.

Order No. 08 - 10733

24 X 12.00 -10, 4-ply tubeless AT489 tire. Fits John Deere Gators.

Order No. 08 - 10760

22.5 X 10.00 -8, 2-ply tubeless Turf Trac tire. Used on John Deere Gators front tire. Replaces John Deere M140361.

Order No. 08 - 10761

25 X 12.00 -9, 2-ply tubeless Turf Trac tire. Used on John Deere Gators rear tire. Replaces John Deere M140362.



ID 1/2" (12.70 mm)
OD 1-3/8" (34.93 mm)
Height 7/16" (11.11 mm)

Order No. 09 - 8869

Bearing replaces John Deere AM122108. Used in our 09-8823 bearing kit.



ID 63/64" (25.00 mm)
OD 2-7/16" (61.91 mm)
Height 21/32" (16.67 mm)

Order No. 09 - 3217

Replaces John Deere 9467. Shaft Bearing, Sealed Bearing. Bearing No. 6305-2RS.



ID 5/8" (15.88 mm)
OD 1-3/8" (34.93 mm)
Height 7/16" (11.11 mm)

Order No. 09 - 8198

Reduction gear bearing replaces John Deere PT8891. Uses 5 bearings for our Gear Box Assembly 05-7097. Bearing No. 99502H-2RS.



ID 5/8" (15.88 mm)
OD 1-3/8" (34.93 mm)
Height 1/2" (11.11 mm)

Order No. 09 - 7950

Front wheel bearing replaces John Deere PT8894. Bearing No. 44F40P.

30

O.E.M.

**O.E.M. REPLACEMENT
JOHN DEERE (Cont.)**



ID 3/4" (19.05 mm)
OD 1-25/32" (45.24 mm)
Height 19/32" (15.08 mm)

Order No. 09 - 484

Replaces 9266 and 9296. Used on our 10-7154. Bearing No. 9504-ZZ.



ID 3/4" (19.05 mm)
OD 1-3/8" (34.93 mm)
Height 1/2" (12.70 mm)

Order No. 09 - 6573

Replaces John Deere AM118315, AM35443. Heavy duty removable back seal.



ID 1" (25.40 mm)
OD 2" (50.80 mm)
Height 27/32" (21.43 mm)

Order No. 09 - 8488

Bearing replaces John Deere 8597. Fits spindle assembly on 30", 42", 50" cut "ZERO TURN". Bearing No. RA100RR.



ID .787" (19.99 mm)
OD 1.850" (46.99 mm)
Height 9/16" (14.29 mm)

Order No. 09 - 442

Replaces John Deere 7677R. Bearing No. 6204-2RS.

30

O.E.M.



Order No. 09 - 14279

Wheel bearing replaces John Deere AM102888, AM137758. 6205-ZRSNR.



ID .9843" (25mm)
OD 2.0475" (52mm)
Height .590" (15mm)

Order No. 09 - 8445

Snowblower axle bushing replaces John Deere M127082. Fits older Ariens snowblowers model 1032. Oil impregnated, bronze.



ID 3/4" (19.05 mm)
OD 1" (25.40 mm)
Height 5/8" (15.88 mm)

Order No. 09 - 8446

Snowblower auger bushing replaces John Deere M124417. Fits all auger side bushings models 1960 to present. Oil impregnated, bronze.



ID 1" (25.40 mm)
OD 1-1/8" (28.58 mm)
Height 5/8" (15.88 mm)



Order No. 09 - 8240

Caster bushing replaces John Deere M83541. Fits all mid size hydro and belt driven mowers.

ID 1" (25.40 mm)
OD 1-1/4" (31.75 mm)
Height 1" (25.40 mm)
Flange OD 1-3/4" (44.45 mm)



Order No. 09 - 8366

Bushing replaces John Deere M70808, M93523. Fits Gator riding commercial 900 series 316 thru 430, F510, F525, F915, F935 & Homeowner models. Also fits front mount mowers models F700 & F900 series. (steel)

ID 1" (25.40 mm)
OD 1-1/4" (31.75 mm)
Height 1" (25.40 mm)
Flange OD 1-3/4" (44.45 mm)

Order No. 09 - 8707

Spanner bushing replaces John Deere M84516. Fits John Deere AM101589 11 x 400 x 5 caster wheel. Spanner bushing for our 08-8551 wheel assembly. ID 1/2" (12.70 mm), OD 3/4" (19.05 mm), Length 5-1/16" (128.59 mm).

Order No. 09 - 8706

Spanner bushing replaces John Deere M91080. Fits John Deere AM115510 9 x 350 x 4 caster wheel. Spanner bushing for our 08-8550 wheel assembly. ID 1/2" (12.70 mm), OD 3/4" (19.05 mm), Length 4-9/16" (115.89 mm).





JOHN DEERE (Cont.)



ID 5/8" (15.8mm)
OD .900" (22.8mm)
Height .870" (22.0mm)



Order No. 09 - 14557

Steering shaft bushing replaces John Deere GX21994. Fits L100 series, Sabre & Scotts models. Flange OD 1" MIN005



Order No. 10 - 9143

Universal adjustable yoke ends. 3/8" - 24 female, for 3/8" pin. Replaces John Deere M80373.

Order No. 10 - 9150

Universal adjustable yoke ends. 1/2" - 20 female, for 1/2" pin. Replaces John Deere T21158.



Order No. 10 - 13440

Drag link replaces John Deere GY21250, GY20770. **Left** hand steering Drag link, adjustable. Fits LA100, X100 series riders. Replaces non-adjustable drag links.



Order No. 10 - 13441

Drag link replaces John Deere GY21251, GY20771. **Right** hand steering Drag link, adjustable. Fits LA100, X100 series riders. Replaces non-adjustable drag links.

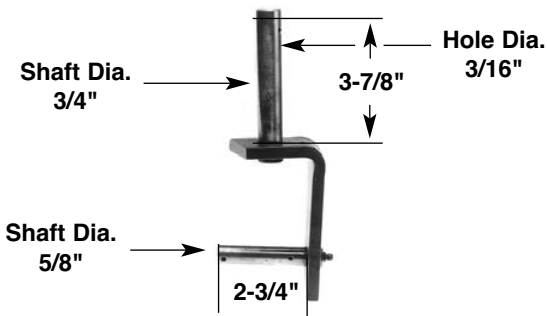

Order No. 10 - 2243

6" Caster Yoke. Replaces Bobcat 36306 & 36013A, Bunton PLO556, John Deere PT8670, Snapper 76400. Used with our support arm 10-2218.



Order No. 10 - 2218

Caster Yoke Support Arm. Replaces Ransomes/Bobcat 36129, Bunton PLO457, John Deere PT8663, Exmark 302122. (Used with our cast yoke 10-2243). Comes complete with bushing and grease fitting. Uses our bushing 09-5721.



Order No. 10 - 13457

Left hand ball joint replaces John Deere AM100645. Also replaces AM32869. 1/2" - 20, Right hand, male thread ball joint with 1/2" - 20 LRH. Left hand threads on internal. Female threads.



Order No. 10 - 12450

1/2 - 20 right hand female threads with 7/16 - 20 male stud. Ball joint replaces John Deere AM125418, AM39889. Fits 1990 thru 2007 all LX, GT and older 100, 200, and 300 series lawn tractors.



Order No. 10 - 11142

Shoulder bolt replaces AYP 184219 / 137644, 193406, Cub Cadet 938-3055, John Deere 193406. Fits deck wheels on riders 2003 & up. MIN010



Order No. 10 - 9307

Rod end replaces John Deere AM103052. Female 1/2" - 20 rod end assembly. Right hand thread. Fits Gravely 18G & 20G.

30

O.E.M.

**O.E.M. REPLACEMENT
JOHN DEERE (Cont.)**



Order No. 10 - 10908

Deck wheel hardware kit fits John Deere. Used with our 08-10724 deck wheel. Includes bushings and hardware.



Order No. 10 - 11278

Spindle assembly with pulley replaces John Deere AM121342. Fits 48" & 54" deck on some LX & GT series tractors. Pulley included.



Order No. 10 - 13385

Spindle assembly replaces John Deere TCA17517. Fits Z-Trak mowers.



Order No. 10 - 11964

Spindle assembly replaces John Deere GY20454. Fits 100 series riders since 2006. 7 point star. Used on 42", 48" & 54" decks.



Order No. 10 - 14168

Spindle assembly replaces John Deere TCA13807. Fits 48" & 60" mower decks for F620, F680 and F687 Z-Trak mowers. F687 48" & 54" decks for 1420, 1435, 1445, 1545, 1565. F725, F735, 777, 797 - 60" & 72" decks. 737, 757 - 54" & 60" decks. 717A, 727A, 48" & 54" decks.

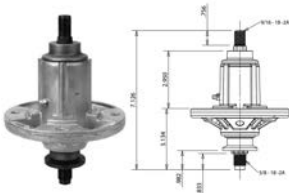

Order No. 10 - 12910

Spindle assembly replaces John Deere GY21098, GY20454, GY20962. Fits LA100-LA165 series mowers since 2006. 7 point spline. Used on 42", 48" & 54" decks.

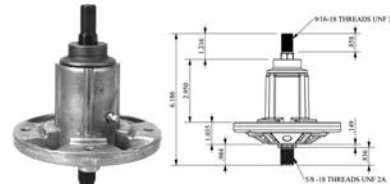

Order No. 10 - 12495

Spindle assembly replaces John Deere GY21099 & GY20867. Fits LA150 & LA175, G110, 190C mowers with 54" decks. 7 point spline.



Order No. 10 - 13234

Spindle assembly replaces John Deere AM136733. Fits EX-TRAK models X300, X300R, X304, Z225 & Z245.



Order No. 10 - 8187

Spindle Assembly. Replaces John Deere AM122797, AM106236, PT8633, AM106236. Fits 36, 40, 48, 52 & 61" cut. (6-1/2" Spindle Shaft) (25mm Dia.)

Order No. 10 - 11274

Spindle assembly replaces John Deere AM108925 with pulley. Fits 38" deck on LX and GT series tractors.

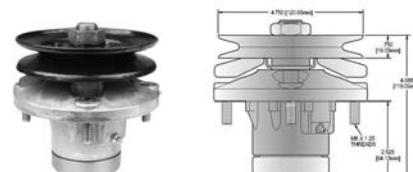

30
O.E.M.



JOHN DEERE (Cont.)



Order No. 10 - 11206

Spindle assembly replaces John Deere GY20050/GY20785. Fits L-100, L110, L120 & L130 models with 42" & 48" decks. Fits current Home Depot models.



Order No. 10 - 11037

Spindle assembly replaces John Deere AM126226. Fits 1438GS & 1438HS Sabre, 1438GS Europro lawn tractors, 15.538GS, 15.538HS Sabre & 1538GS lawn tractors, 1542GS, 1542HS, 15.542HS Sabre & 1542GS Europro lawn tractors, 1642HS, 1642V-Twin H, 1642V-Twin G Sabre & 1642H Europro Lawn tractors, S16642 & S1742 lawn tractors, 1742GS & 1742HS Sabre lawn tractors, 97-14HS Sabo lawn tractor, 107-17HS Sabo lawn tractor, LT160 & LT180 lawn tractors.



Order No. 10 - 9911

Electric PTO clutch replaces John Deere AM119683. 1" ID x 3" Height, 5.375" Pulley, 5/8" belt.



Order No.

Description

12 - 10485

V Belt. Replaces John Deere GC00073. 3/8" (9.53 mm) x 39-1/16"(992.2 mm). Fits walkbehind mower models JS60, JS61, JS63, JS63C, JS63E. Also fits Sabre mower model M21 & Scotts mower model SP6211. Raw edge polyester cord construction, laminated.

12 - 10486

V Belt. Replaces John Deere GC00081. 3/8" (9.53 mm) x 34-3/4"(882.7 mm). Fits walkbehind mower models JS63, Also fits Sabre mower model M23 & Scotts mower model SP6213. Raw edge polyester cord construction, laminated.

12 - 10630

V Belt. Replaces John Deere GX10176. 1/2" (12.7 mm) x 143-5/16" (3640.1 mm). Fits model S2046, 46" cut Scotts. Wrapped molded, aramid cord construction, clutching Cover.

12 - 13217

V Belt. Replaces John Deere **M1118685**. 5/8" (15.875mm) x 120" (3048 mm). Fits Sabre Lawn Tractors: 2254HV, 2354HV, 2554HV all 54" deck only. Scotts Lawn Tractors: GT2554, S2554 all with 54" deck only. John Deere Lawn Tractors: 325, 335, 345, 355D, G100, GT225, GT235, GT235E, GT245, GX325, GX335, GX345, GX355, LX255, LX266. Aramid cord construction, double cover, clutching, white.

12 - 14243

V Belt. Replaces John Deere **GX21395**. 5/8" (15.87 mm) x 161.41" (4099.8 mm). Fits 54" deck models LA150, LA175, G110 & 190C. Wrapped molded, aramid cord construction, double cover, clutching, brown.

12 - 14390

Double V- Belt. Replaces John Deere **M111534**. 5/8" (15.87 mm) x 128-3/4" (3270.25 mm). Fits F110, F225, F735, 54" deck Homeowner Zero turn mowers. Aramid cord construction, laminated.

O.E.M. REPLACEMENT
JOHN DEERE (Cont.)



Order No.	Description
12 - 13158	Deck V-Belt. Replaces John Deere M158131, M154296 . 1/2" (12.7 mm) x 152-1/4" (3867.1mm). Fits EZ-Trak model Z425, Z445, Z465. Raw edge Aramid cord construction.
12 - 10435	Drive Belt. Replaces John Deere GX20241. 17/32" (13.5 mm) x 91-13/16" (2332 mm). Fits model L-100. 14.542GS. Wrapped polyester cord construction. model 14.542GS.
12 - 10437	Drive Belt. Replaces John Deere GX20305, GY20571. 17/32" (13.5 mm) x 138-7/8" (3527.4 mm). Fits model L2048. Wrapped fiberglass cord construction.
12 - 10434	Drive Belt. Replaces John Deere GX20006. 17/32" (13.5 mm) x 88-5/8" (2251.1 mm). Fits models 1542G, 15.542G, 1743GS, 17.542HS. Wrapped fiberglass cord construction.
12 - 10751	Drive Belt. Replaces John Deere M110978. 1/2" (12.7 mm) x 102" (2590.8 mm). Fits models LX176, LX178, LX186 & LX188. Wrapped molded, aramid cord construction, clutching cover.
12 - 10750	Drive Belt. Replaces John Deere M74747. 1/2" (12.7 mm) x 105" (2667 mm). Fits model STX38. Wrapped molded, aramid cord construction, clutching cover.
12 - 11024	Drive Belt. Replaces John Deere TCU16092. 5/8" (15.875 mm) x 150.2" (3815.08 mm). Fits models 717 front mount mowers, zero turns with 48" decks. Fits Great Dane Chariot / Chariot LX. Wrapped molded, laminated neoprene, aramid cord, clutch cover.
12 - 11025	Drive Belt. Replaces John Deere TCU16093. 5/8" (15.875 mm) x 157.28" (3994.91 mm). Fits models 727 mini frame Z-trak, front mount mowers, zero turn with 54" decks. Fits Great Dane Chariot / Chariot LX 54" cut. Wrapped molded, laminated, neoprene, aramid cord, clutch cover.
12 - 11028	Drive Belt. Replaces John Deere M122907. 5/8" (15.875 mm) x 50.49" (1282.4 mm). Fits models GS25, GS30, GS45 & GS75 commercial walkbehind mowers. Fits G15 commercial walk-behind mowers. Raw edge, cogged, aramid cord construction.
12 - 11811	Drive Belt. Replaces John Deere GX22819. 3/8" (9.5 mm) x 37-3/4" (958.85 mm). Fits 21" JD25-45 series & Snapper Easy Line series self propelled mowers. Also replaces Snapper 7100058. Wrapped molded, general purpose, aramid cord construction, double cover.
12 - 12678	Drive Belt. Replaces John Deere M124895 . 1/2" (12.7mm) x 115-1/4" (2927.35 mm). Aramid cord construction, double cover, wrapped, clutching-white.
12 - 12898	Drive Belt. Replaces John Deere M126009 . 1/2" (12.7mm) x 86.39" (2194.3 mm). Aramid clutching cover, white.
12 - 10749	Deck Belt. Replaces John Deere M125218. 9/16" (14.2 mm) x 96-1/2" (2451.1 mm). Fits 38" black mower deck on model STX38 lawn tractor. Serial number 210001 & higher. GX10065, GX10851. Raw edge aramid cord construction.

30 O.E.M.



JOHN DEERE (Cont.)



Order No.

Description

12 - 14365

Drive Belt. Replaces John Deere GX21986, M40223, M86996. 1/2" (12.7 mm) x 87-1/2" (1905 mm). Fits models 71193, 14-38HXL lawn tractor. Traction drive belt for 100 series with 54" deck. Wrapped molded, Aramid cord construction, double friction cover.

12 - 12373

Deck Belt. Replaces John Deere M126536. 1/2" (12.7 mm) x 114-1/2" (2908.3 mm). Fits LT133, LT155, LT166 series models. Wrapped molded, general purpose, aramid cord construction, double cover.

12 - 10436

Deck Belt. Replaces John Deere GX20072, GY20570. 17/32" (13.5 mm) x 103-3/4" (2635.3 mm). Fits model 14.542GS. Wrapped polyester cord construction.

12 - 12760

Deck Belt. Replaces John Deere **TCU13198**. 5/8" (15.875mm) x 141.73" (3600 mm). Fits Z-Trak 737, 757, & 797, 60" decks. Aramid cord construction, double cover.

12 - 12559

Deck Belt. Replaces John Deere **M154601**. 1/2" (12.7mm) x 143.5" (3644.9 mm). Fits 38" mower deck belt. Aramid cord construction, double cover.

12 - 12560

Deck Belt. Replaces John Deere **M154621**. 1/2" (12.7mm) x 146" (3708.4 mm). Fits 42" mower deck belt. Aramid cord construction, double cover.

12 - 10388

Primary Belt. Replaces John Deere M110312/GY20572. 9/16" (14.3 mm) x 64-1/4" (1332 mm). Fits models 1842GV, 1848GV, 1948GV. Raw edge polyester cord construction, laminated.

12 - 11026

Primary Belt. Replaces John Deere M122106. 1/2" (12.7 mm) x 70.62" (1793.74 mm). Fits models GS25, GS30, GS45 & GS75 commercial walkbehind mowers with 36" deck. Also fits G15 commercial walkbehind mowers. Wrapped molded, general purpose, aramid cord construction, clutching cover.

12 - 12078

Primary Deck Belt. Replaces John Deere M144677, M143019. 5/8" (15.875 mm) x 64-1/2" (1638.3 mm). Fits models LX255, LX277, LX279, LX288, LX277AWS, LX280, LX289 all using 42C 48" and 52" decks. Also fits GT242, GT262, GT275 with 48" decks. Also fits GT225, GT235, GT255, GX255, 325, 335, 345. Raw edge double cog, polyester cord construction.

12 - 11027

Secondary Drive Belt. Replaces John Deere M122107. 1" (25.4 mm) x 50.394" (1280 mm). Fits models GS25, GS30, GS45 & GS75 commercial walkbehind mowers. Fits HD45 and HD75 Hydrostatic commercial walk behind mowers. Fits G15 commercial walk-behind mowers. Synchronous timing belt.

12 - 12077

Secondary Deck Belt. Replaces John Deere M110313. 5/8" (15.875 mm) x 111-3/8" (2828.9 mm). Fits 48" deck, LX & GT series models. Wrapped molded, general purpose, aramid cord construction, double cover. Also fits SCOTT'S model S2048.

12 - 12461

PTO Drive Belt. Replaces John Deere **GX21833**. 1/2" (12.7mm) x 141.1" (3583.94 mm). Fits models 145 & 155C. Aramid cord construction, double cover.

12 - 12759

PTO Engine to Deck Belt. Replaces John Deere **TCU13195**. 5/8" (15.875mm) x 117" (2971.8 mm). Fits Z-Trak 737, 757, & 797, 60" & 72" decks. Aramid cord construction, double cover.

12 - 12814

PTO Engine to Deck V-Belt. Replaces John Deere **TCU13196**. 5/8" (15.8 mm) x 131-1/2" (3340.1mm). Fits Z-Trak 737, 757, 797, 54" decks. Wrapped molded, aramid cord construction, double cover, friction.

30

O.E.M.

O.E.M. REPLACEMENT
JOHN DEERE (Cont.)



Order No.	Description
12 - 13157	Hydro Drive Belt. Replaces John Deere M154157 . 1/2" (12.7 mm) x 42-1/4" (1073.1mm). Fits EZ-Trak model Z425, Z445, Z465. Wrapped molded Polyester cord construction, double cover.
12 - 13036	Traction Drive V-Belt. Replaces John Deere M144570 . 1/2" (12.7 mm) x 97" (2463.8mm). Fits LT150. Wrapped molded, Aramid cord construction, double cover, clutching, color white.
12 - 13035	Traction Drive V-Belt. Replaces John Deere M144044 . 1/2" (12.7 mm) x 91-7/8" (2333.6mm). Fits LT150-LT190 & X300-X320 riders. Wrapped molded, polyester cord construction, double cover.
12 - 14237	Pump Drive Belt. Replaces John Deere TCU16026 . 7/8" (22.22 mm) x 31.5" (800.1 mm). Fits models 737, 757, 777 and 797, Z-Trak. 6 rib, "K" section Aramid cord, Fabric back.

*Made with KEVLAR® or non-trade marked Aramid fiber.

30

O.E.M.

Order No. 13 - 11207

Idler pulley replaces John Deere GY20629. Fits L120, L130 lawn tractors. Fits G110 Garden Tractor.



ID 43/64"
OD 5-7/32"
Height 1-23/32"



Flat Idlers with Flange

Order No. 13 - 721

Replaces John Deere AM35585.

Order No. 13 - 727

Replaces John Deere AM35590.

Order No. 13 - 723

Replaces John Deere AM41647.

Order No. 13 - 2188

Replaces John Deere PT8649.

Order No. 13 - 5869

Replaces John Deere AM106564, PT8761.

Note: For Idler measurements see Section 13.



ID 11/16"
OD 5-1/4"
Height 1-9/16"

Order No. 13 - 10737

Idler pulley replaces John Deere GY20110. Fits S100-S130 series 42" & 48" deck. Also fits Sabre models: 14542GS, 1642HS, 1742HS, 17542HS lawn tractors. Scotts models: L1742, L17542, L2048 & L2548 lawn tractors.



ID 11/16"
OD 3-5/8"
Height 1-3/16"

Order No. 13 - 10741

Idler pulley replaces John Deere GY20067. Also fits Sabre models: 14542GS, 1642HS, 1742HS, 17542HS lawn tractors. Scotts models: L1742, L17542, L2048 & L2548 lawn tractors.



ID 13/32"
OD 3-27/32"
Height 1-3/8"



Order No. 13 - 14255

Idler pulley replaces John Deere AM135773. Fits X Series, LA Series, L Series, 105, 115, 145, and 155C models.



JOHN DEERE (Cont.)



ID 11/16"
OD 3-11/32"
Height 1"

Order No. 13 - 9544

Idler pulley replaces John Deere GX20287. Fits L120 series 20 hp 48" deck & L130 series 23 hp 48" deck.



ID 13/32"
OD 3-1/2"
Height 1-1/32"

Order No. 13 - 14241

Idler pulley replaces John Deere AM115459. Fits series LX, GX and Sabre models. Composite. 3/4" belt groove.



ID 21/32"
OD 2-7/8"
Height 29/32"

Order No. 13 - 14240

Idler pulley replaces John Deere AM115460. Fits EZ Trak, LX, GT, X300R and others. Composite. 3/8" belt groove.



ID 21/32"
OD 5-1/4"
Height 1-1/4"

Order No. 13 - 14242

Idler pulley replaces John Deere AM135526. Fits X300 series.



Order No. 13 - 728

V-Belt Idler. Replaces John Deere AM32672.

Order No. 13 - 734

V-Belt Idler. Replaces John Deere AM33574.



ID 11/16"
OD 2-7/8"
Height 21/32"

Order No. 13 - 10738

V-Belt idler pulley replaces John Deere GX20286. Also fits Sabre models: 14542GS, 1642HS, 1742HS, 17542HS lawn tractors. Scotts models: L1742, L17542, L2048 & L2548 lawn tractors.



ID 11/16"
OD 5"
Height 1"

Order No. 13 - 12419

Idler pulley replaces John Deere AM106627.



ID 11/16"
OD 4"
Height 11/16"

Order No. 13 - 12427

Idler pulley replaces John Deere AM37249.

Order No. 13 - 11449

Spindle pulley replaces John Deere GX20367. Fits models 14,442GS, 1642GS, 1642HS, 1742HS, 17.542HS Sabre Lawn Tractors. Models L1742, L17542 Scott Tractors, Models 108-17HS, 108-14.5 SABO Lawn Tractors, and L100, L111, L105, L107, L118, L111 and L108 Lawn Tractors.



ID 19/32"
OD 7"
Height 7/8"













30

O.E.M.

O.E.M. REPLACEMENT
JOHN DEERE (Cont.)















30
O.E.M.

ORDER NO.	REPLACES O.E.M. NO.	LENGTH	CENTER HOLE DIAM.	OUTSIDE HOLE DIAM.	CENTER TO CENTER	WIDTH	STEEL THICK.	APPLICATION
 15 - 1126	AM100991 M41237 AM30698	14" 355.6mm	11/16" 17.5mm			2" 50.8mm	.187" 4.8mm	(3) blades for 38" cut Model 200 series
 15 - 6193	M115759	14-1/16" 357.2mm	11/16" 17.5mm			2-1/2" 63.5mm	.204" 5.2mm	(3) blades for 38" cut shallow deck
 15 - 1127	M127466 M41967 AM31100	16" 406.4mm	11/16" 17.5mm			2" 50.8mm	.187" 4.8mm	(3) blades for 48" cut Model 300
 15 - 6496	AM31100 M41967	16" 406.4mm	11/16" 17.5mm			2 1/2" 63.5mm	.187" 4.8mm	Mulching Blade PATENTED
 15 - 6222	AM104489	16-1/2" 419.1mm	5/8" 15.9mm			2-1/2" 63.5mm	.204" 5.2mm	(3) blades for 48" cut
 15 - 6300	AM104489	16-1/2" 419.1mm	5/8" 15.9mm			2-1/2" 63.5mm	.204" 5.2mm	Mulching Blade PATENTED
 15 - 6206	M115495	16-5/8" 422.3mm	13/16" 20.6mm			2-1/2" 63.5mm	.204" 5.2mm	(3) blades for 48" cut
 15 - 6223	M113517	16-5/8" 422.3mm	13/16" 20.6mm			2-1/2" 63.5mm	.204" 5.2mm	(3) blades for 48" cut Fits model F 710 Mulching Blade
 15 - 6420	M113517	16-5/8" 422.3mm	13/16" 20.6mm			2-1/2" 63.5mm	.204" 5.2mm	Mulching Blade PATENTED
 15 - 6314	M115495	16-5/8" 422.3mm	13/16" 20.6mm			2-1/2" 63.5mm	.204" 5.2mm	Mulching Blade PATENTED
 15 - 10634	GX20250	17" 431.8mm	.675" 17.1mm			2-1/2" 63.5mm	.150" 3.8mm	Fits L120 & L130 series riders. (3) Blades for 48" cut.
 15 - 12920	GX20250	17" 431.8mm	.675" 17.1mm			2-1/2" 63.5mm	.160" 4.0mm	Mulching Blade (3) Blades for 48" cut PATENTED



JOHN DEERE (Cont.)













ORDER NO.	REPLACES O.E.M. NO.	LENGTH	CENTER HOLE DIAM.	OUTSIDE HOLE DIAM.	CENTER TO CENTER	WIDTH	STEEL THICK.	APPLICATION
 15 - 10291	M127500 M145476	17" 431.8mm	.800" 20.6mm			2-1/2" 63.5mm	.204" 5.2mm	Fits 48C decks. Since 1999. (3) blades per unit 48" cut.
 15 - 12821	M127673 M145476 M127500	17" 431.8mm	.800" 20.3mm			2-1/2" 76.2mm	.204" 5.2mm	Mulching Blade. PATENTED. (3) blades for a 48" cut.
 15 - 10284	M136194 TCU14939	17" 431.8mm	.904" 23mm			2-1/2" 63.5mm	.240" 6.1mm	Fits 7-Iron decks. (3) blades for a 48" cut.
 15 - 11595	GX21784 GY20852	17" 431.8mm	7 point star			2-3/4" 69.8mm	.160" 4.0mm	3 in 1 blade. (3) blades for a 48" cut. Fits model 145, 155C riders.
 15 - 11596	GX21784	17" 431.8mm	7 point star			2-3/4" 69.8mm	.160" 4.0mm	Commercial Mulcher 3 in 1 blade. (3) blades for a 48" cut. Fits model 145, 155C riders.
 15 - 6012	M86209 AM39966	17-3/16" 436.6mm	11/16" 17.5mm			2-1/2" 63.5mm	.204" 5.2mm	(3) blades for 50" cut (Old No. 3383)
 15 - 6294	PT8721	18" 457.2mm	5/8" 15.9mm			2-1/2" 63.5mm	.204" 5.2mm	Mulching Blade PATENTED
 15 - 6192	M115496	18-5/8" 473.1mm	13/16" 20.6mm			2-1/2" 63.5mm	.204" 5.2mm	(3) blades for 54" cut
 15 - 6221	M113518	18-5/8" 473.1mm	13/16" 20.6mm			2-1/2" 63.5mm	.204" 5.2mm	(3) blades for 54" cut Fits model F-725 Mulching Blade
 15 - 6315	M115496	18-5/8" 473.1mm	13/16" 20.6mm			2-1/2" 63.5mm	.204" 5.2mm	Mulching Blade PATENTED
 15 - 11491	GX21380 GY20684	18-5/8" 473.1mm	7 point star			2-3/4" 69.8mm	.187" 4.8mm	(3) blades for a 54" cut. Fits G110 series riders.
 15 - 6738	M122455	18-11/16" 474.3mm	1"x1-1/8"			2-1/2" 63.5mm	.204" 5.2mm	(2) blades for 36" cut Fits midsize commercial mowers, models GS25, 36

30

O.E.M.













**O.E.M. REPLACEMENT
JOHN DEERE (Cont.)**

30
O.E.M.

ORDER NO.	REPLACES O.E.M. NO.	LENGTH	CENTER HOLE DIAM.	OUTSIDE HOLE DIAM.	CENTER TO CENTER	WIDTH	STEEL THICK.	APPLICATION
 15 - 10292	M143520	18-7/8" 479mm	.800" 20.6mm			2-3/4" 69.9mm	.204" 5.2mm	(3) blades for a 54" cut.
 15 - 14475	 M144516	19" 482.6mm	.800" 20.3mm			2-1/2" 63.5mm	.240" 6.1mm	Mulching Blade PATENTED (3) blades for 54" cut
 15 - 6480	M136195	19" 482.6mm	.904" 23mm			2-1/2" 63.5mm	.240" 6.1mm	(3) blades for 54" cut. Fits the 7-Iron Deck.
 15 - 10072	M136195	19" 482.6mm	.904" 23mm			2-1/2" 63.5mm	.240" 6.1mm	(3) blades for 54" cut Mulching Blade PATENTED
 15 - 6011	AM100946 M82408	19-1/2" 495.3mm	11/16" 17.5mm			2-1/2" 63.5mm	.204" 5.2mm	(2) blades for 38" cut for riders.
 15 - 6737	M84472	19-1/2" 495.3mm	11/16" 17.5mm			3" 76.2mm	.204" 5.2mm	(2) blades for 38" cut Fits models SX38.
 15 - 845	M83459	19-1/2" 495.3mm	11/16" 17.5mm			3" 76.2mm	.204" 5.2mm	(2) blades for 38" cut Fits model SX-38 High Lift
 15 - 6186	M112991	19-1/2" 495.3mm	11/16" 17.5mm			2-1/2" 63.5mm	.204" 5.2mm	(2) blades for 38" cut Mulching Blade
 15 - 6421	M112991	19-1/2" 495.3mm	11/16" 17.5mm			2-1/2" 63.5mm	.204" 5.2mm	Mulching Blade PATENTED
 15 - 12562	M153118	19-1/2" 495.3mm	7 point star			3" 76.2mm	.204" 5.2mm	Hi-Lift Blade (2) blades for a 38" cut.
 15 - 2120	M112847 M48452 AM35557	20-1/2" 520.7mm	25/32" 19.8mm			2" 50.8mm	.187" 4.8mm	(3) blades for 60" cut Model 400 & WH-D-250
 15 - 6253	M87622 M141785	20-1/2" 520.7mm	29/32" 23mm			2-1/2" 63.5mm	.313" 8mm	(3) blades for 60" cut



JOHN DEERE (Cont.)

ORDER NO.	REPLACES O.E.M. NO.	LENGTH	CENTER HOLE DIAM.	OUTSIDE HOLE DIAM.	CENTER TO CENTER	WIDTH	STEEL THICK.	APPLICATION
 15 - 3348	PT6921	20-3/4" 527.1mm	3/8" 9.5mm			2-1/4" 57.2mm	.150" 3.8mm	For 21" walkbehind
 15 - 10458	GC00344	21" 533.4mm	3/8" 9.5mm	.480" 12.3mm	2" 50.8mm	2-3/4" 69.9mm	.125" 3.2mm	Mulching Blade Fit 21" steel decks. Walkbehind mowers.
 15 - 10635	GX20249	21-27/64" 544.1mm	.675" 17.1mm	13/32" 10.3mm		2-1/2" 63.5mm	.160" 4.0mm	Fits L100 & L110 series riders. (2) Blades for 42" cut. Also fits Sabre and Scotts mowers.
 15 - 6479	M128485	21" 533.4mm	21" 23mm	29/32"		2-1/2" 63.5mm	8mm	.313" (3) blades for 60" cut. Fits the 7-Iron Deck.
 15 - 10073	M128485	21" 533.4mm	.908" 23mm			2-1/2" 63.5mm	.240" 6.1mm	TCU15881, High Lift Blade M133381, Low Lift Mulching Blade PATENTED
 15 - 6122	M112738 M125413 M112972	21" 533.4mm	.904" 23mm	.411" 10.4mm	3-11/16" 93.7mm	2-3/4" 29.9mm	.134" 3.4mm	21" mulching blade for Models GX14SB & GX14SBE
 15 - 11593	GX22151	21-3/8" 542.9mm	7 point star			2-3/4" 69.8mm	.155" 3.9mm	3 in 1 blade. (2) blades for a 42" cut. Fits 102,115,125,135 riders.
 15 - 11594	GX22151	21-3/8" 542.9mm	7 point star			2-3/4" 69.8mm	.160" 4.0mm	Commercial Mulcher 3 in 1 blade. (2) blades for a 42" cut. Fits 102,115,125,135 riders.
 15 - 12380	M154061	21-3/8" 542.9mm	7 point star			2-3/4" 69.8mm	.204" 5.2mm	(Heavy Duty) Blade. Fits models 102, 115, 125 & 135. 42" Riders (2) blades for a 42" cut.
 15 - 10074	M148613 M139976	21-3/8" 542.9mm	13/16" 20.6mm			2-1/2" 63.5mm	.203" 5.2mm	(2) blade for 42" cut model GT225 (3) blades for 60" cut. Fits new style decks from 1999.
 15 - 12919	GX20249	21-27/64" 544.1mm	.675" 17.1mm	13/32" 10.3mm		2-1/2" 63.5mm	.160" 4.0mm	Mulching Blade Patented (2) Blades for 42" cut
 15 - 9959	M139802	21-15/32" 545.3mm	11/16" 17.5mm			2-1/2" 63.5mm	.160" 4.1mm	(2) blades for 42" cut. Mulching Blade. Fits Scott Yard Tractor.

30
O.E.M.

O.E.M. REPLACEMENT
JOHN DEERE (Cont.)



30
O.E.M.

ORDER NO.	REPLACES O.E.M. NO.	LENGTH	CENTER HOLE DIAM.	OUTSIDE HOLE DIAM.	CENTER TO CENTER	WIDTH	STEEL THICK.	APPLICATION
15 - 6252	M83363 AM102401	24-15/16" 612.4mm	29/32" 23mm			2-1/2" 63.5mm	.313" 8mm	(3) blades for 72" cut 9/16" Lift
15 - 6255	M141786 M80783	24-15/16" 612.4mm	29/32" 23mm			2-1/2" 63.5mm	.313" 8mm	(3) blades for 72" cut 1" Lift
15 - 12643	TCU15882	25" 635mm	.900 22.8mm			3" 76.2mm	.250" 6.35mm	Hi-Lift Blade
15 - 6327	M89455 AM101539	29-1/2" 749.3mm	11/16" 17.5mm			2-1/2" 63.5mm	.204" 5.2mm	For 30" deck mowers with grass catcher. High lift.
15 - 6328	M89454 AM101538	29-1/2" 749.3mm	11/16" 17.5mm			2-1/2" 63.5mm	.204" 5.2mm	For 30" deck mowers. Regular lift.
15 - 6329	M118958	29-1/2" 749.3mm	11/16" 17.5mm			2-1/2" 63.5mm	.204" 5.2mm	For 30" deck mowers. Mulching blade.



Order No. 19 - 1370

Air Filter replaces John Deere AM34963, Length: 4-5/8" to 5-1/4", Width: 3-5/8" to 4-1/4", Thickness: 1-1/2".



Order No. 19 - 1398

Air Filter replaces John Deere M82139, Length: 4-3/4" to 5-1/2", Width: 3-1/4" to 4", Thickness: 1-1/2".



Order No. 19 - 1373

Air Filter replaces John Deere AM49396, Length: 7-3/4" to 8-1/4", Width: 3-5/8" to 4-1/4", Thickness: 1-1/2".



Order No. 19 - 1371

Air Filter replaces John Deere M47949, Length: 4-1/2" to 5-3/8", Width: 3" to 3-1/2", Thickness: 1-1/2".



Order No. 19 - 1376

Air Filter replaces John Deere AM37489, Length: 5" to 5-5/8", Width: 3" to 3-5/8", Thickness: 1-1/2".



Order No. 19 - 11205

Prefilter replaces John Deere M151768.



JOHN DEERE (Cont.)

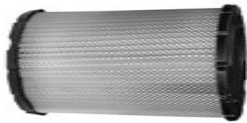

OD 3-1/2"
ID 1-27-32"
Height 7-1/4"

Order No. 19 - 9550

Air filter, fits Kawasaki 12 hp on John Deere Gator M113621. Fits our 19-9616 assembly..

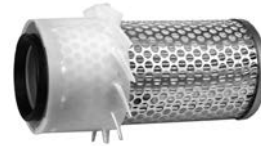

OD 3-9/32"
ID 1-11/16"
Height 7-1/4"

Order No. 19 - 8279

Air filter replaces John Deere CH-15541/AM108243.

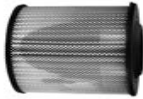

ID 2"
OD 4-1/4"
Height 6-1/16"

Order No. 19 - 8332

Air filter replaces EZ-GO 14416GL. Replaces John Deere AM34093, AM100137, Nelson 83816A, fits Harley, Club Car & Columbia Golf Carts.



ID 2-1/2"
OD 4"
Height 10-1/4"

Order No. 19 - 8328

Air filter replaces John Deere CH12767.



Length 7-1/2"
Width 2-3/8"

Order No. 19 - 13390

Air filter replaces John Deere AM108185. Fits models F1145, F925, F932, F935, 755, 855, 955. Used with our 19-13389 outer element.



Length 8-1/4"
Width 4"

Order No. 19 - 13389

Air filter replaces John Deere AM108184. Fits models F1145, F925, F932, F935, 755, 855, 955. Used with our 19-13390 inner element.



OD 2-7/8"
ID 1-1/2"
Height 5-7/8"

Order No. 19 - 12673

Air filter replaces B&S 793569. Fits John Deere GY21055 & MIU11511.



Order No. 19 - 10080

Filter safety element. Replaces John Deere M123378.



ID 3"
OD 4-3/8"
Height 2-1/4"

Order No. 19 - 1385

Filter replaces John Deere AM30800. El Smith air compressor 2557. ROL-AIR (air comp.) 431.

Order No. 19 - 2780

Prefilter



ID 4-3/4"
OD 6"
Height 1-7/8"

Order No. 19 - 1386

Filter replaces John Deere AM31400.

Order No. 19 - 1377

Prefilter replaces John Deere M45800.

Order No. 19 - 1388

Air Filter replaces John Deere AM37201.

Order No. 19 - 2844

Prefilter for John Deere ET12340.



ID 4-3/4"
OD 6"
Height 3"

30

O.E.M.

**O.E.M. REPLACEMENT
JOHN DEERE (Cont.)**



ID 5-1/2"
OD 7"
Height 2-1/2"

Order No. 19 - 1389

Filter replaces John Deere M47494. Application: Fits (10 thru 20 hp).

Order No. 19 - 7785

Prefilter.



ID 3-3/8"
OD 4-1/2"
Height 2-13/16"

Order No. 19 - 6605

Filter replaces John Deere AM121608, M92359. (11, 12-1/2 and 14 hp) vertical.

Order No. 19 - 6606

Prefilter replaces John Deere M92360.



Length 9-5/8"
Width 4"
Height 2-1/2"

Order No. 19 - 2806

Filter replaces John Deere AM38990 (12, 14, 16 & 18 hp) vertical twin cylinder (L Head).

Order No. 19 - 2797

Prefilter replaces John Deere M84655.



Length 7-1/2"
Width 3-1/4"
Height 3-1/8"

Order No. 19 - 2828

Filter & Prefilter replaces John Deere M97266, M70128, for model FC540, (17 hp) OHV Kawasaki equipped John Deere.

Order No. 19 - 6517

Prefilter replaces John Deere M70127.



Length 3-5/8"
Width 2-3/8"
Height 2-1/4"

Order No. 19 - 6705

Filter replaces John Deere M79451. 4-1/2-5.5 hp for walk behind mowers.

Order No. 19 - 7052

Prefilter replaces John Deere M77555



Length 6-1/4"
Width 2-7/8"
Height 3-1/8"

Order No. 19 - 6706

Filter replaces John Deere AM104560, M97211. (14 hp) vertical engines.

Order No. 19 - 6989

Prefilter replaces John Deere M74285.



ID 1-1/4"
OD 2-3/4"
Height 2-3/4"

Order No. 19 - 1396

Filter replaces John Deere M83339 (2 thru 5 hp) horz. and vert. engines.

Order No. 19 - 1369

Prefilter replaces John Deere PT7946.

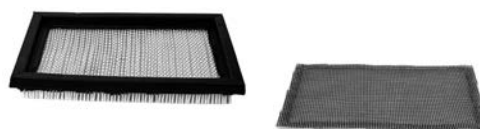

Length 6-1/4"
Width 4-1/2"
Height 7/8"

Order No. 19 - 2789

Filter replaces John Deere PT11025 (3.5 & 4 hp) Max series engines.

Order No. 19 - 8482

Prefilter.



Length 7-1/2"
Width 4-1/2"
Height 2"

Order No. 19 - 13049

Air filter replaces John Deere MIU11286. Used with our 19-9304 prefilter.

30

O.E.M.



O.E.M. REPLACEMENT

JOHN DEERE (Cont.)



Length 5-3/16"
Width 3-1/8"
Height 2-3/8"

Order No. 19 - 2778

Replaces John Deere AM37816. Fits 11 hp I.C. series hp vertical engine.



OD 8"
ID 5-1/2"
Height 2-1/2"

Order No. 19 - 10880

Air filter replaces John Deere M149118. Also replaces Kawasaki 11013-7022, 11013-7023. Fits John Deere models X465, 737, and 757 Mid Mount Z tracks. Fits Kawasaki 20-21 hp model FH641D. Uses our 19-7050 Prefilter.



Order No. 19 - 6600

Oil Filter. Replaces John Deere AM107423. 25/30 Micron.

Order No. 19 - 7916

Hydraulic Transmission filter replaces John Deere AM101207, GY20577. 25/30 Micron.



Order No. 19 - 6677

Oil Filter. Replaces John Deere AM101207, AM101054. Fits (18 and 20 hp) twin cylinder engine models B43 and B48. 25/30 Micron. 3.529" height, 2.966" OD, Thread size 3/4 -16.



Order No. 19 - 6681

Oil Filter. Replaces John Deere AM101378. Fits model GX360K1 (water cooled) engines, tractor models 3813 and 4514. 25/30 Micron. Fits models F22100 & F22400. 3.194" height, 3.252" OD, Thread size 20 x 1.5mm



Order No. 19 - 5909

Oil Filter. Replaces John Deere AM101207. Fits all Vanguards and twin cylinder engines. 25.5 Micron. 3.404" Height, 2.921" OD, Thread size 3/4 - 16



OD 2.921"
Thread Size 3/4-16"
Height 2.707"

Order No. 19 - 12861

Oil filter discount pack replaces John Deere AM125424.

MIN012



OD 2.921"
Thread Size 3/4-16"
Height 2.707"

Order No. 19 - 12862

Oil filter discount pack replaces John Deere AM101207.

MIN012

Order No. 19 - 12864

Oil filter discount pack replaces John Deere AM107423.

MIN012



OD 2.685"
Thread Size 3/4-16"
Height 2.977"



Order No. 20 - 2235

Vented Fuel Cap. Replaces John Deere.



Diameter 3-1/2"

Order No. 20 - 9650

Vented fuel cap replaces John Deere RE64733.

30

O.E.M.

**O.E.M. REPLACEMENT
JOHN DEERE (Cont.)**



Order No. 20 - 12074

Gas cap gauge replaces John Deere AM39206 Fits 300 series tractors. For 9" tank depth, 2-1/4" dia.



Order No. 25 - 7723

Starter handle replaces John Deere PT10615.



Order No. 21 - 13343

15" High back seat. **Yellow Vinyl**, 24 x inserts universal bolt pattern. Replaces John Deere M131157.



Order No. 21 - 13346

18" High back seat. **Yellow Vinyl**, 24 x inserts universal bolt pattern. Replaces John Deere VG11696.



Order No. 21 - 13358

20" High back seat. **Yellow Vinyl**, 24 x inserts universal bolt pattern. Replaces John Deere TCA13830. Heavy Duty



Order No. 23 - 12111

Oil drain valve (Metric M16 x 1.5) threads. Replaces John Deere AM115362.



Order No. 26 - 12430

Electric starter replaces John Deere AM108615. Fits FC540V.



Order No. 26 - 12279

Electric starter replaces John Deere AM133636.



Order No. 26 - 12281

Electric starter replaces John Deere AM108390. Delco style starter.



Order No. 26 - 13379

Electric starter replaces John Deere AM132303/MIA10967. engines. Used on John Deere 23-27 hp engines.

Order No. 31 - 10723

Ignition switch replaces John Deere AM101561 & Great Dane TCA15075. Fits models RX63, RX95, RX85, & SRX 75 & SRX 95, F series and Gator. For magneto ignition, 6 terminal, 3 position. 20 mm x 1.25" mounting stem. Uses our **31-12128** keys

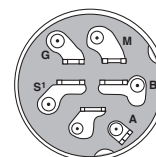

30

O.E.M.



JOHN DEERE (Cont.)



Order No. 31 - 11218

Ignition key replaces John Deere AM123426 & GY20680. Stamped, stainless steel. Fits Delta switches. MIN010



Order No. 31 - 11219

Ignition key John Deere AM123426 & GY20680. Plastic covered. Fits Delta switches. MIN010

Order No. 31 - 12128

Ignition key replaces John Deere AM131841 / AM101600. Fits our 31-10723 switch. (Contains 5 sets of keys with ring.) MIN010

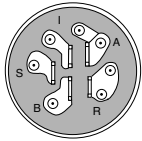

Order No. 31 - 8601

Key switch replaces John Deere AM103286 & AM32318. For battery ignition, 9/16" mounting stems.

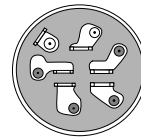

Order No. 31 - 9166

Ignition switch replaces John Deere AM38227. For John Deere front mount mowers. Fits series 300 and some 200's. (Magneto)

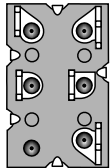

Order No. 31 - 7675

PTO switch replaces John Deere AM39489.

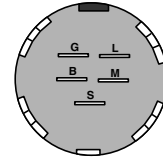

Order No. 31 - 9655

Ignition switch replaces John Deere AM122881. Snap in mounted, 3 position switch. Uses our 31-9667 key.

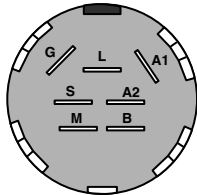

Order No. 31 - 7015

Ignition switch replaces John Deere GY20074.

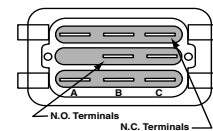

Order No. 31 - 9657

PTO switch replaces John Deere AM118802, AM119139. Middle terminal blank. Push-pull/Snap in mount.



Order No. 31 - 12685

Heavy duty ignition switch with keys replaces John Deere GY20074. Similar to our 31-7015 but heavy duty.



Order No. 31 - 14248

PTO switch replaces John Deere GY20939. Fits models D60, D170, LA130-LA175, X130R-X165. 8 terminals.

Order No. 31 - 9658

Plunger Interlock switch replaces John Deere AM108483. Single pole, normally closed.



30

O.E.M.



**O.E.M. REPLACEMENT
JOHN DEERE (Cont.)**

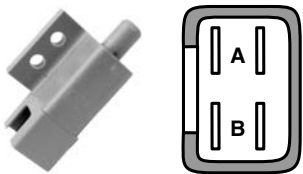

Order No. 31 - 9659

Plunger Interlock switch replaces John Deere AM128925. Double pole, normally open / normally closed.

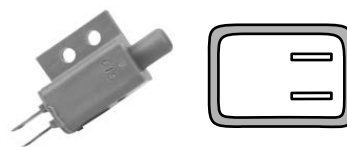

Order No. 31 - 9660

Plunger Interlock switch replaces John Deere AM104884. Single pole, normally open.



Order No. 31 - 9666

Twist lock seat switch replaces John Deere AM119943. Single pole, twist lock mount. Normally closed.



Order No. 31 - 14268

Seat switch replaces John Deere AM130453. Fits models 115, 145, 155c, 190c, La110, La140, La150, X120, X140, La135, La165, La175, D160 100 series, D170 100 series, X165 100 series. Twist lock mount. For seats with 2-3/4" hole. Positions (2), 4 terminals, (N.C./N.C.)



Order No. 31 - 9664

Plunger Interlock switch replaces John Deere AM104403. Single post, right angle snap in mounted. Normally closed.



Order No. 31 - 9663

Plunger Interlock switch replaces John Deere AM103119. Single post, right angle snap in mounted. Normally open.



Order No. 31 - 14246

Plunger safety switch replaces John Deere GY20073. Low profile double pole plunger switch N.C./N.C. 4 terminal. Fits John Deere models 102, 105, 108, 115, 125, 135, 14.542GS, 145, 155C, 1642HS, 17.542HS, 1742HS, 190C, G100, G110, L100, L105, L107, L108, L110, L111, L118, L120, L130, L1742, L2048, L2548, LA100, LA105, LA110, LA115, LA120, LA125, LA130, LA135, LA140, LA145, LA150, LA155, LT150, LT160.



Order No. 31 - 14247

Plunger safety switch replaces John Deere AM131549. Fits John Deere LT150, LT160, LT170, LT180, LT190 and LTR180. Low profile double pole plunger switch. 4 terminal switch in NC/NO.



Order No. 31 - 10677

Solenoid replaces John Deere AM132990, AM133094, AM130365. Heavy Duty.



Order No. 31 - 14220

Solenoid starter replaces MTD 725-04439, John Deere AM138068. No hardware, 1/4" terminal studs.

30

O.E.M.



JOHN DEERE (Cont.)

Order No. 31 - 14029

Voltage regulator replaces John Deere M97348, AM126304, M70121. This is the new style heavy duty regulator. The plug part number AM108848 is included. Fits models 240, 245, 260, 265, 285, 320, 425, 445, 455, 325, 335, 345, 355D, LX172, LX176, LX178, LX186, LX188, LX277, LX279, LX289, X475, X485, X495, X575, X585.



Order No. 31 - 12802

Voltage regulator replaces John Deere models 318-420 with Onan engines.



Order No. 31 - 8969

Voltage regulator replaces John Deere AM34738, AM106357. Fits 8 - 24 hp engines with 15 amp alternators, in line terminals 3 in a row.



Order No. 31 - 9334

Single terminal electronic ignition module. Fits John Deere M70114.



Order No. 41 - 8635

Universal snowblower shoe. Fits John Deere.



Order No. 41 - 5568

Snowblower shoe. Fits John Deere.



Order No. 41 - 5134

Snowblower Runner. Double sided, reversible runner fits John Deere. Painted orange.

30

O.E.M.

KLIPPO

ORDER NO.	REPLACES O.E.M. NO.	LENGTH	CENTER HOLE DIAM.	OUTSIDE HOLE DIAM.	CENTER TO CENTER	WIDTH	STEEL THICK.	APPLICATION
15 - 50148	60-00-4	18-7/8" 475.45mm	35/64" 13.89mm			2-1/4" 2.25mm	.150" 3.8mm	
15 - 10376	90-805R	20-11/16" 525.5mm	.565" 14.3mm			2-1/2" 63.5mm	.150" 3.8mm	
15 - 50147	60-04-4	20-7/8" 530.22mm	9/16" 13.89mm			2-1/4" 57.15mm	.150" 3.8mm	

O.E.M. REPLACEMENT
KYNAST



ORDER NO.	REPLACES O.E.M. NO.	LENGTH	CENTER HOLE DIAM.	OUTSIDE HOLE DIAM.	CENTER TO CENTER	WIDTH	STEEL THICK.	APPLICATION
 15 - 50123	3R-1668	18-5/8" 473.08mm	.782" 20.00mm	.41" 10.72mm	1.56" 39.69mm	2.75" 69.85mm	.125" 3.18mm	

KUBOTA

30



ID 15/32"
Width 3-7/8"
Height 2-1/2"



ID 15/32"
Width 3-13/16"
Height 3-3/4"

Order No. 07 - 8299

Deck wheel replaces Kubota 76505-46250. Used on 44", 48" and 54" decks, models G series, B1550, 1750 and 2350.





Order No. 07 - 8300

Deck wheel replaces Kubota 76543-46250, 76559-46250. Fits RC40G, G4200, G5200, 40", 44" & 48" deck.













Order No. 07 - 14473

Plastic deck wheel replaces Kubota K5668-42100. Fits models ZD321, ZD326 with 60" & 72" decks.

ORDER NO.	REPLACES O.E.M. NO.	LENGTH	CENTER HOLE DIAM.	OUTSIDE HOLE DIAM.	CENTER TO CENTER	WIDTH	STEEL THICK.	APPLICATION
 15 - 3386	70712-34330	15-5/16" 388.9mm	11/16" 17.5mm	.338" 8.6mm	1-1/2" 38.1mm	2" 50.8mm	.204" 5.2mm	(3) blades for 44" cut Model RC44-G
 15 - 14096	K5576-34350	16-1/2" 419.1mm	.890" 22.6mm			2-1/2" 63.5mm	.250" 6.4mm	Fits model H30T, series GR, ZG200, ZD200. (3) blades for 48" cut
 15 - 3387	70721-34330	16-5/8" 422.3mm	11/16" 17.5mm	.338" 8.6mm	1-1/2" 38.1mm	2" 50.8mm	.204" 5.2mm	(3) blades for 48" cut Model MR4800
 15 - 6208	76500-34330	16-5/8" 422.3mm	.719" 18.26mm			2" 50.8mm	.204" 5.2mm	(3) blades for 48" cut Fits models RC62, 72 & 82 Deck #RC48-62H, RC48-62A/F & RC48G



KUBOTA (Cont.)

ORDER NO.	CODE	REPLACES O.E.M. NO.	LENGTH	CENTER HOLE DIAM.	OUTSIDE HOLE DIAM.	CENTER TO CENTER	WIDTH	STEEL THICK.	APPLICATION
15 - 14488		K5619-34350	18-5/8" 457.2mm	.890" 22.6mm			2-1/2" 63.5mm	.250" 6.4mm	Fits model H30T, series ZG & ZD models. K446 (3) blades for 54" cut.
15 - 14483		K5351-34342	18-5/8" 457.2mm	.890" 22.6mm			2-1/2" 63.5mm	.250" 6.4mm	K424 (3) blades for 54" cut
15 - 14095		K5617-34330	18-5/8" 457.2mm	.715" 18.1mm			2-1/2" 63.5mm	.250" 6.4mm	Fits model H30T, series 2G127,ZG23,GR2100/2110 BX-RCK54P models. K327 (3) blades for 54" cut.
15 - 6265		76529-34330	18-11/16" 474.7mm	1-1/8" 28.6mm			2-1/2" 63.5mm	.240" 6.1mm	(3) blades for 54" cut. rider mowers. Fits G1800, 1900 & 2000 models.
15 - 3388		70722-34330	20-7/16" 519.1mm	11/16" 17.5mm			2" 50.8mm	.204" 5.2mm	(3) blades for 60" cut Models MR6000, RCB60-1/E/AE, RC60-71H, RC60-72/A, RC60-27
15 - 3389		76540-34330	20-15/32" 519.9mm	15/16" 23.8mm			2-1/4" 57.2mm	.240" 6.1mm	For models RC60-20, RC60-F20, RC60-25
15 - 6209		K5647-3433 76539-34330 K5649-3434	20-1/2" 520.7mm	1-1/8" 28.6mm			2-1/2" 63.5mm	.240" 6.1mm	(3) blades for 60" cut. Fits tractor models B2150, B1750, B7100HSD, B1550, FZ2100, FZ2400, G1900 & G2000 with deck models:RC60-21B, RC60-71B, 60B, 60F221 & 60GO
15 - 11558		76539-34330	20-1/2" 520.7mm	1-1/8" 28.6mm			2-1/2" 63.5mm	.240" 6.1mm	Fits models B2150, B1750 B7100HSD, B1550, FZ2100, FZ2400, G1900, G2000. (3) blades for a 60" cut. Commercial Mulcher
15 - 14481		K5371-34340	20-1/2" 520.7mm	.890" 22.6mm			2-1/2" 63.5mm	.250" 6.4mm	K472 (3) blades for 60" cut
15 - 14482		K5112-71940	20-1/2" 520.7mm	.715" 18.2mm			2-1/2" 63.5mm	.250" 6.4mm	K132 (3) blades for 60" cut
15 - 6173		65621-37-212	20-11/16" 525.5mm	3/4" 19.1mm	9/16" 14.3mm	3-17/32" 89.7mm	2-1/4" 57.2mm	.150" 3.8mm	Fits 5 hp 21" self- propelled Walk behind, elec. start Model W50021SCE

30
O.E.M.

O.E.M. REPLACEMENT
KUBOTA (Cont.)



ORDER NO.	REPLACES O.E.M. NO.	LENGTH	CENTER HOLE DIAM.	OUTSIDE HOLE DIAM.	CENTER TO CENTER	WIDTH	STEEL THICK.	APPLICATION
15 - 12995	 K5677-34340	24-7/16" 609.6mm	1-1/8" 25.4mm			2-1/2" 63.5mm	.240" 6.1mm	Fits model H30T, series ZD28, ZD326, ZD331 ZTR RCK72P-28Z models. K462 (3) blades for 72" cut.
15 - 6207	76550-34330	24-9/16" 623.9mm	15/16" 23.8mm			2-1/2" 63.5mm	.240" 6.1mm	(3) blades for 72" cut. Fits tractor models L2850, L2550, F2100, F2100F & F2400 with deck models RC72-78, RC72-F25, RC72-F20 & RC72-F24

30

Order No. 17 - 12829

Blade locking bolt replaces Kubota 76539-3437-2. Fits 19.5mm center hole blades including deck models: RC-54-G20, RC-54-F20, RC-60-21B, RC-60-G20, RC-60-FZ21, RCK-24B, RC-72-F30. Shoulder 19.5mm, Length 32mm, Allen head recess 14mm.



O.E.M.



OD 2-1/8"
ID 1-5/8"
Height 9-1/4"

Order No. 19 - 13384

Inner Air filter replaces Kubota K3181-82250. Fits ZD326 diesel zero turn mower with Kubota D1005, 3 cylinder diesel.

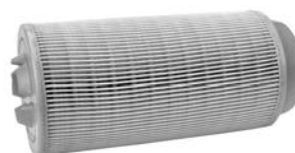

OD 4-1/2"
ID 2-1/2"
Height 9-3/4"

Order No. 19 - 13383

Air filter replaces Kubota K3181-82240. Fits ZD326 diesel zero turn mower with Kubota D1005, 3 cylinder diesel.



Order No. 19 - 9550

Air Filter replaces Kubota K1211-82320. Fits out 19-9616 assembly.



ID 1-11/16"
OD 3-1/4"
Height 7-1/4"

Order No. 19 - 8327

Air filter replaces Kubota 15852-11082. Fits models B20, B1550, B1750, D, E, HSD, HSE, HST, G-1800S, G-1900HST, G-2000, G-2000S, G-3200, G4200H, G-5200H, G-6200H.

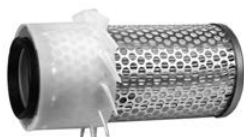

ID 1-11/16"
OD 3-9/32"
Height 7-1/4"

Order No. 19 - 8279

Air filter replaces Kubota 70000-11221 & 15222-11221. Fits models B5100, B5200, B6100, B6100DT, B6100HST, B7100, B7100Dt, B7100HST, B8200HST, L225, L225DT, L235, L245, L245DT, L245H, L260H, L275. (21 & 24 hp)

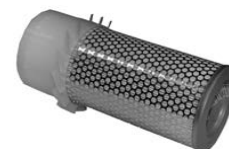

ID 2-1/2"
OD 4"
Height 10-1/4"

Order No. 19 - 8328

Air filter replaces Kubota 70000-11081. Fits models L275, 285, 295, 295DT, 305, 345, 345DT, 355SS, 2250, 2550, 2850, 2650, 2950, 3450, 3650, M4000, 4050, 4500, 4500C, 4500DT.



KUBOTA (Cont.)

ID 5-1/2"
OD 7"
Height 3"



Order No. 19 - 8329

Filter replaces Kubota 2408303. Fits CH25 Command 25 hp OHV engines. Also fits CV18, 20 & 22.

Order No. 19 - 8966

Prefilter replaces Kohler 23-083-02. Prefilter for our 19-8329 air filter.

Length 8"
Width 2-1/8"
Height 2"



Order No. 19 - 7046

Filter & Prefilter replaces Kubota 12681-11220. Used on 5 hp self propelled mowers.

Order No. 19 - 7047

Prefilter.

30



Order No. 19 - 10883

Replaces Kubota 15853-32430.



Order No. 19 - 12120

Oil filter replaces Kubota 15241-32090. Fits many B, BX, G, F, U and ZD series Kubota's. Fits diesel engines.

O.E.M.



Order No. 20 - 8936

Fuel cap replaces Kubota K1122-24122.

OD 1-1/8"
ID 1/2"
Length 3-3/8"



Order No. 20 - 13536

Fuel filter replaces Kubota 15231-443560. Fits models G4200, G5200, G6200, B1550, B20, B1500, B1750-B7100; all B series and older G series 29 tractor models.



Order No. 20 - 9146

Fuel filter replaces Kubota 12581-43012. Fits larger horse power models. 10 micron. Fits 5/16" fuel line.

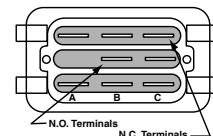

Order No. 31 - 9657

PTO switch replaces Kubota K1211-62231. Middle terminal blank. Push-pull/Snap in mount. Red Knob.

O.E.M. REPLACEMENT



LAWN-BOY

(Also see Toro/Wheel Horse)



Order No. 05 - 2953

Drive Roller replaces LB 607657. (left hand)

Order No. 05 - 2958

Drive Roller replaces LB 607658. (right hand)



Order No. 05 - 3270

Drive Roller. Replaces Lawn-Boy 610441. For 21" self-propelled high speed mower. (left hand)

Order No. 05 - 3269

Drive Roller. Replaces Lawn-Boy 610440. For 21" self-propelled high speed mower. (right hand)

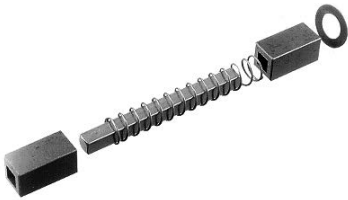

Order No. 05 - 3271

Drive Shaft. Replaces Lawn-Boy 683129. Engine to gear box drive shaft assembly for self-propelled mowers.

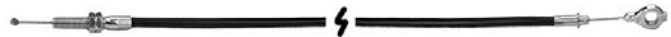

Order No. 05 - 9126

Control cable replaces Lawn-Boy 682685. Fits 21" cut self-propelled steel deck, rear discharge models.

Conduit 55-1/4"
Inner Wire 64"
Wire Travel 8"

Order No. 05 - 300

Drive Disc, replaces Lawnboy 741316.



ID 3"
OD 6"



Order No. 06 - 2999

10" x 1.75" Heavy Duty Steel Wheel. 1/2" bearing, 2" offset hub length and zerk fitting. Replaces Lawnboy 153802. (painted red)



Order No. 06 - 2989

Replaces Lawn-Boy 678637, 682974, 678638 and 682972. For standard push and self-propelled mowers. 8" x 1.75, 1-1/2" hub, 1/2" bearings. (painted white)



Order No. 06 - 2976

8" Heavy Duty Commercial Wheel and zerk fitting. Replaces Lawn-Boy 681980, 678406. 8" x 1.75, 2" hub, 1/2" bearing. (painted orange)

Order No. 06 - 2977

6" Heavy Duty Commercial Wheel and zerk fitting. Replaces Lawn-Boy 681979, 678513. 6" x 1.50, 2" hub, 1/2" bearing. (painted orange)



Order No. 06 - 2965

6" x 1.50 Steel Wheel, 1-1/2" hub. Oilite Bushing. Replaces Lawn-Boy 678636. (painted white)

Order No. 06 - 2980

8" x 1.75 Steel Wheel, 1-1/2" hub. Oilite Bushing. Replaces Lawn-Boy 678637 and 682974. (painted white)

Order No. 06 - 2966

8" Self-Propelled Steel Wheel. Oilite Bushing. Replaces Lawn-Boy 678638 and 682972. Soft Tire. (painted white)

30

O.E.M.



LAWN-BOY (Cont.)

Order No. 07 - 6915

Deck Wheel replaces Lawn-Boy 740280. 1-1/2" centered hub, 1-1/2" center hole steel bushing. ID 1/2", width 1-3/8", height 5".



Order No. 07 - 6918

Deck Wheel replaces Lawn-Boy 705533. 1-1/2" centered hub, 1-1/2" center hole. ID 1/2", width 1-3/8", height 6".



ID 5/8"
Width 2"
Height 6"



ID 1/2"
Width 1-1/2"
Height 4"

Order No. 07 - 6919

Deck Wheel replaces Lawn-Boy 702804. 2-1/8" offset hub.

Order No. 07 - 6914

Deck Wheel replaces Lawn-Boy 701756. 1-1/2" offset hub.



ID 5/8"
Width 2-3/4"
Height 5"



ID 17/32"
Width 1-3/8"
Height 5-3/4"

Order No. 07 - 6917

5" x 2-3/4" Deck Wheel. Replaces Lawnboy 68-2730. 2-1/2" offset hub. Uses our 09-8586 bushing.

Order No. 07 - 3320

Deck Wheel. Replaces John Deere 32639, 54223. 1-3/8" offset hub.



ID 1/2" (12.70 mm)
OD 7/8" (22.23 mm)
Height 29/32" (23.02 mm)



Order No. 09 - 6542

Sleeve and Bearing Assembly. Replaces Lawn-Boy 681904. Used on Lawn-Boy self propelled mowers. MIN010

Order No. 10 - 2964

Wheel Bolt. Replaces Lawn-Boy 603441. Thread Run 3/8"-16, thread lgth 3/8", Shoulder lgth. 1-9/16". MIN010

Order No. 10 - 440

Felt washer for wheel bolt. Replaces Lawn-Boy 605255. MIN010



30



O.E.M.

**O.E.M. REPLACEMENT
LAWN-BOY (Cont.)**



- Order No. Description**
12 - 5012 3/8" (9.53 mm) x 29" (736.6 mm). Replaces Lawn-Boy 602956.
12 - 5014 3/8" (9.53 mm) x 31" (787.4 mm). Replaces Lawn-Boy 609957.
12 - 5027 3/8" (9.53 mm) x 44" (1117.6 mm). Replaces Lawn-Boy 610040.

30
O.E.M.

ORDER NO.	REPLACES O.E.M. NO.	LENGTH	CENTER HOLE DIAM.	OUTSIDE HOLE DIAM.	CENTER TO CENTER	WIDTH	STEEL THICK.	APPLICATION
 15 - 848	612079-03	18-15/16" 481mm	5/8" 15.9mm	17/32" 13.5mm	2-9/16" 65.1mm	3" 76.2mm	.134" 3.4mm	For Scamp Mowers
	612079							
	682909							
 15 - 1057	603703	20-3/4" 527.1mm	5/8" 15.9mm			2-1/2" 63.5mm	.134" 3.4mm	
 15 - 849	612543-03	20-7/8" 530.2mm	5/8" 15.9mm	17/32" 5.6mm	2-9/16" 65.1mm	3" 76.2mm	.134" 3.4mm	For 21" Tri cut (Std.)
	612543							
	683682							
	608094							



LAWN-BOY (Cont.)



Order No. 16 - 1145

Edger Blade. For Lawn-Boy, 8-15/16" length, 2" width, 1/2" C.H., .150" thick.



Order No. 17 - 2220

Blade Adaptor. Replaces Lawn-Boy 677525.



Order No. 18 - 2955

Exhaust Sleeve. Replaces LB 602717.

MIN010

Length 5-1/2"
Width 3"
Height 1-1/4"



Order No. 19 - 10183

Air filter replaces Lawn-Boy 95-5574. Fits late model 2-cycle mowers. Gold & Silver series.



Length 6-1/2"
Width 3-7/8"
Height 7/8"



Order No. 19 - 6659

Filter replaces Lawn-Boy 613361. Fits all M series engines including oil injected.

Order No. 19 - 6660

Pre-filter replaces Lawn-Boy 614245, 613435.

Length 4"
Width 2"
Thickness 7/8"

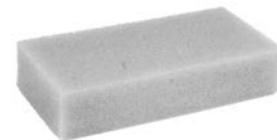

Order No. 19 - 1379

Filter replaces Lawn-Boy 607580. Application: Fits C & D series engines.



Length 4-1/2"
Width 2-1/2"
Thickness 1"

Order No. 19 - 1380

Filter replaces Lawn-Boy 609493. Fits F series engines from 1978 & up.

OD 3-1/4"
Thickness 1-1/4"



Order No. 19 - 1378

Filter replaces Lawn-Boy 604274. Application: Fits C, D & F series and older models.

Width 2-1/4"
Thickness 1-7/16"



Order No. 19 - 2779

Filter replaces Lawn-Boy 602016. Fits C & D series engines.

30

O.E.M.

**O.E.M. REPLACEMENT
LAWN-BOY (Cont.)**



Order No. 20 - 1350

Gas Cap. Replaces Lawn-Boy 681446.



Order No. 20 - 7236

Primer Bulb replaces Lawn-Boy 607310. Used on 1974 & newer models. MIN010



Order No. 20 - 7238

Fuel cap replaces Lawn-Boy 682755. Used on D & F series.

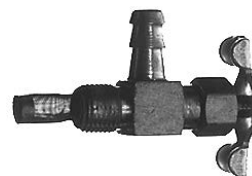

Order No. 20 - 1347

Elbow Cut-Off with Screen. 1/8" pt. - 1/4" Nipple. Replaces Lawn-Boy 677052. MIN010



Order No. 22 - 12304

Carburetor float bowl. Fits models LMR. For Lawnboy engines with Walbro carburetors. 1.860" OD x 1" HT. Small Walbro #20-141.

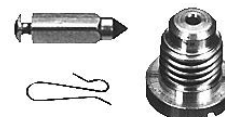

Order No. 22 - 2950

Needle and Seat. Replaces Lawn-Boy 681741 and 678882.



Order No. 22 - 1421

Carburetor Repair Kit. Replaces Lawn-Boy 678415. Fits all "C" and "D" series engines.



Order No. 23 - 2956

Oil Seal. Replaces Lawn-Boy 611396, 609342. Fits "C", "D" and "F" series. MIN010



Order No. 23 - 8369

Carburetor mounting gasket replaces Lawn-Boy 612574. Fits all new Lawn-Boy, carburetor to block gasket. MIN010

30

O.E.M.



LAWN-BOY (Cont.)



Order No. 23 - 2954

Piston Ring Set. Replaces Lawn-Boy 681737.

Order No. 23 - 1464

Piston Ring Set. Replaces LB 679252. (2 Ring Set)

Order No. 23 - 2749

Piston Assembly (Std.). Replaces Lawn-Boy 682986. Fits "F" series engines.



Order No. 25 - 2230

Starter Handle. Replaces Lawn-Boy 606863.



Order No. 25 - 1302

Special #4-1/2 stiff rope for Lawn-Boy mower engines. 200 ft.



Order No. 23 - 2970

Repl. LB 609420 muffler gasket F series. MIN010

Order No. 23 - 2972

Replaces LB 609419 Gear Box Gkt F series. MIN010

Order No. 23 - 2973

Repl. LB 602763 Crk. Case. D & E Series. MIN010

Order No. 23 - 2974

Replaces LB 608362 Reed Plate Gasket MIN010

Order No. 23 - 2759

Repl. LB 604116 Head Gkt. C & D Series. MIN010

Order No. 23 - 2971

Replaces LB 609476 Carb. Gkt. F series. MIN010

Order No. 23 - 3550

Replaces LB 602052 Carb. Throat Gkt. MIN010

Order No. 23 - 3544

Replaces LB 604283 D Bowl Gasket. MIN010

Order No. 23 - 2758

Repl. LB 678071 Gasket Set C or D series.



Order No. 26 - 2241

Starter Pinion Gear. Replaces LB 607547. MIN010

Order No. 26 - 2959

Starter Pinion Gear. Replaces LB 609133. MIN010

Order No. 26 - 2240

Retainer Clip. Replaces Lawn-Boy 604260. MIN010

Order No. 26 - 2957

Retainer Clip. Replaces Lawn-Boy 609229. MIN010



Order No. 26 - 7722

Starter rewind pulley replaces Lawn-Boy 610032. Fits mowers from 1972-1983.

Order No. 26 - 1333

Starter Spring. Repl. LB 604257 For D series. (narrow)

Order No. 26 - 2463

Starter Spring. Repl. LB 683210. Fits 1984 and 85 F models. (wide)

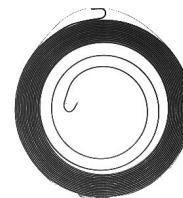

30

O.E.M.

O.E.M. REPLACEMENT



LAWN-BOY (Cont.)



Order No. 27 - 7235

Bump Head Knob. Replaces Lawn-Boy 682069 and Ryan 153066.



Order No. 27 - 7206

Air filter. Replaces Lawn-Boy 610312. Fits models 261, 262, 263, 264, 264-1, 265, 265-T, 265-1, 274, 275, 275-1, 284, 285, 500, 500-1, 520, 520-1, 540, 540-1, 580 and 580-1 trimmers. MIN005



Order No. 27 - 10206

Fuel line and filter assembly. Fits Lawn-Boy and others. 6" x 1/8" fuel line.

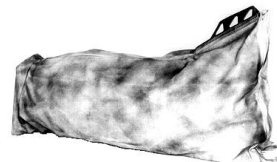

Order No. 28 - 1994

Grass Bag. Replaces Lawn-Boy 679966.

30

O.E.M.

Order No. 31 - 1897

Solid State Ignition Module. Replaces Lawn-Boy 100-2949, 682340 & 681578. Used on Lawn-Boy noncompliance F series engines with manual start ground-to run, 1978-1982 models. Also used on some small outboard engines.



Order No. 31 - 1898

Solid State Ignition Module. Replaces Lawn-Boy 100-2948, 683215. Used on Lawn-Boy compliance F series engines open-to run, 1983 & up.



Order No. 31 - 5933

Universal Solenoid. Replaces Lawn-Boy 740207.



Order No. 31 - 10772

Universal starter solenoid 4 pole, 12 volt. Terminal post will accommodate both 5/16" & 1/4" terminal connectors, Mounting bracket will accommodate both chassis and wall mount configurations. Replaces Lawnboy 740207.















Order No. 31 - 9622

Multi-application ignition switch. Fits Lawn Boy. Includes key, lockwasher nut. 2 terminals/ 2 positions.

O.E.M. REPLACEMENT



LESCO





ORDER NO.	REPLACES O.E.M. NO.	LENGTH	CENTER HOLE DIAM.	OUTSIDE HOLE DIAM.	CENTER TO CENTER	WIDTH	STEEL THICK.	APPLICATION
 15 - 3403	021871	16-1/2" 419.1mm	5/8" 15.9mm			2-1/2" 63.5mm	.204" 5.2mm	(3) blades for 48" cut
 15 - 6009	050111	16-1/2" 419.1mm	5/8" 15.9mm			3" 76.2mm	.204" 5.2mm	(3) blades for 48" cut
 15 - 6300	21871	16-1/2" 419.1mm	5/8" 15.9mm			2-1/2" 63.5mm	.204" 5.2mm	Mulching Blade PATENTED
 15 - 3404	050125	18" 457.2mm	5/8" 15.9mm			2-1/2" 63.5mm	.204" 5.2mm	(2) blades for 36" cut (3) blades for 52" cut.
 15 - 3442	050140 482467	18" 457.2mm	5/8" 15.9mm			3" 76.2mm	.204" 5.2mm	(2) blades for 36" cut (3) blades for 52" cut High lift
 15 - 10173	050140	18" 457.2mm	5/8" 15.8mm			2-1/2" 63.5mm	.204" 5.2mm	Flat Blade Sharpened - 4-sides
 15 - 6294	050140 50125	18" 457.2mm	5/8" 15.9mm			2-1/2" 63.5mm	.204" 5.2mm	Mulching Blade PATENTED
 15 - 9968	050140	18" 457.2mm	5/8" 15.8mm			2" 50.8mm	.240" 6.1mm	Low-Lift Blade Sharpened - 4-sides
 15 - 6008	050156 482129	20" 508mm	5/8" 15.9mm			2-1/2" 63.5mm	.204" 5.2mm	
 15 - 3434	050170	21" 533.4mm	5/8" 15.9mm			2-1/2" 63.5mm	.204" 5.2mm	(3) blades for 61" cut
 15 - 10174	050170	21" 533.4mm	5/8" 15.8mm			2-1/2" 63.5mm	.204" 5.2mm	Flat Blade Sharpened - 4-sides
 15 - 6299	050170	21" 533.4mm	5/8" 15.9mm			2-1/2" 63.5mm	.204" 5.2mm	Mulching Blade PATENTED
 15 - 9969	050170	21" 533.4mm	5/8" 15.8mm			2" 50.8mm	.240" 6.1mm	Low-Lift Blade Sharpened - 4-sides

30

O.E.M.



MARINA

ORDER NO.	REPLACES O.E.M. NO.	LENGTH	CENTER HOLE DIAM.	OUTSIDE HOLE DIAM.	CENTER TO CENTER	WIDTH	STEEL THICK.	APPLICATION
 15 - 10199	CP042013	16-17/64" 413.1mm	13/32" 10.3mm	5/16" 7.9mm	2-9/16"2-13/64"	56mm	.160" 4.1mm	Fits model GT42B.
 15 - 10198	CP047010	18-3/32" 459.6mm	45/64" 17.9mm	5/16" 7.9mm	1-49/64"2-13/64"	56mm	.160" 4.1mm	Fits model GT47E
 15 - 10201	CP050013	18-49/64" 476.6mm	5/8" 15.9mm	5/16" 7.9mm	2-9/16"2-13/64"	56mm	.160" 4.1mm	Fits models GT50B/GT50SB
 15 - 10202	CP056103	20-11/16" 525.5mm	5/8" 15.9mm	5/16" 7.9mm	2-9/16"2-13/64"	56mm	.160" 4.1mm	Fits model GT56SB

30
O.E.M.

McLANE



Order No. 03 - 866

Replaces McLane 1013B. Negative Action Control. Used on B&S equipped edgers. Single lever control.

Conduit 40"
Inner Wire 42"
Wire Travel 1-5/8"



Order No. 06 - 2994

8" x 1.75", 1-3/4" centered hub, 7/16" bearing. Replaces McLane 2016-8. (painted orange)

Order No. 06 - 2995

7" x 1.50", 1-3/4" centered hub, 7/16" bearing. Replaces McLane 2016-7. (painted orange)

Order No. 06 - 2996

6" x 1.50", 1-5/8" offset hub, 7/16" bearing. Replaces McLane 2016-6. (painted orange)

O.E.M. REPLACEMENT



McLANE (Cont.)



ID 5/8" (15.88 mm)
OD 1-3/8" (34.93 mm)
Height 7/16" (11.11 mm)

Order No. 09 - 8199

High speed bearing, double sealed replaces McLane 2036 (chain case bearing). May be used with or without retaining clip. Fits Star Clipper edgers. Bearing No. 99502H-2RSNR.

Order No. 09 - 18199

High speed bearing. (carded)

MIN005



ID 5/8" (15.88 mm)
OD 1-3/8" (34.93 mm)
Height 7/16" (11.11 mm)

Order No. 09 - 481

Premium High Speed Bearing. Replaces McLane 2036. Double Sealed. Bearing No. 99502H-2RS(NR).

30



Description

Order No.

12 - 5052

Belt. Replaces McLane 1060. 1/2" (12.70 mm) x 19" (482.2 mm).

12 - 5053

Belt. Replaces McLane 4060. 1/2" (12.70 mm) x 20" (508 mm).

12 - 5063

Belt. Replaces McLane 2058. 1/2" (12.70 mm) x 30" (762 mm).

12 - 8780

Drive Belt. Replaces McLane 7102. 1/2" (12.70 mm) x 24.5" length (622.3 mm). Fits 21" self propelled rotary mower. Polyester cord construction.

12 - 8761

Engine Belt. Replaces McLane 1060. 1/2" (12.7 mm) x 19.5" length (494.92mm). Fits 1991-present, front throw reel mowers.

O.E.M.

Order No. 13 - 1262

Pulley. Replaces McLane 1063. Has keyway and set screw. 5/8" ID, 2-1/2" OD, 5/8" Width.



Order No. 13 - 1263

Pulley. Replaces McLane 1063-A. Has keyway and set screw. 3/4" ID, 2-1/2" OD, 5/8" Width.



Order No. 16 - 1145

8-15/16" length, 1/2" C.H, 2-1/4" width. Replaces McLane 2059-HD.

Order No. 16 - 2673

10" x 2", 1/2" C.H. Replaces McLane 2059-HD-10. See Section 16 for a complete listing of 1/2" center hole edger blades.

ID 1/2"
OD 2-3/32"



Order No. 17 - 424

Blade Washer. Replaces McLane 2044.

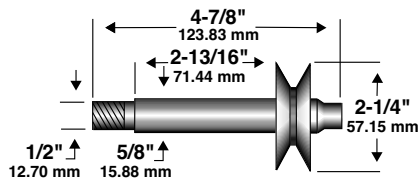

Order No. 16 - 1248

5/8" x 4-7/8" shaft with a 2-1/4" pulley. Replaces McLane 2033.



O.E.M. REPLACEMENT

MOUNTFIELD

Conduit 36-3/4" 935MM
 Length Extension 1-21/32" 42MM
 Wire Travel 1-13/32" 36MM



Order No. 03 - 10222

Throttle control replaces Mountfield RCL29004700. Fits Mountfield walkbehind mowers.

ORDER NO.	REPLACES O.E.M. NO.	LENGTH	CENTER HOLE DIAM.	OUTSIDE HOLE DIAM.	CENTER TO CENTER	WIDTH	STEEL THICK.	APPLICATION
 15 - 50022	M4358	18" 457.20mm	.629" 16.00mm	.281" 7.14mm	2.75" 69.85mm	2.85" 72.47mm	.117" 3.00mm	

30

O.E.M.

MTD



Order No. 02 - 9466

Hex head 5/16" - 18 x 3/4" self-tapping screw. Replaces MTD 910-12670. MIN010



ID 5/8"

Order No. 04 - 467

Heavy Duty Lock Collar. Replaces MTD 711-0169.



Order No. 04 - 461

Centrifugal clutch key 3/16" x 3/4". Replaces MTD 914-0122 & 714-0122. MIN010

Conduit 18-1/2"
 Inner Wire 21-1/2"
 Wire Travel 2-1/4"



Order No. 03 - 9569

Throttle cable replaces MTD 746-0776. Fits 95' - 98' MTD riders models 135 & 136 with B&S engines only.

Inner Wire 56-3/8"
 Spring Length 8-1/2"
 Wire Travel 2-3/4"



Order No. 03 - 9130

Throttle wire replaces MTD 746-0632, 746-0474. "Z" bend on each end.

Inner Wire 60"
 Spring Length 8-1/2"
 Wire Travel 2-1/2"



Order No. 03 - 9131

Throttle wire replaces MTD 746-0672. Fits walkbehind and self-propelled walkbehinds that require a 58" yellow cable.

O.E.M. REPLACEMENT



MTD (Cont.)

Conduit 45"
Inner Wire 47-3/8"
Wire Travel 2-5/8"



Order No. 03 - 9132

Throttle wire replaces MTD 746-0845. Fits 1992 & later push & self-propelled mowers with Tecumseh engines models, 081, 085, 087, 232-238, 280-282, 413, 415, 423, 425, 460, 478, 500, 508, 516, 518. "Z" bends on each end.

Conduit 51-1/4"
Inner Wire 53-5/8"
Wire Travel 2-1/2"



Order No. 03 - 9133

Throttle wire replaces MTD 746-0842. Fits 1992 & later push mowers with B&S engines. Fits models 030-040, 050-063, 070-088, 092-098, 108, 206, 260-265, 280-282, 440, 442, 450, 452, 460, 479, 500-508, 570. "Z" bends at both ends.

Conduit 55-3/8"
Inner Wire 57-3/4"
Wire Travel 2-1/2"



Order No. 03 - 9134

Throttle wire replaces MTD 746-0843. Fits 1992 & later push & self-propelled mowers with B&S engines. Fits models 083, 088, 123-238, 246, 328, 338, 414, 416, 418, 424, 426, 428, 446, 448, 456, 458, 460-479, 488, 518, 528. "Z" bends at both ends.

Conduit 51-3/4"
Inner Wire 52"
Wire Travel 1-11/32"

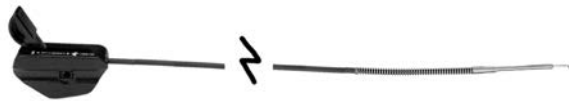

Order No. 03 - 9840

Throttle cable replaces MTD 746-0801. Fits MTD models 019, 070, 072, 080, 082, 200, 202, 220, 222, 280, & 282. "Z" bend.

Conduit 35"
Inner Wire 38"
Wire Travel 3"



Order No. 03 - 9855

Throttle cable replaces MTD 746-0634A. Fits MTD models 600-609, 660-669, 670-679, 690-699, series tractors with twin cylinder engines. Also fits series 820-829 & 840-849 tractors.

Conduit 37"
Inner Wire 42"



Order No. 03 - 10687

Throttle control replaces MTD 746-0630A. Fits walkbehind mowers. Z bend on each end.

Conduit 42"
Inner Wire 45"

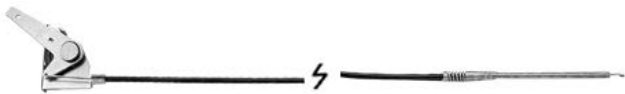

Order No. 03 - 10685

Throttle control replaces MTD 746-1086. Fits lawn tractor with B&S intek engines built from 1999 through 2002. Z bend on end.



Order No. 03 - 7717

Throttle control replaces MTD 931-0972, 731-0972. Fits 21" self propelled mower models 120-176, 120-178B, 120-466B, 120-468B, 120-476B & 120-478B.



Order No. 03 - 8417

Throttle control handle replaces MTD 831-0796A. Fits 36" cut model 132-431-E06, 38" cut models 132-657-F062, 139-652-352 & 46" cut model 140-848-H062.

Conduit 48"
Inner Wire 49-7/8"
Wire Travel 1-11/32"



Order No. 03 - 946

Plastic Conduit Control. 48" length, multiple detent. Used on MTD.

30

O.E.M.



MTD (Cont.)

Conduit 60"
Inner Wire 62-1/2"
Wire Travel 2-1/2"



Order No. 03 - 11516

Throttle cable replaces MTD 746-0841. Fits model series 370-389, 559, 959, 979, E979 & 999, 1997-2002 push and self propelled units. "Z" bend on end.

Conduit 42"
Inner Wire 44-1/2"
Wire Travel 2-1/2"

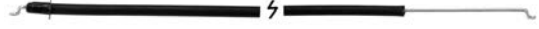

Order No. 03 - 11518

Throttle cable replaces MTD 746-0847 / 746-1115. Fits models 12A-998Q401, 11A-418Q118 & 12A-378Q118 Yardman. "Z" bend on end.

Conduit 25"
Inner Wire 28"
Wire Travel 1-5/8"

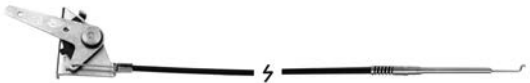

Order No. 03 - 11520

Throttle control assembly replaces MTD 746-1084.



Conduit 37"
Inner Wire 39"
Wire Travel 1-3/4"



Order No. 03 - 14624

Choke control cable replaces MTD/Cub Cadet 746-1085A. Fits models 1170, 1180, 1212, 1800, LT1042, LT1045, LT1046 & LT1050.

Conduit 42"
Inner Wire 48"
Wire Travel 2-1/4"



Order No. 03 - 9681

Choke control replaces MTD 746-0613A. Total length 49-1/2".

Conduit 34"
Inner Wire 39-1/4"
Wire Travel 1-1/2"



Order No. 03 - 9682

Choke control replaces MTD 746-0614A. Fits mid size rear engine riders. Total length 41".

Conduit 18-3/4"
Inner Wire 24-1/4"
Wire Travel 1-1/2"



Order No. 03 - 9683

Choke control replaces MTD 746-0616A. Total length 26".

Conduit 29"
Inner Wire 32"
Wire Travel 1-1/2"

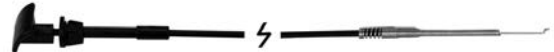

Order No. 03 - 11519

Choke cable replaces MTD 746-3021. Fits models 662-672 & 678. "Z" bend on end.

Conduit 53"
Inner Wire 57"

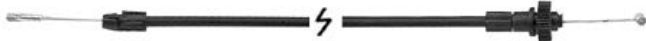

Order No. 03 - 10684

Drive cable replaces MTD 746-0713. Fits 21" walkbehind mowers.



Cable Length 38-1/4"
Overall Length 43"



Order No. 05 - 5616

Clutch drive cable replaces MTD 946-0898, 746-0898. Fits 600 model series snow throwers built 1995-2002 and 700 model series built in 2003. Model 312-610000 (1992), 313-610E120 (1993), 314-616E131 (1994) snowthrowers.

30

O.E.M.

O.E.M. REPLACEMENT



MTD (Cont.)

Conduit 40"
Inner Wire 46-3/8"



Order No. 03 - 10688

Engine stop cable replaces MTD 746-0550. Used on push mowers models: 040, 050, 060, 070, 080 & 090. Also used on self propelled models: 100, 200, 400, & 700. Z bend on each end.

Conduit 36-7/8"
Inner Wire 43-1/8"



Order No. 05 - 10817

Control cable replaces MTD 746-0553. Fits 1991 and newer push mowers with B&S engine models 030-042, 030-416, 030-418, 030-424, 030-426, 030-428, 030-446, 030-448, 030-456, 030-458, 030-506, 030-508, 030-570, 030-580, Z bend on each end.

Conduit 40"
Inner Wire 53"



Order No. 05 - 13264

Control cable replaces MTD 746-1130 / 946-1130. Fits 22" deck, series 038, 2003-2007. Z-bend on each end.

Conduit 76"
Inner Wire 79-1/2"
Wire Travel 3-1/4"



Order No. 05 - 13416

Variable speed drive cable replaces MTD 946-04206A. Fits walkbehind mowers.

Conduit 37-3/8"
Inner Wire 51"
Wire Travel 12"



Order No. 05 - 13332

Control cable replaces MTD 746-1113 / 946-1113.

Conduit 43"
Inner Wire 49-1/2"
Wire Travel 5-1/2"



Order No. 05 - 11511

Engine brake cable replaces MTD 746-0551. Fits model 440, E466 and 469 series. "Z" bend on end.

Conduit 49"
Inner Wire 53-1/2"
Wire Travel 5-1/2"



Order No. 05 - 11512

Engine brake cable replaces MTD 746-0552. Fits 1985 & up walkbehind model series 030, 040, 050, 060, 070, 080, 090, 100, 200, 400 & 700. For self-propelled model series 200, 400, & 700. Push in clip with heavy "Z" bend on each end.

Conduit 40-1/2"
Inner Wire 47"
Wire Travel 5-1/2"

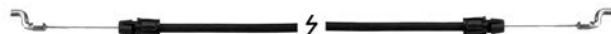

Order No. 05 - 11513

Engine brake cable replaces MTD 746-0554. Fits 1990-96 walkbehind model series 300, 400, & 500. For 1998 & up model series 070 & 100. For 1990 & up self propelled model series 300, 400, & 500. Die cast "Z-Bend" on each end.

Conduit 55"
Inner Wire 61-1/2"
Wire Travel 5-1/2"

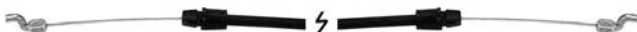

Order No. 05 - 11514

Engine brake cable replaces MTD 746-0555. For model 573, 20" deck, model 370-379, model 445, 21" rear-discharge. Die cast "Z" bend on each end.

Conduit 51"
Inner Wire 55-1/2"
Wire Travel 5-1/2"

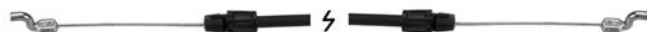

Order No. 05 - 11515

Engine brake cable replaces MTD 746-0737. For 1994-1997 walkbehind model series 070, 080, 100, 200, 400, & 500. Die cast "Z" bends on each end.

30

O.E.M.



MTD (Cont.)

Conduit 48-1/4"
Inner Wire 60-1/4"
Wire Travel 12-1/2"

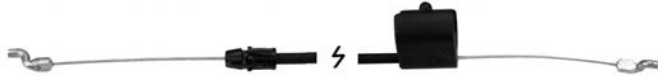

Order No. 05 - 11517

Engine brake cable replaces MTD 746-0946. Fits most side discharge mowers 1986 & prior. Snap fit to handle. "Z" bend on end.

Length 5-3/4"



Order No. 05 - 10686

Brake cable replaces MTD 746-0970. Fits 42" deck mowers. 3/8" eyelets on each end.

Order No. 05 - 13657

Deck engagement cable replaces MTD 946-04092 / 746-04092. Also replaces Toro. Outer casing 26" long.



Conduit Length 25"
Total Length 43"



Order No. 05 - 12965

Deck engagement cable replaces MTD 746-04173B, 746-0417A, 746-04173, 946-04173B, 946-04173A, 946-04173.



Total Length 48"
Conduit Length 37"



Order No. 05 - 8833

Clutch cable replaces MTD 746-0629. Fits all self propelled walk behind mowers with cog front wheels.

Order No. 05 - 14341

Deck cable replaces MTD 946-04618A, 746-04618A. Fits LTX1040 series 13AT, 13AX, 113WX, with 42" & 46" decks.

Conduit Length 42-1/8"
Overall Length 59-1/2"



Conduit 40-3/4"
Inner Wire 54"
Wire Travel 12"



Order No. 05 - 14040

Blade control cable replaces MTD 946-1132, 746-1132. Fits walkbehind mowers.



Order No. 42 - 14178

Pro-Gear T7512 5-Speed transmission replaces Peerless 700-083 & 794727, MTD Pro/Cub Cadet Commercial 01000152.



Order No. 42 - 14179

Pro-Gear 30-1017 Drive Shaft. Replaces Peerless 771842 & Scag 481582, MTD Pro/Cub Cadet 00030352. 6-1/4" Long, 9-Spline

Order No. 42 - 14185

Pro-Gear 30-1001 Coupler. Replaces Peerless 786177. MTD/Cub Cadet Commercial Turf 00030353. 9-Spline.



30

O.E.M.

O.E.M. REPLACEMENT



MTD (Cont.)



Outside Holes 11/32"
ID 1-1/8"
OD 6"

Order No. 05 - 8898

Drive disc replaces MTD 05080A. Fits snowblower models 500, 510, 520 & 600.



ID 6-1/2"
OD 2"

Order No. 05 - 255

Sprocket. Replaces MTD 09054. For 41 chain, 40 tooth.



ID 1/2"
OD 2-1/4"
Width 1-7/8"

Order No. 05 - 3227

Replaces MTD 931-0393, 731-0393.



ID 5/8"
OD 3-1/8"
Width 2-5/16"

Order No. 05 - 309

Replaces MTD 10914.



ID 1/2"
OD 2-1/4"
Width 1-7/8"

Order No. 05 - 8309

Drive Roller replaces MTD 931-0908, 731-0908. Fits models after 1987 with splined shaft.

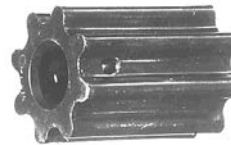

ID 5/8"
OD 1-1/2"
Width 2"

Order No. 05 - 307

Nylon Drive Roller for MTD 07120. Notched for lug tires.



Order No. 05 - 3205

Sprocket. Replaces MTD 948-0852, 748-0852. 1/2" ID, 13/16" OD, 13/16" Height.



ID 1/2"
Width 2-3/4"
Height 5"

Order No. 07 - 6916

Deck Wheel replaces MTD 734-3058B. 2-1/2" offset hub.



ID 5/8"
Width 1-3/8"
Height 5-3/4"

Order No. 07 - 8297

Deck wheel replaces MTD 734-0974, 1-3/8" offset hub.



ID 1/2"
Width 1-3/8"
Height 4-3/4"

Order No. 07 - 430

Deck Wheel replaces MTD 734-0973, 1-1/2" offset center hole.



Order No. 07 - 14446

5" x 2-5/8" x 5/8" plastic bushing, deck wheel replaces Cub Cadet / MTD 634-3159. 2-7/8" centered hub.



Order No. 07 - 282

8" x 1.75", 1/2" C.H., 1-3/8" offset hub. Replaces MTD 54446.

30

O.E.M.



MTD (Cont.)



Order No. 06 - 3240

10.25" x 3.25", Wheel Assembly replaces MTD 734-0510. 5/8" center hole, 2-3/4" offset hub. (painted white)



Order No. 06 - 433

11" x 4", Front Wheel Assembly. Replaces MTD 753-0687, 734-0949. 5/8" plastic bushing, 2-5/8" offset hub. (painted white)



ID .787" (19.99 mm)
OD 1.850" (46.99 mm)
Height 9/16" (14.29 mm)

Order No. 09 - 442

Bearing replaces MTD 941-0919741-0919. Bearing No. 6204-2RS



ID 5/8" (15.88 mm)
OD 1-9/16" (39.69 mm)
Height 15/32" (11.91 mm)

Order No. 09 - 483

Bearing replaces MTD 941-0524P, 941-0524. Bearing No. 6204-2RS



ID 1/2" (12.70 mm)
OD 1-3/8" (34.93 mm)
Height 7/16" (11.11 mm)

Order No. 09 - 8869

Bearing replaces MTD 741-0133. Used in our 09-8823 bearing kit.



ID 21/32" (17 mm)
OD 1-9/16" (40 mm)
Height 15/32" (12 mm)

Order No. 09 - 8507

Bearing replaces MTD 741-0600. Homeowner models. Bearing No. 6203-2RS.



ID 5/8"
OD 7/8"
Height 1/4"

Order No. 09 - 13229

Hex steering bushing replaces MTD 741-0656, 941-0656A.



ID .635"
OD .817"
Length 1"
Flange OD 1-1/4"

Order No. 09 - 12856

Wheel bushing replaces MTD 941-0706 & 741-0706, with grease fitting. MIN010



ID 3/4"
OD 1"
Length 1-3/8"
Flange OD 1-1/16"

Order No. 09 - 12857

Wheel bushing replaces MTD 741-0990A, with grease fitting. MIN010



ID 5/8" (15.88 mm)
OD 7/8" (22.22 mm)
Height 5/8" (15.87 mm)
Flange OD 1-1/8" (28.57 mm)

Order No. 09 - 293

Flange Bearing. Replaces MTD 948-0110, 748-0110, Bronze.



ID 5/8" (15.88 mm)
OD 3/4" (19.05 mm)
Height 3/4" (19.05 mm)
Flange OD 1-1/8" (28.58 mm)

Order No. 09 - 3201

Flange Bearing. Replaces MTD 748-0184, Bronze.



ID 5/8" (15.88 mm)
OD 3/4" (19.05 mm)
Height 3/4" (19.05 mm)
Flange OD 1" (25.40 mm)

Order No. 09 - 3213

Replaces MTD 748-0867.



O.E.M. REPLACEMENT

MTD (Cont.)



ID 5/8" (15.88 mm)
OD 7/8" (22.23 mm)
Height 5/8" (15.88 mm)
Flange OD 1-1/8" (28.58 mm)

Order No. 09 - 3202

Flange Bearing. Replaces MTD 948-0227A, 748-0227A, 748-0227. (Hex Nut), Bronze.



ID 1/2" (12.70 mm)
OD 3/4" (19.05 mm)
Height 19/32" (15.08 mm)
Flange OD 1" (25.40 mm)

Order No. 09 - 382

Replaces MTD 948-0108, 748-0108, Bronze.



ID 3/4" (19.05 mm)
OD 1" (25.40 mm)
Height 3/4" (19.05 mm)
Flange OD 1-1/4" (31.75 mm)

Order No. 09 - 3211

Replaces MTD 941-0293, 741-0293, Nylon.



ID 3/4" (19.05 mm)
OD 1" (25.40 mm)
Height 1-15/16" (49.21 mm)
Flange OD 1-1/8" (28.58 mm)

Order No. 09 - 3222

Flange Bearing. Replaces MTD 948-0169, 748-0169. Graphite Impregnated.



ID 1/2" (12.7 mm)
OD 11/16" (17.5 mm)
Height 19/32" (19.05 mm)
Flanged OD 1" (25.4 mm)

Order No. 09 - 9326

Bearing replaces MTD 941-0324, 741-0324. Flanged bearing fits self propelled mowers. (nylon)



ID 3/4" (19.05 mm)
OD 1-1/4" (31.75 mm)
Height 3/4" (19.05 mm)
Flange OD 1-3/8" (34.93 mm)

Order No. 09 - 3200

Wheel bushing replaces MTD 741-0199, Nylon.



ID 1" (25.4 mm)
OD 1-1/4" (31.7 mm)
Height 19/32" (15.08 mm)

Order No. 09 - 9327

King pin bushing replaces MTD 741-0374. Fits MTD model 406 rear tine tiller. Lower chain case bearing on tiller. Flanged OD 1-1/2". (nylon)



ID 1" (25.4 mm)
OD 1-1/2" (38.1 mm)
Height 3/4" (19.05 mm)

Order No. 09 - 9328

Bearing replaces MTD 741-0244. Flanged bearing for MTD. Flanged OD 1-3/4". (nylon)



ID 5/8" (15.88 mm)
OD 3/4" (19.05 mm)
Height 1" (25.4 mm)
Flange OD 1-1/4" (31.75 mm)

Order No. 09 - 3209

Flange Bearing replaces MTD 748-0855.



ID 5/8" (15.88 mm)
OD 13/16" (20.64 mm)
Height 1" (25.40 mm)

Order No. 09 - 7720

Bushing replaces MTD 7941-0487A, 41-0487A. Fits MTD rider models 530-568 & 600-658. MIN010



ID 5/8" (15.88 mm)
OD 7/8" (22.23 mm)
Height 5/8" (15.87 mm)

Order No. 09 - 7836

King pin bushing replaces MTD 741-0225. Fits 38" and 42" cut front engine riders. MIN010

30

O.E.M.



O.E.M. REPLACEMENT

MTD (Cont.)



Order No. 09 - 10240

Pulley spacer replaces MTD 950-0957. Spacer for our 13-10185 & 13-10186 engine pulleys.



ID 3/4" (19.05mm)
OD 1" (25.4mm)
Height 1" (25.4mm)

Order No. 09 - 9572

Bearing sleeve replaces MTD 941-0340, 741-0340. Fits 600 series models. Also fits 85' - 87' MTD rider models 135-137 with single speed transaxle only.



OD 2-3/64" (51.99 mm)
ID 7/8" (22.22 mm)
Height 1" (25.4 mm)

Order No. 09 - 10264

Axle Bearing replaces MTD 941-0185. Fits 800 & 900 series snowthrowers.



OD 1-55/64" (47.24 mm)
ID 3/4" (19.05 mm)
Height 27/32" (21.43 mm)

Order No. 09 - 10265

Auger impeller bearing replaces MTD 941-0309 without collar & 941-0310 with collar. Fits 22" and 40" MTD blowers. Bearing No. SA204-12. Insert bearing.



ID 1/2" (12.70mm)
OD 1-1/8" (28.58mm)
Height 1/4" (6.35mm)

Order No. 09 - 9502

Engine mount bushing replaces MTD 922-0153. Fits 600 series riders. Nylon. MIN010



ID 1-5/8"
OD 3-9/16"

Order No. 09 - 367

Bearing Housing. Replaces MTD 08253B.



ID 3/4" (19mm)
OD .945" (24mm)
Height 1" (25.4mm)



Order No. 09 - 13468

Plastic flange bearing replaces MTD 741-0660A. MIN010



ID 5/8" (15.8mm)
OD 15/16" (23.8mm)
Height 1" (25.4mm)



Order No. 09 - 13467

Plastic flange bearing replaces MTD 741-0659. Flange OD 1-1/4". MIN010



Coil Diam. 3/8"
Length overall 3-3/8"
Length of coil 2"
Thickness 1/16"

Order No. 10 - 254

Spring. Replaces MTD 732-0157.



Coil Diam. 1/2"
Length overall 2-13/16"
Length of coil 1-5/8"
Thickness 5/64"

Order No. 10 - 291

Tension Spring. Replaces MTD 732-0433.



Coil Dia. 29/32"
Total Length 7-3/4"
Length of Coil 5-11/16"
Thickness 1/8"

Order No. 10 - 9717

Extension spring replaces MTD 932-0594A.



Coil Diam. 3/4"
Length overall 9"
Length of coil 4-3/4"
Thickness 7/64"

Order No. 10 - 3207

Spring. Replaces MTD 732-0153.

30

O.E.M.

O.E.M. REPLACEMENT



MTD (Cont.)

Coil Diam. 1"
Length overall 11-1/2"
Length of coil 6-3/4"
Thickness 9/64"



Order No. 10 - 3221

Deck Spring. Replaces MTD 7932-0307A, 32-0307A.

Coil Diameter 7/8"
Coil Length 7-3/4"
Over All Length 12-3/4"



Order No. 10 - 9184

Extension spring replaces MTD 732-0638. Used on Models 45 thru 47G-400 series.

Coil Diameter 1/2"
Coil Length 2-1/2"
Over All Length 4"



Order No. 10 - 9268

Extension spring replaces MTD 932-0429A, 732-0429A. Fits variable speed model 18 hp tractors. Speed selector lever spring.

Coil Diameter 9/16"
Coil Length 4-1/4"
Over All Length 5-3/4"



Order No. 10 - 9404

Extension spring replaces MTD 732-0814. Fits MTD's 28" cut Yard Boy riding mower.

Coil Diameter 7/16"
Coil Length 2-11/16"
Over All Length 4"



Order No. 10 - 9295

Extension spring replaces MTD 732-0815. Fits MTD 28" cut Yard Boy riding mower.

ID 5/8"
OD 15/32"
Height 1-1/4"



Order No. 10 - 3215

Spur. Replaces MTD 948-0203, 748-0203.



Order No. 10 - 13360

Steering pinion gear replaces MTD 717-1554. Used with our 09-13229 bushing. Used on riders since 1999. 11 tooth splined bore.

ID 5/8"
OD 4-7/8"



Order No. 10 - 9145

Pulley brake disc replaces MTD 09322. Fits 38" & 42" cut, model series 600, 805, 800, 739, 750-769. Spindle brake disc for drive pulley.



Order No. 10 - 10228

Flanged nut replaces MTD 712-0417 and 912-0417A. 5/8" thread. Blade spindle nut used on our 9285, 9284, 9286, 9287, 9516, 9515, 9518, 9288 and 9517.

Length 5-1/4"



Order No. 10 - 8295

Brake Assembly Blade replaces MTD 961-0168B, 761-0168A. Fits 400 series shallow deck 38" cut. Fits 130-498 series tractors.



Order No. 10 - 12410

Deck lift cable replaces MTD 746-0968. Lanyard cable with swivel pins. Length 17".



Order No. 10 - 8950

Front axle steering arm replaces MTD 983-0055, 683-0055. Fits front engine rider models 620-689, 700-739, 1986 and after.

30

O.E.M.



MTD (Cont.)



Order No. 10 - 9159

Ball joint assembly replaces MTD 923-0448A, 723-0448A. Fits all MTD lawn and garden tractors from 1997 - present, except model 995. Used on new style draglink. Size 7/16" - 20 female x 3/8" - 24 male.



Order No. 10 - 2210

Ball Joint Assembly 3/8"-24. Replaces MTD 923-0156, 923-3018, 723-3018, 723-0156. (right hand threads)

Size 3/8"-24



Order No. 10 - 11031

Ball joint assembly replaces MTD 923-3018 / 723-3018. RH threads. Short male threads. (Special)

OD 1/2"
Width 1"
Over All Length 10-1/4"
Slot Length 2-3/4"



Order No. 10 - 9512

Deck link lift replaces MTD 14802A-0637. Fits 600 series on 30", 38" & 42" decks.



Order No. 10 - 9232

1/4" Click pin replaces MTD 914-0143, 714-0143. Length 1-3/4", Dia. 1/4".



Order No. 10 - 14437

Damper replaces MTD commercial turf.



Order No. 10 - 14327

Electric clutch replaces MTD 917-04622 & 917-04183, 717-04183. Warner 5219-99. 1" ID, 4" height, 5-11/32" pulley.



Order No. 10 - 9911

Electric PTO clutch replaces MTD 717-1459, Warner 5217-9, 5217-6. 1" x 3" Height, 5.375" Pulley. 5/8" Belt, Shaft size 1".



Order No. 10 - 12424

Electric PTO clutch replaces MTD 917-1774B, fits 50" Toro/Home Depot & 54" 800 series mowers. Warner 5219-25. Shaft size 1", 6" pulley diameter, 5/8" Belt.



Order No. 10 - 11829

Electric PTO clutch replaces MTD 717-1709 & 917-1709. Fits model 809. 1" ID x 5.375" pulley, 1/2" belt. Warner 5215-130.

30

O.E.M.



O.E.M. REPLACEMENT

MTD (Cont.)



Order No. 10 - 11828

Electric PTO clutch replaces MTD 717-1708 & 917-1708. Also replaces Snapper 14022. 1" ID x 5.395" pulley, 1/2" belt. Warner 5215-129.



Order No. 10 - 8314

Left hand handle bracket replaces MTD 17189B-0637, 17189.



Order No. 10 - 8313

Right hand handle bracket replaces MTD 17188.



Order No. 10 - 3242

Hood Latch. Replaces MTD 723-0296.



Order No. 10 - 9565

Plastic knob assembly replaces MTD 920-0241. Fits 94' Montgomery Ward snowthrowers, MTD edgers from 95' - 98', MTD walkbehind mowers models 111-314 & MTD turf power walkbehind mowers. (Black).



Order No. 10 - 863

Knob and Bolt set for fold-down handles. Replaces MTD 910-1174, 720-0241, 710-1174, 710-405 (Bolt) and 09966 (knob).



Order No. 10 - 3220

Spindle Shaft. Replaces MTD 738-0196/711-0255. 4" length. For more information, see Section 10.



Order No. 10 - 3218

Spindle Shaft. Replaces MTD 738-0197. 3-15/16" Length. For more information, see Section 10.



Order No. 10 - 7281

Variator Shaft replaces MTD 938-0569, 738-0569. Fits White models 666 and 686. 9/16" OD x 3-3/4" Length.

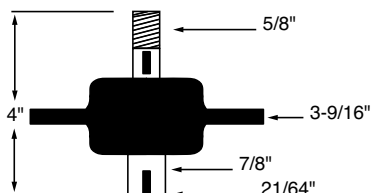

Order No. 10 - 856

Blade Spindle Assembly. Replaces MTD 09321. Uses 09-442 Bearing.

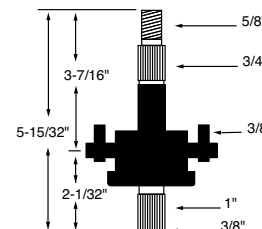

Order No. 10 - 7156

Spindle Assembly replaces MTD 717-0900A. Fits 36" decks. Uses two of our 09-442 Bearings.

30

O.E.M.



MTD (Cont.)

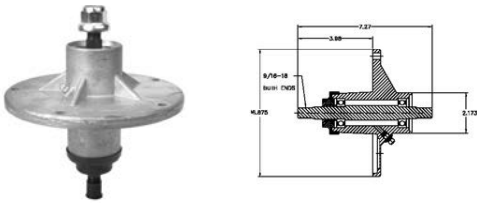

Order No. 10 - 10189

Jackshaft Housing Assembly replaces Murray 1001200 & MTD 1001046. Fits 2001 models and up riding mowers. Includes shaft with grease zerk. Uses our **10-8901** nut.

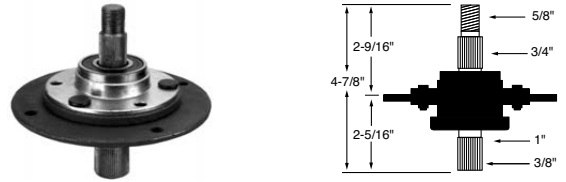

Order No. 10 - 8967

Spindle assembly replaces MTD 917-0912. Fits model 806 series, 42" cut. Right hand and center quill for deck "H". Splined shaft.

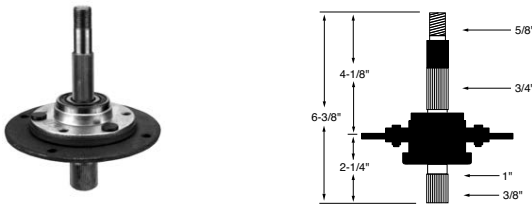

Order No. 10 - 8968

Spindle assembly replaces MTD 917-0913. Fits model 806 series, 46" cut. Left hand side quill for deck "H". Splined shaft.

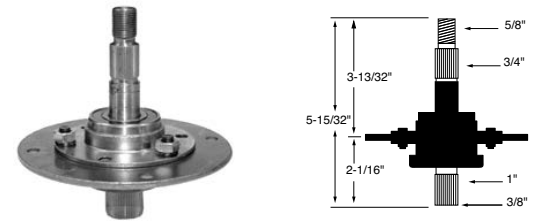

Order No. 10 - 7155

Spindle Assembly replaces MTD 917-0906A, 717-0906A. Fits 38" and 42" "F" deck model 600 series. Uses our **10-10228** nut.



Order No. 10 - 9285

Spindle assembly replaces MTD 918-0117. Without pulley. Fits 46" cut, star hole blades from 1994-1997. Uses Double pulley. Left assembly. Uses our **10-9516** shaft.



Order No. 10 - 9516

Spindle shaft only for our **10-9285** spindle assembly for MTD. Length 5-1/2", OD .785", Bolt Threads 7/16" - 20, Poly Nut Threads 5/8" - 18.



Order No. 10 - 9284

Spindle assembly replaces MTD 918-0116. Without pulley. Fits 46" cut, star hole blades from 1994-1997. Uses single pulley. Right/Center assembly. Uses our **10-9515** shaft.



Order No. 10 - 9515

Spindle shaft only for our **10-9284** spindle assembly for MTD. Length 4-5/8", OD .785", Bolt Threads 7/16" - 20, Poly Nut Threads 5/8" - 18.



Order No. 10 - 9286

Spindle assembly replaces MTD 918-0430A, 918-0240. Without pulley. Fits 46" cut, star hole blades from 1998-2000. Uses Single pulley. Right/Center assembly.



Order No. 10 - 9518

Spindle shaft only for our **10-9286** spindle assembly for MTD. Length 5-3/16", OD .785", Blade Nut & Pulley Nut Thread 5/8" - 18.

30

O.E.M.

O.E.M. REPLACEMENT



MTD (Cont.)



Order No. 10 - 7765

Quill assembly replaces Murray 55962 & 455962. Also replaces MTD 55962E701. Used on 30" cut rear engine rider model 30502.



Order No. 10 - 13604

Spindle housing only replaces MTD. Fits MTD 38" & 42" decks, 600 series, 1997 and newer. Fits our **10-9288, 10-11962, 10-12219, 10-12066, 10-12883 & 10-13131** spindles.

30



Order No. 10 - 12883

Spindle assembly replaces MTD 918-04197, 618-04197. 5-9/16" pulley.



Order No. 10 - 12612

Spindle assembly replaces MTD 918-0671B / 618-0671. Fits 54" decks, 800 series with star hole blades. Includes pulley. 5.39" pulley dia. x .5625 width.



Order No. 10 - 12448

Spindle assembly replaces MTD 918-0596 / 618-0594, 618-0431, 918-0431. Fits 46" decks. Used with our 10-9286 spindle assembly. 5" pulley dia., overall length 6-3/4", left side spindle.



Order No. 10 - 13220

Spindle assembly replaces MTD 918-3167 / 618-3167 (2013), Troy Bilt 14115, 38" decks (GW-6183167). Also fits Cub Cadet model 250.

Order No. 10 - 13631

Spindle assembly replaces MTD 918-04474A, 618-04474. Also replaces Toro 112-6063, fits model 13AC762F052 & 13RC762F052. Pulley Dia. 5.75".



Order No. 10 - 12066

Spindle assembly replaces MTD 918-0574/618-0574 & 918-0565/618-0565 with grease fitting. Fits later model 42" deck 600 series. Uses our **10-12379** replacement shaft.



Order No. 10 - 12379

Spindle shaft replaces MTD. Fits later model 42" deck - 600 series. Fits our **10-12066** spindle assembly.



MTD (Cont.)



Order No. 10 - 9288

Spindle assembly replaces MTD 918-0138. Without pulley. Fits 38" & 42" cut, star hole blades. New style "X" housing. Uses 09-442 bearing and 10-10228 nut.



Order No. 10 - 13974

Spindle shaft only for our 10-9288 Spindle.



Order No. 10 - 9287

Spindle assembly replaces MTD 918-0431, 918-0241. Without pulley. Fits 46" cut, star hole blades from 1998-2000. Uses double pulley. Left assembly. Uses our 10-9517 shaft.



Order No. 10 - 9517

Spindle shaft only for our 10-9287 spindle assembly for MTD 738-0933. Length 6". Uses 10-10228 nut.



Order No. 10 - 12219

Spindle assembly replaces MTD 618-0624 / 918-0624. Fits most 2005-2006, 42" riding mowers. Also replaces Toro model LX420 or 13ZX60RG544, part number 112-0460. Comes complete with our 13-12682 pulley. Pulley dia. 6-5/16, spindle height 6-3/8".



Order No. 10 - 12926

Spindle shaft replaces MTD 738-1010A & Toro 112-0884. Fits 42" & 50" decks. Fits our 10-12219 spindle assemblies. 6-3/8" long.

30

O.E.M.



Order No.

Description

12 - 6907

Drive Belt. Replaces MTD 954-0240, 754-0240. 5/8" section belt, 38-3/16" length (969.96 mm). *Aramid fiber. Fits 30" rear engine rider, variable speed pulley to transaxle.

12 - 6950

Drive Belt. Replaces MTD 754-0346. 30" (761.42 mm). Fits 462R & 479R series self-propelled mowers.

12 - 9932

Drive Belt . Replaces MTD 754-0446. 5/8" (15.88 mm) x 45" (1143. mm). Fits 800 series 2 speed garden tractors 1997 and after. General purpose, polyester cord construction.

12 - 11137

Drive Belt. Replaces MTD 954-0637A. 3/8" (9.53 mm) x 31-1/4" (787.65 mm). Fits self propelled walk behind mowers.

12 - 11135

Drive Belt. Replaces MTD 954-0483. 3/8" (9.53 mm) x 38" (965.20 mm). Fits self propelled front wheel drive models 263, 264, 525, 528 & 529 mowers 2000 & after.

O.E.M. REPLACEMENT



MTD (Cont.)



30
O.E.M.

Order No.	Description
12 - 12382	Drive Belt. Replaces MTD 954-04043/754-0343. 1/2" (12.7 mm) x 57.7" (1465.6 mm). Raw edge. Laminated, Aramid cord construction.
12 - 12429	Drive Belt. Replaces MTD 954-0430/754-0430. 3/8" (9.5 mm) x 35" (889 mm). Fits Snow Thrower models from 1992-2002. Raw edge. Laminated, Aramid cord construction. Sold in Matching Pairs.
12 - 13551	Drive Belt. Replaces MTD 01000151. 1/2" (12.5 mm) x 51-3/4" (1314.5mm). Wheel drive belt for MTD Pro G1336, 36" walk behind, Craftsman Model 247.889360. Cogged, Aramid cord construction.
12 - 9120	Deck Belt. Replaces MTD 754-0440. 1/2" (12.7 mm) x 99" (2514.60 mm). Fits 600 series tractors. Wrap molded, general purpose, polyester cord construction.
12 - 9119	Deck Belt. Replaces MTD 754-0439. 5/8" (15.875 mm) x 60" (1524.0 mm). Fits 600 series tractors. Wrap molded, *Aramid fiber, clutching cover
12 - 9581	Deck Belt. Replaces MTD 754-0443A. HAA Hex Profile x 89.9" (2283 mm). Fits European rear discharge mowers. 2 Ply cover, *Aramid fiber. (Export Only)
12 - 9900	Deck Belt. Replaces MTD 954-0197. 1/2" (12.7 mm) x 117" (2971.8 mm). Fits 50" deck 990 series garden tractors. General purpose, polyester cord construction.
12 - 9935	Deck Belt . Replaces MTD 754-0472. 5/8" (15.88 mm) x 83" (2108.20 mm). Fits auto drive, step through frame 42" lawn and garden tractors 1999 & after. General purpose, polyester cord construction.
12 - 10369	Deck Belt. Replaces MTD 954-0498. 1/2" (12.7 mm) x 67" (1701.8 mm). Fits 42" step thru frame 2001 and after. Also fits Troy Built. Wrapped molded, general purpose, aramid cord construction, clutching cover.
12 - 10261	Deck Drive Belt. Replaces MTD 954-0474. 5/8" (15.88 mm) x 100.20" (2545 mm). Fits auto drive step through Garden Tractors with 46" decks (1999 & older). *Aramid fiber, wrap molded, clutching cover.
12 - 12489	Deck Belt. Replaces MTD 754-04142 / 954-04142. 1/2" 2.7mm) x 91.4" (2321.6 mm). Fits 46" decks, Step-Thru frame lawn tractors. Aramid cord construction, double cover.
12 - 12667	Deck Drive Belt. Replaces MTD 754-04048 / 954-04048. 5/8" (15.875mm) x 130-1/4" (3308.4 mm). Fits models LT1024, 50" decks. Aramid cord construction, double cover.
12 - 6843	Deck Drive Belt. Replaces MTD 754-0349. "A" section belt, 79-3/32" length (2008.98 mm). Fits 820 thru 849 series tractors with 46" cut side discharge "H" decks.
12 - 11660	Deck Drive Belt. Replaces MTD 954-04060B. 1/2" (12.7 mm) x 96-1/2" (2451 mm). Fits 42" 2005 and newer LT-5 design rames. Wrapped Molded general purpose, aramid cord construction, double clutching cover
12 - 11661	Deck Drive Belt. Replaces MTD 954-0642. 5/8" (15.875 mm) x 137-7/8" (3502.6 mm). Fits 54" auto drive model with electric PTO. Wrapped Molded general purpose, aramid cord construction, double clutching cover.
12 - 9480	V-Belt. Replaces MTD 954-0453. 5/8" (15.88 mm) x 36-1/4" (920.75 mm). General purpose, polyester cord construction.



MTD (Cont.)



Order No.	Description
12 - 9847	V-Belt. Replaces MTD 754-0441. 1/2" (12.7 mm) x 76" (1930.4 mm). General purpose, polyester cord construction.
12 - 11132	V Belt. Replaces MTD 954-0460. 3/8" (9.53 mm) x 39-1/4" (990.85 mm). Fits rear wheel drive, rear discharge mowers 1997 & after. Models 959C, 979C, E979E & 999C.
12 - 13232	V-Belt. Replaces MTD 754-04032. 3/8" (9.52 mm) x 35-5/8" (904.8mm). Fits MTD models 400, 500, 550 series self propelled walkbehind, 1998 and older, also fits 550 series edgers. Neoprene, polyester cord construction single cover, clutching white.
12 - 12791	V-Belt. Replaces MTD 754-04240 & 954-04240. 1/2" (12.5 mm) x 162.9" (4137.6mm). Fits MTD models LTX 52" decks. Polyester cord construction.
12 - 13301	V-Belt. Replaces MTD 754-04252. 1/2" (12.5 mm) x 84.17" (2137.6mm). Fits MTD models LTX 52" decks. Polyester cord construction.
12 - 12770	V-Belt. Replaces MTD 754-04207. 1/2" (12.5 mm) x 79.3" (2014.2mm). Fits MTD models LTX Drive Belt. Polyester cord construction.
12 - 12790	V-Belt. Replaces MTD 754-04219. 1/2" (12.5 mm) x 103.24" (2622.5mm). Fits MTD models LTX 46" Deck Belt. Polyester cord construction.
12 - 14215	V-Belt. Replaces MTD 954-04265. 5/8" (15.87 mm) x 33.8" (858.52 mm). Fits 2010 - up Craftsman, Tractor Supply Huskee, Walmart Yard Man. Wrapped-molded, polyester cord construction, single cover, clutching brown.
12 - 7169	Blade Belt. Replaces MTD 754-0264. 52.18" length (1325.56 mm). Fits 30" cut rear engine rider models 139-501 thru 508 and 139-511 thru 514.
12 - 6841	Blade to Blade Belt. Replaces MTD 754-0293. 1/2" section belt, 74" length (1879.6 mm). Fits 44" cut, side discharge, 935 series decks.
12 - 6842	Blade to Blade Belt. Replaces MTD 954-0433, 754-0433, 754-329A. "B" section belt, 69-9/32" length (1759.74 mm). Fits 600 series lawn tractors with 38" side discharge, 805 series decks.
12 - 6949	Blade to Blade Belt. Replaces MTD 954-0355, 754-0355. Fits 32" cut "D" decks.
12 - 6845	Blade to Blade Belt. Replaces MTD 954-0371A, 754-0371A. 5/8" (15.875 mm) x 74" length (1879.6 mm). *Aramid fiber. Fits riders with 42" cut side discharge "G" decks.
12 - 10831	Variable Speed Belt. Replaces MTD 954-04001. 5/8" (15.8 mm) x 69-3/16" (1757.36 mm). Raw edge, laminated, polyester cord construction. Fits 2001 & up.
12 - 6840	Variable Speed Belt. Replaces MTD 754-0281. 5/8" section belt, 44-7/32" length (1123.16 mm). Fits 38", 40", 42" & Older units. Also fits 600 series variable speed unit to rear end.
12 - 6906	Variable Speed Belt. Replaces MTD 754-0241A, 754-0241A. 5/8" section belt, 35-1/4" length (895.35 mm). Fits 30" rear engine rider, engine to variable speed pulley.
12 - 6908	Variable Speed Belt. Replaces MTD 954-0370, 754-0370. 5/8" section belt, 48" length (1219.2 mm). *Aramid fiber. Fits model 1238 front engine rider, variable speed pulley to transaxle. 600 series.

O.E.M. REPLACEMENT



MTD (Cont.)



30
O.E.M.

Order No.	Description
12 - 10833	Variable Speed Drive Belt. Replaces MTD 954-04002. 5/8" (15.875 mm) x 31-3/4" (806.5 mm). Fits models 660 thru 688. For 2001 & up.
12 - 9482	Variable Speed To Transmission Belt. Replaces MTD 954-0362. 7/8" (22.22 mm) x 50" (1270 mm). Fits models 820 - 849. Wrap molded, *Aramid fiber, clutching cover.
12 - 10009	PTO Belt. Replaces MTD 754-0485 & 954-0485. 5/8" (15.88 mm) x 97" (2463 mm). Fits 42" deck with manual PTO, for 2000 and later units. *Aramid fiber.
12 - 12610	PTO Belt. Replaces MTD 754-04041 / 954-04041. 5/8" 875mm x 112.2" (2849.8 mm). Fits models L 1046, LT1045 & LT1046. Aramid cord construction, double cover.
12 - 11848	PTO to Spindle Belt. Replaces MTD 754-04122. 1/2" (12.7 mm) x 90-1/4" (2292.4 mm). Fits 46" deck models. Also replaces Cub Cadet, Troybilt, Bolens, Yard Machines, Husky, Yardman.
12 - 10100	Engine to Deck Belt. Replaces MTD 954-0486A. 5/8" (15.88 mm) x 67" (1701.8 mm) Fits auto drive, step through frame 46" lawn and garden tractors 1999 & after with manual PTO. General purpose, polyester cord construction.
12 - 10260	Engine to Deck Belt. Replaces MTD 954-0476. 5/8" (15.88 mm) x 101.20" (2570mm). Fits auto drive step through Garden Tractors with 46" decks with Electric PTO. *Aramid fiber.
12 - 6844	Engine to Deck Belt. Replaces MTD 754-0350. "B" section belt, 64" length (1625.6 mm). *Aramid fiber. Fits 40" cut Lawn tractors, 800 series.
12 - 11019	Engine to Deck Belt. Replaces MTD 954-0497. 1/2" (12.7 mm) x 60.06" (1525.5 mm). Fits auto step thru tractors 1999 and newer. Wrapped Aramid cord clutching cover.
12 - 6838	Engine/Transmission Belt. Replaces MTD 754-0266. "A" section belt, 85.2" length (2164.08 mm). Fits 4 speed transaxle engines to transmission.
12 - 6839	Engine/Variable Speed Belt. Replaces MTD 754-0280. 5/8" section belt, 53" length (1346.2 mm). Fits 38", 40", 42" & Older units. Also fits 600 series variable speed unit engines.
12 - 9901	Engine Pulley to Drive Pulley Belt. Replaces MTD 954-0271. 3/8" (9.53 mm) x 39" (990.6 mm). Fits front wheel drive self-propelled rear discharge mowers. General purpose, polyester cord construction.
12 - 9903	Transmission to Engine Belt . Replaces MTD 954-0461. 1/2" (12.7 mm) x 78-1/2" (1993.9 mm). Fits 800 series hydrostatic garden tractors 1997 and after. General purpose, polyester cord construction.
12 - 9570	Transmission Drive Belt. Replaces MTD 754-0358. 7/8" 22.22 mm) x 53-1/4" (1352.55 mm). Fits 800 series 2-speed garden tractors, 1996 & prior. General purpose, *Aramid fiber. Clutching cover.
12 - 13653	Transmission V-Belt. Replaces MTD 954-04082A. 3/8" (9.5 mm) x 31.68" (804.9mm). Transmission belt for self propelled walkbehind mower, front wheel drive, 2008 and after. 12AG & 12AV series. Polyester cord construction, wrapped molded, single cover.



MTD (Cont.)



Order No.

Description

12 - 10089

Snowthrower Belt. Replaces MTD 754-0101A & 954-0101A. 1/2" (12.7 mm) x 35" (889 mm). Fits snowthrower model 721. *Aramid fiber.

12 - 14118



Snowthrower Belt. Replaces MTD 954-04050 / 754-04050. 1/2" (12.7 mm) x 35"(889 mm). Fits two stage snow thrower, 2005 -newer. Raw edge, cogged, aramid cord construction.

12 - 13567

Snow Blower Auger V-Belt. Replaces MTD 754-04014. 3/8" (9.5 mm) x 27" (685.8mm). Fits 300 series compact two-stage snow blowers 2004-up. Raw edge, cogged.

12 - 13288

Snow Blower Drive Belt. Replaces MTD 754-0367, 954-0367. 3/8" (9.5 mm) x 34.4" (873.7mm). Neoprene, aramid cord construction, single clutching cover salt-pepper color.

12 - 11482

Primary Drive Belt. Replaces MTD 954-0467. 5/8" (15.875 mm) x 91-1/2" (2324.1 mm). Fits auto drive step thru frame Lawn & Garden Tractors 1999 and newer.

12 - 11483

Secondary Drive Belt. Replaces MTD 954-0468. 5/8" (15.875 mm) x 41-1/2" (1054.1 mm). Fits auto drive step thru frame Lawn & Garden Tractors.

*Made with KEVLAR® or non-trade marked Aramid fiber.



ID 12 point spline
OD 5-3/4"
Height 1"

Order No. 13 - 9587

Deck pulley replaces MTD 756-0980. Fits 600 series mowers.



ID 12 point spline
OD 5"
Height 1"

Order No. 13 - 9588

Deck pulley replaces MTD 756-0969. Fits 600 series mowers. Fits our 10-9288 Spindle.



ID 12 point spline
OD 5"
Height 2-3/4"

Order No. 13 - 9589

Deck pulley replaces MTD 756-0603. Fits 600 series mowers. Double pulley.



ID 1-9/16"
OD 5"
Height 3-1/4"

Order No. 13 - 9708

Deck pulley (double pulley) replaces MTD 756-0638, 941-0524. Fits yard machines model series 690-699 hydrostatic lawn tractors.



Top ID 1"
Bottom ID 1"
Top OD 3-1/2"
Bottom OD 5-1/2"
Height 4-5/8"

Order No. 13 - 10186

Double engine pulley replaces MTD 756-0983B. Fits model 690-699 riding mowers. Without spacer.



Top ID 1"
Bottom ID 1"
Top OD 3-1/2"
Bottom OD 5-1/2"
Height 4-7/8"

Order No. 13 - 10185

Double engine pulley replaces MTD 756-0982B, 753-0635 and 756-0488. Fits model 660-679 riding mowers. Without spacer.

30

O.E.M.

O.E.M. REPLACEMENT



MTD (Cont.)



Top ID 1"
Bottom ID 1-1/4"
Top OD 3-1/2"
Bottom OD 5"
Height 6-1/4"

Order No. 13 - 9590

Double engine pulley replaces MTD 756-0658. Fits 600 series mowers.



ID 1"
Bottom OD 6"
Height 5-7/8"
Keyway 1/4"
Top OD 3-25/64"

Order No. 13 - 12855

Engine pulley replaces MTD 756-04196A.



ID 1"
Bottom OD 6"
Height 5-7/16"
Keyway 1/4"
Top OD 3-9/16"

Order No. 13 - 12854

Engine pulley replaces MTD 756-04067A/956-04067A/756-04195.



ID 1"
Bottom OD 6"
Height 5-7/16"
Keyway 1/4"
Top OD 3-25/64"

Order No. 13 - 12853

Engine pulley replaces MTD 756-04064A/956-04064.



ID 3/4" splined
OD 5-1/2"
Height 2-1/2"

Order No. 13 - 8965

Blade spindle pulley replaces MTD 756-0556. Fits 42" "G" series deck. Used on our 10-7155 spindle assembly.



ID 3/4"
OD 5"
Height 2-1/2"

Order No. 13 - 8657

Blade spindle pulley replaces MTD 756-0486. Fits 38" MTD F Deck 600 series tractor.



Splined ID 5/8"
OD 7-1/4"
Height 5/8"

Order No. 13 - 12810

Transmission pulley replaces MTD 756-04002, 756-01002. Fits 13A, B & C series riders. Spun steel, 6 slot star ID.



ID 3/8"
OD 5-3/4"
Height 1-3/8"

Order No. 13 - 12613

Idler pulley replaces MTD 756-3105 / 956-3105. Fits 54" cut decks.



ID 3/8"
OD 4-1/4"
Height 1-1/8"

Order No. 13 - 12675

Idler pulley replaces MTD 756-04129.



ID 3/8"
OD 3-1/8"
Height 1"

Order No. 13 - 12891

Idler pulley replaces MTD 756-04224, 756-0981.

30

O.E.M.



MTD (Cont.)



ID 3/8"
OD 1-1/2"
Height 1/2"

Order No. 13 - 10672

Idler pulley replaces MTD 753-0518. Fits self propelled walk-behind mowers. Includes hex bolt and bearing.



ID 3/8"
OD 4-1/8"
Height 1-3/64"

Order No. 13 - 11144

Idler pulley replaces MTD 956-0365. Fits 46" deck & 44" rear discharge deck series 600, 700 & 800. Fits Deck H, used 1985 - 1994. (Steel)



ID 3/8"
OD 4"
Height 1-7/32"

Order No. 13 - 8588

Flat Idler pulley replaces MTD 956-0437, 756-0437. Fits MTD series 600 tractor.



ID 3/8"
OD 4"
Height 1-3/8"

Order No. 13 - 14091

Idler pulley replaces MTD/Cub Cadet 756-0542. Fits Cub Cadet Z-Force models with 42" decks.



ID 3/8"
OD 5"
Height 1-7/16"

Order No. 13 - 14090

Idler pulley replaces MTD/Cub Cadet 756-3062.



ID 3/8"
OD 4"
Height 1-1/8"

Order No. 13 - 8602

Idler pulley replaces MTD 756-0627. Fits 46" cut front engine rider. Blade idler models 144P820H000 thru 144P849H000. Composite: glass filled nylon



ID 3/8"
OD 3-1/16"
Height 2"

Order No. 13 - 14326

Idler pulley replaces MTD 756-04325. V-Idler pulley.



Order No. 13 - 718

Flat Idler with flange. Replaces MTD 756-0199. 2" OD, 3/8" ID, 3/4" belt groove.

Order No. 13 - 719

Flat Idler with flange. Replaces MTD 756-0137. 2-15/32" OD, 3/8" ID, 3/4" belt groove.

Order No. 13 - 720

Flat Idler with flange. Replaces MTD 756-0117. 2-15/32" OD, 3/8" ID, 1" belt groove.

Order No. 13 - 722

Flat Idler with flange. Replaces MTD 756-0240. 3-7/32" OD, 3/8" ID, 3/4" belt groove.

Order No. 13 - 728

V-Belt Idler. Replaces MTD 756-0116. 3-1/16" OD, 3/8" ID, 11/16" belt groove.

Order No. 13 - 729

V-Belt Idler. Replaces MTD 756-1035A, 756-0166. 2-5/8" OD, 3/8" ID, 19/32" belt groove.

Order No. 13 - 734

V-Belt Idler. Replaces MTD 756-0226. 4" OD, 3/8" ID, 13-16" belt groove.

Order No. 13 - 2176













Flat Idler with flange. Replaces MTD 756-0225. 3-1/8" OD, 3/8" ID, 3/4" belt groove.

Note: See Section 13 for Idler Measurements.

O.E.M. REPLACEMENT
MTD (Cont.)















O.E.M.
30

ORDER NO.	REPLACES O.E.M. NO.	LENGTH	CENTER HOLE DIAM.	OUTSIDE HOLE DIAM.	CENTER TO CENTER	WIDTH	STEEL THICK.	APPLICATION
 15 - 3408	942-0252 742-0252	6-3/8" 161.9mm	3/8" 9.5mm			1-1/2" 38.1mm	.095" 2.4mm	Takes (1) 15-3408 and (2) 15-3407 for 44" deck (MTD, White and Yardman)
 15 - 6128	942-0539 742-0539	12-3/8" 314.3mm	1-1/2" 38.1mm	7/16" 11.1mm	2-1/2" 63.5mm	3-3/4" 95.3mm	.117" 3mm	Cross Blade for 42" cut. used with blades 15-6126 & 15-6127
 15 - 6019	942-0486 742-0486	14-3/4" 374.7mm	13/32" 10.3mm	5/16" 7.9mm	2-1/2" 63.5mm	3" 76.2mm	.150" 3.8mm	Deep Deck, 800 series Takes (2) 15-6003 and (1) 15-6019 for 46" cut
 15 - 1077	942-0118 742-0118	15-5/16" 388.9mm	3/8" 9.5mm	5/16" 7.9mm	2-1/2" 63.5mm	2" 50.8mm	.150" 3.8mm	(2) blades for 30" cut
 15 - 6003	942-0487A 742-0487A	16-1/4" 412.8mm	13/32" 10.3mm	5/16" 7.9mm	2-1/2" 63.5mm	3" 76.2mm	.150" 3.8mm	Deep Deck, 800 series Takes (2) 15-6003 and (1) 15-6019 for 46" cut.
 15 - 997	942-0120B 942-0120 742-0120	17-1/4" 438.2mm	3/8" 9.5mm	5/16" 7.9mm	2-1/2" 63.5mm	2" 50.8mm	.150" 3.8mm	(2) blades for 34" cut
 15 - 3356	942-0171B 742-0171B 742-0171	17-1/4" 438.2mm	3/8" 9.5mm	5/16" 7.9mm	2-1/2" 63.5mm	2-1/2" 63.5mm	.204" 5.2mm	(3) blades for 50" cut
 15 - 1014	942-0120B 742-0121B 742-0121	18" 457.2mm	3/8" 9.5mm	5/16" 7.9mm	2-1/2" 63.5mm	2" 50.8mm	.150" 3.8mm	(2) blades for 36" cut 18" push/side discharge
 15 - 6143	942-0496 742-0496	18-3/16" 462mm	13/32" 10.3mm	5/16" 7.9mm	2-1/2" 63.5mm	3" 76.2mm	.150" 3.8mm	Deep Deck, 1989 & after (2) blades for 36" cut High lift
 15 - 12963	942-0677-X	18-1/2" 469.9mm	"H" Pattern			3" 76.2mm	.204" 5.1mm	Mulching Blade (3) Blades for 54" cut PATENTED
 15 - 1015	942-0122A 742-0122A	19" 482.6mm	3/8" 9.5mm	5/16" 7.9mm	2-1/2" 63.5mm	2" 50.8mm	.150" 3.8mm	(2) blades for 38" cut
 15 - 6126	942-0537 742-0537	19-5/16" 490.5mm	.406" 10.3mm	.450" 11.4mm	2-1/2" 63.5mm	3" 76.2mm	.150" 3.8mm	Mulching blade Takes (2) for 38" cut use with our 15-6128



MTD (Cont.)

ORDER NO.	REPLACES O.E.M. NO.	LENGTH	CENTER HOLE DIAM.	OUTSIDE HOLE DIAM.	CENTER TO CENTER	WIDTH	STEEL THICK.	APPLICATION
 15 - 6006	942-0473A 742-0473A	19-5/16" 490.5mm	13/32" 10.3mm	5/16" 7.9mm	2-1/2" 63.5mm	3" 76.2mm	.150" 3.8mm	For 38" Deep Deck. Takes (1) 15-6006 and (1) 15-3471 or (2) 15-6006
 15 - 1016	942-0123B 742-0123	20" 508mm	3/8" 9.5mm	5/16" 7.9mm	2-1/2" 63.5mm	2" 50.8mm	.150" 3.8mm	
 15 - 6005	942-0620 742-0620 742-0520	20" 508mm	13/16" 20.6mm	3/8" 9.5mm	2-1/2" 63.5mm	2" 50.8mm	.150" 3.8mm	Fits 030/040 mower
 15 - 6140	942-0720 942-0500 742-0500	20" 508mm	13/16" 20.6mm	3/8" 9.5mm	2-1/2" 63.5mm	2-1/4" 57.2mm	.125" 3.2mm	Fits 090 series 20" mulcher
 15 - 6457	942-0720	20" 508mm	13/16" 20.6mm	3/8" 9.5mm	2-1/2" 63.5mm	2-1/4" 57.2mm	.125" 3.2mm	Fits 20" walkbehind mowers. For splined shaft models & Electric models. Mulching blade.
 15 - 50201	742-0608	20-23/64" 517.13mm	27/64" .410mm	21/64" .320mm	2-1/2" 2.50mm	2" 50.80mm	.150" 3.8mm	
 15 - 50202	742-0607	20-23/64" 517.13mm	27/64" .410mm	21/64" .320mm	2-1/2" 63.50mm	2" 50.80mm	.150" 3.8mm	
 15 - 6096	942-0621 742-0621 742-0521	20-15/16" 531.8mm	13/16" 20.6mm	3/8" 9.5mm	2-1/2" 63.5mm	2" 50.8mm	.150" 3.8mm	21" Rear Bagger Fits models 312R, 313R, 315R
 15 - 1017	942-0124B 742-0124	21" 533.4mm	3/8" 9.5mm	5/16" 7.9mm	2-1/2" 63.5mm	2" 50.8mm	.150" 3.8mm	
 15 - 6042	942-0621A 742-0621 742-0306A	21" 533.4mm	13/16" 20.6mm	3/8" 9.5mm	2-1/2" 63.5mm	2-1/2" 63.5mm	.150" 3.8mm	21" Rear Bagger Fits models 816R, 818R, 462R thru 479R
 15 - 6139	942-0721 742-0721	21" 533.4mm	27/32" 21.4mm	3/8" 9.5mm	2-1/2" 63.5mm	2-1/4" 57.2mm	.125" 3.2mm	21" mulcher Fits Yardman & White Fits models 410/425
 15 - 6127	942-0538 742-0538	21-3/16" 538.2mm	13/32" 10.3mm	7/16" 11.1mm	2-1/2" 63.5mm	3" 76.2mm	.150" 3.8mm	Takes (2) for 42" cut use with our 15-6128

30

O.E.M.

O.E.M. REPLACEMENT



MTD (Cont.)

ORDER NO.	REPLACES O.E.M. NO.	LENGTH	CENTER HOLE DIAM.	OUTSIDE HOLE DIAM.	CENTER TO CENTER	WIDTH	STEEL THICK.	APPLICATION
 15 - 6028	942-0499A 742-0499A 742-0499	21-3/16" 538.2mm	13/32" 10.3mm	5/16" 7.9mm	2-1/2" 63.5mm	3" 76.2mm	.150" 3.8mm	Deep Deck 42" cut mower. Takes (2) blades, side discharge 1990 & after
 15 - 6295	742-0499	21-3/16" 538.2mm	13/32" 10.3mm	5/16" 7.9mm	2-1/2" 63.5mm	3" 76.2mm	.150" 3.8mm	Mulching Blade PATENTED
 15 - 1018	942-0125B 742-0125B 742-0125	22" 558.8mm	3/8" 9.5mm	5/16" 7.9mm	2-1/2" 63.5mm	2" 50.8mm	.150" 3.8mm	(2) blades for 42" cut
 15 - 6004	942-0622 742-0622 742-0522	22" 558.8mm	13/16" 20.6mm	3/8" 9.5mm	2-1/2" 63.5mm	2" 50.8mm	.150" 3.8mm	22" Std. deck
 15 - 3407	942-0295 742-0295	22" 558.8mm	13/32" 10.3mm	5/16" 7.9mm	2-1/2" 63.5mm	2" 50.8mm	.187" 4.8mm	Takes (1) 15-3408 and (2) 15-3407 for 44" deck (MTD, White and Yardman)
 15 - 6212	942-0722 742-0722	22" 558.8mm	13/16" 20.6mm	3/8" 9.5mm	2-1/2" 63.5mm	2-1/4" 57.2mm	.125" 3.2mm	Fits 22" walk behind Mulcher.
 15 - 3354	942-0256A 742-0256A	30" 762mm	3/8" 9.5mm	5/16" 7.9mm	2-1/2" 63.5mm	3" 76.2mm	.150" 3.8mm	

30

O.E.M.



MTD (Cont.)

ORDER NO.	REPLACES O.E.M. NO.	LENGTH	CENTER HOLE DIAM.	OUTSIDE HOLE DIAM.	CENTER TO CENTER	WIDTH	STEEL THICK.	APPLICATION
 15 - 1022	942-0543 742-0543	14-13/16" 376.2mm	"H" Pattern	5/16" 7.9mm	2-1/2" 63.5mm	3" 76.2mm	.125" 3.2mm	Takes (1) 15-1022 & (2) 15-1021 for 46" cut
 15 - 1030	742-04124 942-04124 942-0612 742-0612	14-13/16" 376.2mm	"H" Pattern	3/8" 9.5mm	2-1/2" 63.5mm	2-1/2" 63.5mm	.150" 3.8mm	Takes (1) 15-1030 & (2) 15-1029 for 46" cut. Fits models 600 & 800 series 1997 & after, side discharge tractors. Mulching blade.
 15 - 1038	942-0645	14-13/16" 376.2mm	"H" Pattern	21/64" 8.2mm	2-1/2" 63.5mm	3" 76.2mm	.125" 3.2mm	Takes (1) 15-1038 & (2) 15-1037 for 46" cut. Fits deep deck riding mowers, 1997 & after. Mulching blade.
 15 - 1021	942-0542 742-0542	16-1/4" 412.8mm	"H" Pattern	5/16" 7.9mm	2-1/2" 63.5mm	3" 76.2mm	.125" 3.2mm	Takes (2) 15-1021 & (1) 15-1022 for 46" cut
 15 - 1037	942-0644	16-1/4" 412.8mm	"H" Pattern	5/16" 7.9mm	2-1/2" 63.5mm	3" 76.2mm	.125" 3.2mm	Takes (1) 15-1038 & (2) 15-1037 for 46" cut. Fits deep deck riding mowers, 1997 & after. Mulching blade.
 15 - 1029	942-0611 742-0611	16-1/4" 412.8mm	"H" Pattern	3/8" 9.5mm	2-1/2" 63.5mm	2-1/2" 63.5mm	.150" 3.8mm	Takes (1) 15-1030 & (2) 15-1029 for 46" cut. Fits models 600 & 800 series 1997 & after, side discharge tractors. Mulching blade.
 15 - 1034	942-0623	17-5/16" 439.7mm	"H" Pattern	21/64" 8.2mm	2-1/2" 63.5mm	2-1/2" 63.5mm	.187" 4.8mm	(3) blades for 50" cut. Fits deep deck riding mowers, 1998 & after. Mulching blade.
 15 - 11719	742-0677 942-0677	18-1/2" 469.9mm	"H" Pattern			3" 76.2mm	.204" 5.1mm	(3) blades for 54" cut. Fits 2002 and newer models 54" riders.

30

O.E.M.

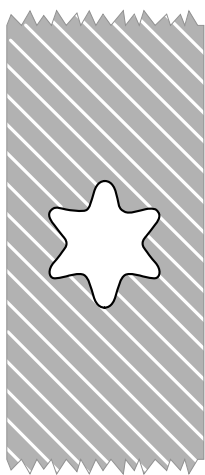

Old blade
Center Hole Pattern

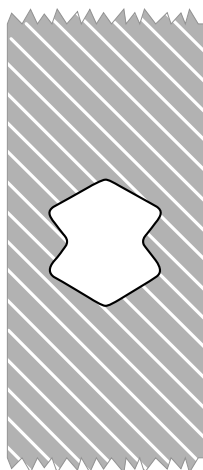

New Blade
Center Hole "H" Pattern

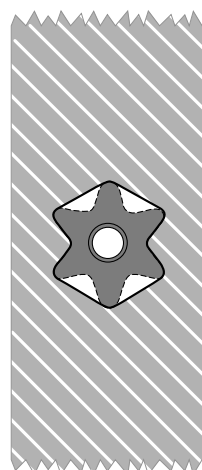

New Blade Center Hole
with MTD's 6 Point
Star Spindle

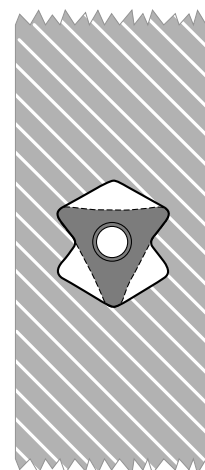









New Blade Center Hole
with our 10-9284, 10-9285,
10-9286, 10-9287,
10-9288 Spindle



O.E.M. REPLACEMENT

MTD (Cont.)

30
O.E.M.

ORDER NO.	REPLACES O.E.M. NO.	LENGTH	CENTER HOLE DIAM.	OUTSIDE HOLE DIAM.	CENTER TO CENTER	WIDTH	STEEL THICK.	APPLICATION
 15 - 1024	942-0610	19-5/16" 490.5mm	"H" Pattern	5/16" 7.9mm	2-1/2" 63.5mm	3" 76.2mm	.150" 3.8mm	(2) blades for 38" cut.
 15 - 1026	942-0610	19-5/16" 490.5mm	"H" Pattern	5/16" 7.9mm	2-1/2" 63.5mm	3" 76.2mm	.150" 3.8mm	(2) blades for 38" cut. Mulching Blade
 15 - 11232	942-0610	19-5/16" 490.5mm	"H" Pattern	5/16" 7.9mm	2-1/2" 63.5mm	3" 76.2mm	.150" 3.8mm	(2) Blades for 38" cut. Mulching Blade.
 15 - 1031	742-04126 942-0616 742-0616	21-3/16" 538.2mm	"H" Pattern	5/16" 7.9mm	2-1/2" 63.5mm	3" 76.2mm	.150" 3.8mm	(2) blades for 42" cut.
 15 - 1032	742-04126 942-0616 742-0616	21-3/16" 538.2mm	"H" Pattern	5/16" 7.9mm	2-1/2" 63.5mm	3" 76.2mm	.150" 3.8mm	(2) blades for 42" cut. Mulching Blade
 15 - 11233	742-04126 942-0616 742-0616	21-3/16" 538.2mm	"H" Pattern	5/16" 7.9mm	2-1/2" 63.5mm	3" 76.2mm	.150" 3.8mm	Mulching Blade.
 15 - 12956	942-04244 942-04290	23-1/2" 596.9mm	5 point star			2-1/2" 63.5mm	.150" 3.81mm	Fits Cub Cadet series 100 LTX lawn tractors with 46" decks, 2009 and after. Also fits LTX1046.
 15 - 1023	942-0609	30" 762mm	"H" Pattern	21/64" 8.2mm	2-1/2" 63.5mm	2-3/4" 69.9mm	.160" 4.0mm	Fits MTD side discharge deck, riding mowers 1990 & after.

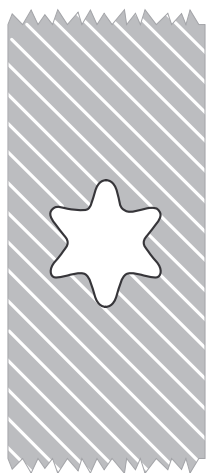

Old blade
Center Hole Pattern

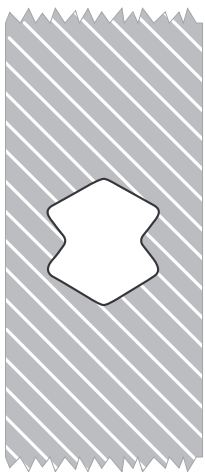

New Blade
Center Hole "H" Pattern

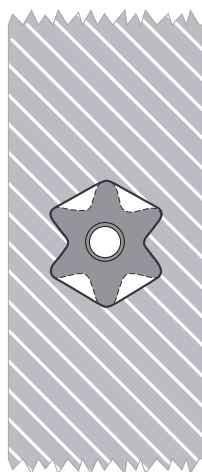

New Blade Center Hole
with MTD's 6 Point
Star Spindle

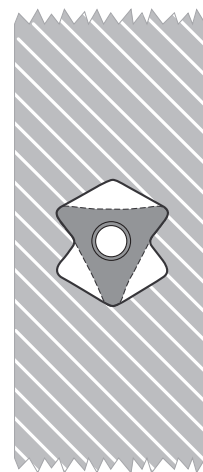

New Blade Center Hole
with our 10-9284, 10-9285,
10-9286, 10-9287,
10-9288 Spindle



MTD (Cont.)

ORDER NO.	REPLACES O.E.M. NO.	LENGTH	CENTER HOLE DIAM.	OUTSIDE HOLE DIAM.	CENTER TO CENTER	WIDTH	STEEL THICK.	APPLICATION
15 - 6448	942-0738	18" 457.2mm	59/64" X 11/16" Prox.*	5/16" 7.9mm	2-1/2" 63.5mm	2-1/4" 57.2mm	.134" 3.4mm	* See Details Below * Mulching blade. Fits MTD deck 1995 & newer. Fits 18" walkbehind.
15 - 6438	942-0740	20" 508mm	59/64" X 11/16" Prox.*	5/16" 7.9mm	2-1/2" 63.5mm	2-1/4" 57.2mm	.125" 3.2mm	* See Details Below * Mulching blade. Fits MTD deck 1997 & newer. Fits 20" walkbehind.
15 - 6439	942-0640	20" 508mm	59/64" X 11/16" Prox.*	5/16" 7.9mm	2-1/2" 63.5mm	2-1/4" 57.2mm	.125" 3.2mm	* See Details Below * High lift blade. Fits MTD deck 1997 & newer. Fits 20" walkbehind.
15 - 6423	942-0741 742-0741	21" 532.2mm	59/64" X 11/16" Prox.*	5/16" 7.9mm	2-1/2" 63.5mm	2-1/4" 57.2mm	.125" 3.2mm	* See Details Below * Mulching blade Fits MTD deck 1995 & newer.
15 - 6450	942-0641	21" 533.4mm	59/64" X 11/16" Prox.*	5/16" 7.9mm	2-1/2" 63.5mm	2-1/4" 57.2mm	.134" 3.4mm	* See Details Below * High lift blade. Fits MTD deck 1997 & newer. Fits 21" walkbehind.
15 - 6424	942-0742 742-0742	22" 558.88mm	59/64" X 11/16" Prox.*	5/16" 7.9mm	2-1/2" 63.5mm	2-1/4" 57.2mm	.125" 3.2mm	* See Details Below * Mulching blade Fits MTD deck 1995 & newer. Fits 22" walkbehind.
15 - 6425	942-0642 742-0642	22" 558.88mm	59/64" X 11/16" Prox.*	5/16" 7.9mm	2-1/2" 63.5mm	2-1/4" 57.2mm	.125" 3.2mm	* See Details Below * Fits MTD deck 1995 & newer. Fits 22" walkbehind.

NOTE: ROTARY DOES NOT SELL THIS BLADE ADAPTOR, THIS IS FOR ILLUSTRATION ONLY

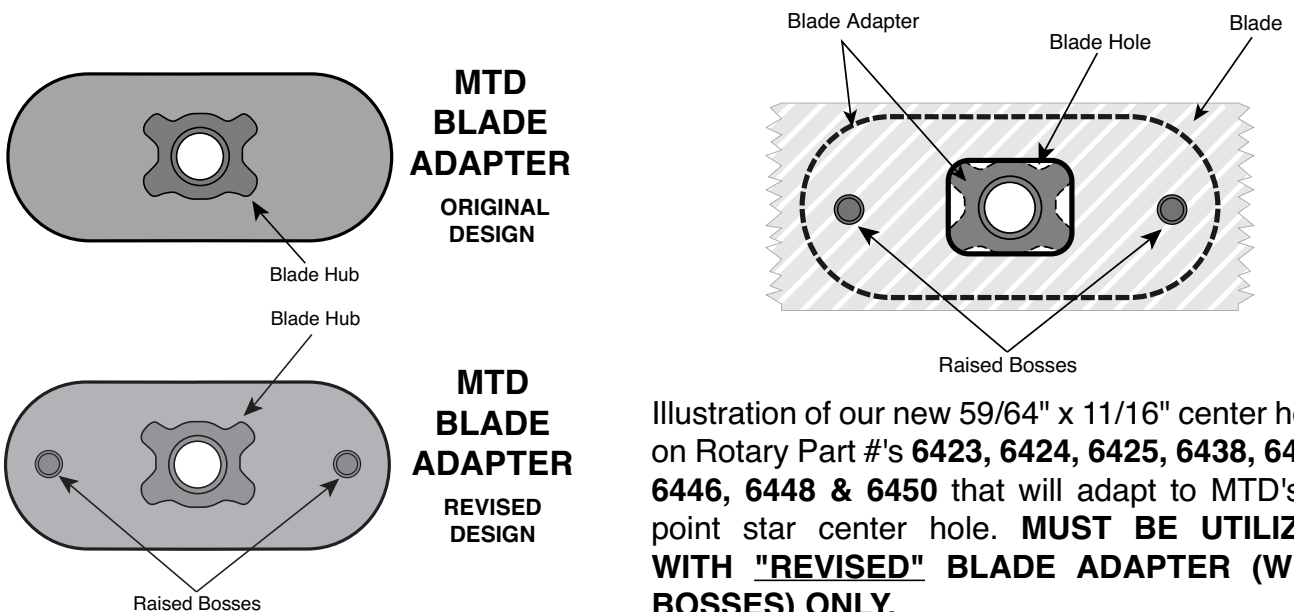



Illustration of our new 59/64" x 11/16" center hole, on Rotary Part #'s 6423, 6424, 6425, 6438, 6439, 6446, 6448 & 6450 that will adapt to MTD's 4-point star center hole. **MUST BE UTILIZED WITH "REVISED" BLADE ADAPTER (WITH BOSSES) ONLY.**



O.E.M. REPLACEMENT

MTD (Cont.)

ORDER NO.	REPLACES O.E.M. NO.	LENGTH	CENTER HOLE DIAM.	OUTSIDE HOLE DIAM.	CENTER TO CENTER	WIDTH	STEEL THICK.	APPLICATION
 14 - 10631		20" 508mm	1" 25.4mm			2-1/2" 63.5mm	.150" 3.8mm	*See Details Below* Universal Commercial Mulching Blade.
 14 - 10633		22" 558.8mm	1" 25.4mm			2-1/2" 63.5mm	.150" 3.8mm	*See Details Below* Universal Commercial Mulching Blade.

NOTE: ROTARY DOES NOT SELL THIS BLADE ADAPTOR, THIS IS FOR ILLUSTRATION ONLY

30 O.E.M.

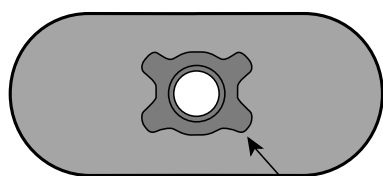

MTD BLADE ADAPTER

ORIGINAL DESIGN

Blade Hub
Blade Hub

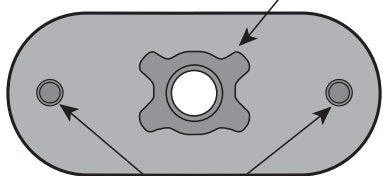

MTD BLADE ADAPTER

REVISED DESIGN

Raised Bosses

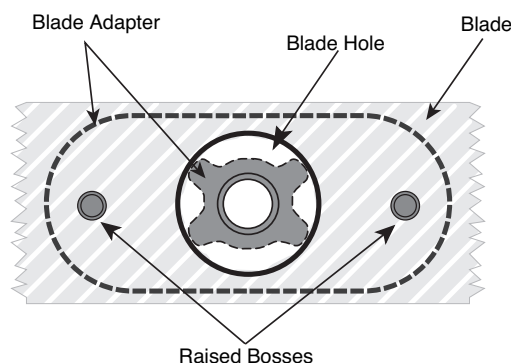
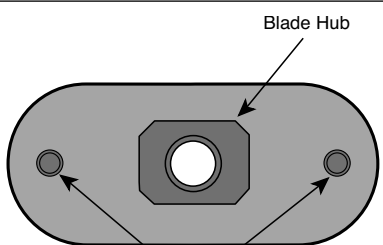

Illustration of our new 1" center hole Universal Commercial Mulcher, on Rotary Part #'s **10631, 10632, 10633** that will adapt to MTD's 4-point star center hole. **MUST BE UTILIZED WITH "REVISED" BLADE ADAPTER (WITH BOSSES) ONLY.**



MTD BLADE ADAPTER

Illustration of our new 7/8" center hole Universal Commercial Mulcher, on Rotary Part #'s **14580, 14581, 6448, 12893, 438, 6439, 6423, 6450, 6424, 6425** that will adapt to MTD's 4-point star center hole.

Raised Bosses

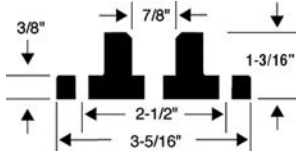

Order No. 17 - 14580

Blade adapter fits MTD walkbehind mowers. Fits our **15-6448, 15-12893, 15-6438, 15-6439, 15-6423, 15-6450, 15-6424, 15-6425** blades.

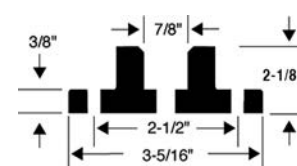

Order No. 17 - 14581

Blade adapter fits MTD walkbehind mowers. Fits our **15-6448, 15-12893, 15-6438, 15-6439, 15-6423, 15-6450, 15-6424, 15-6425** blades.



MTD (Cont.)

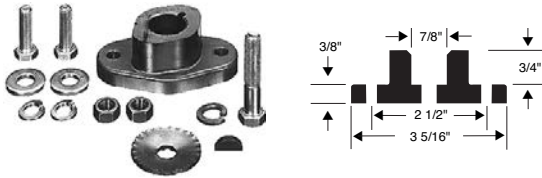

Order No. 17 - 1162

Replaces MTD 10769. For 7/8" crankshafts. Lowers blade 7/16". Has 5/32" keyway.



Order No. 17 - 6626

Blade Adaptor. Replaces MTD 748-0300.

Order No. 17 - 7810

Blade adaptor. Replaces MTD 748-0235 & 753-0210. Fits 30" 500 series rear engine riders with model 796 deck.

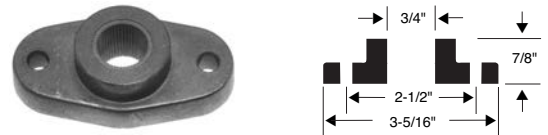

Order No. 17 - 7200

Blade adaptor assembly for our MTD 38" & 42" mulching kits. 7/16" width mounting holes.

Order No. 17 - 7119

Hub only. Replaces MTD 948-0365, 748-0365.



Order No. 17 - 9815

Blade adaptor replaces MTD 753-0583. Fits MTD riders. Includes our 17-6626 hub.

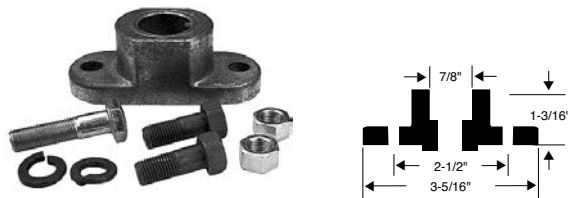

Order No. 17 - 10239

Blade adaptor kit replaces MTD 753-0484. Fits MTD walkbehind mowers. Has 3/16" built in key & 3/8" outside holes.

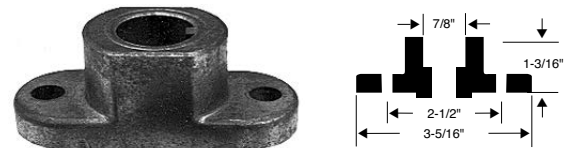

Order No. 17 - 10238

Blade hub only replaces MTD 948-0323. Fits MTD walkbehind mowers. Has 3/16" built in key & 3/8" outside holes. Used in our 17-10239 adaptor kit.



Order No. 17 - 8680

13/16" blade reducer will adapt our 1" universal blades to the following applications. MTD 090 series, MTD 030/040, MTD 312R, 313R, 315R, 816R, 818R, 462R - 479R, MTD 22" mulcher. MIN010



Order No. 18 - 14456

Muffler replaces MTD 751-10448C, single cylinder B&S.

30

O.E.M.



O.E.M. REPLACEMENT

MTD (Cont.)



Order No. 20 - 7730

Fuel tank bushing replaces MTD 735-0149. MIN010



Order No. 20 - 8679

Straight fuel fitting 1/4" & 7/16" nipple. Fits MTD and other models. Used with our 20-7730 fuel tank bushing. Metal 1-1/2" length. MIN010



Order No. 20 - 8678

"L" fuel fitting 1/4" & 7/16" nipple. Fits MTD and other models. Also replaces Snapper 12503. Used with our 20-7730 fuel tank bushing. MIN010



Order No. 20 - 8935

Fuel cap replaces MTD 951-3111, 751-3111.



Order No. 20 - 2235

Vented Fuel Cap replaces MTD.



Order No. 24 - 12650

Spark plug replaces MTD/Ryobi 791-180852B. Fits 4-cycle trimmers. Replaces Torch A4RTF & Champion RDZ19H our 24-9538.



Order No. 24 - 10950

BPMR6F NGK Replaces MTD 791-61031B. Resistor plug. MIN010



Order No. 26 - 13643

Starter extension cord replaces MTD 629-0071, 939-0071. Included in our 26-10975, 26-10976, 26-10982 starters.



Order No. 29 - 8620

Tiller tine set contains (8) of our 29-8610 left hand & 29-8611 right hand tiller tines, (32) of our 29-8621 cap screw, 29-8622 hex nut, 29-8623 lock washer.

Order No. 29 - 8610

Left hand tiller tine replaces MTD 742-0105. Three 3/8" bolt holes, 2-5/8" or 3-1/8" center to center, 12" bolo tine.

Order No. 29 - 8611

Right hand tiller tine replaces MTD 742-0106. Three 3/8" bolt holes, 2-5/8" or 3-1/8" center to center, 12" bolo tine.



Order No. 29 - 8621

Cap screw for our 29-8620 tiller tine set. 3/8" - 1, grade 5 cap screw. MIN010



Order No. 17 - 141

Lock washer for our 29-8620 tiller tine set. 3/8" zinc lock washer. MIN010



Order No. 29 - 8622

Hex nut for our 29-8620 tiller tine set. 3/8" - 16 zinc hex nut. MIN010

30

O.E.M.



MTD (Cont.)



Length 8"
Width 3-1/2"
Height 6-1/2"

Order No. 31 - 7724

Battery replaces MTD 753-0608, 725-1635, 725-1430 and 725-1438. Manifold vent. For MTD 12-1/2 & 16 hp riders. Right hand positive, 275 cranking amps. G50-N18L-A

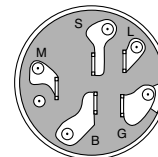

Order No. 31 - 2922

Ignition Switch. Replaces MTD 925-0267, 725-0267A.

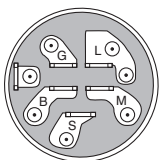

Order No. 31 - 9853

Ignition switch replaces MTD 725-1396, 925-1396. Fits lawn and garden tractors with B&S OHV Vanguard engines.

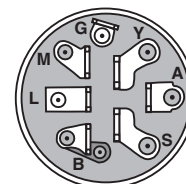

Order No. 31 - 9623

Ignition switch replaces MTD 725-1717. For engines equipped with fuel shut-off solenoid built since 1994. Includes key, lock-washer nut & cover, 6 post.



Order No. 31 - 10793

Molded ignition key replaces MTD 725-1341B. Has ergonomic slip resistant comfort grip.

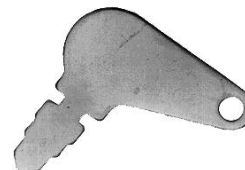

Order No. 31 - 6888

Ignition key. Replaces MTD 725-0128. Fits most riders.

MIN010



Order No. 31 - 13278

Starter key replaces MTD 725-1660 / TC35062. Fits MTD models 314-180-000, 314-180-088, TMO-3525203, 314-180-131 & 314-181-000. Pull / Push Key. MIN010

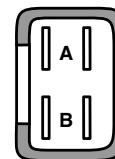

Order No. 31 - 9659

Plunger Interlock switch replaces MTD 925-3169A, 725-3169A. Double pole, normally open / normally closed.

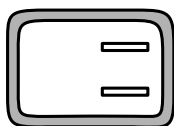

Order No. 31 - 9660

Plunger Interlock switch replaces MTD 725-1657A. Single pole, normally open.

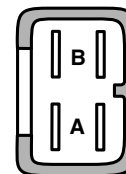

Order No. 31 - 9661

Plunger Interlock switch replaces MTD 925-1657A. Double pole, normally open/normally closed.

30

O.E.M.



O.E.M. REPLACEMENT

MTD (Cont.)

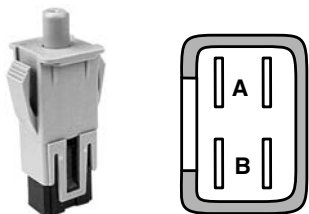

Order No. 31 - 9665

Plunger Interlock switch replaces MTD 925-3164A, 725-3164A. Double pole, snap in mount. Normally open/normally closed.



Order No. 31 - 9663

Plunger Interlock switch replaces Ariens 27541, John Deere AM103119, MTD 725-3167, Murray 57211, Snapper 15707. Single post, right angle snap in mounted. Normally open.



Order No. 31 - 9664

Plunger Interlock switch replaces MTD 925-3166, 725-3166. Single post, right angle snap in mounted. Normally closed.



Order No. 31 - 14246

Plunger safety switch replaces MTD/Cub Cadet 925-04040, 725-04040. Low profile double pole plunger switch N.C./N.C. 4 terminal.



Order No. 31 - 14247

Plunger safety switch replaces MTD 725-04165, 925-04165. Low profile double pole plunger switch. 4 terminal switch in NC/NO.

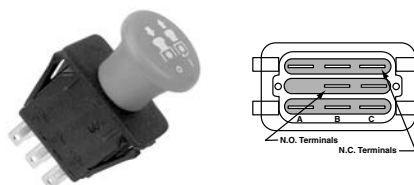

Order No. 31 - 9657

PTO switch replaces MTD 925-1716, 725-1716. Middle terminal blank. Push-pull/Snap in mount.



Order No. 31 - 14323

PTO switch replaces MTD 925-04175, 725-04175. 7 terminals.



Order No. 31 - 13106

PTO switch replaces MTD 725-04258, 925-04258. Fits models GT1054, GT1554, GT33100, GT3200, GTX1054, L1042, L1046, L1050, LT1040, LT1042, LT1045, LT1046, LT1050, LTX1042, LTX1045, LTX1046, LTX1050, SLTX1050, SLTX1054.



Order No. 31 - 7015

Ignition switch replaces MTD 925-1741



Order No. 31 - 12685

Heavy duty ignition switch with keys replaces MTD 925-1741. Similar to our 31-7015 but heavy duty.

30

O.E.M.



MTD (Cont.)



Order No. 31 - 14331

Seat switch replaces Cub Cadet / MTD 925-05013, 725-05013.

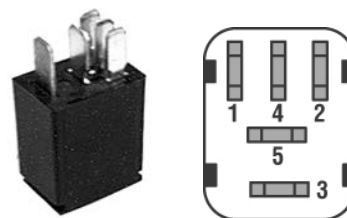

Order No. 31 - 10895

Relay replaces MTD 925-1648. 12 volt, 20 AMP. Fits auto drive riding mowers and snowthrowers.



Order No. 31 - 3319

Solenoid. Replaces MTD 925-0771, 725-0771 and 725-0530.



Order No. 31 - 10677

Solenoid replaces MTD 725-0771. Heavy Duty.



Order No. 31 - 7935

Solenoid replaces MTD 925-1426, 725-1426. Fits MTD front and rear engine rider models 1990 - 1994.



Order No. 31 - 7934

Solenoid replaces MTD 725-0771. Fits MTD front and rear engine rider models 1990 - 1994.



Order No. 31 - 10771

Universal starter solenoid 3 pole, 12 volt. Terminal post will accommodate both 5/16" & 1/4" terminal connectors, Mounting bracket will accommodate both chassis and wall mount configurations. Replaces MTD 725-0771, 725-1426, 725-0530, 925-1426, 925-0771



Order No. 31 - 10772

Universal starter solenoid 4 pole, 12 volt. Terminal post will accommodate both 5/16" & 1/4" terminal connectors, Mounting bracket will accommodate both chassis and wall mount configurations. Replaces MTD 725-04437.



Order No. 31 - 14220

Solenoid starter replaces MTD 725-04439, John Deere AM138068. No hardware, 1/4" terminal studs.



Order No. 41 - 5547

Worm gear replaces MTD 717-1425 & 917-1425. Fits 28" & 33" width snowblowers, models 800 & 900.

30
O.E.M.

O.E.M. REPLACEMENT



MTD (Cont.)



Order No. 41 - 5545

Differential connecting shaft replaces MTD 738-0284.



Order No. 41 - 5546

Snowblower axle replaces MTD 738-0276. Fits two stage 28" & 33" models 800 & 900.



Order No. 41 - 5521

Rubber Paddles replaces MTD 753-0613 (kit), 731-0782 (bar), 731-0780 (right curve), 731-0781 (left curve). **6 piece set.**

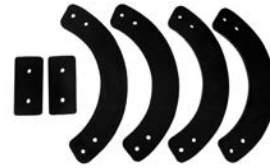

Order No. 41 - 13167

Snowblower paddle set replaces MTD 753-04472. Includes (4) 735-04032 spirals & (2) 735-04033 paddles. Fits newer 21" single stage throwers.



Order No. 41 - 5523

Scraper Bar replaces MTD 731-1033. Fits model Snow Wolf. **19-7/8" length x 2-1/8" width x 1" mounting hole.**



OD 4-7/8"
Thick 1/2"
ID 3-7/8"



Order No. 41 - 5612

Friction rubber wheel replaces MTD 935-0243B, 735-0243. Rubber disc for walkbehind snow blowers.



Order No. 41 - 8628

Shear pin & nut replaces MTD 910-0891, 710-0891 (pin) & 712-0158 (nut). Fits MTD with auger drive snowblowers. Size 5/16" - 18 x 1-3/4". **MIN005**



Order No. 41 - 5549

Shear pin & Cotter pin replaces MTD 738-04124A. Fits models 31A-3BAD700 thru 31AS6LEG752 series 2005 and newer snowthrowers. **MIN005**

Order No. 41 - 8627

Shear pin & nut replaces MTD 910-0890A, 710-0890 (pin) & 712-0158 (nut). Fits MTD with auger drive snowblowers. Size 5/16" - 18 x 1-1/2". **MIN005**



Order No. 41 - 8828

Snowblower skid replaces MTD 784-5580-0637, 784-5580. Fits all two stage units.



Order No. 41 - 5568

Snowblower shoe fits MTD.



Order No. 41 - 9122

Snowblower skid replaces MTD 05002-0637. Fits 1988 & 1989, 20" & 26" snowblowers models 225 & 590.



Order No. 41 - 5134

Double sided, reversible runner. Also fits MTD. Painted orange.

30

O.E.M.



MTD (Cont.)

ID 10"
OD 10-1/4"
Width 3-1/2"



Order No. 41 - 7766

Snowblower skid replaces MTD 784-5038B-0637, 784-5038B, 784-5038A. Fits models 449, 450, 550, 552, 586 & 588.



Order No. 41 - 5584

Snowblower skid replaces MTD 731-06472, universal deluxe poly snowblower skid shoes kit. Fits most MTD 2 stage snow throwers. Helps protect driveway walkways, garages and porches for snowblower damage. Non-abrasive material helps prevent scratches.



Order No. 41 - 8635

Universal snowblower shoe fits MTD.



Order No. 41 - 5585

Universal snowblower skid shoes set. Fits most MTD 2 stage snowthrowers. Eccentric washers allow mounting to a variety of mounting dimensions. Mounting width (min 2", max 3", 5/16" bolt holes. Similar to our 41-8635.



Order No. 41 - 5591

22" Shave plate replaces MTD 790-00117-0637 / 784-5576-0637. Fits 22" MTD two-stage snowthrower models 611D & 623D.



Order No. 41 - 5592

24" Shave plate replaces MTD 790-00120-0637. Also replaces MTD 784-5581A, 784-5581A-0637, 784-5581A-0662, 784-5581A-0687.



Order No. 41 - 5593

26" Shave plate replaces MTD 790-00121-0637, 784-5579A, 753C0628.



Order No. 41 - 5594

27" or 28" Shave plate replaces MTD 790-00118-0637, 784-5582A, 753C0629.



Order No. 41 - 5595

30" Shave plate replaces MTD 790-00119-0637.

30

O.E.M.

O.E.M. REPLACEMENT
MURRAY



Order No. 02 - 41

Woodruff Key. Replaces Murray 20062.

MIN010



Order No. 02 - 9470

Hex head 3/8" - 16 x 1-1/4" self-tapping screw. Replaces Murray 25X7MA.

MIN010



Conduit 50"
Inner Wire 55"
Wire Travel 1-1/2"

Order No. 03 - 8960

Heavy duty throttle control fits Murray walk behind mowers. Plastic conduit converts from positive to negative action. Same as our 03-7974 but is **Heavy Duty**.



Conduit 71"
Inner Wire 76"
Wire Travel 1-1/2"

Order No. 03 - 8961

Heavy duty throttle control fits Murray walkbehind mowers. Plastic conduit converts from positive to negative action. Same as our 03-7975 but is **Heavy Duty**.

30

O.E.M.

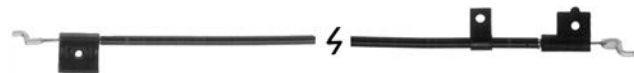

Order No. 03 - 8416

Engine stop cable replaces Murray 43749 & 42363. 45-1/2" conduit length, 54-1/2" wire length. Plastic covered conduit with brackets.

Order No. 03 - 8415

Engine stop cable replaces Murray 42569. 44-1/2" conduit length, 52-1/2" wire length. Plastic covered conduit with brackets.



Order No. 03 - 228

Throttle Control. Replaces Murray 21223PA. 60" Plastic covered conduit. Positive action. with Knob.

Order No. 03 - 229

Throttle Control. Replaces Murray 21222PA. 60" Conduit. Positive action. with Knob.

Order No. 03 - 230

Throttle Control. Replaces Murray 21540PA and 23332PA. 14" conduit. Positive action. with Knob.



Conduit 68"
Inner Wire 69-1/4"
Wire Travel 1-7/16"

Order No. 03 - 8530

Throttle control assembly replaces Murray 420005. Fits all Murray walk behind mowers for 1985 thru 1995. Assembly includes throttle control, nut, screw, 4" cable ties, mounting adapter & instructions. (carded)



Order No. 03 - 7974

Throttle control replaces Murray 71180, 71157 on walkbehind mowers. Plastic conduit converts from positive to negative action. Conduit 50", Inner wire 55", Wire Travel 1-1/2"

Order No. 03 - 7975

Throttle control fits Murray walkbehind mowers. Plastic conduit converts from positive to negative action. Conduit 71", Inner wire 76", Wire Travel 1-1/2"



Conduit 48-1/2"
Inner Wire 51-19/32"
Wire Travel 1-17/64"

Order No. 03 - 242

Throttle Control. Replaces Murray 42096, 42776, 42878, 42879, 42949, 42775. 48-1/2" conduit. Positive action slide control. One bolt mounting. Black case with red slider knob. Fits 3/4" or 7/8" tubing, loop or "T" handle.



Order No. 03 - 8506

Throttle control mounting adapter for Murray. Used with our 03-8530 throttle control assembly.

MIN010



MURRAY (Cont.)



Conduit 60-13/32"
Inner Wire 62-9/32"
Wire Travel 3/4"

Order No. 03 - 7961

Throttle control fits Murray 42096. Positive action control.



Conduit 44-1/2"
Inner Wire 47"
Wire Travel 1-7/8"

Order No. 03 - 9685

Throttle control replaces Murray 7701016, 740194. Fits high wheel trimmers.



Conduit 21"
Inner Wire 23-1/2"
Wire Travel 7/8"

Order No. 03 - 9684

Throttle control replaces Murray 91989.



Conduit 44"
Inner Wire 50"

Order No. 03 - 10690

Engine stop cable replaces Murray 1101093. Fits 20" walkbehind mowers from 2000-2003. 3/16" Z bend on one end, 1/4" T on other end.



Conduit 45-1/4"
Inner Wire 52-1/4"

Order No. 03 - 10691

Engine stop cable replaces Murray 1101181. Fits 20" & 22" walkbehind mowers from 2001-2002. 3/16" Z bend on one end, 1/4" T on other end.



Conduit 42-1/2"
Inner Wire 48-3/4"

Order No. 03 - 10692

Engine stop cable replaces Murray 1101360. Fits 20" walkbehind mowers with rear bagger made from 2001-2003. 3/16" Z bend on one end, 1/4" T on other end.



Conduit 52"
Inner Wire 59-1/4"

Order No. 03 - 10693

Engine stop cable replaces Murray 1101366. Fits 22" walkbehind mowers with Tecumseh engines made from 2000-2003. 3/16" Z bend on each end.



Conduit 52-1/4"
Inner Wire 59-1/4"

Order No. 03 - 10694

Engine stop cable replaces Murray 672835. Fits walkbehind mowers with Tecumseh engines made from 2000-2003. 3/16" Z bend on one end, 1/4" T on other end.



Conduit 42-1/2"
Inner Wire 50"

Order No. 03 - 10695

Engine stop cable replaces Murray 672840. Fits walkbehind mowers made from 2000-2003. 3/16" Z bend on one end, 1/4" T on other end.



Conduit 40"
Inner Wire 48-1/2"

Order No. 03 - 10697

Engine stop cable replaces Murray 43828. Fits 22" walkbehind mowers, braided cable with die cast Z-bend on one end. Z bend on one end, T on other end.

30

O.E.M.



O.E.M. REPLACEMENT

MURRAY (Cont.)

Total Length 28-1/4"



Order No. 05 - 9125

Lift cable replaces Murray 24470. Fits 38" & 39" cut models. 28-1/4" total length with molded rod end 5/16" x 18" rod.

Conduit 43"
Inner Wire 49-3/8"
Wire Travel 6"



Order No. 05 - 12969

Blade brake cable replaces Murray 1102094MA.

Inner Wire 59"
Conduit 55-1/4"

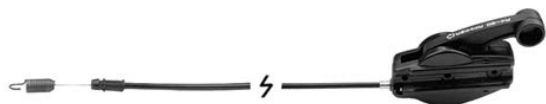

Order No. 05 - 10696

Drive control assembly replaces Murray 740193. Latching cable with control. Fits walkbehind string trimmers. "Z" bend on end.

Inner Wire 61"
Conduit 59"

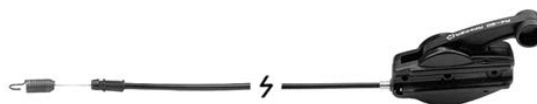

Order No. 05 - 10689

Drive control assembly replaces Murray 1101344. Fits self propelled 22" walkbehind mowers.

Length 1-5/16"



Order No. 05 - 8970

Adjusting nut replaces Murray 21920. Fits bolt size 3/8" - 16.

ID 1/2"
OD 1"
Height 3/4"



Order No. 05 - 478

Sprocket. Replaces Murray 20411.

ID 3"
OD 6"



Order No. 05 - 300

Replaces Murray 35550. Also fits Sears Rider made by Murray.

ID 2-1/4"
OD 4-7/16"



Order No. 05 - 7018

Driven Disc. Replaces Murray 1501435. Fits 21" SP mowers.

Order No. 05 - 308

Drive pinion. Replaces Murray 20066.



ID 5/8"
OD 2-3/4"
Width 1-7/8"

OD 8"
Width 1-3/4"
Bore 1/2"



Order No. 07 - 11021

Plastic wheel replaces Murray 071133. Fits walkbehind mowers. Geared wheel drive for 20", 21" & 22" self propelled walk-behind mowers.



Order No. 07 - 283

Murray 20105. 8" x 1.75", 1/2" C.H., offset hub, lug tread.

30

O.E.M.



MURRAY (Cont.)



ID 11/16"
Width 4-3/16"
Height 2-1/2"

Order No. 07 - 8310

Deck wheel replaces Murray 23203.



ID 13/32"
Width 1-1/2"
Height 3"

Order No. 07 - 8311

Deck wheel replaces Murray 23257.



ID 1/2"
Width 2-3/4"
Height 5"

Order No. 07 - 6916

Deck Wheel, replaces Murray 92683, 092265. 2-1/2" offset hub.



ID 1/2"
Width 2"
Height 5"

Order No. 07 - 10087

Deck wheel replaces Murray 92683. Fits units after the year 2000.



ID 5/8" (15.88 mm)
OD 1-3/8" (34.93 mm)
Height 7/16" (11.11 mm)

Order No. 09 - 8831

Spindle bearing for Murray 92574 spindle assembly. Fits our 10-2925 Murray spindle assembly. Also used in our 10-8320 spindle repair kit. Lower bearing.



ID 5/8" (15.88 mm)
OD 1-9/16" (39.69 mm)
Height 15/32" (11.91 mm)

Order No. 09 - 8861

Spindle bearing for Murray 92574 spindle assembly. Fits our 10-2925 Murray spindle assembly. Also used in our 10-8320 spindle repair kit. Upper bearing.



ID 5/8" (15.88 mm)
OD 1-1/8" (28.58 mm)
Height 3/4" (19.05 mm)
Flange OD 1-1/4" (31.75 mm)

Order No. 09 - 2936

Wheel Bearing. Replaces Murray 24615. Graphite Impregnated. 5/8" x 1-1/8".



ID 3/4" (19.05 mm)
OD 1-1/8" (28.58 mm)
Height 3/4" (19.05 mm)
Flange OD 1-1/4" (31.75 mm)

Order No. 09 - 2935

Bearing. Replaces Murray 403010. Graphite Impregnated. 3/4" x 1-1/8".



ID 5/8" (15.88 mm)
OD 1-9/16" (39.69 mm)
Height 15/32" (11.91 mm)

Order No. 09 - 483

Bearing. Used in many spindle shafts, Bearing No. 6203-2RS.



ID 5/8" (15.88 mm)
OD 1-3/8" (34.93 mm)
Height 7/16" (11.11 mm)

Order No. 09 - 8198

Reduction gear bearing. Fits Murray Spindle Assembly our 10-2925. Bearing No. 99502H-2RS.



ID 3/4" (19.05 mm)
OD 1-3/8" (34.93 mm)
Height 1" (25.40 mm)

Order No. 09 - 7258

Front wheel bushing replaces Murray 91334 & 491334. Used on 36", 38" and 40" front engine riders. (plastic)



ID 11/16" (17.46 mm)
OD 7/8" (22.23 mm)
Height 1-11/16" (42.86 mm)

Order No. 09 - 2892

Bushing only for our 10-2925.

30

O.E.M.



O.E.M. REPLACEMENT
MURRAY (Cont.)



ID 5/8" (15.88 mm)
OD 1-3/8" (34.93 mm)
Height 45/64" (17.86 mm)

Order No. 09 - 9044

Flanged wheel bushing replaces Murray 56105. Fits Murray riders. Nylon



ID 7/8" (22.23 mm)
OD 1-3/8" (34.93 mm)
Height 1" (25.40 mm)

Order No. 09 - 7716

Front wheel bushing replaces Murray 93064. Fits 18 hp Murray lawn tractors .Nylon



ID 5/8" (15.88 mm)
OD 7/8" (22.23 mm)
Height 11/16" (17.46 mm)

Order No. 10 - 8308

Shaft spacer replaces Murray 23213. Fits 42" Murray deck, center pulley spacer. Fits models 8-38222, 7-39004.



ID 3/4" (19.05mm)
OD 7/8" (22.23mm)
Height 11/16" (17.46mm)
Flange OD 1-1/8" (28.58mm)

Order No. 09 - 9746

Flange bushing replaces Murray 90035. Fits front axle spindle bearing on Murray Pre-1991 tractors. MIN010

30

O.E.M.

Order No. 09 - 5619

Fan bearing with flange replaces Murray 761507 & MJ761507 & 780048 bearing for snowthrower. Flange with cage measures: 3-3/4" L x 2-3/4" W. Bolt holes are on 3" centers.



ID 7/8" (22.2mm)
Height 47/64" (18.7mm)
Keyway 9/16" (14.3mm)



Order No. 10 - 8320

Spindle repair kit for our 10-2925 Murray spindle assembly fits 1983 and newer models. Comes with (1) 09-8831 5/8" x 1-3/8" OD bearing, (10) 09-8861 5/8" x 1-9/16" OD bearing, (1) 09-2892 7/8" OD x 1-11/16" Bushing, (1) 1/2" x 20 nut. Used with our 10-7765 quill assembly.

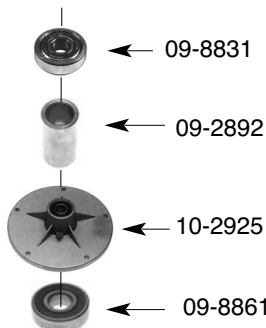

ID 5/8"
OD 6-7/8"
Height 2-37/64"



Order No. 10 - 8321

Spindle repair kit for Murray spindle assembly. Comes with (2) 09-1265 5/8" bearings, bearing, (1) 09-2892 7/8" OD x 1-11/16" bushing, (1) 1/2 x 20 nut.



Order No. 10 - 2925

Blade Housing. Replaces Murray 90905, 24384 & 492574. Uses bearing 09-8831 & 09-8861. Bushing 09-2892, Zerk 01-163.

Order No. 10 - 12925

Quill Assembly. (carded) MIN005

Order No. 10 - 12724

Spindle assembly replaces Murray 492574. Six Pack. MIN006





MURRAY (Cont.)



OD 6-7/8"
Height 7-1/4"

Order No. 10 - 10189

Jackshaft Housing Assembly replaces Murray 1001200. Fits 2001 models and up riding mowers. Includes shaft with grease zerk. Uses our **10-8901** nut. Uses Bearings **09-6513**



Order No. 10 - 7765

Quill assembly replaces Murray 55962 & 455962. Used on 30" cut rear engine rider model 30502.



Order No. 10 - 11996

Steering gear kit replaces Murray 402075. Fits many 1996 & later lawn tractors.



Order No. 10 - 13208

Steering sector gear replaces Murray 094121MA. Used on lawn tractors since 1997.

Size 9/16" - 18



Order No. 10 - 9329

Jackshaft nut replaces Murray 15x100. Fits Murray splined shafts. Hex head. MIN010

Size 1/2" - 20



Order No. 10 - 9296

Jackshaft locknut replaces Murray 15x72. Locknut for our **10-2925** spindle assembly & **10-8320** spindle repair kit. MIN010

Size 9/16" - 18



Order No. 10 - 8901

Pulley lock nut replaces Murray 25 x 140. Fits our **10-8479** Spindle Assembly.



Order No. 10 - 2210

Ball Joint Assembly. Replaces Murray 21031. 3/8"-24. (right hand treads).



Order No. 10 - 2933

Blade Drive Spring. Replaces Murray 165 x 4 (Old 28604). Coil diam. 3/4", Length overall 5-3/4", Length of coil 4-1/4", Thickness 3/32".



Order No. 10 - 2903

Idle Spring. Replaces Murray 20683. 165 x 3. Coil Diam. 3/4", Length overall 6", Length of coil 4-3/4", Thickness 5/64".

30

O.E.M.

O.E.M. REPLACEMENT
MURRAY (Cont.)



Order No. 10 - 2934

Blade Drive Spring. Replaces Murray 165 x 58 (old 20682). Coil diam. 5/8", overall Length 5", Length of coil 3-1/2", Thickness 5/64".



Order No. 10 - 9716

Extension spring replaces Murray 165X76SE. Coil Dia. 13/16", Total Length 11-1/2", Length of Coil 4-1/4", Thickness 1/8".

30

Order No. 10 - 8682

3/8" - 24 Female right hand thread ball joint. Fits go-carts & wagons. Also fits Murray 680070.



O.E.M.



Order No. 10 - 2904

Jackshaft. Replaces Murray 20616. 5-1/4" length.



Order No. 10 - 2931

Jackshaft. Replaces Murray 20616, 21024. 6-7/16" length.



Order No. 10 - 2937

Jackshaft replaces Murray 24578. 5-3/4" length.

Length 7"
OD 5/8"



Order No. 10 - 9906

Splined shaft replaces Murray 774091/94129. Fits Murray /Scotts 42" & 46" front engine riders. Fits our 8901 nut.



Order No. 10 - 6890

Splined Shaft replaces Murray 91922, 7-3/4" length, 5/8" OD. Fits Murray riders with 38" & 42" decks. Fits our 8901 nut.



Order No. 10 - 7282

Splined shaft replaces Murray 91921 6-1/4" length, 5/8" OD. Fits 38" and 42" Murray front engine riders. Fits our 8901 nut.



MURRAY (Cont.)



Order No. 10 - 7283

Jackshaft replaces Murray 55272. 6" length, 5/8" OD, 1/2" - 20 threads. Keyway 5/32".

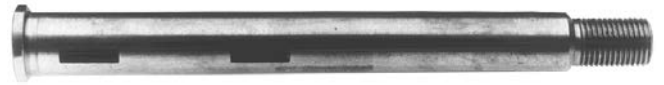

Order No. 10 - 7284

Replaces Murray 23180. Center shaft for 42" mowers. Fits models 9-38219, 9-38222, 9-38004, 9-38211. 5/8" OD, 6-1/8" Length.



Order No. 10 - 13605

Jackshaft replaces Murray 092849MA. Fits 38"-42" decks. Length 7.92"



Order No. 11 - 2905

Murray replacement Chain. Replaces Murray 23468.

30

O.E.M.



Order No.

Description

12 - 4998

Blade Belt. Replaces Murray 37 x 43, 1/2" (12.70 mm) x 82.1" length (2085.34 mm). Fits 36" deck.

12 - 6504

Blade Belt. Replaces Murray 37 x 40, 62.1" length (1577.34 mm). *Aramid fiber with bare back cover.

12 - 6507

Blade Belt. Replaces Murray 37 x 57, 53.68" length (1363.47 mm) *Aramid fiber with bare back cover.

12 - 6509

Blade Belt. Replaces Murray 37 x 63, 83.1" length (2110.74 mm). Glass cord construction with bare back cover.

12 - 6904

Blade Belt. Replaces Murray 37 x 62. "A" section belt, 85.94" length (2182.88 mm).

12 - 7672

Blade belt. Replaces Murray 37 x 70. 77-11/16" (1973.26 mm) x 1/2" (12.70 mm). Fits 46" cut 14-18 hp, 1990 - 1994 models.

12 - 7673

Blade belt. Replaces Murray 37 x 75. 90-5/8" (2301.88 mm) x 1/2" (12.70 mm). Fits 42" cut 12 - 18 hp, 1990 - 1994 models.

12 - 10911

Blade Drive Belt. Replaces Murray 37x111. 9/16" (14.28 mm) x 45" (1143 mm). Covered, general purpose polyester cord construction.

12 - 8444

Blade to Blade Belt. Replaces Murray 37 x 66. 1/2" (12.70 mm) width x 47.1" (1196.34 mm) length V belt. Fits Murray & Ultra Lawn Tractors 18 hp, 46300 series, 46" cut models.

O.E.M. REPLACEMENT



MURRAY (Cont.)



Order No.	Description
12 - 6502	Drive Belt. Replaces Murray 37 x 26, 88.3" length (2242.82 mm). *Aramid fiber with bare back cover.
12 - 6503	Transmission Belt replaces Murray 37 x 38, 40.3" length (1023.62 mm). Glass cord construction with bare back cover.
12 - 6505	Drive Belt. Replaces Murray 37 x 45, 37 x 33, 37 x 35; 90.5" length (2298.70 mm). Dacron cord construction with bare back cover.
12 - 9995	Drive Belt. Replaces Murray 37x87. 1/2" (12.7 mm) x 97" (2464 mm) Fits 38" deck lawn tractors. Polyester cord construction.
12 - 7245	Drive Belt. Replaces Murray No. 37 x 65. 30-3/16" length (766.76 mm). Motor to transaxle belt. Fits 30" rear engine rider models 25515B and 305351B.
12 - 10042	Drive Belt. Replaces Murray 37x98. 3/4" (19.05 mm) x 35.37" (898 mm). Fits Murray Go-Carts. *Aramid fiber.
12 - 10912	Drive Belt. Replaces Murray 37x112. 11/16" (17.46mm) x 66" (1676.4 mm). Fits 42" & 46" decks. Wrapped belt, 2 ply polyester cord construction.
12 - 11017	Deck Belt. Replaces Murray 321205. 5/8" (15.875 mm) x 97.23" (2469.6 mm). Raw edge, laminated, aramid cord construction.
12 - 9994	Deck Belt. Replaces Murray 37x80. 1/2" (12.7 mm) x 86-1/4" (2191 mm) Fits 40", 42" & 43" deck lawn tractors. Polyester cord construction.
12 - 6876	Deck Belt. Replaces Murray 37 x 12. Fits 42" decks. "A" section belt, 54.937" length (1395.40 mm).
12 - 6903	Deck Belt. Replaces Murray 37 x 22. "A" section belt, 99" length (2514.60 mm).
12 - 6508	Motion Drive Belt. Replaces Murray 37 x 61, 95" length (2413 mm). *Aramid fiber with bare back cover.
12 - 8442	Motion Drive Belt. Replaces Murray 37 x 68. 1/2" (12.70 mm) width x 101.68" (2582.67 mm) length V belt. Fits Murray & Ultra Lawn Tractors 18 hp, 46300 series, 46" cut models.
12 - 8747	Motion Drive Belt. Replaces Murray 37 x 64. 1/4" (6.35 mm) x 36.78" (934.21 mm). Fits Aerovac 21", 5-5.5 hp walk behind. V-belt, raw edge, *Aramid fiber.
12 - 9481	Motion Drive Belt. Replaces Murray 37 x 83. 1/2" (12.7 mm) x 81-3/4" (2076.45 mm). Fits Murray riders. General purpose, polyester cord construction.
12 - 10832	Motion Drive Belt. Replaces Murray 37x110. 1/2" (12.7 mm) x 43-7/8" (1114.4 mm). Fits 30" rear engine rider model 309304X8A. Wrapped, polyester cord construction.

30

O.E.M.



MURRAY (Cont.)



Order No.	Description
12 - 10910	Motion Drive Belt. Replaces Murray 37x106. 1/2" (12.7 mm) x 89" (2260.6 mm). Fits 38", 40", 42" & 46" decks with Hydro Transmission 2000 and after. 1 ply polyester cord construction.
12 - 8443	Engine to Deck Belt. Replaces Murray 37 x 69. 1/2" (12.70 mm) width x 80.3" (2039.62 mm) length. Fits Murray & Ultra Lawn Tractors 18 hp, 46300 series, 46" cut models.
12 - 8972	V- Belt. Replaces Murray 37x88. 1/2" (12.7 mm) x 88.24" (2241.3 mm). Fits 42" Hydro tractor. *Aramid fiber, Wrapped Belt.
12 - 9712	V-Belt. Replaces Murray 37 x 86. 1/2" (12.7 mm) x 84" (2133.6 mm). Fits 38" Murray riders. Polyester cord construction. Covered.
12 - 9313	Primary Belt. Replaces Murray 37x89. 1/2" (12.7 mm) x 87" (2209.8 mm). Fits 46" cut mowers. *Aramid fiber. Wrapped belt.
12 - 9715	Primary Blade Drive Belt. Replaces Murray 37 x 96. 1/2" (12.7 mm) x 88-1/4" (2241.55 mm). Fits 46" Murray riders. *Aramid fiber. Covered.
12 - 9714	Primary Blade Drive Belt. Replaces Murray 37 x 93. 5/8" (15.8 mm) x 109" (2768.6 mm). Fits 52" Murray riders. *Aramid fiber. Covered.
12 - 11029	Primary Drive Belt. Replaces Murray 37x114. 25/32" (19.8 mm) x 29-11/32" (745.3 mm). Wrapped, polyester cord construction.
12 - 9713	Secondary Blade Drive Belt. Replaces Murray 37 x 92. 1/2" (12.7 mm) x 52" (1320.8 mm). Fits 50" Murray riders. Polyester cord construction. Covered.
12 - 11030	Secondary Drive Belt. Replaces Murray 37x115. 25/32" (19.8 mm) x 34" (863.6 mm). Wrapped, polyester cord construction.
12 - 10913	Secondary Drive Belt. Replaces Murray 37x113. 25/32" (19.8 mm) x 44-25/32" (1137.4 mm). Wrapped, polyester cord construction.
12 - 14120	 Snowthrower Belt. Replaces Murray 585416MA . 1/2" (12.7 mm) x 38-3/8" (965.2 mm). Fits Craftsman & Murray dual stage snow throwers & Snow Blizzard. Raw edge, Aramid cord.
12 - 12462	Torque Converter Belt. Replaces Murray 37x125 . Torque converter belt for Go-Karts. Aramid cord construction.
12 - 13541	Trans Drive V-Belt. Replaces Murray 7035500YP . 1/2" (12.7 mm) x 85-3/8" (2168.5mm). Trans drive belt, dual spindle brake. Fits 7800000 model series riders. Double cover, Aramid cord construction.

Made with KEVLAR® or non-trade marked Aramid fiber.



O.E.M. REPLACEMENT

MURRAY (Cont.)



Order No. **Description**

- 13 - 2915** Flat Idler with Flange.
Repl. Murray 23339.
- 13 - 2916** Flat Idler repl. Murray 21409.
- 13 - 2917** Flat Idler repl. Murray 23238.
- 13 - 2918** V-Belt Idler repl. Murray 20613.
- 13 - 2919** V-Belt Idler repl. Murray 23211.
- 13 - 3236** Flat Idler repl. Murray 90118.



Order No. **Description**

Steel Pulleys

- 13 - 2926** Pulley repl. Murray 20615.
- 13 - 2928** Pulley repl. Murray 21022.
- 13 - 2929** Pulley repl. Murray 21096.
- 13 - 3317** Pulley repl. Murray 23739.

30

O.E.M.



ID 5/8" splined
OD 5-1/4"
Height 1"

Order No. 13 - 7417

Pulley replaces Murray 91769, 91943. Fits 1989 and up 40" deck, 40600 series. Used with our 10-6890 splined shaft.



ID 9/16" splined
OD 7-1/2"
Height 1-3/8"

Order No. 13 - 7986

Blade spindle pulley replaces Murray 91951 & 774090. Fits 30" rear engine rider 11 hp models 3059X1A, 30594X1A and 30595X1A.



ID 9/16" splined
OD 5"
Height 2-9/16"

Order No. 13 - 7994

Blade spindle pulley (center pulley) replaces Murray 92128. Fits 46" front engine rider 14 and 18 hp models 46620B, 46620X15A and 46621X92B



ID 9/16" splined
OD 5-1/4"
Height 1-13/32"

Order No. 13 - 7991

Blade spindle pulley replaces Murray 91943, 91769. Fits 38" front engine rider. 12 hp model 38617X5A, 38618X92A & 38608X12D.



ID 9/16" splined
OD 5"
Height 1-27/64"

Order No. 13 - 7993

Blade spindle pulley (right and left) replaces Murray 92127. Fits 46" front engine rider 14 And 18 hp models 46620B, 46620X15A & 46621X92B.



ID 9/16" splined
OD 6-1/4"
Height 1-13/32"

Order No. 13 - 7995

Blade spindle pulley replaces Murray 92425. Fits 42" front engine rider 18 hp model 42170X9A



ID 1/2"
OD 4-3/4"
Height 1-3/8"

Order No. 13 - 7126

Blade Belt Idler replaces Murray 91801. Fits 36", 38", 40" and 46" lawn tractors. Model 38608A, 9-35500 and 9-40620. Composite: Glass Filled Nylon.



ID 1/2"
OD 3"
Height 11/16"

Order No. 13 - 7127

Idler Pulley replaces Murray 91178 & 4206130. Fits 25", 30" and 36" rear engine rider models No. 7-35500, 7-30502 and 7-25501. Composite: Glass Filled Nylon.



MURRAY (Cont.)



ID 1/2"
OD 3-11/32"
Height 1-1/16"

Order No. 13 - 7978

Flat idler pulley replaces Murray 91179 & 421409. Engine to transmission idler, fits 38" cut 12 hp lawn tractor 1987 -1993. Composite: Glass Filled Nylon.



ID 21/32"
OD 3-11/32"
Height 1"

Order No. 13 - 9544

Idler pulley replaces Murray 690-407, 690409.



ID 3/8"
OD 2-5/8"
Height 5/8"

Order No. 13 - 10164

Idler pulley replaces Murray 056526. Drive belt idler on rear engine 25" & 30" riders.



ID 3/8"
OD 6"
Height 1-1/4"

Order No. 13 - 9865

Idler pulley replaces Murray 95068, 95272.



Order No. 13 - 9542

Idler pulley replaces Murray 690387. ID 11/16", OD 4-11/16", Height 1-3/8".

Order No. 13 - 9543

Idler pulley replaces Murray 690549. ID 11/16", OD 4-5/8", Height 1".



Order No. 13 - 10131

Idler pulley replaces Murray 690410. ID 11/16", OD 3", Height 1".



ID 1/2"
OD 11/16"
Height 15/32"

Order No. 13 - 9546

Idler pulley reducer bushing replaces Murray 690369.



ID 5/8"
OD 7"
Height 1-17/64"
Keyway 3/16"

Order No. 13 - 7981

Trans axle pulley replaces Murray 55101. Fits 30" rear engine rider, 8 hp, models 8-35500 & 7-30502.



ID 5/8" splined
OD 5"
Height 1"

Order No. 13 - 9514

Jackshaft pulley replaces Murray 094592. Fits 46" cut mowers. Models 46560X91A, 46560X192A, 46561X8, 46562X7 & 46562X8. Takes 4 pulleys per unit.



ID 9/16"
OD 5-3/8"
Height 1/2"

Order No. 13 - 10820

Jackshaft pulley replaces Murray 494199. Fits 42" cut, splined shafts.



30

O.E.M.

O.E.M. REPLACEMENT
MURRAY (Cont.)













O.E.M. 30

ORDER NO.	REPLACES O.E.M. NO.	LENGTH	CENTER HOLE DIAM.	OUTSIDE HOLE DIAM.	CENTER TO CENTER	WIDTH	STEEL THICK.	APPLICATION
15 - 844	24458E701	15-1/32" 381.8mm	7/8" x 1"			2-1/4" 57.2mm	.150" 3.8mm	(3) blades for 42" cut
15 - 1122	20928E701	15-3/16" 385.8mm	7/8" x 1"			2-1/4" 57.2mm	.150" 3.8mm	(2) blades for 30" cut
15 - 6161	92352E701	15-11/16" 398.5mm	.850" 21.4mm			2-1/4" 57.2mm	.134" 3.4mm	(3) blades for 46" cut Low Lift
15 - 6408	56631E701	15-11/16" 398.5mm	.850" 21.4mm			2-1/4" 57.2mm	.134" 3.4mm	(3) blades for 46" cut Mulcher
15 - 6113	92117E701	15-3/4" 400.1mm	27/32" 21.4mm			2-1/4" 57.2mm	.134" 3.4mm	(3) blades for 46" deck High Lift
15 - 6491	92117E701	15-3/4" 400mm	27/32" 21.4mm			2-1/2" 63.5mm	.150" 3.8mm	Mulching Blade PATENTED
15 - 9896	92117	15-3/4" 400mm	27/32" 21.4mm			2-1/4" 57.2mm	.187" 4.8mm	(3) blades for 46" cut. High Lift Heavy Duty
15 - 50255	 881076YP	16" 406.4mm	13/32" 10.3mm	13/32" 10.3mm	1-7/8" 25.4mm	2-1/4" 50.8mm	.150" 3.8mm	(Export Only)
15 - 6470	94692E701	17-41/64" 448.07mm	.850" 21.8mm			2-1/4" 57.2mm	.150" 3.8mm	Fits models 48560X9Z, 50563x8, 52370x92 48", 50" & 52" cut.
15 - 6018	54390E701	18-1/8" 460.4mm	7/8" x 1"			2-1/4" 57.2mm	.134" 3.4mm	For 36" cut, takes (2) 15-3429 and (2) 15-6018 Blades cross
15 - 1124	20930E701 54390E701	18-3/16" 462mm	7/8" x 1"			2-1/4" 57.2mm	.150" 3.8mm	(2) blades for 36" cut
15 - 50254	 880638YP	19" 482.6mm	13/32" 10.3mm	13/32" 10.3mm	1-7/8" 25.4mm	2-1/4" 50.8mm	.150" 3.8mm	(Export Only)

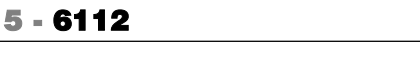
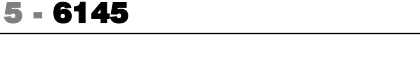

MURRAY (Cont.)

ORDER NO.	REPLACES O.E.M. NO.	LENGTH	CENTER HOLE DIAM.	OUTSIDE HOLE DIAM.	CENTER TO CENTER	WIDTH	STEEL THICK.	APPLICATION
 15 - 6111	92003E701	19-3/8" 492.1mm	.850" 21.4mm			2-1/4" 57.2mm	.150" 3.8mm	Low lift (2) blades for 38" cut
 15 - 6142	71548E701 43865	19-3/8" 492.1mm	13/32" 10.3mm			2-1/4" 57.2mm	.134" 3.4mm	20" mulcher (1991)
 15 - 6119	91742E701	19-1/2" 495.3mm	.850" 21.4mm			2-1/4" 57.2mm	.187" 4.8mm	(Heavy Duty) (2) blades for 38" cut
 15 - 6017	91742E701	19-1/2" 495.3mm	.850" 21.4mm			2-1/4" 57.2mm	.134" 3.4mm	(2) blades for 38" cut
 15 - 6146	56250E701	19-1/2" 495.3mm	.850" 21.4mm			2-3/4" 69.9mm	.134" 3.4mm	(2) blades for 38" cut mulcher
 15 - 11555	95104E701 09510E701	19-1/2" 495.3mm	.850" 21.6mm			2-1/2" 63.5mm	.134" 3.4mm	3 in 1 blade. (2) blades for a 38" cut.
 15 - 2012	20045E701 42785E701	19-15/16" 506.4mm	13/32" 10.3mm	13/32" 10.3mm	2-1/2" 63.5mm	2-1/4" 57.2mm	.150" 3.8mm	
 15 - 10066	672763	20" 508mm	3/8" 9.5mm			2-3/4" 69.9mm	.150" 3.8mm	Fits 20" walkbehind mower. Mulching Blade.
 15 - 6034	91871E701	20-3/8" 517.5mm	.850" 21.4mm			2-1/4" 57.2mm	.134" 3.4mm	Fits models 40603, 40604, 40606, 40620 & 40622 Takes (2) for 40" cut
 15 - 6112	92002E701	20-3/8" 517.5mm	.850" 21.4mm			2-1/4" 57.2mm	.150" 3.8mm	Low lift (2) blades for 40" cut
 15 - 6145	56251E701	20-3/8" 517.5mm	.850" 21.4mm			2-3/4" 69.9mm	.134" 3.4mm	(2) blades for 40" cut mulcher
 15 - 6475	095103E701	20-3/8" 517.5mm	.850" 21.8mm			2-1/4" 57.2mm	.134" 3.4mm	3-n-1 Blade. Takes (2) blades for 40" cut.











30

O.E.M.

O.E.M. REPLACEMENT
MURRAY (Cont.)

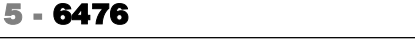











O.E.M. 30

ORDER NO.	REPLACES O.E.M. NO.	LENGTH	CENTER HOLE DIAM.	OUTSIDE HOLE DIAM.	CENTER TO CENTER	WIDTH	STEEL THICK.	APPLICATION
 15 - 6129	91871E701	20-3/8" 517.5mm	27/32" 21.4mm			2-1/4" 57.2mm	.187" 4.8mm	(2) blades for 40" cut (Heavy Duty)
 15 - 11234	91871E701	20-3/8" 517.5mm	27/32" 21.4mm			2-1/4" 57mm	.187" 4.8mm	(2) Blades for 40" cut. Mulching Blade.
 15 - 9228	71584E701	20-3/4" 527mm	13/32" 10.3mm			2-1/4" 57.2mm	.134" 3.4mm	Mulching Blade. For 21" walk-behinds
 15 - 6039	43836E701	20-13/16" 528.6mm	13/32" 10.3mm			2-1/4" 57.2mm	.134" 3.4mm	Fits models 21681X5 & 21681X62 For 21" walkbehind
 15 - 3390	22860E701	20-13/16" 528.6mm	13/32" 10.3mm	13/32" 10.3mm	2-1/2" 63.5mm	2-1/4" 57.2mm	.134" 3.4mm	
 15 - 6160	71161E701	20-7/8" 530.2mm	13/32" 10.3mm			2-3/4" 69.9mm	.150" 3.8mm	Mulcher
 15 - 6476	095100E701A	21-3/16" 538.1mm	.850" 21.8mm			2-1/4" 57.2mm	.134" 3.4mm	3-n-1 Blade Takes (2) blades for 42" cut.
 15 - 6144	56252E701	21-1/4" 539.8mm	.850" 21.4mm			2-3/4" 69.9mm	.134" 3.4mm	(2) blades for 42" cut Mulcher
 15 - 6162	92418E701 95101E701	21-1/4" 539.8mm	.850" 21.4mm			2-1/4" 57.2mm	.150" 3.8mm	(2) blades for 42" cut High Lift
 15 - 6460	92418E701 95101E701	21-1/4" 539.8mm	27/32" 21.4mm			2-1/2" 63.5mm	.150" 3.8mm	Mulching Blade PATENTED
 15 - 9897	92418	21-1/4" 539.8mm	27/32" 21.4mm			2-1/4" 57.2mm	.187" 4.8mm	(2) blades for 42" cut. High Lift (Heavy Duty)
 15 - 6166	95101E701 92419E701	21-1/4" 539.8mm	.850" 21.4mm			2-1/4" 57.2mm	.150" 3.8mm	(2) blades for 42" cut



MURRAY (Cont.)

ORDER NO.	REPLACES O.E.M. NO.	LENGTH	CENTER HOLE DIAM.	OUTSIDE HOLE DIAM.	CENTER TO CENTER	WIDTH	STEEL THICK.	APPLICATION
 15 - 11868	7100851A 1101823	21-5/8" 549.3mm	13/32" 10.3mm	13/32" 10.3mm	1-7/8" 47.6mm	2-1/4" 57.2mm	.135" 3.5mm	3 in 1 blade
 15 - 6471	672059E701	21-7/8" 555.6mm	13/32" 10.3mm			2-1/4" 57.1mm	.134" 3.4mm	Fits 22" walkbehind mowers.
 15 - 2013	42225E701	21-15/16" 557.2mm	13/32" 10.3mm	13/32" 10.3mm	2-1/2" 63.5mm	2-1/4" 57.2mm	.150" 3.8mm	
 15 - 6174	1101120E701 71849E701 71499E701 71113E701	22" 558.8mm	13/32" 10.3mm			2-1/4" 57.2mm	.150" 3.8mm	Mulcher blade for walkbehind
 15 - 2166	54053E701	30" 762mm	7/8" x 1"			2-1/4" 57.2mm	.150" 3.8mm	High Lift
 15 - 3430	55969E701	30" 762mm	.850" 21.4mm			2-3/4" 69.9mm	.160" 4.1mm	
 15 - 6027	56246E701 56212E701	30" 762mm	.850" 21.4mm			2-3/4" 69.9mm	.160" 4.1mm	High Lift
 15 - 6010	56061E701	30" 762mm	7/8" x 1"			2-3/4" 69.9mm	.160" 4.1mm	
 15 - 3443	55793E701	30" 762mm	.850" 21.4mm			2-1/4" 57.2mm	.187" 4.8mm	
 15 - 6215	56217 56210	30" 762mm	.850" 21.4mm			2-3/4" 69.9mm	.150" 3.8mm	Fits 30" rear engine rider models 2466A & 24661A Mulching Blade

30
O.E.M.

O.E.M. REPLACEMENT
MURRAY (Cont.)



30
O.E.M.

Top OD 7/8"
Splined ID .600"
Length 2-5/32"
Diameter 1-15/16"



Order No. 17 - 10957

Blade adaptor replaces Murray 690411. Used on 42", 46" and 52" rail deck frames. Used with our 10-10189 Spindle.



Order No. 17 - 5935

Spline Blade Adaptor. Replaces Murray 56258 , 91926 & 92466. Used in our Murray 38" and 40" mulching kits.

ID 5/8"
OD 1-3/4"
Thickness .117"



Order No. 17 - 14050

Blade belleville washer replaces Murray 17X166MA.

MIN005



Order No. 18 - 6510

Muffler for 11 & 12 hp B&S equipped Murray front engine riders. Replaces Murray 903305E, 91271SE & 91271, model 9-38219.

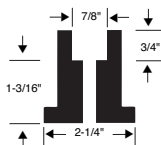

Order No. 17 - 1237

Replaces Murray 42735. For 21" and some 22" walkbehind models 821853, 821861, 821951, 821981 and 822651.

Order No. 17 - 1235

Hub only for our 17-1237.



Order No. 18 - 891

Muffler replaces Murray 90330SE & 90330PA. With bolts and heat shield. 1-7/8" Bolt Center.



Order No. 17 - 1167

Clutch Body for most Murray riders. Replaces Murray 54211. 5/8" center hole.

Overall Length 5-7/8"



Order No. 20 - 6965

Fuel Gauge replaces Murray 24064. Fits Murray 5-1/4" depth fuel tanks, 2-1/4" diameter top.



MURRAY (Cont.)



Order No. 20 - 8934

Fuel cap replaces Murray 92317.



Order No. 26 - 13643

Starter extension cord replaces Murray 6219MA. Included in our 26-10975, 26-10976, 26-10982 starters.



Order No. 28 - 8978

Grass bag replaces Murray 71589. Fits 21" rear bag units. (Black)



Order No. 31 - 2922

Ignition Switch. Replaces Murray 21064 (Magneto).

Order No. 31 - 2932

Ignition Key for 20729 switch.

MIN010

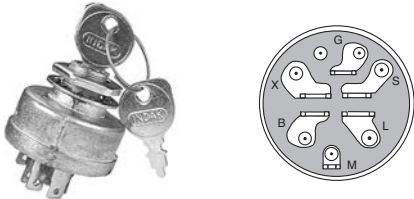

Order No. 31 - 9331

Ignition switch replaces Murray 92377. Fits Murray front engine riders for magneto ignition. 4 position.

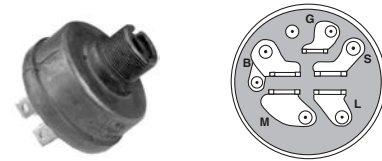

Order No. 31 - 9330

Ignition switch replaces Murray 91846. Also fits Gravely & Noma for magneto ignition. 4 position.



Order No. 31 - 9622

Multi-application ignition switch. Fits single stage Murray. Includes key, lockwasher. 2 terminals/ 2 positions.



Order No. 31 - 9623

Ignition switch replaces Murray 92556. For engines equipped with fuel shut-off solenoid built since 1994. Used on Murray mowers. Includes key, lockwasher nut. 6 post.

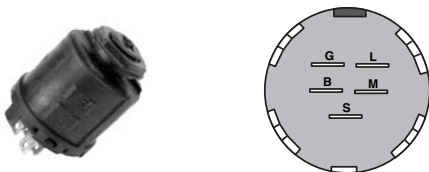

Order No. 31 - 9654

Multi-application ignition switch replaces Murray 327355. Thread mounted with running lights. Uses our 31-9668 nut & our 31-9667 key.

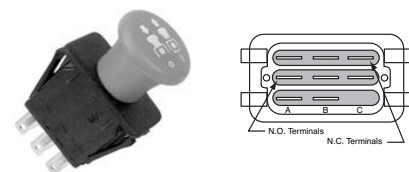

Order No. 31 - 9656

PTO switch replaces Murray 94927 & 6201-316. Push-pull/Snap in mount. Corner terminal blank. Red knob.

Order No. 31 - 9660

Plunger Interlock switch replaces Murray 24273. Single pole, normally open.

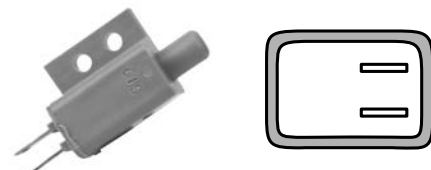

30

O.E.M.



**O.E.M. REPLACEMENT
MURRAY (Cont.)**

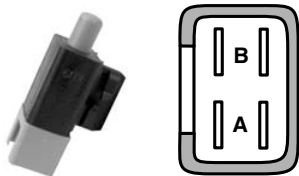

Order No. 31 - 9662

Plunger Interlock switch replaces Murray 94136. Double pole, snap in mount. Normally open/normally closed.



Order No. 31 - 9663

Plunger Interlock switch replaces Murray 57211. Single post, right angle snap in mounted. Normally open.

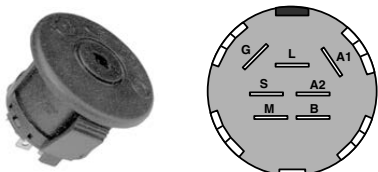

Order No. 31 - 7015

Ignition switch replaces Murray 925-1741, 94762.



Order No. 31 - 12685

Heavy duty ignition switch with keys replaces Murray 94762. Similar to our 31-7015 but heavy duty.



Order No. 31 - 3319

Solenoid replaces Murray 9924285, 24285 & 424285.



Order No. 31 - 10771

Universal starter solenoid 3 pole, 12 volt. Terminal post will accommodate both 5/16" & 1/4" terminal connectors, Mounting bracket will accommodate both chassis and wall mount configurations. Replaces Murray 424285, 924285, 21261, 24285.



Order No. 31 - 10677

Solenoid replaces Murray 21261. Heavy Duty.



Order No. 41 - 8635

Universal snowblower shoe fits Murray.



Order No. 41 - 13042

Snow blower skid replaces Murray 1740718HMA/760061MA, 301380E701, 301380E717MA, 780061MA, 1740718HMA. Fits models 1695557- C950-52846-0, 1695558-C950-52847-0.



Order No. 41 - 5585

Universal snowblower skid shoes set. Fits most Murray. 2 stage snowthrowers. Eccentric washers allow mounting to a variety of mounting dimensions. Mounting width (min 2", max 3", 5/16" bolt holes. Similar to our 41-8635.



Order No. 41 - 5543

Impeller shaft kit replaces Murray/Noma 50660 & MJ577412.



Order No. 41 - 5544

Gearbox Input shaft replaces Murray/Noma MJ1401 & 1401.

30

O.E.M.

IGNITION

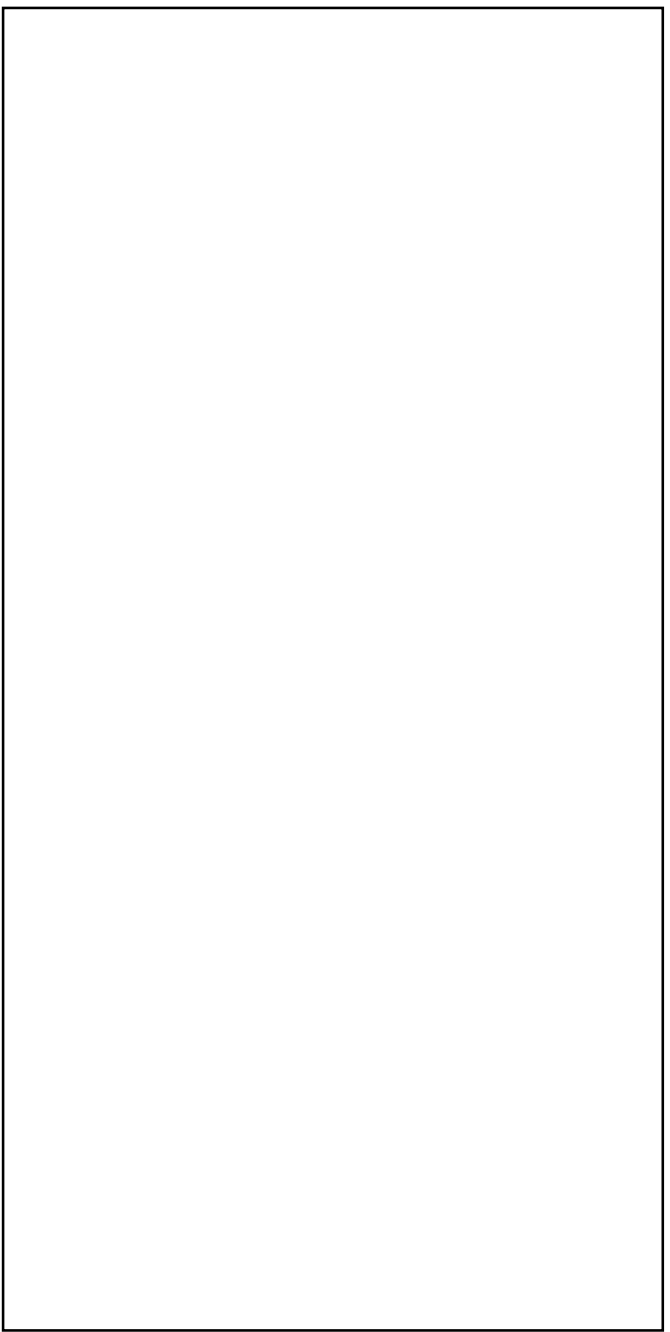

Quick-Glance

IGNITION	PG.
Batteries	1057
Battery Cables	1057-1058
Battery Terminals	1058
Primary Wire	1058
Ignition Switch	1059-1063
PTO Switch	1064-1065
Plunger Switch	1066-1068
Toggle Switch	1070
Solenoid	1071-1072
Fuses	1073-1074
Coils	1075-1078
Regulators	1078-1080
Diode	1080
Batlock	1081



Batteries, Cables & Terminals

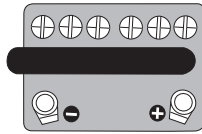

Order No. 31 - 1905

Rider Mower Battery. Right Hand Positive with manifold vent. 7-3/4" length, 5" width, 7-1/4" height, 12 Volt, 9 plates per cell, 220 Cranking Amps. **Acid Not Included.** (U1R-54)

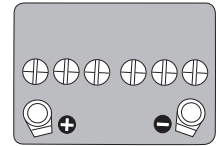

Order No. 31 - 2675

Rider Mower and Tractor Battery. Left Hand Positive. The most popular size for tractors and riding mowers. Fits Dynamark, John Deere, Murray, Snapper. 7-3/4" length, 5" width, 7-1/4" height, 12 Volt, 220 Cranking Amps. **Acid Not Included.** (U1-54)



Order No. 31 - 1906

Rider Mower Battery. Left Hand Positive. Replaces Ariens, Huffy, Carter, Gen. Power. 5-1/4" Length, 3-1/8" Width, 6-1/4" Height. (12N12A-4A-1). 113 Cranking Amps. **Acid Not Included.**

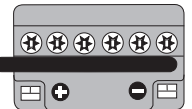

Order No. 31 - 1908

Rider Mower Battery. Right Hand Positive. Replaces Murray and Sears 25526, 27, 23, 3023, 3035. 5-5/16" Length, 3-9/16" Width, 6-9/16" Height. (12N14-3A). 128 Cranking Amps. **Acid Not Included.**

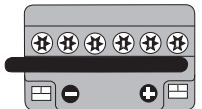

Order No. 31 - 7724

Rider Mower Battery. Right Hand Positive. Replaces MTD 753-0608, 725-1635, 725-1430, 753-0608 and 725-1438. 8" Length, 3-1/2" Width, 6-1/2" Height. Manifold vent. For MTD 12-1/2 & 16 hp. (G50-N18L-A). 275 Cranking Amps. **Acid Not Included.**

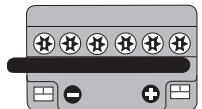

Battery Cables

All copper conductor with poly-vinyl insulation. Brass terminals are crimped and lead dipped for corrosion resistance. (6 gauge.)



Order No	Size/Description	Order No	Size/Description
31 - 1932	8" Red	31 - 1934	16" Red
31 - 11932	8" Red (cd) MIN005	31 - 11934	16" Red (cd) MIN005
31 - 1940	8" Black	31 - 1942	16" Black
31 - 11940	8" Black (cd) MIN005	31 - 11942	16" Black (cd) MIN005
31 - 1933	12" Red	31 - 1935	20" Red
31 - 11933	12" Red (cd) MIN005	31 - 11935	20" Red (cd) MIN005
31 - 1941	12" Black	31 - 1943	20" Black
31 - 11941	12" Black (cd) MIN005	31 - 11943	20" Black (cd) MIN005

Order No	Size/Description	Order No	Size/Description
31 - 1934	16" Red	31 - 1935	20" Red
31 - 11934	16" Red (cd) MIN005	31 - 11935	20" Red (cd) MIN005
31 - 1942	16" Black	31 - 1943	20" Black
31 - 11942	16" Black (cd) MIN005	31 - 11943	20" Black (cd) MIN005



IGNITION

**Battery Cable
(10 ft. Rolls)**



Order No. 31 - 1936

(Red cover) 6 gauge.

Order No. 31 - 1944

(Black cover) 6 gauge.

All copper conductor with poly-vinyl insulation.

**Battery Cable
(50 ft. Rolls)**



Order No. 31 - 8597

Red cover 50 ft. roll battery cable. 6 gauge.

Order No. 31 - 8598

Black cover 50 ft. roll battery cable. 6 gauge,

**Cable Terminals
(Packaged in lots of 10)**



Order No. 31 - 1937

3/8" battery cable terminal.

MIN010

Order No. 31 - 1938

1/4" battery cable terminal.

MIN010

Brass terminals are lead dipped for corrosion resistance.

**Copper Battery Cable Terminals
1/4" & 3/8"**



Order No. 31 - 8599

6 gauge, 3/8" battery cable terminals.

MIN010

Order No. 31 - 8600

6 gauge, 1/4" battery cable terminals.

MIN010

Battery Hold Down Bolt



Order No. 31 - 9249

Battery hold down bolt includes washer and wing nut. Length 8", threaded 4-1/2". Used with our 31-9248. Sold in sets.

**Universal Adjustable
Battery Hold Down**



Order No. 31 - 9248

Universal adjustable battery hold down. Used with our 31-9249. Sold in sets.

Universal Battery Terminal

Order No. 31 - 8596

Universal battery terminal. Fits 2-6 gauge cable. Universal style lead terminal will fit all top post batteries.

MIN010



16 AWG Primary Wire

(for L/M, Auto & Marine)

25' & 100' Rolls



Order No.

Description

- 31 - 6711** 25' roll. (red)
- 31 - 6712** 25' roll. (black)
- 31 - 6713** 25' roll. (white)
- 31 - 6714** 25' roll. (blue)
- 31 - 6715** 25' roll. (yellow)

Order No.

Description

- 31 - 6815** 100' roll. (red)
- 31 - 6816** 100' roll. (black)
- 31 - 6817** 100' roll. (white)
- 31 - 6818** 100' roll. (blue)
- 31 - 6819** 100' roll. (yellow)

31

IGNITION



Universal Wire Harness



Order No. 31 - 6662

Universal Wire Harness. Used with our 31-2922 switch. Fits Murray, MTD, Gravely, Toro. The 5 wire leads are 18" long and have a protective flexible cover.

Wire Connectors



Order No. 31 - 6716

For 22 thru 14 AWG wire. (gray)

MIN100

Order No. 31 - 6717

For 22 thru 14 AWG wire. (blue)

MIN100

Safety Switch for SCAG

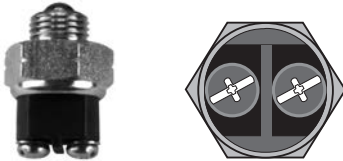

Order No. 31 - 8911

Safety switch replaces Scag 48021. Fits walkbehind mowers for "G" series PTO & "G" series PRO. 2 terminal, 9/16" mounting stem, normally open contact. Also replaces Ariens 29131, Encore 363027 & Gravely 20916.

Safety Switch for GRAVELY

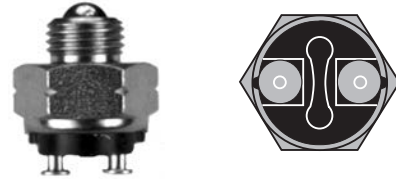

Order No. 31 - 8910

Safety switch replaces Gravely 34640. Also fits Simplicity 1654634 and Toro 28-4250. 9/16" mounting stem, normally closed, neutral safety.

Ignition Switch for AYP

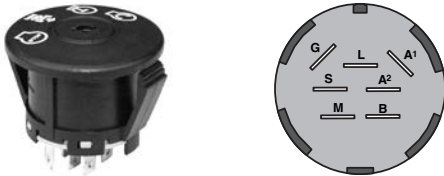

Order No. 31 - 12327

Ignition switch replaces AYP 193350. Used on 2006 - up riders.

Ignition Switch Kit for AYP



Order No. 31 - 9158

Ignition switch kit replaces AYP 158913, Exmark 543070 and Noma 305720, Hustler 045898. Fits Exmark Laser ZTR & John Deere STX 38446 models.

Ignition Switch for CUB CADET



Order No. 31 - 12752

Ignition switch replaces Cub Cadet 725-3163 / 925-3163. Also replaces Troy Bilt & Bolens 1754183 & 1754183099.

Ignition Switch for EXMARK



Order No. 31 - 11822

Ignition switch replaces Exmark 103-0206, 109-4736. Also replaces Toro 104-2541 & 88-9830. Fits Lazer Z 60" & 72" Lazer Z XP. 3 position, 6 terminals.



IGNITION

Ignition Switch for JOHN DEERE

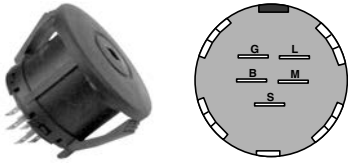

Order No. 31 - 9655

Ignition switch replaces John Deere AM122881. Snap in mounted, 3 position switch. Uses our 31-9667 key.

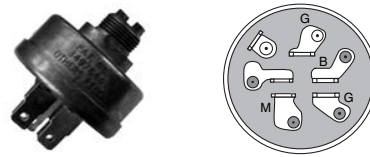

Order No. 31 - 9166

Ignition switch replaces John Deere AM38227. For John Deere front mount mowers. Fits series 300 and some 200's. Also fits Ariens 03602300. (Magneto)

Ignition Switch for JOHN DEERE

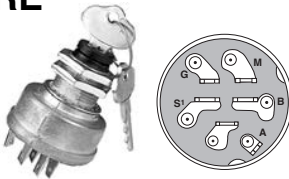

Order No. 31 - 10723

Ignition switch replaces John Deere AM101561 & Great Dane TCA15075. Fits models RX63, RX95, RX85, & SRX 75 & SRX 95, F series and Gator. For magneto ignition, 6 terminal, 3 position. 20 mm x 1.25" mounting stem. Uses our 31-12128 keys.

Ignition Switch for MTD



Order No. 31 - 9853

Ignition switch replaces MTD 725-1396, 925-1396, Simplicity 1679006 & 1686734. Fits lawn and garden tractors with B&S OHV Vanguard engines.

31
IGNITION

Ignition Switch for MURRAY

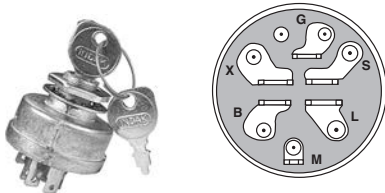

Order No. 31 - 9331

Ignition switch replaces B&S 5411H Murray 92377. Fits Murray front engine riders for magneto ignition. 4 position. Comes with key and hardware.

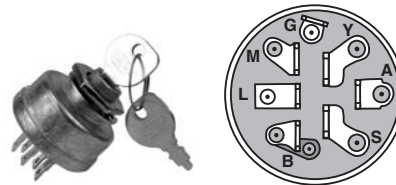

Order No. 31 - 9623

Ignition switch replaces Murray 92556, MTD 725-1717 and AYP 140301. For engines equipped with fuel shut-off solenoid built since 1994. Used on Murray mowers. Includes key, lock-washer nut & cover, 6 post.

Ignition Switch for MURRAY

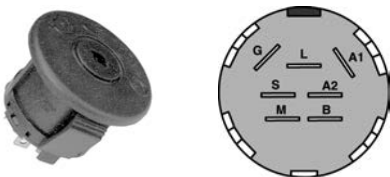

Order No. 31 - 7015

Ignition switch replace Murray 94762 & 925-1741. Also fits AYP 175566 163968, John Deere GY20074, MTD 925-1741. Fits on MTD Revtek mowers in reverse. 7 terminal, 4 position switch.

Heavy Duty Ignition Switch



Order No. 31 - 12685

Heavy duty ignition switch with keys replaces AYP 175566 & 163968, John Deere GY20074, MTD 925-1741, Murray 94762. Similar to our 31-7015 but heavy duty.



Ignition Switch for MURRAY

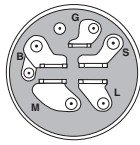

Order No. 31 - 9330

Ignition switch replaces Murray 91846. Also fits Gravely & Noma for magneto ignition. 4 position.

Ignition Switches

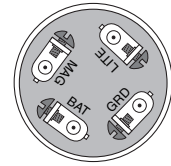
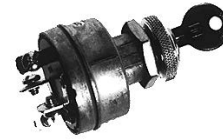

Order No. 31 - 1928

Ignition Switch 4 pole. Two position, no spring back.

Ignition Switches

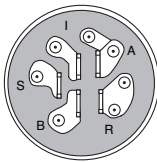

Order No. 31 - 1931

12V Battery Switch - Plug in replaces Wheel Horse 103990. Also replaces Gravely 19223. Fits Gravely Pro Master 20-H.

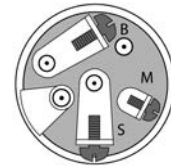

Order No. 31 - 6545

Replaces Snapper 7011155. For Snapper rear engine riders.



Order No. 31 - 7179

Ignition switch replaces Snapper 7018816.

Solenoid for SCAG



Order No. 31 - 14427

Solenoid replaces Scag 483278.

Ignition Switch for SNAPPER



Order No. 31 - 12839

Ignition switch replaces Snapper 7072684YP, Scag 483472, Ariens 03277000, Bush Hog 50047912. Plastic snap bezel. 3 position 5 terminals.

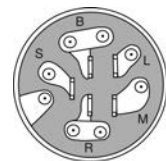

Order No. 31 - 2941

Replaces Roper/Sears 14615, 73232. (Magneto)

IGNITION



Ignition Switch for SNAPPER



Order No. 31 - 12839

Ignition switch replaces Snapper 7072684YP, Scag 483472, Ariens 03277000, Bush Hog 50047912. Plastic snap bezel. 3 position 5 terminals.

Ignition Switch for SIMPLICITY



Order No. 31 - 14672

Ignition switch replaces Simplicity 7017817YP, 1664804SM Scag 48609, Snapper 7017817, Troy Bilt GW1758145, MTD & Troy Bilt: 925-0873, Exmark 1-403121. 2 position, 2 terminals, 5/8" mounting stem. On/Off switch, includes hardware.

Ignition Switch for TORO



Order No. 31 - 14652

Ignition switch replaces Toro 117-2221. Fits most Z Master 2010 and newer, TimeCutter ZS-SS, Titan zero turn mowers. Also fits Exmark Lazer Z S/N 920,000 & up; Lazer Z S/N 850,000 and up, Quest models. Plastic snap in bezel. 3 position, 6 terminals. Keys not included.

Ignition Switch for TORO



Order No. 31 - 14454

Ignition switch replaces Toro 116-0050. Fits Z500 Z Master. Plastic snap in bezel. 3 position, 5 terminals. Keys not included. Uses our 31-2932 or 31-10794 keys.

Terminal Connector Switch



Order No. 31 - 12780

Delta 7 terminal connector fits our 31-7015, 31-10710, 31-12327, 31-12685 Ignition switches.



Order No. 31 - 2942

Replaces Roper/Sears 365401R. Also replaces switch 74R, 2210R, 5797H, 7486H, 9541H, 21037, 71577, 72841 and 511404.

Neutral Start Switch for CASTLEGARDEN



Order No. 31 - 13349

Neutral start switch replaces Castlegarden 19410611/0, 19410608/1, FC72/TC92, Tecumseh peerless / Husqvarna 786201. Transmission neutral start switch.

Ignition Switch for STIGA



Order No. 31 - 10710

Ignition switch replaces Stiga 1134-4093-01. Fits models Stiga Park 2000-and Stiga Villa 2001- **Export Only.**



Order No. 31 - 2922

Ignition Switch replaces AYP STD365402, Scag 48017, MTD 725-0267A & 925-0267, Murray 21064, Toro 23-0660, Snapper 7027698. (Magneto)



Order No. 31 - 7280

Ignition switch replaces Toro/Wheel Horse 103991. Also replaces Kohler 25-099-04.

31

IGNITION



Ignition Switches (Cont.)



Order No. 31 - 8601

Key switch replaces Gravely 19223. Fits Gravely Promaster 20H. For battery ignition, 9/16" mounting stems. Also fits John Deere AM103286 & AM32318.



Order No. 31 - 1939

Starter Switch replaces Snapper 12623.

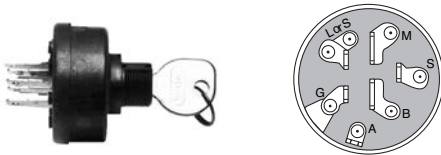

Order No. 31 - 7804

Ignition switch replaces B&S 493625 & 692318, Toro 83-0020, Scag 48798. Fits 14 hp twin cylinder models 400700 vert., 400400 horz., and 18 hp models 422400 horz., 422700 vert.

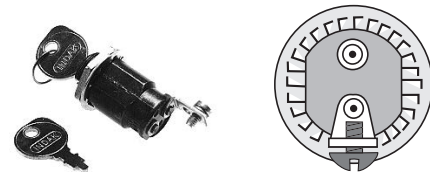

Order No. 31 - 1930

On-Off Switch for Manual Start Riders. Single Pole. Replaces Snapper 7011853.

Ignition Switch for TORO

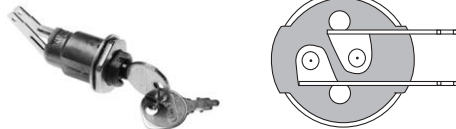

Order No. 31 - 7976

Switch replaces Toro 29-5560 model 5200 & 5620 Snowblowers. Fits 32", 36", 37", 44", 52", mid size commercial mowers with pull start. Also fits Scag, Bobcat, Bunton & Exmark. Includes mounting hardware.



Order No. 31 - 11018

Ignition switch replaces Toro 27-2360. Fits Toro Goundmaster models: 3, 52, 62, 72, 322, 325, 327, 400, 500, RM223D, 450D, 335D, 5100D. Ignition type: Battery, 3 positions, 6 terminals. 9/16" mounting stem.

Ignition Switch for Multi-Applications



Order No. 31 - 9622

Multi-application, momentary switch, 2 positions springback, ignition switch fits single stage Simplicity & Snapper snowthrowers. Includes key, lockwasher. Momentary switch terminals/2 positions.



Order No. 31 - 9654

Multi-application ignition switch replaces AYP 144921, 163088 & 178744, Murray 327355, Simplicity 1718306 & 1713845, 1686734. Thread mounted. Uses our 31-9668 nut. Uses our 31-9667 key.

Plastic Nut for Switches



Order No. 31 - 9668

Plastic nut for our 31-9654 switch.

MIN010

31

IGNITION



IGNITION

Plastic Nut for INDAK Switches



Order No. 31 - 10792

Plastic nut for Indak switches. Makes the switch waterproof. Used with our 31-10791 rubber bezel. MIN010

Rubber Bezel for INDAK Switches



Order No. 31 - 10791

Rubber bezel for Indak switches. Makes the switch waterproof. Used with our 31-10792 plastic nut. MIN010

Relay for AYP & GRASSHOPPER

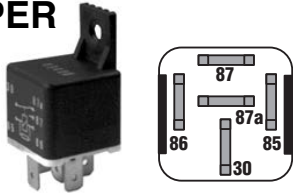

Order No. 31 - 9369

Relay replaces AYP 109748X & Grasshopper 104-026-401 & Walker 6942. Fits several AYP riders. Fit Grasshopper model 325 and Exmark 1-643275. Open to run.

Relay for MTD

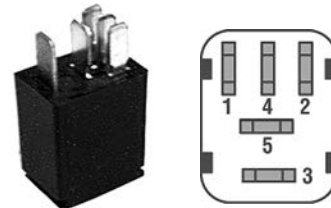

Order No. 31 - 10895

Relay replaces MTD 925-1648. 12 volt, 20 AMP. Fits auto drive riding mowers and snowthrowers.

PTO Switch for ARIENS

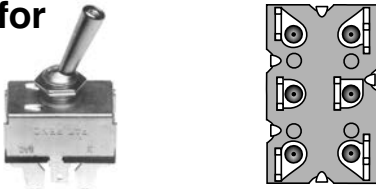

Order No. 31 - 7922

PTO switch replaces Ariens 36024, Grasshopper 604796, 184082, Snapper 7029175, Woods 70422, Scag 48787. Fits 936 series YT tractor models 936002, 936003, 936004, 936005, 936006, 936008, 936009, 936010, 936011 & 936012. Includes mounting hardware.



Order No. 31 - 7675

Replaces Toro 92-6328, 37-2610 & 92-6328, Bobcat 128009, Gravelly 45848, JD AM39489, Power King 03-7301, Snapper 19545, and Walker 6950. Mounting hardware included.

PTO Switches for Multi-Applications

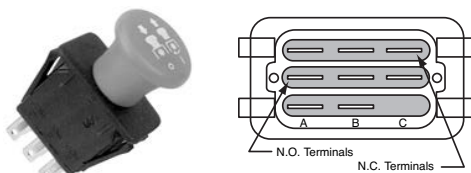

Order No. 31 - 9656

PTO switch replaces AYP 146283, 140404, 154959, 154963, 169416, 169417, 174651, 174652, 174653, Bunton PL7994, Dixon 5961, 539117238, Encore 523030, Hustler 771476, Murray 94927 & 6201-316, Scag 700675 & 27328, Snapper 7035658, & Yazoo 101768. Push-pull/snap mount. Corner terminal blank. Red knob.

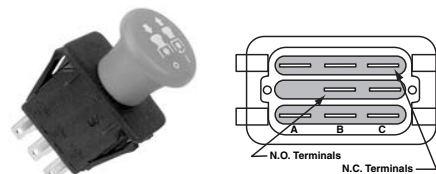

Order No. 31 - 9657

PTO switch replaces Ariens 5221, John Deere AM118802, AM119139, Exmark 1-633673, Kubota K1211-62231, MTD 725-1716, & 925-1716, Scag 700675, Toro 93-9999, 93-9998, 95-4108, 95-7489. Middle terminal blank. Push-pull/snap mount. Red Knob

PTO Switch Retaining Ring for AYP

Order No. 31 - 9777

PTO switch retaining ring replaces AYP 140405. Used with our 31-9656 and 31-9657 MIN005



31

IGNITION



PTO Switch for SCAG

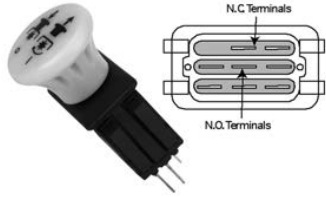

Order No. 31 - 13248

PTO switch replaces Scag 483957. 10 amp PTO switch.

PTO Switch for Multi Applications

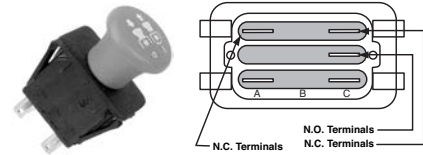

Order No. 31 - 11470

PTO switch replaces Exmark older with 5 terminals. Fits Lazer Z, Turf Tracer, & Turf Ranger Models. Also replaces Ariens 1545600 & Toro 95-7489. Red Knob

PTO Toggle Switch for CUB CADET

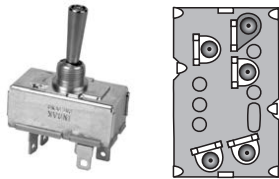

Order No. 31 - 12757

PTO toggle switch replaces Cub Cadet 725-0893 / 925-0893. Fits most box-frame electric clutch applications.

PTO Switch for CUB CADET



Order No. 31 - 12762

PTO switch replaces Cub Cadet 725-3233 / 925-3233. Fits models Z42-Z54, 364365, 1515-1529, 2130-2186 & GT2000. Yellow knob.

PTO Switch for CUB CADET / MTD



Order No. 31 - 14323

PTO switch replaces Cub Cadet / MTD 925-04175, 725-04175. Fits Cub Cadet models GT1554, GT2542, GT2544, GT2550, GT2554, SLT1550, SLT1554 and Z-force. 7 terminals.

PTO Switch for EXMARK

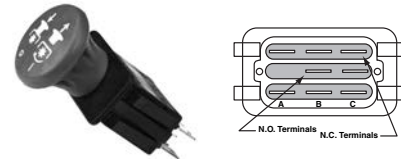

Order No. 31 - 12624

PTO switch replaces Exmark 116-0124. Electrical rating 10A@12-14VDC. Number life at rated load: 100,000 cycles resistive. (High Current) Red knob.

PTO Switch for CUB CADET / MTD



Order No. 31 - 13106

PTO switch replaces Cub Cadet / MTD 725-04258, 925-04258. Fits models GT1054, GT1554, GT33100, GT3200, GTX1054, L1042, L1046, L1050, LT1040, LT1042, LT1045, LT1046, LT1050, LTX1042, LTX1045, LTX1046, LTX1050, SLTX1050, SLTX1054, Craftsman 247.28672, 247.288800, 247.288881, 247.289800, 247.289810, 247.289840, 247.289841.

PTO Switch for JOHN DEERE



Order No. 31 - 14248

PTO switch replaces John Deere GY20939. Fits models D60, D170, LA130-LA175, X130R-X165. 8 terminals.



IGNITION

Plunger Interlock Switches for Multi-Applications

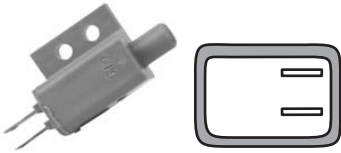

Order No. 31 - 9658

Plunger interlock switch replaces Ariens 30957, AYP 109869X, Exmark 1-513152, John Deere AM108483, Snapper 7027225. Single pole, snap in mounting. Normally closed.

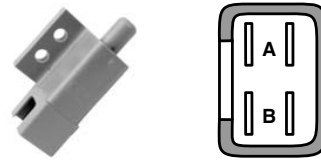

Order No. 31 - 9659

Plunger interlock switch replaces Ariens 088281, AYP 109553X, Bobcat 108208, Dixon 4242, 539115802, Exmark 1-633111, Grasshopper 183894, John Deere AM128925, MTD 725-3169A & 925-3169A, Snapper 7023355. Double pole, snap in mounting. Normally open/normally closed.

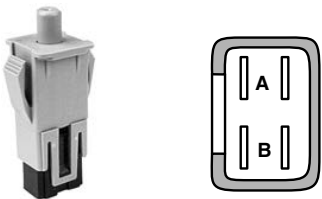

Order No. 31 - 9665

Plunger interlock switch replaces AYP 153664, 161343, 176138, MTD 725-3164A & 925-3164A, Snapper 7022886. Double pole, snap in mount. Normally open/normally closed.

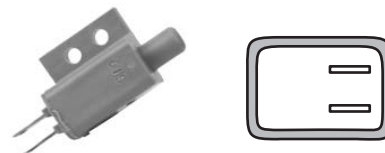

Order No. 31 - 9660

Plunger interlock switch replaces Ariens 36571, Hustler 781211, John Deere AM104884, Murray 24273, Scag 481637, Snapper 7014847, Troy Built 1748723. Single pole, snap in mount. Normally open.

31

Plunger Interlock Switch for Multi-Applications



Order No. 31 - 9664

Plunger interlock switch replaces AYP 121305X, Exmark 1-740275, John Deere AM104403, MTD 725-3166 & 925-3166, Scag 48717. Right angle snap mounted. Normally closed.

Plunger Interlock Switch for Multi-Applications



Order No. 31 - 9663

Plunger interlock switch replaces Ariens 27541, Great Dane D38001, John Deere AM103119, MTD 725-3167, Murray 57211, Scag 481638, Snapper 7015707, Toro 82-2190. Single post, right angle snap mounted. Normally open.

IGNITION

Twist Lock Seat Switch for Multi-Applications

Order No. 31 - 9666

Twist lock seat switch replaces Bolens 1768882, John Deere AM119943, Snapper 292112. Twist lock mount. Normally closed.





**Seat Switch for
AYP**



Order No. 31 - 12091

Seat switch replaces AYP 401545. Used on 2006-up riders.

**Seat Switch for
CUB CADET / MTD**



Order No. 31 - 14331

Seat switch replaces Cub Cadet / MTD 925-05013, 725-05013.

**Seat Switch for
HUSTLER**



Order No. 31 - 14291

Seat switch replaces Hustler 782177 & Grasshopper 183870, Ariens 03490500/3490500, Toro 92-6282. Fits models (Grasshopper) 120, 220, 225, 321D; 600, 700 and 900 series. Hustler models Z, Mini Z, Super Mini Z and Super ZU. Normally Open.

**Seat Switch for
JOHN DEERE**



Order No. 31 - 14268

Seat switch replaces John Deere AM130453. Fits models 115, 145, 155c, 190c, La110, La140, La150, X120, X140, La135, La165, La175, D160 100 series, D170 100 series, X165 100 series. Twist lock mount. For seats with 2-3/4" hole. Positions (2), 4 terminals, (N.C./N.C.)

**Safety Switch for
JOHN DEERE**



Order No. 31 - 14246

Plunger safety switch replaces John Deere GY20073, MTD/Cub Cadet 925-04040, 725-04040. Low profile double pole plunger switch N.C./N.C. 4 terminal. Fits John Deere models 102, 105, 108, 115, 125, 135, 14.542GS, 145, 155C, 1642HS, 17.542HS, 1742HS, 190C, G100, G110, L100, L105, L107, L108, L110, L111, L118, L120, L130, L1742, L2048, L2548, LA100, LA105, LA110, LA115, LA120, LA125, LA130, LA135, LA140, LA145, LA150, LA155, LT150, LT160.

IGNITION



Safety Switch for MTD



Order No. 31 - 14247

Plunger safety switch replaces MTD 725-04165, 925-04165. Also replaces John Deere AM131549, Cub Cadet 01008386, 01008386P. Fits Cub Cadet LT1000, SLT1500, GT1500, ZTR and Z-Force. Also fits John Deere LT150, LT160, LT170, LT180, LT190 and LTR180. Low profile double pole plunger switch. 4 terminal switch in NC/NO.

Plunger Interlock Switch for MTD

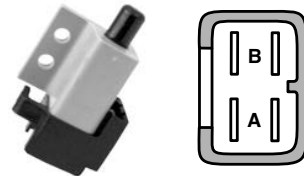

Order No. 31 - 9661

Plunger interlock switch replaces MTD 925-1657A. Double pole, snap in mount. Normally open/normally closed.

Plunger Interlock Switch for MURRAY

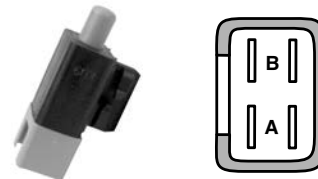

Order No. 31 - 9662

Plunger interlock switch replaces Murray 94136. Double pole, snap in mount. Normally open/normally closed.

31

IGNITION

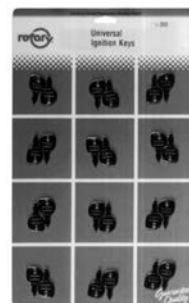

Order No. 31 - 2938

Ignition Keys (carded). Fits our switch 31-1928, 31-1930, 31-1931, 31-2922, 31-2941, 31-2942, 31-6545, 31-7179, 31-7280, and 31-7804. (24 per card)



Ignition Keys



Order No. 31 - 2932

Key Only. Fits our 31-1928, 31-1930, 31-1931, 31-2922, 31-2941, 31-2942, 31-6545, 31-7179, 31-7280, and 31-7804.
MIN010

Ignition Key Bulk



Order No. 31 - 11218

Ignition key replaces John Deere AM123426 & GY20680. Stamped, stainless steel. Fits Delta switches.
MIN010

Switch Keys for Multi-Applications



Order No. 31 - 9667

Switch keys for our 31-9658, 31-9659, 31-9660, 31-9661, 31-9662, 31-9663, 31-9664, 31-9665, 31-9666, 31-9655, 31-9654, 31-7015 plunger switches.



Order No. 31 - 10793

Molded ignition key replaces MTD 725-1341B. Has ergonomic slip resistant comfort grip.



Order No. 31 - 6888

Ignition key replaces MTD 725-0128. Fits most MTD riders.
MIN010

Ignition Key



Order No. 31 - 10794

Ignition key. Molded key and standard key on ring. Fits Indak switches. Same as our 31-2932 bulk key in a set.

Starter Key for MTD



Order No. 31 - 13278

Starter key replaces MTD 725-1660 / TC35062, Tecumseh 35062, Ariens 7500108/7532000. Fits MTD models 314-180-000, 314-180-088, TMO-3525203, 314-180-131 & 314-181-000. Pull / Push Key.
MIN010

Ignition Key for JOHN DEERE



Order No. 31 - 12128

Ignition key replaces John Deere AM131841 / AM101600. Fits our 31-10723 switch.
MIN010

Ignition Key Plastic Covered



Order No. 31 - 11219

Ignition key John Deere AM123426 & GY20680. Plastic covered. Fits Delta switches.
MIN010

31

IGNITION

IGNITION



Headlight Switch for AYP



Order No. 31 - 9733

Headlight switch replaces AYP 110712X.

Stop Switch for B&S



Order No. 31 - 9742

Stop switch replaces B&S 495098S. Fits 4, 5.5 & 9 hp van-guard & 5 hp industrial plus.



Order No. 31 - 7302

Stop Switch used on Tanaka, Kaaz.



Order No. 39 - 7777

Stop switch replaces Stihl 1121-430-0200. Fits models 024, 026.

Kill Switch



Order No. 31 - 2946

Kill Switch with a 48" lead wire. Used on go-carts, ATV's, etc.

Chainsaw Ignition Switch



Order No. 31 - 4720

Comes with "On-Off" Plate and Nut.

Toggle Switch with Wire Leads



Order No. 31 - 7020

Toggle switch with 2, 6" wire leads. Used on Go-Karts. Universal application. 15/32" mount.



Order No. 31 - 7728

Deluxe toggle type kill switch with a 48" lead wire. Used on go-karts and ATV's. Fits 3/4" & 7/8" Frames.



Order No. 31 - 8944

Deluxe toggle type kill switch with a 48" lead wire. Used on go-karts & ATV's. Fits 1" frame.

31

IGNITION



Stop Engine Switch for HONDA

Order No. 31 - 10859

Stop engine switch replaces Honda 36100-ZE1-015. Fits models GX110, GX120, GX140, GX160, GX240, GX270, GX340, GX390.



Universal Solenoid

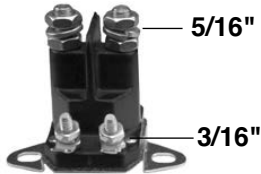

Order No. 31 - 8943

Universal Solenoid. Replaces Toro 28-4210, Ariens 35510, AYP 146154, Bolens 1752137 & 1753539, Case C-26525 & C-33025, Exmark 1-513075, Grasshopper 184251, Gravely 45071, Simplicity 1700751, 1671993 & 1685290, Wheel Horse 110116, 110162 & 110167.



Order No. 31 - 10771

Universal starter solenoid 3 pole, 12 volt. Terminal post will accommodate both 5/16" & 1/4" terminal connectors, Mounting bracket will accommodate both chassis and wall mount configurations. Replaces AMF 53716, Ariens 3057700, Bolens 1751569, Murray 424285, 924285, 21261, 24285, MTD 725-0771, 725-1426, 725-0530, 925-1426, 925-0771, Noma 52323, Snapper 7018817, Toro 111674.

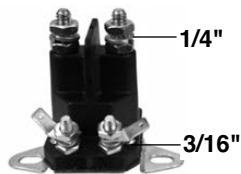

Order No. 31 - 5933

Universal Solenoid. Replaces Toro 47-1910, Ariens 35510, AYP 192507, Bolens 1752137 and 1753539, Gilson 212655, Gravely 45071, Grasshopper 184251, Lawn-Boy 740207, Snapper 7018604, Simplicity 1685290, 1700751, Wheel Horse 110116, AYP 146154.



Order No. 31 - 10772

Universal starter solenoid 4 pole, 12 volt. Terminal post will accommodate both 5/16" & 1/4" terminal connectors, Mounting bracket will accommodate both chassis and wall mount configurations. Replaces Ariens 35510, AYP 109081X, 109946, 146154, Bolens 1752137, 1753539, Case C-266525, C33025, Exmark 1-513075, Gilson 212655, Grasshopper 184251, Gravely 45071, Lawnboy 740207, MTD 725-04437, Simplicity 170051, 16771993, 16852980, 1700751, Snapper 7018604, Toro 47-1910, 110116, 1101162, 110167.

Starter Solenoid Relay for CUB CADET



Order No. 31 - 12792

Starter solenoid relay replaces Cub Cadet 725-3001 / 925-3001. 12 volt, 3-terminal, (2) 5/16 - 18 terminals (1) 10-32 terminal.



Order No. 31 - 3319

Replaces AMF/Dynamark 53716, MTD 725-0771, 725-0530 & 925-0771. Ariens 3057700, Bolens 1751569, Murray 9924285, 24285, 424285, 7701100MA, Snapper 1-8817, Stiga 1134-946-01 and Wheel Horse 111674.

IGNITION



Solenoids

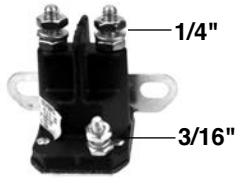

Order No. 31 - 7934

Solenoid replaces MTD 725-0771. Fits MTD front and rear engine rider models 1990 - 1994.

Solenoid for JOHN DEERE



Order No. 31 - 10677

Solenoid replaces John Deere AM132990, AM133094, AM130365, MTD 725-0771, Murray 21261. Heavy Duty.

Solenoid for CASTLEGARDEN



Order No. 31 - 50237

Solenoid replaces Castlegarden 18736100/0 & 18736100/0.

Solenoid Starter for HUSQVARNA



Order No. 31 - 14222

Solenoid starter replaces Husqvarna/AYP 192507. No hardware, 1/4" terminal studs.

Solenoid Starter for MTD

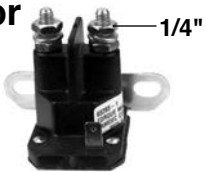

Order No. 31 - 7935

Solenoid replaces MTD 725-1426 & 925-1426, Snapper 18817 & 75671. Fits MTD front and rear engine rider models 1990 - 1994.



Order No. 31 - 14220

Solenoid starter replaces MTD 725-04439, John Deere AM138068. No hardware, 1/4" terminal studs.

Solenoid for RANSOMES/BOBCAT

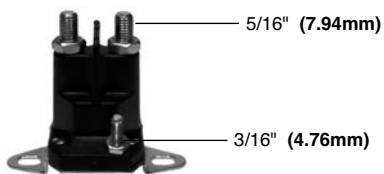

Order No. 31 - 50238

Solenoid replaces Ransomes/Bobcat 1530.

Solenoid for SCAG



Order No. 31 - 14427

Solenoid replaces Scag 483278.

Solenoid for STIGA

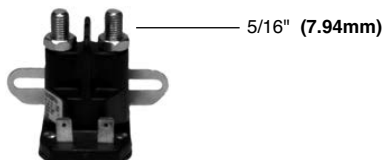

Order No. 31 - 50239

Solenoid replaces Stiga 1134-2946-02.

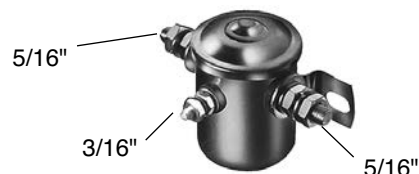

Order No. 31 - 1929

Intermittent duty 3 pole grounded switch, 12 volt.

31

IGNITION



SFE Fuses

Order No.	Description	
31 - 6548	7-1/2 AMP AGC Fuse	MIN005
31 - 1945	7-1/2 AMP SFE Fuse	MIN005
31 - 1946	9 AMP SFE Fuse	MIN005
31 - 1947	14 AMP SFE Fuse	MIN005
31 - 1948	20 AMP SFE Fuse	MIN005
31 - 5898	30 AMP SFE Fuse	MIN005

Goes up to 20 amps at 120 volts.



1/4" diameter
5/8" to 1-7/8" length

AGC Fuses

Order No.	Description	
31 - 6548	7-1/2 AMP AGC Fuse	MIN005
31 - 6549	10 AMP AGC Fuse	MIN005
31 - 6550	15 AMP AGC Fuse	MIN005
31 - 6551	20 AMP AGC Fuse	MIN005
31 - 6552	30 AMP AGC Fuse	MIN005

Goes up to 3 amps at 120 volts.



1/4" x 1-1/4"
non time delay

Fuse Assortment with Tool



Order No. 31 - 1949
Includes (2) each of 7-1/2, 9, 14 and 20 amp SFE Tube Fuses with mini fuse puller.

Fuse Holder



Order No. 31 - 8090
Self stripping fuse holder uses ATC type fuses. Uses our 31-8086, 31-8088, 31-8089 fuses. MIN005

In-Line Fuse Holder



Order No. 31 - 1950
Fuse Holder comes complete with a 10" - 16 gauge lead wire and a 20 amp fuse.

ATC/AGO Inline Fuse Holder



Order No. 31 - 9931
ATC/AGO inline fuse holder fits our 31-8086, 31-8087, 31-8088, 31-8089, 31-8090, 31-8091 & 31-8897 fuses. 4-1/2", 12 ga., orange wire leads. Handles up to 30 Amp fuses. Also included in our 02-9930 kit.

31

IGNITION

IGNITION



ATC Fuses

Order No.	Description	
31 - 8086	ATC 7.5 AMP (Brown)	MIN005
31 - 8087	ATC 10 AMP (Red)	MIN005
31 - 8491	ATC 15 AMP (Blue)	MIN005
31 - 8088	ATC 20 AMP (Yellow)	MIN005
31 - 8897	ATC 25 AMP (Clear)	MIN005
31 - 8089	ATC 30 AMP (Green)	MIN005



nova.™

Electronic Transistorized Ignition Module

Order No. 31 - 8786

Nova II. New improved smaller size. Transistorized ignition.

- ALREADY IN USE BY O.E.M.'S AS STANDARD IGNITION IN THEIR UNITS
- MAINTENANCE FREE
- EASILY INSTALLED
- QUICK AND EASY STARTING (WILL FIRE AT LOW RPM'S)
- OPERATES WELL IN ANY WEATHER CONDITIONS AND COMPLETELY WATERPROOF
- HIGHLY RELIABLE
- DURABLE CONSTRUCTION
- HIGH PERFORMANCE
- ANTI-KICKBACK SYSTEM
- DIE CAST ALUMINUM HOUSING



Widely used in 4 and 2 cycle gasoline engines as in Lawnmowers, Generators, Pumps, Cultivators, Tillers, Compact Garden Tractors, Chain Saws, Brush Cutters, Dusters, Trimmers, Go-Carts, Blowers, etc.

The NOVA™ Module is suitable for 2 leg and 3 leg ignition coils in single cylinder engines. This module is not recommended for use on engines equipped with battery ignition or flywheels with multiple magnets.

31

IGNITION

Fuse Assortment



Order No. 01 - 8900

Assortment contains 90 pieces.

ATC Fuse Assortment



Order No. 01 - 9930

ATC Fuse assortment contains 70 pieces.

Fuse Assortment

Order No. 01 - 10843

ATC Fuse Assortment. This assortment contains 120 pieces of our popular ATC fuse.





**Points for
Briggs & Stratton**



Order No. 31 - 1769

Points replace B&S 65704 breaker point plunger used to actuate the contact sets. Fits 2, 3, 3.5, 4, 5, 7, 8 hp vertical and horizontal engines. MIN010

KOHLER Point Set



Order No. 31 - 4715003S

Kohler 4715003S OEM point set. For K91-361, KT series K532-582.

Ignition Set



Order No. 31 - 1772

Ignition set replaces B&S Points 294628 and Condenser assembly. For models 6B, 8B, 60100 & up 84500 & up, 100000, 130000, 140200, 170000, 171706, 190400, 190700, 191700, 195400 & 19799. Fits 2,3,3-1/2,4,5,7 and 8 HP.

**Ignition Set for
TECUMSEH**



Order No. 31 - 6781

Ignition set replaces Tecumseh points 30547A & condenser 30548B. Fits models LAV, V, VH, VM, TNT, TVS520-600, H, HH40-70, HM70-100, HS 638, 650 & 670.

**Electronic Ignition
Module**

Order No. 31 - 9334

Single terminal electronic ignition module. Fits John Deere M70114, Kawasaki 21119-2095, 21119-2101, 21119-2119, 21119- 2139.



**Coils for
BRIGGS & STRATTON**



Order No. 31 - 1764

Replaces B&S 298316. Fits models 100200, 100900, 130200, 130900, 131200, 131400 and 131900; 5 hp.

Order No. 31 - 1778

Replaces B&S 298968. Models 144000, 145000, 146000, 147000, 193000, 200400, 233400, 234400. Fits 6, most 7, 8 and 9 hp Horizontal and Vertical.

**Ignition Coil for
BRIGGS & STRATTON**



Order No. 31 - 14561

Ignition coil replaces B&S 799651. Fits engine model series M21 / 31 / 33 / 40 / 44.

31

IGNITION

IGNITION



**Coils for
B&S (Cont.)**



Order No. 31 - 7286

Magneto Armature replaces Briggs & Stratton 398811. Fits 7 thru 16 hp vertical and horizontal (single cylinder) engines.



Order No. 31 - 8051

Magneto armature replaces B&S 394891. Fits Horizontal & Vertical Twin (L-Heads) model series 400400 thru 422700.



Order No. 31 - 7287

Magneto Armature replaces Briggs & Stratton 496914, 398593. Fits 2 thru 4 hp vertical and horizontal engines.

**Wire Pack for
Rotary Coils**



Order No. 31 - 9540

Wire pack for our 31-7286, 7287, 7288 coils.



Order No. 31 - 1780

Replaces B&S 298502 and Wico WX15035. Fits models 60000, 61000, 80200, 81000, 82500, 82900, 92500, 92900 and 111000. (2, 3, 3-1/2 and 4 hp horz. & vert.).



Order No. 31 - 8771

Magneto armature replaces B&S 802574. Fits Quantum 127802 series 5 hp engine.



Order No. 31 - 9293

Magneto armature replaces B&S 492341. Fits 10-13 hp & Vanguard 9, 12.5 & 14 hp, Vanguard models 9, 12.5 & 14.5 hp V-twins & 12, 12.2 hp L-head engines.



Order No. 31 - 11578

Ignition coil replaces B&S 691060. Fits model series: 4045A7, 405777, 406777, 407577, 407677, 407777, 40G777, 40H777, 445777, 446777, 543477.



Order No. 31 - 7288

Magneto Armature replaces Briggs & Stratton 397358. Fits 5 hp vertical and horizontal engines.



Order No. 31 - 1779

Replaces B&S 290880 and Wico WX15034. Models 9, 14, 19, 2, 23, 23A, 23B, 23F, 23P and 23R.

31

IGNITION



Ignition Coil for HONDA



Order No. 31 - 12083

Ignition coil replaces Honda 30500-ZF6-W02 / 30500-ZE2-023. Fits models GX240, GX270, GX340 and GX390. Supersedes 30500-ZF6-W01.



Order No. 31 - 10462

Ignition coil replaces Honda 30500-ZE1-033. Fits models GX110, GX120, GX140, GX160.

Ignition Coil for HUSQVARNA



Order No. 31 - 12082

Ignition coil replaces Husqvarna 503-9014-01. Fits models 61/268/45/51/55/240/245/257/250-PS.

Ignition Module for HOMELITE



Order No. 31 - 9720

Ignition module replaces Homelite 94711CS. Fits chain saw XL, XL2, Super 2, VI Super 2, 190, 240, 240SL, Super 240 & 245 models. For backpack blowers, string trimmers, and water bugs.

Coils for KOHLER



Order No. 31 - 1781

Replaces Kohler 47-145-01, 231281, 4151921 & 237256. (12 volt)



Order No. 31 - 1898

Replaces Lawn-Boy 683215 & 100-2948. Used on Lawn-Boy compliance "F" series engines open-to run, 1983 & up.

Solid State Ignition Modules for LAWN-BOY



Order No. 31 - 1897

Replaces Lawn-Boy 682340, 681578 & 100-2949. Used on Lawn-Boy noncompliance "F" series engines with manual start ground-to run, 1978-1982 models. Also used on some small outboard engines.

Ignition Module for POULAN



Order No. 31 - 14460

Ignition module replaces Poulan 530039218. 8 deg.

Ignition Coil for TECUMSEH

Order No. 31 - 14315

Ignition coil replaces Tecumseh 36344A. Fits OHV110 thru OV358EA thru OV490EA. Phelon USA made coil.





IGNITION Coils for TECUMSEH



Order No. 31 - 8692

Ignition module replaces Tecumseh 35135. Fits models TVM, TVXL170-220, OVXL120, HM70-100, OHM-OHSK1120.



Order No. 31 - 1884

Replaces Tec. 30560A, 30546, Phelon FG-6240. Also replaces Clinton 135-13-990.

Order No. 31 - 8693

Ignition module replaces Tecumseh 34443A. Fits models TVS, TNT EVC, H30-70, AH600, HSK600, HXL840, HSK840, 845 & 850.



Ignition Coil for STIHL

Order No. 31 - 14041

Ignition coil replaces Stihl 1122-400-1314. Fits chainsaw models 046, 066, MS460, MS650 and MS660.



Solid State Ignition Module for STIHL



Order No. 31 - 9358

Solid state ignition module with cut-off wire kit replaces Stihl 0000-400-1300. Fits Stihl chainsaw models 024, 026, 028, 034, 036, 044, 046 & 048. Fits Stihl string trimmer models FS360 & FS420.

Ignition Coil for STIHL



Order No. 31 - 12220

Ignition coil replaces Stihl 0000-400-1306. Fits models 025, 09, 010, 011, 012, 020, 020T, 021, 023, & 025. Also will fit newer chainsaws like MS200, MS210, MS230 & M250.

Voltage Regulator for BRIGGS & STRATTON



Order No. 31 - 9204

Voltage regulator replaces Briggs & Stratton 394890, 691185.

Regulator for BRIGGS & STRATTON



Order No. 31 - 10293

Regulator replaces B&S 691188. Fits models 256400, 28B700, 28M700-28Q700, 351400, 351700, & 42A700.

Voltage Regulator

Order No. 31 - 1927

Replaces Briggs & Stratton 295924, Delco 1118988.



31

IGNITION



**Regulator for
BRIGGS & STRATTON**



Order No. 31 - 10294

Regulator replaces B&S 397809. Fits models 422700 series engines. For 8 amp quad circuit charging system.

**Regulator for
BRIGGS & STRATTON**



Order No. 31 - 10296

Regulator replaces B&S 493219. Fits models 303700 series engines.

**Voltage Regulator for
JOHN DEERE**



Order No. 31 - 14029

Voltage regulator replaces John Deere M97348, AM126304, M70121. This is the new style heavy duty regulator. The plug part number AM108848 is included. Fits models 240, 245, 260, 265, 285, 320, 425, 445, 455, 325, 335, 345, 355D, LX172, LX176, LX178, LX186, LX188, LX277, LX279, LX289, X475, X485, X495, X575, X585.

**Voltage Regulator for
GRASSHOPPER**



Order No. 31 - 9210

Voltage regulator replaces Grasshopper 185530. Fits models 1822D, 718D, 721D and 721G. Also fits Kubota 15531-64603.

**Voltage Regulator for
KAWASAKI**



Order No. 31 - 10673

Voltage regulator replaces Kawasaki 21066-2070, 21066-2056. Fits models 425, 445 & F911. Also fits 20 & 22 hp water cooled V-Twin engines & Gator 6 x 4 with 20 amp charging systems. For 13, 15 & 17 amp charging system up to 18 hp engines. Also replaces John Deere M70121. Fits JD models 130, 160, 165, 170, 172, 175, 176, 180, 185, 186, 240, 242, 245, 265, 285, 320, 325, 345, F510, F525, F710 and F725. Fits ATM models 600, 622 & 626. Fits Gator 4x2 & 6x4 models with 15 amp charging systems.



Order No. 31 - 9214

Voltage regulator replaces Kawasaki 21066-2071 & John Deere AM109462. Fits commercial walk behind mowers.

**Regulator for
KOHLER**



Order No. 31 - 9208

Regulator replaces Kohler 41-403-08. Fits K series 8-12 hp single cylinder engines. For 10 AMP charging system. Also fits John Deere AM 102596 and Tecumseh 610749.

**Voltage Regulator for
KOHLER**



Order No. 31 - 8969

Voltage regulator replaces Kohler 25-755-03, 41-403-06 and 41-403-09. Fits 8 - 24 hp engines with 15 amp alternators. Models M8-M20, MV16-MV20, CH5, CH6, CH11-CH15 & CV11-CV15, in line terminals 3 in a row. Also replaces John Deere AM34738 & AM106357.



IGNITION

Rectifier for KOHLER

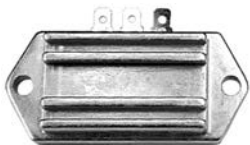

Order No. 31 - 10295

Rectifier replaces Kohler 12-403-01. Fits models CV11, CV12.5, CV13, CV14, CV15 & CV18. Used on commercial walkbehind mowers with Kohler engines with electric clutch, rope starter and no battery.

Regulator for KOHLER



Order No. 31 - 10297

Regulator replaces Kohler 41-403-06. Fits 8-24 hp engines with 15 amp alternators. Fits models K181, K241, K301, K321, K482, K532, K582. "L" pattern with two terminals. Uses systems "S" series K181-K582, 10-16 hp single cylinder. Also fits John Deere.

Regulator/Rectifier for HONDA



Order No. 31 - 9209

Regulator/Rectifier replaces Honda 31600-890-951. For Honda lawn tractors.

Voltage Regulator for ONAN



Order No. 31 - 12802

Voltage regulator replaces Onan 191-1748, 191-2106, 191-2277. For 16 thru 24 HP engines, including P-Series. Also used on John Deere models 318-420 with Onan engines.

31

Diode for B&S



Order No. 31 - 9207

Diode replaces B&S 393814. For 2-4 AMP charging systems. Fits B&S 6 AMP diodes instead of OEM 3 AMP.

Diode for B&S



Order No. 31 - 9205

Diode replaces B&S 392606. For 5 AMP tri-circuit harness alternators. Fits B&S 6 AMP diodes instead of OEM 3 AMP.

IGNITION

Diode for B&S



Order No. 31 - 9206

Diode replaces B&S 393456. For 2-4 AMP dual circuit alternators. Fits B&S 6 AMP diodes instead of OEM 3 AMP.



Battery Terminal for BATLOCK

Order No. 31 - 12115

Batlock conversion kit. The conversion kit quickly converts your current lead yoke connector to a Batlock quick disconnect system. Conversion kit is recommended for use on automobiles, vehicles of all kinds, boats that use Top Post terminal type batteries. 4-6 gauge wire recommended. Used with our 31-8596 universal battery terminal.



Yoke Top Post for BATLOCK

Order No. 31 - 12116

Batlock lead free Yoke Top Post. Batlock quick disconnect system is recommended for use on automobiles (typically, import cars), vehicles of all kinds, boats that use Top Post terminal type batteries. 4-6 gauge wire recommended.

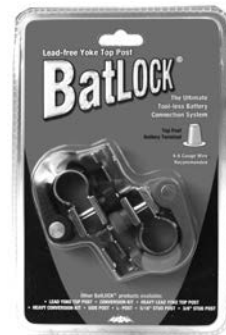

31

IGNITION

TOOLS

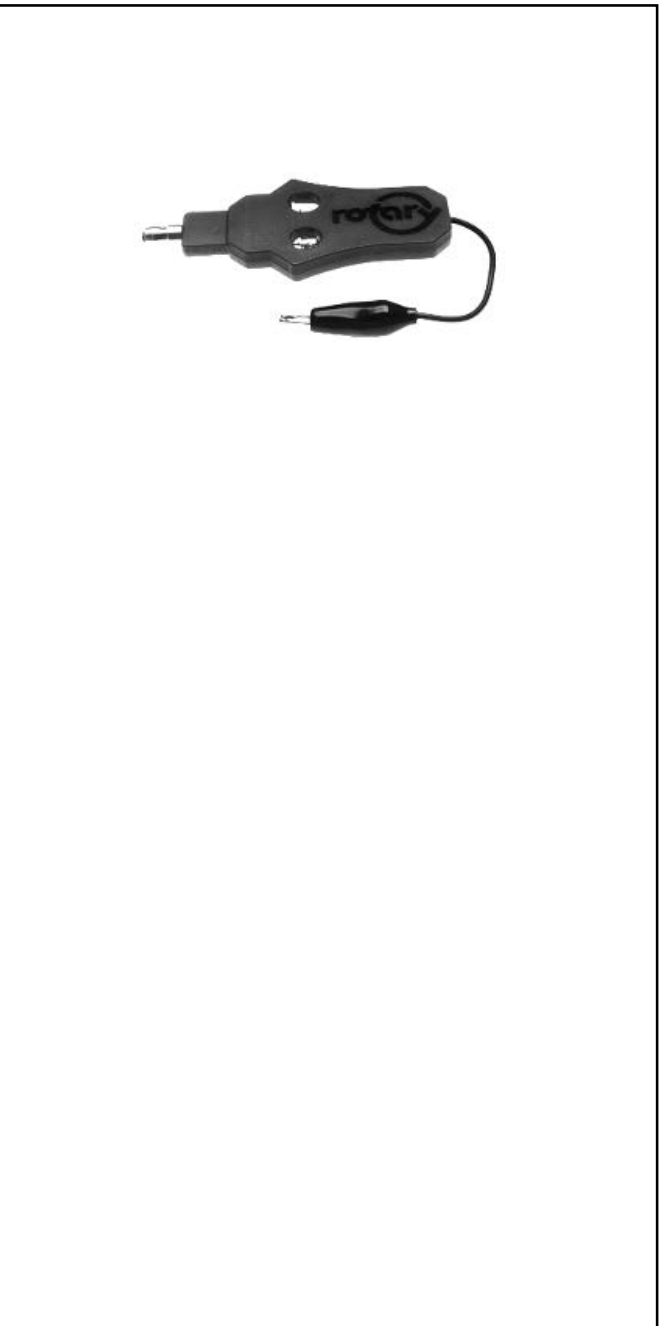
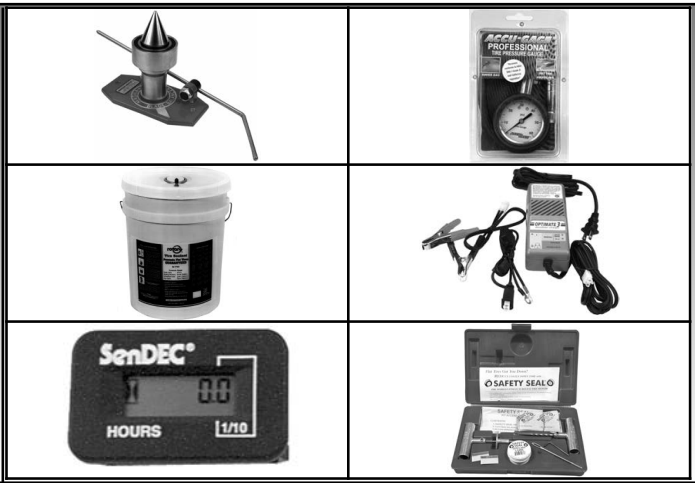

Quick-Glance

TOOLS	PG.
Blade Grinder	1087-1089
Battery Chargers	1093-1095
Spark Plug Tester	1095-1096
Safety Seal	1098
Tire Gauge	1092, 1097
Tire Sealant	1098
Flywheel Tool	1099
Belt Measurer	1100
Service Parts Bag	1100
Repair Tags	1100
Chain Breaker	1102, 1107-1108
Chain Saw Sharpener	1003-1105
Grease Gun	1108-1110
Ultrasonic Carburetor Cleaner	1110-1114



Pro-Thread Thread Repair Kits and Inserts



Repair Kits

Inserts (Pkgs. of 10)

Order No.	Description (Small Inch Thread Size)	Order No.	Description (Small Inch Thread Size)
32 - 2301	8-32	32 - 2305	MIN010 8-32
32 - 2302	10-32	32 - 2306	MIN010 10-32
32 - 2303	10-24	32 - 2307	MIN010 10-24
32 - 2304	12-24	32 - 2308	MIN010 12-24

Order No.	Description (Common Inch Size)	Order No.	Description (Common Inch Size)
32 - 2310	1/4-20	32 - 2313	MIN010 1/4-20 Steel Insert
32 - 2311	5/16-18	32 - 2314	MIN010 5/16-18 Steel Insert
32 - 2312	3/8-16	32 - 2315	MIN010 3/8-16 Steel Insert

Order No.	Description (Metric Thread Size)	Order No.	Description (Metric Thread Size)
32 - 2317	M5 x 0.8	32 - 2320	MIN010 M5 x 0.8 Steel Insert
32 - 2318	M6 x 1	32 - 2321	MIN010 M6 x 1 Steel Insert
32 - 2319	M8 x 1.25	32 - 2322	MIN010 M8 x 1.25 Steel Insert
32 - 2328	M4 x 0.7	32 - 2332	MIN010 M4 x 0.7 Steel Insert
32 - 2329	M10 x 1	32 - 2333	MIN010 M10 x 1 Steel Insert
32 - 2330	M10 x 1.25	32 - 2334	MIN010 M10 x 1.25 Steel Insert
32 - 2331	M12 x 1.25	32 - 2335	MIN010 M12 x 1.25 Steel Insert

Order No.	Contents
32 - 2324	MIN010 M14-1.25MM x 3/8 Steel Insert
32 - 2325	MIN010 M14-1.25MM x 7/16 Steel Insert
32 - 2326	MIN010 M14-1.25MM x 3/4 Steel Insert
32 - 2327	MIN010 M14-1.25MM x 1/2 Steel Insert



Packaged in lots of 10.

Order No. 32 - 2323

14 MM Thread Repair Kit for Spark Plugs.

32

Range Kit Set

Order No.	Contents
32 - 2317	(1) M5 Repair Kit
32 - 2318	(1) M6 Repair Kit
32 - 2319	(1) M8 Repair Kit
32 - 2323	(1) M14 x 1.25 Repair Kit
32 - 2310	(1) 1/4-20 Repair Kit
32 - 2311	(1) 5/16-18 Repair Kit



Order No. 32 - 2316

Contains: Range Kit .

TOOLS



TOOLS

Mighty Midget Crankshaft Straightener

Order No. 32 - 1709

Mighty Midget "Deluxe" Crankshaft Straightener and also combination work table which can be bolted solidly to your work bench when repairing engines. This Crankshaft Straightener will make your money fast and easy as you can straighten a crankshaft and also repair an engine without removing it from the straightener.

Contains:

- 1 - 32-2347 Pressure Equalizer Bolt. 1/2" - 20
- 1 - 32-2344 Adapter Sleeve 7/8"
- 1 - 32-2345 Adapter Sleeve 1"
- 1 - 32-2348 Pressure Bolt. 5/8" - 20
- 1 - 32-2349 Sleeve Bolt. 1/2" - 20

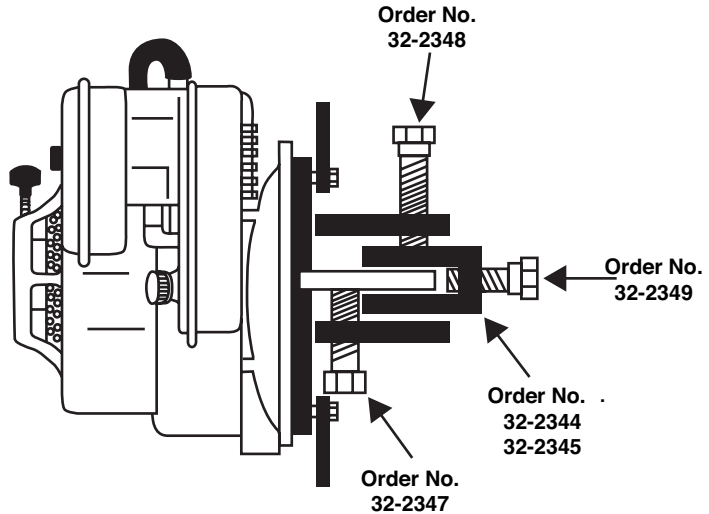

Engine Adapter Plate 2 Cycle

Order No. 32 - 2340

For mounting 2 cycle engines on Power Products. (remove muffler).



Adapter Sleeves

For Midget Racer Engines



Order No.	Size
32 - 2341	9/16"
32 - 2342	5/8"
32 - 2343	3/4"

Adapter Sleeves

For 2 and 4 Cycle Lawn Mower Engines



Order No.	Size
32 - 2344	7/8"
32 - 2345	1"
32 - 2346	7/8" short shaft

25MM Adapter Sleeve for Mighty Midget

Length 2-1/2"



Order No. 32 - 8691

25 mm adapter sleeve for Mighty Midget crankshaft straightener. Short shaft. Adapter sleeve for our 32-1709.

Special Tough Steel Bolts



Order No. 32 - 2347

Pressure Equalizer Bolt. 1/2" - 20



Order No. 32 - 2348

Pressure Bolt. 5/8" - 20



Order No. 32 - 2349

Sleeve Bolt. 1/2" - 20

32

TOOLS



Neway Valve Seat Cutter Kits



Order No. 32 - 1741

This gives you the tools to do the complete job on most air-cooled engines (even the 30° valve seats). The same accurate and precision kit that is used throughout the air-cooled engine industry now has a tool with a 15° top angle and a 60° bottom angle to repair your engines as the factory recommends.

Contains:

- 1 - 31° and 46° head, 1-5/16" dia.
- 1 - 15° and 60° head, 1-5/16" dia.
- 1 - 1/4" pilot
- 1 - 9/32" pilot
- 1 - 5/16" pilot
- 1 - 11/32" pilot
- 1 - 8mm pilot
- Wrenches
- Pilot Puller Pin
- Fitted Tool Case



Order No. 32 - 1742

This valve seat reconitioning kit has a specially engineered cutting head with a 31° angle on one side and 46° on the other. The Neway Valve Seat Cutter is a hand operated tool that fits most air-cooled engines. It insures greater accuracy and produces precision work at low cost. Includes all parts listed below plus 11/32" pilot and longer blades. This kit will also cut all known Wisconsin engine seats except models VQ4 and VR4. The cutter head is adjustable to 1-11/16" diameter.

Contains:

- 1 - 31° and 46-5/16" diameter adjustable to 1-9/16"
- 1 - 1/4" (.248) pilot
- 1 - 9/32" (.279) pilot
- 1 - 8mm pilot for worn 5/16" guide
- Wrenches
- Pilot Puller Pin
- Fitted Tool Case

Order No. 32 - 1750

#250 Blades for previous model 102A. One blade per pack.

Order No. 32 - 1751

#251 Blades for model 102W. One blade per pack.



Order No. 32 - 8940

Neway's latest and most complete valve seat cutter kit, puts precision reconitioning at your finger tips. The LG-3000 contains everything you need to reconition valve seats for most four-cycle power equipment - including the newest overhead valve engines on the market.

Contains:

- 1 - 31° & 46° head, 1-15/16" dia.
- 1 - 31° & 46° head, 1-1/8" dia.
- 1 - 60° head, 1" dia.
- 1 - 15° & 60° head, 1-5/16" dia.
- 1 - 6.02mm pilot
- 1 - 6.05mm pilot
- 1 - 1/4" pilot
- 1 - 9/32" pilot
- 1 - 5/16" pilot
- 1 - 8.0mm pilot
- 1 - 11/32" pilot
- T Wrench
- Hex keys
- Brush
- Pilot puller pin
- Fitted tool case
- Operating instructions

Cutter Head Assembly for NEWAY



Order No. 32 - 9305

Neway #124 cutter head assembly. 15° & 60° head, 1-1/8" dia. Used with our 32-8940, 32-1741, 32-1742 Kits.

Neway "GIZMATIC"



Order No. 32 - 8875

The "Gizmatic" is Neway's most efficient tool for refacing valves by hand. The "Gizmatic" combines the "Gizmo" & Hand Valve Refacer into one tool. Features include a crank style lever which turns the blades against the stationary valve face. This crank provides the operator with enough leverage to make the job effortless, while a second lever allows the operator to control the feed rate of the blades. The "Gizmatic" features soft jawed V-Blocks which hold the valve stem securely in a vise while the cone, either 45° or 30°, automatically centers itself on the valve face. This unique tool offers a unique value in valve refacing.

TOOLS



Grip-Tite Socket Set Combination



Order No. 32 - 13555

14 piece Grip-Tite Super Socket Set. Combination SAE & MM.

Grip-Tite Metric Socket Set



Order No. 32 - 13557

17 piece Grip-Tite Metric Super Socket Set with ratchet and 3" extension.

Grip-Tite SAE Socket Set



Order No. 32 - 13556

17 piece Grip-Tite SAE Super Socket Set with ratchet and 3" extension.

Grip-Tite SAE Super Wrench Set



Order No. 32 - 13558

6 piece Grip-Tite SAE Super Wrench Set with V-Tray.

Grip-Tite Metric Super Wrench Set



Order No. 32 - 13559

6 piece Grip-Tite Metric Super Wrench Set with V-Tray.

32

TOOLS



6" Wire Wheel

Order No. 32 - 8604

6" knot type wire wheel. 1/2" ID.



NEARY Blade Grinder

Order No. 32 - 8779

Neary model 440 rotary blade grinder. Sharpens all types of blades including standard design and mulching styles. Industrial 1/2 HP 3450 RPM motor, totally enclosed for long life. Precision balanced, 8" x 1" aluminum oxide grinding wheel. Guide adjusts for blades sharpened from 20 - 40 degrees. Sharpen blades that rotate clockwise and counter clockwise. Neary supplies wheel dressing brick, blade balancer with every unit.



Order No. 32 - 8778

Replacement rocker arm switch for our 32-8779 Neary blade grinder.

Premium Ceramic Wheel Blue

Order No. 32 - 14155

8 x 1 x 5/8" Premium ceramic wheel (36 grit) blue color. RBG 2208. Fits our 32-8779 & 32-9237 Grinders.

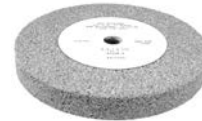

Replacement Stones

Order No. 32 - 2682

Fits 1/3 hp Blade Grinder. 7" x 3/4" x 5/8" center hole. 46 grit.

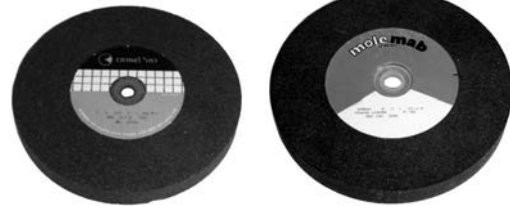

Order No. 32 - 2683

Fits 1/2 hp grinder, our old 32-1735 & new 32-8779. 8" x 1" x 5/8" center hole. 36 grit.

Ruby Stones

For a cooler, cleaner grind and finer finish.

Order No. 32 - 8543

8" x 1" x 5/8" center hole, 36 grit. Fits on our 32-1735, 32-9237 & 32-8779 grinder.

Order No. 32 - 7265

7" x 1" x 5/8" center hole, 46 grit, for Wahl Grinders.

Order No. 32 - 7266

8" x 1" x 5/8" center hole, 46 grit, for Neary Grinders. Fits on our 32-9237.

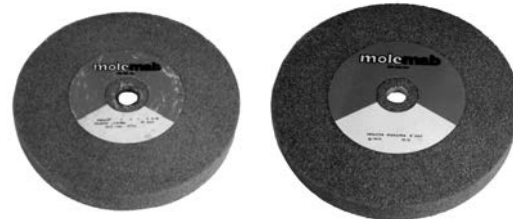

Ruby Stone

Order No. 32 - 9251

12" x 1" x 7/8" center hole, 46 grit. Fits our 32-9238 Blade Grinder.

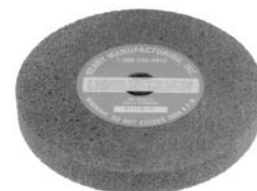



TOOLS

**WALL
Blade Grinder**



Order No. 32 - 9237

The standard BG 121 is designed to be the most affordable Blade Grinder available. All B.G. Grinders feature a totally enclosed Standard Duty Motor which requires an arbor bolt to mount the R.G.B. Grinding Wheel. All B.G. and R.G.B. Grinders have a specially designed reversing switch which allows you to grind both right and left had blades to a fine hollow grind. All B.G. and R.G.B. Grinders have quick guard removal for easy wheel replacement.

**WALL
Blade Grinder**



Order No. 32 - 9238

Designed to sharpen "all" blades, Bush Hog Type, Commercial as well as Standard Blades. R.B.G. 1012-C is the most heavy duty Grinder manufactured by R.B.G. Grinders. The 1012-C comes with a totally sealed and enclosed 1 hp. Commercial Duty Motor and features a 12" Blue Premium Ceramic-Aluminum Oxide. The extra large frame and work table are manufactured from 3/16" formed steel. If you're looking for an extra hard working Blade Grinder we recommend the R.G.B. 1012-C.

**Mulching Plate for
WALL Blade Grinder**



Order No. 32 - 9402

Mulching plate for our 32-9237 Wall Blade Grinder.

**Mulching Plate for
WALL Blade Grinder**



Order No. 32 - 9403

Mulching plate for our 32-9238 Wall Blade Grinder.

**Grit Collector for
WALL Blade Grinder**



Order No. 32 - 9400

Grit collector for our 32-9237 Wall Blade Grinder.

**Grit Collector for
WALL Blade Grinder**

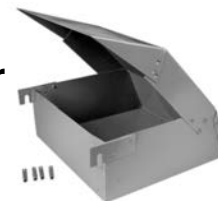

Order No. 32 - 9401

Grit collector for our 32-9238 Wall Blade Grinder.

**Switch for
Wall Blade Grinders**



Order No. 32 - 9530

Switch for Wall BG121 & RGB1012C, blade grinders. Switch for our 32-9237 & 32-9238 Blade Grinders.

Dressing Wheel



Order No. 32 - 9532

Dressing wheel for our 32-9238 blade grinder.

Grinding Stone



Order No. 32 - 7016

Grinding stone for our 32-9238 blade grinder. 12" x 1" with a 7/8" center hole. 30 grit. Blue ceramic stone.

Grinding Wheel

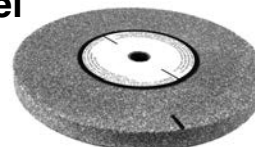

Order No. 32 - 13368

12" x 1" x 7/8", Hard side Mulch Grinding Wheel (used with mulch plate). Fits our 32-9238 Blade Grinder.

32

TOOLS



WALL RBG 712 Blade Sharpener/Grinder



Order No. 32 - 11706

Restore blades to a factory flat edge using our preset blade guide to maintain the proper angle for the best cut and edge life. By replacing traditional grinding wheels the RBG 712 will reduce your work time while eliminating grinding wheel dust and wheel dressing. The unique design will allow you to grind any length of cutting edge required for both standard right-hand and reverse left hand rotation flat blades. With the addition of the optional grit collector you can maintain a cleaner and safer shop while sharpening blades. 1/2 hp, 7" disc wheel.

Blade Sharpener/Grinder from WALL



Order No. 32 - 13140

WALL RBG-912 Blade sharper/grinder. Automatic hands free operation. 1/2 hp, 9" x 1" disc wheel. Restore your old blades to a factory flat edge with ease. Simply lock your blade in the blade holder, set the timer, engage the blade, and walk away. For replacement disc wheel use our **32-13221**.

WALL Grit Collector for RBG 712



Order No. 32 - 11707

Wall Grinder Grit Collector. Fits our **32-11706** Grinder.

MAGNA-MATIC MAGNETIC Blade Balancer



Order No. 32 - 9788

- Extra long life-made of finest precision steel.
- Special sealed bearing-made for precision balancing.
- Super strong magnets to hold blade.

FAST and ACCURATE!

... Just slip the blade (with any size hole up to 1-1/2") onto the cone
 ... The magnetic holding collar holds blade perfectly on center
 ... The ball-bearing spindle is then free to rotate and show the slightest out-of-balance conditions of the blade. With but a twist of the wrist the blade is off to be reworked when necessary. The TRACKING ARM can be extended for all size blades. MAG 1000. **American Made.**

WALL Disc Wheel for RBG 712

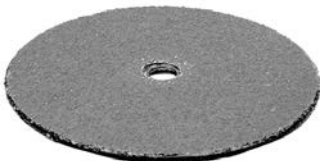

Order No. 32 - 11710

Wall 7" Disc Wheel. Fits our **32-11706** Grinder.

Magnetic Wall Mount Blade Balancer from TECOME C



Order No. 32 - 13216

Tecomec magnetic wall mount blade balancer. 6 magnets allow better stability.

Order No. 32 - 13221

Replacement disc wheel for our **32-13140**.



TOOLS

Valve Refacer



Order No. 32 - 1726

For small engines. Equipped with Carboly Cutter to service hard steel valves.



Order No. 32 - 9072

Replacement Handle for our 32-1726 Valve Refacer.



Order No. 32 - 1743

Cutter Blades. Carbon steel cutter blades for Zim Valve Refacer. For our 32-1726

Valve Seating Tool



Order No. 32 - 1731

Suction Cup Style with 15/16" and 1-1/16" diameter cups. Fits all small engines.

Small Engine Valve Grinder



Order No. 32 - 9050

This one of a kind tool is the complete versatile tool for lapping and grinding valves in seats. Has short locking stems and valve head insert end for both. Also comes equipped with spring and vacuum cup for lapping. Inexpensive but extremely valuable to small engine mechanics.

Order No. 32 - 9051

Replacement 3/4" rubber cup for 32-9050.

Piston Stop Steel



Order No. 32 - 12614

Piston stop steel. Locks pistons in 2-Cycle engines to help removal of clutches & flywheels. 14mm tread machined steel.

Small Engine Valve Compressor



Order No. 32 - 9034

Replacement feet for 32-9033.

Small Engine Valve Spring Compressor

Order No. 32 - 9252

Small engine valve spring compressor replaces our 32-9033.



Order No. 32 - 9253

Small replacement jaw fits our 32-9252.

Order No. 32 - 9254

Large replacement jaw fits our 32-9252.

Valve Spring Compressor

Order No. 32 - 9054

The ideal tool for removing and replacing valve springs of B&S engines. Long and slender, it is adapted to reach into small recesses in which valve springs and retaining washers are located. The arms are hinged so they are practically parallel at the jaws. Spring steel jaws are adjustable in width to fit the valve springs and have edges so thin that they can be easily forced under and over the ends of the valve spring to compress it for removal. Finished in Cadmium.



32

TOOLS



Valve Lapper from Woods Powr-Grip



Order No. 32 - 9013

Valve lapper replaces B&S 19258. Includes 3/4" & 1-1/4" diameter cups.

Valve Spring Compressor



Order No. 32 - 1706

Compressor - Fits most fractional horse-power engines. Notched end compresses valve spring. Hook end aligns valve spring retainer. Remove and install valve springs on all engines using self-locking valve spring retainers.

Ring Expander

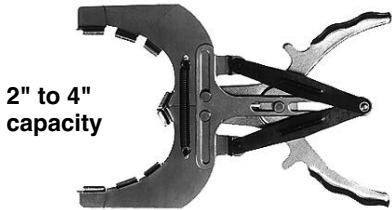

Order No. 32 - 9052

For installing and removing piston rings without the danger of breakage or distortion. No adjustments needed. All rings expanded whether step-cut or diagonal cut.

Cylinder Ridge Reamer



Order No. 32 - 9053

This cylinder ridge reamer does a perfect job everytime. Simple to use. Has excellent carbide cutter replaceable at low cost. Designed to cut across ridge with no "feed-up". The only special small engine reamer made. Range 2" to 3".

Piston Groove Cleaner



Order No. 32 - 9055

Sizes up to 5-1/2". Hardened cutter 5/64", 3/32", 1/8", 5/32" and 3/16". To change position of cutter simply loosen the screw and turn blade.



Order No. 32 - 9069

Cutter. Special hardened cutter for 32-9055.



Order No. 32 - 9070

Cutter replacement for groove cleaner 32-9055.

Ring Compressor



Order No. 32 - 1749

For cylinders with 1-1/2" to 3" diameter. Made of blued spring steel.

Small Engine Cylinder Hone



Order No. 32 - 1704

Fits 1-1/2" to 3" cylinders. Easy adjustments to any small engine application. Length: 7-3/4". Complete with stone - plated.



Order No. 32 - 1705

Replacement Stones for 32-1704 Cylinder Hone. 2" Length x 5/16" width. Set of three. (medium grit)



TOOLS

Piston Ring Assembly Tool for HUSQVARNA



Order No. 32 - 14626

Piston ring assembly tool kit. Replaces Husqvarna 502-50 70-01. Useful for assembling pistons and cylinders on chain-saws. 4 sizes of clamps. Give yourself a third hand with this kit. This kit will compress piston rings ranging from 30mm to 60mm in diameter. Includes a piston support block and piston stop.

Small Engine Compression Tester



Order No. 32 - 9036

Especially designed for small engine use. Dual dial, Metric and American, chrome gauge. Has a slide release valve for multiple tests. For use on 14mm and 18mm plug holes.

Order No. 32 - 9037

Valve Core for our 32-9036 Compression Tester 300psi.

Carburetor/Crankcase Pressure Gauge



Order No. 32 - 11321

Carburetor/Crankcase pressure gauge. Pumps up to 15 P.S.I.

Carburetor/Crankcase Pressure Gauge



Order No. 32 - 8338

Carburetor/Crankcase pressure gauge pumps up to 14 P.S.I. has both American and Metric scales.

Shrink Tube

Order No.	Qty.	Description
32 - 11551	8	1/8" x 6"
32 - 11552	8	3/16" x 6"
32 - 11553	8	1/4" x 6"
32 - 11554	4	3/8" x 6"
32 - 10655	4	1/2" x 6"
32 - 10666	3	3/4" x 6"



Shrink Tube Assortment

CONTENTS		
Order No.	Qty.	Description
32 - 11551	8	1/8" x 6"
32 - 11552	7	3/16" x 6"
32 - 11553	7	1/4" x 6"
32 - 11554	5	3/8" x 6"
32 - 10655	4	1/2" x 6"
32 - 10666	3	3/4" x 6"



Order No. 01 - 11550

Shrink Tube Assortment. This assortment contains 38 pieces of our popular sizes in a see through impact resistant box.

32

TOOLS



Battery Chargers from SCHUMACHER

Order No. 32 - 10343

Battery charger 12 volt, 1 amp manual. Plugs into wall electrical outlet. Convenient 12 ft power cord reach. Charges small 12 volt batteries and keeps larger batteries warm in cold temperatures. Reverse polarity protection.

Order No. 32 - 10344

Battery charger 6/12 volt, 1.5 amp automatic. Unique automatic battery charger maintains both 6 and 12 volt batteries, keeping them at full charge using float-mode monitoring. Perfect for charging small batteries. LED's indicate: Charging, Charged and Trouble. Reverse polarity protection.

Order No. 32 - 10345

Battery charger 10/2 fully automatic dual-rate. This economical 12 volt charger can be used two ways. Manual or fully automatic. No overcharging worries when in fully automatic mode. 10 amp fast charge for everyday charging needs. Charges in 3 to 5 hours. 2 amp trickle charge, charges a small 12 volt battery in 2 to 12 hours. LED light signals fully charged. Fully automatic will not overcharge batteries.



Battery Tester from SCHUMACHER



Order No. 32 - 10460

Easy to operate battery tester. Test load, battery condition, starter motor draw and complete charging system. for 6 and 12 volt batteries. 100 amp load test for 6 volt, 50 amp load test for 12 volt. Easy to read meter.

Adjustable Ignition Spark Tester



Order No. 32 - 9773

Adjustable ignition spark tester works on ignition systems from high energy electronic automotive systems to small engines. Tests for no start conditions and for spark strength. Adjustable gap allows for different spark gap requirements of different ignition systems from 0 to 40,000 volts. Gauge background makes spark easy to see for accurate measurement. Alligator clip securely fastens to ground.

Circuit Tester



Order No. 32 - 9835

Circuit tester checks all 6 and 12 volt systems. Locates shorts, grounds and open circuits. Made in the U.S.A.

Ignition & Spark Plug Tester



Order No. 32 - 9099

TOOLS



**OPTIMATE 3
BATTERY CHARGER**

Order No. 32 - 11998

Optimate 3 battery charger. Replaces Honda 31670-VMS-000. First Aid for batteries. Left your battery unattended and now its dead? Your ordinary smart charger shows "Battery Ready" but its not? Optimate 3 will save neglected batteries other smart chargers can't. Recommended for all 12v lead-acid batteries from 2Ah to 45Ah, although it can also maintain larger batteries (it will take longer to charge).



**Wall Bracket for
OPTIMATE 3**

Order No. 32 - 12000

Optimate 3 battery charger Wall Bracket.



**Replacement Battery Clip for
OPTIMATE 3**

Order No. 32 - 12008

Optimate 3 battery charger replacement battery clips.



**Charger Cable Extender for
OPTIMATE 3**

Order No. 32 - 12009

Optimate 3 battery charger cable extender.



**Replacement Connector for
OPTIMATE 3**

Order No. 32 - 12011

Optimate 3 battery charger replacement weatherproof permanent connector.



**Charger Cable Adapter for
OPTIMATE 3**

Order No. 32 - 12014

Optimate 3 battery charger cable adapter. Works with battery Tender connector.



32

TOOLS

BATTERY TENDER
12 Volt Fully Automatic Charger



Order No. 32 - 7829

The Battery Tender is a 1.25 amp battery charger that automatically switches from full charge to a float charging mode, and then monitors the battery. Designed to fully charge a battery and maintain it at proper storage voltage without the damaging effects caused by trickle chargers. For lead acid and gel cell batteries only. Has a 6 ft. cord. Made in USA. 5 year warranty.

Charging System Tester



Order No. 32 - 9074

Charging System Tester. Checks battery condition and starting as well as charging system. Both 6 and 12 volt. Full instructions. Model 1092 Dixson.

Testmate Mini Battery Analyzer



Order No. 32 - 11999

Testmate Mini Battery Analyzer. This unique, handheld on vehicle battery and charging system tester. Checks battery voltage. Checks battery starting power. Checks vehicle charging system. Used to analyze where the problem lies. Limited electrical knowledge required.

Accumate Pro5



Order No. 32 - 12010

Accumate Pro5, five station battery charger. The cost effective 5-bank charger - each bank is an independent 1, 8A automatic 4-stage smart charger. Simultaneously charge & maintain any combination of 5 separate or series / parallel connected batteries. Ideal for seasonal battery storage or stock management. Delivered with wall mounts for convenient placement.

Ignition/Spark Plug Tester



Order No. 32 - 7731

This tester checks the integrity of the electrical ignition and magneto/coil ignition systems of lawnmowers, boat motors, motorcycles and automobiles. The tester checks both current and voltage and will indicate fouled electrodes. E-Z view LED and neon lamps for easy accurate reading, pocket size, high impact ABS plastic casing.

TOOLS



Economy Ignition Tester



Order No. 32 - 1754

An easy to use, time saving piece of shop equipment.

Spark Plug Gap Wire - Gauge



Order No. 32 - 1707

With electrode adjusting tools, thousand and metric equivalents.

CheckSpark Engine Ignition Analyzer

Order No. 32 - 14297

Checkspark Engine Ignition Analyzer quickly and safely tests for proper spark on 2 stroke and 4 stroke engines. Eliminates guess work. 1 of 3 LED's will accurately indicate the condition of ignition system. Tests, proper voltage, high voltage, low voltage, no voltage. One person, hands free operation, just clip on the sparkplug wire and crank. Patented gripper hook.



Spark Plug Hole Thread Chasers



Order No. 32 - 5827

14 - 18mm Hex Spark Plug Hole Thread Chaser. Renews damaged threads. Removes carbon and corrosion with a few turns. Allows firm seating of plugs. Assures metal to metal contact for effective heat transfer.



Order No. 32 - 9031

10 - 14mm Hex Spark Plug Hole Thread Chaser. Renews damaged threads. Removes carbon and corrosion with a few turns. Allows firm seating of plugs. Assures metal to metal contact for effective heat transfer. Long hex designed to prevent "wobble". Neoprene ring holds chaser snugly in socket. Made of heat treated steel.

32

Ammeter



Order No. 32 - 9019

Universal Ammeter - Round. 2-1/4" dia. Mounts easily with 2 nuts provided.

Wireless Tachometer



Order No. 32 - 9073

Precision hand held instrument. Accurately reads R.P.M. in all 2 and 4 cycle single cylinder engines. 0 to 15,000 R.P.M. Scales. Solid State. Uses 9 volt battery, not included. Model No. 1082 Dixson.

TOOLS



Hour Meter



Order No. 33 - 9359

Tach/Hour meter. Records actual running of engine. Non-erasable. Shows engine RPMs (Read up to 9,000 RPMs). Alerts you to Lube (grease) & Change Oil (25 hour intervals). No battery required, triggered from the spark plug wire.

Sendec Digital Hour Meter

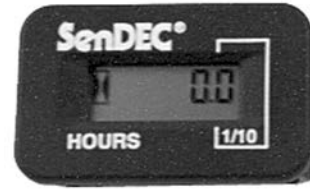

Order No. 33 - 10408

Sendec digital hour meter. Small panel mount. Used on several riders. Replaces AYP 169642, 177501, 110940X.

PVC Electrical Insulating Tape



Order No. 32 - 9023

1/2" x 60', 7 mil. tape.

Tube-Grip



Order No. 32 - 9474

Tube grip is an innovative tool designed to accurately dispense materials from flexible tubes. It also enables you to dispense the thickest sealants through very small openings. Includes 3 oz. tube of RTV aluminum silicone.

Tire Gauge



Order No. 32 - 6599

AccuGage Tire Gauge comes with a flexible, braided hose for easy access to valve stem, a bleed valve for precise air pressure, an unbreakable crystal and a rubber boot (cover) to help protect the gauge casing. Brass geared movement, accurate Bourdon tube design - not a plunger. 0-60 gauge.



Order No. 32 - 11814

AccuGage tire gauge. Flexible 11" hose between gauge and chuck for hard to reach tire valves 0-15 psi range. Swivel-angle chuck. Polished brass bezel, stem pressure release valve assembly. Needle holds pressure reading until released. Pushbutton valve bleeds air to desired pressure.

Valve Stem & Core Tool

Order No. 32 - 9973

Valve stem and core tool, used to remove and install valve stems and valve stem cores in tubeless and tube type tires and wheels.



TOOLS



Safety Seal



Order No. 32 - 14196

Safety Seal Slim Refill 121-60. Pack of 60, 4" repairs designed for that tough to repair tiny puncture (max 1/8").

Insert Plugs only for SAFETY TIRE SEAL



Order No. 32 - 8191

Replacement insert plugs for our repair kit 32-8081. (60 replacement plugs per box.)

Safety Seal Slim Refill



Order No. 32 - 8081

The original self vulcanizing, easy to use, clean, economical, permanent, tubeless tire repair system. It's the on-the-job, on-the-wheel repair for all tubeless tires. Comes with insertion tool, spreader probe, lube, spare needle, allen wrench, blades, seal cords.

Tire Bead Lube



Order No. 32 - 12975

Tire bead lube. Delta first bead lube concentrate is probably the slipperiest in the industry. The turquoise colored concentrate can be mixed 3 to 1 with tap water to make an efficient and economical mounting lube. It's much slicker than mounting paste and allows tires to easily slide and get the bead properly mounted on the rim. Also contains a rust-inhibitor package that will not allow rust to form on the rim. Its entirely non-toxic, odorless, and environmentally friendly. 4 per case. Concentrate 1 gallon.

Tire Sealant 5 Gallon Container



Order No. 32 - 7763

Use this 5 gallon bulk container of tire sealant with our pump 32-7764 for an easy, no mess alternative of applying tire sealant to a multitude of equipment.

Tire Sealant Pump



Order No. 32 - 7764

Pump assembly for our 32-7763 5 gallon container of tire sealant. Injects 8 oz. per pump.

5 Gallon Heavy Duty Slime Tire Sealant



Order No. 32 - 9551

5 Gallons of heavy duty Slime tire sealant.

Slime Tire Sealant Pump



Order No. 32 - 9552

Aluminum pump for our 32-9551 5 gallon Slime tire sealant. Also includes cap for pail.

32

TOOLS



Flywheel Tool

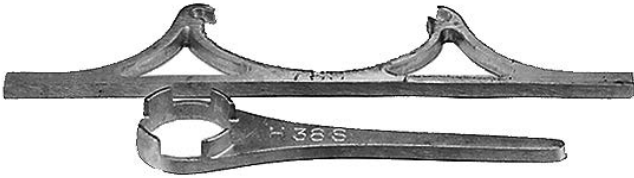

This tool can be used on all Briggs & Stratton engines for removal of starter clutch and holding Flywheel.

Order No. 32 - 1753

For 3 - 3-1/2 hp engines. Complete set.

Order No. 32 - 1758

For 4 - 5 hp engines. Complete set.

Order No. 32 - 1759

For 6 - 7 hp engines. Complete set.

Ratchet Starter Remover



Order No. 32 - 1757

A real time saver to be used with 1" socket, any drive or 1/2" drive. Made of heavy gauged steel. Fits B&S 19244. Also fits newest B&S ratchets.

Flywheel Pullers

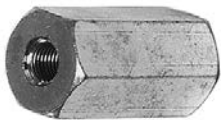

Order No. 32 - 9102

Replaces Tecumseh 670103. 7/16" thread size.

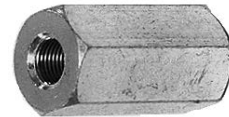

Order No. 32 - 9103

Replaces Tecumseh 670169. 1/2" x 20 thread size.

Flywheel Knocker



Order No. 32 - 1738

Flywheel Knocker.

Throttle Wire Bending Tool



Order No. 32 - 1720

Condenser Tool



Order No. 32 - 1736

This handy tool will compress the spring while you remove or attach primary wire.

J-B Weld



Order No. 32 - 9077

JB Weld cold weld compound. Repairs, fills, bonds: Iron, steel, copper, aluminum, brass, bronze, pewter, wood, porcelain, ceramic and plastic.



TOOLS

Combination Internal-External Snap Ring Pliers



Order No. 32 - 1725

Compress internal rings with one pair and expand external rings with the other. Comes complete with four sets of tips in a plastic box.

Electrical Wire Stripper/Crimper Tool



Order No. 32 - 6718

Electrical Stripper/Crimper Tool. The fast, easy and professional way to strip electrical wire. Used to strip automotive electrical wire.

Heavy Duty Three-Jaw Gear Pullers



Order No. 32 - 9020

4" size

BICO gear pullers are drop-forged and feature heat-treated screws and floating screw center points. Jaws are adjustable and reversible for application to all gear removal jobs.

Service Repair Tags



Front



Back

Order No. 32 - 9087

These repair tags are sharply printed and made of durable material, with reinforced eyelets, with wire. They help you to organize information, minimize errors, and alert personnel to special instructions. Size: 3-1/4" x 6-1/4". MIN100

32

Belt Measurer



Order No. 32 - 9108

Belt Measurer. Measures 3/8", 1/2" and 5/8" fractional horse power belts as well as A & B section Industrial Belts up to 110".

Service Parts Bags



Order No. 50 - 7256

Service parts bag, measures 8-3/8" x 12", writing area of 5" x 1-1/2" and has a hole for hanging. MIN100

TOOLS



T-Handle Torx Wrench



Order No. 32 - 13161
T-Handle Torx Wrench T27.

T-Handle Allen Style Hex Wrench



Order No. 32 - 13164
3mm T-Handle allen style hex wrench.
Order No. 32 - 13163
4mm T-Handle allen style hex wrench.
Order No. 32 - 13162
5mm T-Handle allen style hex wrench.

Torx L Wrench Driver for STIHL



Order No. 32 - 9062
Wrench replaces Stihl 0812-370-1145. Fits stihl screws T-27 size bit.

Rotary Pocket Screwdriver



Order No. 50 - 8016
Rotary Pocket Screwdriver. Comes with interchangeable phillips or flat head. **Length 5-9/16"**.

Gasket and Carbon Scraper

Order No. 32 - 9027
The 1" wide blade makes short work of those tough jobs. Blade is forged steel and tempered for long life. Can be resharpened many times. Comfortable plastic handle.

Overall Length 9-1/2"



Crankshaft Holder Wrench



Order No. 32 - 9029
This handy tool will do many small pulling jobs from oil seals to carburetor clips. Every tool box should have one.



Order No. 32 - 9030
For small engines and outboard motors. Makes ignition and valve work easy. Turn crankshaft after flywheel is removed.

TOOLS



Roller Chain Puller - Holder

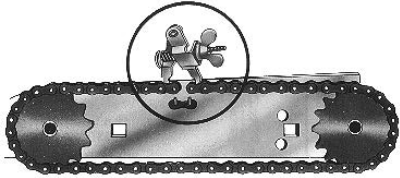

Order No. 32 - 9071

Time saving, handy tool to help put a chain on at the right tension. Leaves both hands free to connect chain. For chain 35 through 60.

Chain Breaker



Order No. 32 - 1733

Lightweight - For use with Chain 35, 40, 41, 42, 43 or 50. Fast and simple method of taking apart rivet type roller chain.

Order No. 32 - 1729

Replacement pin for our chain breaker 32-1733.

Reversible Impact Driver

Order No. 32 - 9010

3/8" Drive Reversible Impact Driver. The perfect hand tool for loosening or tightening frozen nuts, bolts and screws. Just strike the blunt end of the driver with a hammer and the operation is complete. Can be used with 3/8" drive sockets.



Set contains:

- 2 Phillips Type bits
- 2 Flat Bits
- 2 x 36mm (1-7/16")
- 8 x 36mm (5/16")
- 3 x 36mm (1-7/16")
- 10 x 36mm (3/8")

Recoil Air Hose



Order No. 32 - 1755

This 25' self-retracting air hose is a must for all air tools. Made of tough lasting nylon. Includes hose end and 1/4" fittings. 200 psi, 5/16" OD, 3/16" ID.

Impact Driver Bits



Order No. 32 - 6596

Set of 8 bits for our Impact Driver 32-9010.

- | | |
|-----------------------------|----------------------------------|
| 4 Phillips Type Bits | 4 Flat Bits |
| (1) 2 x 80mm (3-1/8") | (1) 8mm x 80mm (5/16" x 3-1/8") |
| (1) 3 x 80mm (3-1/8") | (1) 10mm x 80mm (3/8" x 3-1/8") |
| (1) 2 x 36mm (1-7/16") | (1) 8mm x 36mm (5/16" x 1-7/16") |
| (1) 3 x 36mm (1-7/16") | (1) 10mm x 36mm (3/8" x 1-7/16") |

Nylon Cable Ties



Order No. 32 - 8531

4" Nylon cable ties.

MIN100

Order No. 32 - 8545

14" Nylon cable ties.

MIN100

Order No. 32 - 9086

7" Nylon cable ties.

MIN100

32

TOOLS



Chain Saw Tools Efco Saw Chain Sharpener

Order No. 32 - 4250

- The easiest to use of all chain grinders. Fast, accurate, precision perfect.
- The adjustable 10° reclinable vise makes it one saw chain grinder that can perfectly sharpen any saw chain style from chipper to round ground chisel in the following pitches: 1/4", .315", .325", .354", 3/8", mini, .404" and 1/2".
- Large direct motor - 1/4 hp (approx.).
- No belts - gives consistent grinding wheel speed.
- Adjustable Head Tilt simplifies correct grinding angles. Pivoting vise permits fast change over from left to right hand cutter sharpening.
- Can be bench or stand mounted.
- Comes complete with 2 grinding wheels, instructions, dressing, brick for facing wheel, and 3/16" and 1/4" depth gauge wheel.
- Motor specifications: 115 volt single phase, draws three amps. 1/8" wheel speed 3400 R.P.M.
- Parts Available:



Order No. 32 - 4256

Motor Spring

Order No. 32 - 4257

Pawl

Order No. 32 - 4239

Dressing brick



Grinding Wheels for 32-4250 Grinder

5-11/16" Diameter
7/8" Center Hole

Order No.	Thickness	Chain Pitch	Recom. RPM'S
32 - 4252	3/16"	3/8", .354", .404"	4480
32 - 4253	1/8"	1/4", .325", 3/8", mini	4500
32 - 4254	1/4"	depth gauge	4500

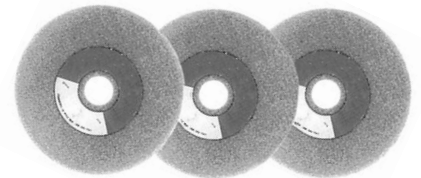

Note: Each wheel should be rung to ensure that wheel is not damaged.

Circular Telescoping Mirror



Over all Length 10"

Order No. 32 - 9039

2-1/4" diameter. Extends to 14".

Pocket Magnet



Order No. 32 - 9038

Adjust to 28".

Flexible Pick Up Tool



Order No. 32 - 9028

This tool will bend in any direction to hold or pick up objects. Handy squeeze action gives close control. Luster finish. Length 23-1/2".

TOOLS



"MIDI JOLLY" CHAIN GRINDER



Order No. 32 - 9704

This new compact grinder stands out for its great versatility and professional grinding capacity. The "MIDI JOLLY" mounts a permanent magnet motor capable to provide excellent performances even under the greatest strain.

Super Jolly Grinder



Order No. 32 - 14421

Super Jolly Grinder model TL1150 with automatic vise feature of a hydraulic chain clamp vise. This automatically locks the chain when the grinding head is lowered and can reduce sharpening time by as much as 50%. New self-centering adjustment knob. Powerful, 110V, 300 watt direct-drive, ball bearing motor, large fan and aluminum fins keep motor running cool. Adjustable vise accepts any chain type, large diameter wheel prevents cutter burn. Mounts on wall or bench, easily head angle adjustment.

Grinding Wheels for Mini Jolly Grinder

3-15/16" Diameter
5/8" Center Hole

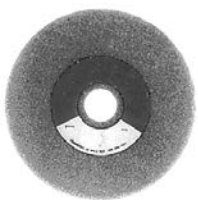

Grinding Wheel for 32-9704



Order No. 32 - 9705

Grinding wheel for our 32-9704 Chain Grinder. 4-1/8" OD x 7/8" ID x 1/8" Thickness.

Order No. 32 - 9706

Grinding wheel for our 32-9704 Chain Grinder. 4-1/8" OD x 7/8" ID x 3/16" Thickness.

Order No. 32 - 9707

Grinding wheel for our 32-9704 Chain Grinder. 4-1/8" OD x 7/8" ID x 1/4" Thickness.

32

TOOLS

Order No. 32 - 5845

1/8" Thickness

Order No. 32 - 5846

3/16" Thickness

Note: Each wheel should be rung to ensure that wheel is not damaged.



Light Bulb for Grinders



Order No. 32 - 14607

Light bulb for grinders. Fits most Grinders

Vise Bottom for JOLLY STAR



Order No. 32 - 14612

Vise bottom for Jolly Star.

Pawl Kit for JOLLY STAR



Order No. 32 - 14611

Pawl kit for Jolly Star.

Vise Assembly for JOLLY STAR



Order No. 32 - 14610

Vise assembly for Jolly Star.

Swivel for Base for JOLLY STAR

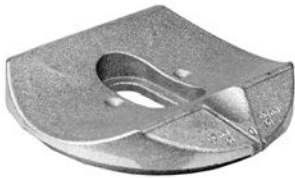

Order No. 32 - 14609

Swivel for Base for Jolly Star.

Spring Motor Return for JOLLY STAR



Order No. 32 - 14608

Spring motor return for Jolly Star.

Spring Motor Return for SUPER JOLLY



Order No. 32 - 14613

Spring motor return for Super Jolly. Fits our 32-14421.

Chain Stop for SUPER JOLLY



Order No. 32 - 14614

Chain stop for Super Jolly. Fits our 32-14421.



TOOLS



File-O-Plate from
CARLTON

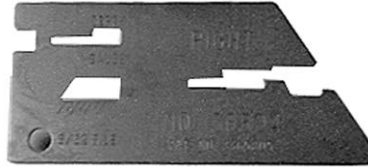

Order No. 32 - 10798

Fits 3/8 Standard Semi chisel chain. Used with 7/32" file.

Order No. 32 - 10802

Fits .325 Semi Chisel chain. Used with 3/16" file.

Order No. 32 - 10799

Fits 3/8 Standard Chisel chain. Used with 7/32" file.

Order No. 32 - 10803

Fits .325 Chisel chain. Used with 3/16" file.

Order No. 32 - 10800

Fits 3/8 Chisel chain. Used with 7/32" file.

Order No. 32 - 10804

Fits 3/8 Lo Pro chain. Used with 5/32" file.

CARLTON
Chain Reel Holder



32

TOOLS

Order No. 32 - 10919

Carlton chain reel holder handles reels when making up chain loops. The unit adapts to all chain reels through 1/2" pitch.



Grinding Wheel Dressers

Order No. 32 - 4237

Wheel dresser for shaping and grinding wheels.



Order No. 32 - 4238

Replacement wheel for dresser.



Order No. 32 - 4239

Dressing brick - 1" x 1" x 6".

Grinding Wheels
(Roundface)



Order No.	Diameter		Size Bore		Thickness	Application	Chain Pitch
32 - 4230	4	x	3/8	x	1/8	Bell, Nielsen	1/4", .325", 3/8", mini
32 - 4231	4	x	3/8	x	5/32	Bell, Nielsen	
32 - 4232	4	x	3/8	x	3/16	Bell, Nielsen	3/8", .354", .404"
32 - 4234	4	x	3/8	x	1/4	Bell, Nielsen	depth gauge
32 - 4802	5	x	1/2	x	1/8	Foley-Belsaw	1/4", .325", 3/8", mini
32 - 4803	5	x	1/2	x	3/16	Foley-Belsaw	3/8", .354", .404"

Chain Saw Tools
Chain Rivet Spinner

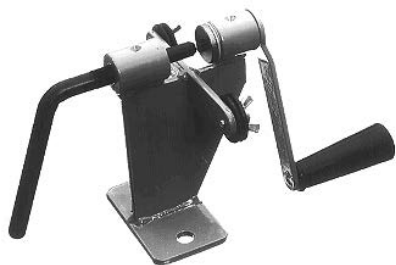

Order No. 32 - 4260

Professional, heavy duty, rivet spinner assembled with handle. Fastest method of assembling chain. Comes with our 32-4272.

Handle

Order No. 32 - 4270

For rivet spinner 32-4260.

Anvil Heads

Order No. 32 - 4271

For 32-4260. 1/4", 3/8" LP. Anvil Head (small).

Order No. 32 - 4272

For 32-4260. .404 and Std. 3/8". Anvil Head (large).

Saw Chain Breaker



Order No. 32 - 4265

Professional, powerful, heavy duty fast lever action for punching out rivets in saw chains. Breaks all sizes of chain. Bench mounted.

Parts Available:

Order No.

32 - 4266

32 - 11465

32 - 4267

32 - 4268

32 - 4269

Item

Punch for 32-4265.

Punch for 32-4265

For .043 Gauge Chain

Handle for 32-4265.

Set Screw for 32-4265.

Anvil, adjustable.



TOOLS

Filemate



Order No. 32 - 4245

The incomparable four-in-one tool for all makes and models of chain saws. Four chain depth gauge settings. File guide for right and left hand cutters. Gauge for checking bar groove depth and bar groove cleaner.

Pocket Chain Breaker



Order No. 32 - 1563

- Six-Way saw chain repairing tool.
- Heat treated steel anvil and punch to make on the job saw chain repairs when chain parts break, become damaged or worn.
- Designed with six channels to accommodate all chain sizes from 1/4" thru 1/2" pitch.
- Chain parts easily removed by placing damaged section of chain over correct anvil and punching out rivets.

Break-N-Mend

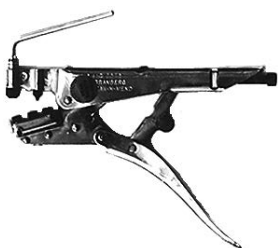

Order No. 32 - 4281

Adjustable anvil to 1/2". Chain breaking and spinning tool for chain saw chain.

Chain-Bar Checking Tool

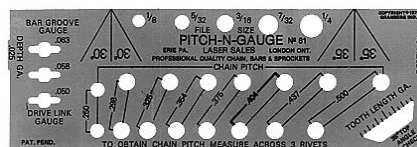

Order No. 32 - 4248

- Checks 8 chain and bar measurements.
- | | |
|------------------------|------------------------|
| No. 1-35° Filing Angle | No. 5-Drive Link Gauge |
| No. 2-Check File Size | No. 6-Tooth Length |
| No. 3-Bar Groove Gauge | No. 7-Pitch of Chain |
| No. 4-Depth Gauge | No. 8-30 File Angle |

Grinding Wheel Lubricant

Order No. 32 - 4813

Kool Grind Lubricant. Coats and lubricates the grinding stone. Prevents clogging and glazing. Increased grind-stone life. Simply hold stick to stone for a second every 2 or 3 teeth sharpened. Noticeably cooler and faster sharpening.

MIN005



Oil Suction Gun



Order No. 32 - 9057

An all-purpose filling and draining unit. Use where a fluid lubricant is required. Durable steel construction. 15" flex hose gets into hard to reach places. 20 oz. capacity.

32

TOOLS



Power Extractor



Order No. 32 - 12022

Power Extractor model 1708. The Motive Products Power Extractor allows easy evacuation of engine oil, transmission fluid, other vehicle fluids. Also works as a vacuum bleeder. Pumping the integrated hand pump creates a vacuum in the tank and fluid is extracted. 10 qt. capacity.

EZ Lift Rider Ramps from BLITZ



Order No. 32 - 12823

The new EZ Lift Rider Ramps make mower maintenance EZ! Innovative design provides 6" of lift with unobstructed access for FAST blade removal, oil changes, and more. Features include skid resistant feet and grip points for use on concrete or grass. Compact hanging or stackable storage. Lightweight for easy use and transport. Made of durable, rust-proof materials. Holds 500 lbs per pair. NOT FOR VEHICLE USE. Unit Dimensions: 11" x 16.50" x 30"

Heavy Duty Grease Gun



Order No. 32 - 12858

Heavy duty lever action grease gun.

Pistol Grip Grease Gun



Order No. 32 - 12929

Heavy duty pistol grip grease gun.

Grease Gun Adapter for Sprocket Nose



Order No. 32 - 9018

Grease gun adapter for sprocket nose. Used with our 32-1727 & 32-6661 Grease Guns. MIN005

Grease Gun



Order No. 32 - 6661

Lever Action Grease Gun. Uses 14 oz. grease cartridge or can be bulk loaded.

12" Flexible Extension for Lube Gun



Order No. 32 - 5895

12" Flexible Extension for our Lube Gun Kit 32-1727 and our 32-6661 Grease Gun. 1/8" Thread.

Grease Gun Coupler



Order No. 32 - 9905

Grease gun coupler for our 32-6661 & 32-1727 grease guns.

32

TOOLS

TOOLS



"00" Grease



Order No. 32 - 7814

Use this 5 gallon bulk container of "00" grease. To apply larger amounts of grease faster and easier.

HV-350 Sealant/Adhesive from VALCO



Order No. 32 - 12492

HV-350 is a one-part, multi-purpose adhesive that virtually outperforms any glue, epoxy, silicone on the market. The "HV" stands for High Vibration, it can be stretched up to 600 percent of original length, max temp is 350° fahrenheit. Use to attach plastic and carbon parts. Can be sanded and painted. In its cured state, the sealant maintains adhesive and sealant properties in submerged water. 3.35 oz.

PB Blaster Penetrating Oil



Order No. 32 - 8824

PB Blaster is a powerful, concentrated penetrant frees rusted or frozen parts by releasing the surface tension that causes parts to stick. Lubricates to protect against future rust and corrosion. 12 per case. **Sold Individually.** (12 oz. can)

WD-40



Order No. 32 - 14143

WD-40, 11 oz Smart Straw can.

Order No. 32 - 14144

WD-40, 14.5 oz, Commercial size.

WD-40 Specialist Penetrant



Order No. 32 - 14145

WD-40, Specialist Rust Release Penetrant 11 oz. Frees corroded nuts, bolts. Penetrates rust, fast acting, smart straw for precise application. Features Blue Torch Technology. Superior performance (29% faster) vs. PB Blaster on the nail climb test.

Carburetor & Choke Cleaner from GOLD EAGLE



Order No. 32 - 13041

Carburetor & Choke Cleaner. 12.5 oz.

32

TOOLS



Mechanic In A Bottle (1 Gallon)



Order No. 32 - 14211

Mechanic In A Bottle Professional Strength by B3C Fuel Solutions 1 (128 oz.) Gallon container. Removes heavy varnish deposits from fuel system components. Removes heavy carbon deposits from combustion chamber. Conditions rubber and plastic parts. Boosts octane level.

Gasoline Test Kit and Display



Order No. 32 - 14213

B3C Fuel Solutions Display and Test Kit. This display contains 24 Mechanic In A Bottle (4oz.), 24 Ethanol Shield (4oz.), 8 Ethanol Shield (16 oz.) 1 educational poster (18" x 244"), and a bonus of 12 (5 pack) test kits. Also included is 1 gallon of professional strength Mechanic In A Bottle and a complete diagnostic kit that contains 7 easy tests that can be performed to quickly identify fuel related problems.

Alcohol Fuel Tester



Order No. 32 - 12800

Tiny tester alcohol content tester. This handy tester will let you know approximately how much alcohol is present in gasoline. This is also a very good shop tool to determine engine failure reasons.

Fuel Test Swab from B3C Fuel Solutions



Order No. 32 - 14429

Fuel test swab from B3C fuel Solutions.

Ultrasonic Carburetor Cleaner



Order No. 32 - 13659

Ultrasonic cleaning is based on the cavitation effect caused by high frequency ultrasonic wave vibration signals in fluid. Microscopic bubbles are formed, and they implode violently causing the cavitation which creates an intense scrubbing action on the surface of the item being cleaned. 7" x 6-1/2" x 9-3/4". (Net Price)



Order No. 32 - 13660

Ultra sonic cleaning solution concentrate. No solvent or VOC content, non-petroleum based. 1 gallon makes 5 gallons of cleaning solution.

TOOLS



Bugs-B-Gone from Sea Foam



Order No. 32 - 12226

Bugs-B-Gone, removes dead bugs from your vehicle. Quick & Easy. Environmentally safe product, contains no petroleum distillates or ammonia. Non-abrasive and will not harm paint. 16 oz. MIN012

SEA FOAM Spray



Order No. 32 - 13222

Sea Foam spray is for internal engine use only to clean carbon deposits from intake systems, intake valves and combustion chambers of your engine. Use Sea Foam spray to clean all these areas with the cleaning tube and hook guide tool inserted into a sealed air intake system. Spray Sea Foam into the engine from in front of the throttle plate. Sea Foam spray can be used to clean gum and varnish from a 2 cycle engine. Run engine and spray. (SS14) MIN012

Deep Creep from Sea Foam



Order No. 32 - 12225

Deep Creep from Sea Foam. Cleans, penetrates and lubricates. Penetrates rusted parts. Cleans and lubricates air tools, guns, door locks, pulleys, hinges, wheels and much more. 12 oz. spray can. **Has been reformulated to meet all National VOC Regulations.** MIN012

Trans Tune from Sea Foam



Order No. 32 - 12224

Trans Tune, automatic transmission and power steering tune up. Cleans gum and varnish, smooths rough and erratic shifting. Auto-trans flush, power steering and rack and pinion flush, cleans, dries hydraulics. 16 oz. MIN012

Motor Treatment from Sea Foam



Order No. 32 - 12255

Motor treatment from Sea Foam. 1 gallon. MIN004

PLUG-ALL



Order No. 32 - 9774

Plug-All & Vacuum & Fuel Line Stoppers. Stepped design plugs fit all 1/8", 3/16", 1/4", 5/16", 3/8" and 1/2" hoses. Tapered caps close tubes from 1/8" to 1/2". Great for use during tune-ups.

32

TOOLS



Garage D.O.G.G. Cleaner



Order No. 32 - 12578

Dissolves dirt, oil, grease, grime on most outdoor equipment. Works quickly without scrubbing, and robbing grime from equipment. Spray nozzle allows spraying upside down for hard to reach area's.

Garage D.O.G.G. Shield



Order No. 32 - 12579

Dirt, Oil, Grease, Grime wont stick to this formula. Spray on formula dries quickly, clear, producing a non-stick coating that last. Spray nozzle allows spraying upside down for hard to reach area's.

Chain Lube from CHAMPION



Order No. 32 - 13374

Champion chain lube, 14oz. Professional grade, lithium grease spray that works in all types of weather. Will no harm metal, metal alloy, non-metal plastic chain/gear sets.

Battery Corrosion Protector from BTS



Order No. 32 - 12409

Battery corrosion protector from BTS. Coats, penetrates and protects terminals, cables and connectors. Protects against acid corrosions and moisture. 11 oz. bottle.

Belt Dressing from BTS



Order No. 32 - 12408

Belt Dressing from BTS. Stops squeals, prevents slippages, extends life 10.5 fl. oz. bottle.

Battery Cleaner from BTS



Order No. 32 - 11458

Battery Cleaner & Acid Leak Detector. Removes Corrosion, Acid & Dirt deposits from terminals, clamps & connectors. Yellow cleaning foam turns red when it locates acid leaks. 15 oz. spray.

Foam Filter Spray Oil from UNIFILTER



Order No. 32 - 11222

Foam filter spray oil from Unifilter. 5.5 oz.

Rotary/Torco "OO" & EP-O Semi Fluid Grease



Order No. 32 - 9452

"OO" & EP-O semi fluid grease for chain saw tips, sprockets, trimmer heads, gear cases. 4 oz. bottle.

TOOLS



**Copper Anti-Seize from
BTS**



Order No. 32 - 11462

Copper anti seize. Reduces friction, wear & Torque. Eases assembly & disassembly. 8 oz bottle.

**Carburetor & Choke Cleaner from
BTS**



Order No. 32 - 11460

Carburetor & Choke Cleaner quickly removes gum, dirt, varnish & carbon. Cleans & frees linkages, chokes, throttle plates & PVC valves. 12.5 oz spray can. Not CARB approved.

**Brake Parts & Metal Cleaner from
BTS**



Order No. 32 - 11453

Brake Parts & Metal Cleaner. Cleans & Degreases fast, dries fast and completely. Removes brake dust, grease, oil and brake fluid. 15 oz. spray can. Not CARB approved.

**Glass Cleaner from
BTS**



Order No. 32 - 11454

Ammonia free Glass Cleaner. Cuts oil, grease and fingerprints. Won't streak or smear. 19 oz. spray can.

**Engine Degreaser from
BTS**



Order No. 32 - 11455

Engine degreaser cleans dirty engines fast. Spray on, hose off. Quickly penetrates grease, oil & sludge. 16 oz. spray can.

**Silicone Spray from
BTS**



Order No. 32 - 11461

Silicone spray synthetic lubricant. Lubricates, protects, seals, repels water, stops squeaks. Protects against rust and corrosion. 10 oz. spray

**White Grease from
BTS**



Order No. 32 - 11456

White lithium grease. Reduces friction and wear. Withstands high & low temperatures. 12 oz. spray.

**PT- 1 Penetrating Oil from
BTS**



Order No. 32 - 11457

PT-1 Fast penetrating oil. Attacks rust & corrosion. Loosens & frees rusted nuts, bolts and frozen mechanisms. 12 oz spray.

**Threadlocker from
BTS**



Order No. 32 - 11459

Medium strength treadlocker. Locks and seals threads. (Blue) Fasteners 1/4" to 3/4", .34oz carded.

Order No. 32 - 12406

Blue threadlocker from BTS. 1.69 fl. oz.(50ml) bottle. Fasteners 1/4" to 3/4". Locks and seals treads.



Order No. 32 - 11463

High strength treadlocker. Locks and seals threads. (Red) Fasteners 3/8" to 1", 1.69 oz carded.

Order No. 32 - 12407

Red threadlocker from BTS. .34 fl. oz. (10ml) bottle. Fasteners 3/8" to 1". Locks and seals treads.

32

TOOLS



Rotary/Torco High Temperature Extreme Pressure Grease



Order No. 32 - 9454

High temperature extreme pressure grease for high load & speed bearings, shafts & gears, etc. 14 oz. tube. Highly water resistant. Drop point 500 degrees +. MIN010

Rotary/Torco General Purpose Grease



Order No. 32 - 9453

General purpose grease for general chassis lubrication, low load bearings, gears & shafts. 14 oz. tube. MIN010

Disposable Nitrile Gloves from DURASKIN



Order No. 32 - 13040

Duraskin disposable nitrile glove. Size: **Medium**, powder free, textured, 5 Mil thickness, 9-1/2" length, colored black. 100 per box.

Order No. 32 - 13060

Duraskin disposable nitrile glove. Size: **Large**, powder free, textured, 5 Mil thickness, 9-1/2" length, colored black. 100 per box.

Order No. 32 - 13061

Duraskin disposable nitrile glove. Size: **XL**, powder free, textured, 5 Mil thickness, 9-1/2" length, colored black. 100 per box.

Nitrile Tough Gloves



Order No. 32 - 11636

Size Small

Order No. 32 - 11638

Size Large

Order No. 32 - 11637

Size Medium

Order No. 32 - 11639

Size X-Large

Tough and durable lightweight gloves. Trend setting performance, comfort, and versatility. The flexible nitrile coating is tougher than rubber, protecting palms and fingertips from the rigors of everyday work. Seamless lightweight black nylon knit liner increases comfort while it repels dirt and stains. Machine washable.

LAWN AND GARDEN ACCESSORIES



LAWN & GARDEN 33

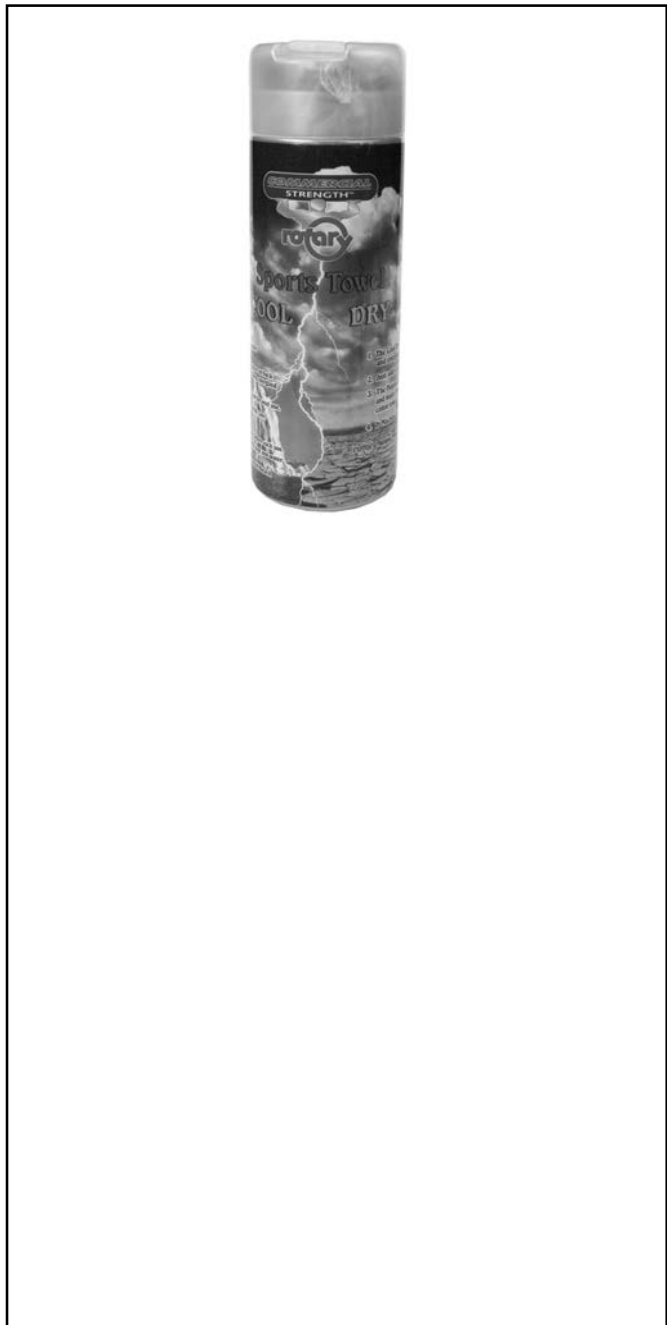
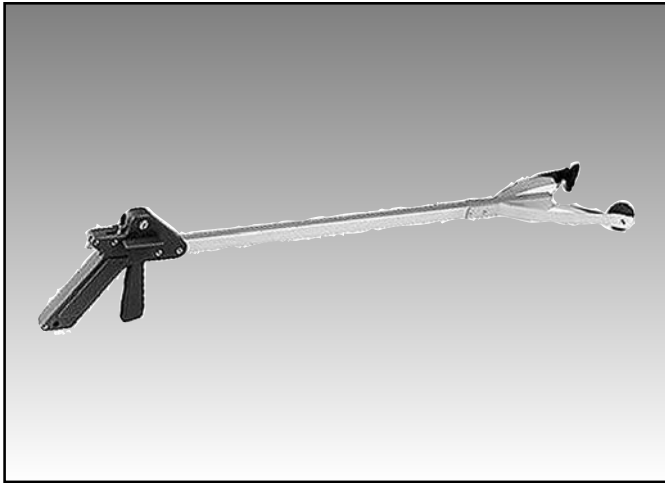

Quick-Glance

LAWN & GARDEN ACC.	PG.
Safety Sunglasses	1117-1119
Safety Glasses	1119
Dust Mask	1120
Hearing Protector	1120
Gas Cans	1120-1122
Trimmer Line Cutter	1122
Cool Dry Sports Towel	1123
Hour Meter	1123
EZ Reacher	1123
Radio	1124
Blade Balancer	1125
Tire Sealant	1126
Chain Saw Files	1127
Chain Saw Handles	1128
Gas Treatments	1129-1131
Engine Oil	1132-1133
Wrenches	1134-1135



LAWN AND GARDEN ACCESSORIES

SAFETY SUNGLASSES

CONTENTS

33
LAWN & GARDEN



Order No.	Model No.	Lens Color	Frame Color	Qty.		
33 - 11601	119	Red Revo	Orange	2		
33 - 11603	124	Clear	Fog Black	2		
33 - 11602	126	Brown	Fog Black	2		
33 - 11616	1863	Silver Mirror	Shiny Black	1		
33 - 11614	1734	Clear	Matte Black	1		
33 - 11611	421	Smoke	Fog Black	1		
33 - 11610	428	Blue Revo	Fog Black	1		
33 - 11618	541	Smoke	Crystal Black	1		
33 - 11619	548	Blue Revo	Crystal Black	1		
33 - 11606	741	Smoke	Crystal Black	2		
33 - 11608	743	Silver Mirror	Crystal Black	2		
33 - 11609	745	Yellow	Crystal Black	2		
33 - 11607	754	Clear	Crystal Black	2		
33 - 11625	828	Blue Revo	Black	2		
33 - 11624	844	Clear	Crystal Black	2		
33 - 11626	873	Silver Mirror	Orange/Black	2		
33 - 11623	921	Smoke	Fog Black	2		
33 - 11622	924	Clear	Fog Black	1		
33 - 11612	23233	Silver Mirror	Shiny Black/Red	1		
33 - 11613	3469	Red Mirror	Shiny Black	1		
33 - 12557	181212	Gold Revo	Emerald Pearl	1		
33 - 11621	9117	Brown/Mirror	Liquid Brown	2		
33 - 11620	9610	Green Revo	Shiny Black	2		
33 - 11627	91351	Clear Anti-Fog	Soft Touch Black	3		
33 - 11628	G3	Neck Cords	Adjustable	3		
33 - 11629	G4	Neck Cords	Adjustable	3		

Kit shown above. You must Order Part No's 32-11631 & 32-11630

Order No. 33 - 11631

Assortment of 36 safety sunglasses, 3 goggles & 6 neck cords. Display Not Included.

PRODUCT FEATURES:

- Crafted of high-grade nylon material
- Ultralight, flexible frame design for comfort fit.
- Comfort fit rubber nose piece
- Meet and exceed ANSI Z87+ specifications
- Lenses provide 99.9% protection from harmful UVA and UVB rays

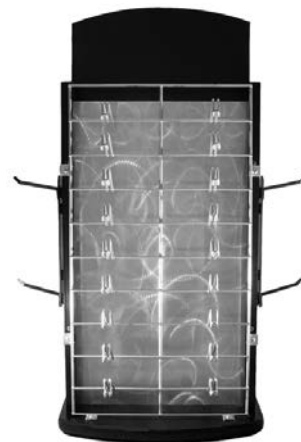

Order No. 33 - 11630

Safety sunglass display rack only.

LAWN AND GARDEN ACCESSORIES



33
LAWN & GARDEN

SAFETY SUNGLASSES

Order No. Model & Description



- 33 - 11614 Model 1734/Clear Lens, Black Frame
- 33 - 11616 Model 1863/Silver Mirror Lens, Shiny Black Frame



- RECON**
- 33 - 11624 Model 844/Clear Lens, Foam Protector, Crystal Black Frame
 - 33 - 11625 Model 828/Black-Blue Revo Lens, Foam Protector, Black Frame
 - 33 - 11626 Model 873/Silver Mirror Lens, Foam Protector, Orange/Black Frame



- SHIELD**
- 33 - 11618 Model 541/Smoke Lens, Foam Protector, Crystal Black Frame
 - 33 - 11619 Model 548/Blue Revo Lens, Foam Protector, Black Frame



- SNIPER**
- 33 - 11620 Model 9610/Green Revo Lens, Shiny Black Frame
 - 33 - 11621 Model 9117/Brown Flash Mirror Lens, Liquid Brown Frame
 - 33 - 11622 Model 924/Clear Lens, Fog Black Frame
 - 33 - 11623 Model 921/Smoke Lens, Fog Black Frame



- TALON**
- 33 - 11601 Model 119/Red Revo Lens, Orange Frame
 - 33 - 11602 Model 126/Brown Lens, Fog Black Frame
 - 33 - 11603 Model 124/Clear Lens, Fog Black Frame

Order No. Model & Description



- VIPER**
- 33 - 11606 Model 741/Smoke Lens, Black Crystal Frame
 - 33 - 11607 Model 754/Clear Lens, Crystal Frame
 - 33 - 11608 Model 743/Silver Mirror Lens, Black Crystal Frame
 - 33 - 11609 Model 745/Yellow Lens, Black Crystal Frame



- VISION**
- 33 - 11610 Model 428/Blue Revo Lens, Fog Black Frame
 - 33 - 11611 Model 421/Smoke Lens, Fog Black Frame
 - 33 - 11612 Model 23233/RPG Insert, Smoke Lens, Fog Black Frame
 - 33 - 11613 Model 3469/KP6 Insert, Red Lens, Fog Black Frame



- YUKON**
- 33 - 12557 Model 6912/Gold Revo Lens, Velvet II Black/ Orange Frame



SAFETY GOGGLES

- 33 - 11627 Model 91351/Clear, Anti Fog Lens, Soft Touch Black Frame



Neck Cords

- 33 - 11629 G4 Adjustable Cord 3/16" woven, Assorted Colors
- 33 - 11628 G3 Adjustable Cord



Crossfire Goggles



Order No. 33 - 13351

Crossfire Element Goggles, smoke lens. Anti fog, soft touch black.

XTS Safety Glasses



Order No. 33 - 9459

XTS safety glasses. Hard coated, polycarbonate lens. Clear.

Order No. 33 - 9460

XTS safety glasses. Hard coated, polycarbonate lens. UV & blue light protection. Gray.

Safety Glasses



Order No. 33 - 9076

Light weight safety glasses. Special SCRATCH RESISTANT HIGH IMPACT PLASTIC. Protects eye glasses and eyes. Fits comfortably over glasses, made by a top name in safety.

**Elvex Safety Glasses
(Clear) Uniwrap**



Order No. 33 - 8618

Clear lens, dark blue frame safety glasses.

Clear lens safety glasses. Lens made from impact resistant polycarbonate, provides 99% UV protection and is silicon hard-coated for extended life span.

Safety Sunglasses



Order No. 33 - 11616

Core Crossfire, Silver Mirror Lens Safety Sunglasses, shiny black frame, heavy duty.



Order No. 33 - 11617

Core Crossfire Blade, Brown Flash Mirror Lens Safety Sunglasses, brown temple, heavy duty.



Order No. 33 - 12437

Core Green Camo W/Smoke Lens Safety Sunglasses, heavy duty.



Order No. 33 - 12438

Core Woodland Brown Camo Safety Sunglasses, heavy duty.

LAWN AND GARDEN ACCESSORIES



33
LAWN & GARDEN

Corded Foam Ear Plugs



Case Quantity 100

Order No. 33 - 7729

These corded ear plugs are ideal for use with outdoor power equipment and have a noise reduction rating of 29 decibels. The range of noise reduction ratings of existing hearing protectors are approximately 0 to 30. (higher numbers denote greater effectiveness).

Hearing Protector



Order No. 33 - 9393

Hearing protector from Elvex. Noise reduction rating of 25 decibels when used as directed.

Hearing Protector



Order No. 33 - 11957

Folding Ear Muff Hearing Protection. 19db noise reduction.

Dust Mask



Order No. 33 - 12684

Disposable dust mask, non toxic. General purpose protection against nontoxic nuisance dusts and mists. Preformed nose design and soft, nonwoven material ensure a tight, comfortable fit with elastic strap. 50 per box. MIN005

Justrite Type 1 Metal Safety Gas Can

Order No. 33 - 11992

Justrite type 1 safety gas can 2 gallon with funnel. Individually boxed. CARB compliant.

Order No. 33 - 11993

Justrite type 1 safety gas can 5 gallon with funnel. Replaces Kubota 77700-01541. Individually boxed. CARB compliant.

Order No. 33 - 11994

Funnel spout for safety gas can. Replaces Kubota 77700-01543.

Justrite Type 1 Safety Gas Can. Heavy-duty, high grade coated steel construction with reinforcing ribs to strengthen side-walls to resist chemicals and stand up to heavy abuse. Single spout for filling and pouring. Self-closing, leak-proof lid and a swinging handle for carrying heavier loads. Counterbalanced ergonomic design with fullfisted grip handle offers gravity-assisted pouring. All models are equipped with an FM tested dual density flame arrester, which dissipates heat to stop flashback ignition. Positive pressure relief mechanism automatically vents between 3 and 5 psig. Meets OSHA and NFPA requirements, is certified by FM, UL, ULC.





No-Spill Fuel Containers

PRODUCT FEATURES:

- Thumb button control for precise pouring.
- Stainless steel screen to filter debris.
- Designed to empty completely.
- Translucent body, for visual fuel level.
- Quart and liter markings for reference.
- Specially treated body for low permeation.
- Wide, stable base to reduce upsets.
- Attached dust cover keeps spout clean.



1-1/4 Gallon



2-1/2 Gallon



32-13636 (Newer Style)



5 Gallon



5 Gallon Diesel



32-13634 (Older Style)



32-13635 (Spout)

Order No. 33 - 13459

No-Spill 1-1/4 Gallon Gas container. (Net Price)

Order No. 33 - 13460

No-Spill 2-1/2 Gallon Gas container. (Net Price)

Order No. 33 - 13461

No-Spill 5 Gallon Gas container. (Net Price)

Order No. 33 - 13453

No-Spill 5 Gallon Diesel Fuel container. Yellow. (Net Price)

Order No. 33 - 13636

No-Spill Nozzle Assembly. Fits our 32-13453, 32-13459, 32-13460, 32-13461. Newer style nozzle (2011-up). (Net Price)

Order No. 33 - 13634

No-Spill Nozzle Assembly. (2010 & previous production) Older style nozzle. (Net Price)

Order No. 33 - 13635

No-Spill 6" Flexible Spout Extension. Fits our 32-13453, 32-13459, 32-13460, 32-13461 containers. (Net Price)

No-Spill fuel containers advance convenience and quality in gasoline-can design by reducing emissions of hydrocarbons from evaporation, permeation and spillage. This helps protect the environment as well as saves you on fuel cost due to waste. Each container is molded from fluorinated, high molecular weight material for low permeation. Complies with both EPA and CARB requirements. Meets California Air Resource Board Phase II requirements for sale or use in California. Tested and certified to ASTM F-852-99.

Midwest Gas Cans

Order No. 33 - 14293

1 Gallon Midwest gas can is made of durable HDPE with barrier materials to virtually eliminate hydrocarbon emissions. Holds 1 gallon & 4 oz. of your gas and oil mixes and exceeds California Air Resource Board (CARB) and EPA requirements for portable fuel containers. 7.50" x 5.25" x 9.5". 12 per case.



Order No. 33 - 14294

2+ Gallon Midwest gas can is made of durable HDPE with barrier materials to virtually eliminate hydrocarbon emissions. Holds 2 gallons & 8 oz. of your gas and oil mixes and exceeds California Air Resource Board (CARB) and EPA requirements for portable fuel containers. 9.25" x 7.75" x 9.75". 6 per case.



Order No. 33 - 14295

5+ Gallon Midwest gas can is made of durable HDPE with barrier materials to virtually eliminate hydrocarbon emissions. Holds 5 gallons of your gas and oil mixes and exceeds California Air Resource Board (CARB) and EPA requirements for portable fuel containers. 12.50" x 9.75" x 14". 4 per case.



Order No. 33 - 14342

Replacement spout kit for use with all Midwest Gas Cans. 4.75" x 11", 12 per case.



Trimmer Line Cutter



Order No. 33 - 12820

Trimmer line cutter, "Patented", simple to use and safe with no exposed cutting edges. Put on your keyring and have ready when it is time to refill your trimmer. Cuts trimmer line from .065 to .130 in diameter. MIN010



G4 DOT Reacher



Order No. 33 - 10432

32" G4 DOT Reacher Model 2533. Uses our 32-10431 replacement cups. MIN006

Order No. 33 - 10648

48" G4 DOT Reacher Model 2548. MIN006

Order No. 33 - 10640

40" G4 DOT Reacher Model 2540. Uses our 32-10431 replacement cups. MIN006

Order No. 33 - 10431

G4 DOT Reacher replacement cups. Cups for our 32-10432 & 32-10640 G4 DOT Reacher. (Pack of 2)

A favorite of Highway departments around the world. Industrial quality lightweight pick-up tool. Lightweight aluminum shaft, high impact plastic handle, rubber cups that can pick up a penny or brick. Heavy duty, durable and light weight.

60" Folding G4 DOT Reacher



Order No. 33 - 12404

60" Folding G4 DOT Reacher. MIN006

Cool Dry Sports Cooling Towel

Order No. 33 - 13439

Cool dry sports cooling towel. PVA chamois with reinforced mesh, both sides smooth. Large 27" x 17".

Order No. 33 - 13438

Cool dry sports cooling towel. PVA chamois with reinforced mesh, both sides smooth. Small 17" x 13".



Hour Meter



Order No. 33 - 9359

Tach/Hour meter. Records actual running of engine. Non-erasable. Shows engine RPMs (Read up to 9,000 RPMs). Alerts you to Lube (grease) & Change Oil (25 hour intervals). No battery required, triggered from the spark plug wire.

Sendec Digital Hour Meter



Order No. 33 - 10408

Sendec digital hour meter. Small panel mount. Used on several riders. Replaces AYP 169642, 177501, 110940X.

LAWN AND GARDEN ACCESSORIES



33

LAWN & GARDEN

JENSEN Heavy Duty Radio



Order No. 33 - 12386

JENSEN all weather heavy duty AM/FM MINI RADIO. Model JHD910. Complete waterproof AM/FM Radio. 7-Channel NOAA Weatherband & Weather Alert. Front panel audio aux-in for use with iPods, MP3 players, & portable CD players. Jobsite work timer. 30 day internal memory. Green & Amber backlighting. 2-Channel amplified audio output. Standard "L" mounting bracket included. 12VDC Power, no batteries required. Size 5-3/16" W x 3-3/8" H x 1-7/8" D.

JENSEN Heavy Duty Speakers



Order No. 33 - 12387

JENSEN all weather heavy duty speakers. Model JXHD35. Used withour 32-12386 radio. Offering full range audio reproduction, easy mounting options, and UV resistance.

JENSEN Heavy Duty Antenna



Order No. 33 - 12388

JENSEN all weather heavy duty antenna. Model 1181039. Used withour 32-12386 radio. This 14.15" rubber mast top/side mount antenna, prevents breakage associated with normal metal mast antennas and the mounting base adjusts a complete 90° for either top or side mounting.

Audio-Vox Heavy Duty Headphones



Order No. 33 - 12390

Audio-Vox all weather heavy duty headphones. Model OEMHP1. Used withour 32-12386 radio. These fully padded headphones are equipped with a flexible coiled cord with 1/4" phono plug, adjustable left-right level controls, and an adjustable headband.

JENSEN Roll Bar Mounting Kit



Order No. 33 - 12392

JENSEN (ROPS) Roll Bar Mounting Install Kit for JENSEN Radio. Used withour 32-12386 radio. Universal bracket clamps onto all standard ROPS roll bars. Brackets include provisions for antenna and speaker mounting. Includes wiring harness, hardware, and instructions.



**Economy
Blade Balancer**



Order No. 33 - 827

Economy Blade Balancer Display. (24 pcs.)

Order No. 33 - 1756

Economy Blade Balancer (individual). Made of zinc die cast G30.

Universal Blade Balancer



Order No. 33 - 8316

Universal blade balancer. Made of derlin plastic.

**Blade Sharpening
Grinding Wheel**



Order No. 33 - 2677

Fits any 1/4" or 3/8" electric drill. With nylon guide.

Tie Down Straps



**Order
No.**

Size

33 - 1745	10"
33 - 1746	15"
33 - 1747	21"
33 - 9091	31"
33 - 10818	41"

Plastic Wedges



Order No. 33 - 12597

12" Falling wedge

Order No. 33 - 4240

10" Falling wedge

Order No. 33 - 4241

8" Falling wedge

Order No. 33 - 4242

5-1/2" Falling / Bucking wedge

The professional falling and bucking wedge. Features include horizontal slots on one side to ensure straight, smooth guidance into the kerf and a double row of non-grip barbs on the reverse side to guard against splitting back of the wedge. Excellent super tough plastic composition resists chipping and breakage even in frozen hardwood.

Riding Mower Cover

Order No. 33 - 13094

Deluxe Riding Mower & Tractor Cover. 78" x 30" x 48" dark green color. Protects riding mower or tractor against wind, rain, snow, sun, dust and dirt damage. Also fits some grills and motorcycles. Heavy duty tear resistant high density woven polyethylene material. 4 per case.



LAWN AND GARDEN ACCESSORIES



33

LAWN & GARDEN

Rotary Tire Sealant Pump



Order No. 33 - 10346

Dispensing pump used with our 32-10328, 1 gallon tire sealant. Injects 1 oz. per pump.

Rotary Tire Sealant 1 Gallon



Order No. 33 - 10328

Tire sealant seals punctures up to 3/8" in tread area instantly and permanently while you ride. 1 Gallon.

Tire Sealant 16oz. Bottle



Order No. 33 - 8502

Tire sealant, seals punctures up to 3/8" in tread area instantly and permanently while you ride. Guaranteed effective for the life of the tire. 12 per case (16 oz. bottle).

Tire Sealant 32oz. Bottle



Order No. 33 - 7762

Installs in minutes, prevents dry rot, corrosion and under inflation from slow leaks. Used on golf carts, riding mowers, wheelbarrows, go-karts, ATV's, small tractors, lawn tractors and farm tractors. Seal punctures up to 3/8" in tread area instantly and permanently while you ride. Guaranteed effective for the life of the tire. 12 per case (32 oz. bottle).

Slime Tire Sealant

Order No. 33 - 9212

Slime tire sealant. (16 oz. bottle)

Order No. 33 - 9215

Slime tire sealant. (32 oz. bottle)



Order No. 33 - 10909

1 Gallon of Slime tire sealant with pump. 4 per case.

New Non-flammable Formula

Order No. 33 - 6668

Quickly seals and inflates tires. Will fix most normal punctures and rim leaks without need to remove tire. Easy to use. 12 per case. **Sold Individually. With hose.** (14 oz. can)





LAWN AND GARDEN ACCESSORIES

33
LAWN & GARDEN

12" Cut-Off Saw Blades

ID 1"
OD 12"
Thickness 1/8"



Order No.	Description
33 - 8230	12" Cut-off saw blade for stone
33 - 8231	12" Cut-off saw blade for metal

14" Cut-Off Saw Blades

ID 1"
OD 14"
Thickness 1/8"

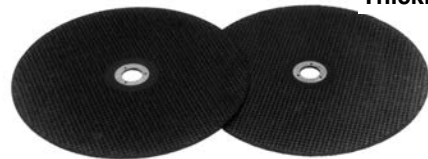

Order No.	Description
33 - 8232	14" Cut-off saw blade for metal
33 - 8233	14" Cut-off saw blade for stone

Bushing for Cut-Off Saw Blades

Order No. 33 - 8234

20mm bushing for cut-off saw blades. Bushing for our 32-8230 cut-off saw blades. MIN010



Premium Saw Chain Files
(Pferd Brand)

Order No.		Chain Size	Dimensions (round)
33 - 1559	MIN006	3/8" L.P.	5/32" x 8"
33 - 1560	MIN006	.325"	3/16" x 8"
33 - 1561	MIN006	3/8"	7/32" x 8"
33 - 1562	MIN006	.404"	1/4" x 8"
33 - 1564	MIN006	.354"	13/64" x 8"



Precision manufactured of tough chrome alloy steel. Cut design assures maximum file life. The choice of professionals. Packaged in boxes of 1/2 dozen.

Rapid Filer

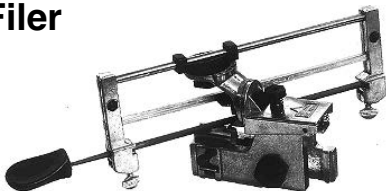

Order No. 33 - 4282

Super rapid filer eliminates the guess work in hand filing. Sharpens saw chain right on the bar. The correct cutter angle and depth gauge height are obtained from accurate, simple dial adjustments. Sharpens all pitches of chain 1/4" to 1/2". Accommodates 6" or 8" round files.

6" Flat Depth Gauge File



Order No. 33 - 4013

Finest steel-smooth edges.

MIN003

Grinding Stones
(Threaded)

Order No.		Size
33 - 4817	MIN005	5/32
33 - 4818	MIN005	3/16
33 - 4819	MIN005	7/32



To fit all DREMEL, GRANBERG, OMARK and SAWTUNE Chain Sharpening Tools. (5 of one size in a pkg.)

LAWN AND GARDEN ACCESSORIES



33
LAWN & GARDEN

Universal Plastic File Handle



Order No. 33 - 12058

Universal small orange plastic file handle.

Order No. 33 - 12059

Universal medium orange ribbed plastic file handle.

Plastic File Handle



Order No. 33 - 9042

Plastic handle for chain saw files. Has a compartment in handle to store a spark plug.

Wood File Handle



Order No. 33 - 4015

High quality, hardwood file handles with wire bound ferrule. Self-adjusting to file tang. Cannot work loose. Guaranteed not to split under normal use. 7/8" dia. x 3-1/2" length. 11 oz. per dozen. MIN012

File Holder



Order No. 33 - 4246

The world's best one piece holder. Solid yet lightweight and well balanced for the professional and part-time woodcutter.

Grease Gun



Order No. 33 - 4273

For sprocket nose or roller nose bar bearings. Uses light or heavy grease.

Metal Grease Gun



Order No. 33 - 5801

Grease Gun for sprocket nose bars.

Order No. 33 - 5802

Replaceable tip for grease gun.

Lube Gun Kit



Order No. 33 - 1727

The ultimate in compact, cartridge-loading grease guns. Contains the gun and one cartridge with a high quality, performance proven lithium grease.

Lube Loads



Order No. 33 - 1728

Contains 4 cartridges with approximately 3 ounces of grease each. Used with our 32-1727 Lube gun. MIN004



"OO" Grease

Order No. 33 - 9089

For use in all outdoor power equipment where a "OO" Grease is recommended. 1 quart bottle. 12 bottles per case. Snapper 7011050. **Sold in case lots.** MIN012



Order No. 33 - 19088

Rotary "OO" Grease packaged in an easy to use container. For use in all outdoor power equipment where a "OO" grease is recommended. 9 oz. tube. 12 per case. **Sold Individually.**

Sno-Jet



Order No. 33 - 9983

Sno-Jet helps solve the age-old problem of wet snow sticking. Use it on snowblowers, shovels and snow plow blades. 12 per case. **Sold Individually.** (11 oz spray can).

Mo-Deck



Order No. 33 - 9982

Mo-Deck is specially formulated to be sprayed on the under surfaces of all types of mowers to help prevent clipping buildup and clogging. This helps the mower cut cleanly and efficiently, saving fuel and wear and tear. 12 per case. **Sold Individually.** (11 oz spray can).

Hydrostatic Transmission Fluid



Order No. 33 - 11589

Hydrostatic Transmission Fluid. 15w-50wt. Synthetic

Motor Treatment from Sea Foam



Order No. 33 - 12223

Sea Foam motor treatment. For gas, diesel & small engine applications. 100% pure petroleum. Stabilizes fuels, cleans carbon & fuel injectors. Removes moisture in fuel & oil. Oxygen sensor safe. 16 fl. oz. MIN024

Ethanol Shield

16 oz.



Order No. 33 - 14212

Ethanol Shield by B3C Fuel Solutions (16 oz.) bottle. Ethanol Shield protects your entire fuel system from the harmful effects of ethanol blended fuel as well as clean varnish and carbon deposits from the fuel tank to the tailpipe! Ethanol Shield treats the problem not the symptom. Each bottle treats 160 gallons of fuel. 9 Bottles per case.

Order No. 33 - 12794

Sea Foam motor treatment. For gas, diesel & small engine applications. 100% pure petroleum. Stabilizes fuels, cleans carbon & fuel injectors. Removes moisture in fuel & oil. Oxygen sensor safe. 16 fl. oz. 12 pk MIN012

LAWN AND GARDEN ACCESSORIES



33
LAWN & GARDEN

**PRI-G
Gasoline Treatment**

PRI-G preserves fuel freshness, restores stale fuels, prevents carbon build-up, provides quick starts, boosts economy & power.

Order No. 33 - 10668

PRI-G gasoline treatment. 8 oz bottle. 12 per case. Treats 20 gallons of fuel. **Sold Individually.**

Order No. 33 - 10669

PRI-G gasoline treatment. 16 oz bottle. 12 per case. Treats 256 gallons of fuel. (Concentrate) **Sold Individually.**



**Diesel Fuel Treatment from
PRI-D**



Order No. 33 - 11759

PRI-D is a super concentrated, complete fuel treatment that improves all diesel fuels and kerosene, enabling them to perform to maximum potential. 16 oz. bottle. Treats 256 gallons.

**Start Your
Engines**



Order No. 33 - 12460

Start Your Engines, fuel system revitalizer. Safe for use in 2 & 4 cycle engines up to 25hp. Freshens stale gas, ensures easy starts of power equipment. 4 oz. From the makers of STA-BIL.

Gas Stabilizer

Order No. 33 - 6663

1 qt. bottle, 12 per case. **Sold Individually.**

Order No. 33 - 6569

4 oz. bottle carded, 24 per case. **Sold Individually.**

Order No. 33 - 7096

8 oz. container, 12 per case. **Sold Individually.**

Order No. 33 - 10004

Display contains 12, 4oz. bottles.



*Gas Stabilizer. Keeps stored fuel fresh indefinitely even after prolonged storage of a year or longer.

*Prevents gum and varnish build-up that clogs fuel systems.

**Marine Fuel Stabilizer from
STA-BIL**

Order No. 33 - 12803

8 oz. bottle, 1 oz treats 5 gallons of fuel. 12/case. Treats up to 40 gallons of fuel.

Order No. 33 - 12804

32 oz. bottle, 1 oz treats 5 gallons of fuel. 6/case. Treats up to 160 gallons of fuel.



- America's #1 Selling Marine Fuel Additive Brand!
- Best Ethanol Problem Fighter
- More than (4X) the Fuel System Cleaner than in Regular STA-BIL
- Double the corrosion preventer than in Regular STA-BIL
- Prevents corrosion from moisture & ethanol-induced water attraction
- Improves marine engine performance YEAR-ROUND, not just for seasonal storage



Fuel Stabilizer from CHAMPION



Order No. 33 - 13429

Champion value added formula 8 oz. fuel stabilizer. Concentrated formula designed for all 2&4 cycle engines. Keeps gasoline and diesel fuel fresh during storage. One ounce treats 2.5 gallons. Bottle treats 20 gallons. 12 per case.

Ethanol Shield from B3C Fuel



Order No. 33 - 13412

Ethanol shield from B3C Fuel. 4 oz bottle, 12 pack. Gasoline will decay in as little as 90 days. Ethanol shield preserves gasoline, protects carburetor diaphragms. MIN012

Ethanol Treatment from STA-BIL



Order No. 33 - 13493

4 fl oz. Ethanol Treatment from Sta-bil. Treats up to 10 Gallons.

Order No. 33 - 13494

10 fl. oz. Ethanol Treatment from Sta-bil. Treats up to 25 Gallons

Stabil Ethanol Treatment. Perfect for small engines. Prevents corrosion caused by today's Ethanol blended fuels. Helps remove water from fuel, cleans carburetor's, fuel injectors, intake valves for improved performance. Use at every fill up for optimal performance and protection.

Mechanic In A Bottle from B3C Fuel



Order No. 33 - 13411

Mechanic In A Bottle from B3C Fuel. 4 oz bottle, 12 pack. On machine carburetor cleaning, contains rubber & plastic conditioners, revitalizes old fuel, carbon cleaner, octane improvement, safely dissolves varnish/shellac, fuel stabilization, high temp detergent. MIN012

Gasoline Tank Snake from B3C Fuel Solutions



Order No. 33 - 14642

Gasoline Tank Snake from B3C fuel solutions. Fuel tank water absorber plus stabilizer. Stabilizes up to 1 year. Turns blue when full of water, prevents repairs, leave in protection.

LAWN AND GARDEN ACCESSORIES



33
LAWN & GARDEN

Two-Cycle Engine Oil (Smoke Free)



Order No. 33 - 11598

48/2.6 ounce bottle (mix with 1 gallon of gas). 50:1
MIN048

Order No. 33 - 11599

36/6.4 ounce bottle (mix between 2 and 2-1/2 gallons of gas). 50:1
MIN036

Order No. 33 - 11600

24/12.8 ounce bottle (mix with 5 gallons of gas). 50:1
MIN024

Order No. 33 - 10675

4/1 gallon bottles per case.
MIN004

Synthetic Two-Cycle Engine Oil (Smoke Free)



Order No. 33 - 12568

2.6 oz, 36 piece counter display. 50:1
MIN036

Order No. 33 - 9939

48/ 100ml bottle. 50:1. 48 pieces per case.
MIN048

Order No. 33 - 9940

12/ 1 Litre bottle. 50:1
MIN012

NO SMOKE TWO STROKE 2-Cycle Engine Oil. Safe for the environment and the equipment operator because it eliminates exhaust smoke. The elimination of exhaust smoke also SIGNIFICANTLY REDUCES cylinder deposits, ring coking, exhaust port clogging, piston scuffing, plug fouling, rust and corrosion and INCREASES ENGINE LIFE. Specifically formulated for chain saws, motorcycles, lawnmowers, string trimmer, blowers and all other air cooled two cycle engines requiring 16:1, 24:1, 32:1, 40:1 or 50:1 mixing ratios.

Two-Cycle Engine Oil



Mix 50:1

Order No. 33 - 9098

Two-cycle oil for chain saws, lawnmowers, string trimmers, outboard motors, etc. This oil provides outstanding resistance to piston scuffing, bearing wear and plug fouling. 24/6.4 oz. bottles per case. **Sold in case lots.**
MIN024

Two Cycle Oil (32:1)



Order No. 33 - 14108

Two cycle oil 32:1 mix, 48/8 oz. For chain saws, lawnmowers, string trimmers, outboard motors, etc. 48/8oz. bottles per case. **Sold in case lots.**
MIN048

Rotary/Torco Fuel Stabilizer



Order No. 33 - 9457

Fuel stabilizer for gasoline & diesel fuel systems. 1 oz pillow packs. Treats 2 gallons of fuel.
MIN024



4-Cycle Lawnmower Oil



Order No. 33 - 7761

20 fl oz per bottle.(12 bottles per case). SHCO MIN012

Order No. 33 - 12958

Prem. quality 10W-30. 32 fl oz per bottle. 12 per case. MIN012

Order No. 33 - 10676

48 fl oz per bottle. 8 bottles per case.

Premium quality SAE 30 detergent blend oil. For use in all air-cooled 4-cycle engines.

2-Cycle G-Oil



Order No. 33 - 12704

2-Cycle, G-Oil, (2.6 oz.) Counter Display. 24pc. MIN024

Order No. 33 - 12705

2-Cycle, G-Oil, (50:1) 16 oz. bottle. MIN012

G-Oil, lawn and garden 2-cycle Green engine oil is patent pending superior performance 2-cycle engine oil made from American grown base oils that use the power of nanotechnology to provide ultimate protection for air-cooled 2-cycle engines. G-Oil, is the "Green Alternative" and meets API TC requirements. This No-Smoke formula contains stabilized technology to improve fuel stability in a variety of general purpose equipment and personal recreational engines including motorcycles, snowmobiles, chain saws, lawn and garden equipment. Does not utilize a solvent to increase gasoline miscibility and offers a significant safety advantage since the product has a flash point of 262 degrees F and is not classified as flammable or combustible according to OSHA or D.O.T. regulations. 100% American made.

Fuel Catalyst from Fitch

Order No. 33 - 10165

Fuel catalyst for engines under 3.5 hp and all hand-held outdoor power equipment. (F2-T)

Order No. 33 - 10166

Fuel catalyst for engines over 3.5 hp; walk behind mower, snow blowers. (F4-T)

Order No. 33 - 12519

Power sports pack for commercial mowers, motorcycles, ATV's, do not exceed 10 gallons. Must use both drop in's.

- Easier Starting
- Increased Fuel Economy
- Reduced Emissions



Rotary/Torco 2-Cycle Oil



Torco's 2-cycle oil recommended for all chainsaws, blowers, trimmers & high RPM air cooled 2-cycle engines with emission control & spark arrestor system. Contains fuel stabilizers & fuel identification tint. Meets ISO-L-EGO & JASO FC performance levels.

Order No. 33 - 9449

2-Cycle oil, 2.56 oz pillow packs. Mixes 1 Gallon. MIN024

Order No. 33 - 9450

2-Cycle oil, 6.4 oz bottle. Mixes 2-1/2 gallons. MIN024

Order No. 33 - 9451

2-Cycle oil, 12.8 oz bottle. Mixes 5 gallons. MIN024

LAWN AND GARDEN ACCESSORIES



33
LAWN & GARDEN

Spanner Wrench



Order No. 33 - 14164

Spanner wrench 21mm (13/16") x 19mm (3/4") - 11mm (7/16") square. Removes spark plug and oil drain.

T-Wrench



Order No. 33 - 8977

T-wrench for chain saws with wrap around handles. 1-5/8" barrel length. 19mm x 13mm x 1-5/8"



T-Wrenches

Order No.	Spark Plug Socket Size	Guide Bar Nut Size	Order No.	Spark Plug Socket Size	Guide Bar Nut Size
33 - 4215	13/16" (21mm)	11/16" (17mm)	33 - 4220	3/4" (19mm)	9/16" (14mm)
Stihl 08S, S-10, TS, 50, 070, 075AV. Solo 50, 70, 125, 630.			Campbell Hausfeld CS-3000, 4000 series; Echo 605; John Deere 17, 19; Lombard Comango, Lighting I, II, III, IV, V. Montgomery Ward 24031, 36, 37, 38, 40, 45, 85, 87, 89, 90, 94, 95, 96; Poulan 200, 300, 400 series; Remington PL-4, PI-5, PL-55, SL-4, SL-11, SL-55.		
33 - 4216	3/4" (19mm)	5/8" (16mm)	33 - 4221	13/16" (21mm)	1/2" (13mm)
Homelite XL-12, SXL-12, SXL-AO, 125, 800, 900, EZ, EZ Mini.			Pioneer 620, 650, 1073, 400, 540, 550, 600, HC, RA, NU17, 650, 700, 50, 800.		
33 - 4217	13/16" (21mm)	9/16" (14mm)	33 - 4222	3/4" (19mm)	7/16" (11mm)
Allis Chalmers 95, 195, 295; McCulloch 200, 300, 400, 500, 700, 800 series, 1-60, 1-70, 1-80 series; Poulan 30, 40, 50, 60, 70, 80, 90 series.			Frontier Mark 1; Homelite Mini; Husqvarna Husky 35, 65, 77. Jonsereds Lit J-376; Partner Mini P; Pioneer P-10.		
33 - 4218	3/4" (19mm)	1/2" (13mm)	33 - 4223	5/8" (16mm)	7/16" (11mm)
Echo 601, 100; Husqvarna 60 series, 160 series, 77, 180, 185, 263, 280, 380, 1100, 2100; John Deere 8, 9, 12, 15; Montgomery Ward 2400A, 24002A, 24032, 24033, 24034, 24035, 24072, 24075; Partner R series, P series, F series; Remington MM Weekender, MM Bantam, MM Auto, MM Bantam, MM Auto MM Deluxe, MMES, SL-9, SL-9A, SL-10, SL-10A; Stihl 041, 041AV, 045AV, 051AV, 031AV, 020AVC. Redline RLE300.			Homelite XL-2, Super XL, McCulloch, Mini 6. Promac 510.		
33 - 4219	5/8" (16mm)	1/2" (13mm)	33 - 5889	3/4" (19mm)	13/32" (10mm)
Homelite, McCulloch, SP40, SP25, 110, 120, 130, 140, McCulloch Series. Promac 1600. HU. SQ. 36R, 44, 61, 165R, 480 Jons. 510-520. Promac. 555, 700, CP70, 600.			Echo		

T-Wrench

Order No. 33 - 11852

T-Wrench 3/4" x 13mm / 1/2" W/ 3-3/16" long barrel. Fits 3/4" (19mm) Spark plug, 1/2" (13mm) bar nut.





Spark Plug Wrench

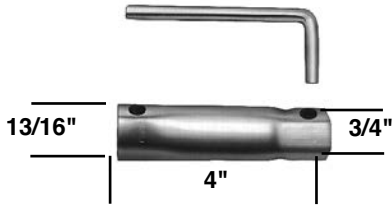

Order No. 33 - 1291

Loosen or tighten spark plug with this handy tool.



Order No. 33 - 8976

Spark plug wrench fits overhead valve engines. 13/16" & 5/8."

Top Saw Tool



Order No. 33 - 14139

The Pocket Wrench is 9 tools in one that allows the user to work on chainsaws, cutoff saws, trimmers and blowers in the field. The tool easily fits in your pocket or in an included sheath (4 1/2"-inches long) and contains a large screwdriver for bar adjustment, a T27 Torx for all bolts on most saws, a 4mm Allen wrench for all other saws, a small screwdriver (for fuel and bar oil adjustment), a bar groove cleaner and has a 13mm (1/2"-inch) socket that will fit a bar nut on most half or full-wrap handle chain saws. The other end of the tool has a 19mm deep socket for the spark plug on all other saws and a bar nut on Stihl saws, and can be reversed to a 16mm socket. Additionally it can be used as a file handle.

Collapsible Debris Bag



Order No. 33 - 14362

Collapsible Debris Bag. 21-1/2" wide, 29" tall.

MIN004

Utility Poly Shovel



Order No. 33 - 14159

Utility Poly Shovel. Our easy to clean polypropylene shovel is rust-proof and virtually unbreakable. Not only does it make a great snow shovel, but is excellent as a mulch shovel, grain shovel or handy for many other home and farm chores. Red in color for easy identification.

Insect Repelling Super Band



Order No. 33 - 14461

Insect repelling super band. Repels Mosquitoes, Biting Flies, Gnats, Sand Flies, Bees and many other annoying flying pest. The essential natural oils that are used are non-toxic and safe for children and pets and completely Deet Free. Once opened, the band is activated and keeps repelling insects for up to 200 hours. Counter display 50 pcs.



CHAIN SAW CHAIN

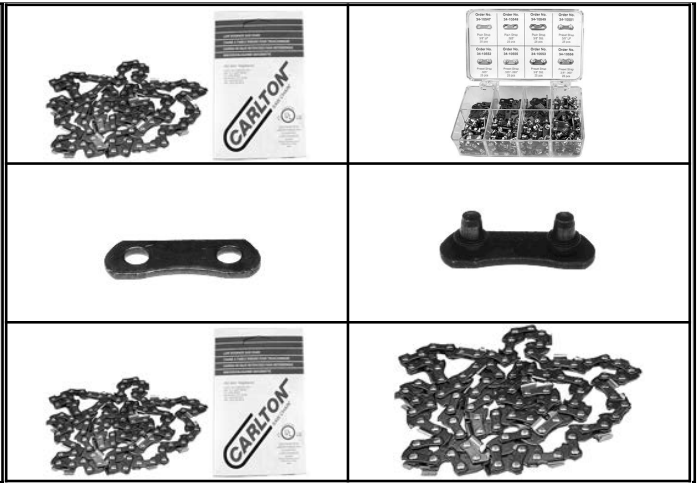

Quick-Glance

CHAIN SAW CHAIN	PG.
Saw Chain	1140-1145
Assortment	1145

34 Quick-Glance

CHAIN SAW CHAIN



CHAIN INTERCHANGE BY MANUFACTURER NUMBER

CHAIN SAW CHAIN 34

Chain Pitch	Chain Gauge	Chain Type	Sandvik Windsor	Sabre	Carlton	Home-lite		McCulloch	Oregon	Poulan	Stihl
1/4"	.050"	Semi-Chisel	50K	T16		25-50			25 AP	P25	13RM
3/8"	.050"	Semi-Chisel	50A	800	A-1EP	M		PM 370GX	72DG	P22	33RM
3/8"	.050"	Chisel	50ALG	T5Y	A1LM-BL			SPR 370G	72LP		
3/8"	.050"	Semi-Chisel	50AG		A1EP-BL	38 ME 50			72SG		33RM2
3/8"	.050"	Lo-Pro	50RG	350S	N1C-BL	37-C-50		MP370	91SG	P101	63PM1
3/8"	.058"	Semi-Chisel	58A	T8P	A-2EP			SM 378	23,73, DP		
3/8"	.058"	Chisel	58ALG	T8Y	A2LM-BL			SPR 378G	73LP		
3/8"	.058"	Semi-Chisel	58AG		A2EP-BL	38 ME 58			73SG		
3/8"	.063"	Semi-Chisel	63A	T6P	A363EP-N			PM 373	75D		36M
3/8"	.063"	Semi-Chisel	63AG			75SG		36RM2			
3/8"	.063"	Chisel	63ALG		A3LM-BL			SPR 373G	75LP		
.404"	.058"	Semi-Chisel	58B	U8P	B2EP			SM 408	26		
.404"	.058"	Semi-Chisel	58B		B2EP			PM 408	51AC		45C
.404"	.058"	Chisel		U8Y				SPR 408	51LP		
.404"	.063"	Semi-Chisel	63B	U6P	B3EP			SM 403	27	P27	
.404"	.063"	Semi-Chisel	63B	U6P	B3EP	40-C-63		PM 403	52CP	P52	46M
.325"	.050"	Semi-Chisel	50J	520	K1C				20VB	P20, 87	23TM
.325"	.050"	Chisel	50JL		K1L	32 L 50			33LG		
.325"	.050"	Semi-Chisel	50JG	520S	K1C	32 ME 50			20VB		23TM1
.325"	.050"	Chisel	50JL		K1L	32 LE 50			33SL		
.325"	.058"	Semi-Chisel	58J	528	K2C				21VB		25TM
.325"	.058"	Chisel	58JL		K2L	32 L 58			34LG		25RS1
.325"	.058"	Semi-Chisel	58J		K2C-GL	32 ME 58			34SG		
.325"	.058"	Chisel	58JL		K2L	32 LE 58			34SL		
.325"	.063"	Semi-Chisel	63J	523	K3C				22VB		26TM
.325"	.063"	Semi-Chisel	63JG		K3C-BL	32 ME 63			35SG		26TM1
.325"	.063"	Chisel	63JL		K3L				35SL		26TM1

The Carlton Saw Chain Numbering System

Example: A2LM-60E

A		2		LM		60		E	
3/8" Pitch		.058" Gauge		Magna Chisel		Drive Link		Endless Loop	
A	3/8"	1	.050" (1,3mm)	C	Champion (semi chisel)			E	Endless Loop
B	.404"	2	.058" (1,5mm)	EP	Type "E" Prof.(semi chisel)			GL	Guard Link
E	1/4"	3	.063" (1,6mm)	H	Machine chain/semi chisel			BL	Bumper Link
G	.750"	4	.043" (1,1mm)	L	Chisel			SK	Skip Sequence
K	.325"	5	.080" (2,0mm)	LM	Magna Chisel				
N	3/8" LP	7	.122" (3,1mm)	M	Harvester Machine				
				MC	Micro Chisel				
				RM	Microcut (chamfer chisel)				
				RP	Ripping				
				S	"S" Style (chipper)				



CARLTON SAW CHAIN

Carlton BL/GL Series is "Low Kickback Saw Chain" in accordance with ANSI B175

Pitch	Gauge	Cutter	Chain No.
3/8" Low-Profile	.043	SEMI-CHISEL	N4C-BL

NARROW KERF- 3/8" LOW-PROFILE

Top Plate File Angle	File Size	Depth Gauge Setting
35°	5/32"	.022"

Pitch	Gauge	Cutter	Chain No.
3/8" Low-Profile	.050	SEMI-CHISEL	N1C

3/8" LOW-PROFILE

Top Plate File Angle	File Size	Depth Gauge Setting
35°	5/32"	.022"

Pitch	Gauge	Cutter	Chain No.
3/8" Low-Profile	.050	SEMI-CHISEL	N1C-BL

3/8" LOW-PROFILE

Top Plate File Angle	File Size	Depth Gauge Setting
35°	5/32"	.022"

Pitch	Gauge	Cutter	Chain No.
.325"	.050	SEMI-CHISEL	K1C
.325"	.058		K2C
.325"	.063		K3C

.325" SEMI-CHISEL

Top Plate File Angle	File Size	Depth Gauge Setting
35°	3/16"	.022"

Pitch	Gauge	Cutter	Chain No.
.325"	.050	SEMI-CHISEL	K1C-BL
.325"	.058		K2C-BL
.325"	.063		K3C-BL
.325"	.050	CHISEL	K1L-BL
.325"	.058		K2L-BL
.325"	.063		K3L-BL

.325" BL SEMI-CHISEL

Top Plate File Angle	File Size	Depth Gauge Setting
35°	3/16"	.022"

Pitch	Gauge	Cutter	Chain No.
.325"	.050	CHISEL	K1L
.325"	.058		K2L
.325"	.063		K3L

.325" CHISEL

Top Plate File Angle	File Size	Depth Gauge Setting
35°	11/64"	.022"

Pitch	Gauge	Cutter	Chain No.
3/8"	.050	SEMI-CHISEL	A1EP-GL
3/8"	.058		A2EP-GL
3/8"	.063		A3EP-GL
3/8"	.050	CHISEL	A1LM-GL
3/8"	.058		A2LM-GL
3/8"	.063		A3LM-GL

3/8" GL SEMI-CHISEL

Top Plate File Angle	File Size	Depth Gauge Setting
35°	7/32"	.028"

Pitch	Gauge	Cutter	Chain No.
3/8"	.050	CHISEL	A1LM
3/8"	.058		A2LM
3/8"	.063		A3LM

3/8" SEMI-CHISEL

Top Plate File Angle	File Size	Depth Gauge Setting
35°	7/32"	.028"

Pitch	Gauge	Cutter	Chain No.
3/8" Low-Profile	.043	SEMI-CHISEL	N4C

NARROW KERF 3/8" LOW-PROFILE

Top Plate File Angle	File Size	Depth Gauge Setting
35°	5/32"	.022"

Pitch	Gauge	Cutter	Chain No.
.404"	.058	CHISEL	B2LM
.404"	.063		B3LM

3/8" MAGNA CHISEL

Top Plate File Angle	File Size	Depth Gauge Setting
30°	7/32"	.028"

3/8" GL CHISEL

Top Plate File Angle	File Size	Depth Gauge Setting
30°	7/32"	.028"

Pitch	Gauge	Cutter	Chain No.
.404"	.058	SEMI-CHISEL	B2EP
.404"	.063		B3EP

.404" SEMI-CHISEL

Top Plate File Angle	File Size	Depth Gauge Setting
35°	7/32"	.032"

NARROW KERF 3/8" LOW-PROFILE

Top Plate File Angle	File Size	Depth Gauge Setting
35°	5/32"	.022"

Pitch	Gauge	Cutter	Chain No.
.404"	.058	CHISEL	B2LM
.404"	.063		B3LM

.404" MAGNA CHISEL

Top Plate File Angle	File Size	Depth Gauge Setting
35°	7/32"	.038"

SKIP-TOOTH SAW CHAIN

SKIP-TOOTH SAW CHAIN

For cutting big timber. Fewer cutters allow increased chip clearance and faster feeding.



SKIP-TOOTH CHAIN IS AVAILABLE IN THESE CARLTON TYPES

Pitch	Gauge	Cutter	Chain No.
3/8"	.050	Semi-chisel	A1EP-ST
3/8"	.050	Chisel	A1LM-ST
3/8"	.058	Chisel	A2LM-ST
3/8"	.063	Semi-chisel	A3EP-ST
3/8"	.063	Chisel	A3LM-ST
.404"	.063	Semi-chisel	B3EP-ST
.404"	.063	Chisel	B3LM-ST

CHAIN SAW CHAIN



CARLTON

SAW CHAIN
25 Foot and 100 Foot Reels

CARLTON



CHAIN SAW CHAIN 34

			CARLTON SAW CHAIN		
Pitch	Desc.	GA.	Order No.	Carlton No.	
25 Foot Rolls					
3/8"	Lo Pro	.050	34 - 10517	N1C-25R	
3/8"	Semi Chisel	.043	34 - 14153	N4C-25U	
3/8"	Semi Chisel	.050	34 - 10494	A1EP-25R	
3/8"	Semi Chisel	.058	34 - 10496	A2EP-25R	
3/8"	Semi Chisel	.063	34 - 10498	A3EP-25R	
3/8"	Chisel	.050	34 - 10501	A1LM-25R	
3/8"	Chisel	.058	34 - 10503	A2LM-25R	
3/8"	Chisel	.063	34 - 10505	A3LM-25R	
.325"	Semi Chisel	.050	34 - 10507	K1C-25R	
.325"	Semi Chisel	.058	34 - 10509	K2C-25R	
.325"	Semi Chisel	.063	34 - 10511	K3C-25R	
.325"	Chisel	.050	34 - 10516	K1L-25R	
.325"	Chisel	.058	34 - 10514	K2L-25R	
.325"	Chisel	.063	34 - 10500	K3L-25R	
.404"	Semi Chisel	.063	34 - 10515	B3EP-25R	
25 Foot Guard Link					
3/8"	Semi Chisel	.050	34 - 11543	A1EP-GL-25R	
25 Foot Bumper Link					
3/8"	Lo Pro	.043	34 - 10564	N4C-BL-25R	
3/8"	Lo Pro	.050	34 - 10499	N1C-BL-25R	
3/8"	Semi-Chisel	.058	34 - 10497	A2EP-BL-25R	
3/8"	Chisel	.058	34 - 10504	A2LM-BL-25R	
3/8"	Chisel	.063	34 - 10506	A3LM-BL-25R	
.325"	Semi-Chisel	.050	34 - 10508	K1C-BL-25R	
.325"	Semi-Chisel	.058	34 - 10510	K2C-BL-25R	
.325"	Chisel	.063	34 - 11525	K3L-BL-25R	
100 Foot Roll					
3/8"	Lo Pro (BL)	.043	34 - 10664	N4C-BL-100R	
3/8"	Sem-Chisel	.043	34 - 14154	N4C-100U	
3/8"	Lo Pro	.050	34 - 10491	N1C-100R	
3/8"	Lo Pro(BL)	.050	34 - 10488	N1C-BL-100R	
3/8"	Semi-Chisel	.050	34 - 10487	A1EP-100R	
3/8"	Chisel	.050	34 - 10489	A1LM-100R	
3/8"	Magna Chisel	.050	34 - 12483	A1LM-SK-100R	
3/8"	Chisel	.058	34 - 12488	A2LM-100R	
3/8"	Chisel	.063	34 - 11481	A3LM-100R	
.325"	Semi-Chisel	.050	34 - 10490	K1C-100R	
.325"	Chisel	.050	34 - 10493	K1L-100R	
.325"	Magna Chisel	.050	34 - 12482	K1L-SK-100R	
.325"	Chisel (BL)	.063	34 - 11530	K3L-BL-100R	
.325"	Semi-Chisel	.058	34 - 10621	K2C-100R	
.325"	Chisel	.058	34 - 10622	K2L-100R	
.325"	Chisel	.063	34 - 10492	K3L-100R	



CARLTON

**SAW CHAIN
REPAIR PARTS**

CARLTON



Plain Strap



Preset Strap

Pitch	Fits Carlton Chain No.	Carlton Plain Strap No.	Order No.		Pitch	Fits Carlton Chain No.	Carlton Preset Strap No.	Order No.	
3/8" LP	N1-4	43002	34 - 10547	MIN025	3/8" LP	N1	43011	34 - 10551	MIN025
.325"	K1-3	43000	34 - 10548	MIN025	3/8" LP	N4	42993	34 - 10557	MIN025
3/8"	A1-3	43003	34 - 10549	MIN025	.325"	K1-2	43008	34 - 10552	MIN025
.404"	B2-3	43004	34 - 10550	MIN025	.325"	K3	43009	34 - 10555	MIN025
.750"	G7-122S	43203	34 - 12216	MIN025	3/8"	A1-2	43012	34 - 10553	MIN025
					3/8"	A3	43013	34 - 10556	MIN025
					.404"	B2	43015	34 - 10554	MIN025
					.750"	G7-122S	43203	34 - 12217	MIN025

WINDSOR

**SAW CHAIN
REPAIR PARTS**

WINDSOR



Plain Strap



Preset Strap

Pitch	Windsor Chain No.	Windsor Plain Strap No.	Order No.		Pitch	Windsor Chain No.	Windsor Preset Strap No.	Order No.	
3/8" LP	50R	R201	34 - 4288	MIN010	3/8" LP	50R	50R20	34 - 4284	MIN010
.325"	50J	J201	34 - 4292	MIN010	3/8"	50A	58A20	34 - 4287	MIN010
.325"	58J	J201	34 - 4292	MIN010	3/8"	58A	58A20	34 - 4287	MIN010
3/8"	50A	A201	34 - 4294	MIN010	3/8"	63A	63A20	34 - 4287	MIN010
3/8"	58A	A201	34 - 4294	MIN010					
3/8"	63A	A201	34 - 4294	MIN010					
.404"	58B	B201	34 - 4297	MIN010					
.404"	63B	B201	34 - 4297	MIN010					

34

CHAIN SAW CHAIN

**Loop Chain for Pole Saws from
CARLTON**



Order No. 34 - 12720

3/8" Lo Pro x .043 GA, 38 DL saw chain from Carlton. Fits 10" pole saws. Carlton N4C-BL-38E RO.

Order No. 34 - 10896

3/8" LP x .043 GA, 44 DL Carlton saw chain for 12" bars on Stihl Pole saws.

CHAIN SAW CHAIN



CARLTON

SEMI-CHISEL SAW CHAIN

CARLTON

Cut Loops

34

CHAIN SAW CHAIN



Pitch	Gauge	Drive Links	CARLTON SAW CHAIN		Carlton No.
			Order No.		
3/8" X LO PRO Bumper Link					
3/8"	.043	44	34 - 10896		N4C-BL-44G
3/8"	.043	50	34 - 10805		N4C-BL-50G
3/8"	.043	52	34 - 13181		N4C-BL-52G
3/8"	.050	44	34 - 10535		N1C-BL-44G
3/8"	.050	45	34 - 10522		N1C-BL-45G
3/8"	.050	49	34 - 10536		N1C-BL-49G
3/8"	.050	50	34 - 10520		N1C-BL-50G
3/8"	.050	52	34 - 10518		N1C-BL-52G
3/8"	.050	53	34 - 10537		N1C-BL-53G
3/8"	.050	55	34 - 10538		N1C-BL-55G
3/8"	.050	56	34 - 10528		N1C-BL-56G
3/8"	.050	57	34 - 10527		N1C-BL-57G
3/8"	.050	59	34 - 10529		N1C-BL-59G
3/8"	.050	60	34 - 12412		N1C-BL-60G
3/8"	.050	62	34 - 10540		N1C-BL-62G
3/8" X .050 Semi Chisel					
3/8"	.050	64	34 - 10541		A1EP-64G
3/8"	.050	66	34 - 11524		A1EP-66G
3/8"	.050	70	34 - 10524		A1EP-70G
3/8"	.050	72	34 - 10525		A1EP-72G
3/8" X .058 Chisel (Guard Link)					
3/8"	.058	68	34 - 14635		A2EP-GL-68G
3/8"	.058	72	34 - 11545		A2LM-GL-72G



CARLTON

SEMI-CHISEL SAW CHAIN

CARLTON

Cut Loops

			CARLTON SAW CHAIN	
Pitch	Gauge	Drive Links	Order No.	Carlton No.
.325" X .050				
Semi Chisel				
.325"	.050	56	34 - 11526	K1C-56G
.325"	.050	64	34 - 11533	K1C-64G
.325" X .050				
Semi Chisel (Bumperlink)				
.325"	.050	66	34 - 11536	K1C-BL-66G
.325"	.050	72	34 - 11538	K1C-BL-72G
.325" X .050				
Semi Chisel				
.325"	.050	66	34 - 10530	K1C-66G
.325"	.050	72	34 - 10532	K1C-72G
.325"	.050	78	34 - 10534	K1C-78G
.325"	.050	80	34 - 11055	K1C-80G
.325" X .058				
Semi Chisel (Bumperlink)				
.325"	.058	66	34 - 11539	K2C-BL-66G
.325"	.058	68	34 - 11540	K2C-BL-68G
.325"	.058	72	34 - 11541	K2C-BL-72G
.325" X .058				
Semi Chisel				
.325"	.058	64	34 - 10542	K2C-64G
.325"	.058	66	34 - 10543	K2C-66G
.325"	.058	72	34 - 10544	K2C-72G
.325" X .063				
Semi Chisel				
.325"	.063	62	34 - 11534	K3C-62G
.325"	.063	67	34 - 10545	K3C-67G
.325"	.063	74	34 - 10546	K3C-74G
.325"	.063	81	34 - 11528	K3C-81G



34

CHAIN SAW CHAIN

CHAIN SAW CHAIN



CARLTON

CHISEL SAW CHAIN

CARLTON

Cut Loops

CHAIN SAW CHAIN 34



Pitch	Gauge	DL.	CARLTON SAW CHAIN		Carlton No.
			Order No.		
3/8" x .050 Chisel					
3/8"	.050	59	34 - 11665		A1LM-59G
3/8"	.050	60	34 - 11666		A1LM-60G
3/8"	.050	68	34 - 11669		A1LM-68G
3/8"	.050	70	34 - 11670		A1LM-70G
3/8"	.050	72	34 - 11671		A1LM-72G
3/8" x .058 Chisel					
3/8"	.058	59	34 - 11673		A2LM-59G
3/8"	.058	64	34 - 11674		A2LM-64G
3/8"	.058	70	34 - 11676		A2LM-70G
3/8"	.058	72	34 - 11529		A2LM-72G
3/8" X .058 Chisel (Guard Link)					
3/8"	.058	72	34 - 11545		A2LM-GL-72G
.325" x .050 Chisel					
.325"	.050	56	34 - 11679		K1L-56G
.325"	.050	64	34 - 11680		K1L-64G
.325"	.050	66	34 - 11681		K1L-66G
.325"	.050	67	34 - 11682		K1L-67G
.325"	.050	72	34 - 11684		K1L-72G
.325"	.050	78	34 - 11686		K1L-78G
.325"	.050	80	34 - 11687		K1L-80G
.325" x .058 Chisel					
.325"	.058	64	34 - 11688		K2L-64G
.325"	.058	66	34 - 11689		K2L-66G
.325"	.058	68	34 - 11690		K2L-68G
.325"	.058	72	34 - 11691		K2L-72G
.325"	.058	80	34 - 11693		K2L-80G
.325" x .063 Chisel					
.325"	.063	67	34 - 11695		K3L-67G
.325"	.063	68	34 - 11696		K3L-68G
.325"	.063	74	34 - 11697		K3L-74G
.325"	.063	81	34 - 11698		K3L-81G



CARLTON

STANDARD SAW CHAIN

CARLTON

Cut Loops



Pitch	Gauge	DL.	CARLTON SAW CHAIN	
			Order No.	Carlton No.
3/8" x .043 (Lo Pro) Standard				
3/8"	.043	50	34 - 11717	N4C-50E-RO
3/8" x .050 (Lo Pro) Standard				
3/8"	.050	52	34 - 11705	N1C-52E-RO
3/8"	.050	55	34 - 11708	N1C-55E-RO
3/8"	.050	56	34 - 11709	N1C-56E-RO
3/8"	.050	62	34 - 11712	N1C-62E-RO
3/8" X .050 Standard				
3/8"	.050	84	34 - 12528	A1LM-84E-RO
3/8" X .058 Standard				
3/8"	.058	84	34 - 12290	A2LM-84G
3/8"	.058	93	34 - 12291	A2LM-93G

34

CHAIN SAW CHAIN

Chain Saw Parts Assortment for CARLTON



Order No. 01 - 10722
Assortment contains 200 pieces.

Order No.	Qty.	CONTENTS Description	
34 - 10547	25	3/8" LP Plain Strap	MIN025
34 - 10548	25	.325" Plain Strap	MIN025
34 - 10549	25	3/8" Plain Strap Standard	MIN025
34 - 10551	25	3/8" LP Preset Strap	MIN025
34 - 10552	25	.325" Preset Strap	MIN025
34 - 10555	25	.325" Preset Strap .063	MIN025
34 - 10553	25	3/8 Preset Strap Standard	MIN025
34 - 10556	25	3/8" Preset Strap .063	MIN025



CHAIN SAW BARS

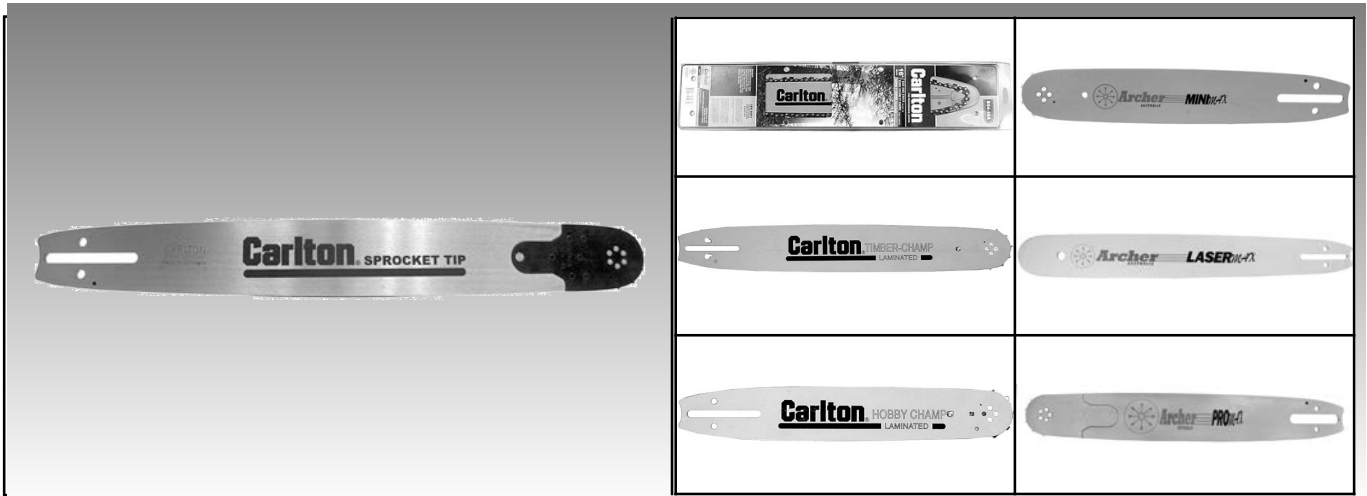

Quick-Glance

CHAIN SAW BARS	PG.
Archer Bars	1148-1150
Carlton Bars	1151
Carlton Bar & Chain Combo	1152
GB Bars	1153-1171

CHAIN SAW BARS



GUIDE BAR PART NUMBER SYSTEM

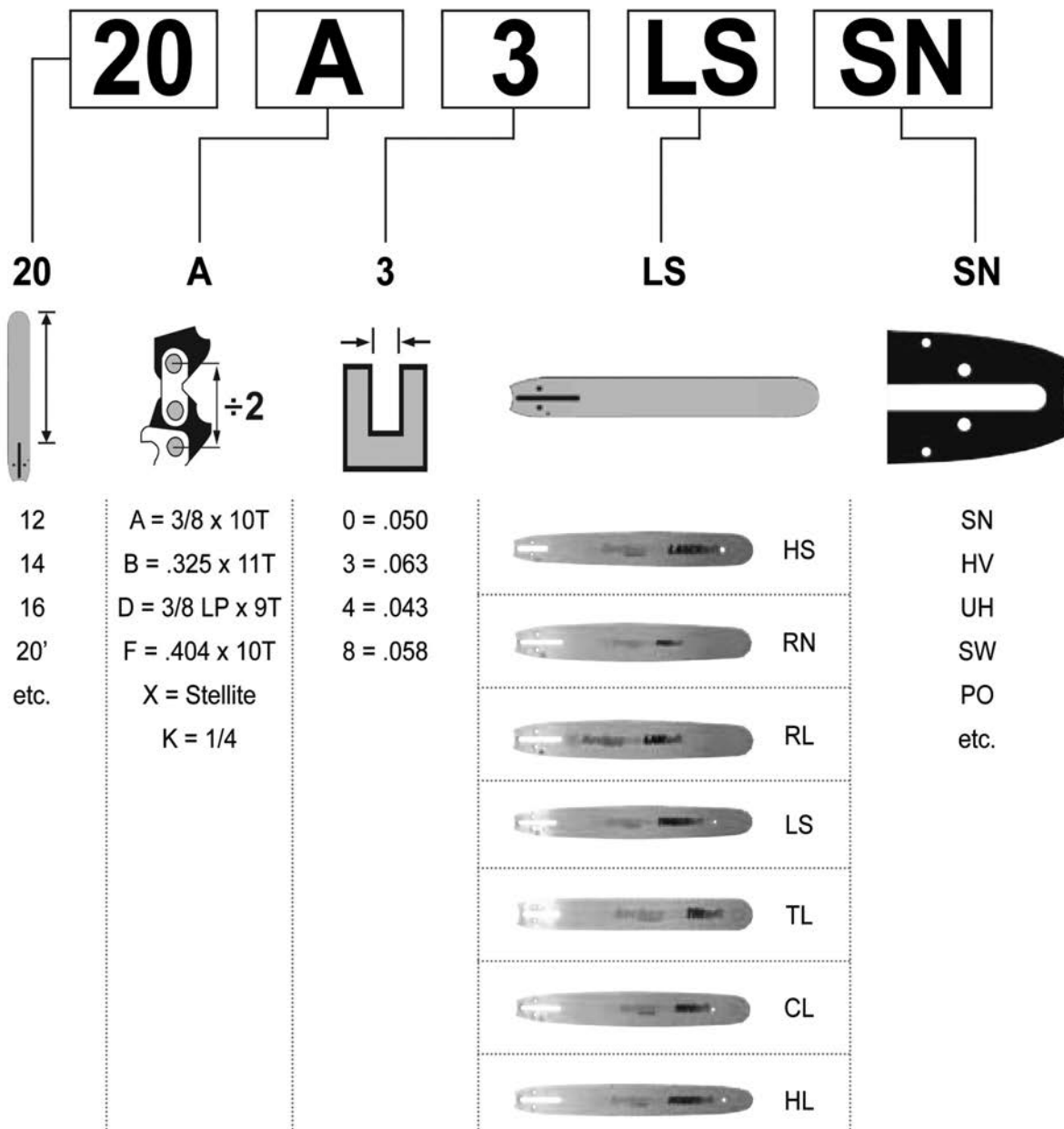

35

CHAIN SAW BAR

Pole Saw Bars from ARCHER



Order No. 35 - 13545

12-D4-CL-SW pole saw bar replaces Echo 12A4CD3744. Solid sprocket nose bar. Fits power pruner models PP600, 800, 1000, 1250, PPT260, 2400 (Echo) pole pruner saw. 12" bar, 3/8"LP, .043 ga, 44 drive links.

Order No. 35 - 13544

12-D4-CL-SW pole saw bar replaces Stihl 3005-000-3905. Solid sprocket nose bar. Fits Stihl HT70, HT75 pole pruner saw. 12" bar, 3/8"LP, .043 ga, 44 drive links.

Order No. 35 - 13546

14-D4-CL-SW pole saw bar replaces Stihl 3005-000-3909. Solid sprocket nose bar. Fits Stihl HT70, HT75 pole pruner saw. 14" bar, 3/8"LP, .043 ga, 50 drive links.

Chain Saw Bars from
ARCHER**Order No. 35 - 13302**

12 x 3/8 x .050, 45DL. Archer 12DO-CL-PO. Replaces our 35-10438.

Order No. 35 - 13303

14 x 3/8 x .050, 52DL. Archer 14DO-CL-PO. Replaces our 35-10439.

Order No. 35 - 13304

18 x 3/8 x .050, 62DL. Archer 18DO-CL-PO. Replaces our 35-10441.

Order No. 35 - 13305

12 x 3/8 x .050, 44DL. Archer 12DO-CL-M. Replaces our 35-10442.

Order No. 35 - 13306

14 x 3/8 x .050, 49DL. Archer 14DO-CL-M. Replaces our 35-10443.

Order No. 35 - 13307

12 x 3/8 x .050, 48DL. Archer 12DO-CL-HX. Replaces our 35-10445.

Order No. 35 - 13309

12 x 3/8 x .050, 44DL. Archer 12DO-CL-SW. Replaces our 35-10451.

Order No. 35 - 13310

16 x 3/8 x .050, 55DL. Archer 16DO-CL-SW. Replaces our 35-10453.

Order No. 35 - 13311

20 x 3/8 x .050, 72DL Pro. Archer 20XO-HS-HV. Replaces our 35-10565.

Order No. 35 - 13312

20 x 3/8 x .050, 72DL Pro. Archer 20XO-HS-SN. Replaces our 35-10566.

Order No. 35 - 13313

20 x 3/8 x .050, 70DL Pro. Archer 20XO-HS-EC. Replaces our 35-10567.

Order No. 35 - 13314

20 x 3/8 x .050, 70DL Pro. Archer 20XO-HS-UHL. Replaces our 35-10568.

Order No. 35 - 13315

16 x 3/8 x .050, 59DL Pro. Archer 16XO-HS-UHL. Replaces our 35-10569.

Order No. 35 - 13316

20 x 3/8 x .063, 72DL Pro. Archer 20X3-HS-HV. Replaces our 35-10570.

Order No. 35 - 14235

16 x .050 x 3/8LP, 56DL. Archer 16DO-CL-PO. Fits Echo, Poulan, Husqvarna, Red Max & Shindaiwa.

Order No. 35 - 13317

20 x 3/8 x .050, 72DL Pro. Archer 20AO-RN-HV. Replaces our 35-10577.

Order No. 35 - 13318

20 x 3/8 x .050, 70DL Pro. Archer 20AO-RN-EC. Replaces our 35-10578.

Order No. 35 - 13320

20 x 3/8 x .058, 72DL Pro. Archer 20A8-RN-HV. Replaces our 35-10580.

Order No. 35 - 13321

20 x 3/8 x .050, 72DL Pro. Archer 20AO-RN-UHL. Replaces our 35-10581.

Order No. 35 - 13322

18 x 3/8 x .050, 68DL Pro. Archer 18AO-RN-HV. Replaces our 35-10586.

Order No. 35 - 13323

16 x 3/8 x .050, 60DL Pro. Archer 16AO-RN-SN. Replaces our 35-10587.

Order No. 35 - 13324

24 x 3/8 x .050, 84DL Pro. Archer 24AO-RN-HV. Replaces our 35-10588.

Order No. 35 - 13326

20 x 3/8 x .063, 72DL Pro. Archer 20A3-RN-SN. Replaces our 35-10590.

Order No. 35 - 13327

18 x 3/8 x .058, 68DL Pro. Archer 18A8-RN-UHL. Replaces our 35-10592.

Order No. 35 - 13328

16 x 3/8 x .050, 60DL Pro. Archer 16A0-RN-HV. Replaces our 35-10593.

Order No. 35 - 13329

16 x 3/8 x .058, 60DL Pro. Archer 16A8-RN-HV. Replaces our 35-10594.

Order No. 35 - 13330

18 x .325 x .050, 72DL Pro. Archer 18BO-RN-UHL. Replaces our 35-10721.

Order No. 35 - 13589

18 x .058 x .325, 72DL Pro. Archer 18B8-TL-UH. Replaces our 35-10721.

Order No. 35 - 14343

20 x .063 x .325, 81DL. Professional, 0B3-RN-SN solid one piece bar with 1 rivet nose. Fits Stihl 029, MS290, 034, 036, MS360.

CHAIN SAW BARS



Sprocket Nose Tip for OREGON



Order No. 35 - 10916

Sprocket nose tip replaces Oregon 30853.

Chain Saw Sprocket Nose from ARCHER



Order No. 35 - 14338

.325" x 12 teeth, Archer OR325 replacement chainsaw sprocket nose tip. Bar Nose / Speed Tip fits Carlton 1-rivet. Fits Woodland Pro and Oregon Power Match bars. Speed tip nose is easily removed by punching or drilling out the large rivet. Tip works with all gauges (.050, .058, .063). Requires a hammer and punch to install.

35

CHAIN SAW BAR



**Pole Saw Bars from
CARLTON**



Order No. 35 - 13104

Carlton 12-10-N4-MHC pole saw bar. Fits Echo. 12" bar , .325", .043 ga, 45 drive links.

Order No. 35 - 13105

Carlton 14-10-N4-MHC pole saw bar. Fits Echo. 14" bar , .375", .043 ga, 52 drive links.

CARLTON CHAIN SAW BARS

**3 STYLES OF CARLTON BARS
ALL UNSURPASSED QUALITY**

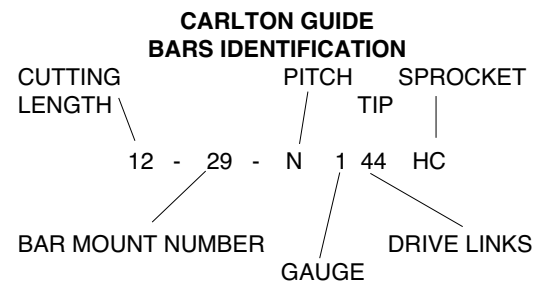

**Style Code
PL**

TIMBER CHAMP (TC)

Logger proven laminate, Induction hardened rails.



**Style Code
HB**

HOBBY CHAMP (HC)

Same features as the Timber Champ, Induction hardened rails, ground grooves.



**Style Code
PS**

PREMIUM SPROCKET (PS)

Professional quality, solid steel sprocket nose bars. The Universal Sprocket Tip will fit our competitors as well as their tip will fit ours.



**Style Code
PH**

PREMIUM HARDNOSE (PH)

Professional quality guide bar. Hardnosed solid steel bar with extra long stellite weld for use in dirty or abrasive conditions.

BAR IDENTIFICATION	
Pitch of Sprocket Tip	Identified By First Letter In the Bar Number
3/8"	A
.404"	B
.325"	K
3/8" LP	N

BAR IDENTIFICATION	
Gauge of BAR	Identified By Number after Pitch
.050	1
.058	2
.063	3
.043	4

35

CHAIN SAW BAR

CHAIN SAW BARS



Bar & Chain Combination from CARLTON



35

CHAIN SAW BAR

Order No. 35 - 13184

12" Bar & Chain Combination N1CB2H12-45ECA, fits Echo. Bar 12-10-N145-HC, Chain N150C-K-45E.

Order No. 35 - 13066

14" Bar & Chain Combination 600743CA, fits Stihl. Bar 14-26-N150-HC, Chain N1C-BL-50E. 3/8 Lo Pro x .050 Bumper Link x 50 Drive Links.

Order No. 35 - 10840

14" Bar & Chain Combination fits Echo, Homelite, Husqvarna, & Poulan. 50 ga., 3/8LP pitch, 52 drive links.

Order No. 35 - 10828

16" Bar & Chain Combination fits Echo, Homelite, Husqvarna, & Poulan. 50 ga., 3/8LP pitch, 57 drive links.

Order No. 35 - 13064

18" Bar & Chain Combination 600741CA, fits Husqvarna. Bar 18-81-A268-TC11, Chain A2LM-BL-68E . 3/8 Std. x .058 Chisel, Bumper Link x 68 Drive Links.

Order No. 35 - 10836

18" Bar & Chain Combination fits Homelite & Poulan. 50 ga., 3/8LP pitch, 62 drive links.

Order No. 35 - 10837

18" Bar & Chain Combination fits Echo, Homelite & Poulan. 50 ga., .325 pitch, 72 drive links.

Order No. 35 - 13074

18" Bar & Chain Combination 600753CA, fits Stihl. Bar 18-42-A366-TC11, Chain A3LM-BL-66E. 3/8 Std. x .063 Chisel, Bumper Link x 66 Drive Links.

Order No. 35 - 13076

20" Bar & Chain Combination 600756CA, fits Stihl. Bar 20-42-A372-TC11, Chain A3LM-BL-72E. 3/8 Std. x .063 Chisel, Bumper Link x 72 Drive Links.

Order No. 35 - 10838

20" Bar & Chain Combination fits Poulan. 50 ga., .325 pitch, 78 drive links.



CHAIN SAW BARS

Rotary No.	Replaces Carlton Number	Replaces Oregon	Archer Number	Rotary No. for Archer	Length	Replaces Alt. Oregon No.	
12533	12-26-N4-HC				12"		
13104	12-10-N4-MHC				12"		
10575	12-26-N144-HC	120SDEA074	12DO-CL-SW	13309	12"	120SPEA074	
10597	12-10-N145-HC	120SDEA041	12DO-CL-PO	13302	12"		
10606	12-28-N148-HC	120DGEA041	12DO-CL-HX	13307	12"		
10610	12-29-N144-HC	120SDEA218	12DO-CL-M	13305	12"		
10573	14-26-N150-HC	140SDEA074			14"	140SPEA074	
12434	14-26-N4-HC				14"		
13105	14-10-N4-MHC				14"		
10596	14-10-N152-HC	140SDEA041	14DO-CL-PO	13303	14"		
10604	14-29-N149-HC	140SDEA218	14DO-CL-M	13306	14"		
10605	14-28-N153-HC	140DGEA041	14DO-CL-HX	13308	14"		
10839	N1CBL114-49E	108763			14"	600546-CA	COMBO
10840	N1CBL214-52E	105699			14"	600553-CA	COMBO
12349	15-81-A256-PS	158RNDD009	16A8-RN-HV	13329	15"		
10571	16-26-N155-HC	160SDEA074	16DO-CL-SW	13310	16"	160SPEA074	
			16DO-CL-PO	14235	16"		
10572	16-42-K367-TC	163RNBD025			16"	163SLGD025	
12538	16-26-N4-HC				16"		
10609	16-14-A160-TC				16"		
10574	16-42-A160-TC	160RNDD025			16"		
10595	16-10-N157-HC	160SDEA041			16"		
10599	16-01-K266-TC	168SLBK009			16"	168SLBK041	
10601	16-29-N155-HC	160SDEA218			16"		
10602	16-28-N159-HC	160DGEA041			16"		
10603	16-21-A160-TC10	160GDDD096			16"		
10612	16-81-A260-TC11	168SLBK009			16"	168SLGK009	168RNBK009
12335	16-81-A260-PS	168RNDD009			16"		
10827	N1CBL116-54E	108764			16"	600547-CA	COMBO
10828	N1CBL216-57E				16"	600554-CA	COMBO
10829	N1CBL216-56E	105700			16"	600550-CA	COMBO
12333	16-01W-050-PH	200ATMZ009	16XO-HS-UHL	13315	16"	200RNDZ009	
13080	16-09-K166-TC				16"		
13223	16-42-K367-PS				16"		
12356	16-42-A360-PS	163RNBD025			16"		
12338	16-41-A160-PS	160GDDD176			16"	160GNDD176	160GDDD176
12331	16-01W-A160-PS	160ATMK009			16"	160RNGK009	
12355	16-42-A160-PS	160RNDD025	16AO-RN-SN	13323	16"		
12350	16-41-A160-PS	160SLHD176			16"	160RNDD176	160GLHD176
12342	16-81-A160-PS	160RNDD009	16AO-RN-HV	13328	16"	160RGDD009	160SLHD009
12335	16-81-A260-PS	168SLHD009	16A8-RN-HV	13329	16"	168RNDD009	
10600	18-01W-K2-TC	188SLBK041			18"	188SLGK009	
12476	20-01W-K178-TC				18"		
10607	18-01-A164-TC10	180GDDD096			18"		
13082	18-09-K172-TC				18"		
13086	18-09W-K172-TC				18"		
13081	18-42-K374-TC				18"		

35

CHAIN SAW BAR

CHAIN SAW BARS



Rotary No.	Replaces Carlton Number	Replaces Oregon	Archer Number	Rotary No. for Archer	Length	Replaces Alt. Oregon No.	
13186	18-26-K368-TC				18"		
10611	18-81-A268-TC11	188SLBK009			18"	188SLGK009	188RNBK009
10613	18-10-N162-HC	180SDEA041	18DO-CL-PO	13304	18"		
10836	N1CBL218-62E	180DGEA041			18"		COMBO
10837	K1CBL318-72E	105715			18"	600555-CA	COMBO
12343	18-81-A168-PS	180RNDD009	18AO-RN-HV	13322	18"	180SLHD009	
12348	18-01W-A264-PS	188SLBK009	18A8-RN-UHL	13327	18"	188SLGK009	188RNBK095
12352	18-01W-A164-PS	180RNDZ009	18A8-RN-UHL	13327	18"	188SLGK009	188RNBK095
12347	18-01W-K172-TC12	180SLGK009	18BO-RN-UHL	13330	18"	180ATMZ009	
13589			18B8-TL-UH	13589	18"		
13083	20-01W-K1-TC12				20"		
13085	20-10W-K1-HC				20"		
13084	20-01W-K278-PS				20"		
10598	20-21-A170-TC	200GDDD009			20"		
12339	20-41-A170-PS	200RNDD276			20"		
10608	20-41-A170-TC	200SLHD176			20"		
10838	K1CBL320-78E				20"	600552-CA	COMBO
12346	20-81-050-PH	200SLHD009	20XO-HS-HV	13311	20"	200RNDD009	200RGDD009
12360	20-42-050-PH	200ATMD025	20XO-HS-SN	13312	20"		
12341	20-41-050-PH	200ATMZ009	20XO-HS-EC	13313	20"		
12334	20-01W-050-PH	160ATMK009	20XO-HS-UHL	13314	20"	160RNGK009	
12353	20-81-063-PH	203ATMD009	20X3-HS-HV	13316	20"		
12357	20-42-A172-PS	200SLHD025			20"	200RNDD025	
12344	20-81-A172-PS	200RNDD009	20AO-RV-HV	13317	20"	200RGDD009	200SLHD009
12339	20-41-A170-PS	200GLHD176	20AO-RN-EC	13318	20"	200GNDD176	200GDDD176
12345	20-81-A272-PS	208RNDD009	20A8-RN-HV	13320	20"	208SLHD009	
12332	20-01W-A170-PS	200ATMZ009	20AO-RN-UHL	13321	20"	200RNDZ009	
12358	20-42-A372-PS	203RNDD025	20A3-RN-SN	13326	20"	203RNDD025	
			20B3-RN-SN	14343	20"		
12340	24-41-A181-PS	240GNDD176			24"	240GDDD176	
12336	24-81-A284-PS	248RNDD009			24"		
12337	24-81-A184-PS	240SLHD009	24AO-RN-HV	13324	24"	240RNDD009	
12336	24-81-A284-PS	248SLHD009			24"	248RNDD009	
13122	24-42-A384-PS				24"		
13126	24-81-A184-PS				24"		
13187	24-81-A284-PS				24"		
12359	20-42-A184-PS	240RNDD025			25"		
13121	28-42-A191-PS				28"		
13123	28-42-A391-PS				28"		
13188	28-81-A192-PS				28"		
13189	28-81-A292-PS				28"		
13124	30-42-A3100-PS				30"		
13125	32-42-A3105-PS				32"		
13190	32-D009-A1-PS				32"		
13120	36-D025-A3-PS				36"		
13191	36-81-A3115-PS				36"		

CHAIN SAW BAR 35



BAR & CHAIN COMBINATION FROM CARLTON

Fits Model Numbers	Bar Length	Gauge	Pitch	Drive Links	Carlton Bar Number	Carlton Combo Number	CARLTON BAR & CHAIN		
							Order Number		
HOBBY CHAMP									
MCCULLOCH: Mac 3214, Eager Beaver 2014, Silver Eagle 2014S, MAC 130, PM310. Eager Beaver 2.0/2.1 series, MS1420, MS1432	14	50	3/8 LP	49	14-29-N149-HC	N1CBL114-49E			
MCCULLOCH: Mac 3216, 3516, 3516CC, Eager Beaver 2016, 2116, 2.0/2.1 series, Super 2316, Silver Eagle 2016S, 2116AVE, 2315, Mac 160S, PM310, Mac Cat Super 16AV, MX1635, MS1635AV	16	50	3/8 LP	54	16-29-N154-HC	N1CBL116-54E			
ECHO: CS400-440, CS3600-5000 HOMELITE: 27AV, 4550, Timberman POULAN: 285, 295, 305, 310 325, 335, 336, 2700, 2750, 2800, 2900, 3000, 3050, 3100, 3300.	18	50	.325	72	16-29-N154-HC	K1CBL318-72E	35 - 10837		
POULAN: 285, 295, 305, 310 325, 335, 336, 2700, 2750, 2800, 2900, 3000, 3050, 3100 3300.	20	50	.325	78	20-10W-K1-HC	K1CBL320-78E	35 - 10838		
MINI HOBBY CHAMP									
ECHO: CS285EL, CS290EVL, CS300EVL, CS280E, CS302 CS315, CS320EVL, CS328 CS330EVL, CS360EVL, EL55 CS2800, CS2900, CS2000/3000, CS3050, CS3400/3450 4400, ECS150/1850FT, CS2600/3400, CS3050, CS3500, CS301, CS302S, CS340, CS345, CS351, ECS2000, ECS3000. HOMELITE: 20, 20AV, 23AV 3300, 3550, 3800, D3300, D3850, PS33, Ranger, Timberman, UT10926 HUSQVARA: 23, 34, 37, 38, 41 POULAN: 1800, 2000, 2300AV, 2300CVA, 25A, Micro 25, S25CVA, S25D, S25DA, P600	14	50	3/8 LP	52	14-10-N1-MHC	N1CBL214-52E	35 - 10840		
	16	50	3/8 LP	57	10-10-N1-MHC	N1CBL216-57E	35 - 10828		
HOMELITE: 20, 23, 23AV Ranger, 3300, 3350, 3800, 3850 POULAN: Micro25, 25D, 25DLC, 25PS, S25D, S25DLX S25CVA, 25A, S25, S25AV, S25DA, 180, 200, 205, 210, 225, 235, 236, 255, 260, 1220-2600, Wood Shark, Wild Thing	18	50	3/8 LP	62	18-10-N1-MHC	N1CBL218-62E	35 - 10836		

35

CHAIN SAW BAR

CHAIN SAW BARS



Manufacturer and Model Numbers	Bar Length	Gauge	Pitch	Drive Links	ARCHER BARS		
					Order Number		
ALPINA							
A40E, Prof 41, Prof 45, A40AV, 45AV, Prof 55, Prof 65, Prof 56, Prof 66, Isofloat (540, 600), Prof 68, Prof 78, 700, C40E, CP47, CP65, 540A, CP41, CP45, 800, Prof 90AV, Prof 120AV, P41, P45, 450	18	50	3/8	64			
0-70, 0-70S, A-70E & PRO 70E	16 20	50 50	3/8 3/8	60 70			
330, 380, 432, 438, P34-S EURO-35, EURO-40, EURO-45	12 14 16	50 50 50	3/8 LP 3/8 LP 3/8 LP	44 49 55	35 - 13305 35 - 13306		
700, C40E, CP47, CP65, 540A, CP41, CP45, 800, PRO90, PRO120, P41, P45, 450, P500, P550, 600, 6001, P650	16 20	50 50	3/8 3/8	59 70	35 - 13321 35 - 13305 35 - 13306		
A40E, Prof 41, Prof 45, A40AV, 45AV, Prof 55, Prof 65, Prof 56, Prof 66, Isofloat (540, 600), Prof 68, Prof 78, 700, C40E, CP47, CP65, 540A, CP41, CP45, 800, Prof 90AV, Prof 120AV, P41, P45, 450	16 20	50 50	3/8 3/8	59 70	35 - 13315 35 - 13314		
DOLMAR / SACHS							
100, 101, 102, 103, 104, 105, 106, 108, 200, 201, 260, 275, 285, 295 Hobby PS340, PS400, 801, ES140, 160, 161, 171, 1800, PS33, 341 PS34, 3300TH	12 14 16 18	50 50 50 50	3/8 LP 3/8 LP 3/8 LP 3/8 LP	45 52 57 62	35 - 13302 35 - 13303 35 - 13304		
109, 110, 111, 112, 113, 114, 115, 116, 1600, 117, 118, 119, 120, 105, 108, PS6000, PS6000I, PS540	18 16 18	50 58 58	3/8 .325 .325	64 66 72			
105, 108, 109, 110, 111, 112, 113, 114, 115, 116, 117, 118, 119, 120SERIES PS6000, PS600I, PS540	16 20	50 50	3/8 3/8	60 69	35 - 13321		
PS6400, PS7300, PS7900, PS9000, PS9010FL	16 16 24 24	58 58 58 50	3/8 3/8 3/8 3/8	60 60 84 84	35 - 13329 35 - 13324		
105, 108, 109, 110, 111, 112, 113, 114, 115, 116, 117, 118, 119, 120 SERIES PS6000, PS6000, PS540	16 20	50 50	3/8 3/8	60 69	35 - 13315 35 - 13314		

35

CHAIN SAW BAR



CHAIN SAW BARS

CARLTON BARS			Style	Archer Part No.	Carlton Part No.	CARLTON Bar & Chain Combo.			
Order Number						Carlton Part No.	Order Number		
			PL		18-01-A164-TC10				
35 - 10603			PL		16-21-A160-TC10				
35 - 10610 35 - 10604 35 - 10601			CL,HB CL,HB HB, MP, HB	12DO-CL-M 14DO-CL-M	12-29-N144-HC 14-29-N149-HC 16-29-N155-HC				
35 - 12331 35 - 12332			ST, ST RN	20AO-RN-UHL	16-01W-A160-PS 20-01W-A170-PS				
			CL CL	12DO-CL-M 14DO-CL-M					
35 - 12333 35 - 12334			HS, PH HS, PH	16XO-HS-UHL 20XO-HS-UHL	16-01W-050-PH 20-01W-050-PH				
35 - 10597 35 - 10596 35 - 10595 35 - 10613			HB, CL, HB HB, CL, HB HB, HB HB, CL, HB	12DO-CL-PO 14DO-CL-PO 18DO-CL-PO	12-10-N145-HC 14-10-N152-HC 16-10-N157-HC 18-10-N162-HC				
			PL, PL		18-01-A164-TC10				
35 - 10599			PL, PL PL, PL		16-01-K266-TC 18-01W-K2-TC				
35 - 12331 35 - 12332			ST, ST RN, MP	UHL16-50PA 20AO-RN-UHL	16-01W-A160-PS 20-01W-A170-PS				
35 - 12349 35 - 12335 35 - 12336 35 - 12337			RN, ST ST, ST ST, ST RN, ST	16A8-RN-HV HV24-58PA 24AO-RN-HV	15-81-A256-PS 16-81-A260-PS 24-81-A284-PS 24-81-A184-PS				
35 - 12333 35 - 12334			HS, DT DT, DT	16XO-HS-UHL 20XO-HS-UHL	16-01W-050-PH 20-01W-050-PH				

35 CHAIN SAW BAR

CHAIN SAW BARS



Manufacturer and Model Numbers	Bar Length	Gauge	Pitch	Drive Links	ARCHER BARS		
					Order Number		
ECHO							
CS-2000,CS-2600,CS-280,CS-2800,CS-280E CS-285, CS-285EVL, CS-290,CS-2900, CS-290EVL, CS-300, CS-3000, CS-300EVL, CS-301, CS-302, CS-302S, CS-304, CS-3050, CS-315, CS-320, CS-320EVL, CS-328, CS330, CS-330EVL, CS-340, CS-3400, CS-341, CS-345, CS-3450, CS-346, CS-3500, CS351, CS-360, CS-360EVL, CS-4000, CS-440, CS-4500, CS-4601, E155, ECS 150, ECS 1850FT, ECS-2000, ECS-3000, EL 55	12 12 14 14 16 16 18 18 18 20 20 20	43 50 43 50 50 50 50 50 50 50 50 50	3/8 LP 3/8 LP 3/8 LP 3/8 LP 3/8 LP .325 3/8 LP .325 .325 .325 .325 .325	45 45 52 52 57 66 62 72 72 78 78 78	35 - 13302 35 - 13303		
CS-1001, CS-3600, CS-3700, CS-3900, CS-400, CS-4000, CS-4010, CS-4100, CS-4200, CS-440, CS-4400, CS-4500, CS-451, CS-4510, CS-451VL, CS-452, CS-452VL, CS-4600, CS-4601, CS-500, CS-5000, CS-500EVL, CS-500VL, CS-501EVL, CS-510, CS-5100, CS-510EVL, CS550, CS-5500, CS-5501, CS-550EVL, CS-60, CS-600, CS-600EVL	16 20 20	50 50 50	3/8 3/8 3/8	60 70 70			
CS-601, CS602, CS-602VL, CS60S, CS-610, CS-610EVL, CS-650, CS-650EVL, CS660, CS660EVL, CS-670, CS-6700, CS-6701, CS-6702, CS-701, CS-702, CS-702VL, CS-706, CS-750, CS-750EVL, CS-750VL, CS-8000, CS-8001, CS801, CS-802, CS-803, CS-900, CST-610	16 20 24 24 20	50 50 50 58 50	3/8 3/8 3/8 3/8 3/8	60 70 81 84 70	35 - 13318 35 - 13313		
HOMELITE							
20, 180, 190, 192, 200, 205, 240, 245, 250, 240SL, 245SL, 3350B, 35SL, BANDIT LX 30, EL, EL 14, EL 12, EL 16, ELCT 200, ELECTRIC, LITTLE RED, LX 30, SABRE 31, SABRE 33, SABRE 35, SL, SUPER Z, SUPER 2(SL, CC, XL, VI), XEL, XEL ELCT, XEL 14, XL, XL SERIES, XL10, XL2, XLT	12 16 20	50 50 50	3/8 LP 3/8 LP .325	48 60 78	35 - 13307		
30, 130, 150, 200, 250, 252, 290, 300, 340, 350, 415, 455, 150AO, 3850B, C540, C550, CS40, CS50, EZ 25AO, EZ AUTO, EZ250, MINI SL, SUPER EZ, SUPER EZAO, SUPER XL MINI, VI-123, VI-125, XL-100 SERIES, XL MINI, XL 76	18	50	3/8	64			
130, 150, 250, 252, 290, 300, 330, 340, 350, 360, 400, 410, 415, 450, 455, 460, 540, 550, 650, 700, 750, 800, 825, 850, 900, 922, 923, 925, 955, 1050, 8800, 150 AO, 35 SL, 360AO, 360SL, 385B, 410SL, 450SL, 550SL, AUTO, CS40, CS50, EZ 25AO, EZ AUTO, MIN SL, SUPER EZ, SUPER EZAO, SUPER XL AUTO SUPER XL MINI, SUPER XL, SXL, SXL925, SXLAO V922, V955, VI-123, VI-125, VI-925, XL MINI, XL100 SERIES, XL12, XL125, XL15, XL400, XL700.. XL76, XL800, XL900, XL923, XLAO, SLAUTO	16 20 16 20 16 20 20 24	50 50 50 50 50 50 50 50 50 50 50 58	3/8 3/8 3/8 3/8 3/8 3/8 3/8 3/8 3/8 3/8 3/8 3/8	60 70 60 70 60 70 60 70 60 70 81 84	35 - 13321		

35 CHAIN SAW BAR



CHAIN SAW BARS

CARLTON BARS			Style	Archer Part No.	Carlton Part No.	CARLTON Bar & Chain Combo.							
Order Number						Carlton Part No.	Order Number						
35 - 13104			HB, CL, HB HB, CL, HB HB, MP, HB HB, MP, HB HB, MP, HB TC TC HC	12DO-CL-PO 14DO-CL-PO 20-10W-K1-TC12 20-10W-K1-HC	12-10-N4-MHC 12-10-N145-HC 14-10-N4-MHC 14-10-N152-HC 16-10-N157-HC 16-09-K166-TC 18-10-N162-HC 18-09-K172-TC 18-09-K172-TC	N1CB2H12-45ECA	35 - 13184						
35 - 10597													
35 - 13105													
35 - 10596													
35 - 10595													
35 - 13080													
35 - 10613													
35 - 13082													
35 - 13086													
35 - 13084													
35 - 13085													
35 - 10603			PL, PL PL, PL		16-21-A160-TC10 20-41-A170-PS								
35 - 12338			ST, ST RN, ST	20AO-RN-EC	16-41-A160-PS 20-41-A170-PS								
35 - 12336			ST, ST		24-81-A284-PS								
35 - 12341			DT, DT	20XO-HS-EC	20-41-050-PH								
35 - 10606			HB, CL, HB HB, CL, HB HB, MP, HB	12DO-CL-HX 14DO-CL-HX	12-28-N148-HC 14-28-N153-HC 16-28-N159-HC								
35 - 10605													
35 - 10602													
			PL, PL		18-01-A164-TC								
35 - 10603			PL, PL		16-21-A160-TC10								
35 - 12331			ST, ST ST, RN MP	20AO-RN-UHL	16-01W-A160-PS 20-01W-A170-PS								
35 - 12332													
35 - 12338			ST, ST ST, ST	EX16-50PA E20-50PA	16-41-A160-PS 20-41-A170-PS								
35 - 12336			ST, ST		24-81-A284-PS								

35
CHAIN SAW BAR

CHAIN SAW BARS



Manufacturer and Model Numbers	Bar Length	Gauge	Pitch	Drive Links	ARCHER BARS		
					Order Number		
HOMELITE (CONT'D)							
290, 300, 330, 340, 350, 360, 400, 410, 450, 460, 540, 550, 650, 700, 750, 800, 850, 900, 922, 923, 925, 955, 8800, 150 AO, 410SL, CS40, EZ25AO, MINI SL, SUPER EZAO, SUPER XL AUTO, SXL, XL12, XL125, XL400, XLAO	16 20	50 50	3/8 3/8	59 70	35 - 13315 35 - 13314		
130, 150, 200, 300, 330, 340, 350, 360, 400, 410, 450, 460, 540, 550, 650, 700, 7550, 800, 825, 850, 900, 922, 923, 925, 955, 1050, 8800, 150AO, 35SL, 360AO, 360SL, 410SL, 450SL, 550SL, C540, C550, EZ25AO, EZ250, MINI SL, SUPER EZ, SUPER EZAO, SUPER XL AUTO, SUPERXL, SXL, SXL925, SXLAO, V922, V955, VI925, XL 12, XL 700, XL 800, XL 900, XL12, XL125, XL15, XL400, XL76, XL923, XL-AO/AUTO	20 20	50 50	3/8 3/8	70 70	35 - 13313		
HUSQVARNA							
33, 36, 40, 42, 44, 45, 50, 55, 133, 154, 234, 238, 240, 242, 254, 257, 262, 340, 440, 444, XP Rancher 50, EL1200, 1400, 1405, 1500, 1600, 49, 51, 57, 140, 246, 351, 360, 362, 61, 65, 66, 70, 77, 160, 161, 162, 260, 263, 266, 394, 268XP, 272XP, 288XP, 298, 181, 185, 280, 281, 285, 480 1100, 2100, 2101XP, 3120XP, 266XP, 181, 185, 268, 272, 280, 285, 288, 365, 371, 372, 395, 390, 394, 480, 1100, 2100, 2101, 3120	18 16 18 18 16 18 20 20	50 58 58 50 58 58 50 58	3/8 .325 .325 .325 3/8 3/8 .325 .325	64 66 72 72 60 68 78 78	35 - 13330		
36, 41, 136, 141, 243, 23, ELECTRIC 16, ELECTRIC 316	12 14 16 18	50 50 50 50	3/8 LP 3/8 LP 3/8 LP 3/8 LP	45 52 56 62	35 - 13302 35 - 13303 35 - 13304		
33, 36, 40, 42, 44, 45, 49, 50, 51, 55, 133, 154, 234, 238, 240, 242, 254, 257, 262, 340, 440, 444, XP Rancher 50, EL 1400, 1405, 57, 140, 246, 351, 360, 362, XL1200, 1500, 1600	16 20 18	50 50 58	3/8 3/8 3/8	60 70 64	35 - 13321 35 - 13327		
61, 65, 66, 77, 160, 161, 162, 181, 185, 260, 263, 266, 268, 272, 280, 285, 288, 298, 365, 371, 372, 395, 390, 394, 480, 1100, 2100, 2101, 3120	16 18 20 20 16 24 24 24 24 28 28 32 36	50 50 50 58 58 58 50 50 50 58 58 50 63	3/8 3/8 3/8 3/8 3/8 3/8 3/8 3/8 3/8 3/8 3/8 3/8	60 68 72 72 60 84 84 84 84 92 92 105 115	35 - 13328 35 - 13322 35 - 13317 35 - 13320 35 - 13329 35 - 13324		
33, 36, 40, 42, 44, 45, 49, 50, 51, 55, 57, 133, 140, 154, 234, 238, 240, 242, 246, 254, 257, 262, 340, 351, 360, 361, 362, 440, 444, EL1200, 1400, 1405, 1500, 1600, XP, RANCHER 50	16 20 20	50 50 50	3/8 3/8 3/8	60 70 70	35 - 13315 35 - 13314		
61, 65, 66, 77, 160, 161, 162, 260, 263, 266, 394, 268, 272, 288, 298, 181, 185, 280, 285, 480, 1100, 2100, 2101, 3120, 266, 70, 365, 371, 372, 395, 390, 394	20	50	3/8	72	35 - 13311		

CHAIN SAW BAR 35



CHAIN SAW BARS

CARLTON BARS			Style	Archer Part No.	Carlton Part No.	CARLTON Bar & Chain Combo.			
Order Number						Carlton Part No.	Order Number		
35 - 12333 35 - 12334			DT, DT DT, DT	16XO-HS-UHL 20XO-HS-UHL	16-01W-050-PH 20-01W-050-PH				
35 - 12341			DT, DT DT, DT	20XO-HS-EC	20-41-050-PH 20-41-A170-PS				
35 - 10599 35 - 12347			PL, PL PL, PL	18BO-RN-UHL	16-01-K266-TC 18-01W-K2-TC	600745CA 600752CA			
35 - 10612 35 - 10611			PL, PL PL, PL		16-81-A260-TC11 18-81-A268-TC11	600741CA	35 - 13064		
35 - 13083			PS		20-01W-K278-PS				
35 - 10597 35 - 10596 35 - 10595 35 - 10613			HB, CL, HB HB, CL, HB HB, MP, HB HB, CL, HB	12DO-CL-PO 14DO-CL-PO 18DO-CL-PO	12-10-N145-HC 14-10-N152-HC 16-10-N156-HC 18-10-N162-HC	600746CA			
35 - 12331 35 - 12332 35 - 12352			ST, ST ST, MP ST, MP	20AO-RN-UHL 18A8-RN-UHL	16-01W-A160-PS 20-01W-A170-PS 18-01W-A164-PS				
35 - 12342 35 - 12343 35 - 12344 35 - 12345			ST, ST ST, ST ST, ST ST, ST	16AO-RN-HV 18AO-RN-HV 20AO-RN-HV 20A8-RN-HV	16-81-A160-PS 18-81-A168-PS 20-81-A172-PS 20-81-A272-PS	600742CA			
35 - 12349 35 - 12336 35 - 12337			ST, ST ST, ST ST, ST	16A8-RN-HV 24AO-RN-HV	15-81-A256-PS 24-81-A284-PS 24-81-A184-ST				
35 - 13187 35 - 13188 35 - 13189 35 - 13190 35 - 13191			PS PS PS PS PS		24-81-A284-PS 28-81-A192-PS 28-81-A292-PS 32-D009-A1-PS 36-81-A3115-PS				
35 - 12333 35 - 12334			DT, DT DT, DT DT, DT	16XO-HS-UHL 20XO-HS-UHL	16-01W-050-PH 20-01W-050-PH 20-41-A170-PS				
35 - 12346			DT, DT	20XO-HS-HV	20-81-050-PH				

35
CHAIN SAW BAR

CHAIN SAW BARS



Manufacturer and Model Numbers	Bar Length	Gauge	Pitch	Drive Links	ARCHER BARS				
					Order Number				
JOHN DEERE									
36, 40	12	50	3/8 LP	45	35 - 13302				
	14	50	3/8 LP	52		35 - 13303			
	16	50	3/8 LP	56					
50V, 51SV, 55SV, 500CS, 60V, 65V, 66SV	16	50	3/8	60					
	20	50	3/8	70					
61, 81, 91	12	50	3/8 LP	44	35 - 13305				
	14	50	3/8 LP	49		35 - 13306			
	16	50	3/8 LP	55					
50V, 51SV, 55SV, 500CS, 60V, 65V, 66SV	16	50	3/8	60	35 - 13313				
	20	50	3/8	70					
	20	50	3/8	70					
	24	50	3/8	81					
JONSERED									
45, 49, 50, 51, 52, 370, 410, 420, 425, 435, 450, 451, 452, 455, 490, 510, 520, 521, 525, 535, 590, 2116EL	18	50	3/8	64	35 - 13330				
	18	50	.325	72					
	16	58	.325	66					
	18	58	.325	72					
625, 630, 630 SUPER, 670, 670 WEST COAST, 2065, 2071, 2077, 2083, 2094, 2095, 2165, 2171	16	58	3/8	60					
	16	58	3/8	60					
	18	58	3/8	68					
490, 520SP, 525, 535, 590, 2050, 2051, 2054, 2055, 2063	16	50	3/8	60	35 - 13321				
	20	50	3/8	70		35 - 13327			
	18	58	3/8	68					
70, 75, 77, 89, 81, 90, 110, 111, 601, 621, 624, 754, 820, 830, 920, 930, 935, 1020, 1030	16	50	3/8	60					
	20	50	3/8	70					
	24	50	3/8	81					
625, 630, 630 SUPER, 670, 670 WEST COAST, 2065, 2071, 2077, 2083, 2094, 2095, 2165, 2171	16	50	3/8	60	35 - 13328				
	18	50	3/8	68		35 - 13322			
	20	50	3/8	72			35 - 13317		
	16	58	3/8	60				35 - 13329	
20	58	3/8	72	35 - 13320					
24	58	3/8	84						
70, 75, 77, 89, 81, 90, 110, 111, 601, 621, 624, 754, 820, 830, 920, 930, 935, 1020, 1030	20	50	3/8	70	35 - 13313				
	20	50	3/8	70					
625, 630, 630 SUPER, 670, 670 WEST COAST, 2065, 2071, 2077, 2083, 2094, 2095, 2165, 2171	20	50	3/8	72	35 - 13311				
MAKITA									
DCS6400, DCS7300, DCS7900, DCS9000, DCS9010	16	58	3/8	60	35 - 13329				
	24	58	3/8	84					
	24	50	3/8	84		35 - 13324			

CHAIN SAW BAR 35



CHAIN SAW BARS

CARLTON BARS			Style	Archer Part No.	Carlton Part No.	CARLTON Bar & Chain Combo.			
Order Number						Carlton Part No.	Order Number		
35 - 10597			HB, CL, HB	12DO-CL-PO	12-10-N145-HC				
35 - 10596			HB, CL, HB	14DO-CL-PO	14-10-N152-HC				
35 - 10595			HB, HB		16-10-N157-HC				
35 - 10603			PL, PL		16-21-A160-TC10				
35 - 10610			HB,CL,HB	12DO-CL-M	12-29-N144-HC				
35 - 10604			HB, CL, HB	14DO-CL-M	14-29-N149-HC				
35 - 10601			HB, MP, HB		16-29-N155-HC				
35 - 12338			ST, ST		16-41-A160-PS				
			ST, ST		20-41-A170-PS				
35 - 12341			DT, DT	20XO-HS-EC	20-41-050-PH				
			PL, PL		18-01-A164-TC				
35 - 12347			RN,	18BO-RN-UHL	18-01W-K172-TC12				
35 - 10599			PL, PL		16-01-K266-TC				
			PL, PL		18-01W-K2-TC				
35 - 10612			PL, PL		16-18-A260-TC11				
35 - 12335			PL, PL		16-81-A260-PS				
35 - 10611			PL, PL		18-81-A268-TC11				
35 - 12331			ST, ST		16-01W-A160-PS				
35 - 12332			ST, MP	20AO-RN-UHL	20-01W-A170-PS				
35 - 12352			ST, MP	18A8-RN-UHL	18-01W-A164-PS				
35 - 12338			ST, ST		16-41-A160-PS				
			ST, ST		20-41-A170-PS				
35 - 12342			ST, ST	16AO-RN-HV	16-81-A160-PS				
35 - 12343			ST, ST	18AO-RN-HV	18-81-A168-PS				
35 - 12344			ST, ST	20AO-RN-HV	20-81-A172-PS				
35 - 12349			ST, ST	16A8-RM-HV	15-81-A256-PS				
35 - 12345			ST, ST	20A8-RN-HV	20-81-A272-PS				
35 - 12336			ST, ST		24-81-A284-PS				
35 - 12341			DT, DT	20XO-HS-EC	20-41-050-PH				
			DT, DT		20-41-A170-PS				
35 - 12346			DT, DT	20XO-HS-HV	20-81-050-PH				
35 - 12349			ST, ST	16A8-RN-HV	15-81-A256-PS				
35 - 12336			ST, ST		24-81-A284-PS				
35 - 12337			ST, ST	24AO-RN-HV	24-81-A184-PS				

35 CHAIN SAW BAR

CHAIN SAW BARS



Manufacturer and Model Numbers	Bar Length	Gauge	Pitch	Drive Links	ARCHER BARS		
					Order Number		
McCULLOCH							
PRO 35, 40, Mini Mac, ser., PM 6, PM 12, PM ser. (155, 310, 320, 330, 340, 355, 360, 364, 370, 374, 375, 384, 470, 474, 480, 484, 494, 510, 515), C180, Eager Beaver, M2, M4, 3500, 4000, California, Statesmen, Mac 110, 120, 130, 115, 140, 170, E 12, E 14, E 16, Titan 35, 40, Titan 7, E30ES, E35ES, E40	12	50	3/8 LP	44	35 - 13305		
	14	50	3/8 LP	49			
	16	50	3/8 LP	54			
Pro Mac 10-10S, PM 484, Mac 120, 930, 935, 940, 8200, D.E. 50, D.E. 80	16	50	3/8	60			
1-10, 2-10, 3-10, 4-10, 5-10, 6-10, 7-10, 10-10, 55, 555, 560, 605, 610, 620, 645, 650, 655, 700, 800, 850, 1000, 5700, 8200, CP55, CP70, DBL EAGLE, MAC120, PROMAC, SILVER EAGLE, 3420, 3270, SP60, SP70, SP80, TIMBER BEAR, TITAN 50, 57, 70	20	50	3/8	70			
	20	50	3/8	70			
	20	50	.325	78			
1-10, 2-10, 3-10, 4-10, 5-10, 6-10, 7-10, 10-10, 55, 555, 560, 605, 610, 620, 645, 650, 655, 700, 800, 850, 1000, 5700, 8200, CP55, CP70, DBL EAGLE, MAC120, PROMAC, SILVER EAGLE, 3420, 3270, SP60, SP70, SP80, TIMBER BEAR, TITAN 50, 57, 70	16	50	3/8	60			
	20	50	3/8	70			
OLEO-MAC/OLYMPYK							
233, 234, 240, 241, 244, 335, 340, OM-3200, 140EF, 930, 935, 940, 942, 945, 946, 950, 951	12	50	3/8 LP	44	35 - 13309		
	14	50	3/8 LP	50			
	16	50	3/8 LP	56			
	16	58	.325	66	35 - 13310		
	18	58	.325	72			
18	50	3/8	64				
930, 935, 940, 942, 945, 946, 950, 951	16	50	3/8	60	35 - 13327		
	18	50	3/8	64			
	20	50	3/8	71			
PARTNER							
P-48, P-49, 405, 540, 545, 400, 450, 465, 495, 500, 550, 605, 5000, 1400 EL, 1450 EL, 1650 EL, Mini Farmer Saw, 5500, 360	18	50	3/8	64			
	16	58	.325	66			
	18	58	.325	72			
F55, F65, R-series, S50, S55, S65, P55, P65, P70, 7000, P85, P52, P45, P100, 650, 660, 7700	16	50	3/8	60	35 - 13328		
	18	50	3/8	68			
	20	50	3/8	72			
	20	58	3/8	72			

35

CHAIN SAW BAR



CHAIN SAW BARS

CARLTON BARS			Style	Archer Part No.	Carlton Part No.	CARLTON Bar & Chain Combo.			
Order Number						Carlton Part No.	Order Number		
35 - 10610 35 - 10604 35 - 10601			HB, MP, HB HB, MP, HB HB, MP, HB	12DO-CL-M 14DO-CL-M	12-29-N144-HC 14-29-N149-HC 16-29-N155-HC				
35 - 10609			PL, PL		16-14-A160-TC				
			PL, PL PL, PL		20-41-A170-TC 20-41-A170-PS				
			RN, PL RN, PL ST, ST	16AO-RN-MC 20AO-RN-MC	16-41-A160-PS				
35 - 10575 35 - 10571 35 - 10599			HB, MP, HB HB, MP, HB HB, MP, HB	12DO-CL-SW 16DO-CL-SW	12-26-N144-HC 14-26-N150-HC 16-26-N155-HC				
			PL, HB PL, HB		16-01-K266-HC 18-01W-K2-HC				
			PL, PL		18-01-A164-TC10				
35 - 12331 35 - 12348 35 - 12332			ST, ST ST, MP ST, MP	18A8-RN-UHL 20AO-RN-UHL	16-01W-A160-PS 18-01W-A264-PS 20-01W-A170-PS				
			PL PL, PL		18-01-A164-TC				
35 - 10599			PL, PL PL, PL		16-01-K266-TC 18-01W-K2-TC				
35 - 12342 35 - 12343 35 - 12344 35 - 12345			ST, ST ST, ST ST, ST ST, ST	16AO-RN-HV 18AO-RN-HV 20AO-RN-HV 20A8-RN-HV	16-81-A160-PS 18-81-A168-PS 20-81-A172-PS 20-81-A272-PS				

35

CHAIN SAW BAR

CHAIN SAW BARS



Manufacturer and Model Numbers	Bar Length	Gauge	Pitch	Drive Links	ARCHER BARS		
					Order Number		
PARTNER (CONT'D)							
P-48, P-49, 405, 540, 545, 400, 450, 465, 495, 500, 550, 605, 5000, 1400EL, 1450EL, 1650 EL, Mini Farmer Saw, 5500, 360	16	50	3/8	59	35 - 13321 35 - 13327		
	20	50	3/8	70			
	18	58	3/8	64			
F55, F65, R-SERIES, S50, S55, S65, P55, P65, P70, 7000, P85, P52, P45, P100, 650, 660, 7700	16	58	3/8	60	35 - 13329		
	24	58	3/8	84			
F55, F65, R-series, S50, S55, S65, P55, P65, P70, 7000, P85, P52, P45, P100, 650, 660, 7700	20	50	3/8	72	35 - 13311		
P-48, P-49, 405, 540, 545, 400, 450, 465, 495, 500, 550, 605, 5000, 1400 EL, 1450 EL, 1650EL, Mini Farmer Saw, 5500, 360	16	50	3/8	59	35 - 13315		
	20	50	3/8	70			
POULAN							
1800, 2000, 2300AV, 2300CVA, MICRO 25, S 25CVA, S 25D, P 600, 20 SERIES, 25 SERIES, 180, 190, 200, 205, PP210, 225, 235, 250, 255, 260, PP260, 285, 295, PP300E, 305, 306, 310, 325, 335, 336, 380, 523, 1220, 1425, 1625, 1800, 2000, 2050, 2100, 2150, 2250, 2300, 2350, 2375, 2400, 2450, 2500, 2550, 2600, 25A, 180, 190, 200, WOODSHARK, 205, 210, 225, 230, 235, 236, 240, 255, 260, 1420, 1950, 2075, E14E, E16E, MICRO25, XX SERIES, XXV SERIES, S23, S25 SERIES	12	50	3/8 LP	45	35 - 13302 35 - 13303		
	14	50	3/8 LP	52			
	16	50	3/8 LP	56			
	18	50	.325	72			
	20	50	.325	78			
2100, 2150, 2250, 2300, 2350, 2375, 2400, 2450, 2500, 2550, 2600, 25A, 180, 190, 200, WOODSHARK, 205, 210, 225, 230, 235, 236, 240, 255, 260, 1420, 1950, 2075, E14E, E16E, MICRO25, XX SERIES, XXV SERIES, S23, S25 SERIES	20	50	.325	78			
203, 230, 245, 306, 325, 360, 361, 375, 380, 395, 400, 415, 425, 445, 450, 475, 505, 670, 3400, 3600, 3700, 3800, 3900, 4000, 4200, 4400, 4900, 5200, 5400, 5500, 6700, 6900, 7700, 8500, AWP428, 200, 300, 400 SERIES, *375, *395 * REQUIRES SPACERS	16	50	3/8	60			
	20	50	3/8	70			
	20	50	3/8	70			
	24	58	3/8	84			
Poulan Pro 325	16	58	.325	66			
	18	58	.325	72			
245, 306, 361, 3400, 3700, 3800, 4000, 4200, 4400, 4900, 5200, 5400, 6900, 200 ser., 300 ser., 400 ser., 7700, 8500	16	50	3/8	60			
	20	50	3/8	70			
	24	50	3/8	81			
RED MAX							
G300	12	50	3/8 LP	45	35 - 13302 35 - 13303		
	14	50	3/8 LP	52			
	16	50	3/8 LP	57			

35 CHAIN SAW BAR



CHAIN SAW BARS

CARLTON BARS			Style	Archer Part No.	Carlton Part No.	CARLTON Bar & Chain Combo.			
Order Number						Carlton Part No.	Order Number		
35 - 12331			ST, ST		16-01W-A160-PS				
35 - 12332			ST, MP	20AO-RN-UHL	20-01W-A170-PS				
35 - 12352			ST, MP	18A8-RN-UHL	18-01W-A164-PS				
35 - 12349			ST, ST	16A8-RN-HV	15-81-A256-PS				
35 - 12336			ST, ST		24-81-A284-PS				
35 - 12346			DT, DT	20XO-HS-HV	20-81-050-PH				
35 - 12333			DT, DT DT, DT	16XO-HS-UHL	16-01W-050-PH 20-41-A170-PS				
35 - 10597			HB, CL, HB	12DO-CL-PO	12-10-N145-HC				
35 - 10596			HB, CL, HB	14DO-CL-PO	14-10-N152-HC				
35 - 10595			HB, MP, HB		16-10-N157-HC				
35 - 13082			TC		18-09-K172-TC				
35 - 13085			HC		20-10W-K1-HC				
35 - 10603			PL, PL	16HL50SPYA	16-21-A160-TC10				
35 - 12336			PL, PL PL, PL		20-41-A170-PS 24-81-A284-PS				
35 - 10599			PL, PL PL, PL	16-01-K266-TC 18-01W-K2-TC					
35 - 10597			HB, CL, HB	12DO-CL-PO	12-10-N145-HC				
35 - 10596			HB, CL, HB	14DO-CL-PO	14-10-N152-HC				
35 - 10595			HB, HB		16-10-N157-HC				

35
CHAIN SAW BAR

CHAIN SAW BARS



Manufacturer and Model Numbers	Bar Length	Gauge	Pitch	Drive Links	ARCHER BARS		
					Order Number		
SEARS							
41512, 41514, 41519, 41521, 41524, 41526,	12	50	3/8 LP	45	35 - 13302		
41616, 51519, 59042, 59406, 59414,	14	50	3/8 LP	52			
59512, 59521, 59522, 59524, 59525,	16	50	3/8 LP	57			
59526, 59714, 59816, 59819, 59824, 59826,							
59880, 59883, 59884, 59886, 59887							
SHINDAIWA							
101, 102, 103, 104, 105, 107, 110, 113,	12	50	3/8 LP	45	35 - 13302		
117, 140, 160, 180, 300, 340, 345, 350,	14	50	3/8 LP	52			
355, 360, 415, 416, 420, 440, 450, 451,	16	50	3/8 LP	57	35 - 13303		
480, 500, 510, 560	18	50	3/8 LP	62			
575, 580, 680, 685, 695, 757	16	58	3/8	60			
	18	58	3/8	68			
575, 580, 680, 685, 695, 757	16	50	3/8	60	35 - 13328		
	18	50	3/8	68			
	20	50	3/8	72	35 - 13322		
	20	58	3/8	72			
575, 580, 680, 685, 695, 757	16	58	3/8	60	35 - 13320		
	16	58	3/8	60			
	24	58	3/8	84			
575, 580, 680, 685, 695, 757	20	50	3/8	72	35 - 13329		
575, 580, 680, 685, 695, 757	20	50	3/8	72	35 - 13311		
	20	63	3/8	72	35 - 13316		

35

CHAIN SAW BAR



CHAIN SAW BARS

CARLTON BARS			Style	Archer Part No.	Carlton Part No.	CARLTON Bar & Chain Combo.			
Order Number						Carlton Part No.	Order Number		
35 - 10597			HB, CL, HB	12DO-CL-PO	12-10-N145-HC				
35 - 10596			HB, CL, HB	14DO-CL-PO	14-10-N152-HC				
35 - 10595			HB, MP, HB		16-10-N157-HC				
35 CHAIN SAW BAR									
35 - 10597			HB, CL, HB	12DO-CL-PO	12-10-N145-HC				
35 - 10596			HB, CL, HB	14DO-CL-PO	14-10-N152-HC				
35 - 10595			HB, MP, HB		16-10-N157-HC				
35 - 10613			HB, CL, HB	18DO-CL-PO	18-10-N162-HC				
35 - 10612			PL, PL		16-81-A260-TC11				
35 - 10611			PL, PL		18-81-A268-TC11				
35 - 12342			RN, ST	16AO-RN-HV	16-81-A160-PS				
35 - 12343			RN, ST	18AO-RN-HV	18-81-A168-PS				
35 - 12344			ST, ST		20-81-A172-PS				
35 - 12345			ST, ST	20A8-RN-HV	20-81-A272-PS				
35 - 12349			ST, ST	16A8-RN-HV	15-81-A256-PS				
35 - 12335			ST, ST		16-81-A260-PS				
35 - 12336			ST, ST		24-81-A284-PS				
35 - 12346			DT, DT	20XO-HS-HV	20-81-050-PH				
35 - 12353			DT, DT	20X3-HS-HV	20-81-063-PH				

35

CHAIN SAW BAR

CHAIN SAW BARS



Manufacturer and Model Numbers	Bar Length	Gauge	Pitch	Drive Links	ARCHER BARS		
					Order Number		
SOLO							
634, 639, 641, 644, 645, 647, 651, 654	16	58	.325	67			
	18	58	.325	73			
662, 667, 670, 680, 603, 690	16	58	3/8	60			
	18	58	3/8	68			
662, 667, 670, 680, 603, 690	16	58	3/8	60	35 - 13329		
	20	58	3/8	72	35 - 13320		
	24	58	3/8	84	35 - 13324		
STIHL							
009, 010, 011, 012, 015, E10, 021, E14, AVH Electronis 023, 025, 020T	12	50	3/8 LP	44	35 - 13309		
	12	43	3/8 LP	44			
	14	50	3/8 LP	50			
	14	43	3/8 LP	50			
	16	43	3/8	55			
	16	50	3/8 LP	55	35 - 13310		
024, 026, 028, 029, 030, 031, 032, 034, 036, 038, 039, 040, 041, 042, 044, 045, 048, 056, 064, 066, E15, E20	16	63	.325	67			
	16	63	.325	67			
	16	50	3/8	60			
	16	43	3/8	55			
	18	63	.325	68			
	18	63	.325	74			
024, 026, 028, 029, 030, 031, 032, 034, 036, 038, 039, 040, 041, 042, 044, 045, 048, 056, 064, 066, E15, E20, 026C	16	50	3/8	60	35 - 13323		
	16	63	3/8	60			
	20	50	3/8	72			
	20	63	3/8	72	35 - 13326		
	25	50	3/8	84			
024, 026, 028, 029, 030, 031, 032, 034, 036, 038, 039, 040, 041, 042, 044, 045, 048, 056, 064, 066, E15, E20	20	50	3/8	72	35 - 13312		
	24	63	3/8	84			
	28	50	3/8	91			
	28	63	3/8	91			
	30	63	3/8	100			
	32	63	3/8	105			
	36	63	3/8	114			
TAS / TANAKA							
ECS 290, ECS 300, ECS 320, ECS 330,	12	50	3/8 LP	45	35 - 13302		
ECS 350, ECS 355, ECS 405,	14	50	3/8 LP	52	35 - 13303		
ECS 3500, ECS 360, ECS 370	16	50	3/8 LP	57			
	18	50	3/8 LP	62	35 - 13304		

CHAIN SAW BAR 35



CHAIN SAW BARS

CARLTON BARS			Style	GB Part No.	Carlton Part No.	CARLTON Bar & Chain Combo.			
Order Number						Carlton Part No.	Order Number		
35 - 10599			PL, PL		16-01-K266-TC				
35 - 10612			PL, PL		18-01W-K2-TC				
35 - 10611			PL, PL		16-81-A260-TC11				
35 - 10611			PL, PL		18-81-A268-TC11				
35 - 12349			ST, ST	16A8-RN-HV	15-81-A256-PS				
35 - 12345			ST, ST	20A8-RN-HV	20-81-A272-PS				
35 - 12337			ST, ST	24AO-RN-HV	24-81-A184-PS				
35 - 10575			HB, CL, HB	12DO-CL-SW	12-26-N144-HC	600757CA	35 - 13066		
35 - 12433			HB, MP, HB		12-26-N4-HC	600743CA			
			HB, MP, HB		14-26-N150-HC	600758CA			
35 - 12538			HB, MP, HB		14-26-N4-HC				
35 - 10571			HB, MP, HB		16-26-N4-HC				
35 - 10571			HB, CL, HB	16DO-CL-SW	16-26-N155-HC	600747CA			
35 - 10572			PL, PL		16-42-K367-TC	600749CA			
35 - 13223					16-42-K367-PS				
35 - 10574			PL, PL		16-42-A160-TC				
35 - 13186					18-26-K368-TC				
35 - 12355			HB, ST	16AO-RN-SN	16-42-A160-PS	600748CA	35 - 13076		
35 - 12356			ST		16-42-A360-PS				
35 - 12357			ST, ST		20-42-A172-PS				
35 - 12358			ST, ST	20A3-RN-SN	20-42-A372-PS	600756CA			
			ST, ST		20-42-A184-PS				
35 - 13120			PS		36-D025-A3-PS				
35 - 10597			HB, CL, HB	12DO-CL-PO	12-10-N145-HC				
35 - 10596			HB, CL, HB	14DO-CL-PO	14-10-N152-HC				
35 - 10595			HB, MP, HB		16-10-N157-HC				
35 - 10613			HB, MP, HB	18DO-CL-PO	18-10-N162-HC				

35

CHAIN SAW BAR



CHAIN SAW SPROCKETS

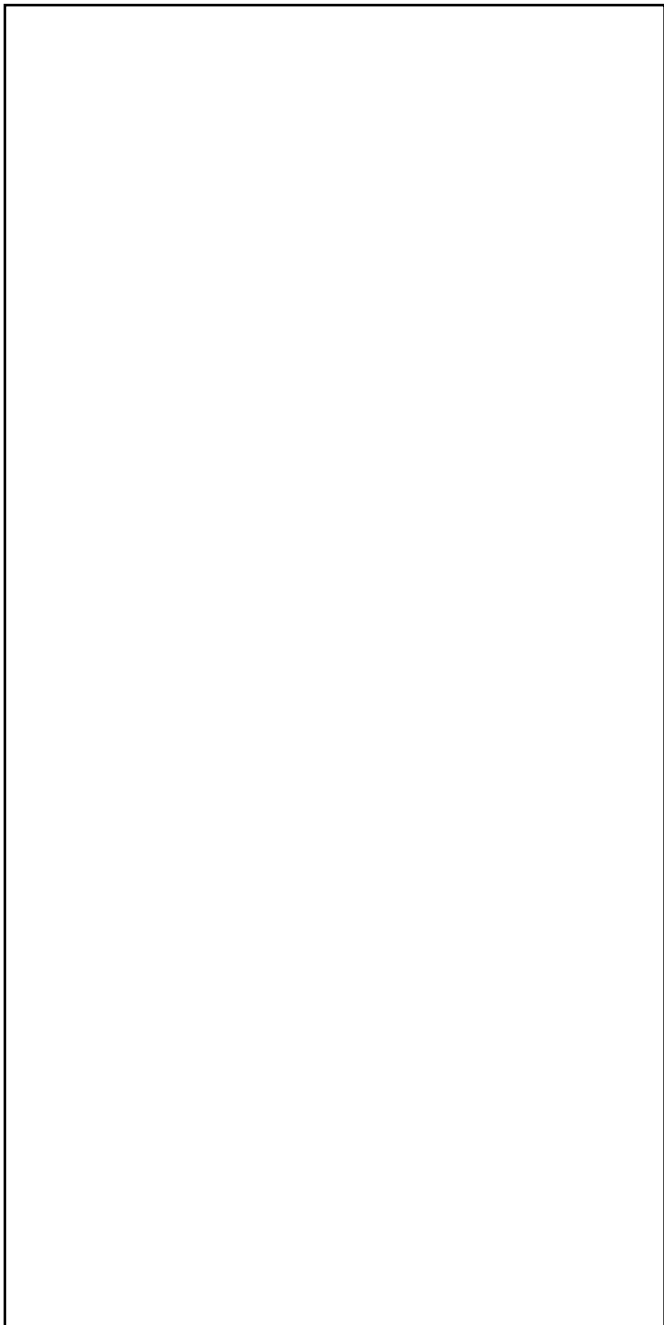
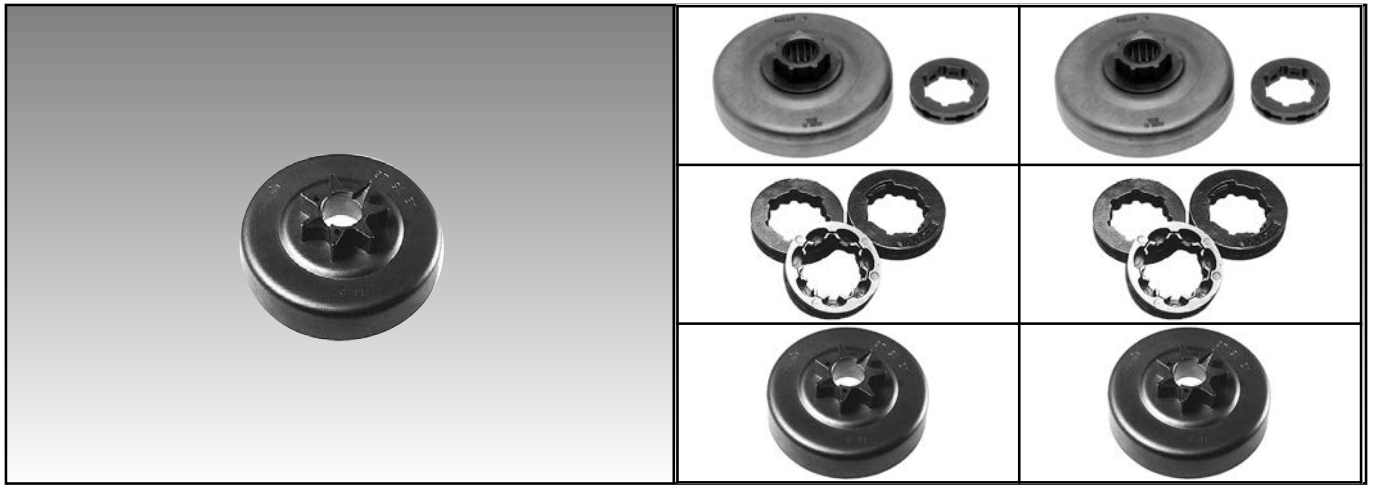

Quick-Glance

CHAIN SAW SPROCKETS	PG.
Open Spur Sprockets	1174-1176
EZ-Drive Sprockets	1177
Rim Sprockets	1176, 1177

CHAIN SAW SPROCKETS



Open Spur

Top Quality Sprockets

Chain Saw Brand	Models	Pitch	No. Teeth	Herr Mfgr. No.	Order No.		
ALLIS CHALMERS	75, 75A, 95	3/8 LP	6	B225-M6	36 - 4360		
ALPINA-CASTOR	A-40-AY, 41, 45	.325	7	N110-L7	36 - 1600		
DANARM	1-35, 1-36SS	3/8 LP	6	N217-M6	36 - 1618		
DAYTON (W.W. GRAINGER)	2Z573, 4Z970	3/8 LP	6	B225-M6	36 - 4360		
DOLMAR	122, 123, 133, 143, CA	.404"	7	50010	36 - 12029		
ECHO	CS-4000, CS-4500, CS-4600, CS-5000, CS-5500	.325"	7	50150	36 - 12042		
	CS-650, CS-660	3/8"	7	50155	36 - 12039		
	CS-400, CS-440, CS-3900	.325"	7	EC206J7N	36 - 12038		
	CS-602, CS-702, CS-750	3/8"	7	50140	36 - 12035		
	CS-451, CS-452, CS-500, CS-510, CS-550, CS-610, CS-650, CS-660	3/8	7	355-A7	36 - 4387		
	CS-3000, CS-3400, CS-3450	3/8 LP	6	359-M6	36 - 1627		
FRONTIER	Mark I, Mark II VIP, F35, FB35	3/8 LP	6	N217-M6	36 - 1618		
HOMELITE	110 (Electric)	3/8 LP	6	N217-M6	36 - 1618		
	190, XL Mini, SXL Mini AO, XL101, XL, XL2, XEL, Super 2, VI Super 2, Super 2CC, (2-3/8" clutch & 3/8" shaft)	3/8 LP	6	N158-M6	36 - 1640		
	150AO, EZ 250AO, XL Mini, XL101, VI123, XL76, (w/o Brake) EZ, EZ Auto, SEZ AO, SXL Mini AO, 330,*350, 360, 410, (Model with 2-5/8" clutch, 5/8" shaft) *Note: units with "S" clutch	3/8	7	N157-A7	36 - 1656		
	XL-12, (Before Serial 1735838), XL15, XL400, XL500, XL600, XL700, C-52 (small hole)	3/8	7	N147-A7	36 - 1644		
	XL-12, (After Serial 1735838), XLAuto, SXL Auto, 450, 450W, 450HG, 450SL, 550 XL800, XL850, XL870, XL875, XL901, XL903, XL904, XL913, XL914, XL922, XL924, VI944, VI955, SXL925, (6 Shoe Clutch) Large Hole	3/8	7	N148-A7	36 - 1646		
	240, 245	3/8 LP	6	N152-M6	36 - 4391		

N prefix denotes with bearing type B or no first letter denotes bushing type.



CHAIN SAW SPROCKETS



Open Spur

Top Quality Sprockets

Chain Saw Brand	Models	Pitch	No. Teeth	Herr Mfg. No.	Order No.		
HUSQVARNA	61 (After No. 0510572), 266, (After No. 051...) 268 (After No. 051...), 272 (After No. 051...)	3/8	7	N304-A7	36 - 4381		
	Husky Jr. 121 33, 34, 35, 37, 38	3/8 LP 3/8 LP	6 6	B225-M6 N217-M6	36 - 4360 36 - 1618		
	77, 160, 163, 180, 260, 263, 280, 380, 480, I-65 50, 51, 55, 154, 254, 262	3/8 .325	7 7	50415 N110-L7	36 - 1600		
	36, 41	.325 3/8" LP	7 6	266-L7 266-M6	36 - 1602 36 - 1603		
	40, 45 340, 345, 350, 351, 346XP	.325 .325	7 7	N265-L7 HU414-J7N	36 - 1604 36 - 10819		
JOBU	SL-2, SL-21	3/8 LP	6	N217-M6	36 - 1618		
	949, 949S, LF50, LF50B	.325	7	N110-L7	36 - 1600		
JOHN DEERE	28, 30, 35, 40V	3/8 LP	6	354-M6			
	50V, 55V, 65EV	3/8	7	355-A7	36 - 4387		
	65EV	3/8"	7	50155	36 - 12039		
	45	.325"	7	EC206J7N	36 - 12038		
	60V, 70V, 80EV	3/8"	7	50140	36 - 12035		
JONSERED	Lil'Jon, Lil'Jon Auto	3/8 LP	6	B225-M6	36 - 4360		
	490, 590	.325	7	N110-L7	36 - 1600		
	36, 361, 365, 370	3/8 LP	6	N217-M6	36 - 1618		
	2036, 2040	.325 3/8 LP	7 6	266-L7 266-M6	36 - 1602 36 - 1603		
	2041, 2045, 2050	.325	7	N265-L7	36 - 1604		
	2150, 2250	.325	7	HU414-J7N	36 - 10819		
LOMBARD	Pony	3/8 LP	6	N217-M6	36 - 1618		
McCULLOCH	Mini-Mac, Mini-Mac 6, 25, 30, 35 Mac 6,110-140, 3214, 3216, 3516, 3818, PowerMac 310-340, 365, 480, ProMac 3205, 3805, Super Pro 40, Titan 7, Titan 35, Titan 40	3/8 LP	6	N174-M6	36 - 1634		
	PRO MAC 55, 60, 155, 165, 355, 375, 515, 610, 650, 655, 700, 805, 850, SP-60, CP-70, SP-70, Mac 1-10 Thru 10-10	3/8	7	N176-A7	36 - 1660		
PARTNER	22, 330, 350, 1612, 1613, 1614, 1616	3/8 LP	6	N217-M6	36 - 1618		
	Homeowner 400, 500, 5000, P48, P49	.325	7	N110-L7	36 - 1600		
	365, 405	.325 3/8 LP	7 6	266-L7 266-M6	36 - 1602 36 - 1603		

N prefix denotes with bearing type B or no first letter denotes bushing type.

CHAIN SAW SPROCKETS



Open Spur

Top Quality Sprockets

Chain Saw Brand	Models	Pitch	No. Teeth	Herr Mfg. No.	Order No.		
PIONEER	P10, P12	3/8 LP	6	N217-M6	36 - 1618		
POULAN PRO	230, 260, 2050, 2075, 2150, 2175, 2250, 2550	3/8" LP	6	PO532-R6N	36 - 12046		
POULAN	360, 361, 400, 401, 450, 451	3/8	7	N227-A7			
	25, 25A, 25DA, Countervibe, S-25	3/8 LP	6	B225-M6	36 - 4360		
	20, Micro 25, 180, 205, 225, 235	3/8 LP	6	B224-M6	36 - 4359		
	1800, 2000, 2100, 2300, 2400	3/8	7	N230-A7	36 - 4307		
	375, 395, 3400, 3700, 3800, 4000	3/8	7	N231-L7	36 - 4355		
	285, 305, 335, 336, 365, 2800, 2900, 3000, 3300	.325	7	N110-L7	36 - 1600		
	325	.325	7	266-L7	36 - 1602		
	255, 295, 2500, 2600, 2750	.325	7	266-M6	36 - 1603		
	1800, 2000, 2300 (Models w/needle bearing)	3/8 LP	6	N232-M6	36 - 4359		
SEARS 2.3 (CRAFTSMAN)	35095, 35096, 35211, 35215, 35219, 35231, 35232, 35235, 35238, 35255, 35256, Explorer I, II	3/8 LP	6	B225-M6	36 - 4360		
	351062, 351142, 351161, 351181, 352161, 352180	3/8" LP	6	PO532-R6N	36 - 12046		
SKIL (PM-CANADIEN)	310, 944, 1600, 1601, 1602, 1610, 1611, 1612 (Electric), 1613, 1614, 1616, 1700, 1705, 1712	3/8 LP	6	N217-M6	36 - 1618		
STIHL	030AV, 031AV, 031AVE, 032AV, 040, 041, 041AV, 041AVE, (After No. 5664891...)	3/8	7	183-A7	36 - 1680		
	09, 010, 011	3/8 LP	6	081-M6	36 - 4396		
	028 (After No. 8991531)	.325	7	190-L7	36 - 4308		
	024, 026 (Before No. X25809074)	.325	7	191-L7	36 - 1617		
	029, 034, 036, 039	3/8	7	193-A7	36 - 1619		
	017, 021, 023, 025	3/8 LP	6	084-M6	36 - 1621		
WRIGHT (POULAN)	121, 122A	3/8 LP	6	B225-M6	36 - 4360		

CHAIN SAW RIM SPROCKETS



Order No.	Pitch	Description	Mfg. No.	
36 - 12582	3/8	8 tooth STD 7 spline	RST-375-8	MIN010
36 - 12583	.404	7 tooth STD 7 spline	RST-404-7	MIN010
36 - 12584	3/8	7 tooth STD 7 spline	RST-375-7	MIN010
36 - 12585	3/8	7 tooth Mini 7 spline	RMI-375-7	MIN010
36 - 12586	.325	8 tooth Small 7 spline	RMS-325-8	MIN010
36 - 12587	.325	7 tooth Mini 7 spline	RMI-325-7	MIN010
36 - 12588	3/8	7 tooth Small 7 spline	RSM-375-7	MIN010
36 - 12589	.325	7 tooth Small 7 spline	RSM-325-7	MIN010
36 - 12590	.404	8 tooth STD 7 spline	RST-404-8	MIN010
36 - 12591	.325	9 tooth STD 7 spline	RST-325-9	MIN010
36 - 12592	1/4	9 tooth Small 7 spline	RSM-250-9	MIN010

N prefix denotes with bearing type B or no first letter denotes bushing type.



CHAIN SAW SPROCKETS



EZ- DRIVE

Top Quality Sprockets

Chain Saw Brand	Models	Pitch	No. Teeth	Herr Mfgr. No.	Order No.
ALPINA-CASTOR	A-40-AY, 41, 45	.325	7	N110-24	36 - 8055
DAYTON (W.W. GRAINGER)	4Z251, 4Z397	3/8	7	N230-11	36 - 8058
DOLMAR	112, 113, 114, 116, 116SI, 117, 119, 120, 120SI, 120 SUPER	3/8"	7	DO158LCA7N	36 - 12036
ECHO	CS-302, CS-315, CS-330, CS-351, CS-360	3/8"LP	6	EC204SCA7N	36 - 12045
HUSQVARNA	Practica 61, Rancher 61, 66, 162, 266, 268, 272	3/8	7	N304-11	36 - 8061
	50, 51, 55, 154, 254, 262	.325	7	N110-24	36 - 8055
	50, 51, 55, 154, 254, 262	3/8"	7	HU411SCA7N	36 - 12044
JOBU	340, 345, 346XP, 350, 351, 353,	.325	7		36 - 13585
	949, 949S, LF50, LF50B	.325	7	N110-24	36 - 8055
JOHN DEERE	28, 30, 35, 35EV, 40	3/8"LP	7	EC204SCA7N	36 - 12045
JONSERED	490, 590	3/8"	7	HU411SCA7N	36 - 12044
		.325	7	N110-24	36 - 8055
	625, 630, 630 Super, 630WEST COAST, 670	3/8	7	N304-11	36 - 8061
	2141, 2145, 2149, 2150, 2151, 2152, 2159, 2245, 2250	.325	7		36 - 13585
MAKITA	DCS 6000i, DCS68001	3/8"	7	DO158LCA7N	36 - 12036
PARTNER	Homeowner 400, 500, 5000, P48, P49	.325	7	N110-24	36 - 8055
POULAN	325	.325	7	N110-24	36 - 8055
	375, 395, 3400, 3700, 3800, 4000	3/8	7	N230-11	36 - 8058
SEARS (CRAFTSMAN)	35885	3/8	7	N230-11	36 - 8058
STIHL	030AV, 031AV, 031AVE, 032AV, 040, 041, 041AV, 041AVE, (after # 5664891)	3/8	7	183-11	36 - 8062
	024, 026, MS260, MS270, MS240, MS280, MS281, (Replaces Stihl 1121-007-1037)	.325	7		36 - 14276
WESTERN AUTO	A-18, 3400	3/8	7	N230-11	36 - 8058

N prefix denotes with bearing type B or no first letter denotes bushing type.

36

CHAIN SAW RIM SPROCKETS

Order No.	Pitch	Description
36 - 1690	.325	7 tooth small 7 spline
36 - 1688	3/8 L.P.	7 tooth small 7 spline
36 - 1689	3/8 STD	7 tooth std. 7 spline
36 - 1686	.404	7 tooth std. 7 spline
36 - 9499	.325	8 tooth small 7 spline
36 - 9498	3/8	8 tooth std. 7 spline
36 - 10986	.325	7 tooth mini. 7 spline
36 - 10987	3/8	7 tooth mini. 7 spline



Tool steel rim sprockets designed for maximum strength and life. Available in the following pitches and sizes.

SPROCKETS



CHAIN SAW SPRINGS

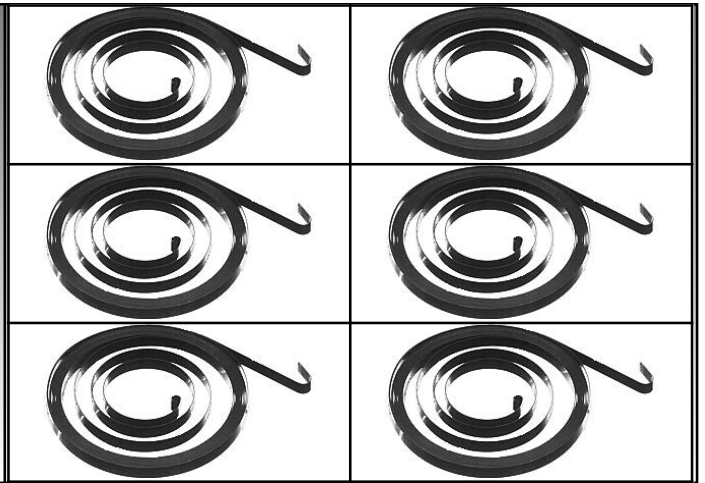
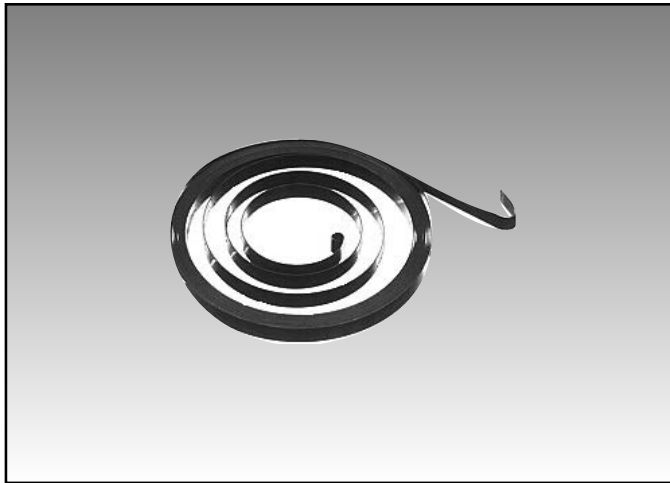

37

Quick-Glance

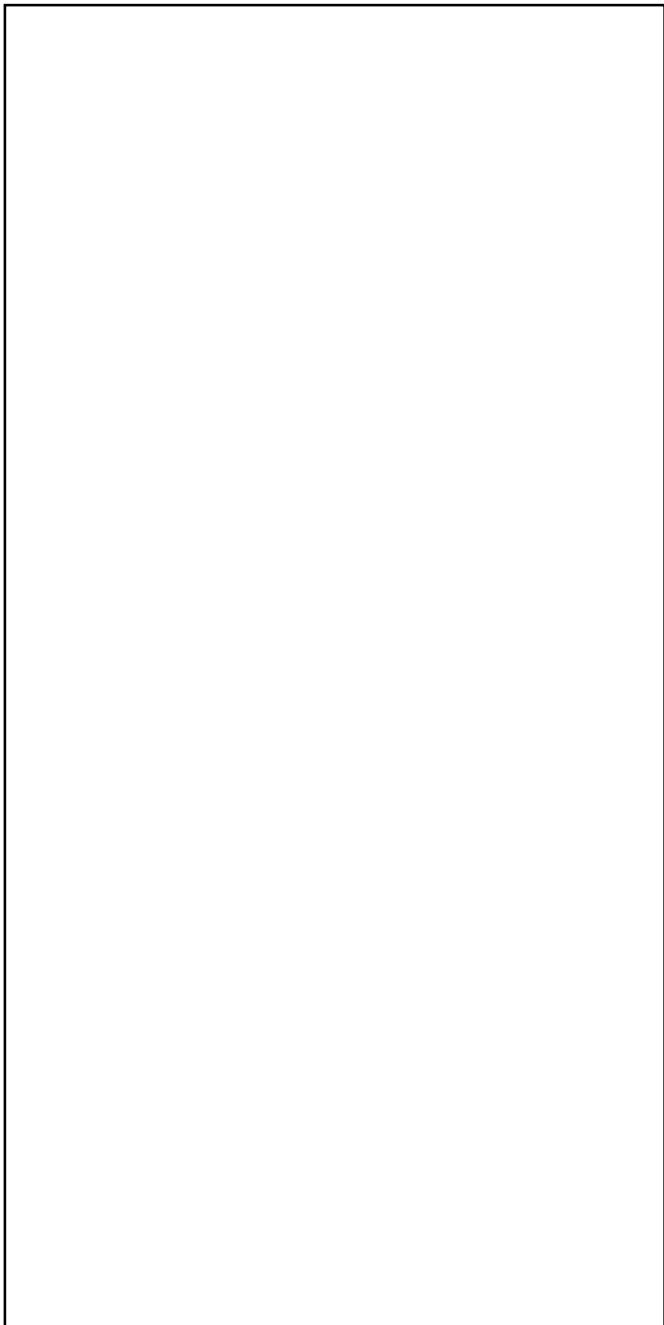

Quick-Glance

CHAIN SAW SPRINGS

PG.

Springs

1180-1181

CHAIN SAW SPRINGS



37

SPRINGS



OEM	Models	OEM No.	Order No.		
ECHO (KIORITZ)	451, 452, 500, 550, 600, 601, 602, 650, 701, 702, 750, 5500, 6700, 8000	177220 0283 4	37 - 3002		
	302, 351, 400, 440, 4600, 5000	177220 0393 0	37 - 3003		
FRONTIER TML	All Spring Only	100073	37 - 3048		
HOMELITE	EZ, Super EZ, Super EZAO, EL Mini, FP, Super XL Mini Auto, 150, 250, 350, 360	65107	37 - 1701		
	XL, XL2, Super 2, 190, 240	69217	37 - 3009		
HUSQVARNA	K750 & K960 Cut off saws	506 25 89 01	37 - 13056		
	61 Rancher, 162, 181, 266, 268, 272	50 15 204 01	37 - 3037		
	L65, 77, 160, 180, 280, 285, 380, 480	50 14 022 01	37 - 3012		
	36R, ALL Series, 44, 45, 140, 165R, 240, 244, 340, 444	50 14 604 01	37 - 3011		
	Older 34, 35	50 17 067 01	37 - 3048		
	41, 50 Rancher, 51, 55, 335XPT	50 17 631 01	37 - 3023		
	42, 133, 154, 242, 246	50 16 302 01	37 - 3082		
JONSEREDS	66E, 70E, 80, 90, 111-Super, 621, 801, 910E, 910EV, 920	504 21 26 01	37 - 3016		
	49SP, 50, 51, 52, 52E, 521EV	504 21 26 02	37 - 3017		
	490, 590	505 29 51 26	37 - 3046		
	450, 455, 510SP, 520SP, 525, 535	504 21 26 06	37 - 3041		
	M36, 361, 361E, 365, 370, 380	507 10 00 73	37 - 3048		
McCULLOCH	Pro Mac 10-10, 55, 60, 555, 570, 610, 650, 700, 800, 805, 850, 1010S, 5700, 8200, Super Pro 60, 70, 80, 81, Model 7-10A, Timber Bear	87680	37 - 3025		



OEM	Models	OEM No.	Order No.		
OLYMPIK (OLEO-MAC)	260, 261, 271, 460AS, 480AS, 481, 482, 482MP	60-00132	37 - 3026		
PARTNER	R16, 17, 18, 22, 30, 40, F55, K16, 20, 65, 650, 850, 1200, P55, 70, 100, 7000	295108	37 - 3013		
	500, 5000	505-295-126	37 - 3046		
	Mini P, P2, 3, 4, 330, 340, 350	504 35 27 05	37 - 3048		
POULAN					
SACHS DOLMAR	112, 114, 117, 119, 122, 144 -166, 308, 310	144 163 010 (119 163 010)	37 - 3060		
	112-133, 166, 307, 311	123 163 010	37 - 3061		
SKIL	1600-1616	F315882	37 - 3048		
STIHL	041, (#2663818 - #5816401), TS510, 051 (...#6745961)	1111-195-1600	37 - 3026		
	030, 031	1113-195-1600	37 - 3044		
	009, 010, 011, (...X12725130), 015	1116-195-1600	37 - 3045		
	026, 028, 032, 034	1118-190-0600	37 - 3068		
	020	1114-190-0600	37 - 3024		
	070, 08, 090, 510, TS350 (old model)	1106-190-0600	37 - 3034		
	038, 041 (#5816401...), 045, (#5919431...), 048, 050, 051, (#674961...), 056, 075, TS350	1117-190-0601	26 - 2445		
	017, 021, 023, 025, 029, 039	1129-190-0600	37 - 3080		
	BR500, BR550, BR600, Blowers TS410, TS420 Cut off Saws	4282-195-0300	37 - 13055		



CHAIN SAW CARBURETION

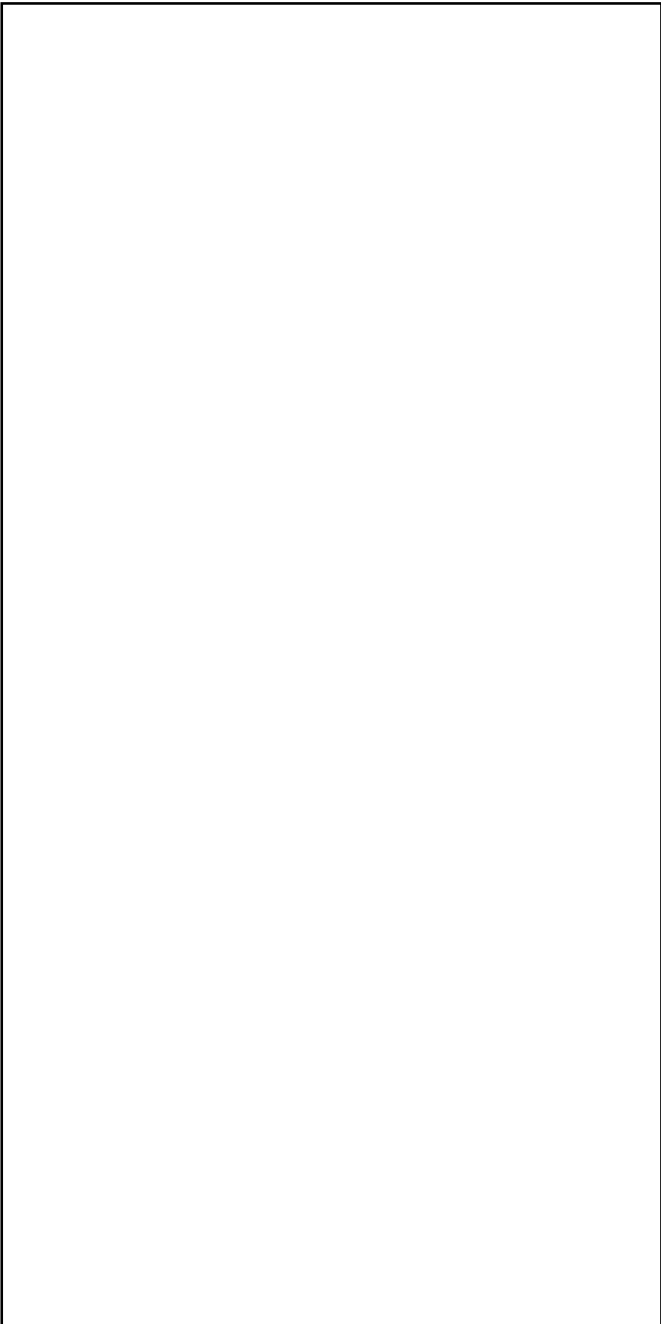
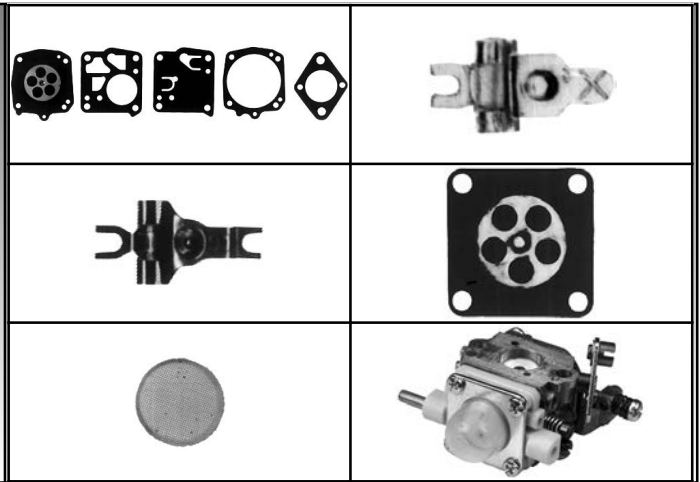

Quick-Glance

CHAIN SAW CARBURETION	PG.
Tillotson	
Fuel Screens	1189
Diaphragms	1189
Gaskets	1190
Carburetor Kits	1191
Stihl	
Carburetor Kits	1191, 1200
Walbro	
Fuel Lever	1192
Fuel Screens	1192
Welch Plugs	1192
Gaskets	1192-1194
Carburetor Kits	1194-1197
Zama	
Carburetor Kits	1196, 1200-1201
Gaskets	1198-1199
TK	
Carburetor Kits	1197-1198
Gaskets	1197
Fuel Line	1203-1206



CHAIN SAW CARBURETION

Repair Parts Assortment for WA & T WALBRO Carburetors

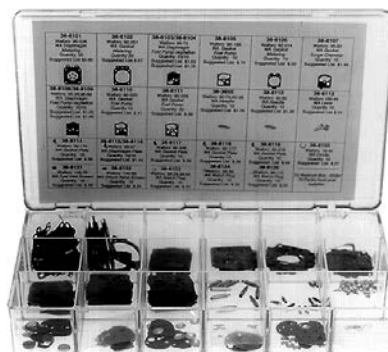

Order No. 01 - 6576

Repair Parts Assortment for WA & T Walbro Carburetors. Contains the diaphragms and gaskets for the Walbro WA, WT and WTA carburetors. Assortment contains 270 pieces.

Replacement packages of parts also available. See Display & Assortments for order numbers.

38

CARBURETION

Intake Gasket Assortment



Order No. 01 - 6577

Intake Gasket Assortment. Contains 13 different intake gaskets for Walbro, Tillotson, Zama and TK. Assortment contains 137 pieces.

Replacement packages of parts also available. See Display & Assortments for order numbers.

Repair Parts Assortment for ZAMA Carburetors

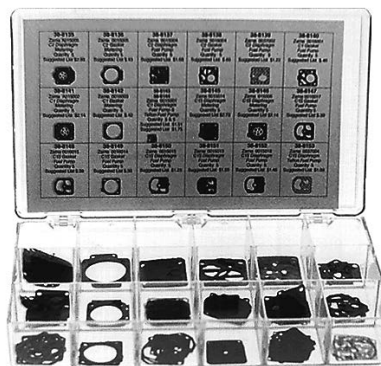

Order No. 01 - 6578

Repair Parts Assortment for Zama Carburetors. Contains the diaphragms and gaskets for the Zama C1, C1S and C2 carburetor series. Assortment contains 95 pieces.

Replacement packages of parts also available. See Display & Assortments for order numbers.



CHAIN SAW CARBURETION

Repair Parts Assortment for TILLOTSON Carburetors



Order No. 01 - 6579

Repair Parts Assortment for Tillotson Carburetors. Contains all the diaphragms and gaskets for the Tillotson HS & HU carburetors. Assortment contains 550 pieces.

Replacement packages of parts also available. See Display & Assortments for order numbers.

Chain Saw & Trimmer Filter Assortment



Order No. 01 - 7203

Chain Saw Filter Assortment contains fuel filters for Stihl, Homelite, Tillotson, Tecumseh and McCulloch. Assortment contains 80 pieces. Refills available in multiples of 10.

Replacement packages of parts also available. See Display & Assortments for order numbers.

Jet Needle for SHINDAIWA



Order No. 38 - 7925

Jet Needle replaces Shindaiwa 20000-81170. Fits models T25, C25, C35.

Fuel Levers for TILLOTSON



Order No. 38 - 3668

Replaces Tillotson 155A26. Fits HS series.

MIN010



Order No. 38 - 8113

Replaces Tillotson 155A-29. Fits HU series.

MIN010

Fuel Inlet Needles for TILLOTSON



Order No. 38 - 3655

Replaces Tillotson 34-216. Fits HS series carburetors and Walbro 82-75.

MIN010



CHAIN SAW CARBURETION

Zama Carburetor for ECHO



Order No. 22 - 11179

Zama carburetor replaces Echo A02100380 & A021000381. Fits Echo models GT200, GT201, SRM200, SRM201, SRM130, SRM231, HC160, HC180 & HC200. Zama RB-K66A, RB-K70A.

Zama Carburetor for ECHO



Order No. 22 - 11178

Zama carburetor replaces 12520013123. Fits Echo model TC2100. Zama C1U-K54A.

38

CARBURETION

Zama Carburetor for ECHO

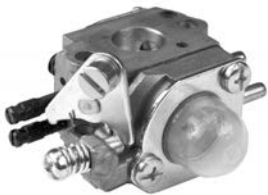

Order No. 22 - 11177

Zama carburetor replaces Echo 12520013312. Fits Echo models SRM2100, GT2000, GT2100, ST2000SB, PAS and PDSR. Zama C1U-K52.

Zama Carburetor for ECHO



Order No. 22 - 11176

Zama carburetor replaces Echo 12520005962. Fits Echo models HC1500, HC1600, HC2000, HC2410, HC2400 and HCR1500. Zama C1U-K51.

Zama Carburetor for ECHO



Order No. 22 - 11175

Zama carburetor replaces Echo 125200-20561. Fits Echo models PB2100. Zama C1U-K42B.

Zama Carburetor for ECHO



Order No. 22 - 11170

Zama carburetor replaces Echo 12520008664. Fits Echo models PB602, PB603, PB610 & PB611. Zama C1M-K49C.



Walbro Carburetor for ECHO



Order No. 22 - 11164

Walbro carburetor replaces Echo 12300057730. Fits model SRM2601 trimmers. Walbro WYJ-192.

Walbro Carburetor for ECHO



Order No. 22 - 11165

Walbro carburetor replaces Echo 12300051730. Fits Echo model SRM2601. Walbro WYJ-220.

Walbro Carburetor for ECHO



Order No. 22 - 11163

Walbro carburetor replaces Echo 12300040630. Fits Echo models SRM2000, SRM2200 & GT22000 trimmers and hedge trimmers. Walbro WY-18.

Walbro Carburetor for ECHO



Order No. 22 - 11155

Walbro carburetor replaces Echo 12300052133. Fits Echo model GT2400. Walbro WT-424, Zama C1U-K23B.

Walbro Carburetor for POULAN

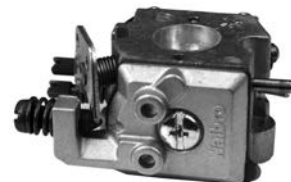

Order No. 22 - 11151

Walbro carburetor replaces Poulan 530069651. Fits Poulan model GT1. Walbro WT-298.

CHAIN SAW CARBURETION



Walbro Carburetor for RED MAX



Order No. 22 - 11147

Walbro carburetor replaces Red Max 1148-81001. Fits model GSK30D brushcutter, GOPEDS, KOMATSU ZENOAH G2, D8 and G230 PU. Walbro WA-167.

Walbro Carburetor for RYOBI



Order No. 22 - 11157

Walbro carburetor replaces Ryobi 7843. Fits Ryobi trimmer models. Walbro WT-539.

Walbro Carburetor for SHINDAIWA



Order No. 22 - 11168

Walbro carburetor replaces Shindaiwa 70036-81002. Fits Shindaiwa model T20 trimmers. Walbro WZ-8C.

Walbro Carburetor for SHINDAIWA



Order No. 22 - 11166

Walbro carburetor replaces Shindaiwa 20016-81020 & 20016-81021. Fits Shindaiwa model S230. Walbro WYL-19.

Walbro Carburetor for STIHL



Order No. 22 - 11150

Walbro carburetor fits Stihl models 4133FS & 4226. Walbro WT-227, WT-264.

Walbro Carburetor for STIHL



Order No. 22 - 11145

Walbro carburetor fits Stihl models BR400. Walbro HD-4.

Walbro Carburetor for STIHL



Order No. 22 - 11148

Walbro carburetor fits Stihl models FS51, 61, 65, 85 & 90 trimmers. Walbro WT-38.

Welch Plugs for TILLOTSON

Order No. 38 - 8157

Replaces Tillotson 179-62. Fits HU series. MIN010

Order No. 38 - 8160

Replaces Tillotson 179-59. Fits HS series. (large) MIN010

Order No. 38 - 8161

Replaces Tillotson 179-60. Fits HS series. (small) MIN010

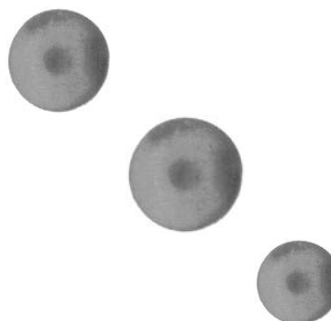



CHAIN SAW CARBURETION

HK Fuel Screens for TILLOTSON

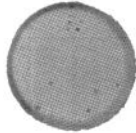

Order No. 38 - 4918

Replaces Tillotson 95-197.

MIN010

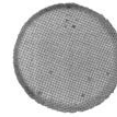

Order No. 38 - 8159

Replaces Tillotson 95-177. Fits HS-HU series.

MIN010

Check Valve for WALBRO

Order No. 38 - 13230

Check valve replaces Walbro 176-64-1.

MIN010



Diaphragms for TILLOTSON



Order No. 38 - 1552

Replaces Tillotson 237-600. Fits HL Carburetors.



Order No. 38 - 1553

Replaces Tillotson 237-137. Fits HL Carburetors.

MIN010



Order No. 38 - 3654

Diaphragm Assembly. Replaces Tillotson 237-653. Fits HS Series Carburetors. Also supplied in DG-5HS Kit.

MIN010



Order No. 38 - 3658

Fuel Pump Diaphragm. Replaces Tillotson 237-144. Fits HS Series Carburetors. Also supplied in DG-5HS Kit.

MIN010



Order No. 38 - 3661

Fuel Pump Diaphragm. Replaces 237-153. Fits HU series.

MIN010



Order No. 38 - 8154

Fuel Pump Diaphragm. Replaces 237-143. Fits HS series.

MIN010



Order No. 38 - 8155

Metering Diaphragm. Replaces 237-604. Fits HU series.

MIN010



Order No. 38 - 8156

Teflon Fuel Pump Diaphragm. Fits HU series.

MIN010

38

CARBURETION

CHAIN SAW CARBURETION



Gaskets for
TILLOTSON



Order No. 38 - 8133

Intake Gasket. Replaces 16B-276. Fits HK series.

MIN010



Order No. 38 - 6306

Intake Gasket. Replaces Tillotson HT.

MIN010



Order No. 38 - 1555

Gasket. Replaces Tillotson 16B-206. Fits HL Carburetors.

MIN010



Order No. 38 - 1556

Gasket. Replaces McCulloch 65583.

MIN010

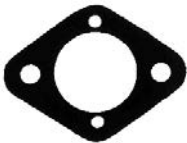

Order No. 38 - 3656

Flange Gasket. Replaces Tillotson 16B-228. Fits HS Series Carburetors. Also supplied in DG-5HS.

MIN010



Order No. 38 - 3657

Diaphragm Gasket. Replaces Tillotson 16B-226. Fits HS Series. Also supplied in DG-5HS.

MIN010



Order No. 38 - 3659

Fuel Pump Gasket. Replaces Tillotson 16B-227. Fits HS Series Carburetors. Also supplied in DG-5HS.

MIN010



Order No. 38 - 3662

Intake Gasket. Replaces 16B-248. Fits HU series. Also fits Walbro series.

MIN010



Order No. 38 - 3663

Metering Gasket. Replaces 16B-246. Fits HU series.

MIN010



Order No. 38 - 3664

Fuel Pump Gasket. Replaces 16B-247. Fits HU series.

MIN010



Order No. 38 - 8129

Intake Gasket. Replaces 16B-274. Fits HK series.

MIN010



Order No. 38 - 8131

Intake Gasket. Replaces 16B-216. Fits HL series.

MIN010

38

CARBURETION



**Carburetor Kit for
STIHL**

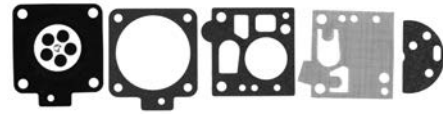

Order No. 38 - 13485

Carburetor kit replaces Stihl 1119-007-1062, Bing P/N 65-940-203. Used on models 038M.

**Carburetor Kits for
TILLOTSON**

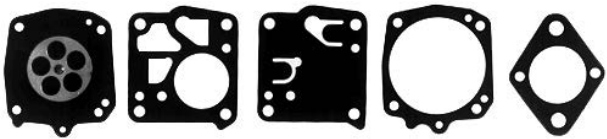

Order No. 38 - 1544

Replaces Tillotson DG-5HS. Fits HS Series Tillotson Carburetors.



Order No. 38 - 4911

Replaces Tillotson RK-32HK. Complete kit for these HK carbs.: HK-7, 7B, 7C, 9A, 9B, 9C; HK-10C, 10D, 10E; HK12-A, 12B, 12C; HK-15B, 15C; HK-16D, HK-19A, 19C, HK-20A, 20B, 20C; HK-21, HK-23A, 23B, 23C, 23D, 23E; HK-27B, HK-28C, HK-29, HK-38A, HK-40A.

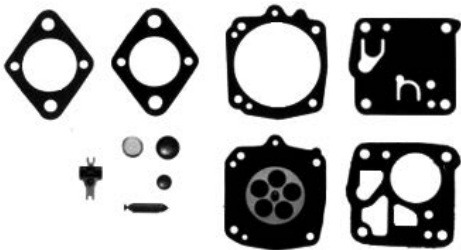

Order No. 38 - 3644

Replaces Tillotson RK-23HS.



Order No. 38 - 3667

Replaces Tillotson DG-2HU. For new HU Tillotson Carburetors. Contains both diaphragms and three gaskets. (For complete kit 38-4183)

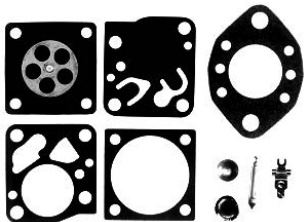

Order No. 38 - 4183

Replaces Tillotson RK-14HU. Complete HU Tillotson Carburetor Kit. All gaskets, diaphragms, lever, screen and Welch plugs.

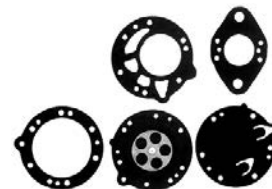

Order No. 38 - 1551

CK-012910 Diaphragm and Gasket Set 012910 and DG-2-HL. Fits HL Series Carburetors used on Homelite, McCulloch, Poulan, Pioneer and many others.

38

CARBURETION

CHAIN SAW CARBURETION



Fuel Lever for WALBRO



Order No. 38 - 8113

Replaces Walbro 166-48. Fits WA series.

MIN010

Fuel Inlet Needles for WALBRO



Order No. 38 - 3655

Replaces Walbro 82-75. Fits WA series.

MIN010

38

Fuel Lever for WALBRO



Order No. 38 - 8112

Replaces Walbro 82-82. Fits WA series.

MIN010



Order No. 38 - 7217

Replaces Walbro 166-55. Fits WB, WS and STC carburetors.

MIN010

CARBURETION

Fuel Lever for WALBRO



Order No. 38 - 8337

Fuel Lever replaces Walbro 166-48.

MIN010

Fuel Screens for WALBRO

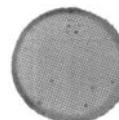

Order No. 38 - 8121

Fuel Inlet Screen. Replaces Walbro 140-70. Fits WA series.

MIN010

Order No. 38 - 8122

Check Valve Screen. Replaces Walbro 140-69. Fits WA series.

MIN010

Circlip for WALBRO



Order No. 38 - 8120

Replaces Walbro 16-42. Fits WA series.

MIN010

Welch Plugs for WALBRO



Order No. 38 - 8123

Replaces Walbro 88-171, 88-28. Fits WA series.

MIN010

Order No. 38 - 8124

Replaces Walbro 88-131, 88-89. Fits WA series.

MIN010

Order No. 38 - 8125

Replaces Walbro 88-136, 88-110. Fits WA series.

MIN010

Gasket for WALBRO



Order No. 38 - 8116

Teflon Diaphragm Plate. Fits WA series.

MIN010

Order No. 38 - 8115

Diaphragm Plate. Replaces Walbro 95-57. Fits WA series.

MIN010



Order No. 38 - 8114

Gasket Plate. Replaces Walbro 92-170. Fits WA series.

MIN010



CHAIN SAW CARBURETION

**Gasket Ring for
WALBRO**



Order No. 38 - 10267

Gasket ring replaces Walbro 16-101-8.

**Gasket Ring for
WALBRO**



Order No. 38 - 10268

Gasket ring replaces Walbro 16-110-8.

**Gasket for
WALBRO**



Order No. 38 - 8117

Gasket Plate. Replaces Walbro 92-206. Fits WA series.

MIN010

Order No. 38 - 8119

Gasket Plate. Replaces Walbro 92-318. Fits WA series. Also included in our **01-6576** assortment.

MIN010

**Gasket for
WALBRO**

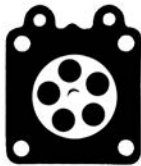

Order No. 38 - 8101

Metering Diaphragm. Replaces Walbro 95-526. Fits WA series.

MIN010

Order No. 38 - 8102

Metering Gasket. Replaces Walbro. 92-251. Fits WA series.

MIN010

Order No. 38 - 8103

Fuel Pump Diaphragm. Replaces Walbro 95-72. Fits WA series.

MIN010

Order No. 38 - 8104

Teflon Fuel Pump Diaphragm. Fits WA series Carburetors.

MIN010

Order No. 38 - 8105

Fuel Pump Gasket. Replaces Walbro 92-188, 92-142. Fits WA series.

MIN010

Order No. 38 - 8106

Metering Gasket. Replaces Walbro 92-214. Fits WA series.

MIN010

Order No. 38 - 8107

Surge Chamber Gasket. Replaces Walbro 95-83. Fits WA series.

MIN010



38

CARBURETION



CHAIN SAW CARBURETION

Gasket for WALBRO (Cont.)



Order No. 38 - 8109

Teflon Fuel Pump Diaphragm. Replaces Walbro 95-89. Fits WA & WT series. MIN010



Order No. 38 - 8110

Fuel Pump Gasket. Replaces Walbro 92-228. Fits WA series. MIN010



Order No. 38 - 8111

Fuel Pump Gasket. Replaces Walbro 92-225. Fits WA series. MIN010



Order No. 38 - 8126

Walbro HDC Intake Gasket. MIN010



Order No. 38 - 8127

Walbro WS Intake Gasket. MIN010



Order No. 38 - 8130

Walbro MDC Intake Gasket. MIN010

Carburetor Mounting Gasket for POULAN



Order No. 38 - 8365

Carburetor mounting gasket replaces Poulan 530019156. MIN010



Order No. 38 - 3662

Intake Gasket. Replaces 16B-248. Fits HU series. Also fits Walbro series. MIN010

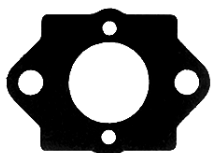

Order No. 38 - 1542

Carburetor Mounting Gasket. Replaces Poulan 19045. For Walbro WA & WT series carburetors. MIN010

Carburetor Kits for WALBRO



Order No. 38 - 4181

Walbro D10-WS. Replaces 350-511 and 350-527.

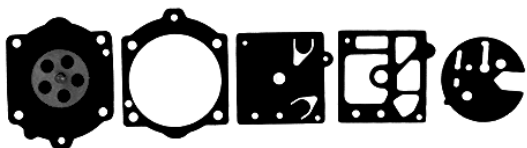

Order No. 38 - 4182

Walbro D10-HDB. Replaces 350-518.



Order No. 38 - 4209

Walbro Carburetor Kit. Replaces Walbro D1-MDC.

38

CARBURETION



CHAIN SAW CARBURETION

**Carburetor Kits for
WALBRO (Cont.)**

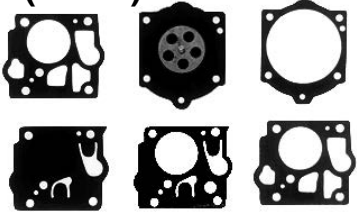

Order No. 38 - 4184

SDC Carburetor Diaphragm and Gasket Kit. Replaces Walbro D10-SDC.

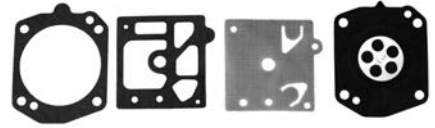

Order No. 38 - 12470

Diaphragm & Gasket Kit replaces Walbro D10-HD.

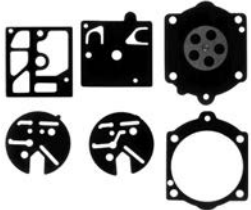

Order No. 38 - 4186

HDC Carburetor Diaphragm and Gasket Kit. Replaces Walbro D10-HDC.



Order No. 38 - 4923

Replaces Walbro D20-WA&T.

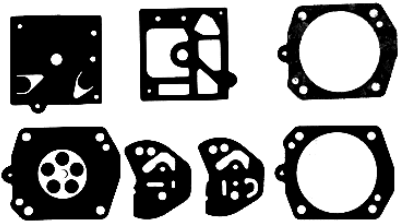

Order No. 38 - 4301

Replaces Walbro D10 HDA.

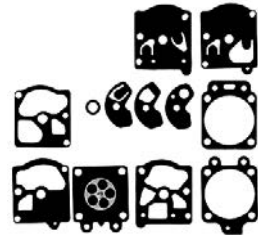

Order No. 38 - 4179

Replaces Walbro D4-W, D4-WA&T and D10-WAT.



Order No. 38 - 8259

Carburetor Kit replaces Walbro K10-WS.

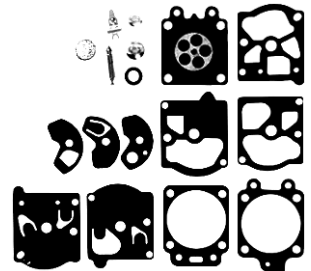

Order No. 38 - 4180

Replaces Walbro K10-WAT.

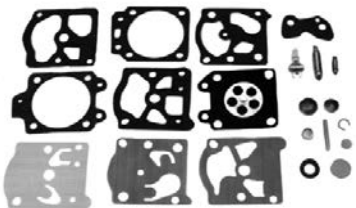

Order No. 38 - 8952

Carburetor kit replaces Walbro K20-WAT. Complete carburetor kit for newer WA & WT series carburetor's.

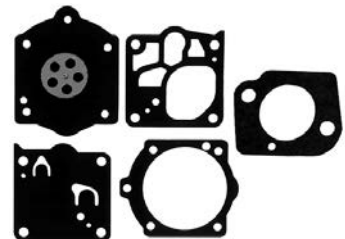

Order No. 38 - 7215

Replaces Walbro D10-WJ & D1-WJ.

38

CARBURETION



CHAIN SAW CARBURETION

Gasket & Diaphragm Kit for WALBRO



Order No. 38 - 13415

Gasket & Diaphragm kit replaces Walbro D0-WYJ.



Order No. 38 - 13263

Carburetor kit replaces Walbro K20-WYJ.



Order No. 38 - 13490

Carburetor & Diaphragm kit replaces Walbro D22-HDA.

Gasket & Diaphragm Kit for ZAMA



Order No. 38 - 13638

Gasket & Diaphragm kit replaces Zama RB-71. Fits Echo TC100,SV-4/E,SV-4/B



Order No. 38 - 13293

Carburetor kit replaces Zama RB-41. Fits models C1Q-S11C-E and C1Q-S16A. Fits Stihl models 021, 023, 025.



Order No. 38 - 13292

Carburetor kit replaces Zama RB-36. Fits Stihl 044 saws with C3M-S5D, C3M-S5E, C3M-S5G, C3M-S12A, C3M-S20, C3M-S21, C3M-S22, C3M-S23, C3M-S24.



Order No. 38 - 13294

Carburetor kit replaces Zama RB-45. Fits Husqvarna models 40, 45, 49, H45/49, H55/51, 240R, 245R and RX saws. Jonsered models 2041, 2045, 2050 and RS44. Partner models 400, 410, 450, 460, 490, 510. Zama models C1Q-EL1, C1Q-EL5,A, C1Q-EL6, C1Q-EL7, C1Q-EL10, C1Q-M43.



Order No. 38 - 13291

Carburetor kit replaces Zama RB-31. Fits C3A Zama carburetor's. Fits Stihl models 034, 036 & MS360 with Zama C3A series: S19, S26, S38A, S4/A/B, S4/C, S31A, S31D/E, S39A, & S39B carburetor's.

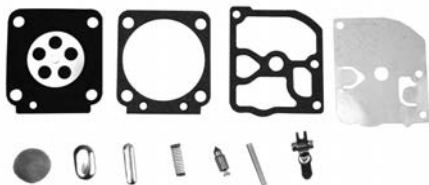

Order No. 38 - 13391

Carburetor kit replaces Zama RB-77. Fits Zama models C1Q-S43, C1Q-S43A-B, C1Q-S57, C1Q-S57A. Use GND-33 our 38-13097 for gasket and diaphragm kit.



Order No. 38 - 13489

Carburetor & Diaphragm kit replaces Zama GND-35 & GND-29. Fits model C1Q. Fits Stihl. Fits Dolmar models PS-340, PS-34. Zama models C1Q-DM1, C1Q-DM6, C1Q-DM7, C1Q-DM8, C1Q-DM9.

38

CARBURETION



CHAIN SAW CARBURETION

**Carburetor Kits for
WALBRO (Cont.)**

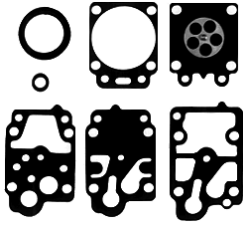

Order No. 38 - 6568

D10-WY Carburetor Kit. Fits the newer plastic type carburetors on many Grass & Hedge Trimmers, Brushcutters and Power Blowers.



Order No. 38 - 8260

Carburetor Kit replaces Walbro K10-WZ.



Order No. 38 - 7216

Replaces Walbro D11-WJ & D2-WJ.



Order No. 38 - 8342

Carburetor Kit replaces Walbro K10-HDB.

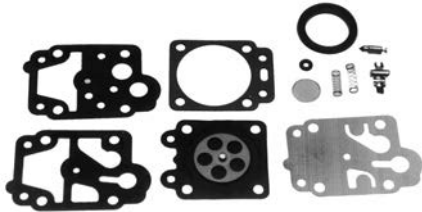

Order No. 38 - 8261

Carburetor Kit replaces Walbro K10-WY.

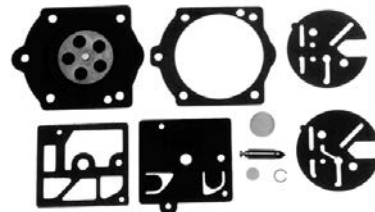

Order No. 38 - 8341

Carburetor Kit replaces Walbro K10-HDC.

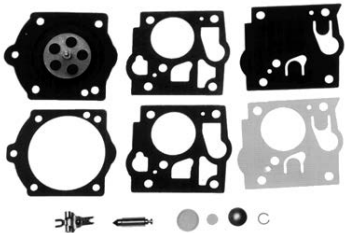

Order No. 38 - 8340

Carburetor Kit replaces Walbro K10-SDC.

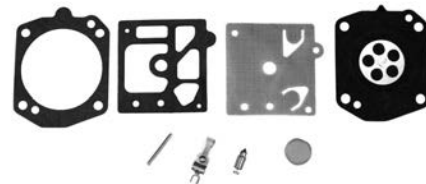

Order No. 38 - 12471

Complete carburetor kit replaces Walbro K10-HD.

**Carburetor Kits for
TK**



Order No. 38 - 4302

Replaces Homelite A98064-11. For TK Carburetors, used on Homelite models ST80, 100, 120, 160, 200 with Kawasaki equipped engines.

**Gaskets for
TK**



Order No. 38 - 8132

TK Intake Gasket for Green Machine.

MIN010

38

CARBURETION

CHAIN SAW CARBURETION



Carburetor Kits for TK



Order No. 38 - 5829

TK for Green Machine. Used on Green Machine and Shindaiwa with Shindaiwa engines John Deere, Hofco, and Robin with Fuji engines.

Carburetor Kit for TEIKEI



Order No. 38 - 7218

Fits McCulloch Mac 25, John Deere with Fuji engines, Hoffco and Robin with Fuji engines and Stihl with Komatsu engines. Used on Fuji and Komatsu engines.

38

CARBURETION



Order No. 38 - 8140

C1 Fuel Pump Gasket. Replaces 0016001.

MIN010

Gasket for ZAMA

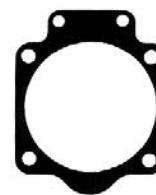

Order No. 38 - 8136

C2 Metering Gasket. Replaces 0016005.

MIN010



Order No. 38 - 8142

C1 Metering Gasket. Replaces Zama 0016003.

MIN010



Order No. 38 - 8147

C1S Fuel Pump Gasket (thin). Replaces Zama 0016017.

MIN010



Order No. 38 - 8148

C1S Fuel Pump Gasket. Replaces Zama 0016015.

MIN010



Order No. 38 - 8149

C1S Fuel Pump Gasket. Replaces Zama 0016014.

MIN010

Diaphragms for ZAMA



Order No. 38 - 8135

C2 Metering Diaphragm. Replaces Zama A015005.

MIN010



Order No. 38 - 8137

C2 Fuel Pump Diaphragm. Replaces Zama 0015004.

MIN010



CHAIN SAW CARBURETION

Gasket for ZAMA (Cont.)



Order No. 38 - 8139

C2 Fuel Pump Diaphragm. Replaces Zama 0037002.

MIN010



Order No. 38 - 8141

C1 Metering Diaphragm. Replaces Zama A015002.

MIN010



Order No. 38 - 8143

C1 Fuel Pump Diaphragm. Replaces Zama 0015001.

MIN010



Order No. 38 - 8145

C1S Metering Diaphragm. Replaces Zama 0015014.

MIN010



Order No. 38 - 8146

C1S Metering Diaphragm. Replaces Zama A015006.

MIN010



Order No. 38 - 8150

C1S Fuel Pump Diaphragm. Replaces Zama 0015015.

MIN010



Order No. 38 - 8151

C1S Fuel Pump Diaphragm. Replaces Zama 0015013.

MIN010



Order No. 38 - 8152

C1S Fuel Pump Diaphragm. Replaces Zama 0015018.

MIN010



Order No. 38 - 8144

C1 Teflon Fuel Pump Diaphragm.

MIN010



Order No. 38 - 8153

C1S Teflon Fuel Pump Diaphragm. Replaces Zama 0037004.

MIN010



Order No. 38 - 14083

Metering diaphragm replaces Zama A015010. Fits Zama C1U.

MIN010



Order No. 38 - 14348

Metering diaphragm replaces Zama A015053. Fits C1Q carburetors for Stihl. Replaces Stihl 4314-121-4700. Included in our 38-13420 & 38-14383.

MIN010

38

CARBURETION

CHAIN SAW CARBURETION



Gasket & Diaphragm Kit for STIHL

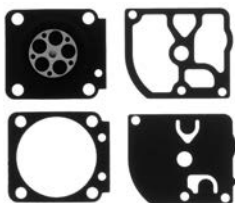

Order No. 38 - 14654

Gasket & diaphragm kit replaces Stihl 1129-007-1062. Fits C1 Q carburetors, Zama GND-98.

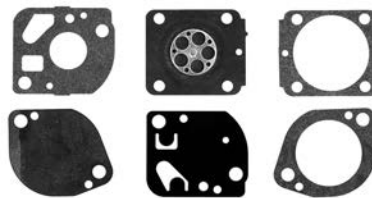

Order No. 38 - 14653

Gasket & diaphragm kit replaces Stihl 4180-007-1060. Fits C1 Q carburetors, Zama GND-91.

38

CARBURETION

Carburetor Kits for ZAMA



Order No. 38 - 4210

Replaces Zama K015019 and GND1. Fits C1 type carburetors. For McCulloch 300467, 91824. Used on many McCulloch chain saws.

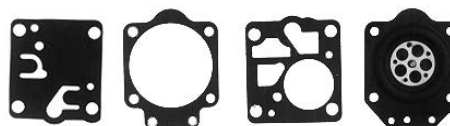

Order No. 38 - 4996

Replaces Zama K015005 and GND8. Fits C2 type carburetors. For Homelite 07025, 94952 & 9108. Used on many Homelite chain saws.

Carburetor Repair Kit for ZAMA

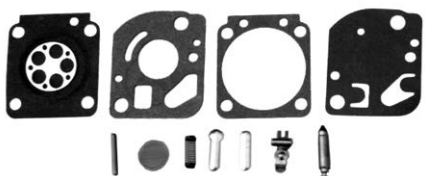

Order No. 38 - 9244

Carburetor repair kit replaces Zama RB-20. Kit used on Homelite C1U carburetor's.



Order No. 38 - 9297

Carburetor repair kit replaces Zama RB-21. Kit used on Echo C1U carburetor's.



Order No. 38 - 9298

Carburetor repair kit replaces Zama RB-28. Kit used on McCulloch C1U carburetor's.

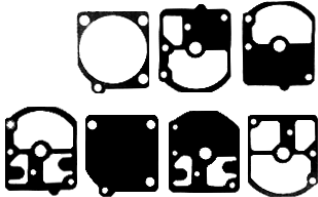

Order No. 38 - 5839

Replaces Zama K015011, K015022, K015027, K015032, K015033 and GND32. For C1S Zama Carburetors without metal washers attached to the metering diaphragm.



Order No. 38 - 5840

Replaces Zama K015026 and K015034 and GND4. For C1S Zama Carburetors with conventional type metering diaphragm.

Gasket & Diaphragm Kit for ZAMA



Order No. 38 - 12773

Gasket & Diaphragm kit replaces Zama RB-61. Fits Echo PB4600, PB6000 w/C1M carburetor. Similar to GND-31 for gasket and diaphragm kit. Fits C1M-K24 A-B, C1M-K25 A-B, C1M-K37 A-D, C1M-K49 A-C, C1m-K76.



Order No. 38 - 12774

Gasket & Diaphragm kit replaces Zama GND-31. Fits Echo PB4600, PB6000 w/C1M carburetor. Similar to RB-61 for complete kit. Fits C1M-K24 A-B, C1M-K25 A-B, C1M-K37 A-D, C1M-K49 A-C, C1m-K76.



Order No. 38 - 12996

Gasket & Diaphragm kit replaces Zama RB-66. Repair kit for C1Q-S28, 29, 30, 41, 42, 44, & 45 model carburetors on Stihl. Fits C1Q-528 A-D, C1Q-528 A-D, C1Q-52D A-C, C1Q-530 A-C, C1Q-544 A, C1Q-5432. Fits Stihl models FH75, FC75, HL75, FS75, FS80, FS85, HT70, HT75, HS75, HS80, HS85, BG75, FC55, FS46, FS55.

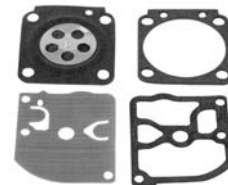

Order No. 38 - 12998

Gasket & Diaphragm kit replaces Zama GND-28. Gaskets & Diaphragm kit for C1Q-S28, 29, 30, 41, 42, 44, & 45 model carburetors on Stihl. Fits C1Q-528 A-D, C1Q-528 A-D, C1Q-52D A-C, C1Q-530 A-C, C1Q-544 A, C1Q-5432. Fits Stihl models FH75, FC75, HL75, FS75, FS80, FS85, HT70, HT75, HS75, HS80, HS85, BG75, FC55, FS46, FS55.

38

CARBURETION



CHAIN SAW CARBURETION

Gasket & Diaphragm Kit for ZAMA



Order No. 38 - 13063

Gasket & Diaphragm kit replaces Zama GND-52. Fits Echo models ES230, 231, PB230, 231 blowers, SRM230, 231 trimmers, Fits Zama carburetor models RB-FA1, RB-567 A-B, RB-K66 A-B, RB-K67 A-B, RB-K70 A, RB-K71, RB-K-72, RB-K75 & RB-SK18. Replaces Echo P005000550.

Gasket & Diaphragm Kit for ZAMA

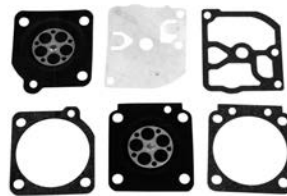

Order No. 38 - 13097

Gasket & Diaphragm kit replaces Zama GND-33 & GND-39. Fits Husqvarna 40, 45, H40-45, H55-51, 240, 245 chain saws. Zama C1Q-EL1, C1Q-EL5 A, C1Q-EL6, C1Q-EL7, C1Q-EL10, C1Q-S43 A-B, C1Q-S57 A, C1Q-M43 and C1Q-M44 carburetors.

38

CARBURETION



Order No. 38 - 13185

Carburetor kit replaces Zama RB-69. Fits Stihl 020, 020T, MS191, MS192T, MS200T. Replaces Stihl 1129-007-1062. Fits models C1Q-EL11 A-B, C1Q-EL12, C1Q-EL13, C1Q-EL14,m C1Q-S32 and C1Q-S61.

Gasket & Diaphragm Set for ZAMA



Order No. 38 - 9199

Gasket & Diaphragm Kit. Fits Zama GND 13, 14, 16, 17 and 18 on C1U. Also fits C1U carburetor kits using rounded metering diaphragm.

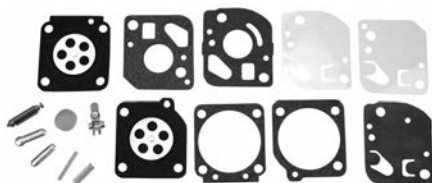

Order No. 38 - 13365

Carburetor kit replaces Zama RB-29. Fits Homelite/John Deere, Ryobi with Zama model C1U carburetor's.



Order No. 38 - 13262

Carburetor kit replaces Zama RB-27 & RB-22.



Order No. 38 - 13488

Carburetor kit replaces Zama GND-7. Fits carburetor model C1 S. Fits Stihl.



Order No. 38 - 13420

Carburetor kit replaces Zama RB114. Fits models C1Q-S72B, C1Q-S88. Fits Stihl model 4180.

Gasket & Diaphragm Kit for ZAMA

Order No. 38 - 14383

Gasket & Diaphragm kit replaces Zama GND-56. Fits C1Q carburetors for Stihl.

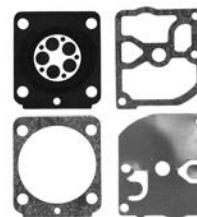



CHAIN SAW CARBURETION

Carburetor Kit for NIKKI



Order No. 38 - 6893

Nikki Carburetor Kit for Mitsubishi T300 and up, with BA401 engines on Snapper, Toro and Red Max blowers.

Universal Gasket

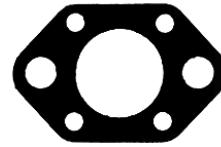

Order No. 38 - 8134

Universal Intake Gasket.

MIN010

Tank Grommet for STIHL



Order No. 38 - 7294

Tank grommet replaces Stihl 4114-358-7300 and 4114-358-7000. Fits trimmer models FS60, FS61, FS62 and FS65.

MIN005

Duck Bill Valve for HOMELITE



Order No. 38 - 7259

Duck bill valve replaces Homelite 69451.

MIN010

Fuel Line for STIHL



Order No. 38 - 14257

Fuel line replaces Stihl 1123-358-7701 / 7702. Fits models 021, 023, 025.

Fuel Line for HOMELITE



Order No. 38 - 14278

Fuel hose replaces Stihl 1122-647-9400. Fits models 026, 034, 036, 064, 066, MS 260, 361.

Fuel Line for STIHL



Order No. 38 - 14277

Fuel hose replaces Stihl 1124-358-7700. Fits models MS 650, 066, MS640, MS880, 084, TS 700, 088, MS 780, TS 800, 064, MS660.

Fuel Line for HOMELITE



Order No. 38 - 13171

Fuel hose replaces Stihl 1127-358-7702. Fits 029/034/036/039.

38

CARBURETION

CHAIN SAW CARBURETION



Molded Fuel Line

Length 4-15/16"



Order No. 38 - 5831

Replaces Stihl 1119-358-7700. For Stihl model 034, 036 & 038.

Molded Fuel Line

Length 6-3/8"



Order No. 38 - 4971

Replaces McCulloch 215708 for model 1010.

38

Molded Fuel Line

Length 9-1/4"



Order No. 38 - 4972

Replaces Homelite 63745A, 63744A for XL-12 and Super XL-12.

Fuel Line & Grommet for McCULLOCH

Length 7-1/2"



Order No. 20 - 7293

Fuel Line and Grommet replaces McCulloch 213948 (fuel line) and McCulloch 215495 (grommet), Toro 41-1880. Also fits Echo and WeedEater trimmers and blowers.

CARBURETION

Intake Gasket Material



Order No. 38 - 6305

High Performance Intake Gasket Material.

MIN010



CHAIN SAW ACCESSORIES

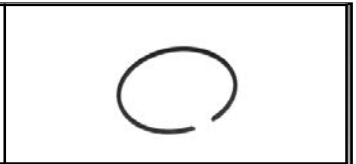

Quick-Glance

CHAIN SAW ACCESSORIES	PG.
Fuel Line	1206
Fuel/Oil Cap	1206-1208
Crankshaft Assembly	1208-1212
Cylinder/Piston Assembly	1208-1212
Piston Rings	1208-1212
Bar Stud Nut	1213-1215
Gaskets	1212-1213
Oil Seals	1213
Switches	1215
Starter Pawl	1216
Starter Pulley	1216-1217
AV Mounts	1217
AV Buffer	1217-1218
Starter Recoils	1218-1219

CHAIN SAW ACCESSORIES



Vinyl Fuel and Lubricant Tubing



Order No.	Dimensions		Standard Package
	ID	OD	
20 - 4197	3/32"	3/16"	50 ft.
20 - 4198	1/8"	1/4"	50 ft.
20 - 8595	1/8"	3/16"	50 ft.
20 - 4199	3/16"	5/16"	50 ft.
20 - 4200	1/4"	3/8"	50 ft.

Approved for all Chain saw use.

Special formula, vinyl gas and oil tubing for chain saws, small engines, snowmobiles, mowers etc. Resists swelling or hardening. Translucent material allows visual inspection of flow.

Tygon Fuel and Lubricant Tubing

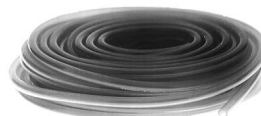

Order No.	Dimensions		Standard Package
	ID	OD	
20 - 6616	.080"	.140"	50 ft.
20 - 6617	3/32"	3/16"	50 ft.
20 - 6618	1/8"	1/4"	50 ft.
20 - 8386	1/8"	3/16"	50 ft.
20 - 6619	3/16"	5/16"	50 ft.
20 - 6620	1/4"	3/8"	50 ft.

Approved for all Chain saw use.

Tygon Fuel and Lubricant Tubing for Petroleum and Petroleum/Alcohol blends. Gas and oil tubing for chain saws, small engines, snowmobiles, mowers etc. Flexible and Resists swelling and brittleness. (Yellow)

Oil Pump for POULAN



Order No. 39 - 11860

Oil pump replaces Poulan 530-071259 & 530-069957. Fits chain saw models 1950 thru 2550, 211, 220 and 260 Pro.

Fuel Line for ECHO



Order No. 20 - 13370

25' coil of 3mm ID x 6mm OD fuel line. Replaces Echo 90015.

Order No. 20 - 13369

25' coil of 3mm ID x 5mm OD fuel line. Replaces Echo 90014.

Grommet With Hose for STIHL



Order No. 20 - 12847

Grommet with hose replaces Stihl 9890516 & 9302803. Fits Stihl models FS350/400/450/480.

Fuel Pump Primer for STIHL



Order No. 20 - 12997

Fuel pump primer replaces Stihl 1130-350-6200 & 0000-350-6202. Fits BR500 blowers & TS400, TS800 Cut Off Saws.

Fuel Cap for STIHL



Order No. 39 - 7299

Fuel cap replaces Stihl 1117-350-0520 and 1117-350-0500. Fits models 036, 038, 044, 066, 045, 048, 056 and 064.

Fuel/Oil Cap for STIHL



Order No. 39 - 7295

Fuel/Oil cap replaces Stihl 1117-350-0510 and 1117-640-3600. Fits models 09 thru 044. Oil cap only for models 038, 036, 026 and 034.

CHAIN SAW ACCE. 39



CHAIN SAW ACCESSORIES

Fuel Cap for HUSQVARNA



Order No. 20 - 13363

Fuel cap replaces Husqvarna 501-43-14-02. Fits saw models 225, 266, 268, 272, 44, 61, 66, 298, 2100, 2101.

Fuel Cap for ECHO



Order No. 20 - 13530

Fuel cap replaces Echo 13100455530. Has internal retainer. Fits string trimmers, backpack blowers, hedge trimmers etc. Non-vented cap. 1-7/8" OD

Fuel Cap Assembly for ECHO



Order No. 20 - 13531

Fuel cap assembly with retainer replaces Echo 13160009861, 3160009861, 13160009860, 13100406610, 13160003360. Fits models PB403, 403H, 403T, 413, 413H, 413HT, 413T, PB460LN, 461LN, 602, 610, 620. 2" OD

Fuel Line Fitting for POULAN



Order No. 20 - 13448

Fuel line fitting replaces Poulan 530-023877. Fits gas saw models 180, 1800, 180C, 1800 Super, 190, 2000, 210, Micro XXV and S23 Arbor Pro.

Fuel Cap



Order No. 39 - 7081

Fuel Cap. Replaces Stihl 0000-350-0520/1117-350-0500. Used on Stihl model 024.

Oil Caps



Order No. 39 - 7083

Oil Cap. Replaces Stihl 0000-350-0510/1117-640-3600. Used on models 024, 028, 038, 042 & 048.

Fuel Cap for STIHL



Order No. 39 - 7772

Fuel cap replaces Stihl 1107-350-0500. Fits model 07S.

Oil Cap for STIHL



Order No. 39 - 7770

Oil filler cap replaces Stihl 1106-640-3600. Fits models 070 and 090.

CHAIN SAW ACCESSORIES



Order No. 20 - 6884

Fuel Cap. Replaces Poulan 701583 and 710567, Weedeater 530-14347, 530-010729. Fits models 1400, 1500, 1600, 1700, 1720, 1730, 1740, 1900, 4000, 5000, 6010 and Weedie 215. Fits WE, Yard Pro and chain saws with gas tank on top of engine.



Crankshaft Assembly for HUSQVARNA



Order No. 39 - 9644

Crankshaft assembly replaces Husqvarna 503613371. Fits models 61, 268, 272 (after 1993).

Crankshaft Assembly for STIHL



Order No. 39 - 9645

Crankshaft assembly replaces Stihl 4223-030-0400. Fits model TS400.



Order No. 39 - 7876

Crankshaft assembly replaces Stihl 1108-030-0402. Fits models 08S, TS08, TS350 & TS360.



Order No. 39 - 8686

Crankshaft assembly replaces Stihl 1119-030-0400. Fits models 038, 038S, 038 Magnum.

Cylinder/Piston Assemblies

Complete with Piston, Rings, Pins and Clips

Piston & Cylinder Set for HUSQVARNA



Order No. 39 - 13015

Cylinder & Piston Assembly replaces Husqvarna 506-15-55-06. Fits K950.

Cylinder & Piston Assembly for HUSQVARNA



Order No. 39 - 13616

Cylinder & Piston assembly replaces Husqvarna 503-69-10-73, 503-93-90-03, 503-93-90-05, 48mm. Fits model 365. Includes piston, cylinder, rings, pin & clips. Also replaces Jonsered model 2165.



Order No. 39 - 12629

Piston & Cylinder set replaces Husqvarna 503-609171. Fits Husqvarna model 51.



Order No. 39 - 12630

Piston & Cylinder set replaces Husqvarna 503-611071. Fits Husqvarna model 268 (50mm) cylinder made after 1991.

CHAIN SAW ACCE.
39



CHAIN SAW ACCESSORIES

Cylinder/Piston Assemblies Complete with Piston, Rings, Pins and Clips

Piston & Cylinder Set for HUSQVARNA



Order No. 39 - 12631

Piston & Cylinder set replaces Husqvarna 503-609108 & 503-609102. Fits Husqvarna model 55.



Order No. 39 - 9637

Cylinder/Piston assembly replaces Husqvarna 503536802. Fits models 242 - 242XP.



Order No. 39 - 11057

Cylinder/Piston assembly replaces Husqvarna 503-53-20-71. Fits Husky model 61.



Order No. 39 - 12632

Piston & Cylinder set replaces Husqvarna 503-758172 & 503-758171. Fits Husqvarna model 272 & 272XP.



Order No. 39 - 9638

Cylinder/Piston assembly replaces Husqvarna 503503902. Fits models 254 - 254XP.

Piston & Cylinder Kit for MAKITA



Order No. 39 - 12815

Piston & Cylinder kit replaces Makita 325-130-032. Fits models 6200, 6201, 6400, 6401, 6410, 6411. Also replaces Wacker 0202778.

Cylinder & Piston Assembly for PARTNER



Order No. 39 - 12885

Cylinder & Piston Assembly replaces Partner 520-75-73-02 & 506-38-61-71. Fits K750.



Order No. 39 - 12628

Piston & Cylinder kit replaces Partner 506-29-42-71. Fits models K1250 cut off saws. (60mm)

39
CHAIN SAW ACCE.



Order No. 39 - 9917

Piston ring replaces Husqvarna 5016998-01/503289017. Fits Husqvarna 266-266XP chain saw.

Order No. 39 - 9918

Piston ring replaces Husqvarna 5032890-05. Fits Husqvarna 242-242XP chain saw. Used with our 39-9637 piston assembly.

Order No. 39 - 9919

Piston ring replaces Husqvarna 5032890-11. Fits Husqvarna 254-254XP chain saw. Used with our 39-9638 piston assembly.

CHAIN SAW ACCESSORIES



PARTNER



Order No. 39 - 9640

Cylinder/Piston assembly replaces Partner 506 09 92-12. Fits models K650 & 700 Active.



Order No. 39 - 9921

Piston ring replaces Partner 5032890-17. Fits Partner K650 Active chain saw. Used with our 39-9640 piston assembly.

STIHL



Order No. 39 - 9641

Cylinder/Piston assembly replaces Stihl 1121-020-09 & 1121-020-1209. Fits models 026.



Order No. 39 - 9922

Piston ring replaces Stihl 1121-034-3010. Fits Stihl 026 chain saw. Used with our 39-9641 piston assembly.



Order No. 39 - 9642

Cylinder/Piston assembly replaces Stihl 1125-020-1213. Fits models 034-036.



Order No. 39 - 9923

Piston ring replaces Stihl 1125-034-3001. Fits Stihl 034-026 chain saw. Used with our 39-9642 piston assembly.



Order No. 39 - 9643

Cylinder/Piston assembly replaces Stihl 4223-020-1200. Fits model TS400.



Order No. 39 - 9924

Piston ring replaces Stihl 127-034-3006. Fits Stihl TS400 chain saw. Used with our 39-9643 piston assembly.



Order No. 39 - 12267

Cylinder assembly replaces Stihl 4205-020-1200. Fits models TS760 (58mm bore). Cylinders come complete with piston, rings, pins and clips.



Order No. 39 - 12266

Cylinder assembly replaces Stihl 4221-020-1201. Fits models TS460. Cylinders come complete with piston, rings, pins and clips.

CHAIN SAW ACCE. 39



CHAIN SAW ACCESSORIES

STIHL (Cont.)



Order No. 39 - 7055

Cylinder/Piston assembly. Replaces Stihl 1108-020-1220. For Stihl model 08S and TS350.



Order No. 39 - 9925

Piston ring replaces Stihl 1108-034-3001. Fits Stihl 08-TS350 chain saw. Used with our 39-7055 piston assembly.



Order No. 39 - 8401

Cylinder/Piston assembly replaces Stihl 1111-020-1200. Fits Stihl models 051 & TS510-52mm.



Order No. 39 - 9926

Piston ring replaces Stihl 1115-034-3001. Fits Stihl 051-TS510 & 038 Magnum chain saw. Used with our 39-8401 & 39-8672 piston assembly.



Order No. 39 - 7057

Cylinder/Piston assembly. Replaces Stihl 1118-020-1203 and 1118-020-1202. For Stihl model 028S.



Order No. 39 - 9927

Piston ring replaces Stihl 1118-034-3001. Fits Stihl 028 Super chain saw. Used with our 39-7057 piston assembly.



Order No. 39 - 7059

Cylinder/Piston assembly. Replaces Stihl 4201-020-1200. For Stihl model TS360AVSE.



Order No. 39 - 9929

Piston ring replaces Stihl 4201-034-3000. Fits Stihl 08S-TS360 chain saw. Used with our 39-7059 piston assembly.



Order No. 39 - 11056

Cylinder/Piston assembly replaces Stihl 1119-020-1202. Fits Stihl models 038 Magnum & MS380.



Order No. 39 - 12731

Cylinder & Piston assembly replaces Stihl 4238-020-1202. Fits TS410, TS420 cut off saws.

39

CHAIN SAW ACCE.

CHAIN SAW ACCESSORIES

Cylinder & Piston Assembly for STIHL



Order No. 39 - 13617

Cylinder & Piston assembly replaces Stihl 1119-020-1204. Fits MS381 chain saw. Includes Piston, Cylinder, Rings, Pin & Clips.

Cylinder & Piston Assembly for STIHL



Order No. 39 - 13618

Cylinder & Piston assembly replaces Stihl 1135-020-1202. Fits MS361 chain saw. Includes Piston, Cylinder, Rings, Pin & Clips.

Order No. 39 - 14114

Cylinder & Piston assembly replaces Stihl 4137-020-1202, 34mm. Fits FS85 trimmers. Includes piston, cylinder, rings, pin & clips. Also fits some FC75, FC85, FH75, FR85, FS75, FS80, HL75, HL75K, HT70, HT75, KA85, KR85, KW85, SP81, SP85.



Control Shaft for STIHL



Order No. 39 - 7775

Control shaft replaces Stihl 1118-182-0900. Fits model 028.

Clamping Collar for STIHL



Order No. 39 - 7776

Clamping collar replaces Stihl 9771-021-2580. Used on rubber elbow, manifold to carb. on 038 saws.

Head Gasket for ECHO



Order No. 39 - 7684

Replaces Echo 101010-03931, 101010-0393, 101010-13331. Fits model CS302. For our 39-7062 cylinder/piston assembly. MIN010

Head Gasket for STIHL



Order No. 39 - 7686

Replaces Stihl 1108-029-2300. Fits models 08S, TS08, TS350 & TS360. For our 39-7055 cylinder/piston assembly. MIN010

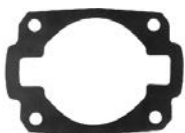

Order No. 39 - 7689

Replaces Stihl 1110-029-2300. Fits models 041AV, 041 & Farm Boss. For our 39-7060 cylinder/piston assembly. MIN010

Chain Adjuster Kit for HUSQVARNA



Order No. 39 - 13586

Chain adjuster kit replaces Husqvarna 537044102. Fits models 362XP, 365, 372, 385, 570, 575, 576.

39

CHAIN SAW ACCE.



CHAIN SAW OIL SEALS

(Packaged in lots of 5)



Order

No. **Make & OEM No.**

HUSQVARNA

39 - 4860	503-26-02-04	MIN005
39 - 4861	503-26-02-05	MIN005

ECHO

39 - 4895	100-212-1123-0	MIN010
------------------	----------------	--------

Guide Bar Stud Nut for ECHO



Order No. 39 - 10796

Guide bar stud nut replaces Echo 433019-03933. 6mm
MIN010

Bar Bolt for POULAN



Order No. 39 - 8612

Bar bolt replaces Poulan 15819. Fits S25A & S25AV. Size 5/16 x 18 x 1".
MIN010

CHAIN SAW GASKET MATERIAL KIT

Make Any Gasket You Need!

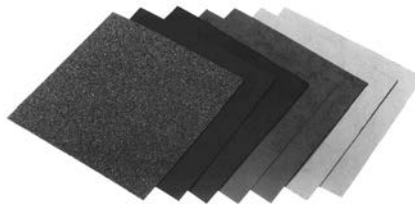

Order No. 39 - 4910

Kit Contains the Following:

Two	6" x 6"	Metal reinforced head gasket material, app. .050
Two	6" x 6"	Heat, Gas, Oil resistance compressed asbestos, app. .020
Two	6" x 6"	Treated paper, intake material, app. .020
One	6" x 6"	Cork and rubber material, general purpose, Gas and Oil resistance app. .067

CHAIN SAW ACCESSORIES



GUIDE BAR STUD NUTS

(Packaged in lots of 10)



CHAIN SAW TENSIONERS

(Includes Screw and Fittings)



Order

No. Make & OEM No.

ECHO

- 39 - 4793** 452 thru 701 MIN010
- 39 - 10796** 433019-03993 MIN010

HOMELITE

- 39 - 4791** For 5/16 x 18 Stud MIN010
- 39 - 4792** For 3/8 x 16 Stud MIN010

HUSQVARNA

- 39 - 4793** 44, 61, 65, 77, 162, 180, 280, 285, 380, 444, 480, 2100 MIN010

McCULLOCH

- 39 - 4795** Mac 6, 7-10, 55, 60 Pro 10-10, SP81 MIN010
- 39 - 8323** Mini Mac 300 MIN010
- 39 - 8324** Mini Mac 600 MIN010

PARTNER

- 39 - 4793** P55, P70, P100, R16, S50, S55 MIN010

PIONEER

- 39 - 4795** P20, P26, P28, P28S, P40, C55, C56, 620, 650, 150A MIN010

POULAN

- 39 - 4791** 3400, 3700, 4000, 4200 MIN010

STIHL

- 39 - 4797** 050, 051AV, 075AV 08S, 07, 070, 090, Contra. MIN010
- 39 - 4796** 09, 011, 012, 024, 028,034, 038, 056, 064 MIN010
- 39 - 7768** 050, 051AV, 075, 085 MIN010
- 39 - 7769** 010, 015, 020AV, 031AV, 032, 041AV, 042AV, 045AV, 056 MIN010

Order

No. Make & OEM No.

HOMELITE

- 39 - 8396** XL12, Super XL, 410, 450, 540, 550
- 39 - 8397** XL, XL2, Super 2, VI Super 2, 240, 245

HUSQVARNA

- 39 - 6440** 266, 268, 61
- 39 - 9648** 238, 242, 444
- 39 - 9649** 152, 254, 262

McCULLOCH

- 39 - 8398** Mini Mac 100, 300 Mac 6, Mini 1, Mini Mac 6, Mac 6, SP40, PM510, Power Mac 6A, HO, 3-10
- 39 - 8399** 600

POULAN

- 39 - 4830** XX, XXV, Micro 25, 1800, 2000
- 39 - 8400** 3400

STIHL

- 39 - 4833** 07, 07 Super, 08, 08 Super, 050, 051, 051AV, 070, 070AV, 075, 075AV, 090, 090AV
- 39 - 7771** 028
- 39 - 7773** 030, 031, 031AV 031AVS, 041, 041AV 042, 042AV, 045 045AV, 045AV Super

39 CHAIN SAW ACCE.



**Bar Stud for
STIHL**



Order No. 39 - 7767

Bar stud replaces Stihl 1110-664-2400. Fits models 040, 041, 041G. MIN010

Chainsaw Ignition Switch



Order No. 31 - 4720

Comes with "On-Off" Plate and Nut.

**Stop Switch for
STIHL**



Order No. 39 - 7777

Stop switch replaces Stihl 1121-430-0200. Fits models 024, 026.

Starter Handle and Rope



Order No. 25 - 4969

Molded Starter Handle and Rope for Poulan Micro 25 saws. Replaces 530-026791/530-023783. (with knob)

**Stop Switch Assembly for
HUSQVARNA**



Order No. 39 - 11588

Stop switch assembly replaces Husqvarna 503-08-97-021 / 503-71-79-01. Fits models 36 / 41 / 50 / 51 / 55 / 61 / 266 / 268 / 272 / 340 / 345 / 394 / 395.

Fibre Washer



Order No. 39 - 1570

Fits Starter Dog and Fairbanks Morse 10-27-80. MIN010

Starter Cups



Order No. 39 - 1566

Replaces Poulan 2501.

Universal Handle



Order No. 25 - 1318

This popular handle will work equally well as a replacement on vertical pull lawnmower engines and chain saws.

CHAIN SAW ACCESSORIES



Starter Pawl for STIHL



Order No. 39 - 9633

Starter pawl replaces Stihl 1125-195-7200. Fits models 009, 010, 011, 012, 021, 023, 024, 025, 026, 028, 034, 036 & 044.



Order No. 39 - 7871

Starter Pawl replaces Stihl 1118-195-7200. Fits model 009, 010, 011, 024, 028 & 032. (plastic)



Order No. 39 - 7872

Starter Pawl replaces Stihl 1117-195-7200. Fits model 08, 038, 041, 042, 045, 048, 051, 056 & 075. (plastic)



Order No. 39 - 11584

Starter pawl replaces Stihl 1124-195-7200. Fits model 038 / MS380.



Order No. 39 - 12717

Starter pawl replaces Stihl 4116-195-7200 & 0000-195-7200. Fits models FS160-220-280, 550, 400, 450, BR320, 320L, 340, TS400. With metal pin. MIN005

Starter Pulley for HOMELITE



Order No. 39 - 8287

Starter pulley replaces Homelite 97768A, UP04091. Fits models XL, Super 2, 240, 245.

Starter Pulley for HUSQVARNA



Order No. 39 - 13095

Starter pulley replaces Husqvarna 537-09-25-01. Fits models 340/ 345/346/350/45, 350, 351, 353, 445, 455, 460, 2141, 2149.

Starter Pulley Kit for POULAN



Order No. 39 - 12748

Starter pulley replaces Poulan 530-069313. Fits gas saw models 2200, 2500, 255, 2600, 2750, 2900, 295, 3050, 310, 315. Also fits Husqvarna models 136 & 141.

Starter Pulley for STIHL



Order No. 39 - 9636

Starter pulley replaces Stihl 1117-195-0402. Fits models 038, 041, 042, 045, 048, 051, 056, 08, 075, TS350. Metal.



Order No. 39 - 7067

Replaces Stihl 1125-195-0401, 1125-195-0400. Used on Stihl model 034.



Order No. 39 - 7068

Replaces Stihl 1122-195-0400. Used on models 064, 08S & 051 (new).

Starter Ring for STIHL



Order No. 39 - 9634

Starter ring replaces Stihl 0000-961-5116. Fits models 08, 041 & 045. Plastic ring.

39
CHAIN SAW ACCE.



Starter Pulley for STIHL



Order No. 39 - 11579

Starter pulley replaces Stihl 1123-195-0400. Fits model MS170/180, MS230/240 & MS250/260.



Order No. 39 - 9635

Starter pulley replaces Stihl 1128-195-0400. Fits models 036 & 044.

Starter Pulley for HUSQVARNA



Order No. 39 - 13588

Starter pulley replaces Husqvarna 506016401 & 537201901. Fits models 40, 45 & 335 XPT.

Starter Pulley for ECHO



Order No. 26 - 13532

Starter pulley replaces Echo 177215-43130. Fits models SRM3000, SRM3605, SRM4605, CLS 4600-4610.

Order No. 39 - 7296

Clutch assembly replaces Stihl 1108-160-2002. Fits model 08S.



AV Mounts



Order No. 39 - 7085

Replaces Stihl 1118-790-9930. Fits model 028.

AV Buffer for HUSQVARNA



Order No. 39 - 9630

AV buffer replaces Husqvarna 501628701. Fits model 266. Plastic crankcase.

AV Buffer for HUSQVARNA



Order No. 39 - 9631

AV buffer replaces Husqvarna 501699401. Fits model 266. Plastic crankcase.



Order No. 39 - 7086

Replaces Stihl 1121-790-9912/1121-790-9911. Fits models 024 & 026.

Order No. 39 - 7087

Replaces Stihl 1121-790-9909, 1121-790-9906. Fits models 024 & 026.



CHAIN SAW ACCESSORIES



AV Buffer for STIHL



Order No. 39 - 11581

AV buffer replaces Stihl 1123-791-2800. Fits model MS170/180.

AV Buffer for STIHL



Order No. 39 - 11582

AV buffer replaces Stihl 1123-790-9900. Fits model MS 230/250.

AV Buffer for STIHL



Order No. 39 - 11583

AV buffer replaces Stihl 1123-791-2805. Fits model MS 230/250.

AV Buffer for STIHL



Order No. 39 - 11585

AV buffer replaces Stihl 1121-790-9912. Fits model 038/MS380.

AV Buffer for STIHL



Order No. 39 - 11586

AV buffer replaces Stihl 1121-790-9909. Fits model 038/MS380.

Metric Bolt Assortment for Chain Saws

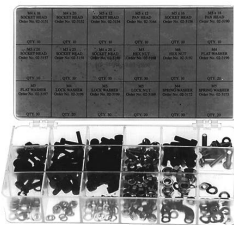

Order No. 01 - 5896

Contains a combination of the most popular metric bolts, nuts, washers and screws for Husqvarna, Stihl.

Chain Saw Cap Bolt Assortment for POULAN and HOMELITE Saws



Order No. 01 - 1571

240 Pieces.

Replacement packages of parts also available. See Displays & Assortments for order numbers.

Starter Recoil Assembly for SHINDAIWA

Order No. 26 - 13528

Starter recoil assembly replaces Shindaiwa A051001520 / 68206-75010. Fits Red Max Blowers Zehoah T4030-75100, EB4300, EB431, EB4400, EB4401, EB441, EB6200, EB7000, EB7000RH, EB7001, EB7001RH, EBZ4800, EBZ4800RH, EBZ5000, EBZ5000Q, EBZ5100, EBZ5100-CA, EBZ5100RH, EBZ5100Rh-CA.



CHAIN SAW ACCE. 39



CHAIN SAW ACCESSORIES

Starter Recoil Assembly for STIHL



Order No. 26 - 13582

Starter recoil assembly replaces Stihl 4180-190-4000. Fits models KM90, KM100, KM110, KM130, FS90, FS100, FS110, FS130, FC90, FC100, FC110, FC130.

Recoil Assembly for STIHL



Order No. 26 - 13562

Recoil assembly replaces Stihl 1125-080-2105. Fits models FS034, 034 AV 036, MS340, MS360.

Recoil Assembly for STIHL



Order No. 26 - 13561

Recoil assembly replaces Stihl 1128-080-2104. Fits models 044, 046, MS440 and MS460.

Recoil Assembly for STIHL



Order No. 26 - 13560

Recoil assembly replaces Stihl 1122-080-2110. Fits models 066, MS650, MS660.

Recoil Assembly for STIHL



Order No. 26 - 13612

Recoil assembly replaces Stihl 1127-080-2103/1127-080-2103A. Fits models 029, 031, 039, MS290, MS310, MS390 Chain saws.

Recoil Assembly for STIHL



Order No. 26 - 13591

Recoil assembly replaces Stihl 4238-190-0301, 4238-190-0300 & 4238-190-0402B. Fits models TS410/TS420 Cut off saws.

Recoil Assembly for STIHL



Order No. 26 - 13529

Recoil assembly replaces Stihl 4282-190-0300A. Fits models BR500, BR550, BR600.

Starter Recoil Assembly for STIHL



Order No. 26 - 13580

Starter recoil assembly replaces Stihl 4203-190-0405. Fits models BR320, BR340, BR380, BR400, BR420 blowers.

Starter Recoil Assembly for STIHL

Order No. 26 - 13628

Starter recoil assembly replaces Stihl 4223-190-0401. Fits model TS400 Cutquick cut off saws.



SNOWBLOWER ACCESSORIES

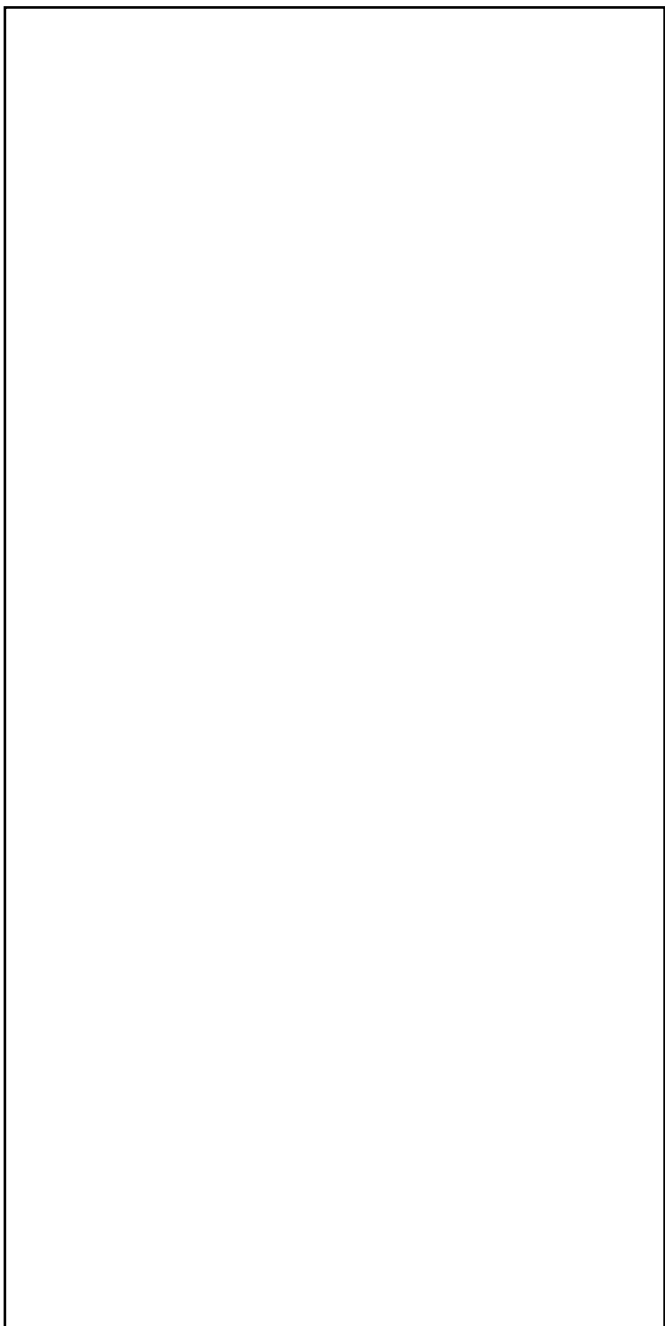
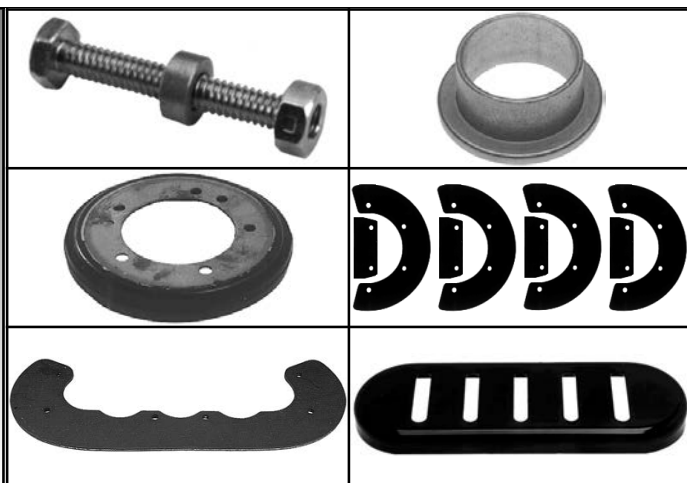

Quick-Glance

SNOWBLOWER ACCESSORIES	PG.
Shear Pin	1221-1222
Drive Disk	1221
Shafts	1222
Bushings	1222
Scraper Bars	1223-1226
Rubber Paddles	1223-1226
Shave Plate	1226
Tire Chains	1227
TerraGrip Traction Belts	1227
Shoe	1228
Skids	1228-1229
Air Vane	1229
Snow Stik	1229



SNOWBLOWER ACCESSORIES

Shear Pin & Nut for MTD



Order No. 41 - 8628

Shear pin & nut replaces MTD 710-0891, 910-0891 (pin) & 712-0158 (nut). Fits MTD with auger drive snowblowers. Size 5/16" - 18 x 1-3/4". MIN005

Order No. 41 - 8627

Shear pin & nut replaces MTD 710-0890, 910-0890A (pin) & 712-0158 (nut). Fits MTD with auger drive snowblowers. Size 5/16" - 18 x 1-1/2". MIN005

Shear Bolt & Nut Set for AYP



Order No. 41 - 13397

Shear bolt and nut set replaces AYP 188243. Also replaces 192090, 198636, 179828, 187494, 532179828, 532187494, 532188243. 1/4 - 20 threads, 2" long. Set of 6.

Shear Pin & Nut for NOMA



Order No. 41 - 9564

5/16" Shear pin & nut replaces Noma 301171. Fits Noma, John Deere, Sears, Eagle, AYP and Husky Snowblowers. MIN005

Order No. 41 - 8938

1/4" Shear pin with spacer & nut replaces Noma 301172. Fits Noma, John Deere, Sears, Eagle, AYP & Husky snowblowers. MIN005

Ignition Switch



Order No. 31 - 2922

Ignition switch. Replaces Murray 21064. Also works on Gravely, 5 terminals. Also replaces Toro 23-0660.

Ignition Keys



Order No. 31 - 2932

Ignition Key fits Murray Switch 21064 and most Universal type switches. MIN010

Shear Pins



Order No. 41 - 916

Replaces Ariens 510015. 2-1/8" x 5/16" threads with lock nut. MIN005

Order No. 41 - 918

Replaces Ariens 532005. 1-9/16" x 1/4" threads with lock nut. MIN005

Order No. 41 - 917

Replaces Ariens 532005, 510016. 1-3/4" x 1/4" threads with lock nut. Also replaces Jacobsen numbers 342449 and 400120. MIN005

Starter Key for MTD



Order No. 31 - 13278

Starter key replaces MTD 725-1660 / TC35062, Tecumseh 35062, Ariens 7500108/7532000. Fits MTD models 314-180-000, 314-180-088, TMO-3525203, 314-180-131 & 314-181-000. Pull / Push Key. MIN010

Drive Disc



Order No. 05 - 300

Replaces Snapper 1-0765 and Ariens Disc 3003. Jacobsen 158458. Gilson 32222. Also fits Sears Rider made by Murray.

Drive Disc for NOMA



Order No. 05 - 7018

Drive Disc. Replaces Noma 53830 & 313883. Also replaces Ariens 22013, 82-90 models. Fits 21" SP mowers.

Drive Disc for MTD



Outside Holes 1 1/32"
ID 1-1/8"
OD 6"

Order No. 05 - 8898

Drive disc replaces MTD 05080A. Fits snowblower models 500, 510, 520 & 600.

Drive Disc for SNAPPER Snowblowers



Order No. 41 - 7678

Drive Disc. Replaces Snapper 17226. Fits Snapper 4, 5, and 8 hp Snow thrower models 4222, 5222, 5242, 7222, 7242 and 8264. Also replaces Toro 37-6570

SNOWBLOWER ACCESSORIES



Shear Pin & Nut for HONDA



Order No. 41 - 5540

Shear Pin and Nut replaces Honda 90102-732-010 & 90114-SA0-000. Thread M6 x 1.0, Shoulder Dia. 10mm, Length 1-29/32". MIN005

Shear Pin & Nut for ARIENS



Order No. 41 - 5575

Shear pin replaces Ariens 52100100. Includes bolts and nuts. Fits new 2007 model series 921001, 921002 & 921003 that take the new black shear bolt. 1/2" wrench size. MIN005

Shear Pin & Nut for HUSQVARNA



Order No. 41 - 5541

Shear Pin and Nut replaces Husqvarna 531002513 & 506714001. (Metric) MIN005

Shear Pin & Cotter Pin for MTD



Order No. 41 - 5549

Shear pin & Cotter pin replaces MTD 738-04124A. Fits models 31A-3BAD700 thru 31AS6LEG752 series 2005 and newer snowthrowers. MIN005

Impeller Shaft Kit for MURRAY / NOMA



Order No. 41 - 5543

Impeller shaft kit replaces Murray/Noma 50660 & MJ577412.

Snowblower Axle for MTD



Order No. 41 - 5546

Snowblower axle replaces MTD 738-0276. Fits two stage 28" & 33" models 800 & 900.

Gearbox Input Shaft for MURRAY / NOMA



Order No. 41 - 5544

Gearbox Input shaft replaces Murray/Noma MJ1401 & 1401. Length 19-3/16"

Differential Connecting Shaft for MTD



Order No. 41 - 5545

Differential connecting shaft replaces MTD 738-0284.

Snowblower Auger Bushing for ARIENS



ID 1" (25.40 mm)
OD 1-1/8" (28.58 mm)
Height 5/8" (15.88 mm)

Order No. 09 - 8446

Snowblower auger bushing replaces Ariens 55035. Fits all auger side bushings models 1960 to present. Oil impregnated, bronze.



ID 3/4" (19.05 mm)
OD 1" (25.40 mm)
Height 5/8" (15.88 mm)

Order No. 09 - 8445

Snowblower axle bushing replaces Ariens 55039. Fits older Ariens snowblowers model 1032. Oil impregnated, bronze.

Bearing for ARIENS



ID 3/4" (19.05 mm)
OD 1-3/4" (44.45 mm)
Height 1/2" (12.70 mm)

Order No. 09 - 487

Sealed high speed bearing. For Ariens 54063 snowblowers. bearing No. SC0493LU.

Worm Gear for MTD



ID 1-1/2"
OD 2-7/8"
Key 1/4"
Teeth 20
Thickness .885"

Order No. 41 - 5547

Worm gear replaces MTD 717-1425 & 917-1425. Fits 28" & 33" width snowblowers, models 800 & 900. Brass

41

SNOWBLOWER



SNOWBLOWER ACCESSORIES

Electronic Transistorized Ignition for NOVA



Order No. 31 - 8786
Nova transistorized ignition.

Friction Rubber Wheel for MTD



OD 4-7/8"
Thick 1/2"
ID 3-7/8"

Order No. 41 - 5612
Friction rubber wheel replaces MTD 935-0243B, 735-0243. Rubber disc for walk behind snow blowers.

SCRAPER BARS for ARIENS

Length 20"
Width 2-5/8"
Mounting Hole 7/8"



Order No. 41 - 5510
Replaces Ariens No. 32159. Fits model 2 + 2.

ARIENS

Length 23-3/4"
Width 2"
Mounting Hole 1/4"



Order No. 41 - 5566
Scraper bar replaces Ariens 10164. Fits model 924082.

Order No. 41 - 5567
Scraper bar replaces Ariens 22107. Fits all 20" augers. Length 19-1/4", Width 1-5/8", Hole 3/8".

BOLENS

Length 19-3/8"
Width 1-5/8"
Mounting Hole 1/4"



Order No. 41 - 5511
Replaces Bolens 1741179. Fits models 225, 300 and 350.

GILSON

Length 20-1/8"
Width 1-1/2"
Mounting Hole 1/4"



Order No. 41 - 5512
Replaces Gilson No. 201879. Fits model Snow Cannon.

HONDA

Length 19-5/8"
Width 2-7/8"
Mounting Hole 1-3/16"



Order No. 41 - 5522
Scraper Bar replaces Honda 76322-747-A10. Honda code 3526985. Fits model HS621.

HONDA

Length 19-3/8"
Width 2-1/2"
Mounting Hole 5/16"



Order No. 41 - 5537
Rubber auger kit replaces Honda 76322-V10-020 code 6672448. Fits HS520 snowblowers.

JACOBSEN

Length 19"
Width 2"
Mounting Hole 1/4"



Order No. 41 - 5513
Replaces Jacobsen 99038-5 and 991296. Fits model Snowburst.

MTD

Length 19-7/8"
Width 2-1/8"
Mounting Hole 1"



Order No. 41 - 5523
Scraper Bar replaces MTD 731-1033. Fits model Snow Wolf.

NOMA

Length 20-7/8"
Width 1-5/8"
Mounting Hole 1/4"



Order No. 41 - 5531
Replaces Noma 302418 & Sears 53688547 & John Deere M94511. Fits Noma, Sears & John Deere 5 hp models.

Snowblower Paddle Set for MTD



Order No. 41 - 13167
Snowblower paddle set replaces MTD 753-04472. Includes (4) 735-04032 spirals & (2) 735-04033 paddles. Fits newer 21" single stage throwers.

SNOWBLOWER ACCESSORIES



SCRAPER BARS for SNAPPER

Length 16-3/8"
Width 2"
Mounting Hole 1/4"



Order No. 41 - 5528

Replaces Snapper 7028425, 7024619, 7028425. Fits model LE317.

SNAPPER

Length 18-1/2"
Width 2"
Mounting Hole 1/4"



Order No. 41 - 5529

Replaces Snapper 7028426, 24365 & 35948. Fits model LE319.

SNAPPER

Length 19-1/4"
Width 2"
Mounting Hole 1/4"



Order No. 41 - 5514

Replaces Snapper 7028427, 7018764. Fits model 3201.

TORO

Length 15-3/8"
Width 2-1/8"
Mounting Hole 1/4"



Order No. 41 - 5527

Replaces Toro 75-8780. Fits Toro Powerlite models.

TORO

Length 19-1/8"
Width 1-15/16"
Mounting Hole 1/4"



Order No. 41 - 5524

Scraper Bar replaces Toro 55-8760. Fits model CCR2000.

TORO

Length 19-5/8"
Width 1-7/8"
Mounting Hole 1/4"



Order No. 41 - 5515

Replaces Toro 23-3170. Fits models S-200 and 620.

TORO

Length 19-5/8"
Width 2-1/8"
Mounting Hole 1/4"



Order No. 41 - 5525

Scraper Bar replaces Toro 71-5390. Fits model CCR1000.

Scraper Blade for ARIENS



Order No. 41 - 13168

Scraper blade replaces Ariens 03809400. Fits models SS522, SS722E, S322.

RUBBER PADDLES for ARIENS



Order No. 41 - 5502

Replaces Ariens 532018. Fits all 2 + 2 models. 8 piece set.

HONDA



Order No. 41 - 5505

Replaces Honda 1003375 (4 ea.) and Honda 1003391. 8 piece set.

BOLENS

Length 18"
Width 2-1/4"
Mounting Hole 1/4"



Order No. 41 - 5503

Replaces Bolens 1737488. Fits models 225, 225E, 300, 300E, 350, 350E and 520.

JACOBSEN

Length 18"
Width 2-1/2"
Mounting Hole 1/4"



Order No. 41 - 5506

Replaces Jacobsen JA51888-4. Fits model Snowburst.

MIN002

41

SNOWBLOWER



SNOWBLOWER ACCESSORIES

RUBBER PADDLES for HONDA



Order No. 41 - 5526

Replaces Honda 72523-747-000 (1) pcs. & 72522-747-000 (2) pcs. & 72521-747-000 (3) pcs. Fits models 521 & 621. **6 piece set.**



Order No. 41 - 5536

Rubber auger kit replaces Honda 06720-V10-030 code 6813166. Fits HS520 snowblowers. **6 piece set.**

NOMA



Order No. 41 - 5533

Replaces Noma 302565 (4) pcs. & 57121 (2) pcs., John Deere M94576 (4) pcs. & M94574 (2) pcs. Fits 3-1/2 & 5 hp models. **6 piece set.**



Order No. 41 - 13169

Snowblower paddle set for Sears/Noma. Fits Craftsman and all Sears 22" model numbers: 536.88150, 538.885210 that do not have replacement paddles.

GILSON



Order No. 41 - 5504

Replaces Gilson 207527 (4 ea.) and 207141 (2 ea.). Fits models 55190, 55185, 55131, 55203 and 55312. **6 piece set.**

SNAPPER



Order No. 41 - 5508

Replaces Snapper 7060631. Fits model 3201. **6 piece set.**

MTD



Order No. 41 - 5521

Fits MTD and Yardman. Replaces MTD 731-0782 (BAR), 731-0780 (right curve), 731-0781 (left curve), 753-0613. **6 piece set.**



Order No. 41 - 13170

Snowblower paddle set replaces Snapper 7061215, 70761215. Fits 17" model LE-17 snowthrowers.

Rotor Blade Paddle for TORO



Order No. 41 - 5532

Replaces Toro 54-9921. Fits Toro CCR-1000 models. **Inside length 14-1/8", Outside length 21".**

Order No. 41 - 5539

Rotor blade paddle replaces Toro 99-9313. Fits CCR 3000 snowblowers.

TORO

Length 17-5/8"
Width 2-5/8"
Mounting Hole 1/4"



Order No. 41 - 5509

Replaces Toro No. 23-3730. Fits models S-200 and 620.

41

SNOWBLOWER

SNOWBLOWER ACCESSORIES



Shave Plate for MTD



Order No. 41 - 5591

22" Shave plate replaces MTD 790-00117-0637 / 784-5576-0637. Fits 22" MTD two-stage snowthrower models 611D & 623D.



Order No. 41 - 5592

24" Shave plate replaces MTD 790-00120-0637. Also replaces MTD 784-5581A, 784-5581A-0637, 784-5581A-0662, 784-5581A-0687.



Order No. 41 - 5593

26" Shave plate replaces MTD 790-00121-0637, 784-5579A, 753C0628.



Order No. 41 - 5594

27" or 28" Shave plate replaces MTD 790-00118-0637, 784-5582A, 753C0629.



Order No. 41 - 5595

30" Shave plate replaces MTD 790-00119-0637.

Snowblower Paddle for TORO



Order No. 41 - 5596

Snowblower paddle replaces Toro 84-1980. Made of TICOR material from recycled tires. Resist aging and abrasion, long lasting. Can withstand extreme temperatures. Environmentally friendly construction. USA Made. Similar to our 41-5534.



Order No. 41 - 5597

Snowblower paddle replaces Toro 99-9313. Made of TICOR material from recycled tires. Resist aging and abrasion, long lasting. Can withstand extreme temperatures. Environmentally friendly construction. USA Made. Similar to our 41-5539.

Paddle for TORO



Order No. 41 - 5520

Snowblower Paddle repl. Toro 55-9251. Fits model CCR2000. Inside length 14-3/8", Outside length 21-7/8".



Order No. 41 - 5534

Paddle replaces Toro 80-0660 & 84-1980. Fits Toro powerlite snowthrowers.

41

SNOWBLOWER



SNOWBLOWER ACCESSORIES

TIRE CHAINS



Order No.	Cross Chain Spacing	Application
41 - 5551	2	400 x 480 x 8
41 - 5565	2	400 x 480 x 8 Deep Lug
41 - 5563	2	410 x 350 x 4 Deep Lug
41 - 5552	2	410 x 350 x 4
41 - 5535	2	410 x 350 x 5
41 - 5550	2	410 x 350 x 6 / 12.25 x 3.50
41 - 5564	2	12 x 350 x 6 Deep Lug
41 - 5553	2	13 x 500 x 6 / 12.5 x 450 x 6
41 - 5560	2	14 x 400 x 6
41 - 5569	2	15 x 6.00 x 6
41 - 5554	2	16 x 650 x 8 / 570 x 8
41 - 5548	2	16 x 650 x 8 Deep Lug
41 - 5555	2	18 x 650 x 8
41 - 5559	2	18 x 850 x 8
41 - 5557	2	18 x 950 x 8
41 - 5570	2	20 x 10.00 x 8 / 20 x 10 x 10
41 - 5558	2	20 x 800 x 10 / 20 x 800 x 8
41 - 5556	2	23 x 950 x 12
41 - 5561	2	23 x 1050 x 12
41 - 5574	4	23 x 10.50 x 12
41 - 5571	2	23 x 8.50 x 12
41 - 5577	2	24 x 12 x 12
41 - 5572	2	26 x 12 x 12
41 - 5573	4	29 x 12 x 15

ALL CHAINS ARE ZINC PLATED. TWO LINK SPACING
CHAINS ARE PACKAGED AND PRICED PER PAIR

TerraGrip Traction Belts



Order No.	SIZE
41 - 5604	16 X 6.50 X 8
41 - 5606	20 x 8 x 8
41 - 5607	20 x 9/10 x 8
41 - 5605	20 x 10 x 10 / 22 x 9.5 x 12
41 - 5609	23 x 9.5 x 12
41 - 5608	23 x 10.5 x 12
41 - 5610	24 x 12 x 12
41 - 5611	26 x 12 x 12

TerraGrip Traction Belts are the innovative traction aid that provides a significant benefit over traditional tire chains by protecting the driving surface. Multi-ply rubber slats surround the tread of the tire providing a secure fit with no steel touching the driving surface. Easy installation, no tools required.

SNOWBLOWER ACCESSORIES



Snowblower Skid for MTD



Order No. 41 - 5584

Snowblower skid replaces MTD 731-06472, universal deluxe poly snowblower skid shoes kit. Fits most AYP, MTD, Craftsman, Murray, Toro 2 stage snow throwers. Helps protect driveway walkways, garages and porches for snowblower damage. Non-abrasive material helps prevent scratches..

Snowblower Skid for MTD



Order No. 41 - 9122

Snowblower skid replaces MTD 05002-0637. Fits 1988 & 1989, 20" & 26" snowblowers models 225 & 590.

Order No. 41 - 8828

Snowblower skid replaces MTD 784-5580, 784-5580-0637. Fits all two stage units

Snowblower Skid for MTD

ID 10"
OD 10-1/4"
Width 3-1/2"



Order No. 41 - 7766

Snowblower skid replaces MTD 784-5038B, 784-5038A. Fits models 449, 450, 550, 552, 586 & 588.

Snowblower Runner for ARIENS



Order No. 41 - 5568

Runner replaces Ariens 24599. Fits all Ariens blowers from 60's until present. Also fits John Deere, Bolens, MTD, Simplicity. Ariens models 924080 & 924082 with 24" auger.

Snowblower Runner For ARIENS



Order No. 41 - 5134

Double sided, reversible runner replaces Ariens 02483851, 02483859. Fits all Ariens snowblowers from 60's until present. Used on models 924080 & 924082 with 24" auger. Also fits John Deere, Bolens, MTD & Simplicity. Painted Black.

Universal Snowblower Skid



Order No. 41 - 5585

Universal snowblower skid shoes set. Fits most AYP, Ariens, MTD, Craftsman, Noma, Murray, Snapper & Toro 2 stage snowthrowers. Eccentric washers allow mounting to a variety of mounting dimensions. Mounting width (min 2", max 3", 5/16" bolt holes. Similar to our 41-8635.

Snow Blower Skid for HONDA



Order No. 41 - 13043

Snow blower skid replaces Honda 76153-736-010 & 76153-736-000 / 1878628. Fits HS55, HS55K1, HS55K2, HS70, HS80, HS80K1, HS50.

Snow Blower Skid for MURRAY



Order No. 41 - 13042

Snow blower skid replaces Murray 1740718HMA/760061MA, 301380E701, 301380E717MA, 780061MA, 1740718HMA. Fits models 1695557- C950-52846-0, 1695558-C950-52847-0.

Universal Snowblower Shoe

Order No. 41 - 8635

Universal snowblower shoe. Fits White models ST800, 850, ST950, 1050, Ariens models ST524, ST824, ST924. Also fits many Toro, MTD, John Deere, Noma, Murray, Snapper & Argo Allis models.



41

SNOWBLOWER



SNOWBLOWER ACCESSORIES

Snowblower Skid for AYP



Order No. 41 - 5589

Snowblower skid replaces AYP 174762X431 & 532174762. Left hand.

Snowblower Skid for AYP



Order No. 41 - 5590

Snowblower skid replaces AYP 178777X431 & 532178777. Right hand.

Air Vane for TORO



Order No. 41 - 8993

Air vane replaces Toro 52-7060. Fits snowblower models S-200 & S-620. Takes 7 per unit.

SnoStik

Order No. 41 - 9962

Snostick is a brand new product for helping snowblower users remove slush and snow from the discharge chute area. A great safety device, keeping your hands away from danger while they stay warm and dry. (25 per case) **Sold individually.**



SNOWBLOWER REPLACEMENT PARTS

Replacement Paddle Fasteners and Scraper Bolts

Order No.	Description	
41 - 5517	Bolt (Scraper) SBB-TJ-100 100/box	MIN010
41 - 5518	Nut (Scraper) SBN-TJ-100 100/box	MIN010
41 - 5519	Fastener (Paddle) PF-TJ-100 100/box	MIN010

Fasteners (Toro & Jacobsen only)

Toro—Paddles have 7 fasteners on each (14 fasteners per machine). Scraper has 3 bolts and 3 nuts each.

Jacobsen—Paddles have 6 fasteners each (12 fasteners per machine). Scraper has 3 bolts and 3 nuts each.

Note: Paddle fasteners—Should be replaced when paddles are replaced. Our fasteners are the next size larger and help prevent backing out because of repeated removal and assembly.

Scraper bolts—Are a button head allowing the user to insert an allen wrench and thus remove more easily. Generally, the nut and bolt rust together and have to be cut apart.

Both the paddle fastener and the scraper bolt will have a pre-applied adhesive to help prevent loosening due to vibration.



41

SNOWBLOWER

TRANSMISSIONS & ACCESSORIES



42
Quick-Glance



Quick-Glance

DRIVE PARTS	PG.
Gear Box Assembly	1231
Jackshaft Coupler	1231
Brake Pad	1231
Differential	1231
Transmission	1232
Transaxle	1232
Drive Shaft	1233



Order No. 42 - 7097

Gear Box Assembly. Replaces Bobcat 38008-1N, Bunton PLA0965, Exmark 1-302029, John Deere PT8640, Kees 976380. Snapper/Kees 7076380 & 70362025. (12.5 to 1 Gear Ratio). Uses our **32-9458** gear oil



Coupler with Cover for EXMARK



Order No. 42 - 9579

Coupler with cover replaces Exmark 1-324340 & 1-323501, Scag 481581. Fits 5 speed mowers. Comes with grease fitting & cover. 9-spline center. Used with our **05-9580** drive shaft.

Jackshaft Coupler with safety cover for SCAG



Order No. 42 - 8250

Jackshaft coupler replaces Scag 46513 & 48226. Encore 363353. For 36", 48", 52" and 61" walk behind mowers. Also fits Toro 51-4260, Exmark 1-324157. Comes with grease fitting and safety sleeve. (36 spline)

Pro-Gear Coupler



Order No. 42 - 14185

Pro-Gear 31-1001 Coupler. Replaces Peerless 786177, Ariens 04901200, MTD/Cub Cadet Commercial Turf 00030353, Exmark 1-323680, Toro 98-0789. 9-Spline



Order No. 42 - 14184

Pro-Gear 31-1000 Coupler. Replaces Peerless 771834, Bobcat/Bunton 2308135, Husqvarna 539102164, 102164, Exmark 1-323501, 1-324340 & Wright 3949003. 9-Spline

Brake Pad for TECUMSEH

Length 1-1/8"
Width 1/2"
Height 1/4"

Order No. 42 - 7158

Brake pad replaces Tecumseh 799021/790006. Used on AMF, Simplicity. Fits Peerless 600 series transaxles.



Pro-Gear Differential



Order No. 42 - 14397

Pro-Gear differential replaces DR trimmer/mower 192301/19230. Fits DR field and brush mower 11.5, 13, 15, 17 and 18 hp walk behind models.



TRANSMISSIONS & ACCESSORIES



42
TRANSMISSIONS

Pro-Gear Transmission 5 Speed



Order No. 42 - 14177

Pro-Gear T7511 5-Speed transmission replaces Peerless 700-079, Ariens/Gravely 04901000/49010.

Pro-Gear Transmission 5 Speed



Order No. 42 - 14178

Pro-Gear T7512 5-Speed transmission replaces Peerless 700-083 & 794727, MTD Pro/Cub Cadet Commercial 01000152.

Pro-Gear Transmission
5 Speed



Order No. 42 - 14176

Pro-Gear T7510 transmission replaces Peerless 700-070A, Scag 481580, Bobcat 4127203, Toro/Exmark 1-323500 & Wright 39490001 & Red Hawk.



Pro-Gear Transmission 4 Speed



Order No. 42 - 14396

Pro-Gear T7401 4-Speed transmission. Fits DR Power 150591 & 15059.

Pro-Gear Transmission 3 Speed



Order No. 42 - 14395

Pro-Gear T7305 3-Speed transmission. Replaces Peerless 700-134, Sarlo 3110.

Pro-Gear Transaxle



Order No. 42 - 14394

Pro-Gear T2301 Transaxle. Replaces Billy Goat 521102.



Pro-Gear Drive Shaft



Order No. 42 - 14182

Pro-Gear 30-1020 Drive Shaft. Replaces Peerless 771846 & Bobcat/Bunton 2308134. 6-5/8" Long, 9-Spline

Pro-Gear Drive Shaft



Order No. 42 - 14181

Pro-Gear 30-1019 Drive Shaft. Replaces Peerless 776468 & Ariens/Gravely 04923100. 6-1/8" Long, 9-Spline

Pro-Gear Drive Shaft



Order No. 42 - 14180

Pro-Gear 30-1018 Drive Shaft. Replaces Peerless 771841 & Exmark 1-323502. 6-1/8" Long, 9-Spline

Pro-Gear Drive Shaft



Order No. 42 - 14179

Pro-Gear 30-1017 Drive Shaft. Replaces Peerless 771842 & Scag 481582, MTD Pro/Cub Cadet 00030352 & Wright 39490002. 6-1/4" Long, 9-Spline

Drive Shaft for EXMARK

Length 6"
Keyway 3/16"



Order No. 42 - 9580

Drive shaft replaces Exmark 1-323502. Fits 5 speed mowers. 9-spline. Used with our 05-9579 coupler with cover.

Pro-Gear Drive Shaft



Order No. 42 - 14183

Pro-Gear 30-1021 Drive Shaft. Replaces Peerless 776456 & Bobcat/Bunton 4130099. 7" Long, 9-Spline

PRESSURE WASHER PARTS & ACCESSORIES

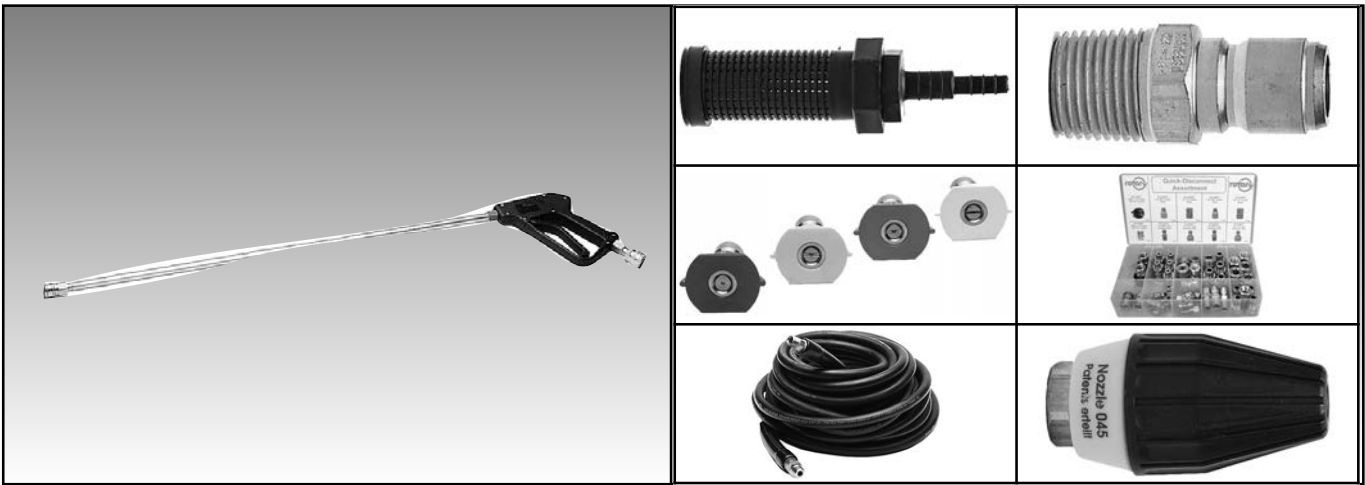

48

PRESSURE WSHER

Quick-Glance

**PRESSURE WASHER
ACCESSORIES**

PG.

Pressure Washer Accessories 1235-1237



**Teflon Tape for
Pressure Washer Fittings**



Order No. 48 - 9406

Teflon thread sealant tape for pressure washer fittings. 1/2" x 520" total length.

Steel & Brass Female Plugs



Order No.

Description

Steel

48 - 9411 1/4" FPT Plug. MIN002

48 - 9413 3/8" FPT Plug. MIN002

Brass

48 - 9417 1/4" FPT Plug. MIN002

48 - 9415 3/8" FPT Plug. MIN002

Note: FPT = Female Pipe Thread.

Steel & Brass Male Plugs



Order No.

Description

Steel

48 - 9412 1/4" MPT Plug. MIN002

48 - 9414 3/8" MPT Plug. MIN002

Brass

48 - 9418 1/4" MPT Plug. MIN002

48 - 9416 3/8" MPT Plug. MIN002

Note: MPT = Male Pipe Thread.

Brass Female Socket



Order

No.

Description

48 - 9420 1/4" FPT Socket.

48 - 9422 3/8" FPT Socket.

Brass Male Socket



Order

No.

Description

48 - 9419 1/4" MPT Socket.

48 - 9421 3/8" MPT Socket.

48

PRESSURE WASHER

PRESSURE WASHER PARTS & ACCESSORIES



Stainless Tips for Pressure Washers



Order No.	Degree/Color	Orifice Size	Order No.	Degree/Color	Orifice Size
48 - 9426	0° - Red	4.0	48 - 9434	25° - Green	4.0
48 - 9427	0° - Red	4.5	48 - 9435	25° - Green	4.5
48 - 9428	0° - Red	5.0	48 - 9436	25° - Green	5.0
48 - 9429	0° - Red	5.5	48 - 9437	25° - Green	5.5
48 - 9430	15° - Yellow	4.0	48 - 9438	40° - White	4.0
48 - 9431	15° - Yellow	4.5	48 - 9439	40° - White	4.5
48 - 9432	15° - Yellow	5.0	48 - 9440	40° - White	5.0
48 - 9433	15° - Yellow	5.5	48 - 9441	40° - White	5.5

PRESSURE WASHER 48

Trigger Gun



Order No. 48 - 9408

4500 PSI trigger gun for pressure washers.

Trigger Gun Assembly



Order No. 48 - 9446

4500 PSI trigger gun for pressure washers, with 30" aluminum wand, quick-disconnects.

Trigger Gun Repair Kit



Order No. 48 - 9409

Repair kit for our 48-9408 & 48-9446 trigger guns.

Pressure Regulator



Order No. 48 - 9424

Pressure regulator, Unloader. 1/4" By-Pass, 3/8" Inlet, 3/8" Discharge. Specifications: 1500-3000 PSI, 8GPM, 200°F.

Chemical Injector



Order No. 48 - 9425

20% Draw rate chemical injector. Fixed mixture. Specifications: 20% draw rate, 3 to 5 GPM, 3/8" x 3/8" MPT.

Brass Chemical Nozzle



Order No. 48 - 9442

Brass chemical nozzle for pressure washers. Specifications: 65° #40 orifice, black coded collar.



PRESSURE WASHER PARTS & ACCESSORIES

DK Rotating Nozzle



Order No. 48 - 9443

DK rotating nozzle for pressure washers. Specifications: 3200 PSI, 180°.

Screw Type Disconnect



Order No. 48 - 9447

Screw type disconnect for pressure washers. Specifications: M22 x 1.5 thread, Rated: 4000 PSI, 3/8" x 3/8" FPT.

Pressure Hose



Order No. 48 - 9448

3/8" x 50' pressure hose for pressure washers. Specifications: 3000 PSI.

Hi-Pressure Strainer



Order No. 48 - 9444

Hi-Pressure strainer for pressure washers. Filter with 1/4" quick disconnect. Specifications: 100 mesh screen.

SALES PROMO & SERVICE AIDS

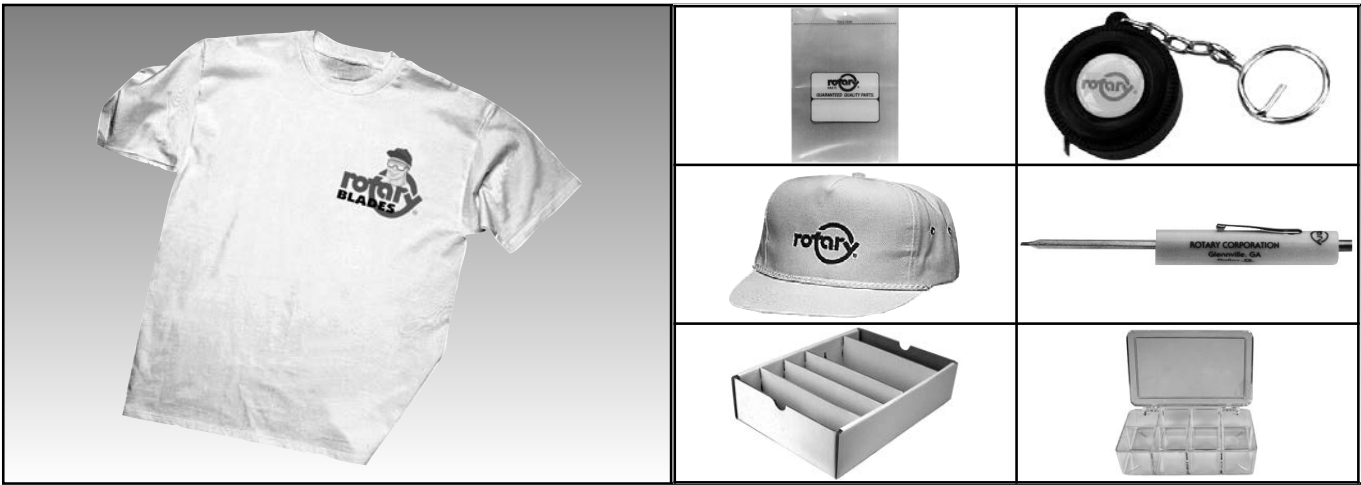

Quick-Glance

SALES PROMO & SERVICE AIDS PG.

Service Aids

1239-1242



**Belt Rack
(30 Feet)**

Belt Rack. Wood base with predrilled mounting holes and 8 adjustable wire hangers per section. Comes boxed 10 sections per box, each section is 3' in length. One box will display up to 80 rows of belts.



Order No. 50 - 12250

Belt display rack, 10 racks per box.

Rotary Debris Bag



Order No. 50 - 9246

14" x 14" Rotary debris bag. (black)

Service Parts Bag



Order No. 50 - 7256

Service Parts Bag, measures 8-3/8" x 12", writing area of 5" x 1-1/2" and has a hang hole for easy use. MIN100

Merchandise Bags



Order No. 50 - 9503

High density white plastic merchandising bags. Measurements 10" x 6" x 21". Boxed in qty's of 1000. MIN1000

Rotary Pocket Screwdriver



Order No. 50 - 8016

Rotary Pocket Screwdriver. Comes with interchangeable phillips or flat head. Length 5-9/16".

Bin Boxes

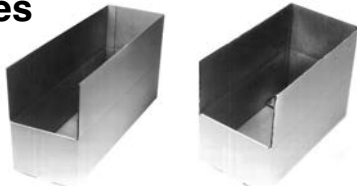

Order No. 50 - 8202

2" Width x 4" Height x 12-1/2" Length, White Bin Box. MIN010

Order No. 50 - 8203

4" Width x 4" Height x 12-1/2" Length, White Bin Box. MIN010

Order No. 50 - 8204

6" Width x 4" Height x 12-1/2" Length, White Bin Box. MIN010

Order No. 50 - 8206

6" Width x 8-1/2" Height x 12" Length, White Bin Box. MIN010

Order No. 50 - 8205

8" Width x 12-1/2" Height x 24" Length, White Bin Box. MIN010

Bin Box With Dividers

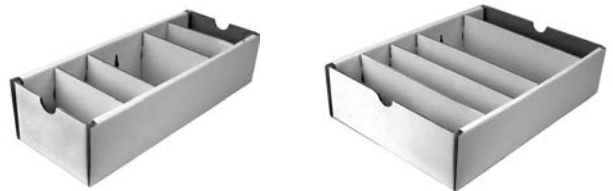

Order No. 50 - 12257

4" wide x 3" height x 12" length, bin box with dividers. Sold 25 per bundle. MIN025

Order No. 50 - 12258

8" wide x 3" height x 12" length, bin box with dividers. Sold 25 per bundle. MIN025

50

SERVICE AIDS

SALES PROMO & SERVICE AIDS



Rotary Tape Measure



Order No. 50 - 9115

Rotary tape measure key chain. Measures items up to 40" in length. 1-1/2" Dia., key chain.

Repair Tags



Back



Front

Order No. 32 - 9087

These repair tags are sharply printed and made of durable material, with reinforced eyelets. They help you to organize information, minimize errors, and alert personnel to special instructions. Size: 3-1/4" x 6-1/4".

MIN100

Plastic Compartment Boxes



Order No. 50 - 8992

4-1/2" x 2-1/2" small plastic compartment box. Plastic box used with our 01-1572, 01-8975 assortments. (8 compartments)



Order No. 50 - 8990

11" x 6" large plastic compartment box. Plastic box used with our 01-7203, 01-7204 assortments. (15 compartments)



Order No. 50 - 8989

8" x 4-1/2" small plastic compartment box. Plastic box used with our 01-5897, 01-8900 assortments.



Order No. 50 - 8991

11" x 6-1/2" large plastic compartment box. Plastic box used with our 01-6576, 01-6579 assortments. (18 compartments)

50

SERVICE AIDS



Rotary Replacement Belt Sleeves



Order No. 50 - 94195

Rotary's 5/8" small generic reversible belt sleeve.



Order No. 50 - 94196

Rotary's 1-1/4" large generic reversible belt sleeve.

Trimmer Line Header Card



Order No. 50 - 10425

Trimmer line header card. used with our 50-10426 Display.

Rotary Low Profile Pink Cap



Order No. 50 - 14650

Rotary Low profile pink cap.

Rotary Low Profile Khaki Cap



Order No. 50 - 14651

Rotary Low profile khaki soft mesh cap.

50

SERVICE AIDS

SALES PROMO & SERVICE AIDS



Rotary Custom Caps



A



B

Order No.	Description
50 - 8695	Pro-Style Golf Cap with braid (A)
50 - 8699	Classic Baseball Style Cap (B)

Bumper Sticker



Rotary store signs. Package includes (1) 48" x 12", (1) 20" x 5" and (1) Static Sticker. Signs are made of rigid but flexible polystyrene. Static stickers are designed to be applied to the inside of door or window facing outside without glue or adhesives.

Order No.	Description
50 - 8703	Bumper Sticker

50

T-Shirts



100% white cotton T-shirts have design printed on back with matching front crest (inset).
 Sizes: M, L, XL, XXL

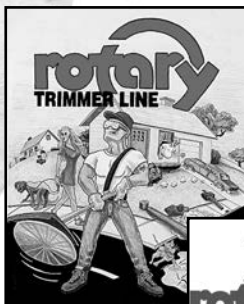
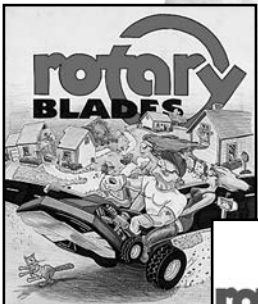

Order No.	Description
50 - 8704	Joyride T-Shirt
50 - 8705	Cuttin' Loose T-Shirt

SERVICE AIDS



O.E.M. REPLACEMENT CROSS REFERENCE

2014 CROSS REFERENCE

OEM #	Our #	Page #	OEM #	Our #	Page #	OEM #	Our #	Page #
AC DELCO			AMF/DYNAMARK/NOMA			AMF/DYNAMARK/NOMA		
44FFS	24 - 5858	595	301171	41 - 9564	1221	49405	12 - 5121	212
44TS	24 - 5857	596	301172	41 - 8938	1221	49405	12 - 7531	215
44X6S	24 - 2534	595	301935	12 - 6636	212	49562	09 - 7917	132
45F	24 - 5855	594	302289	12 - 6872	240	49570	12 - 7480	215
45TS	24 - 5857	596	302291	12 - 7609	216	49878	12 - 5211	213
46F	24 - 5855	594	302418	41 - 5531	1223	50734	10 - 2225	162
46TS	24 - 5857	596	302565	41 - 5533	1225	50782	10 - 2208	174
585F	24 - 5856	594	302611	07 - 8298	107	52204	07 - 6918	104
C82	24 - 2535	594	302611	07 - 3320	106	52407	09 - 8306	146
C86	24 - 5856	594	303065	15 - 6099	394	53307	12 - 7448	214
C87	24 - 5856	594	303241	12 - 6898	240	53363	12 - 7512	215
CR44NS	24 - 2538	595	303241	12 - 7533	215	53716	31 - 10771	1071
CS42S	24 - 5850	595	304076	10 - 7251	201	53716	31 - 3319	1071
LM46	24 - 1294	594	305698	12 - 7516	215	53836	09 - 8783	145
M41FF	24 - 2552	594	306931	15 - 6024	393	54758	12 - 6896	240
M43FF	24 - 2536	594	306932	15 - 6025	393	54758	12 - 7525	215
M45FF	24 - 5855	594	309069	15 - 3406	393	54766	18 - 891	438
R42XLS	24 - 2539	595	309070	15 - 6099	394	54829	12 - 7473	215
R44TS	24 - 5857	596	310675	10 - 7251	201	54830	12 - 7514	215
R45TS	24 - 5857	596	310764	15 - 3336	393	54837	09 - 9046	145
R46TS	24 - 5857	596	313883	05 - 7018	93	54902	09 - 3303	146
S41XLR	24 - 2554	596	313907	10 - 1170	201	55914	12 - 7436	214
S42 XLR	24 - 2553	596	316608	15 - 6138	394	56424	10 - 1172	201
S85F	24 - 5856	594	325751	15 - 6468	394	57121	41 - 5533	1225
			327519	10 - 1172	201	57214	12 - 7528	215
			330278	15 - 6286	394	577023	09 - 9046	145
AGS			35374	13 - 731	36	57736	13 - 726	36
532-050-422-533	15 - 6482	327	39454	12 - 7531	215	58170	12 - 7620	216
532-050-422-543	15 - 6483	327	39454	12 - 5121	212	581730	09 - 9303	133
			39455	12 - 7506	215	58212	15 - 6024	393
AIRCAP			39455	12 - 5096	212	6826	13 - 734	36
10109-00-05	17 - 6889	428	39456	12 - 5196	213	6826	13 - 5869	263
10680-01	15 - 3366	327	39498	13 - 714	36	779057	10 - 1170	201
122035	15 - 2051	327	39979	09 - 339	146	779058	10 - 7251	201
			40195	09 - 3305	146	782223	10 - 3301	171
ALLEN			40223	13 - 721	36	782964	13 - 731	36
H192271	15 - 6104	327	41740	12 - 7481	215	782965	15 - 1085	393
SE1601	27 - 9035	327	42111	12 - 7615	216	782965	15 - 3447	393
			42690	20 - 7730	510	782966	31 - 3319	1071
AMF/DYNAMARK/NOMA			42879	20 - 1347	34	782971	15 - 1093	393
024373	08 - 368	117	43979	12 - 7499	215	782971	15 - 6021	393
1325	05 - 7018	93	43979	12 - 5089	212	782972	15 - 6031	393
150100	12 - 7533	215	44264	12 - 7541	215	9248	15 - 6031	393
202611	07 - 6918	104	44280	13 - 734	36	9648	09 - 5619	136
21865	12 - 7469	215	44280	13 - 5869	263	9648MA	09 - 5619	136
22557	10 - 312	39	45074	13 - 728	36	9757	09 - 5619	136
23763	10 - 312	39	45074	13 - 730	36	9757MA	09 - 5619	136
24167	08 - 368	117	45186	12 - 7506	215			
300323	15 - 6031	393	45216	12 - 7486	215	ARCHER		
300575	12 - 7477	215	47390	12 - 5104	212	12DO-CL-HX	35 - 13307	1149
300680	12 - 7128	240	47390	12 - 7514	215	12DO-CL-M	35 - 13305	1149
300747	12 - 7511	215	47611	12 - 7531	215	12DO-CL-PO	35 - 13302	1149
300920	13 - 12891	281	48044	12 - 6970	240	12DO-CL-SW	35 - 13309	1149
300920	13 - 2188	263						

O.E.M. REPLACEMENT CROSS REFERENCE



CROSS REFERENCE 2014

OEM #	Our #	Page #	OEM #	Our #	Page #	OEM #	Our #	Page #
ARCHER			ARIENS			ARIENS		
12XO-HS-HV	35 - 13309	1149	01552900	21 - 13998	526	05418800	09 - 7917	132
14DO-CL-M	35 - 13306	1149	01588100	08 - 10742	110	05418800	09 - 6513	133
14DO-CL-PO	35 - 13303	1149	01588100	08 - 10461	111	05435100	09 - 8199	131
16A8-RN-HV	35 - 13329	1149	02210700	41 - 5567	1223	05435100	09 - 481	131
16AO-RN-HV	35 - 13328	1149	02459900	41 - 5568	1228	05503000	09 - 8796	147
16AO-RN-SN	35 - 13323	1149	02483100	26 - 13643	621	05503500	09 - 8446	147
16DO-CL-PO	35 - 14235	1149	02483859	41 - 5568	1228	05503900	09 - 8445	146
16DO-CL-SW	35 - 13310	1149	02728500	15 - 3323	328	05521600	09 - 8783	145
16XO-HS-UHL	35 - 13315	1149	02728700	15 - 2137	328	06903200	03 - 9129	57
18A8-RN-UHL	35 - 13327	1149	02728759	15 - 2137	328	06907600	03 - 9128	57
18AO-RN-HV	35 - 13322	1149	02749300	15 - 6445	328	06908700	03 - 9127	57
18B8-TL-UH	35 - 13589	1149	02754100	31 - 9660	1066	07100124	08 - 8550	111
18BO-RN-UHL	35 - 13330	1149	03027800	15 - 3326	328	07115200	08 - 8006	120
18DO-CL-PO	35 - 13304	1149	03027859	15 - 3326	328	07124100	08 - 8006	120
20A3-RN-SN	35 - 13326	1149	03057700	31 - 3319	1071	07130100	08 - 11217	110
20A8-RN-HV	35 - 13320	1149	03057700	31 - 10771	1071	07130100	08 - 8197	111
20AO-RN-EC	35 - 13318	1149	03090800	10 - 9913	164	07160000	08 - 8007	120
20AO-RN-HV	35 - 13317	1149	03123700	15 - 6060	328	07200004	12 - 13505	221
20AO-RN-UHL	35 - 13321	1149	03181900	20 - 7783	515	07200007	12 - 13509	221
20X3-HS-HV	35 - 13316	1149	03248300	05 - 7018	93	07200020	12 - 13508	221
20XO-HS-EC	35 - 13313	1149	03277000	31 - 12839	1061	07200021	12 - 13507	221
20XO-HS-HV	35 - 13302	1149	03450500	10 - 11070	170	07200428	12 - 8428	221
20XO-HS-HV	35 - 13302	1149	03471700	07 - 6916	106	07200623	12 - 13508	221
20XO-HS-HV	35 - 13309	1149	03551000	31 - 8943	1071	07202300	12 - 8762	221
20XO-HS-HV	35 - 13311	1149	03551000	31 - 10772	1071	07202400	12 - 7472	215
20XO-HS-SN	35 - 13312	1149	03551000	31 - 5933	1071	07202400	12 - 5062	212
20XO-HS-UHL	35 - 13314	1149	03601800	10 - 9912	164	07202600	12 - 7586	216
24AO-RN-HV	35 - 13324	1149	03602400	31 - 7922	1064	07202600	12 - 5168	213
OR325	35 - 14338	1150	03624700	15 - 6254	328	07202600	12 - 7586	216
PD5017	36 - 12036	1177	03624759	15 - 6254	328	07202900	12 - 5176	213
PD5174	36 - 8055	1177	03643100	10 - 9911	164	07202900	12 - 7594	216
PD5176	36 - 12044	1177	03657100	31 - 9660	1066	07203000	12 - 7496	215
			03746500	15 - 13177	328	07203800	12 - 5086	212
			037805800	41 - 5510	1223	07204000	12 - 7444	214
ARIENS			03809400	41 - 13168	1224	07204200	12 - 5016	211
00129200	29 - 8611	667	03905600	07 - 6916	106	07204300	12 - 7437	214
00129251	29 - 8611	667	03971900	15 - 13177	328	07204300	12 - 5015	211
00129259	29 - 8611	667	04265400	15 - 14540	328	07204400	12 - 7594	216
00129300	29 - 8610	667	04901000/4901042	42 - 14177	1232	07204500	12 - 7581	216
00129351	29 - 8610	667	04901200	42 - 14185	1231	07204700	12 - 8432	221
00129359	29 - 8610	667	04923100	42 - 14181	1233	07204800	12 - 5011	211
00170800	05 - 300	92	05403900	09 - 481	131	07204800	12 - 7433	214
00300300	05 - 300	92	05403900	09 - 8199	131	07204900	12 - 5174	213
00522100	31 - 11470	1065	05404500	09 - 813	133	07204900	12 - 7592	216
0055430	15 - 6445	328	05405500	09 - 813	133	07205000	12 - 7589	216
01016400	41 - 5566	1223	05406300	09 - 487	133	07205000	12 - 5171	213
01016459	41 - 5566	1223	05408000	09 - 8869	130	07205000	12 - 7590	216
01137000	15 - 3322	328	05408900	09 - 6573	133	07205200	12 - 5196	213
01137000	09 - 3222	146	05412000	09 - 484	133	07205300	12 - 7593	216
01137059	15 - 3322	328	05412300	09 - 442	134	07205600	12 - 7475	215
01190600	31 - 9622	1063	05416200	09 - 6573	133	07205600	12 - 5065	212
01213200	13 - 2181	263	05418800	09 - 8507	132	07206000	12 - 7471	215
01545600	31 - 9657	1064	05418800	09 - 7210	132	07206500	12 - 5019	211
01545600	31 - 11470	1065						



O.E.M. REPLACEMENT CROSS REFERENCE

2014 CROSS REFERENCE

OEM #	Our #	Page #	OEM #	Our #	Page #	OEM #	Our #	Page #
ARIENS			ARIENS			ARIENS		
07206600	12 - 8430	221	07211900	12 - 5064	212	2749351	15 - 6445	328
07206600	12 - 7449	214	07212200	12 - 7515	215	27541	31 - 9660	1066
07206600	12 - 5017	211	07212300	12 - 7495	215	27541	31 - 9663	1066
07206700	12 - 7480	215	07212800	12 - 7506	215	3003	05 - 300	92
07207000	12 - 7591	216	07213000	12 - 8427	221	300300	05 - 300	92
07207200	12 - 7480	215	07213000	12 - 7482	215	30278	15 - 3326	328
07207300	12 - 7433	214	07213100	12 - 7441	214	3027859	15 - 3326	328
07207400	12 - 13284	221	07213100	12 - 7441	214	30577	31 - 3319	1071
07207500	12 - 7498	215	07213100	12 - 8426	221	3057700	31 - 10771	1071
07207600	12 - 7478	215	07213200	12 - 7485	215	3057700	31 - 3319	1071
07207700	12 - 7494	215	07213400	12 - 7578	216	30957	31 - 9658	1066
07207800	12 - 7520	215	07213500	12 - 7613	216	31237	15 - 6060	328
07208200	12 - 7434	214	07213600	12 - 12850	228	31237	15 - 6060	328
07208400	12 - 7435	214	07214200	12 - 7477	215	3123759	15 - 6060	328
07208500	12 - 5015	211	07214300	12 - 12850	228	31819	20 - 7783	515
07208500	12 - 7437	214	07214400	12 - 7532	215	32159	41 - 5510	1223
07208600	12 - 8430	221	07215500	12 - 7508	215	3215900	41 - 5510	1223
07208600	12 - 7791	254	07215500	12 - 5098	212	34717	07 - 6916	106
07208600	12 - 8431	221	07215700	12 - 7441	214	3471700	07 - 6916	106
07208600	12 - 7483	215	07216900	12 - 5098	212	3490500	31 - 14291	1067
07208700	12 - 7593	216	07217100	12 - 7432	214	35510	31 - 10772	1071
07208800	12 - 5005	211	07217100	12 - 7438	214	35510	31 - 5933	1071
07208900	12 - 7479	215	07217400	12 - 12461	230	35510	31 - 8943	1071
07209100	12 - 7491	215	07227600	12 - 7480	215	3551000	31 - 8943	1071
07209200	12 - 5172	213	07232100	12 - 7438	214	3551000	31 - 5933	1071
07209200	12 - 7589	216	07234300	12 - 12850	228	36024	31 - 7922	1064
07209300	12 - 7474	215	07236200	12 - 13506	221	36247	15 - 6254	328
07209300	12 - 5064	212	07240800	12 - 7513	215	3624759	15 - 6254	328
07209400	12 - 7432	214	07326901	02 - 9373	53	36531	10 - 8682	173
07209500	12 - 7489	215	07326901	13 - 9397	292	36571	31 - 9660	1066
07209600	12 - 7493	215	07500108	31 - 13278	1069	39032	03 - 9129	57
07209700	12 - 7431	214	07525300	20 - 9650	515	51001500	41 - 916	1221
07209800	12 - 7438	214	07532000	31 - 13278	1069	51001600	41 - 917	1221
07209900	12 - 7436	214	08828100	31 - 9659	1066	52100100	41 - 5575	1222
07209900	12 - 5014	211	09225400	10 - 11071	164	5221	31 - 9657	1064
07210100	12 - 7501	215	09232700	10 - 14009	164	527011	15 - 911	328
07210200	12 - 7518	215	09407700	10 - 14495	164	532005	41 - 917	1221
07210300	12 - 7533	215	10164	41 - 5566	1223	532005	41 - 918	1221
07210500	12 - 7480	215	1016400	41 - 5566	1223	53200500	41 - 918	1221
07210600	12 - 5020	211	11370	15 - 3322	328	53200500	41 - 917	1221
07210600	12 - 7442	214	12132	13 - 2181	263	532018	41 - 5502	1224
07210800	12 - 7480	215	1213200	13 - 2181	263	53201800	41 - 5502	1224
07210800	12 - 8428	221	1545600	31 - 9657	1064	54045	09 - 813	133
07210900	12 - 5065	212	1588100	08 - 8550	111	54063	09 - 487	133
07210900	12 - 7475	215	20355500	31 - 1781	1077	54073	09 - 484	133
07211100	12 - 7477	215	22013	05 - 7018	93	54080	09 - 8869	130
07211200	12 - 7440	214	2201300	05 - 7018	93	54120	09 - 484	133
07211400	12 - 8425	221	22107	41 - 5567	1223	54123	09 - 442	134
07211500	12 - 5100	212	2459900	41 - 5568	1228	55030	09 - 8796	147
07211600	12 - 7514	215	27285	15 - 3323	328	5503000	09 - 8796	147
07211700	12 - 7473	215	2728551	15 - 3323	328	55035	09 - 8446	147
07211800	12 - 7490	215	27287	15 - 2137	328	55039	09 - 8445	146
07211900	12 - 7474	215	2728759	15 - 2137	328	55213	09 - 8783	145

O.E.M. REPLACEMENT CROSS REFERENCE



CROSS REFERENCE 2014

OEM #	Our #	Page #	OEM #	Our #	Page #	OEM #	Our #	Page #
ARIENS			ARIENS			ARIENS		
55216	09 - 8783	145	72075	12 - 7498	215	72130	12 - 7482	215
59201000	10 - 14252	191	72076	12 - 7478	215	72130	12 - 8427	221
59202600	10 - 14230	191	72077	12 - 7494	215	72131	12 - 8426	221
69032	03 - 9129	57	72078	12 - 7520	215	72132	12 - 7485	215
69076	03 - 9128	57	72079	12 - 7590	216	72134	12 - 7578	216
69087	03 - 9127	57	72082	12 - 7434	214	72135	12 - 7613	216
71211	08 - 8006	120	72084	12 - 7435	214	72138	12 - 7438	214
71213	08 - 8007	120	72085	12 - 5015	211	72142	12 - 7477	215
71301	08 - 11217	110	72085	12 - 7437	214	72144	12 - 7532	215
7130100	08 - 8197	111	72086	12 - 8431	221	72155	12 - 7508	215
715095	21 - 13998	526	72086	12 - 7483	215	72155	12 - 5098	212
72023	12 - 8762	221	72087	12 - 7593	216	7215500	12 - 5098	212
72024	12 - 5062	212	72088	12 - 5005	211	72157	12 - 7441	214
72024	12 - 7472	215	72089	12 - 7479	215	72180	12 - 8428	221
72026	12 - 5168	213	72091	12 - 7491	215	72200600	26 - 10975	621
72026	12 - 7586	216	72092	12 - 7589	216	72403500	26 - 10976	621
72029	12 - 7594	216	72092	12 - 5172	213	72403600	26 - 10982	621
72029	12 - 5176	213	72093	12 - 7474	215	7525300	20 - 9650	515
72030	12 - 7496	215	72093	12 - 5064	212	79209100	21 - 12512	525
72031	12 - 7433	214	72094	12 - 7432	214	88281	31 - 9659	1066
72038	12 - 5086	212	72095	12 - 7489	215	9225400	10 - 11071	164
72040	12 - 7444	214	72096	12 - 7493	215			
72042	12 - 5016	211	72097	12 - 7431	214	AS MOTOR		
72043	12 - 5015	211	72099	12 - 7436	214	10004145	15 - 50127	328
72043	12 - 7437	214	72099	12 - 5014	211			
72044	12 - 7594	216	72101	12 - 7501	215	ASTRON		
72045	12 - 7581	216	72102	12 - 7518	215	717295	27 - 7909	658
72047	12 - 8432	221	72103	12 - 7533	215			
72048	12 - 5011	211	72105	12 - 7480	215	AUTOLITE		
72048	12 - 7433	214	72106	12 - 7442	214	106	24 - 7222	589
72049	12 - 5174	213	72106	12 - 5020	211	106	24 - 6935	592
72049	12 - 7592	216	72108	12 - 8428	221	106	24 - 9493	592
72050	12 - 5171	213	72108	12 - 7480	215	15	24 - 5857	596
72050	12 - 7590	216	72109	12 - 5065	212	16	24 - 5857	596
72052	12 - 5196	213	72109	12 - 7475	215	215	24 - 6932	591
72053	12 - 7593	216	72110	12 - 7513	215	216	24 - 9539	592
72055	12 - 7444	214	72111	12 - 7477	215	216	24 - 6932	591
72056	12 - 7475	215	72112	12 - 7440	214	216	24 - 2542	589
72056	12 - 5065	212	72113	12 - 5098	212	217	24 - 6932	591
72059	12 - 7589	216	72114	12 - 8425	221	245	24 - 2537	595
72060	12 - 7471	215	72115	12 - 5100	212	245	24 - 12554	598
72061	12 - 7480	215	72116	12 - 7514	215	25	24 - 5857	596
72065	12 - 5019	211	72117	12 - 7473	215	254	24 - 2510	591
72066	12 - 8430	221	72118	12 - 7490	215	254	24 - 12549	598
72066	12 - 7449	214	72119	12 - 7474	215	255	24 - 2504	591
72066	12 - 5017	211	72119	12 - 5064	212	255	24 - 12542	598
72067	12 - 7480	215	72121	12 - 7477	215	255	24 - 2551	590
72069	12 - 7586	216	72122	12 - 7515	215	255	24 - 2543	589
72070	12 - 7591	216	72123	12 - 7495	215	255	24 - 2529	593
72071	12 - 7481	215	72124	12 - 5098	212	2554	24 - 8496	591
72072	12 - 7480	215	72124	12 - 7508	215	2554	24 - 6835	589
72073	12 - 7433	214	72125	12 - 5054	212	255DP	24 - 9734	590
72074	12 - 13284	221	72128	12 - 7506	215	258	24 - 2532	593



O.E.M. REPLACEMENT CROSS REFERENCE

2014 CROSS REFERENCE

OEM #	Our #	Page #	OEM #	Our #	Page #	OEM #	Our #	Page #
AUTOLITE			AUTOLITE			AUTOLITE		
258	24 - 5859	589	3926	24 - 12431	594	64	24 - 2534	595
258	24 - 2507	591	3926	24 - 10021	590	64	24 - 12543	598
258DP	24 - 9735	590	403	24 - 8963	589	725	24 - 5857	596
26	24 - 8073	592	403	24 - 8497	592	726	24 - 5857	596
26	24 - 5857	596	4062	24 - 2554	596	86	24 - 8054	592
26	24 - 7021	596	4063	24 - 7232	590	AC 285F	24 - 5856	594
26	24 - 7019	589	4063	24 - 2553	596	XST255DP	24 - 13018	593
2695	24 - 2535	594	4092	24 - 2552	594	XST2974DP	24 - 13020	593
27	24 - 5857	596	4092	24 - 7186	591	XST2976DP	24 - 13021	593
275	24 - 7231	589	4092	24 - 7187	591	XST3924DP	24 - 13022	593
275	24 - 9535	592	4093	24 - 2550	590	AYP/ROPER/SEARS		
2794	24 - 12545	598	415	24 - 2536	594	101273M	18 - 891	438
2796	24 - 12546	598	415	24 - 5855	594	101342N	12 - 7536	215
295	24 - 12548	598	4164	24 - 14492	591	101477X	10 - 1171	201
295	24 - 2531	593	417	24 - 5855	594	102403X	13 - 9377	269
295	24 - 2506	591	425	24 - 5855	594	103670X	07 - 282	101
295	24 - 5860	589	425	24 - 7150	591	1044-R	17 - 423	434
2954	24 - 2512	591	425	24 - 2536	594	104445X	31 - 9660	1066
2956	24 - 2509	591	425	24 - 7153	589	104679X	13 - 2176	263
2956	24 - 2547	589	4253	24 - 7149	591	104679X	13 - 723	36
2956DP	24 - 9739	590	4263	24 - 7230	590	105313X	13 - 7157	264
295DP	24 - 9736	590	4263	24 - 12550	598	105380X	12 - 7531	215
2974	24 - 5850	595	4263	24 - 7188	592	105455X	07 - 6915	105
2974	24 - 12552	598	4263	24 - 2539	595	106085X	12 - 6901	222
2974	24 - 2533	595	4264	24 - 12553	598	106085X	12 - 7522	215
2974	24 - 2513	591	4265	24 - 12555	598	106316X	10 - 11858	167
2974	24 - 7191	589	4265	24 - 7311	590	106381X	12 - 7535	215
2974	24 - 8883	591	4265	24 - 9873	595	106381X	12 - 5125	212
2974	24 - 8882	591	456	24 - 2555	590	106412X	12 - 7512	215
2976	24 - 9993	593	456	24 - 2544	589	106412X	12 - 8512	222
2976	24 - 7148	591	456	24 - 1294	594	107644X	07 - 282	101
2976	24 - 2548	590	456	24 - 2505	591	109550X	10 - 11858	167
2984	24 - 8883	591	456	24 - 2530	593	109553X	31 - 9659	1066
2985	24 - 7190	591	456DP	24 - 9737	590	109729X	07 - 6909	107
306	24 - 7224	589	458	24 - 5936	591	109748	31 - 9369	1064
3076	24 - 8964	590	458	24 - 6595	589	109851X	10 - 9489	174
308	24 - 8571	592	458	24 - 9536	593	109869X	31 - 9658	1066
308	24 - 7225	589	458	24 - 6877	593	109946	31 - 10772	1071
308	24 - 6934	592	458	24 - 12544	598	110448X	10 - 9718	158
375	24 - 5856	594	458DP	24 - 9738	590	110485X	09 - 8507	132
376	24 - 5856	594	46F	24 - 5855	594	110883X	12 - 7542	215
377	24 - 5856	594	515	24 - 5858	595	110883X	12 - 8465	222
378	24 - 5856	594	516	24 - 5858	595	110884X	12 - 9945	222
386	24 - 7422	591	517	24 - 5858	595	110884X	12 - 7536	215
386	24 - 7227	589	54	24 - 2534	595	110940X	33 - 10408	1097
386	24 - 7185	591	5503	24 - 14636	592	110975X	12 - 7494	215
3924	24 - 7229	590	5503	24 - 12551	598	12000029	02 - 9372	53
3924	24 - 9871	596	585F	24 - 5856	594	120262X	15 - 6120	330
3924	24 - 8554	594	63	24 - 12547	598	120301X	12 - 7536	215
3924	24 - 9730	592	64	24 - 2538	595	120418X	12 - 7523	215
3924	24 - 6933	593	64	24 - 7220	589	121263X	15 - 6105	331
3924	24 - 7423	592	64	24 - 7868	591	121305X	31 - 9664	1066
3926	24 - 8495	592	64	24 - 7189	592			

O.E.M. REPLACEMENT CROSS REFERENCE



CROSS REFERENCE 2014

OEM #	Our #	Page #	OEM #	Our #	Page #	OEM #	Our #	Page #
AYP/ROPER/SEARS			AYP/ROPER/SEARS			AYP/ROPER/SEARS		
121361	13 - 10396	269	137140	10 - 9910	164	145106	15 - 1043	331
121657X	10 - 8649	200	137152	10 - 9521	184	145106	15 - 6037	331
121676X	10 - 6813	201	137153	12 - 9367	222	145755	05 - 14623	68
121687X	10 - 6813	201	137266	10 - 8901	184	146154	31 - 8943	1071
121705X	10 - 8647	201	137380	15 - 6264	330	146154	31 - 10772	1071
121798X	15 - 6195	330	137380	15 - 6196	330	146248	07 - 282	101
121922X	09 - 9745	145	137553	10 - 9520	184	146248	07 - 282	101
123796X	12 - 9768	223	137641	10 - 8479	184	146283	31 - 9656	1064
124035X	10 - 13225	181	137644	10 - 11142	179	146323	05 - 14623	68
124293X	12 - 6900	222	137645	10 - 8479	184	146527	12 - 9848	223
124648X	10 - 12309	164	137646	10 - 8549	184	146763	13 - 12620	270
125907X	12 - 6902	222	138255	12 - 9764	222	148434	07 - 283	101
125908X	12 - 7536	215	138255	12 - 8784	222	148436	07 - 283	101
126338X	15 - 6120	330	138399	12 - 7502	215	148763	12 - 9698	223
126520X	12 - 8516	223	138496	15 - 6123	330	150283	10 - 12309	164
126847X	09 - 7279	143	138497	15 - 6218	331	150340	07 - 10758	103
126907X	12 - 6902	222	138497	15 - 6124	331	152443	15 - 6437	329
127842	15 - 6124	331	138498	15 - 6125	332	152443	15 - 9170	329
128285	10 - 8479	184	138776	02 - 9374	53	153531	13 - 9121	270
128774	10 - 8548	184	138971	15 - 6125	332	153532	13 - 9148	271
129206	13 - 9148	271	138971X431	15 - 6125	332	153535	13 - 7180	271
129861	13 - 7180	271	139123	13 - 10396	269	153664	31 - 9665	1066
129895	09 - 7917	132	139245	13 - 9849	269	154959	31 - 9656	1064
129895	09 - 442	134	139573	12 - 9368	223	155066	09 - 9747	137
129963	10 - 11474	177	139729	10 - 8901	184	1553H	09 - 813	133
130652	15 - 6263	329	139774	15 - 6190	331	1554H	09 - 813	133
130652	15 - 6205	329	139775	15 - 12563	332	156577	05 - 13350	68
130794	10 - 8479	184	140067	12 - 8464	223	156581	05 - 13350	68
130794	10 - 12723	184	140101	15 - 10841	330	156971	12 - 10008	223
130801	12 - 8784	222	140186	13 - 12271	271	157033	15 - 9970	321
130801	12 - 9764	222	140218	12 - 8781	223	157101	15 - 6236	333
130861	03 - 9566	68	140294	12 - 9336	223	157722	02 - 9374	53
130969	12 - 8511	222	140301	31 - 9623	1060	157769	12 - 10306	223
131006	12 - 8462	222	140401	31 - 11219	1069	157769	12 - 9848	223
131264	12 - 8463	222	140402	31 - 11219	1069	158818	12 - 9312	223
131290	12 - 7184	222	140403	31 - 11219	1069	158913	31 - 9158	1059
131322	15 - 6218	331	140404	31 - 9656	1064	159267	15 - 9810	332
131340	10 - 8830	181	140405	31 - 9777	1064	159705	15 - 6495	329
131494	13 - 9376	269	140527	20 - 8935	514	159705	15 - 9970	321
131959	10 - 863	160	140923	10 - 12309	164	160395	10 - 13225	181
132672	12 - 7496	215	141114	15 - 6236	333	160784	31 - 9663	1066
132672	12 - 5086	212	141416	12 - 9337	223	160855	12 - 9764	222
132801	12 - 9765	222	141523	20 - 8935	514	160855	12 - 8784	222
133035	12 - 7484	215	142600	10 - 9910	164	160889	10 - 9911	164
133049	05 - 13548	68	143651	10 - 9519	184	161343	31 - 9665	1066
133172	10 - 8479	184	143969	15 - 6120	330	161588	12 - 7526	215
133957	07 - 6916	106	143978	15 - 6105	331	161588	12 - 5116	212
134148	15 - 6190	331	144200	12 - 7531	215	161597	12 - 10078	223
134149	15 - 6262	332	144200	12 - 8516	223	161741	12 - 9767	223
134149	15 - 6189	332	144917	13 - 12428	271	1629J	12 - 7526	215
136376	10 - 863	160	144959	12 - 9697	223	163088	31 - 9654	1063
136819	10 - 8648	200	145028	10 - 9912	164	163817	12 - 9768	223
137078	12 - 10306	223	145106	15 - 6235	332	163819	15 - 6437	329



O.E.M. REPLACEMENT CROSS REFERENCE

2014 CROSS REFERENCE

OEM #	Our #	Page #	OEM #	Our #	Page #	OEM #	Our #	Page #
AYP/ROPER/SEARS			AYP/ROPER/SEARS			AYP/ROPER/SEARS		
163819	15 - 9170	329	174873	07 - 6916	106	187256	15 - 12121	323
163968	31 - 7015	1060	174883	12 - 10232	224	187256	15 - 11180	331
163968	31 - 12685	1060	17490612	02 - 9373	53	187281	10 - 11591	185
165482	10 - 9575	184	174978	12 - 9964	224	187283	12 - 11034	224
165484	17 - 9586	435	175064	15 - 9810	332	187291	10 - 11592	185
165555	12 - 10005	224	175065	15 - 12732	332	187292	10 - 12734	185
165555	12 - 870	224	175065	15 - 9810	332	187292	10 - 11592	185
165560	15 - 50252	330	175067	05 - 10891	70	187292	10 - 11590	185
165561	15 - 50253	330	175436	12 - 12480	224	187494	41 - 13397	1221
165579	10 - 9574	184	175442	31 - 7015	1060	187690	10 - 11474	177
165626	13 - 13622	270	175442	31 - 12685	1060	187925	09 - 5618	134
165632	12 - 7555	215	175450	15 - 6484	332	188243	41 - 13397	1221
165833	15 - 9810	332	175451	15 - 6485	332	188606	07 - 14035	103
165833	15 - 12732	332	175566	31 - 12685	1060	189028	15 - 9810	332
166042	13 - 10128	36	175566	31 - 7015	1060	189028	15 - 12732	332
166043	13 - 9846	269	175820	13 - 11633	269	189993	13 - 11635	270
168552	05 - 13350	68	176084	15 - 6495	329	191273	12 - 11034	224
168720	15 - 6484	332	176138	31 - 9665	1066	191890X428	15 - 12732	332
168721	15 - 6485	332	177501	33 - 10408	1097	191890X428	15 - 9810	332
169178	12 - 12423	225	177637	07 - 9156	102	192090	41 - 13397	1221
169416	31 - 9656	1064	177865	13 - 7180	271	192507	31 - 5933	1071
169417	31 - 9656	1064	177968	13 - 11634	270	192507	31 - 14222	1072
169642	33 - 10408	1097	178138	12 - 12892	224	192870	10 - 11590	185
169676	05 - 10891	70	178342	10 - 8901	184	192872	10 - 11592	185
17000612	02 - 9373	53	178744	31 - 9654	1063	193003	17 - 12280	435
170037	15 - 50252	330	178777X431	41 - 5590	1229	193003	17 - 14457	435
170038	15 - 50253	330	178777X479	41 - 5590	1229	193144	07 - 10758	103
17060612	02 - 9373	53	179050	13 - 12385	271	193195	13 - 11635	270
170698	15 - 6495	329	179114	13 - 12644	270	193197	13 - 11634	270
173434	13 - 9121	270	179828	41 - 13397	1221	193214	12 - 11861	224
173435	13 - 9148	271	179831	05 - 5620	92	193235	05 - 13380	70
173436	13 - 7180	271	180054	15 - 9907	330	193350	31 - 12327	1059
173437	13 - 11632	269	180213	12 - 11129	224	193406	10 - 11142	179
173438	13 - 9376	269	180214	12 - 11130	224	193707	17 - 12728	428
173901	13 - 12661	270	180217	12 - 10005	224	193825	17 - 8753	428
173920	15 - 9907	330	180217	12 - 870	224	193957	15 - 12240	331
173921	15 - 12475	322	180583	15 - 6484	332	194326	13 - 13178	269
173921	15 - 10377	329	180584	15 - 6485	332	194327	13 - 13179	269
173984	02 - 9374	53	180808	12 - 10077	224	194346	12 - 11862	224
174284	09 - 9747	137	181654	23 - 6783	586	194387X460	07 - 13495	103
174356	10 - 11014	185	182158	03 - 9679	57	194406X428	15 - 9810	332
174358	10 - 12307	185	182419	10 - 11142	179	194406X428	15 - 12732	332
174360	10 - 12308	185	183533	12 - 14117	225	194653	05 - 14204	68
174365	17 - 12280	435	183724	10 - 863	160	195945	13 - 12378	271
174367	10 - 12980	164	184219	10 - 11142	179	196103	12 - 11863	224
174368	12 - 10076	224	184588	05 - 14623	68	196106	13 - 13175	269
174369	12 - 10077	224	184590	17 - 12728	428	197242	12 - 11864	224
174375	13 - 12513	270	184596	05 - 14623	68	197253	12 - 11867	224
174509	10 - 12309	164	187254	15 - 12121	323	197473	13 - 12378	271
174651	31 - 9656	1064	187254	15 - 11180	331	197725	20 - 8935	514
174653	31 - 9656	1064	187254	15 - 13239	331	198145	13 - 12456	270
174762	41 - 5589	1229	187255	15 - 12121	323	198636	41 - 13397	1221
174762X431	41 - 5589	1229	187256	15 - 14459	331	199532	13 - 12385	271

O.E.M. REPLACEMENT CROSS REFERENCE



CROSS REFERENCE 2014

OEM #	Our #	Page #	OEM #	Our #	Page #	OEM #	Our #	Page #
AYP/ROPER/SEARS			AYP/ROPER/SEARS			AYP/ROPER/SEARS		
199534	13 - 12385	271	4460J	29 - 8611	667	700615	05 - 14623	68
199612	12 - 12052	224	4798J	12 - 7521	215	700953	07 - 10758	103
25034	15 - 2162	329	4898H	10 - 314	39	701211	15 - 6037	331
25036	15 - 3392	331	4933H	13 - 719	36	7080J	12 - 7504	215
25723	12 - 7521	215	4933H	13 - 720	36	73040900	10 - 8901	184
25724	12 - 7537	215	53018	13 - 728	36	73050900	10 - 8901	184
25726	12 - 7504	215	532-441597	12 - 14359	228	75443	12 - 7439	214
2614J	12 - 7449	214	532128285	10 - 8479	184	75673	13 - 718	36
2921J	12 - 7490	215	532130794	10 - 8479	184	76557	13 - 718	36
314175	12 - 8432	221	532133172	10 - 8479	184	76672	12 - 7480	215
3754H	12 - 7438	214	532137152	10 - 9521	184	81229	12 - 7441	214
3754H1	12 - 7438	214	532137266	10 - 8901	184	8225R	12 - 7480	215
400234	10 - 8901	184	532137553	10 - 9520	184	83691	12 - 7440	214
401545	31 - 12091	1067	532137645	10 - 8479	184	8377J	12 - 7502	215
401603	12 - 12398	225	532139729	10 - 8901	184	850972	15 - 6037	331
402008	12 - 870	224	532165482	10 - 9575	184	850973	15 - 6038	332
402008	12 - 10005	224	532165579	10 - 9574	184	850977	17 - 8752	428
402009	12 - 12423	225	532165579-01	10 - 9574	184	851462	03 - 9679	57
403107	15 - 12721	333	532169676	05 - 10891	70	851514	17 - 8753	428
403107	15 - 12974	333	532174762	41 - 5589	1229	851801	07 - 9156	102
405143	12 - 12286	225	532175067	05 - 10891	70	87025	05 - 13548	68
405380	15 - 12242	333	532178777	41 - 5590	1229	9040H	09 - 13359	146
406712	15 - 12732	332	532187281	10 - 11591	185	9040H	09 - 7258	146
406712	15 - 9810	332	532187290	10 - 11590	185	9040H	09 - 339	146
406712	15 - 9810	332	532187291	10 - 11592	185	9121R	12 - 7557	215
406712X431	15 - 9810	332	532192870	10 - 11590	185	9178	13 - 718	36
406713	15 - 6236	333	532405143	12 - 12286	225	9179R	12 - 7444	214
406713X431	15 - 6236	333	532420097	17 - 12728	428	9180R	12 - 7484	215
406713X431	15 - 1044	333	5324279-84	15 - 13498	368	9180R	12 - 9769	222
40671X431	15 - 6038	332	5324279-85	15 - 13500	368	STD365402	31 - 2922	1062
408007	12 - 14116	225	532429636	12 - 13251	225	TH3H340	12 - 7439	214
408010	12 - 14117	225	53688547	41 - 5531	1223	TH3H390	12 - 7444	214
408019	12 - 14512	225	539-107521	13 - 12513	270	TH3H440	12 - 7449	214
418373	17 - 12728	428	539-112057	10 - 11590	185	TH4H370	12 - 7480	215
419271	12 - 8516	223	56400	15 - 1043	331	TH4H390	12 - 7482	215
419274	15 - 12957	333	56401	15 - 1044	333	TH4H690	12 - 8512	222
420097	17 - 12728	428	58558	12 - 7492	215	TH4H690	12 - 7512	215
420463	15 - 13023	333	5928J	12 - 7531	215	TH4H830	12 - 9367	222
421825	15 - 13023	333	62828	12 - 7513	215			
425162	20 - 8935	514	62828	12 - 8510	222	BAD BOY		
426322	15 - 50253	330	63087A	19 - 14188	479	022-5234-98	07 - 6917	103
426323	15 - 50252	330	63688	10 - 863	160	033-5001-00	13 - 12722	271
427984	15 - 13498	368	6474H	12 - 7626	216	037-6015-00	10 - 13089	186
427985	15 - 13500	368	65139	08 - 368	117	037-6015-50	10 - 13089	186
428287	23 - 6783	586	6554J	29 - 8610	667	037-6016-00	10 - 13090	186
428454	12 - 14513	225	6555J	29 - 8611	667	037-6023-00	09 - 50191	130
429636	12 - 13251	225	67346	12 - 7482	215	038-0003-00	15 - 6294	323
430220	20 - 8935	514	67486	05 - 422	88	038-0005-00	15 - 2173	334
431880X460	07 - 13495	103	6941R	12 - 7648	216	038-2007-00	15 - 10667	334
437601	15 - 13023	333	6942R	12 - 7530	215	038-3000-00	15 - 2173	334
440620	05 - 5620	92	6943R	12 - 7535	215	038-3000-00	15 - 2172	334
441597	12 - 14359	228	6944R	12 - 7616	216	038-4820-00	15 - 2172	334
4459J	29 - 8610	667	700417	03 - 9680	57	038-5220-00	15 - 6178	350



O.E.M. REPLACEMENT CROSS REFERENCE

2014 CROSS REFERENCE

OEM #	Our #	Page #	OEM #	Our #	Page #	OEM #	Our #	Page #
BAD BOY			BEARING			BELT (INDUSTRY NUMBER)		
038-5350-00	15 - 6300	322	SC0228LU	09 - 481	131	3L440	12 - 5027	211
038-5350-00	15 - 3403	347	SC0265LUC3	09 - 3228	131	3L440	12 - 7449	214
038-5350-0050	15 - 6300	322	SC0288LU	09 - 8199	131	3L450	12 - 5028	211
038-6050-00	15 - 10667	334	SC0493LU	09 - 487	133	3L450	12 - 7450	214
038-6060-00	15 - 10667	334	BELT (INDUSTRY NUMBER)			3L460	12 - 5029	211
038-7202-00	15 - 6833	334	3L170	12 - 5000	211	3L460	12 - 7451	214
038-7220-00	15 - 6026	334	3L180	12 - 5001	211	3L470	12 - 5030	211
038300000	15 - 1010	336	3L190	12 - 5002	211	3L480	12 - 7453	214
038300000	15 - 2173	334	3L200	12 - 5003	211	3L480	12 - 5031	211
038300000	15 - 3404	347	3L210	12 - 5004	211	4L1000	12 - 5133	212
038482000	15 - 1009	336	3L220	12 - 5005	211	4L1000	12 - 7543	215
038605000	15 - 6303	324	3L230	12 - 5006	211	4L1010	12 - 6629	212
038720200	15 - 6404	334	3L240	12 - 5007	211	4L1010	12 - 7544	215
041520000	12 - 7659	216	3L240	12 - 7429	214	4L1020	12 - 7545	215
042-9000-00	31 - 11219	1069	3L250	12 - 5008	211	4L1020	12 - 6630	212
056-8058-00	31 - 9656	1064	3L250	12 - 7430	214	4L1030	12 - 6631	212
063-2004-00	19 - 12861	450	3L260	12 - 5009	211	4L1030	12 - 7546	215
063-2004-00	19 - 6929	483	3L260	12 - 7431	214	4L1040	12 - 7547	215
063-8014-00	19 - 8631	484	3L270	12 - 5010	211	4L1040	12 - 6632	212
070-5035-00	10 - 11237	167	3L270	12 - 7432	214	4L1050	12 - 6633	212
5208425	15 - 3434	362	3L280	12 - 7432	214	4L1050	12 - 7548	215
BEARING			3L280	12 - 7433	214	4L1060	12 - 6634	212
44F40P	09 - 7950	131	3L280	12 - 5011	211	4L1060	12 - 7549	215
6002-2RS	09 - 8525	131	3L290	12 - 7434	214	4L1070	12 - 7550	215
6003	09 - 50180	130	3L290	12 - 5012	211	4L1070	12 - 6635	212
6004	09 - 50181	130	3L300	12 - 7435	214	4L1080	12 - 7551	215
6006	09 - 50183	130	3L300	12 - 5013	211	4L1080	12 - 6636	212
608	09 - 50185	130	3L310	12 - 7436	214	4L1090	12 - 6637	212
6200	09 - 50187	130	3L310	12 - 5014	211	4L1090	12 - 7552	215
6201	09 - 50188	130	3L320	12 - 5015	211	4L1100	12 - 7553	215
6202	09 - 50189	130	3L320	12 - 7437	214	4L1100	12 - 6638	212
6202	09 - 7312	131	3L330	12 - 5016	211	4L1110	12 - 7554	215
6203-2RS	09 - 483	132	3L330	12 - 7438	214	4L1110	12 - 6639	212
6203-RS	09 - 7917	132	3L340	12 - 5017	211	4L1120	12 - 6640	212
6203-ZRS	09 - 6535	133	3L340	12 - 7439	214	4L1120	12 - 7555	215
6203LU	09 - 7210	132	3L350	12 - 5018	211	4L1130	12 - 6641	212
6203LU	09 - 8507	132	3L350	12 - 7440	214	4L1130	12 - 7556	215
6203Z	09 - 6513	133	3L360	12 - 5019	211	4L1140	12 - 7557	215
6204DU	09 - 442	134	3L360	12 - 7441	214	4L1140	12 - 6642	212
6204Z	09 - 7166	134	3L370	12 - 7442	214	4L170	12 - 5050	212
6205	09 - 50190	130	3L370	12 - 5020	211	4L180	12 - 5051	212
6205-RS1	09 - 7162	134	3L380	12 - 5021	211	4L190	12 - 5052	212
6206	09 - 50191	130	3L380	12 - 7443	214	4L200	12 - 5053	212
6305LC	09 - 7178	134	3L390	12 - 7444	214	4L210	12 - 5054	212
9R8	09 - 6625	130	3L390	12 - 5022	211	4L220	12 - 5055	212
L44610	09 - 814	134	3L400	12 - 7445	214	4L230	12 - 5056	212
L44643	09 - 814	134	3L400	12 - 5023	211	4L230	12 - 7466	215
LM11910	09 - 813	133	3L410	12 - 5024	211	4L240	12 - 5057	212
LM11949	09 - 813	133	3L410	12 - 7446	214	4L240	12 - 7467	215
NTN6203LU	09 - 8437	132	3L420	12 - 7447	214	4L250	12 - 5058	212
RA100RR	09 - 8488	135	3L420	12 - 5025	211	4L250	12 - 7468	215
SB205-12	09 - 3274	134	3L430	12 - 7448	214	4L260	12 - 5059	212
			3L430	12 - 5026	211	4L260	12 - 7469	215

O.E.M. REPLACEMENT CROSS REFERENCE



CROSS REFERENCE 2014

OEM #	Our #	Page #	OEM #	Our #	Page #	OEM #	Our #	Page #
BELT (INDUSTRY NUMBER)			BELT (INDUSTRY NUMBER)			BELT (INDUSTRY NUMBER)		
4L270	12 - 5060	212	4L530	12 - 7496	215	4L790	12 - 7522	215
4L270	12 - 7470	215	4L530	12 - 5086	212	4L800	12 - 5113	212
4L280	12 - 7471	215	4L540	12 - 7497	215	4L800	12 - 7523	215
4L280	12 - 5061	212	4L540	12 - 5087	212	4L810	12 - 5114	212
4L290	12 - 7472	215	4L550	12 - 7498	215	4L810	12 - 7524	215
4L290	12 - 5062	212	4L550	12 - 5088	212	4L820	12 - 7525	215
4L300	12 - 5063	212	4L560	12 - 7499	215	4L820	12 - 5115	212
4L300	12 - 7473	215	4L560	12 - 5089	212	4L830	12 - 7526	215
4L310	12 - 7474	215	4L570	12 - 5090	212	4L830	12 - 5116	212
4L310	12 - 5064	212	4L570	12 - 7500	215	4L840	12 - 7527	215
4L320	12 - 7475	215	4L580	12 - 7501	215	4L840	12 - 5117	212
4L320	12 - 5065	212	4L580	12 - 5091	212	4L850	12 - 7528	215
4L330	12 - 7476	215	4L590	12 - 7502	215	4L850	12 - 5118	212
4L330	12 - 5066	212	4L590	12 - 5092	212	4L860	12 - 5119	212
4L340	12 - 7477	215	4L600	12 - 7503	215	4L860	12 - 7529	215
4L340	12 - 5067	212	4L600	12 - 5093	212	4L870	12 - 7530	215
4L350	12 - 7478	215	4L610	12 - 5094	212	4L870	12 - 5120	212
4L350	12 - 5068	212	4L610	12 - 7504	215	4L880	12 - 7531	215
4L360	12 - 5069	212	4L620	12 - 7505	215	4L880	12 - 5121	212
4L360	12 - 7479	215	4L620	12 - 5095	212	4L890	12 - 5122	212
4L370	12 - 5070	212	4L630	12 - 7506	215	4L890	12 - 7532	215
4L370	12 - 7480	215	4L630	12 - 5096	212	4L900	12 - 5123	212
4L380	12 - 7481	215	4L640	12 - 5097	212	4L900	12 - 7533	215
4L380	12 - 5071	212	4L640	12 - 7507	215	4L910	12 - 5124	212
4L390	12 - 7482	215	4L650	12 - 5098	212	4L910	12 - 7534	215
4L390	12 - 5072	212	4L650	12 - 7508	215	4L920	12 - 5125	212
4L400	12 - 7483	215	4L660	12 - 7509	215	4L920	12 - 7535	215
4L400	12 - 5073	212	4L660	12 - 5099	212	4L930	12 - 7536	215
4L410	12 - 5074	212	4L670	12 - 5100	212	4L930	12 - 5126	212
4L410	12 - 7484	215	4L670	12 - 7510	215	4L940	12 - 5127	212
4L420	12 - 5075	212	4L680	12 - 7511	215	4L940	12 - 7537	215
4L420	12 - 7485	215	4L680	12 - 5101	212	4L950	12 - 7538	215
4L430	12 - 5076	212	4L690	12 - 5102	212	4L950	12 - 5128	212
4L430	12 - 7486	215	4L690	12 - 7512	215	4L960	12 - 5129	212
4L440	12 - 5077	212	4L700	12 - 5103	212	4L960	12 - 7539	215
4L440	12 - 7487	215	4L700	12 - 7513	215	4L970	12 - 7540	215
4L450	12 - 5078	212	4L710	12 - 5104	212	4L970	12 - 5130	212
4L450	12 - 7488	215	4L710	12 - 7514	215	4L980	12 - 5131	212
4L460	12 - 5079	212	4L720	12 - 7515	215	4L980	12 - 7541	215
4L460	12 - 7489	215	4L720	12 - 5105	212	4L990	12 - 5132	212
4L470	12 - 7490	215	4L730	12 - 5106	212	4L990	12 - 7542	215
4L470	12 - 7452	214	4L730	12 - 7516	215	5L1000	12 - 5227	213
4L470	12 - 5080	212	4L740	12 - 7517	215	5L1000	12 - 7645	216
4L480	12 - 5081	212	4L740	12 - 5107	212	5L1010	12 - 7646	216
4L480	12 - 7491	215	4L750	12 - 5108	212	5L1010	12 - 6643	213
4L490	12 - 5082	212	4L750	12 - 7518	215	5L1020	12 - 6644	213
4L490	12 - 7492	215	4L760	12 - 5109	212	5L1020	12 - 7647	216
4L500	12 - 7493	215	4L760	12 - 7519	215	5L1030	12 - 7648	216
4L500	12 - 5083	212	4L770	12 - 5110	212	5L1030	12 - 6645	213
4L510	12 - 5084	212	4L770	12 - 7520	215	5L1040	12 - 7649	216
4L510	12 - 7494	215	4L780	12 - 5111	212	5L1040	12 - 6646	213
4L520	12 - 7495	215	4L780	12 - 7521	215	5L1050	12 - 6647	213
4L520	12 - 5085	212	4L790	12 - 5112	212	5L1050	12 - 7650	216



O.E.M. REPLACEMENT CROSS REFERENCE

2014 CROSS REFERENCE

OEM #	Our #	Page #	OEM #	Our #	Page #	OEM #	Our #	Page #
BELT (INDUSTRY NUMBER)			BELT (INDUSTRY NUMBER)			BELT (INDUSTRY NUMBER)		
5L1060	12 - 7651	216	5L410	12 - 5168	213	5L680	12 - 7613	216
5L1060	12 - 6648	213	5L420	12 - 5169	213	5L680	12 - 5195	213
5L1070	12 - 6649	213	5L420	12 - 7587	216	5L690	12 - 7614	216
5L1070	12 - 7652	216	5L430	12 - 7588	216	5L690	12 - 5196	213
5L1080	12 - 6650	213	5L430	12 - 5170	213	5L700	12 - 5197	213
5L1080	12 - 7653	216	5L440	12 - 7589	216	5L700	12 - 7615	216
5L1090	12 - 7654	216	5L440	12 - 5171	213	5L710	12 - 7616	216
5L1090	12 - 6651	213	5L450	12 - 5172	213	5L710	12 - 5198	213
5L1100	12 - 7655	216	5L450	12 - 7590	216	5L720	12 - 7617	216
5L1100	12 - 6652	213	5L460	12 - 7591	216	5L720	12 - 5199	213
5L1110	12 - 7656	216	5L460	12 - 5173	213	5L730	12 - 7618	216
5L1110	12 - 6653	213	5L470	12 - 5174	213	5L730	12 - 5200	213
5L1120	12 - 6654	213	5L470	12 - 7592	216	5L740	12 - 5201	213
5L1120	12 - 7657	216	5L480	12 - 7593	216	5L740	12 - 7619	216
5L1130	12 - 6655	213	5L480	12 - 5175	213	5L750	12 - 7620	216
5L1130	12 - 7658	216	5L490	12 - 5176	213	5L750	12 - 5202	213
5L1140	12 - 7659	216	5L490	12 - 7594	216	5L760	12 - 5203	213
5L1140	12 - 6656	213	5L500	12 - 7595	216	5L760	12 - 7621	216
5L230	12 - 5150	213	5L500	12 - 5177	213	5L770	12 - 5204	213
5L240	12 - 5151	213	5L510	12 - 7596	216	5L770	12 - 7622	216
5L250	12 - 5152	213	5L510	12 - 5178	213	5L780	12 - 7623	216
5L250	12 - 7570	216	5L520	12 - 7597	216	5L780	12 - 5205	213
5L260	12 - 5153	213	5L520	12 - 5179	213	5L790	12 - 5206	213
5L260	12 - 7571	216	5L530	12 - 5180	213	5L790	12 - 7624	216
5L270	12 - 5154	213	5L530	12 - 7598	216	5L800	12 - 5207	213
5L270	12 - 7572	216	5L540	12 - 5181	213	5L800	12 - 7625	216
5L280	12 - 5155	213	5L540	12 - 7599	216	5L810	12 - 5208	213
5L280	12 - 7573	216	5L550	12 - 5182	213	5L810	12 - 7626	216
5L290	12 - 7574	216	5L550	12 - 7600	216	5L820	12 - 5209	213
5L290	12 - 5156	213	5L560	12 - 5183	213	5L820	12 - 7627	216
5L300	12 - 7575	216	5L560	12 - 7601	216	5L830	12 - 7628	216
5L300	12 - 5157	213	5L570	12 - 5184	213	5L830	12 - 5210	213
5L310	12 - 5158	213	5L570	12 - 7602	216	5L840	12 - 7629	216
5L310	12 - 7576	216	5L580	12 - 7603	216	5L840	12 - 5211	213
5L320	12 - 7577	216	5L580	12 - 5185	213	5L850	12 - 7630	216
5L320	12 - 5159	213	5L590	12 - 5186	213	5L850	12 - 5212	213
5L330	12 - 7578	216	5L590	12 - 7604	216	5L860	12 - 5213	213
5L330	12 - 5160	213	5L600	12 - 7605	216	5L860	12 - 7631	216
5L340	12 - 7579	216	5L600	12 - 5187	213	5L870	12 - 5214	213
5L340	12 - 5161	213	5L610	12 - 7606	216	5L870	12 - 7632	216
5L350	12 - 5162	213	5L610	12 - 5188	213	5L880	12 - 5215	213
5L350	12 - 7580	216	5L620	12 - 5189	213	5L880	12 - 7633	216
5L360	12 - 7581	216	5L620	12 - 7607	216	5L890	12 - 5216	213
5L360	12 - 5163	213	5L630	12 - 5190	213	5L890	12 - 7634	216
5L370	12 - 7582	216	5L630	12 - 7608	216	5L900	12 - 7635	216
5L370	12 - 5164	213	5L640	12 - 7609	216	5L900	12 - 5217	213
5L380	12 - 7583	216	5L640	12 - 5191	213	5L910	12 - 7636	216
5L380	12 - 5165	213	5L650	12 - 5192	213	5L910	12 - 5218	213
5L390	12 - 7584	216	5L650	12 - 7610	216	5L920	12 - 7637	216
5L390	12 - 5166	213	5L660	12 - 5193	213	5L920	12 - 5219	213
5L400	12 - 5167	213	5L660	12 - 7611	216	5L930	12 - 5220	213
5L400	12 - 7585	216	5L670	12 - 7612	216	5L930	12 - 7638	216
5L410	12 - 7586	216	5L670	12 - 5194	213	5L940	12 - 5221	213

O.E.M. REPLACEMENT CROSS REFERENCE



CROSS REFERENCE 2014

OEM #	Our #	Page #	OEM #	Our #	Page #	OEM #	Our #	Page #
BELT (INDUSTRY NUMBER)			BOBCAT/RANSOM			BOBCAT/RANSOM		
5L940	12 - 7639	216	108208	31 - 9659	1066	32345-02	10 - 6672	163
5L950	12 - 7640	216	112111-01	15 - 2172	334	33004A	05 - 8099	90
5L950	12 - 5222	213	112111-01	15 - 3400	336	33050	09 - 5721	146
5L960	12 - 7641	216	112111-01	15 - 1009	336	33103	05 - 10810	90
5L960	12 - 5223	213	112111-02	15 - 13016	323	35008N	09 - 3217	134
5L970	12 - 5224	213	112111-02	15 - 3401	336	35010A	10 - 2224	172
5L970	12 - 7642	216	112111-02	15 - 2173	334	35062B	09 - 8077	132
5L980	12 - 7643	216	112111-02	15 - 1010	336	36006N	10 - 1226	186
5L980	12 - 5225	213	112111-03	15 - 13017	324	36013A	10 - 2243	156
5L990	12 - 7644	216	112111-03	15 - 3402	337	36068N	10 - 2219	161
5L990	12 - 5226	213	112111-04	15 - 3329	337	36082N	10 - 1227	186
			112243-02	15 - 6183	337	36129	10 - 2218	157
			112243-03	15 - 6272	337	36271	13 - 6997	272
BERNARD			128003	12 - 11853	242	36306	10 - 2243	156
12806	15 - 50125	335	128009	31 - 7675	1064	36411	10 - 6581	156
20062	19 - 50242	458	128010	31 - 9158	1059	36482	10 - 6580	157
364	19 - 50243	458	128079	10 - 9311	173	36526	10 - 6581	156
			128099	12 - 8811	242	36567	10 - 9375	186
BILLY GOAT			138008	05 - 7788	90	38008-1N	42 - 7097	1231
350100	15 - 10968	335	14380	09 - 7262	142	38010-1A	13 - 5714	264
350100	15 - 6324	335	1530	31 - 50238	1072	38010-2A	13 - 2188	263
350147	15 - 10780	335	188019	10 - 11858	167	38010-2A	13 - 12891	281
400295	08 - 14346	110	1985032	31 - 9656	1064	38012N	06 - 3239	98
440279	08 - 14346	110	2188128	12 - 8808	242	38016	12 - 7581	216
521102	42 - 14394	1232	2188134	12 - 11468	243	38016	12 - 5242	242
			2188151	10 - 11444	167	38016N	12 - 7581	216
BLACK & DECKER			2188153	31 - 11470	1065	38016N	12 - 5242	242
82-010	16 - 6764	421	2188179	19 - 7916	483	38017	12 - 5241	242
82-024	16 - 6172	421	2188179	19 - 12862	450	38017N	12 - 5241	242
			2306005	13 - 5714	264	38018N	13 - 2186	267
BLACK ROCK			2306019	10 - 2222	158	38020	10 - 9142	174
119-3501	31 - 9658	1066	2308134	42 - 14182	1233	38022B	13 - 2187	272
119-3502	31 - 9659	1066	2308135	42 - 14184	1231	38025N	09 - 8664	138
119-3505	31 - 9666	1066	2721246	10 - 10757	159	38025N	09 - 9011	138
			2721337	10 - 11237	167	38030N	12 - 5823	242
BLITZ			2721512	07 - 10715	103	38042N	09 - 5848	138
11935	32 - 12823	1109	31005A	10 - 2222	158	38058N	09 - 9041	138
			31006A	10 - 2223	158	38058N	09 - 8664	138
BLUEBIRD			31007A	10 - 2221	158	38069N	09 - 5848	138
0315	09 - 8863	134	31008B	13 - 5991	272	38076	12 - 7632	216
315	09 - 8863	134	31011B	13 - 2185	272	38089N	13 - 2184	272
5001	15 - 6324	335	31012A	13 - 5991	272	38096C	08 - 905	112
5001	15 - 10968	335	32022	15 - 6294	323	38111	12 - 7632	216
5002	10 - 8755	182	32022	15 - 1010	336	38140	13 - 2184	272
5004	10 - 8741	176	32022A	15 - 1010	336	38183	13 - 6608	272
5201	15 - 11645	335	32022A	15 - 2173	334	38184	13 - 7813	264
5201	15 - 8720	335	32061	15 - 6296	322	38184-1	13 - 7813	264
5401	15 - 11644	335	32061	15 - 1009	336	38184-2	13 - 7813	264
5601	15 - 11643	335	32061A	15 - 1009	336	38209	08 - 3277	115
5970	15 - 10780	335	32061A	15 - 2172	334	38212	12 - 6969	242
71910	15 - 12714	335	32061A	15 - 6296	322	38213	09 - 12651	132
			32344	10 - 6670	163	38232	13 - 6607	272
			32345-01	10 - 6671	163	38249	12 - 6836	242



O.E.M. REPLACEMENT CROSS REFERENCE

2014 CROSS REFERENCE

OEM #	Our #	Page #	OEM #	Our #	Page #	OEM #	Our #	Page #
BOBCAT/RANSOM			BOLENS			BOLENS		
38264	08 - 3276	112	110-8454	12 - 5054	212	110-8540	12 - 5158	213
38273	09 - 5812	137	110-8455	12 - 5055	212	110-8540	12 - 7576	216
38274	09 - 5812	137	110-8456	12 - 7466	215	110-8544	12 - 5162	213
38348-01	09 - 8488	135	110-8456	12 - 5056	212	110-8544	12 - 7580	216
38382	31 - 9660	1066	110-8459	12 - 7471	215	110-8547	12 - 5165	213
38383	31 - 9658	1066	110-8459	12 - 5059	212	110-8547	12 - 7583	216
38440	12 - 8803	242	110-8460	12 - 7470	215	110-8552	12 - 7588	216
38442	12 - 8809	242	110-8460	12 - 5060	212	110-8552	12 - 5170	213
38456	13 - 2186	267	110-8461	12 - 5061	212	110-8554	12 - 7590	216
38510	08 - 8098	108	110-8461	12 - 7471	215	110-8562	12 - 7598	216
38510	08 - 3276	112	110-8462	12 - 5062	212	110-8566	12 - 7602	216
38523	12 - 8810	242	110-8463	12 - 5063	212	110-8572	12 - 7608	216
4127203	42 - 14176	1232	110-8463	12 - 7473	215	110-8576	12 - 7612	216
4130099	42 - 14183	1233	110-8464	12 - 5064	212	110-8642	12 - 7472	215
42139B	15 - 3329	337	110-8464	12 - 7474	215	110-9439	12 - 7473	215
42180B	15 - 6299	324	110-8466	12 - 7476	215	110-9539	12 - 7575	216
42180B	15 - 2174	337	110-8466	12 - 5066	212	118-5275	09 - 813	133
43037A	09 - 7839	143	110-8467	12 - 5067	212	118-5434	12 - 7442	214
48045B	19 - 6680	484	110-8467	12 - 7477	215	118-5487	12 - 7437	214
48053-2A	09 - 8240	148	110-8468	12 - 7478	215	118-5828	09 - 484	133
48053-2A	09 - 5707	147	110-8468	12 - 5068	212	150168	12 - 7604	216
483800	08 - 8098	108	110-8469	12 - 7479	215	150169	12 - 7605	216
48426	19 - 8328	474	110-8469	12 - 5069	212	150173	12 - 7601	216
603925	08 - 8098	108	110-8470	12 - 7480	215	150175	12 - 7592	216
603927	08 - 8098	108	110-8470	12 - 5070	212	150175	12 - 5174	213
603971	08 - 8098	108	110-8473	12 - 7483	215	150176	12 - 7602	216
64123-86	10 - 5708	180	110-8473	12 - 5073	212	150180	12 - 5082	212
64140-2	10 - 2910	161	110-8474	12 - 5074	212	150180	12 - 7492	215
64144-12	10 - 5706	176	110-8474	12 - 7484	215	170-0101	12 - 7467	215
64163-07	10 - 6885	175	110-8475	12 - 7485	215	170-2443	12 - 7467	215
64163-12	10 - 1191	175	110-8475	12 - 5075	212	170-2727	12 - 7489	215
64163-14	10 - 2238	175	110-8476	12 - 7486	215	170-3084	12 - 7478	215
64163-22	10 - 6886	175	110-8476	12 - 5076	212	170-3085	12 - 5053	212
64163-71	10 - 2238	175	110-8477	12 - 7487	215	170-4403	12 - 7491	215
64173-01	10 - 2225	162	110-8478	12 - 7488	215	170-4595	12 - 7486	215
64173-02	10 - 2226	162	110-8478	12 - 5078	212	170-5033	12 - 5055	212
64173-05	10 - 2226	162	110-8481	12 - 7491	215	170-5034	12 - 7478	215
64188-21	10 - 2910	161	110-8485	12 - 7495	215	170-5061	12 - 5053	212
65032	12 - 7478	215	110-8485	12 - 5085	212	170-5326	12 - 7480	215
65082	12 - 7480	215	110-8487	12 - 5087	212	170-6238	12 - 7477	215
72039	15 - 1036	337	110-8487	12 - 7497	215	170-6239	12 - 7481	215
72039B	15 - 1036	337	110-8488	12 - 7498	215	170-6383	12 - 7587	216
76096-01	06 - 2998	97	110-8488	12 - 5088	212	170-6462	12 - 7585	216
76096-02	06 - 2999	98	110-8495	12 - 7505	215	170-6799	12 - 7513	215
76167	06 - 2998	97	110-8500	12 - 7510	215	170-6907	12 - 7467	215
76168	06 - 2999	98	110-8501	12 - 7511	215	170-6967	12 - 7467	215
78030N	12 - 7431	214	110-8503	12 - 7511	215	170-7233	12 - 7469	215
78031N	12 - 7441	214	110-8535	12 - 5153	213	170-7640	12 - 5055	212
78113	09 - 8375	131	110-8535	12 - 7571	216	170-8425	12 - 7471	215
			110-8536	12 - 7572	216	170-9698	12 - 7588	216
			110-8536	12 - 5154	213	170-9821	12 - 7588	216
BOLENS			110-8539	12 - 7575	216	171-0457	12 - 7581	216
110-8450	12 - 5050	212	110-8539	12 - 5157	213	171-0555	12 - 7471	215
110-8453	12 - 5053	212						

O.E.M. REPLACEMENT CROSS REFERENCE



CROSS REFERENCE 2014

OEM #	Our #	Page #	OEM #	Our #	Page #	OEM #	Our #	Page #
BOLENS			BOLENS			BOLENS		
171-0556	13 - 719	36	171-7861	12 - 7499	215	172-5407	12 - 7480	215
171-0556	12 - 7493	215	171-9203	12 - 5065	212	172-5469	12 - 7478	215
171-0567	13 - 728	36	171-9731	12 - 5096	212	172-5603	12 - 5076	212
171-0812	12 - 5055	212	171-9731	12 - 7506	215	172-5603	12 - 7486	215
171-0957	12 - 5055	212	171-9783	12 - 7484	215	172-6450	19 - 6680	484
171-1844	12 - 7479	215	1719762	10 - 2226	162	172-6573	12 - 7477	215
171-1845	12 - 7589	216	172-0131	12 - 7487	215	172-6701	12 - 7520	215
171-1880	12 - 7478	215	172-0131	12 - 5077	212	172-6929	12 - 7481	215
171-1916	12 - 7482	215	172-0573	12 - 7473	215	172-6929	12 - 5071	212
171-1959	12 - 7501	215	172-0573	12 - 5063	212	172-7926	15 - 6066	338
171-2113	12 - 7438	214	172-0718	12 - 7579	216	172-7978	13 - 729	36
171-2719	12 - 7435	214	172-0718	12 - 5161	213	172-8133	12 - 7535	215
171-2911	12 - 7574	216	172-0726	12 - 5066	212	172-8183	12 - 7535	215
171-2912	12 - 7580	216	172-0726	12 - 7486	215	172-8225	09 - 442	134
171-3067	12 - 5062	212	172-0727	12 - 5079	212	172-8440	13 - 718	36
171-3067	12 - 7472	215	172-0938	12 - 7441	214	172-9440	13 - 718	36
171-3533	12 - 7438	214	172-1574	12 - 5095	212	172-9626	12 - 7480	215
171-3714	12 - 7486	215	172-1574	12 - 7505	215	172-9716	12 - 7592	216
171-3716	12 - 7478	215	172-1967	12 - 7495	215	173-1273	12 - 7478	215
171-3803	13 - 721	36	172-1967	12 - 5085	212	173-1718	12 - 7494	215
171-3853	12 - 7500	215	172-1995	12 - 7602	216	173-1719	12 - 5084	212
171-4106	12 - 5054	212	172-1995	12 - 5090	212	173-1719	12 - 7494	215
171-4107	12 - 7489	215	172-2074	12 - 5162	213	173-2171	12 - 5026	211
171-4115	12 - 7476	215	172-2074	12 - 7580	216	173-2171	12 - 7474	215
171-4115	12 - 5066	212	172-2095	12 - 7589	216	173-2192	12 - 7485	215
171-4251	12 - 5053	212	172-2095	12 - 5171	213	173-2582	12 - 7474	215
171-4285	12 - 7466	215	172-2238	12 - 7508	215	173-2582	12 - 5064	212
171-4286	12 - 7491	215	172-2258	12 - 7474	215	173-2719	12 - 7494	215
171-4513	12 - 5006	211	172-2344	12 - 7505	215	173-2719	12 - 5084	212
171-4673	12 - 7579	216	172-2344	12 - 5095	212	173-2726	12 - 7514	215
171-4690	12 - 7475	215	172-2523	12 - 7492	215	173-2726	12 - 5104	212
171-4785	12 - 7473	215	172-2523	12 - 5082	212	173-2880	12 - 7486	215
171-4799	12 - 7518	215	172-2639	12 - 5068	212	173-2880	12 - 5076	212
171-5006	12 - 7579	216	172-2639	12 - 7478	215	173-3152	12 - 7478	215
171-5010	12 - 7477	215	172-2992	12 - 7478	215	173-3152	12 - 5068	212
171-5212	12 - 7496	215	172-2993	12 - 5077	212	173-3439	12 - 5068	212
171-5213	12 - 7505	215	172-2993	12 - 7488	215	173-3770	12 - 5068	212
171-5340	13 - 720	36	172-3056	12 - 7497	215	173-3770	12 - 7478	215
171-5621	12 - 7435	214	172-3056	12 - 5087	212	173-3805	12 - 7440	214
171-5740	12 - 7588	216	172-3060	12 - 5084	212	173-5583	07 - 6915	105
171-5942	12 - 7490	215	172-3060	12 - 7494	215	173-5996	12 - 7440	214
171-6036	12 - 7436	214	172-366	12 - 7446	214	173-6248	12 - 7507	215
171-6161	12 - 7474	215	172-3661	12 - 5024	211	173-6259	12 - 7477	215
171-627	12 - 7490	215	172-4035	12 - 5101	212	173-6279	12 - 7479	215
171-6307	12 - 7513	215	172-4035	12 - 7511	215	173-6279	12 - 5069	212
171-6557	12 - 7528	215	172-4148	12 - 7518	215	173-6903	12 - 7543	215
171-6570	12 - 7486	215	172-4148	12 - 5108	212	173-7187	12 - 7640	216
171-6571	12 - 7477	215	172-4261	12 - 7494	215	173-7347	12 - 7512	215
171-7120	12 - 7487	215	172-4261	12 - 5084	212	173-7347	12 - 5102	212
171-7195	12 - 7501	215	172-4488	13 - 723	36	173-7459	12 - 7502	215
171-7584	13 - 2192	264	172-4729	12 - 5068	212	173-7488	41 - 5503	1224
171-7837	12 - 7503	215	172-5253	12 - 7477	215	173-7574	12 - 5087	212
171-7837	12 - 5093	212	172-5253	12 - 5067	212	173-7574	12 - 7497	215



O.E.M. REPLACEMENT CROSS REFERENCE

2014 CROSS REFERENCE

OEM #	Our #	Page #	OEM #	Our #	Page #	OEM #	Our #	Page #
BOLENS			BOLENS			BOSCH		
173-7807	07 - 6919	103	180-0365	12 - 5067	212	WR8DS	24 - 7220	589
173-8015	12 - 7492	215	180-0366	12 - 7479	215	WR8DS	24 - 7311	590
173-8433	20 - 7730	510	180-0367	12 - 7476	215	WR9D	24 - 2538	595
173-8496	12 - 7508	215	180-0367	12 - 5066	212	WR9EC	24 - 6934	592
173-8496	12 - 5098	212	181-2039	12 - 7609	216	WR9EC	24 - 7225	589
173-8511	12 - 5099	212	181-2039	12 - 5191	213	WR9EC	24 - 7224	589
173-8511	12 - 7509	215	181-3220	12 - 7480	215	WRS5F	24 - 8883	591
173-8571	15 - 6068	338	181-3220	12 - 5070	212	WS5F	24 - 8882	591
173-9080	12 - 7522	215	181-3271	12 - 7498	215	WS5F	24 - 2533	595
173-9080	12 - 5112	212	181-3561	12 - 7498	215	WS7E	24 - 2510	591
173-9943	12 - 7436	214	186-0801	12 - 7599	216	WS7F	24 - 7191	589
173-9944	12 - 7480	215	186-0801	12 - 5181	213	WS7F	24 - 2513	591
174-1135	12 - 7514	215	186-3848	12 - 7488	215	WS8E	24 - 5859	589
174-1179	41 - 5511	1223	186-3848	12 - 5078	212	WS8E	24 - 2504	591
174-1334	12 - 7528	215	189-2436	12 - 5011	211	WS8E	24 - 2551	590
174-1534	12 - 7528	215	189-2436	12 - 7433	214	WS8E	24 - 2529	593
174-1576	12 - 7524	215	189-3200	12 - 7433	214	WS8E	24 - 2543	589
174-1576	12 - 5114	212	189-4063	12 - 7433	214	WS8E	24 - 2532	593
174-1577	12 - 5116	212	189-4063	12 - 5011	211	WS8E	24 - 2507	591
174-1577	12 - 7526	215	189-4272	12 - 7440	214	WS8F	24 - 7148	591
174-1578	12 - 5076	212	189-4272	12 - 5018	211	WS8F	24 - 9993	593
174-1634	12 - 7528	215	189-4335	12 - 7441	214	WSAO	24 - 2542	589
174-2006	12 - 7444	214	189-4335	12 - 5019	211	WSAO	24 - 6932	591
174-2476	12 - 7440	214	390377	12 - 7469	215	WSR6F	24 - 5850	595
174-3876	12 - 5130	212				WSR9E	24 - 2537	595
174-4493	12 - 5101	212	BOSCH			BRIGGS & STRATTON		
174-5368	12 - 7498	215	601053	31 - 9369	1064	100023	32 - 12800	1111
174-6868	12 - 7481	215	HS5E	24 - 2512	591	185922GS	48 - 9447	1237
174-7188	12 - 7540	215	HS8E	24 - 2547	589	186071GS	23 - 6783	586
174-7199	12 - 7540	215	M5A	24 - 2535	594	211119	23 - 1508	567
174-7232	12 - 7488	215	M5A	24 - 7185	591	211119S	23 - 1508	567
174-7359	12 - 7506	215	USR7AC	24 - 12064	596	212004	23 - 2815	567
174-7515	12 - 7512	215	USR7AC	24 - 10427	596	220197	24 - 1298	600
174-7640	15 - 6069	338	W4-A1	24 - 7186	591	220859	18 - 1286	34
174-7938	12 - 7540	215	W4-A1	24 - 2552	594	221077	23 - 7945	575
174-8271	12 - 7502	215	W64S	24 - 2536	594	221172	22 - 12933	534
174-8723	31 - 9660	1066	W6AC	24 - 7187	591	221377	22 - 8208	532
175-1328	31 - 9659	1066	W6D	24 - 7149	591	221488	18 - 1281	444
175-1569	31 - 3319	1071	W7AC	24 - 7153	589	221747	22 - 7971	532
175-1597	12 - 7534	215	W7AO	24 - 7153	589	221798	24 - 1285	600
175-1601	12 - 7436	214	W8BC	24 - 7231	589	221995	22 - 13455	533
175-1872	12 - 7527	215	W8DC	24 - 7868	591	221997	22 - 7972	532
175-2137	31 - 5933	1071	W9D	24 - 2534	595	222014	22 - 7973	534
175-2137	31 - 8943	1071	W9ECO	24 - 5860	589	222698	23 - 11435	586
175-2751	12 - 7481	215	W9ECO	24 - 2531	593	222698	23 - 1435	586
175-3081	12 - 7550	215	W9ECO	24 - 2506	591	222698S	23 - 1435	586
175-3539	31 - 8943	1071	W9EO	24 - 6595	589	222698S	23 - 11435	586
175-3539	31 - 5933	1071	W9EO	24 - 2505	591	22372	03 - 250	74
1753539	31 - 10772	1071	W9EO	24 - 7150	591	225171	24 - 1298	600
1761083	31 - 9664	1066	W9EO	24 - 2530	593	230005	22 - 2887	537
1768882	31 - 9666	1066	WR7D	24 - 2539	595	230318	20 - 1345	34
177-2145	15 - 6068	338	WR8DC	24 - 2538	595	230591	22 - 8053	538
180-0365	12 - 7477	215	WR8DS	24 - 7189	592			

O.E.M. REPLACEMENT CROSS REFERENCE



CROSS REFERENCE 2014

OEM #	Our #	Page #	OEM #	Our #	Page #	OEM #	Our #	Page #
BRIGGS & STRATTON			BRIGGS & STRATTON			BRIGGS & STRATTON		
230896	22 - 9558	533	262784	22 - 7741	42	270989	22 - 8213	528
231371	22 - 10054	533	267615	23 - 1405	571	271025	22 - 8212	529
231435	22 - 9558	533	26763	22 - 177	42	271075	23 - 2761	569
231855S	22 - 10945	536	26925	22 - 184	42	271077	23 - 7945	575
231855S	22 - 10944	536	270026	22 - 1425	528	271139	23 - 3673	575
23433	22 - 2888	537	270026	22 - 10934	528	271139S	23 - 3673	575
260025	22 - 180	42	270055	23 - 7945	575	271271	19 - 12945	448
260029	22 - 181	530	270067	19 - 1376	451	271271	19 - 2797	452
260041	22 - 174	42	270069	23 - 1403	582	271411	23 - 7946	575
260455	22 - 8047	532	270070	23 - 3543	576	271412	23 - 6531	575
260545	22 - 178	42	270073	23 - 3538	576	271466	19 - 1369	452
260584	22 - 182	530	270074	23 - 3548	575	271485	02 - 156	43
260591	22 - 179	42	270080	23 - 1402	582	271592	23 - 1494	576
260596	22 - 175	42	270093	19 - 13641	457	271607	23 - 7944	575
260599	22 - 173	42	270239	23 - 2734	581	271701	23 - 1404	582
260695	22 - 188	531	270250	23 - 3537	576	271702	23 - 3530	582
260703	22 - 172	42	270251	19 - 1372	451	271702S	23 - 3530	582
260711	22 - 187	530	270253	22 - 1426	528	271794	19 - 2786	452
260832	22 - 176	42	270267	23 - 6525	576	271794S	19 - 2786	452
260860	23 - 9877	567	270268	23 - 6526	575	271866	23 - 2761	569
260871	22 - 7733	42	270273	23 - 2753	569	271866S	23 - 2761	569
260875	22 - 171	42	270328	23 - 6971	576	271867	23 - 8242	569
260877	22 - 171	42	27034	23 - 6521	575	271867S	23 - 8242	569
260878	22 - 170	42	270341	23 - 1482	569	271868	23 - 8243	569
261044	23 - 1509	567	270344	02 - 158	43	271868S	23 - 8243	569
261044S	23 - 1509	567	270344S	02 - 158	43	271916	23 - 7246	582
261055	23 - 2811	567	270345	23 - 3672	576	271933	19 - 8481	456
261055S	23 - 2811	567	270345S	23 - 3672	576	271939	19 - 10105	454
261105	22 - 7940	531	270349	02 - 158	43	271962	19 - 5939	452
261184	23 - 9876	567	270383	23 - 1480	569	271962S	19 - 5939	452
261233	23 - 2816	567	270430	23 - 1484	569	271996	23 - 7248	582
261306	22 - 7948	531	270447	19 - 1375	451	271997	23 - 7247	582
261395	22 - 8209	532	270511	23 - 7781	577	272157	23 - 1480	569
261409	18 - 1287	34	270528	19 - 1373	451	272157S	23 - 1480	569
261462	23 - 8562	567	270528S	19 - 1373	451	272163	23 - 1484	569
261528	23 - 9880	567	270538	23 - 3547	575	272163S	23 - 1484	569
261564	18 - 897	445	270571	23 - 7939	577	272165	23 - 2753	569
262246	23 - 9878	567	270579	19 - 1371	451	272166	23 - 8834	569
262246S	23 - 9878	567	270579S	19 - 1371	451	272167	23 - 1479	569
262247	23 - 9879	567	270684	23 - 7965	576	272170	23 - 1482	569
262247S	23 - 9879	567	270782	19 - 2786	452	272171	23 - 2732	569
262505	22 - 7736	42	270808	23 - 3530	582	272198	23 - 8228	582
262572	22 - 7735	42	270833	23 - 1401	582	272199	23 - 7173	577
262604	22 - 7736	42	270836	23 - 2732	569	272199S	23 - 7173	577
262651	23 - 8821	567	270843	19 - 1397	451	272200	23 - 8413	569
262651S	23 - 8821	567	270843S	19 - 1397	451	272200S	23 - 8413	569
262652	23 - 8822	567	270844	23 - 8229	577	272218	19 - 6603	453
262652S	23 - 8822	567	270848	19 - 1398	451	272235	19 - 6524	451
262656	22 - 7737	42	270884	23 - 7421	577	272235	19 - 12939	448
262656	22 - 7736	42	270895	23 - 3649	582	272235S	19 - 6524	451
262664	22 - 7738	42	270915	23 - 6528	582	272235S	19 - 12939	448
262678	22 - 7739	42	270916	23 - 6529	582	272293	23 - 8797	577
262759	22 - 7740	42	270973	19 - 10181	454	272309	23 - 7211	577



O.E.M. REPLACEMENT CROSS REFERENCE

2014 CROSS REFERENCE

OEM #	Our #	Page #	OEM #	Our #	Page #	OEM #	Our #	Page #
BRIGGS & STRATTON			BRIGGS & STRATTON			BRIGGS & STRATTON		
272403	19 - 7095	453	27355S	23 - 1498	576	293478	22 - 1431	537
272403S	19 - 12961	449	273638S	19 - 9304	456	293506	23 - 1454	558
272403S	19 - 7095	453	273638S	19 - 12946	448	294201	23 - 1529	566
272405	19 - 7051	456	27381	23 - 6523	576	294232	23 - 7213	557
272405	19 - 7051	456	27381S	23 - 6523	576	294232	23 - 1453	558
272409	23 - 1494	576	27404	23 - 1493	576	294303	26 - 1326	629
272409S	23 - 1494	576	27549	23 - 2733	581	294599	18 - 2296	438
272410	23 - 7963	576	27549S	23 - 2733	581	294599	18 - 12296	438
272444	19 - 10104	453	27670	23 - 1479	569	294599	18 - 1275	34
272477	19 - 7949	453	27750	23 - 1404	582	294599S	18 - 2296	438
272477S	19 - 7949	453	27803	23 - 2735	581	294599S	18 - 12296	438
272481	23 - 8225	581	27803S	23 - 2735	581	294599S	18 - 1275	34
272481S	23 - 8225	581	27828	23 - 1478	576	294606	23 - 1448	556
272489	23 - 7941	576	27828S	23 - 1478	576	294606S	23 - 1448	556
272490	19 - 2797	452	27909	23 - 1497	576	294628	31 - 1772	1075
272490	19 - 12945	448	27909S	23 - 1497	576	295587	23 - 2720	563
272490S	19 - 12945	448	27917	23 - 7942	575	295649	23 - 1454	558
272490S	19 - 2797	452	27918	23 - 7943	575	295657	23 - 1453	558
272533	19 - 8490	454	27987	19 - 1370	451	295852	23 - 1462	558
272536	23 - 1482	569	27987	19 - 12938	448	295871	26 - 876	608
272536S	23 - 1482	569	27987S	19 - 12938	448	295924	31 - 1927	1078
272538	22 - 8364	529	27987S	19 - 1370	451	296676	23 - 1510	567
272538S	22 - 8364	529	280104	26 - 860	608	296677	23 - 1511	567
272554	23 - 8414	575	280104	26 - 10860	608	296768	23 - 9811	584
272554S	23 - 8414	575	280104S	26 - 10860	608	297274	18 - 1278	439
272585	23 - 7966	577	280104S	26 - 860	608	297275	23 - 1469	571
272602	23 - 2734	581	280117	26 - 875	608	297615	23 - 1405	571
272602S	23 - 2734	581	280393	23 - 3548	575	297616	23 - 1470	571
272638	22 - 8227	529	280439	26 - 875	608	297815	23 - 1462	558
272638S	22 - 8227	529	280439S	26 - 875	608	298090	20 - 12952	450
272653	23 - 8746	575	280663	23 - 6866	585	298090	20 - 6000	46
272653S	23 - 8746	575	280918	26 - 9507	608	298090	20 - 16000	499
272916	23 - 13510	569	281024	22 - 13613	531	298090S	20 - 6000	46
272922	19 - 7051	456	281051	19 - 7778	453	298090S	20 - 16000	499
27293	23 - 3648	582	281165S	23 - 12043	577	298174	23 - 1452	558
272996	23 - 7963	576	281370	23 - 8789	584	298310	26 - 1324	608
273113	23 - 7966	577	281370A	23 - 8789	584	298316	31 - 1764	1075
273113S	23 - 7966	577	281370S	23 - 8789	584	298425	20 - 1359	515
273185	19 - 8490	454	281434S	25 - 10275	604	298502	31 - 1780	1076
273185S	19 - 8490	454	281503	26 - 13587	622	298683	20 - 1342	508
273186	23 - 7944	575	281505	26 - 13587	622	298830	18 - 1272	34
273186S	23 - 7944	575	281505S	26 - 10324	611	298904	23 - 2721	563
273238	19 - 12946	448	281658	23 - 2681	584	298905	23 - 2722	563
273238	19 - 9304	456	281658S	23 - 2681	584	298906	23 - 2723	563
273280S	23 - 11077	569	290880	31 - 1779	1076	298968	31 - 1778	1075
273356	19 - 9592	454	291244	18 - 12296	438	298982	23 - 1531	557
273356	19 - 12947	448	291675	23 - 1447	556	298982	23 - 1461	558
273356S	19 - 9592	454	291675S	23 - 1447	556	298983	23 - 2475	558
273356S	19 - 12947	448	291691	22 - 1415	539	298984	23 - 2476	559
273364	23 - 13224	575	291763	22 - 1416	539	298985	23 - 6878	559
273489	23 - 13525	569	292585	23 - 7966	577	298989	23 - 1471	571
27351	23 - 6522	582	292681	22 - 8046	537	298989	23 - 13526	572
27355	23 - 1498	576	292775	23 - 1469	571			

O.E.M. REPLACEMENT CROSS REFERENCE



CROSS REFERENCE 2014

OEM #	Our #	Page #	OEM #	Our #	Page #	OEM #	Our #	Page #
BRIGGS & STRATTON			BRIGGS & STRATTON			BRIGGS & STRATTON		
299059	22 - 1423	537	391783	23 - 6774	559	394569S	18 - 1268	439
299060	22 - 1424	537	391834	23 - 13513	571	394569S	18 - 1272	34
299106	18 - 1273	439	392134	26 - 10384	610	394644	18 - 862	438
299430	23 - 2772	566	392286	19 - 6514	454	394644	18 - 2280	440
299477	18 - 1277	439	392305S	20 - 13228	512	394661	23 - 6725	563
299477	18 - 859	440	392308	19 - 1396	452	394663	23 - 8826	563
299477S	18 - 859	440	392308S	19 - 1396	452	394681	22 - 1419	537
299477S	18 - 1277	439	392329	31 - 8051	1076	394682	22 - 8255	537
299577	23 - 1406	571	392331	23 - 5875	557	394693	22 - 1416	539
299637	22 - 1429	528	392606	31 - 9205	1080	394698	22 - 2884	539
299690	23 - 5875	557	392642	19 - 2777	452	394732	23 - 7964	577
299707	22 - 11958	533	392811	18 - 1267	438	394890	31 - 9204	1078
299740	22 - 10943	536	392989	18 - 8001	440	394891	31 - 8051	1076
299742	23 - 1531	557	392989	18 - 1277	439	394955	23 - 6725	563
299743	23 - 1532	557	393010	18 - 1269	439	394957	23 - 8826	563
299745	23 - 5875	557	393010S	18 - 1269	439	394988	31 - 8051	1076
299819	23 - 1442	556	393152	25 - 1330	604	394989	22 - 7968	538
299819S	23 - 1442	556	393152	25 - 11330	604	395005	20 - 13228	512
299948	26 - 852	608	393152	25 - 2234	605	395051R	20 - 1502	505
390066	26 - 1327	629	393156	20 - 13228	512	395537	26 - 9353	629
390365	23 - 8452	563	393169	20 - 1348	508	395538	26 - 9219	628
390391	26 - 12330	622	393232	18 - 859	440	395538	26 - 9218	628
390401	23 - 2770	566	393232	18 - 1277	439	395538	26 - 9354	629
390420	23 - 8049	567	393232S	18 - 1277	439	396244	20 - 5842	46
390486	23 - 8450	558	393232S	18 - 859	440	396306	26 - 9974	612
390492	19 - 2773	453	393271	23 - 6725	563	396424	19 - 2788	452
390930	19 - 1374	452	393397	22 - 8380	529	396424S	19 - 2788	452
391071	22 - 2885	539	393406	19 - 2840	453	396795	22 - 1420	537
391086	23 - 1445	556	393411	23 - 8951	571	397144	23 - 1469	571
391086S	23 - 1445	556	393456	31 - 9206	1080	397145	23 - 1405	571
391233	22 - 1420	537	393615	18 - 892	438	397358	31 - 7288	1076
391285	23 - 6725	563	393725	19 - 2778	453	397795	19 - 2789	455
391287	23 - 6726	563	393750	18 - 1281	444	397795S	19 - 2789	455
391288	23 - 8826	563	393755	18 - 1284	444	397809	31 - 10294	1079
391289	23 - 6727	563	393757	18 - 2297	444	397974	20 - 6593	512
391313	18 - 1283	440	393760	18 - 8004	445	397974S	20 - 6593	512
391483	23 - 1441	556	393761	18 - 2298	445	398003	26 - 9363	627
391483S	23 - 1441	556	393812	23 - 2709	556	398039	22 - 10942	536
391492	18 - 2280	440	393814	31 - 9207	1080	398101	25 - 7723	604
391651	23 - 6720	563	393957	19 - 1374	452	398183	22 - 10931	541
391652	23 - 6721	563	393957S	19 - 1374	452	398187	22 - 10053	533
391662	23 - 2747	571	394018	19 - 2777	452	398188	22 - 10055	537
391669	23 - 1463	558	394018S	19 - 2777	452	398593	31 - 7287	1076
391670	23 - 2479	558	394019	19 - 2806	452	398811	31 - 7286	1076
391671	23 - 8946	559	394019S	19 - 2806	452	399039	19 - 8482	455
391672	23 - 6772	559	394358	20 - 12949	450	399517	20 - 5842	46
391673	23 - 6722	563	394358	20 - 11349	499	399671	26 - 1324	608
391674	23 - 6723	563	394358	20 - 1349	46	399676	26 - 10384	610
391675	23 - 8947	563	394358S	20 - 11349	499	399781	23 - 8825	556
391681	22 - 1428	528	394358S	20 - 1349	46	399781S	23 - 8825	556
391780	23 - 1466	558	394434	23 - 8050	567	399806	19 - 5941	452
391781	23 - 6773	558	394569	18 - 1272	34	399806S	19 - 5941	452
391782	23 - 8827	559	394569	18 - 1268	439	399877	19 - 2841	455



O.E.M. REPLACEMENT CROSS REFERENCE

2014 CROSS REFERENCE

OEM #	Our #	Page #	OEM #	Our #	Page #	OEM #	Our #	Page #
BRIGGS & STRATTON			BRIGGS & STRATTON			BRIGGS & STRATTON		
399877S	19 - 2841	455	493219	31 - 10296	1079	495098S	31 - 9742	1070
399959	19 - 2838	456	493237	31 - 8771	1076	495307	23 - 10770	556
399959	19 - 12941	448	493261	23 - 8794	558	495307S	23 - 10770	556
399968	19 - 7879	454	493262	23 - 8793	563	495602	23 - 1469	571
4104	19 - 1371	451	493263	23 - 13290	572	495603	23 - 1405	571
4113	22 - 171	42	493288	18 - 1267	438	495603	23 - 14548	572
4154	19 - 6929	483	493295	26 - 10385	622	495606	22 - 11140	540
490075	20 - 3462	512	493386	23 - 8792	563	495766	26 - 12329	622
490179	26 - 1326	629	493388	23 - 8795	558	495770	22 - 7721	528
490311	26 - 10085	628	493389	23 - 8790	559	495799	22 - 10933	540
490348	23 - 6758	566	493537	19 - 8481	456	495859	31 - 9293	1076
490547	18 - 7867	440	493537S	19 - 8481	456	495877	26 - 9362	627
490566	23 - 6757	566	493625	31 - 7804	1063	495878	26 - 8498	627
490586	31 - 9293	1076	493629	20 - 12951	450	495933	22 - 13537	533
490652	25 - 7327	604	493629	20 - 7998	496	496077	19 - 7880	455
490652	25 - 17327	604	493640	22 - 12304	533	496106	18 - 7867	440
490877	26 - 6673	608	493762	22 - 10237	540	496106S	18 - 7867	440
490937	22 - 10931	541	493824	26 - 8286	609	496115	20 - 8959	51
491021	19 - 6604	453	493880	24 - 1285	600	496117	23 - 13290	572
491055S	24 - 7423	592	493880	24 - 9161	599	496650	26 - 12329	622
491056	19 - 5909	483	493880S	24 - 9161	599	496659	23 - 1470	571
491056	19 - 12863	450	493880S	24 - 1285	600	496881	26 - 10877	612
491288	25 - 2234	605	493909	19 - 7094	453	496894	19 - 7094	453
491312	31 - 9293	1076	493909	19 - 12936	448	496894	19 - 12936	448
491413	18 - 8003	440	493910	19 - 7214	453	496894S	19 - 7094	453
491435	19 - 12960	449	493936	18 - 1278	439	496894S	19 - 12936	448
491435	19 - 8481	456	493963	18 - 8002	440	496914	31 - 7287	1076
491435S	19 - 8481	456	493982	20 - 1359	515	497401	26 - 9798	612
491519	19 - 5941	452	493982S	20 - 1359	515	497481	22 - 10939	540
491539	22 - 10086	539	493988	20 - 8000	513	497525	26 - 9796	612
491546	31 - 10293	1078	493988	20 - 2235	514	497535	22 - 10933	540
491588	19 - 12941	448	493988S	20 - 8000	513	497578	22 - 10937	541
491588	19 - 2838	456	493988S	20 - 2235	514	497586	22 - 14111	550
491588S	19 - 2838	456	494191	23 - 9877	567	497586	22 - 14112	550
491588S	19 - 12941	448	494241	23 - 9261	571	497595	26 - 9796	612
491889	26 - 5876	629	494349	22 - 10935	540	497596	26 - 9797	612
491922	22 - 10876	535	494381	22 - 12670	533	497598	26 - 10385	622
491950	19 - 6602	453	494408	20 - 8958	51	497605	26 - 10562	629
492030	20 - 8546	511	494511	19 - 7877	455	497606	26 - 9854	612
492056	19 - 6929	483	494511S	19 - 7877	455	497608	26 - 10084	628
492333	26 - 13587	622	494559	20 - 3462	512	497680	26 - 12368	622
492341	31 - 9293	1076	494585	18 - 1278	439	497725	19 - 8815	454
492341	31 - 9293	1076	494585	18 - 892	438	497725S	19 - 8815	454
492416	31 - 8771	1076	494622	22 - 7951	538	497830	26 - 12329	622
492653	23 - 13513	571	494623	22 - 7969	538	497929	20 - 9315	513
492832	26 - 8286	609	494624	22 - 11140	540	497929S	20 - 9315	513
492889	19 - 8483	455	494625	22 - 7967	538	498144	26 - 9488	609
492932	19 - 12861	450	494768	20 - 5841	46	498148	26 - 9799	612
492932	19 - 6929	483	494769	20 - 9294	511	498170	22 - 14111	550
492932S	19 - 12861	450	494782	26 - 12329	622	498260	22 - 10237	540
492932S	19 - 6929	483	494846	26 - 12329	622	498261	22 - 10931	541
492947	19 - 6575	453	49485	18 - 892	438	498584	23 - 6725	563
493206	19 - 6603	453	494926	26 - 9507	608	498586	23 - 8826	563

O.E.M. REPLACEMENT CROSS REFERENCE



CROSS REFERENCE 2014

OEM #	Our #	Page #	OEM #	Our #	Page #	OEM #	Our #	Page #
BRIGGS & STRATTON			BRIGGS & STRATTON			BRIGGS & STRATTON		
498596	19 - 9168	454	590781	31 - 8051	1076	691569	23 - 6522	582
498596S	19 - 9168	454	591420	31 - 7287	1076	691599	22 - 184	42
498680	23 - 10754	558	591420	31 - 1780	1076	691609	20 - 1346	34
498681	23 - 11322	559	613022	19 - 10263	455	691643	19 - 7880	455
498984	18 - 8002	440	650821	19 - 10263	455	691663	23 - 9965	585
498984S	18 - 8002	440	65647	23 - 3546	575	691667	19 - 7214	453
499059	22 - 14112	550	65704	31 - 1769	1075	691668	19 - 7778	453
499220	22 - 10936	541	66538	24 - 1285	600	691720	18 - 1286	34
499282	23 - 6725	563	66538S	24 - 1285	600	691764	20 - 1345	34
499284	23 - 6725	563	66728	25 - 7327	604	691775	22 - 9558	533
499290	23 - 8826	563	66728	25 - 17327	604	691794	23 - 8049	567
499292	23 - 8826	563	66768	23 - 2681	584	691798	22 - 7948	531
499425	23 - 10755	558	67218	20 - 1346	34	691801	22 - 8209	532
499486	19 - 12942	448	67838	23 - 14299	584	691804	23 - 9880	567
499486	19 - 9273	456	68477	20 - 1503	508	691808	18 - 897	445
499486S	19 - 12942	448	68618	26 - 1338	608	691832	22 - 7736	42
499486S	19 - 9273	456	68838	23 - 8789	584	691832	22 - 7737	42
499521	26 - 9798	612	68848	26 - 1339	608	691833	22 - 7738	42
499532	19 - 6600	483	68848S	26 - 1339	608	691868	23 - 6971	576
499685	22 - 12293	540	68987	23 - 3545	575	691871	22 - 8213	528
499706	26 - 13252	622	690014	23 - 1532	557	691873	22 - 8212	529
499901	26 - 12707	609	690018	23 - 2479	558	691874	18 - 8003	440
499907	23 - 6722	563	690019	23 - 8946	559	691876	02 - 156	43
499908	23 - 6723	563	690020	23 - 6772	559	691894	23 - 13224	575
499909	23 - 8947	563	690101	26 - 13252	622	691909	24 - 12054	599
499921	23 - 1463	558	690191	22 - 10932	540	691912	22 - 13613	531
499956	23 - 6725	563	690248	31 - 9293	1076	691955	31 - 9205	1080
499957	23 - 6726	563	690266	22 - 2888	537	692024	26 - 9363	627
499958	23 - 8826	563	690273	23 - 7946	575	692038	18 - 7867	440
499959	23 - 6727	563	690289	23 - 9778	585	692046	20 - 6593	512
499996	23 - 1466	558	690429	23 - 8562	567	692134	22 - 8053	538
499997	23 - 6773	558	690453	18 - 1287	34	692141	05 - 8052	89
499998	23 - 8827	559	690480	22 - 7733	42	692179	03 - 250	74
499999	23 - 6774	559	690578	24 - 1298	600	692189	23 - 14299	584
5021D	22 - 10934	528	690610	19 - 9168	454	692190	20 - 1503	508
5021H	22 - 10934	528	690612	20 - 1348	508	692191	05 - 8052	89
5021K	22 - 10934	528	690618	22 - 7973	534	692193	02 - 41	39
5088D	19 - 11547	451	690627	22 - 7971	532	692205	22 - 174	42
5088H	19 - 11547	451	690766	22 - 8208	532	692206	22 - 8047	532
5409H	31 - 10771	1071	690953	22 - 2890	537	692207	22 - 182	530
5409K	31 - 10771	1071	691031	23 - 3548	575	692208	22 - 188	531
5410H	31 - 10772	1071	691035	20 - 12951	450	69221	20 - 13228	512
5410K	31 - 10772	1071	691035	20 - 7998	496	692211	22 - 7740	42
5411H	31 - 9331	1060	691043	24 - 10786	591	692213	23 - 1402	582
5411K	31 - 9331	1060	691060	31 - 11578	1076	692214	23 - 6525	576
5412H	31 - 9623	1060	691185	31 - 9204	1078	692215	23 - 6526	575
5412K	31 - 9623	1060	691188	31 - 10293	1078	692218	23 - 1401	582
5429K	19 - 14158	457	691242	22 - 10054	533	692219	23 - 7421	577
555087	23 - 10770	556	691265	26 - 10233	627	692221	23 - 1404	582
590393	23 - 8822	567	691276	22 - 7739	42	692226	23 - 7246	582
590394	23 - 8821	567	691278	22 - 7741	42	692230	23 - 2753	569
590777	23 - 13526	572	691293	26 - 10562	629	692231	23 - 8834	569
590777	23 - 1471	571	691564	26 - 10709	612	692232	23 - 8228	582



O.E.M. REPLACEMENT CROSS REFERENCE

2014 CROSS REFERENCE

OEM #	Our #	Page #	OEM #	Our #	Page #	OEM #	Our #	Page #
BRIGGS & STRATTON			BRIGGS & STRATTON			BRIGGS & STRATTON		
692236	23 - 8797	577	696854	19 - 6929	483	792813	22 - 7948	531
692237	23 - 7211	577	696854	19 - 12861	450	793214	23 - 2721	563
692241	23 - 7941	576	697014	19 - 12943	448	793281	31 - 7287	1076
692249	23 - 13510	569	697014	19 - 10184	456	793281	31 - 1780	1076
692278	23 - 6531	575	697015	19 - 10304	456	793360	31 - 10293	1078
692297	19 - 7778	453	697015	19 - 13629	449	793569	19 - 12673	453
692299	26 - 13587	622	697029	19 - 9168	454	793606	20 - 6593	512
692299	26 - 10325	610	697036	31 - 1780	1076	793676	19 - 12895	455
692304	18 - 1283	440	697037	31 - 1764	1075	793685	19 - 12894	453
692307	18 - 862	438	697152	19 - 10263	455	794071	19 - 12272	452
692307	18 - 2280	440	697153	19 - 12943	448	794209	23 - 1471	571
692313	22 - 10876	535	697153	19 - 10184	456	794209	23 - 13526	572
692318	31 - 7804	1063	697153	19 - 12964	455	794360	31 - 10293	1078
692405	23 - 7248	582	697153	19 - 12943	448	795027	20 - 2235	514
692406	23 - 7247	582	697153	19 - 10184	456	795027	20 - 8000	513
692446	19 - 9591	454	697292	19 - 10454	455	795036	18 - 2298	445
692513	19 - 6600	483	697634	19 - 12943	448	795066	19 - 12968	456
692513	19 - 12864	450	697634	19 - 10184	456	795083	22 - 7721	528
692519	19 - 11795	454	697775	19 - 10263	455	795115	19 - 10184	456
692520	19 - 7050	454	697776	19 - 10184	456	795115	19 - 12943	448
692550	23 - 12627	556	697944	20 - 9294	511	795121	26 - 9798	612
692554	23 - 13525	569	697947	20 - 5841	46	795161	32 - 12800	1111
692605	31 - 8771	1076	698083	19 - 10184	456	795315	31 - 9293	1076
692667	23 - 13137	575	698083	19 - 12943	448	795629	23 - 8746	575
692703	22 - 12293	540	698181	20 - 9294	511	795890	19 - 6929	483
692915	23 - 3547	575	698182	20 - 5842	46	796031	19 - 13644	457
692939	23 - 9811	584	698183	20 - 5841	46	796032	19 - 14158	457
693059	26 - 10860	608	698210	23 - 13525	569	796254	19 - 12985	456
693059	26 - 860	608	698369	19 - 11547	451	796260	22 - 188	531
693469	26 - 10709	612	698369	19 - 12940	448	796610	23 - 11123	577
693503	22 - 10938	540	698413	19 - 10263	455	796611	22 - 12304	533
693551	26 - 12494	613	698717	23 - 1482	569	796956	18 - 2297	444
693552	26 - 12954	613	698754	19 - 9273	456	796970	19 - 14206	457
693713	26 - 13114	613	699334	25 - 7723	604	797007	19 - 10263	455
693900	26 - 12330	622	699655	23 - 1529	566	797008	19 - 12943	448
693981	23 - 11123	577	699833	23 - 8225	581	797008	19 - 10184	456
694056	22 - 10086	539	699933	23 - 1471	571	797182	31 - 9204	1078
694394	20 - 8958	51	699933	23 - 13526	572	797375	31 - 9204	1078
694395	20 - 8959	51	710265	19 - 9167	456	797622	22 - 10054	533
695091	19 - 9273	456	710266	19 - 8814	456	797704	19 - 14422	457
695091	19 - 12942	448	711459	19 - 12886	456	797819	19 - 14089	457
695396	19 - 6929	483	715231	31 - 9293	1076	798452	19 - 14364	457
695396	19 - 12861	450	790166	19 - 12080	452	798897	19 - 14289	457
695479	26 - 13096	613	791545	20 - 13228	512	798911	19 - 14423	457
695547	19 - 10184	456	791850	20 - 5905	43	799579	19 - 14099	457
695708	26 - 10860	608	792020	20 - 11816	506	799650	31 - 9293	1076
695708	26 - 860	608	792038	19 - 12877	455	799651	31 - 14561	1075
695740	25 - 7723	604	792101	19 - 13049	455	799868	22 - 14111	550
695890	23 - 2734	581	792105	19 - 12282	454	802574	31 - 8771	1076
696537	26 - 10384	610	792303	19 - 12283	454	805113	19 - 6601	455
696539	26 - 9362	627	792303	19 - 12479	454	805267	19 - 8480	455
696540	26 - 8498	627	792367	23 - 8452	563	805267S	19 - 8480	455
696541	26 - 9854	612	792383	22 - 12293	540	808106	26 - 10709	612

O.E.M. REPLACEMENT CROSS REFERENCE



CROSS REFERENCE 2014

OEM #	Our #	Page #	OEM #	Our #	Page #	OEM #	Our #	Page #
BRIGGS & STRATTON			BUNTON-GOODALL			BUNTON-GOODALL		
808656	22 - 10876	535	PJH1060	09 - 8240	148	PLO786	13 - 734	36
808656	22 - 10875	535	PL0368A	13 - 12891	281	PLO815	10 - 5704	178
820263	19 - 9550	459	PL0941	09 - 6573	133	PLO848	12 - 5238	242
820263	19 - 11842	459	PL4020	03 - 8800	57	PLO861	12 - 7591	216
821136	19 - 11865	468	PL4055	15 - 3373	338	PLO928	09 - 5703	147
821136	19 - 9728	468	PL4205	15 - 6116	338	PLO961	12 - 7641	216
821136	19 - 11865	468	PL4205	15 - 6300	322	PO209	09 - 6573	133
841497	19 - 11841	468	PL4206	15 - 6294	323	Z32008	10 - 5705	178
841497	19 - 9583	468	PL4206	15 - 6014	338	Z35010	10 - 8412	176
842921	19 - 6929	483	PL4274	13 - 8005	263	BUSH HOG		
842921	19 - 12861	450	PL4275	12 - 7913	242	50018299	31 - 9656	1064
89966	18 - 1270	34	PL4518	31 - 9660	1066	50047912	31 - 12839	1061
89966	18 - 2294	438	PL4606A	10 - 8187	186	78892	31 - 9622	1063
91539	05 - 8052	89	PL4607	10 - 8188	186	99073	31 - 9659	1066
92738	23 - 9778	585	PL4611	09 - 3217	134	CARLISLE		
93053	20 - 5905	43	PL4855	15 - 6300	322	321050	08 - 10959	125
93065	02 - 41	39	PL4855	15 - 6115	338	457211	08 - 10288	110
93357	22 - 2890	537	PL6139	10 - 8188	186	457291	08 - 10286	110
94174	23 - 9965	585	PL6140A	10 - 8187	186	5111021	08 - 12671	122
94616	22 - 2890	537	PL7323	09 - 8488	135	511140	08 - 10970	122
94687	23 - 9965	585	PL7484	31 - 9659	1066	511255	08 - 11221	120
94913	22 - 2890	537	PL7540	07 - 6917	103	511416	08 - 10127	120
95162	20 - 5905	43	PL7994	31 - 9656	1064	511433	08 - 13245	120
95162S	20 - 5905	43	PL8036A	13 - 7861	264	511434	08 - 12524	120
95458GS	48 - 9422	1235	PL8540A	13 - 7918	263	512186	08 - 10290	122
95459GS	48 - 9416	1235	PL8540A	13 - 10414	288	5170111	08 - 12766	122
95459GS	48 - 9414	1235	PLA0965	42 - 7097	1231	5170161	08 - 12764	122
99157	09 - 10303	135	PLO019	12 - 7479	215	5170171	08 - 12765	122
99157	09 - 7162	134	PLO019	12 - 7479	215	574311	08 - 11471	122
992304	24 - 7423	592	PLO020	12 - 7480	215	574318	08 - 12244	120
99333	22 - 11959	533	PLO020	12 - 7480	215	574361	08 - 11023	122
99525S	22 - 10941	536	PLO021	12 - 7482	215	5743U1	08 - 12795	122
B4705GS	48 - 9413	1235	PLO021	12 - 7482	215	575315	08 - 12635	122
B4705GS	48 - 9415	1235	PLO035	10 - 2224	172	588389	08 - 12310	120
BUNTON-GOODALL			PLO148	12 - 7471	215	70-376	08 - 8915	120
2308134	42 - 14182	1233	PLO148	12 - 7471	215	70-405	08 - 12767	122
2308135	42 - 14184	1231	PLO368A	13 - 2188	263	P552021	08 - 10289	122
252762	18 - 8002	440	PLO371	10 - 2219	161	T50D373	08 - 10761	127
4130099	42 - 14183	1233	PLO410	10 - 5706	176	T50D397	08 - 10760	127
8036A	13 - 7861	264	PLO417	10 - 2238	175	T55A3N9	08 - 10726	126
P2005	15 - 3374	338	PLO457	10 - 2218	157	T55A3P2	08 - 10725	126
PAL0368A	13 - 12891	281	PLO511	12 - 7599	216	T55U373	08 - 10736	127
PAL0368A	13 - 2188	263	PLO556	10 - 2243	156	T55U3C7	08 - 10735	127
PAL0806A	10 - 8187	186	PLO556AL	10 - 2243	156	T560352	08 - 11809	121
PAL0942	08 - 8196	108	PLO609	09 - 3217	134	T5793A6	08 - 10733	127
PAL0942A	08 - 8196	108	PLO617	10 - 1191	175	T5793P2	08 - 10732	127
PAL0942A	08 - 8196	108	PLO619	12 - 5241	242	CARLTON		
PAL0942A	08 - 8196	108	PLO636	13 - 2186	267	11851	35 - 14338	1150
PAL1075A	08 - 905	112	PLO642	06 - 3239	98	11853	35 - 10916	1150
PC005	15 - 6299	324	PLO643	12 - 5237	242	12-10-N145-HC	35 - 10597	1157
PC005	15 - 6141	339	PLO643	12 - 7493	215			
PJ-5019-50	03 - 8766	57	PLO661	12 - 7603	216			
PJ4020	03 - 8800	57	PLO786	13 - 5869	263			



O.E.M. REPLACEMENT CROSS REFERENCE

2014 CROSS REFERENCE

OEM #	Our #	Page #	OEM #	Our #	Page #	OEM #	Our #	Page #
CARLTON			CARLTON			CARLTON		
12-10-N4-MHC	35 - 13104	1151	24-81-A284-PS	35 - 13187	1161	K1L-72E	34 - 11684	1144
12-26-N144-HC	35 - 10575	1165	24-81-A284-PS	35 - 12336	1157	K1L-78E	34 - 11686	1144
12-26-N4-HC	35 - 12433	1171	28-81-A192-PS	35 - 13188	1161	K1L-80E	34 - 11687	1144
12-28-N148-HC	35 - 10606	1159	28-81-A292-PS	35 - 13189	1161	K2C-BL-66E	34 - 11539	1143
12-29-N144-HC	35 - 10610	1157	36-81-A3115-PS	35 - 13191	1161	K2C-BL-68E	34 - 11540	1143
14-10-N152-HC	35 - 10596	1157	36D025A3PS	35 - 13120	1171	K2C-BL-72E	34 - 11541	1143
14-10-N4-MHC	35 - 13105	1151	43202	34 - 12216	1141	K2L-64E	34 - 11688	1144
14-28-N153-HC	35 - 10605	1159	43203	34 - 12217	1141	K2L-68E	34 - 11690	1144
14-29-N149-HC	35 - 10604	1157	50030	36 - 12036	1177	K2L-72E	34 - 11691	1144
15-81-A256-PS	35 - 12349	1157	50115	36 - 12045	1177	K2L-80E	34 - 11693	1144
16-01-K266-HC	35 - 10599	1157	50120	36 - 12038	1174	K3-BL-25R	34 - 11525	1140
16-01W-050-PH	35 - 12333	1157	50455	36 - 12044	1177	K31-68E	34 - 11696	1144
16-01W-A160-PS	35 - 12331	1157	50940	36 - 12046	1176	K3C-62E	34 - 11534	1143
16-09-K166-TC	35 - 13080	1159	50940	36 - 1603	1175	K3C-81E	34 - 11528	1143
16-10-N156-HC	35 - 14235	1149	6-10091X	36 - 14276	1177	K3L-67E	34 - 11695	1144
16-10-N157-HC	35 - 10595	1157	600741CA	35 - 13064	1152	K3L-74E	34 - 11697	1144
16-14-A160-TC	35 - 10609	1165	600743CA	35 - 13066	1152	K3L-81E	34 - 11698	1144
16-21-A160-TC	1035 - 10603	1157	600753CA	35 - 13074	1152	K3L-BL-100R	34 - 11530	1140
16-28-N159-HC	35 - 10602	1159	600756CA	35 - 13076	1152	N1C-BL-25R	34 - 10499	1140
16-29-N155-HC	35 - 10601	1157	65980	32 - 10802	1106	N1C-BL-60E	34 - 12412	1142
16-41-A160-PS	35 - 12338	1159	65981	32 - 10803	1106	N1CB2H12-45ECA	35 - 13184	1152
16-42-A160-PS	35 - 12355	1171	65985	32 - 10798	1106	N1CBL214-52E	35 - 10840	1152
16-42-A160-TC	35 - 10574	1171	65986	32 - 10800	1106	N1CBL216-57E	35 - 10828	1152
16-42-A360-PS	35 - 12356	1171	65989	32 - 10799	1106	N1CBL218-62E	35 - 10836	1152
16-42-K367-PS	35 - 13223	1171	65993	32 - 10804	1106	N4C-025U	34 - 14153	1140
16-81-A160-PS	35 - 12342	1161	82508	32 - 10919	1106	N4C-100U	34 - 14154	1140
16-81-A260-PS	35 - 12335	1157	A1EP-66E	34 - 11524	1142	N4C-BL-38E	34 - 12720	1141
16-81-A260-TC	1135 - 10612	1161	A1EP-GL-25R	34 - 11543	1140	N4C-BL-44E	34 - 10896	1141
18-01W-A164-PS	35 - 12352	1161	A1LM-59E	34 - 11665	1144	N4C-BL-50E	34 - 10805	1142
18-01W-A264-PS	35 - 12348	1165	A1LM-60E	34 - 11666	1144	PST325	35 - 14338	1150
18-01W-K172-TC	1235 - 12347	1161	A1LM-68E	34 - 11669	1144	PST375	35 - 10916	1150
18-09-K172-TC	35 - 13082	1159	A1LM-70E	34 - 11670	1144	SR7-11892	36 - 12589	1176
18-09-K272-TC	35 - 13589	1149	A1LM-72E	34 - 11529	1144	SR7-11892	36 - 1690	1177
18-09W-K172-TC	35 - 13086	1159	A1LM-72E	34 - 11671	1144	SR7-18720	36 - 1688	1177
18-10-N162-HC	35 - 10613	1157	A2EP-GL-068G	34 - 14635	1142	SR7-18720	36 - 12588	1176
18-26-K368-TC	35 - 13186	1171	A2LM-59E	34 - 11673	1144	SR7-22270	36 - 1686	1177
18-81-A168-PS	35 - 12343	1161	A2LM-64E	34 - 11674	1144	SR7-68210	36 - 1689	1177
18-81-A268-TC	1135 - 10611	1161	A2LM-84E	34 - 12290	1145	SR7-68210	36 - 12584	1176
20-01W-050-PH	35 - 12334	1157	A2LM-93E	34 - 12291	1145	SR8-11891	36 - 12586	1176
20-01W-A170-PS	35 - 12332	1157	A2LM-E	34 - 11676	1144	SR8-11891	36 - 9499	1177
20-01W-K278-PS	35 - 13083	1161	A2LM-GL-72E	34 - 11545	1142	SR8-22273	36 - 12582	1176
20-10W-K1-HC	35 - 13085	1159	A3LM100	34 - 11481	1140	SR8-22273	36 - 9498	1177
20-10W-K1-TC	135 - 13084	1159	K1C-56E	34 - 11526	1143	SRA17	36 - 1689	1177
20-41-050-PH	35 - 12341	1159	K1C-64E	34 - 11533	1143	SRA18	36 - 9498	1177
20-42-A172-PS	35 - 12357	1171	K1C-80E RO	34 - 11055	1143	SRA27	36 - 1688	1177
20-42-A372-PS	35 - 12358	1171	K1C-BL-66E	34 - 11536	1143	SRA37	36 - 10987	1177
20-42-K381-SP	35 - 14343	1149	K1C-BL-72E	34 - 11538	1143	SRB17	36 - 1686	1177
20-81-050-PH	35 - 12346	1161	K1CBL318-72E	CA35 - 10837	1152	SRK27	36 - 1690	1177
20-81-063-PH	35 - 12353	1169	K1CBL320-78E	35 - 10838	1152	SRK37	36 - 10986	1177
20-81-A172-PS	35 - 12344	1161	K1L-56E	34 - 11679	1144			
20-81-A272-PS	35 - 12345	1161	K1L-64E	34 - 11680	1144			
20D176050PH	35 - 12341	1159	K1L-66E	34 - 11681	1144			
24-81-A184-PS	35 - 12337	1157	K1L-67E	34 - 11682	1144			
						CASE/INGERSOLL		
						1979607C1	12 - 12708	228
						A-65717	12 - 7516	215

O.E.M. REPLACEMENT CROSS REFERENCE



CROSS REFERENCE 2014

OEM #	Our #	Page #	OEM #	Our #	Page #	OEM #	Our #	Page #
CASE/INGERSOLL			CASE/INGERSOLL			CASTLEGARDEN		
A-70090	19 - 1386	470	C-24018	12 - 7516	215	82004600/0	10 - 50167	73
A-70205	12 - 7440	214	C-24296	12 - 7508	215	82207200/0	10 - 50256	186
A-70226	12 - 7607	216	C-24342	12 - 7479	215	82207201/0	10 - 50257	186
A-70227	12 - 7511	215	C-24349	12 - 7503	215	82207202/0	10 - 12706	187
A-70296	12 - 7609	216	C-24442	15 - 3332	339	TC102/122	10 - 14316	166
A-70304	12 - 7525	215	C-25139	07 - 6915	105			
A-70525	12 - 7606	216	C-25140	07 - 6918	104	CHAMPION		
C-10507	12 - 7435	214	C-25682	07 - 6919	103	2071	24 - 9730	592
C-11124	12 - 7584	216	C-26437	12 - 7474	215	255	24 - 1295	594
C-11384	12 - 7613	216	C-26525	31 - 8943	1071	8815-1	24 - 13039	596
C-11514	12 - 7445	214	C-26736	07 - 6915	105	CJ14	24 - 2532	593
C-11945	12 - 7525	215	C-26737	07 - 6918	104	CJ14	24 - 2507	591
C-11946	12 - 7608	216	C-27120	12 - 5083	212	CJ14	24 - 10706	594
C-11949	12 - 7609	216	C-27707	12 - 7519	215	CJ14	24 - 5859	589
C-11988	12 - 7606	216	C-27708	12 - 7523	215	CJ14	24 - 2523	594
C-13012	13 - 722	36	C-28883	19 - 1386	470	CJ14	24 - 5854	595
C-13184	12 - 7516	215	C-29476	12 - 5086	212	CJ4	24 - 2500	594
C-14116	12 - 7484	215	C-31500	07 - 6909	107	CJ6	24 - 2500	594
C-14345	12 - 7439	214	C-33025	31 - 8943	1071	CJ6	24 - 2543	589
C-14965	12 - 7523	215	C-33025	31 - 10772	1071	CJ6	24 - 2510	591
C-15343	13 - 727	36	C-46890	31 - 9666	1066	CJ6	24 - 2551	590
C-15370	12 - 7506	215	C12102	10 - 2212	174	CJ6	24 - 12549	598
C-15411	12 - 7535	215	C12110	09 - 6573	133	CJ6Y	24 - 8882	591
C-15552	12 - 7476	215	C23359	12 - 7514	215	CJ7Y	24 - 2513	591
C-15672	13 - 719	36	C23535	13 - 719	36	CJ7Y	24 - 12545	598
C-15943	12 - 7513	215	C23804	12 - 7510	215	CJ8	24 - 2504	591
C-15944	12 - 7509	215	C23806	12 - 7513	215	CJ8	24 - 12542	598
C-16088	12 - 7510	215	C28025	13 - 2176	263	CJ8	24 - 2529	593
C-16093	12 - 7512	215	C41167	09 - 6573	133	CJ8	24 - 1295	594
C-16094	12 - 7519	215	C426424	09 - 6573	133	CJ8	24 - 2543	589
C-17213	13 - 731	36	NLS	12 - 7510	215	CJ8	24 - 2551	590
C-17413	12 - 7475	215				CJ8Y	24 - 9993	593
C-18634	12 - 7525	215				CJ8Y	24 - 7148	591
C-18707	12 - 7525	215				CJ8Y	24 - 12546	598
C-18709	12 - 7514	215	CASTELGARDEN			CJ8Y	24 - 2529	593
C-18918	12 - 7511	215	19399060/0	10 - 14316	166	CJ8Y	24 - 2548	590
C-18919	12 - 7474	215	19410608/1	31 - 13349	1062	CJ8Y	24 - 2501	595
C-18966	13 - 2176	263	19410611/0	31 - 13349	1062	CS-45	24 - 1295	594
C-19161	12 - 7514	215	82207203/0	10 - 12966	187	D10	24 - 5856	594
C-19162	12 - 7586	216	1136-0837-01	10 - 14316	166	D14	24 - 7227	589
C-20405	19 - 2844	472	12735695/0	17 - 50166	435	D14	24 - 5856	594
C-22706	12 - 7512	215	18399065/1	10 - 14316	166	D14	24 - 7185	591
C-22707	12 - 7519	215	18736100/0	31 - 50237	1072	D14	24 - 2535	594
C-22708	12 - 7523	215	81004395	15 - 50144	340	D16	24 - 5856	594
C-23685	12 - 7511	215	81004396/0	15 - 50146	339	D16	24 - 7422	591
C-23805	12 - 7509	215	81004397/0	15 - 50145	339	D16J	24 - 7227	589
C-23807	12 - 7510	215	81004398/0	15 - 13215	340	D16J	24 - 5856	594
C-23808	12 - 7516	215	82004340/0	15 - 50142	340	D21	24 - 5856	594
C-23809	12 - 7513	215	82004340/1	15 - 11311	339	D21	24 - 7227	589
C-23810	12 - 7512	215	82004341/0	15 - 50143	340	D9	24 - 5856	594
C-23837	12 - 7514	215	82004342/0	15 - 50163	340	D9J	24 - 5856	594
C-23949	12 - 7520	215	82004343/0	15 - 50162	340	DJ6J	24 - 2503	595
C-23950	12 - 7525	215	82004344/1	15 - 11310	339	DJ6J	24 - 2512	591



O.E.M. REPLACEMENT CROSS REFERENCE

2014 CROSS REFERENCE

OEM #	Our #	Page #	OEM #	Our #	Page #	OEM #	Our #	Page #
CHAMPION			CHAMPION			CHAMPION		
DJ7Y	24 - 6835	589	N11YC	24 - 7311	590	RN11YC	24 - 7220	589
DJ7Y	24 - 8496	591	N9YC	24 - 7149	591	RN11YC	24 - 12553	598
DJ8J	24 - 2509	591	N9YC	24 - 12547	598	RN11YC	24 - 7189	592
DJ8J	24 - 2547	589	QC12YC	24 - 10786	591	RN11YC	24 - 2538	595
DJ8J	24 - 1289	594	QJ19LM	24 - 10788	591	RN11YC4	24 - 7189	592
G59C	24 - 10988	597	RA4HC	24 - 10998	597	RN12YC	24 - 8554	594
H10	24 - 2526	594	RA6HC	24 - 10994	597	RN14YC	24 - 12555	598
H10	24 - 2542	589	RA6HC	24 - 10990	597	RN2C	24 - 2554	596
H10	24 - 6932	591	RA6HC	24 - 10991	597	RN3C	24 - 7232	590
H10C	24 - 6932	591	RA8HC	24 - 14492	591	RN3C	24 - 8963	589
J11	24 - 2517	594	RA8HC	24 - 10992	597	RN3C	24 - 2553	596
J11C	24 - 7224	589	RBL16Y	24 - 7019	589	RN4C	24 - 8497	592
J12	24 - 2517	594	RC12YC	24 - 12312	596	RN9YC	24 - 7230	590
J17LM	24 - 2530	593	RC12YC	24 - 12431	594	RN9YC	24 - 2539	595
J17LM	24 - 2544	589	RC12YC	24 - 7229	590	RN9YC	24 - 7188	592
J17LM	24 - 2555	590	RC12YC	24 - 14559	594	RNYC	24 - 12550	598
J17LM	24 - 2505	591	RC12YC	24 - 8554	594	RS14YC	24 - 6935	592
J17LM	24 - 1294	594	RC12YC	24 - 6933	593	RS14YC	24 - 7222	589
J19LM	24 - 12544	598	RC12YC	24 - 7423	592	RS17YX	24 - 9493	592
J19LM	24 - 6877	593	RC12YC	24 - 9872	594	RS9YC	24 - 5851	596
J19LM	24 - 5936	591	RC12YC	24 - 12551	598	RV12YC	24 - 5857	596
J19LM	24 - 6595	589	RC144C	24 - 9871	596	RV15YC	24 - 5857	596
J6	24 - 2517	594	RC14YC	24 - 8495	592	RV17YC	24 - 5857	596
J6C	24 - 2517	594	RC14YC	24 - 12312	596	RV17YC	24 - 8073	592
J6J	24 - 2517	594	RC14YC	24 - 11220	593	RZ7C	24 - 10188	596
J8	24 - 12548	598	RCJ14	24 - 7190	591	UL4J	24 - 2550	590
J8	24 - 2555	590	RCJ6Y	24 - 8883	591	UL81C	24 - 2550	590
J8	24 - 2517	594	RCJ7Y	24 - 11307	591	UL81J	24 - 2550	590
J8	24 - 5860	589	RCJ7Y	24 - 8358	595	W14	24 - 8964	590
J8	24 - 2544	589	RCJ7Y	24 - 5850	595	XC10YC	24 - 14637	592
J8C	24 - 5860	589	RCJ7Y	24 - 12552	598	XC12YC	24 - 14636	592
J8C	24 - 2531	593	RCJ8	24 - 2537	595	XC92YC	24 - 12381	592
J8C	24 - 2506	591	RCJ8	24 - 11308	591	Y82	24 - 12558	598
J8J	24 - 2517	594	RCJ8	24 - 12554	598	Z94	24 - 10993	597
K13	24 - 5856	594	RCJ8Y	24 - 7190	591	Z9Y	24 - 10370	596
K15J	24 - 5856	594	RDJ7Y	24 - 10950	595			
L14	24 - 5855	594	RDZ19H	24 - 12650	592	CLINTON		
L14	24 - 7153	589	RDZ19H	24 - 9538	592	005-0233-00	19 - 1384	473
L78C	24 - 7186	591	RDZ4H	24 - 14308	592	135-13-990	31 - 1884	1078
L78C	24 - 2552	594	RH10C	24 - 9539	592	233-112-500	23 - 1453	558
L82C	24 - 2550	590	RJ12C	24 - 8571	592	233-113-500	23 - 1455	560
L82C	24 - 7187	591	RJ14YC	24 - 7021	596	265-278-500	26 - 1329	629
L86C	24 - 7150	591	RJ17LM	24 - 11309	592	291-55	22 - 1409	544
L86C	24 - 7153	589	RJ17LM	24 - 14560	596	291-57	22 - 1409	544
L86C	24 - 2536	594	RJ18YC	24 - 8054	592	293-3	20 - 1347	34
L90	24 - 5855	594	RJ19LM	24 - 7225	589	293-32-5	20 - 1347	34
L90	24 - 7153	589	RJ19LM	24 - 9536	593	293-32-500	20 - 1348	508
L92YC	24 - 5858	595	RJ19LM	24 - 6934	592	94-176-990	23 - 1441	556
L92YC	24 - 7231	589	RL82C	24 - 10999	596			
L92YC	24 - 5852	595	RL82YC	24 - 10989	597	CLUB CAR		
N11YC	24 - 2534	595	RL86C	24 - 7153	589	1015426	19 - 8331	458
N11YC	24 - 12543	598	RL95YC	24 - 10997	597	102558201	19 - 9550	459
N11YC	24 - 7868	591	RL95YC	24 - 9535	592			

O.E.M. REPLACEMENT CROSS REFERENCE



CROSS REFERENCE 2014

OEM #	Our #	Page #	OEM #	Our #	Page #	OEM #	Our #	Page #
COMET			CUB CADET			CUB CADET		
12-083-05	19 - 12935	449	01002072	15 - 6240	341	464362-R1	12 - 7525	215
200393	12 - 13241	225	01002108P	10 - 11072	165	465003-R91	09 - 484	133
203578A	12 - 13048	225	01004081	13 - 12276	273	473468-R2	12 - 7515	215
203580A	12 - 13054	225	01004101	13 - 12277	273	475595-R1	12 - 7470	215
203581A	12 - 13047	225	01004719-0637	15 - 10383	342	475610-R1	12 - 7433	214
203582	12 - 13242	226	01004772	15 - 11564	341	477589-R3	15 - 6075	340
203583A	12 - 13052	226	01005380	15 - 10362	342	477597-R3	15 - 6077	343
203584A	12 - 13088	226	01007015	12 - 12850	228	477598-R3	15 - 6075	340
203585A	12 - 13059	226	01008386	31 - 14247	1068	477599-R2	12 - 7520	215
203586A	12 - 13058	226	01008386P	31 - 14247	1068	478263-R91	12 - 7602	216
203589A	12 - 8487	226	01008616	15 - 11805	340	481-00-R2	12 - 5116	212
203590A	12 - 13053	226	01010168	15 - 11250	342	481099-R1	12 - 7526	215
203591	12 - 10052	226	01010168-0637	15 - 11250	342	481099-R2	12 - 7526	215
203592	12 - 13243	226	02000103	12 - 10830	226	485610-R1	12 - 7481	215
203593A	12 - 13050	226	02000154	12 - 12708	228	487043-R1	12 - 7433	214
203597	12 - 10042	239	02003622	10 - 14437	159	487994-R1	12 - 7480	215
203597A	12 - 10042	239	02004447	13 - 12277	273	487996-R1	12 - 7478	215
203783A	12 - 13627	226	02005017	15 - 10361	341	488077-R1	12 - 7491	215
203784	12 - 13592	226	02005018	15 - 10362	342	488082-R1	12 - 7495	215
203785A	12 - 13057	226	02005019	15 - 10363	342	488082-R2	12 - 7495	215
209748A	04 - 456	81	02005020	15 - 11805	340	488619-R1	19 - 1390	479
209760A	04 - 455	81	02005077	13 - 12276	273	489397-R1	12 - 7520	215
209768A	04 - 457	81	02005079	13 - 12275	273	489397-R3	12 - 7520	215
215654	04 - 13989	81	1004719	15 - 10383	342	490-201-0001	19 - 12864	450
215654	04 - 13990	81	1005336	15 - 10361	341	490471-R1	15 - 6075	340
217775A	04 - 13989	81	1005337	15 - 10362	342	490473-R1	15 - 6077	343
217775A	04 - 13990	81	1005338	15 - 10363	342	490489-C1	12 - 7524	215
219462	04 - 13990	81	106465-C1	12 - 7494	215	490489-R1	12 - 7524	215
219462	04 - 13989	81	106990-C1	12 - 7488	215	490489-R2	12 - 10830	226
219559	04 - 13988	81	106991-C1	12 - 7498	215	491395-R1	13 - 723	36
884-100	12 - 13088	226	117210-C1	19 - 2774	473	492102-R1	12 - 12233	255
			126496-C1	12 - 7476	215	492103-R1	12 - 7648	216
			132013-C1	12 - 7473	215	49364-R1	12 - 7516	215
COMMERCIAL TURF PROD			132407-C1	12 - 7512	215	493650-R1	12 - 7493	215
1001717	31 - 9664	1066	135462-C1	12 - 7638	216	4L420	12 - 5075	212
12242	31 - 9659	1066	140080-C91	12 - 7475	215	52-05025	19 - 12863	450
18324	31 - 9658	1066	144409-C1	12 - 7637	216	52-05025	19 - 5909	483
			1759-3359	19 - 1388	472	5205025	19 - 12863	450
COUNTRY CLIPPER			17620268013	20 - 10018	513	5205025	19 - 5909	483
C28971	09 - 7162	134	1768882	31 - 9666	1066	542520-R91	13 - 726	36
C28971	09 - 10303	135	19-7810984	12 - 7482	215	547191-R1	15 - 6078	343
E-6247	10 - 11071	164	214878-C1	12 - 7441	214	548436-R1	19 - 1385	474
E-6444	10 - 14189	166	214878-R1	12 - 7441	214	549107-R1	12 - 7482	215
H-1666	15 - 6185	400	251428-R1	12 - 7576	216	549108-R1	12 - 7481	215
H-1667	15 - 6167	359	351321-R1	12 - 5054	212	549599-R1	12 - 7497	215
H-2122	15 - 6311	324	384881-R94	09 - 6573	133	549609-R1	12 - 7493	215
H-2203	15 - 6311	324	385163-R2	19 - 1384	473	549714-R1	12 - 12246	260
H1885	10 - 9311	173	385168-R2	19 - 1386	470	549821-R1	12 - 7474	215
			386160-R1	12 - 7438	214	549822-R1	12 - 7511	215
CUB CADET			393840-R91	18 - 8284	442	56235-C1	12 - 7511	215
00030353	42 - 14185	1231	40041	12 - 7483	215	56629-C1	12 - 8820	260
01000152	42 - 14178	1232	455102-R21	09 - 8488	135	586609-R92	09 - 8488	135
01000152P	42 - 14178	1232	464351-R1	12 - 7473	215	58663-C1	12 - 7514	215
01000399	12 - 7550	215						



O.E.M. REPLACEMENT CROSS REFERENCE

2014 CROSS REFERENCE

OEM #	Our #	Page #	OEM #	Our #	Page #	OEM #	Our #	Page #
CUB CADET			CUB CADET			CUB CADET		
59003-C1	12 - 7487	215	710-1889	10 - 12622	178	742-04053B	15 - 11480	341
59004-C1	12 - 7483	215	712-3022	10 - 8447	178	742-04053B	15 - 11507	341
59636-C1	12 - 7473	215	712-3022	10 - 8447	178	742-04053C	15 - 11507	341
59701-C1	12 - 7520	215	717-04163	10 - 11859	165	742-04053C	15 - 11480	341
59702-C1	12 - 7528	215	717-04174	10 - 12621	165	742-04068	15 - 11479	341
60069-C91	09 - 8488	135	717-04183	10 - 14327	169	742-04068	15 - 11506	341
60071-C91	09 - 8488	135	717-04552	10 - 14229	166	742-04101	15 - 11475	343
61083-C1	12 - 7475	215	717-1434	10 - 9910	164	742-04124	15 - 1030	340
61084-C1	12 - 7502	215	717-1459	10 - 9911	164	742-04125	15 - 1029	385
61606C	19 - 1388	472	717-3384	10 - 12230	165	742-04126	15 - 1032	386
618-0324	10 - 12883	188	717-3385A	10 - 12231	165	742-04126	15 - 11233	386
618-0324A	10 - 12883	188	717-3389	10 - 12230	165	742-04154	15 - 12909	342
618-04123B	10 - 12236	188	717-3390	10 - 14045	166	742-04290	15 - 12956	386
618-04124A	10 - 13001	188	717-3403	10 - 12228	165	742-04308	15 - 1031	386
618-04125	10 - 11962	187	717-3446	10 - 13973	165	742-0616	15 - 1032	386
618-04126	10 - 11962	187	717-3497	10 - 12227	165	742-0616	15 - 11233	386
618-04126A	10 - 11962	187	719-3118A	10 - 11961	187	742-0616	15 - 1031	386
618-04129A	10 - 11963	187	723-04032A	19 - 8631	484	742-0656	15 - 1031	386
618-04129B	10 - 11963	187	723-0448	10 - 9159	174	742-0677A	15 - 11719	342
618-0427A	10 - 12883	188	723-3014	19 - 6680	484	742-0677B	15 - 11719	342
618-0427A	10 - 12883	188	725-04040	31 - 14246	1067	742-0739	15 - 12893	342
618-0427C	10 - 12883	188	725-04175	31 - 14323	1065	742-0741	15 - 6423	387
618-04394	10 - 11961	187	725-04227	31 - 7015	1060	742-0741A	15 - 6423	387
618-04426	10 - 11961	187	725-04227A	31 - 7015	1060	742-0742	15 - 6424	387
618-04456	10 - 13131	188	725-04227B	31 - 7015	1060	742-0742A	15 - 6424	387
618-04456A	10 - 13131	188	725-04258	31 - 13106	1065	742-3002	15 - 6081	340
618-04461	10 - 13131	188	725-05013	31 - 14331	1067	742-3003	15 - 6082	341
618-04461A	10 - 13131	188	725-0893	31 - 12757	1065	742-3008	15 - 6147	342
618-04608A	10 - 12612	195	725-0893P	31 - 12757	1065	742-3009	15 - 6238	342
618-04636	10 - 13029	188	725-1716	31 - 11470	1065	742-3013	15 - 6239	342
618-04636A	10 - 13029	188	725-3001	31 - 12792	1071	742-3018	15 - 6237	343
618-04822A	10 - 14328	187	725-3163	31 - 12752	1059	742-3019	15 - 6240	341
618-04825	10 - 14329	187	725-3164	31 - 9665	1066	742-3032	15 - 11477	342
618-04950	10 - 14328	187	725-3164AP	31 - 9665	1066	742-3033	15 - 11475	343
618-05016	10 - 14329	187	725-3166	31 - 9664	1066	742-4125	15 - 1029	385
618-0595	10 - 12972	189	725-3233	31 - 12762	1065	746-04066	03 - 14325	57
618-0595A	10 - 12972	189	734-04155	07 - 12648	104	746-04120	03 - 14324	57
618-0595B	10 - 12972	189	734-3000	07 - 3320	106	746-04214	03 - 14621	58
618-0625B	10 - 12967	188	734-3000	07 - 6918	104	746-1085A	03 - 14624	59
618-0659	10 - 12973	188	734-3058B	07 - 6916	106	751-3012	12 - 7475	215
618-0659A	10 - 12973	188	734-3195	06 - 11956	100	751-3013	20 - 6000	46
618-0660	10 - 12967	188	7343195A	06 - 11956	100	7511034916	12 - 7475	215
618-0677	10 - 11961	187	738-3056	10 - 11142	179	753-04856A	07 - 6916	106
618-3129A	10 - 11961	187	73806-C1	12 - 7436	214	754-0101A	12 - 10089	233
618-3129B	10 - 11961	187	741-04129	10 - 11961	187	754-0197	12 - 9900	235
618-3129C	10 - 11961	187	741-04130	10 - 11961	187	754-0240	12 - 6907	235
619-04183A	10 - 12871	188	741-0990A	09 - 12857	146	754-0241	12 - 6906	233
619-04199	10 - 12871	188	741-0990B	09 - 12857	146	754-0241A	12 - 6906	233
61904183B	10 - 12871	188	742-04015	15 - 11478	341	754-0264	12 - 7169	233
634-3159	07 - 14446	103	742-04016	15 - 11476	340	754-0266	12 - 6838	233
651814-R1	09 - 813	133	742-04053	15 - 11507	341	754-0271	12 - 9901	235
651815-R91	09 - 813	133	742-04053A	15 - 11480	341	754-0280	12 - 6839	233
710-04226	10 - 12622	178	742-04053A	15 - 11507	341	754-0281	12 - 6840	233

O.E.M. REPLACEMENT CROSS REFERENCE



CROSS REFERENCE 2014

OEM #	Our #	Page #	OEM #	Our #	Page #	OEM #	Our #	Page #
CUB CADET			CUB CADET			CUB CADET		
754-0293	12 - 6841	233	754-0467A	12 - 11482	236	754-3084	12 - 10901	228
754-0329A	12 - 6842	236	754-0468	12 - 11483	236	756-0226	13 - 734	36
754-0346	12 - 6950	233	754-0472	12 - 9935	234	756-04129	13 - 9377	269
754-0347	12 - 7506	215	754-0474	12 - 10261	236	756-04141	13 - 13409	273
754-0349	12 - 6843	233	754-0476	12 - 10260	236	756-04216	13 - 11711	273
754-0350	12 - 6844	233	754-0483	12 - 11135	236	756-04224	13 - 2188	263
754-0355	12 - 6949	235	754-0485	12 - 10009	235	756-04325	13 - 14326	280
754-0358	12 - 9570	233	754-0486	12 - 10100	236	756-04325	13 - 731	36
754-0362	12 - 9482	235	754-0486A	12 - 10100	236	756-0542	13 - 14091	280
754-0370	12 - 6908	235	754-0497	12 - 11019	236	756-0981A	13 - 2188	263
754-0371	12 - 6845	235	754-0498	12 - 10369	237	756-0981A	13 - 12891	281
754-0371A	12 - 6845	235	754-0637A	12 - 11137	237	756-0981B	13 - 12891	281
754-04001	12 - 10831	235	754-0640	12 - 11849	227	756-1188	13 - 12884	273
754-04001A	12 - 10831	235	754-0641	12 - 11850	227	756-1227	13 - 12682	273
754-04002	12 - 10833	235	754-0642	12 - 11661	237	756-1229	13 - 13409	273
754-04032	12 - 13232	233	754-0644	12 - 10783	228	756-3003	13 - 734	36
754-04032A	12 - 13232	233	754-0645	12 - 10784	228	756-3003	13 - 5869	263
754-04032B	12 - 13232	233	754-3000	12 - 7476	215	756-3045	13 - 12275	273
754-04033	12 - 11843	227	754-3004	12 - 7521	215	756-3062	13 - 14090	280
754-04041	12 - 12610	234	754-3005	12 - 7529	215	75604129B	13 - 9377	269
754-04043	12 - 12382	235	754-3006	12 - 7638	216	75604522	13 - 12275	273
754-04043A	12 - 12382	235	754-3007	12 - 7503	215	759-04019	15 - 11478	341
754-04044	12 - 11844	227	754-3008	12 - 7475	215	759-04020	15 - 11476	340
754-04045	12 - 11845	227	754-3009	12 - 7511	215	759-04020	15 - 11476	340
754-04048	12 - 12667	233	754-3010	12 - 7473	215	759-04047	15 - 11506	341
754-04060	12 - 11660	236	754-3011	12 - 7512	215	759-04047	15 - 11479	341
754-04060B	12 - 11660	236	754-3012	12 - 7475	215	759-04081	15 - 6237	343
754-04062	12 - 11846	227	754-3014	12 - 7482	215	759-3547	19 - 2774	473
754-04064	12 - 11840	227	754-3015	12 - 7492	215	759-3812	15 - 6081	340
754-04077	12 - 11847	227	754-3016	12 - 7494	215	759-3813	15 - 6082	341
754-04083	12 - 11661	237	754-3017	12 - 7498	215	759-3816	15 - 6147	342
754-04101	12 - 11137	237	754-3019	12 - 7514	215	759-3817	15 - 6238	342
754-04118	12 - 12609	227	754-3020	12 - 7488	215	759-3820	15 - 6239	342
754-04122	12 - 11848	234	754-3023	12 - 7639	216	759-3824	15 - 6237	343
754-04138	12 - 12768	227	754-3024	12 - 7534	215	759-3825	15 - 6240	341
754-04142	12 - 12489	234	754-3025	12 - 7520	215	759-3829	15 - 11477	342
754-04153	12 - 12769	227	754-3026	12 - 7503	215	759-3830	15 - 11475	343
754-04185	12 - 12873	227	754-3026A	12 - 7503	215	759-3841	15 - 6239	342
754-04219	12 - 12790	234	754-3027	12 - 7529	215	759-3843	15 - 6077	343
754-04240	12 - 12791	234	754-3028	12 - 7521	215	759-3844	15 - 6075	340
754-0430	12 - 12429	235	754-3029	12 - 7502	215	759-3848	15 - 6075	340
754-0430A	12 - 12429	235	754-3030	12 - 7502	215	759-3850	15 - 6077	343
754-0430B	12 - 12429	235	754-3036	12 - 10781	228	759-3853	15 - 6078	343
754-0433	12 - 6842	236	754-3037	12 - 7523	215	759-3939	15 - 10636	341
754-0439	12 - 9119	234	754-3038	12 - 10563	228	759-4047	15 - 11506	341
754-0440	12 - 9120	234	754-3038	12 - 7503	215	759-4047	15 - 11479	341
754-0441	12 - 9847	234	754-3039	12 - 12051	228	764-0645A	12 - 10784	228
754-0446	12 - 9932	234	754-3047	12 - 7641	216	917-04163A	10 - 11859	165
754-0453	12 - 9480	236	754-3051A	12 - 10232	224	917-04174A	10 - 12621	165
754-0460	12 - 11132	236	754-3055A	12 - 11997	227	917-04180	10 - 12899	165
754-0461	12 - 9903	236	754-3055A	12 - 11997	227	917-04183	10 - 14327	169
754-0465	12 - 13232	233	754-3068	12 - 11820	228	917-04197A	10 - 12883	188
754-0467	12 - 11482	236	754-3073	12 - 10782	228	917-04552A	10 - 14229	166



O.E.M. REPLACEMENT CROSS REFERENCE

2014 CROSS REFERENCE

OEM #	Our #	Page #	OEM #	Our #	Page #	OEM #	Our #	Page #
CUB CADET			CUB CADET			CUB CADET		
917-04622	10 - 14327	169	91804822	10 - 14328	187	942-0677B	15 - 11719	342
917-0949	10 - 9910	164	9180593A	10 - 12972	189	942-0739	15 - 12893	342
917-1434	10 - 9910	164	9180595	10 - 12972	189	942-0741	15 - 6423	387
917-1459	10 - 9911	164	923-3014	19 - 6680	484	942-0741A	15 - 6423	387
917-3384	10 - 12230	165	9230448A	10 - 9159	174	942-0742	15 - 6424	387
917-3385B	10 - 12231	165	925-04175	31 - 14323	1065	94204154A	15 - 12909	342
917-3389	10 - 12230	165	925-04227	31 - 7015	1060	94204290	15 - 12956	386
917-3390	10 - 14045	166	925-04227A	31 - 7015	1060	94204415	15 - 10363	342
917-3403	10 - 12228	165	925-04227B	31 - 7015	1060	94204416	15 - 10362	342
917-3497	10 - 12227	165	925-05013	31 - 14331	1067	94204417	15 - 10361	341
91704552	10 - 14229	166	925-0893	31 - 12757	1065	9420742A	15 - 6424	387
9173446	10 - 13973	165	925-1716	31 - 11470	1065	946-04214	03 - 14621	58
918-0324	10 - 12883	188	925-3001	31 - 12792	1071	946-04618A	05 - 14341	73
918-0324A	10 - 12883	188	925-3163	31 - 12752	1059	946-1085A	03 - 14624	59
918-04123B	10 - 12236	188	925-3164A	31 - 9665	1066	9513013	20 - 6000	46
918-04124A	10 - 13001	188	925-3166	31 - 9664	1066	954-0101A	12 - 10089	233
918-04125A	10 - 11962	187	925-3233	31 - 12762	1065	954-0197	12 - 9900	235
918-04125B	10 - 11962	187	92504040	31 - 14246	1067	954-0240	12 - 6907	235
918-04126	10 - 11962	187	92504165	31 - 14247	1068	954-0241	12 - 6906	233
918-04126A	10 - 11962	187	934-3000	07 - 6918	104	954-0241A	12 - 6906	233
918-04129A	10 - 11963	187	938-3056	10 - 11142	179	954-0264	12 - 7169	233
918-04129B	10 - 11963	187	941-04089	10 - 11961	187	954-0266	12 - 6838	233
918-04197	10 - 12883	188	941-04089	09 - 813	133	954-0266A	12 - 7528	215
918-0427	10 - 12883	188	941-04091	10 - 11961	187	954-0271	12 - 9901	235
918-0427A	10 - 12883	188	942-04053-X	15 - 12809	342	954-0280	12 - 6839	233
918-0427C	10 - 12883	188	942-04053A	15 - 11507	341	954-0281	12 - 6840	233
918-0427D	10 - 12883	188	942-04053A	15 - 12809	342	954-0293	12 - 6841	233
918-04394	10 - 11961	187	942-04053A	15 - 11480	341	954-0329A	12 - 6842	236
918-04426	10 - 11961	187	942-04053B	15 - 11507	341	954-0346	12 - 6950	233
918-04456	10 - 13131	188	942-04053B	15 - 11480	341	954-0349	12 - 6843	233
918-04461	10 - 13131	188	942-04053B	15 - 12809	342	954-0350	12 - 6844	233
918-04636	10 - 13029	188	942-04053C	15 - 12809	342	954-0355	12 - 6949	235
918-04822	10 - 14328	187	942-04053C	15 - 11480	341	954-0358	12 - 9570	233
918-04822A	10 - 14328	187	942-04053C	15 - 11507	341	954-0362	12 - 9482	235
918-04825B	10 - 14329	187	942-04068	15 - 11506	341	954-0370	12 - 6908	235
918-04865	10 - 13029	188	942-04068	15 - 11479	341	954-0371	12 - 6845	235
918-04865A	10 - 13029	188	942-04124	15 - 1030	340	954-0371A	12 - 6845	235
918-04889A	10 - 14328	187	942-04125	15 - 1029	385	954-04001	12 - 10831	235
918-05016	10 - 14329	187	942-04126	15 - 1032	386	954-04001A	12 - 10831	235
918-0595A	10 - 12972	189	942-04126	15 - 11233	386	954-04002	12 - 10833	235
918-0595B	10 - 12972	189	942-04126	15 - 1031	386	954-04032	12 - 13232	233
918-0624A	10 - 12973	188	942-04126-X	15 - 11233	386	954-04032A	12 - 13232	233
918-0625B	10 - 12967	188	942-04154	15 - 12909	342	954-04032B	12 - 13232	233
918-0659	10 - 12973	188	942-04308	15 - 1031	386	954-04033	12 - 11843	227
918-0659A	10 - 12973	188	942-04308-X	15 - 11233	386	954-04041	12 - 12610	234
918-0660	10 - 12967	188	942-04312	15 - 1031	386	954-04043	12 - 12382	235
918-0671	10 - 12612	195	942-0616-X	15 - 11233	386	954-04043A	12 - 12382	235
918-3129A	10 - 11961	187	942-0616A	15 - 1032	386	954-04044	12 - 11844	227
918-3129B	10 - 11961	187	942-0616A	15 - 11233	386	954-04044A	12 - 11844	227
918-3129C	10 - 11961	187	942-0616A	15 - 1031	386	954-04045	12 - 11845	227
91804197A	10 - 12883	188	942-0656	15 - 1031	386	954-04048	12 - 12667	233
91804456A	10 - 13131	188	942-0677	15 - 11719	342	954-04060	12 - 11660	236
91804608A	10 - 12612	195	942-0677A	15 - 11719	342	954-04060B	12 - 11660	236

O.E.M. REPLACEMENT CROSS REFERENCE



CROSS REFERENCE 2014

OEM #	Our #	Page #	OEM #	Our #	Page #	OEM #	Our #	Page #
CUB CADET			CUB CADET			DENSO		
954-04062	12 - 11846	227	954-3016	12 - 7494	215	K16PR-U11	24 - 14559	594
954-04064	12 - 11840	227	954-3017	12 - 7498	215	Q16PR-U	24 - 14636	592
954-04077	12 - 11847	227	954-3019	12 - 7514	215	Q16PR-U	24 - 12551	598
954-04083	12 - 11661	237	954-3020	12 - 7488	215	T20M-U	24 - 2509	591
954-04118	12 - 12609	227	954-3023	12 - 7639	216	T20MPU	24 - 10950	595
954-04122	12 - 11848	234	954-3024	12 - 7534	215	U20MU	24 - 11571	596
954-04138A	12 - 12768	227	954-3025	12 - 7520	215	U20MU	24 - 12558	598
954-04142	12 - 12489	234	954-3026A	12 - 7530	215	W14-U	24 - 12548	598
954-04153	12 - 12769	227	954-3027	12 - 7529	215	W14EPR-U	24 - 12555	598
954-04219	12 - 12790	234	954-3028	12 - 7521	215	W14LM-U	24 - 12544	598
954-04240	12 - 12791	234	954-3030	12 - 7502	215	W14LMR-US	24 - 14560	596
954-0430	12 - 12429	235	954-3036	12 - 10781	228	W16EPR-U	24 - 12553	598
954-0430A	12 - 12429	235	954-3037	12 - 7523	215	W16EX-U	24 - 12543	598
954-0430B	12 - 12429	235	954-3038	12 - 10563	228	W20EPR-U	24 - 12550	598
954-0433	12 - 6842	236	954-3038	12 - 7503	215	W20EX-U	24 - 12547	598
954-0439	12 - 9119	234	954-3039	12 - 12051	228	W20M-U	24 - 12542	598
954-0440	12 - 9120	234	954-3047	12 - 7641	216	W20MP-U	24 - 12546	598
954-0441	12 - 9847	234	954-3055A	12 - 11997	227	W20MR-U	24 - 12554	598
954-0446	12 - 9932	234	954-3068	12 - 11820	228	W22M-U	24 - 12549	598
954-0453	12 - 9480	236	954-3073	12 - 10782	228	W22MP-U	24 - 12545	598
954-0460	12 - 11132	236	954-3084	12 - 10901	228	W22MPR-U	24 - 12552	598
954-0461	12 - 9903	236	9540266A	12 - 6838	233	DIXIE CHOPPER		
954-0465	12 - 13232	233	9540280A	12 - 6839	233	10202	08 - 9573	113
954-0467	12 - 11482	236	9540347	12 - 7506	215	10202	08 - 11062	110
954-0467A	12 - 11482	236	95404033A	12 - 11843	227	10202	08 - 9501	110
954-0468	12 - 11483	236	95404043B	12 - 12382	235	10202	08 - 9763	112
954-0472	12 - 9935	234	95404153A	12 - 12769	227	10203	09 - 9606	143
954-0474	12 - 10261	236	95404185	12 - 12873	227	10205	09 - 7950	131
954-0476	12 - 10260	236	9540645A	12 - 10784	228	10220	09 - 10665	148
954-0483	12 - 11135	236	9543051A	12 - 10232	224	10222	10 - 9908	172
954-0485	12 - 10009	235	956-04129	13 - 12675	281	10239	08 - 10700	116
954-0486	12 - 10100	236	956-04129	13 - 9377	269	200031	13 - 13423	274
954-0486A	12 - 10100	236	956-0981	13 - 12891	281	2000B64	12 - 11503	243
954-0497	12 - 11019	236	956-1227	13 - 12682	273	200238	13 - 13424	274
954-0498	12 - 10369	237	956-3045	13 - 12275	273	2006A62R	12 - 13366	243
954-0637A	12 - 11137	237	964-0645A	12 - 10784	228	2006A96R	12 - 10022	243
954-0640	12 - 11849	227	BS-298090S	20 - 6000	46	2006B112R	12 - 10033	244
954-0641	12 - 11850	227	IH-132496-C1	13 - 5869	263	2006B130R	12 - 10034	244
954-0642	12 - 11661	237	IH-492102-R1	12 - 12233	255	2006B144R	12 - 12443	244
954-0644	12 - 10783	228	IH-549714-R1	12 - 12246	260	2006B160R	12 - 12452	244
954-0645	12 - 10784	228	IH-60071-C91	09 - 8488	135	2006B41R	12 - 10025	243
954-3000	12 - 7476	215	IH60071C92	09 - 8488	135	2006B44R	12 - 12239	243
954-3004	12 - 7521	215	KH-47-883-01-S1	19 - 2774	473	2006B57R	12 - 11223	243
954-3005	12 - 7529	215	WD-C38410	10 - 9913	164	2006B80R	12 - 10029	243
954-3006	12 - 7638	216	WDC47449	10 - 9913	164	2006B85R	12 - 10032	244
954-3007	12 - 7503	215	YS-7563003	13 - 5869	263	2006B85W	12 - 10032	244
954-3008	12 - 7475	215				2006B87R	12 - 12751	244
954-3009	12 - 7511	215	DAYCO			2006B88	12 - 11502	244
954-3010	12 - 7473	215	B38	12 - 11483	236	2006B88W	12 - 11502	244
954-3011	12 - 7512	215				2006B92R	12 - 11225	244
954-3012	12 - 7475	215	DELCO			2006B92W	12 - 11225	244
954-3014	12 - 7482	215	1118988	31 - 1927	1078	2006B94R	12 - 11226	244
954-3015	12 - 7492	215						



O.E.M. REPLACEMENT CROSS REFERENCE

2014 CROSS REFERENCE

OEM #	Our #	Page #	OEM #	Our #	Page #	OEM #	Our #	Page #
DIXIE CHOPPER			DIXIE CHOPPER			DIXIE CHOPPER		
2006B98R	12 - 12442	244	30227-66X	15 - 12616	344	9907B130	12 - 10034	244
2006B99R	12 - 12238	244	30227-72H	15 - 6404	334	9907B41	12 - 10025	243
2006B99W	12 - 12238	244	30227-72N	15 - 6833	334	9907B57	12 - 11223	243
2008B100R	12 - 13456	244	30227-H	15 - 6224	343	9907B84	12 - 10814	243
2008B87W	12 - 12751	244	30227N	15 - 6442	343	9907B85	12 - 10032	244
2008B89R	12 - 12983	244	30234	13 - 9895	274	9907B92	12 - 11225	244
2008B97R	12 - 13219	244	30236-0B128	12 - 10011	244	9907B94	12 - 11226	244
2010B100W	12 - 13456	244	400053	08 - 11061	110	A89	12 - 10035	243
2010B41W	12 - 10025	243	400053	08 - 10789	110	A96	12 - 10022	243
2010B44W	12 - 12239	243	400129	08 - 11061	110	B103	12 - 10036	244
2010B87W	12 - 12751	244	400130	08 - 10915	110	B112	12 - 10033	244
2010B98W	12 - 12442	244	400200	21 - 12521	525	B128	12 - 10011	244
2010B99W	12 - 12238	244	400275	09 - 13418	132	B130	12 - 10034	244
20214	10 - 9142	174	400293	21 - 12512	525	B162	12 - 10010	244
20245	31 - 2922	1062	400321	21 - 12512	525	B38	12 - 10023	243
20256B38	12 - 10023	243	40222	20 - 12074	515	B40	12 - 10024	243
300037	13 - 13426	274	500012	10 - 12835	168	B41	12 - 10025	243
300401	13 - 13413	274	500017	31 - 9655	1060	B42	12 - 10026	243
300440	10 - 12806	189	500056	10 - 14353	166	B44	12 - 12239	243
300441	10 - 12807	189	500062	10 - 12923	168	B57	12 - 11223	243
300442	10 - 12808	189	50300	10 - 11070	170	B64	12 - 11503	243
30203B103	12 - 10036	244	600035	20 - 12084	514	B78	12 - 10027	243
30204B78	12 - 10027	243	60105	19 - 12862	450	B80	12 - 10029	243
30217	10 - 9949	189	60105	19 - 7916	483	B81	12 - 10030	243
30217-L	10 - 9950	189	6092	15 - 1100	345	B82	12 - 10031	243
30218	09 - 8488	135	63203A89	12 - 10035	243	B84	12 - 10814	243
30218	09 - 9937	135	63204B42	12 - 10026	243	B85	12 - 10032	244
30219	10 - 10081	175	63227-H	15 - 6020	343	B88	12 - 11502	244
30224	13 - 9891	271	63227-N	15 - 6020	343	B92	12 - 11225	244
30226-66E	15 - 13987	344	65070	05 - 12092	94	B94	12 - 11226	244
30227-42	15 - 6316	321	65071	05 - 12093	94	B99	12 - 12238	244
30227-42	15 - 6020	343	65080B80	12 - 10029	243	C158	12 - 10815	244
30227-50	15 - 3372	343	65244	05 - 11508	90	N-167	10 - 10559	177
30227-50	15 - 6298	322	67204	09 - 9709	142	OE3557	19 - 9583	468
30227-50V	15 - 6790	343	67204	08 - 9809	110	OE3656	19 - 9728	468
30227-50V	15 - 6298	322	68081B81	12 - 10030	243	S-114	10 - 13296	158
30227-50V	15 - 3372	343	68082B82	12 - 10031	243	W-137	10 - 10560	177
30227-52T	15 - 3374	338	68140	19 - 7916	483	W101	17 - 9531	434
30227-52X	15 - 11557	370	68140	19 - 9464	484			
30227-52X	15 - 11556	370	68140	19 - 12862	450	DIXON		
30227-56H	15 - 13419	344	68162B162	12 - 10010	244	17080	08 - 10461	111
30227-56T	15 - 13419	344	68249	03 - 12053	58	17080	08 - 10742	110
30227-56X	15 - 13419	344	68250	03 - 10951	58	17080	08 - 8551	111
30227-60	15 - 6083	344	90122	19 - 8328	474	3579	10 - 9911	164
30227-60	15 - 6303	324	97166	08 - 9573	113	539-103258	13 - 12474	278
30227-60H	15 - 6441	344	97171	09 - 9951	135	539115242	15 - 6101	346
30227-60V	15 - 6303	324	97319	13 - 13502	274	539115278	13 - 9378	275
30227-60V	15 - 6083	344	97345B40	12 - 10024	243	539115279	09 - 8488	135
30227-62T	15 - 14442	344	97346C158	12 - 10815	244	539115802	31 - 9659	1066
30227-62X	15 - 14442	344	97392	20 - 12313	496	539116199	12 - 7525	215
30227-62X	15 - 14467	344	9907525X100S	13 - 13427	274	539116199	12 - 5115	212
30227-66H	15 - 12616	344	9907A96	12 - 10022	243	539116199	12 - 5205	213
30227-66T	15 - 12616	344	9907B112	12 - 10033	244	539116200	12 - 8509	245

O.E.M. REPLACEMENT CROSS REFERENCE



CROSS REFERENCE 2014

OEM #	Our #	Page #	OEM #	Our #	Page #	OEM #	Our #	Page #
DIXON			DIXON INDUSTRIES			DIXON INDUSTRIES		
539116200	12 - 7623	216	539116199	12 - 5115	212	61516	10 - 11071	164
539116837	09 - 6573	133	539116200	12 - 5205	213	6236	15 - 1100	345
539116898	09 - 8437	132	539116200	12 - 8509	245	6236	15 - 6086	345
539117197	09 - 6573	133	539116200	12 - 7623	216	6897	15 - 6785	322
539117238	31 - 9656	1064	539116800	09 - 9008	138	7252	19 - 9464	484
539119854	15 - 6312	321	539116801	09 - 8433	138	8178	09 - 9008	138
539124267	12 - 7486	215	539116802	09 - 9009	138	8179	09 - 8433	138
539124278	13 - 9379	275	539117174	15 - 6766	345	8180	09 - 9009	138
539124487	12 - 7619	216	539119853	15 - 6087	345	8600	15 - 6312	321
539124489	12 - 5171	213	539119854	15 - 6086	345	8688	15 - 6087	345
539124501	12 - 7489	215	539119854	15 - 1100	345	9229	15 - 1066	345
539125652	15 - 6312	321	539119863	15 - 6766	345	9258	15 - 6298	322
539127651	08 - 10461	111	539119864	15 - 6782	345	9265	15 - 6298	322
539129512	31 - 9656	1064	539119867	15 - 6785	322	9265	15 - 6088	345
539129630	09 - 6573	133	539119868	15 - 6784	346	9383	15 - 6303	324
8167	09 - 6573	133	539119871	15 - 6303	324	9383	15 - 6180	334
9543	09 - 6573	133	539119871	15 - 6180	334	9443	15 - 6782	345
			539120023	31 - 9656	1064	9444	15 - 6766	345
			539124213	12 - 7586	216	9445	15 - 6784	346
			539124267	12 - 7486	215			
DIXON INDUSTRIES			539124278	13 - 9379	275	DOLMAR		
12421	15 - 6180	334	539124487	12 - 7619	216	119-163-010	37 - 3060	1181
12421	15 - 6303	324	539124489	12 - 5171	213	123 163 010	37 - 3061	1181
1324	15 - 6101	346	539124501	12 - 7489	215	144 163 010	37 - 3060	1181
13368	15 - 6784	346	539125960	19 - 9464	484	326173080	39 - 13135	488
1351	15 - 6084	346	539126275	15 - 6087	345	391-173-010	39 - 9957	491
13938	15 - 6087	345	539126276	15 - 1066	345	391-173-030	39 - 9958	491
13939	15 - 6086	345	539126431	15 - 6088	345	394-173-020	39 - 13583	491
13939	15 - 1100	345	539128711	10 - 11071	164	395-173-010	19 - 13394	493
13948	15 - 6766	345	539129512	31 - 9656	1064	PS-340	38 - 13489	1196
13949	15 - 6782	345	539129519	15 - 6312	321			
13952	15 - 6785	322	539129543	15 - 6312	321	DONALDSON		
13953	15 - 6784	346	539129580	15 - 6785	322	P822858	19 - 9728	468
13956	15 - 6303	324	539129683	15 - 6312	321			
13956	15 - 6180	334	539129741	15 - 1066	345	E-Z ROLL		
1539	12 - 7586	216	539129743	15 - 6298	322	22-0064	12 - 5013	211
1684	12 - 7486	215	539129747	15 - 6303	324	A-209	12 - 5177	213
1687	13 - 9378	275	539129747	15 - 6180	334	A-211	12 - 5180	213
1701	09 - 8488	135	539129747	15 - 6180	334	S-333	12 - 5055	212
1713	13 - 9379	275	539129748	15 - 6782	345	S-335	12 - 5063	212
2412	12 - 7619	216	539129749	15 - 6784	346			
2426	12 - 5171	213	539129775	15 - 6303	324	E.T.RUGG		
2469	12 - 7489	215	539129775	15 - 6180	334	10858	13 - 729	36
4242	31 - 9659	1066	539129786	15 - 6784	346	21101	13 - 2176	263
5249	09 - 8437	132	53916800	09 - 9008	138	3100140	12 - 5050	212
539101080	31 - 9659	1066	5961	31 - 9656	1064			
539101768	31 - 9656	1064	6013	15 - 6312	321	ECHO		
539102677	09 - 8488	135	6092	15 - 6312	321	000030	20 - 9607	519
539115242	15 - 6101	346	6092	15 - 1100	345	000100	27 - 9068	656
539115244	15 - 6084	346	6109	12 - 5115	212	000721	22 - 11179	545
539115278	13 - 9378	275	6109	12 - 7525	215	0009860	20 - 9026	516
539115279	09 - 8488	135	6111	12 - 8509	245	0009861	20 - 9026	516
539115802	31 - 9659	1066	6111	12 - 7623	216	001760	27 - 9068	656
539115982	09 - 8437	132	6111	12 - 5205	213			
539116199	12 - 7525	215						



O.E.M. REPLACEMENT CROSS REFERENCE

2014 CROSS REFERENCE

OEM #	Our #	Page #	OEM #	Our #	Page #	OEM #	Our #	Page #
ECHO			ECHO			ECHO		
0448730	20 - 7999	515	13100453530	20 - 7999	515	A021000720	22 - 11179	545
0455730	20 - 9048	516	13100455530	20 - 13530	516	A021000721	22 - 11179	545
0455830	20 - 9048	516	131205-07320	38 - 9024	502	A0210007700	22 - 11973	546
0508361	27 - 8735	485	131300-56430	20 - 9607	519	A02100740	22 - 11967	546
100101-003931	39 - 7684	1212	13160003360	20 - 13531	516	A051000201	26 - 13610	622
100212-11230	39 - 4895	1213	13160009860	20 - 13531	516	A051000840	26 - 13610	622
1003060	27 - 6966	485	13160009860	20 - 9026	516	A052000160	26 - 13172	611
1003931	39 - 7684	1212	13160009861	20 - 13531	516	A226000031	27 - 10269	485
101010-03930	39 - 7684	1212	13160009861	20 - 9026	516	A226000350	27 - 14163	486
101010-13331	39 - 7684	1212	13200-21330	38 - 9024	502	A226000351	27 - 14163	486
10101003931	39 - 7684	1212	13211546730	20 - 12605	518	A226000410	27 - 12775	486
123-181-39130	20 - 11510	51	132115467430	20 - 12605	518	A356000030	20 - 9607	519
123000-51731	22 - 11165	545	157410	27 - 6975	659	A356000031	20 - 9607	519
123000-52133	22 - 11155	546	158620	27 - 4299	659	A504000100	26 - 8071	633
12300040630	22 - 11163	546	17500539132	36 - 1627	1174	C061000100	27 - 9068	656
12300051730	22 - 11165	545	17500539133	36 - 1627	1174	P021001760	27 - 9068	656
12300052133	22 - 11155	546	17720055931	26 - 13609	622	P022006770	27 - 13300	641
12300057730	22 - 11164	545	177215-43130	26 - 13532	609	PO22006750	27 - 11983	640
12300057731	22 - 11164	545	177218-42030	26 - 12848	611	PO22006760	27 - 11982	640
123181-26030	20 - 9477	51	177220-02834	37 - 3002	1180	PO22006770	27 - 11987	640
12520005962	22 - 11176	545	177220-03930	37 - 3003	633	TC 2100	38 - 13638	1196
12520005963	22 - 11176	545	177220-06530	37 - 3010	633	V137000030	20 - 12605	518
12520008561	22 - 11970	546	177220-40630	26 - 8072	633	V430000140	27 - 12506	75
12520008563	22 - 11970	546	177220-42030	26 - 8071	633	V430000730	27 - 12508	75
12520008664	22 - 11170	546	177220-443331	26 - 13172	611			
12520008665	22 - 11170	546	177228-01110	25 - 2239	605	ECONOMY		
12520013123	22 - 11178	545	178001-0076-1	03 - 9567	58	60-4301	15 - 825	346
12520013124	22 - 11178	545	178001-0893-1	27 - 12505	75			
12520013312	22 - 11177	545	178001-0963-0	03 - 9568	58	EDGER TOOL		
12520013313	22 - 11177	545	210012-01112	27 - 8572	661	2851	16 - 6276	422
12520020561	22 - 11175	545	21001503460	27 - 11800	661			
12520020562	22 - 11175	545	21002303460	27 - 11801	661	EDKO		
12538108660	20 - 9948	51	21002303461	27 - 11801	661	20560	12 - 5083	212
12A4CD3744	35 - 13545	1148	21560031	27 - 12991	641	20824	12 - 5063	212
130-310-51830	27 - 12377	485	215703	27 - 30101	642	20825	12 - 5193	213
130305-08360	27 - 8735	485	226000031	27 - 10269	485	20939	12 - 5189	213
13030508361	27 - 8735	485	300300-08261	27 - 9068	656	21416	12 - 5173	213
130310-00760	27 - 7160	485	433019-03933	39 - 10796	1213	27055	12 - 5189	213
130310-03060	27 - 6966	485	696015-52631	16 - 2663	421			
130310-03360	39 - 6985	485	696015-52631	16 - 10712	421	EL SMITH		
130310-04560	27 - 9066	485	720-237-001	16 - 6107	421	2557	19 - 1385	474
130310-04922	27 - 6966	485	720-237-001	16 - 6477	421			
130310-51730	27 - 9067	485	900103	27 - 12598	519	ELECTROLUX		
130310-54130	27 - 10759	485	90014	20 - 13369	506	6445800	15 - 50060	346
13031039132	39 - 13166	486	90015	20 - 13370	506	6448400	15 - 50034	346
130317-00760	27 - 8585	485	90050300008	27 - 9181	655			
131004-06320	20 - 7233	515	90051100010	27 - 9182	655	EMGLO		
131004-06610	20 - 9026	516	A021000052	22 - 11971	546	L54E	19 - 2773	453
131004-40930	20 - 7999	515	A021000053	22 - 11971	546			
131004-48730	20 - 9048	516	A021000230	22 - 11968	546	ENCORE		
131004-55730	20 - 9048	516	A021000231	22 - 11968	546	15E363268	03 - 8626	58
131004-55830	20 - 9048	516	A021000232	22 - 11968	546	253027	15 - 6279	347
13100406610	20 - 13531	516	A021000290	22 - 11975	546	253027	15 - 11647	347

O.E.M. REPLACEMENT CROSS REFERENCE



CROSS REFERENCE 2014

OEM #	Our #	Page #	OEM #	Our #	Page #	OEM #	Our #	Page #
ENCORE			EXMARK			EXMARK		
323008	06 - 3239	98	1-303076	13 - 12891	281	1-323733	12 - 13109	246
343084	10 - 13469	166	1-303078	12 - 7581	216	1-323734	12 - 13110	246
363007	09 - 5713	147	1-303079	12 - 7589	216	1-324157	42 - 8250	1231
363029	05 - 10811	90	1-303080	12 - 7634	216	1-324340	42 - 9579	1231
363031	20 - 1347	34	1-303080	12 - 5867	246	1-324340	42 - 9579	1231
363117	10 - 6974	171	1-303105	10 - 9142	174	1-324340	42 - 14184	1231
363169	13 - 8587	285	1-303146	15 - 1010	336	1-352009	28 - 8979	663
363169	13 - 7983	263	1-303146	15 - 6294	323	1-402006	10 - 1227	186
363176	05 - 7787	91	1-303164	10 - 1191	175	1-402086	15 - 6296	322
363190	05 - 9757	91	1-303197	20 - 1358	498	1-403009	13 - 5714	264
363203	03 - 8626	58	1-303201	06 - 3239	98	1-403018	12 - 7582	216
363216	13 - 11228	286	1-303283	15 - 2173	334	1-403024	12 - 7639	216
363268	03 - 8626	58	1-303284	20 - 12074	515	1-403024	12 - 8370	246
363291	15 - 6294	323	1-303331	20 - 1347	34	1-403025	12 - 7597	216
363291	15 - 3404	347	1-303464	13 - 7711	276	1-403025	12 - 8092	246
363292	09 - 12651	132	1-303495	15 - 6178	350	1-403026	15 - 1009	336
363311	08 - 8574	113	1-303498	13 - 9770	277	1-403059	15 - 2172	334
363353	42 - 8250	1231	1-303499	12 - 5217	213	1-403059	15 - 6296	322
363379	10 - 9749	190	1-303499	12 - 5823	242	1-403086	15 - 6175	349
423063	19 - 9361	484	1-303514	09 - 8305	147	1-403121	31 - 14672	1062
453048	19 - 9380	484	1-303516	13 - 13013	275	1-403148	15 - 6175	349
483025	13 - 10414	288	1-303527	15 - 10071	351	1-403148	15 - 6296	322
483035	15 - 3403	347	1-303543	09 - 3217	134	1-403148	15 - 9988	349
5203434	10 - 14189	166	1-322145-01	10 - 10307	156	1-403174	12 - 13454	247
523025	10 - 14045	166	1-323017	12 - 7631	216	1-413093	12 - 10037	247
523025	10 - 11073	166	1-323017	09 - 8198	131	1-413094	12 - 11504	247
523030	31 - 9656	1064	1-323051	12 - 5865	246	1-413095	12 - 10887	247
523031	31 - 9656	1064	1-323070	13 - 9262	276	1-413096	12 - 12405	247
523034	31 - 9659	1066	1-323252	09 - 8198	131	1-413099	13 - 11815	275
523370	10 - 14045	166	1-323253	02 - 9373	53	1-413308	12 - 10251	247
523370	10 - 11073	166	1-323253	13 - 9397	292	1-413424	13 - 12317	275
583106	10 - 9750	190	1-323256	13 - 9771	276	1-503016	12 - 7584	216
583108	17 - 14050	434	1-323261	05 - 9752	91	1-503031	15 - 11647	347
			1-323261	05 - 9757	91	1-503031	15 - 6279	347
			1-323262	05 - 10415	91	1-513012	09 - 11060	136
EVERRIDE			1-323280	12 - 8812	246	1-513016	09 - 8488	135
136574	31 - 9657	1064	1-323285	13 - 9753	275	1-513048	05 - 7787	91
181026	15 - 11663	347	1-323285	13 - 12891	281	1-513051	31 - 9660	1066
181042	15 - 11662	347	1-323285	13 - 2188	263	1-513075	31 - 8943	1071
191107	15 - 12251	347	1-323288	12 - 9257	246	1-513152	31 - 9658	1066
191108	15 - 12375	347	1-323299	12 - 8091	246	1-513167	20 - 9700	518
			1-323300	12 - 8805	246	1-513208	17 - 14050	434
EXMARK			1-323329	09 - 6534	135	1-513211	19 - 9361	484
1-213077	12 - 7480	215	1-323344	12 - 13108	246	1-513211	19 - 9361	484
1-302006	10 - 2219	161	1-323501	42 - 14184	1231	1-513211	19 - 7916	483
1-302016	08 - 905	112	1-323501	42 - 9579	1231	1-513264	15 - 6834	348
1-302029	42 - 7097	1231	1-323502	42 - 9580	1233	1-513336	09 - 8984	147
1-303041	09 - 5703	147	1-323502	42 - 14180	1233	1-513508	20 - 12074	515
1-303044	09 - 8305	147	1-323515	15 - 9487	349	1-513547	09 - 8409	140
1-303057	09 - 3217	134	1-323515	15 - 1009	336	1-513809	09 - 8408	140
1-303057	09 - 3217	134	1-323515	15 - 2172	334	1-513809	09 - 8998	140
1-303067	09 - 8077	132	1-323539	10 - 1191	175	1-513875	15 - 6407	356
1-303073	13 - 2185	272	1-323680	42 - 14185	1231	1-513876	15 - 6406	356
1-303076	13 - 2188	263						



O.E.M. REPLACEMENT CROSS REFERENCE

2014 CROSS REFERENCE

OEM #	Our #	Page #	OEM #	Our #	Page #	OEM #	Our #	Page #
EXMARK			EXMARK			EXMARK		
1-522143-01	10 - 8625	156	1-633484	15 - 6178	350	103-0665	10 - 12977	167
1-523009	08 - 7025	122	1-633569	12 - 9863	248	103-0665	10 - 11237	167
1-523027	10 - 9972	159	1-633579	09 - 10017	142	103-0690	10 - 11075	167
1-523027	10 - 13664	159	1-633580	10 - 10013	176	103-0690	10 - 12261	168
1-523175	12 - 10038	247	1-633581	09 - 10064	142	103-0862	10 - 11566	179
1-523541	19 - 9464	484	1-633582	08 - 9803	108	103-0866	12 - 10716	245
1-543070	31 - 9158	1059	1-633585	09 - 813	133	103-0881	12 - 10254	245
1-543259	10 - 11858	167	1-633673	31 - 11470	1065	103-0882	12 - 10255	245
1-543365	20 - 12074	515	1-633673	31 - 9657	1064	103-1026	10 - 13504	178
1-543409	21 - 12531	526	1-633673	31 - 9657	1064	103-1105	10 - 13003	190
1-543411	21 - 12531	526	1-633696	03 - 12218	58	103-1140	10 - 13130	191
1-543509	09 - 814	134	1-633701	13 - 10960	276	103-1183	10 - 13004	190
1-543511	10 - 10014	176	1-633959	09 - 9992	142	103-1184	10 - 10785	190
1-543513	09 - 10665	148	1-633993	08 - 9283	120	103-1224	08 - 9898	109
1-543523	12 - 5867	246	1-634619	10 - 12668	190	103-1224	08 - 8550	111
1-551054	10 - 11858	167	1-634662	08 - 9809	110	103-1297	12 - 10256	245
1-602501	13 - 5714	264	1-634662	08 - 9804	108	103-1326	19 - 11865	468
1-603045	12 - 10886	247	1-634972	10 - 10353	190	103-1326	19 - 9728	468
1-603283	15 - 9465	324	1-641300	10 - 12977	167	103-1327	19 - 9583	468
1-603299	07 - 6917	103	1-643052	12 - 10041	248	103-1364	10 - 12262	168
1-603306	12 - 10885	247	1-643097	15 - 9882	355	103-1577	15 - 10419	349
1-603336	03 - 13014	58	1-643275	31 - 9369	1064	103-1577-S	15 - 10419	349
1-603539	10 - 11857	166	1-644092	10 - 13006	190	103-1578-S	15 - 10071	351
1-603576	12 - 12256	247	1-644251	08 - 10075	111	103-1579	15 - 10420	348
1-603602	10 - 10007	181	1-653048	10 - 12261	168	103-1579-S	15 - 10420	348
1-603602	09 - 8586	141	1-653048	10 - 11075	167	103-1581	15 - 10421	355
1-603661	15 - 6216	352	1-653099	13 - 12715	275	103-1581-S	15 - 10421	355
1-603676	05 - 10813	90	1-653099	13 - 12715	275	103-2146	19 - 9361	484
1-603805	13 - 9772	276	1-653163	12 - 10252	248	103-2146	19 - 9380	484
1-603843	13 - 11658	275	1-653292	10 - 12261	168	103-2171	08 - 9898	109
1-603844	15 - 6217	351	1-653332	12 - 10167	248	103-2240	12 - 14638	245
1-611223	10 - 11857	166	1-653333	12 - 10039	248	103-2477	09 - 12119	136
1-613072	15 - 6250	352	1-65333869	13 - 12793	275	103-2507	15 - 10718	348
1-613098	13 - 10397	276	1-653368	12 - 10040	248	103-2508	15 - 10719	351
1-613112	15 - 6303	324	1-653416	12 - 10253	248	103-2510	15 - 10249	352
1-613112	15 - 6290	353	1-809020	10 - 7181	162	103-2510-S	15 - 10249	352
1-613204	10 - 2216	173	1-809020	24 - 7191	589	103-2518-S	15 - 6178	350
1-613264	08 - 9187	120	100-2860	06 - 13432	100	103-2519-S	15 - 6820	348
1-613271	12 - 10884	247	103-0063	10 - 10013	176	103-2521-S	15 - 9882	355
1-631560	09 - 8351	131	103-0064	08 - 10288	110	103-2527	15 - 6296	322
1-631732	10 - 12977	167	103-0065	08 - 10286	110	103-2527	15 - 2172	334
1-632511-01	10 - 10194	156	103-0069	08 - 10075	111	103-2529-S	15 - 6821	348
1-633002	08 - 10289	122	103-0206	31 - 11822	1059	103-2529-S	15 - 9884	321
1-633109	13 - 9864	275	103-0281	10 - 12262	168	103-2530	15 - 10667	334
1-633111	31 - 9659	1066	103-0291	21 - 12531	526	103-2530-S	15 - 10667	334
1-633127	12 - 9016	247	103-0292	21 - 12531	526	103-2531-S	15 - 6481	355
1-633131	10 - 9143	174	103-0301-S	15 - 6303	324	103-2533	10 - 12668	190
1-633162	12 - 10257	247	103-0301-S	15 - 6290	353	103-2547	10 - 12668	190
1-633166	13 - 9793	276	103-0301-S	15 - 11139	353	103-2744	08 - 9283	120
1-633167	13 - 9794	276	103-0501	10 - 11237	167	103-2913	10 - 13664	159
1-633173	12 - 9014	247	103-0661	10 - 11133	167	103-3037	17 - 14440	428
1-633347	20 - 11273	511	103-0662	10 - 11133	167	103-3168	07 - 10301	104
1-633366	12 - 9862	247	103-0664	10 - 11444	167	103-3168	07 - 12727	106

O.E.M. REPLACEMENT CROSS REFERENCE



CROSS REFERENCE 2014

OEM #	Our #	Page #	OEM #	Our #	Page #	OEM #	Our #	Page #
EXMARK			EXMARK			EXMARK		
103-3200	10 - 10872	190	103-6400	15 - 11269	348	103-9605-S	15 - 12003	350
103-3206	10 - 13007	191	103-6400-S	15 - 11269	348	103-9606	15 - 12004	352
103-3232-S	15 - 6250	352	103-6401	15 - 11231	349	103-9607	15 - 11778	352
103-3233	15 - 9465	324	103-6401-S	15 - 11231	349	103-9607-S	15 - 11778	352
103-3245	10 - 12981	167	103-6402	15 - 11495	351	103-9610	15 - 11775	350
103-3246	10 - 12403	168	103-6402-S	15 - 11495	351	103-9611	15 - 11779	352
103-3289	15 - 6407	356	103-6403	15 - 11248	353	103-9612	15 - 11787	354
103-3290	15 - 6406	356	103-6403	15 - 11224	353	103-9613	15 - 11791	355
103-3808	19 - 8279	474	103-6403-S	15 - 11224	353	103-9614	15 - 11772	322
103-4014	12 - 12237	245	103-6403-S	15 - 11248	353	103-9615	15 - 11776	322
103-4051	07 - 10301	104	103-6404	15 - 11229	355	103-9616	15 - 11785	354
103-4079	10 - 9972	159	103-6404-S	15 - 11229	355	103-9616-S	15 - 11785	354
103-4079	10 - 13664	159	103-6506	12 - 12783	245	103-9618	15 - 12027	354
103-4760	12 - 10252	248	103-6579	10 - 12403	168	103-9619	15 - 11786	354
103-4761	12 - 12641	245	103-6580-S	15 - 10719	351	103-9619-S	15 - 11786	354
103-5189	08 - 10288	110	103-6581-S	15 - 9988	349	103-9622	15 - 11789	355
103-5221	31 - 9657	1064	103-6582-S	15 - 6291	350	103-9622-S	15 - 11789	355
103-5364	10 - 12017	179	103-6583-S	15 - 1009	336	103-9624	15 - 12028	355
103-5589	12 - 10253	248	103-6583-S	15 - 9487	349	103-9625	15 - 11790	355
103-6317	12 - 13254	245	103-6583-S	15 - 2172	334	103-9628	15 - 11780	323
103-6381	15 - 11493	349	103-6584	15 - 6294	323	103-9628-S	15 - 11780	323
103-6381-S	15 - 11493	349	103-6584	15 - 1010	336	103-9629	15 - 11784	324
103-6382	15 - 11450	351	103-6584-S	15 - 6291	350	103-9630	15 - 11788	325
103-6382-S	15 - 11450	351	103-6584-S	15 - 2173	334	103-9630-S	15 - 11788	325
103-6383	15 - 11249	353	103-6584-S	15 - 1010	336	103-9631	15 - 11792	325
103-6383-S	15 - 11249	353	103-6738-S	15 - 10718	348	103-9631-S	15 - 11792	325
103-6384	15 - 11498	355	103-7263	07 - 12018	104	1031578	15 - 10071	351
103-6384-S	15 - 11498	355	103-8075	10 - 10872	190	1033233S	15 - 9465	324
103-6386	15 - 11494	349	103-8107	15 - 11783	354	1033785	08 - 10288	110
103-6386-S	15 - 11494	349	103-8240	15 - 11781	354	1035598	12 - 10256	245
103-6387	15 - 11451	352	103-8240-S	15 - 11781	354	1036397S	15 - 11267	351
103-6387-S	15 - 11451	352	103-8244	15 - 12005	354	1036397S	15 - 11267	351
103-6388	15 - 11496	353	103-8251	15 - 12002	350	1036583	15 - 1009	336
103-6388-S	15 - 11496	353	103-8280	10 - 12668	190	1038251S	15 - 12002	350
103-6390	15 - 11500	348	103-8288	15 - 11771	350	1038370S	15 - 11770	350
103-6390-S	15 - 11500	348	103-8288-S	15 - 11771	350	1039615S	15 - 11776	322
103-6391	15 - 11240	349	103-8290	15 - 11769	350	1039618S	15 - 12027	354
103-6391-S	15 - 11240	349	103-8290-S	15 - 11769	350	1039625S	15 - 11790	355
103-6392	15 - 11241	351	103-8296	15 - 11769	350	106-0888	03 - 8765	66
103-6392-S	15 - 11241	351	103-8296-S	15 - 11769	350	107-1887	21 - 13998	526
103-6393	15 - 11242	352	103-8323	10 - 13007	191	107-4276-03	15 - 6256	410
103-6393-S	15 - 11242	352	103-8370	15 - 11770	350	108-6163	21 - 13998	526
103-6394	15 - 11244	355	103-8396	15 - 11782	354	109-0977	13 - 10156	37
103-6394-S	15 - 11244	355	103-8396-S	15 - 11782	354	109-0977	13 - 12297	278
103-6395	15 - 11243	348	103-8415	07 - 12015	104	109-1057	12 - 10887	247
103-6396	15 - 11279	349	103-9081	10 - 13005	190	109-2064	09 - 13259	135
103-6396-S	15 - 11279	349	103-9598	15 - 11773	350	109-2098	07 - 12018	104
103-6397	15 - 11267	351	103-9598-S	15 - 11773	350	109-2102	10 - 13540	191
103-6397	15 - 11267	351	103-9600	15 - 11774	350	109-2339	10 - 9972	159
103-6398	15 - 11469	354	103-9600-S	15 - 11774	350	109-2339	10 - 13664	159
103-6398-S	15 - 11469	354	103-9603	15 - 11777	352	109-2584	12 - 10884	247
103-6399	15 - 11501	355	103-9603-S	15 - 11777	352	109-2594	08 - 12879	122
103-6399-S	15 - 11501	355	103-9605	15 - 12003	350	109-2915	10 - 12261	168



O.E.M. REPLACEMENT CROSS REFERENCE

2014 CROSS REFERENCE

OEM #	Our #	Page #	OEM #	Our #	Page #	OEM #	Our #	Page #
EXMARK			EXMARK			EXMARK		
109-2916	10 - 12261	168	110-8837	09 - 9944	137	303514	09 - 8305	147
109-2916	10 - 11075	167	116-0027	10 - 13470	159	303543	09 - 3217	134
109-2916	10 - 12517	168	116-0124	31 - 12624	1065	304173	08 - 905	112
109-3321	19 - 12374	484	116-1037-S	15 - 14491	354	3211-46	10 - 12564	181
109-3388	12 - 12426	245	116-3455	12 - 14209	246	3213-5	10 - 13240	178
109-3397	13 - 12301	275	116-5496-S	15 - 11772	322	3213-6	10 - 12633	178
109-3658	13 - 10153	37	116-5497-S	15 - 11776	322	3217-9	10 - 8447	178
109-4076	13 - 12300	275	116-5498-S	15 - 11780	323	323017	12 - 7631	216
109-4077	13 - 12298	278	116-5499-S	15 - 11784	324	323051	12 - 5865	246
109-4077	13 - 10152	37	116-5500-S	15 - 11788	325	323070	13 - 9262	276
109-4077	13 - 12302	275	116-5501-S	15 - 11792	325	323256	13 - 9771	276
109-4180	19 - 9361	484	1161611	10 - 12403	168	323261	05 - 9752	91
109-4180	19 - 7916	483	1163626	13 - 11658	275	323280	12 - 8812	246
109-4199	12 - 13255	245	1164666	13 - 11815	275	323285	13 - 9753	275
109-4736	31 - 11822	1059	1164667	13 - 9864	275	323288	12 - 9257	246
109-4994	12 - 14165	245	1165171S	15 - 11501	355	323299	12 - 8091	246
109-5018	12 - 13256	245	1165174S	15 - 11469	354	323300	12 - 8805	246
109-5364	12 - 12425	246	1165175S	15 - 11267	351	323502	42 - 9580	1233
109-5396-S	15 - 11783	354	1165175S	15 - 11267	351	323515	15 - 2172	334
109-5876-S	15 - 11775	350	1165177S	15 - 11279	349	323515	15 - 9487	349
109-5877-S	15 - 11779	352	1165496S	15 - 11770	350	323515	15 - 1009	336
109-5878-S	15 - 11787	354	1165497S	15 - 11776	322	324157	42 - 8250	1231
109-5879-S	15 - 11791	355	1165499S	15 - 11782	354	325-20	10 - 8411	179
109-6460-S	15 - 12002	350	1165500S	15 - 11788	325	325-20	10 - 8419	180
109-6461-S	15 - 12003	350	1168883	10 - 10194	156	325-36	10 - 11040	180
109-6464-S	15 - 12027	354	117-1197	31 - 8943	1071	3296-39	10 - 12565	181
109-6465-S	15 - 12028	355	1211379	06 - 13432	100	3296-51	10 - 11039	178
109-7582	12 - 12799	245	1323385	10 - 10357	160	3322154	09 - 8999	140
109-7665	10 - 12403	168	1633482	15 - 2173	334	352009	28 - 8979	663
109-7673	10 - 12403	168	1634662	08 - 10288	110	402006	10 - 1227	186
109-8070	12 - 14217	246	254-94	09 - 814	134	402086	15 - 6296	322
109-8073	12 - 14167	246	29-5560	31 - 7976	1063	403018	12 - 7582	216
109-8370-S	15 - 11770	350	302-52	02 - 163	43	403024	12 - 7639	216
109-8891	13 - 10153	37	302030	10 - 1226	186	403024	12 - 8370	246
109-9126	08 - 10288	110	302036	05 - 8266	91	403025	12 - 7597	216
109-9275	10 - 12835	168	302122	10 - 2218	157	403025	12 - 8092	246
109-9276	10 - 11075	167	303041	09 - 5703	147	403026	15 - 6296	322
109-9276	10 - 12517	168	303044	09 - 8305	147	403026	15 - 1009	336
109-9276	10 - 12261	168	303067	09 - 8077	132	403059	15 - 2172	334
109-9390-S	15 - 11772	322	303073	13 - 2185	272	403059	15 - 6296	322
109-9391-S	15 - 11776	322	303078	12 - 7581	216	403086	15 - 6175	349
109-9392-S	15 - 11780	323	303079	12 - 7589	216	403086	15 - 6296	322
109-9393-S	15 - 11784	324	303080	12 - 5867	246	403148	15 - 6175	349
109-9394-S	15 - 11788	325	303080	12 - 7634	216	413093	12 - 10037	247
109-9395-S	15 - 11790	355	303146	15 - 1010	336	42-1000-03	15 - 6256	410
109-9606-S	15 - 12004	352	303146	15 - 6294	323	503016	12 - 7584	216
109-9851	10 - 12017	179	303201	06 - 3239	98	503031	15 - 6279	347
109585	20 - 1358	498	303283	15 - 2173	334	513009	09 - 8351	131
1096462S	15 - 12004	352	303464	13 - 7711	276	513048	05 - 7787	91
1096463S	15 - 12005	354	303495	15 - 6178	350	513051	31 - 9660	1066
1099392S	15 - 11780	323	303498	13 - 9770	277	513075	31 - 8943	1071
1099394S	15 - 11788	325	303499	12 - 5217	213	513152	31 - 9658	1066
110-6569	21 - 13998	526	303499	12 - 5823	242	513167	20 - 9700	518

O.E.M. REPLACEMENT CROSS REFERENCE



CROSS REFERENCE 2014

OEM #	Our #	Page #	OEM #	Our #	Page #	OEM #	Our #	Page #
EXMARK			EXMARK			FERRIS		
513211	19 - 9361	484	69-1180	21 - 13998	526	22182	31 - 9665	1066
513336	09 - 8984	147	740275	31 - 9664	1066	22383	13 - 10774	290
513508	20 - 12074	515	800334	10 - 8411	179	22476	15 - 3329	337
513547	09 - 8409	140	800334	10 - 8419	180	22587	13 - 10773	290
513809	09 - 8408	140	804509	10 - 8447	178	22631S	08 - 10288	110
513809	09 - 8998	140	809006	10 - 2226	162	46363-5	09 - 3217	134
513875	15 - 6407	356	93-2195	19 - 9550	459	5020842	15 - 9969	319
513876	15 - 6406	356	98-7249	31 - 9369	1064	5020842	15 - 10174	318
522143	10 - 8625	156	EZ-GO CART			5020842	15 - 2174	337
523175	12 - 10038	247	14416GL	19 - 8332	458	5020842	15 - 9987	357
523541	19 - 9464	484	72144G01	19 - 9571	458	5020842	15 - 3434	362
543511	10 - 10014	176	FAIRBANKS MORSE			5020842	15 - 6299	324
55-3570	20 - 8934	514	10-27-80	39 - 1570	1215	5020842S	15 - 2174	337
603283	15 - 9465	324	FALLS PRODUCTS			5020842S	15 - 3434	362
603283	15 - 6250	352	352400	15 - 1074	356	5020842S	15 - 9987	357
603299	07 - 6917	103	FATE-ROOT-HEATH			5020843	15 - 9967	319
603539	10 - 11857	166	1330	12 - 5053	212	5020843	15 - 10172	318
603602	09 - 8586	141	FERRIS			5020843	15 - 2172	334
603602	10 - 10007	181	1520814	13 - 11228	286	5020843	15 - 6296	322
603661	15 - 6216	352	1520842	15 - 9987	357	5020843	15 - 1009	336
603676	05 - 10813	90	1520842	15 - 10174	318	5020884	09 - 814	134
603805	13 - 9772	276	1520842	15 - 9969	319	5021145	10 - 12977	167
603844	15 - 6217	351	1520842	15 - 6299	324	5021227	15 - 3374	338
613072	15 - 6250	352	15208425	15 - 3434	362	5021227	15 - 6014	338
613112	15 - 6303	324	15208425	15 - 9987	357	5021227	15 - 3404	347
613112	15 - 6290	353	1520843	15 - 2174	337	5021227	15 - 9968	319
631560	09 - 8351	131	1520843	15 - 6296	322	5021227	15 - 10173	318
631732	10 - 12977	167	1520843	15 - 9967	319	5021227S	15 - 10173	318
632511-01	10 - 10194	156	1520843	15 - 10172	318	5021227S	15 - 6014	338
633111	31 - 9659	1066	1520843S	15 - 6296	322	5021227S	15 - 3404	347
633127	12 - 9016	247	1521083	10 - 11858	167	5021227S	15 - 3374	338
633131	10 - 9143	174	1521145	10 - 12977	167	5021976	13 - 12472	277
633166	13 - 9793	276	1521227	15 - 6014	338	5022061	12 - 12867	258
633167	13 - 9794	276	1521227	15 - 3374	338	5022061	12 - 12824	256
633173	12 - 9014	247	1521227	15 - 10173	318	5022180	31 - 9656	1064
633482	15 - 6294	323	1521227	15 - 9968	319	5022182	31 - 9656	1064
633482	15 - 2173	334	1521227	15 - 3404	347	5022476	15 - 3329	337
633482	15 - 1010	336	1521357	19 - 9380	484	5022476	15 - 6026	334
633484	15 - 6291	350	1521823	10 - 11857	166	5022631SX2	09 - 813	133
633569	12 - 9863	248	1521866	20 - 9650	515	5022631SX2	08 - 10288	110
633580	10 - 10013	176	1522040	10 - 11444	167	5022631SX3	10 - 10013	176
633582	08 - 9803	108	1522158	20 - 9650	515	5023330	09 - 7178	134
633673	31 - 9657	1064	1530301	10 - 5722	198	5023455	31 - 9665	1066
634662	08 - 9804	108	20819	13 - 6532	290	5030301	10 - 5722	198
634662	08 - 9809	110	21451	31 - 9660	1066	5061827	15 - 12868	357
641300	10 - 12977	167	21769	31 - 9658	1066	5101755	15 - 3434	362
643006	15 - 6481	355	22095	31 - 9659	1066	5101756	15 - 3404	347
643052	12 - 10041	248	22180	31 - 9656	1064	5101986	15 - 2172	334
653101	15 - 6821	348	FLEET			5208425	15 - 3434	362
653101	15 - 9884	321				5600184	13 - 12472	277
653102	15 - 6820	348				FLEET		
653368	12 - 10040	248				AF25552	19 - 9728	468
653438	12 - 10717	248						



O.E.M. REPLACEMENT CROSS REFERENCE

2014 CROSS REFERENCE

OEM #	Our #	Page #	OEM #	Our #	Page #	OEM #	Our #	Page #
FLYMO			GB			GILSON		
1911	15 - 1033	358	SW12-43SW	35 - 12433	1171	14790	12 - 5071	212
51275188	07 - 9673	101	SW12-50SW	35 - 10575	1165	14843	12 - 7472	215
5127526-69	07 - 9672	101	SW16-43SW	35 - 12538	1171	1526	12 - 5055	212
5138636-02	07 - 9671	101	GENERAC			15365	12 - 7494	215
5138640-02	07 - 9674	101	070185D	19 - 6600	483	16146	12 - 7482	215
5138644	07 - 9675	101	10455515	26 - 12432	613	16348	12 - 7481	215
6823809	07 - 9676	101	1323	19 - 12864	450	16366	12 - 7480	215
6824900	07 - 9677	101	1323	19 - 6600	483	16366	12 - 5070	212
FOOTE			70185	19 - 6600	483	16366	12 - 7442	214
B-1084	05 - 3205	88	70185	19 - 12864	450	16386	12 - 7483	215
FORD			73111GS	19 - 11042	458	16386	12 - 5073	212
234594	12 - 5177	213	78601	19 - 10752	458	16711	12 - 7503	215
330599	12 - 7481	215	78602	19 - 10753	458	17518	12 - 7503	215
342660	12 - 7622	216	OC3017	26 - 12432	613	17569	12 - 7486	215
FRONTIER			OE4271	26 - 12432	613	17569	12 - 7477	215
100073	37 - 3048	1180	OE6037	24 - 12431	594	17569	12 - 5076	212
GAMBLE SKOGMO			OE9323	26 - 12432	613	17643	12 - 7490	215
1651-020	12 - 5051	212	GIANT VAC			18263	12 - 7487	215
GARDEN WAY			36041	15 - 6278	358	200413	12 - 7482	215
1748723	31 - 9660	1066	GILSON			200414	12 - 7526	215
1751328	31 - 9659	1066	1019	12 - 7442	214	200416	12 - 7475	215
1761083	31 - 9664	1066	1024	29 - 820	666	200624	12 - 7523	215
1772388	10 - 9911	164	1040	12 - 7475	215	200625	12 - 7499	215
GATES			1044	09 - 813	133	200626	12 - 7585	216
7800-22	13 - 1262	285	1045	09 - 814	134	200626	12 - 7585	216
GB			1046	09 - 814	134	200804	12 - 7517	215
EC202-R6N	36 - 1627	1174	10463	12 - 7480	215	200973	12 - 7521	215
GBA7L7	36 - 1689	1177	1054	29 - 450	666	200982	12 - 7521	215
GBA7M7	36 - 10987	1177	10755	12 - 7486	215	201879	41 - 5512	1223
GBA7S7	36 - 1688	1177	10897	12 - 7494	215	207141	41 - 5504	1225
GBA8L7	36 - 9498	1177	10923	12 - 7473	215	207527	41 - 5504	1225
GBB7L7	36 - 1686	1177	1110	12 - 7478	215	208301	12 - 7476	215
GBJ7MJ	36 - 10986	1177	1111	12 - 7442	214	208525	12 - 7430	214
GBJ7S7	36 - 1690	1177	1140	09 - 813	133	208526	12 - 7443	214
HX12-50SW	35 - 10606	1159	11793	12 - 7635	216	208527	12 - 7491	215
HX14-50SW	35 - 10605	1159	11901	12 - 7479	215	208625	12 - 7470	215
HX16-50SW	35 - 10602	1159	11943	12 - 7580	216	208626	12 - 7432	214
M12-50SW	35 - 10610	1157	12023	12 - 5004	211	208736	07 - 6919	103
M14-50SW	35 - 10604	1157	12684	12 - 7641	216	208918	07 - 6918	104
M16-50SW	35 - 10601	1157	13009	12 - 7484	215	209310	12 - 7482	215
PA475-R6N	36 - 1603	1175	13072	12 - 7515	215	209373	12 - 7484	215
PO12-50SW	35 - 13302	1149	13436	12 - 7497	215	209375	12 - 7487	215
PO12-50SW	35 - 10597	1157	13487	12 - 7480	215	209581	12 - 7529	215
PO14-50SW	35 - 10596	1157	13560	12 - 7503	215	209630	12 - 7482	215
PO16-50SW	35 - 10595	1157	1409	12 - 7597	216	209652	12 - 7601	216
PO18-50SW	35 - 10613	1157	14159	12 - 7508	215	210392	12 - 7539	215
			14167	12 - 7483	215	210453	07 - 6915	105
			14168	12 - 7508	215	210692	12 - 7539	215
			14168	12 - 7494	215	210752	12 - 7513	215
			14365	12 - 7494	215	210754	12 - 7534	215
			14790	12 - 7481	215	211650	12 - 7438	214
						212086	12 - 7483	215
						212183	12 - 7481	215
						212655	31 - 5933	1071

O.E.M. REPLACEMENT CROSS REFERENCE



CROSS REFERENCE 2014

OEM #	Our #	Page #	OEM #	Our #	Page #	OEM #	Our #	Page #
GILSON			GILSON			GRASSHOPPER		
212655	31 - 10772	1071	37059	15 - 2030	358	184251	31 - 10772	1071
212775	12 - 7500	215	37169	12 - 7479	215	184251	31 - 5933	1071
212776	12 - 7509	215	37230	12 - 7481	215	184251	31 - 8943	1071
213676	12 - 7528	215	37230	12 - 5071	212	185530	31 - 9210	1079
214170	12 - 7501	215	37756	12 - 7499	215	265537	10 - 9142	174
214776	12 - 7492	215	3866	12 - 7469	215	265545	10 - 9143	174
217773	12 - 7483	215	4051	12 - 7436	214	265615	10 - 2209	174
218152	12 - 7439	214	4052	12 - 7498	215	265616	10 - 13451	174
219981	12 - 7482	215	4332	12 - 7474	215	282575	10 - 12361	148
231362	12 - 7450	214	4638	12 - 7473	215	320231	15 - 6415	321
23141	12 - 7485	215	4816G	12 - 7530	215	320231	15 - 3377	359
23144	12 - 7545	215	4825	12 - 7503	215	320232	15 - 3378	359
23145	12 - 7489	215	4953	12 - 7505	215	320233	15 - 6330	359
231511	12 - 7516	215	5283	12 - 7506	215	320236	15 - 3379	359
23181	12 - 7525	215	5286	12 - 7509	215	320236	15 - 6309	322
234110	12 - 7493	215	6163	12 - 7442	214	320236	15 - 11033	359
234292	12 - 7638	216	6184	12 - 7444	214	320237	15 - 3380	359
234360	12 - 7542	215	6185	12 - 7488	215	320237	15 - 6309	322
234419	12 - 7535	215	6588	13 - 721	36	320238	15 - 6323	359
234420	12 - 7584	216	710138	07 - 6917	103	320239	15 - 3380	359
234594	12 - 7451	214	7714	13 - 718	36	320239	15 - 6309	322
23486	13 - 729	36	7903	12 - 7492	215	320239	15 - 13463	359
235000	12 - 7595	216	79EA319	12 - 7475	215	320242	15 - 6401	360
235459	12 - 7496	215	83EA335	12 - 7603	216	320242	15 - 6167	359
235955	12 - 7444	214	9301	12 - 7471	215	320242	15 - 6311	324
236705	12 - 7476	215	9302	12 - 7480	215	320243	15 - 6168	360
236907	12 - 7539	215	9305	12 - 7495	215	320243	15 - 6311	324
236914	12 - 7648	216	9306	12 - 7476	215	320243	15 - 3424	360
236928	12 - 7550	215	9308	12 - 7468	215	320244	15 - 10102	359
237452	12 - 7475	215				320245	15 - 6168	360
237453	12 - 7472	215	GRASSCRAFT			320245	15 - 6311	324
237685	12 - 7593	216	GC-1605-91	15 - 6760	358	320245	15 - 3424	360
237738	12 - 7529	215	SE1601	27 - 9035	327	320245	15 - 13464	360
240684	12 - 7451	214				320250	15 - 6402	360
2434	12 - 7477	215	GRASSHOPPER			320251	15 - 6403	360
244104	12 - 7439	214	100800	19 - 12120	483	320253	15 - 6403	360
244105	12 - 7487	215	100850	19 - 9464	484	381100	12 - 5156	213
244106	12 - 7484	215	100940	19 - 8279	474	381100	12 - 7574	216
24445	13 - 5869	263	101000	20 - 13536	520	381904	12 - 7477	215
24445	13 - 734	36	101005	20 - 9146	497	381914	12 - 8733	248
245946	07 - 6914	105	110080	09 - 10303	135	382000	12 - 5159	213
24829	09 - 2935	146	110081	09 - 10303	135	382000	12 - 7578	216
3045	12 - 7484	215	110081	09 - 7162	134	382034	12 - 12094	248
3053	12 - 7487	215	110082	09 - 7162	134	382035	12 - 10743	248
32222	05 - 300	92	110082	09 - 10303	135	382037	12 - 8731	248
33632	13 - 435	666	120050	09 - 7950	131	382038	12 - 7610	216
34491	12 - 7533	215	120081	09 - 8488	135	382049	12 - 7627	216
35545	12 - 5073	212	122044	09 - 9160	136	382049	12 - 5209	213
35545	12 - 7483	215	183806	31 - 2922	1062	382080	12 - 12095	248
36019	12 - 5003	211	183870	31 - 14291	1067	382082	12 - 12096	248
3660	12 - 7468	215	183894	31 - 9659	1066	382084	12 - 12097	249
36751	12 - 7532	215	183925	31 - 9657	1064	382085	12 - 10744	249
36770	12 - 7477	215	184082	31 - 7922	1064	382086	12 - 12098	249



O.E.M. REPLACEMENT CROSS REFERENCE

2014 CROSS REFERENCE

OEM #	Our #	Page #	OEM #	Our #	Page #	OEM #	Our #	Page #
GRASSHOPPER			GRAVELY			GRAVELY		
382090	12 - 12099	249	00389900	10 - 14009	164	15242	12 - 7472	215
382093	12 - 14363	249	005430	10 - 11664	168	15243	12 - 7531	215
382095	12 - 10745	249	00574100	10 - 11664	168	15355	12 - 7481	215
382097	12 - 12100	249	007277	31 - 1929	1072	15373	19 - 1385	474
382098	12 - 12106	249	007354	20 - 1347	34	18355	09 - 8522	148
382099	12 - 12107	249	009212	15 - 2164	361	18543	18 - 2286	441
382110	12 - 12108	249	014673	12 - 9900	235	18563	20 - 1347	34
382111	12 - 12109	249	01552900	21 - 13998	526	19223	31 - 1931	1061
382570	12 - 7584	216	022152	31 - 1781	1077	19223	31 - 8601	1063
382627	12 - 7480	215	03498400	15 - 1065	360	19332	19 - 1377	470
382730	12 - 7580	216	035634	31 - 12792	1071	20015000	12 - 7474	215
382750	12 - 7584	216	03746500	15 - 13177	328	20031900	31 - 1929	1072
382753	12 - 7586	216	038946	15 - 6194	319	200347	15 - 2164	361
382765	12 - 7590	216	03971900	15 - 13177	328	20034700	15 - 2164	361
383720	12 - 7580	216	042366	19 - 12863	450	20034751	15 - 2164	361
388740	10 - 11237	167	04265400	15 - 14540	328	20068	12 - 7512	215
388766	10 - 9913	164	044439	12 - 7522	215	20165300	12 - 9900	235
388767	10 - 14495	164	046999	15 - 6180	334	20259700	18 - 2286	441
388769	10 - 12114	168	04901000/4901042	12 - 14177	1232	20277600	19 - 1377	470
393225	13 - 7937	264	04923100	42 - 14181	1233	20299	19 - 1384	473
393312	13 - 13622	270	07213600	12 - 12850	228	20302700	19 - 1384	473
393376	13 - 13417	277	07214300	12 - 12850	228	203339	12 - 7430	214
414686	09 - 7162	134	0721960	12 - 7837	250	20355500	31 - 1781	1077
415650	13 - 8093	277	07234300	12 - 12850	228	204080	12 - 7612	216
426122	07 - 13280	104	07238600	12 - 7522	215	204081	12 - 7643	216
482472	08 - 9189	120	07325200	13 - 734	36	204416	12 - 7490	215
482478	08 - 8896	121	07325200	13 - 5869	263	204417	12 - 7469	215
482480	08 - 8896	121	07326901	13 - 9397	292	204420	12 - 7490	215
482483	08 - 11563	119	07326901	02 - 9373	53	204421	12 - 7470	215
483800	08 - 3276	112	07327600	13 - 734	36	204424	12 - 7484	215
483800	08 - 11522	110	07327600	13 - 5869	263	204426	12 - 7434	214
484225	07 - 6916	106	073278	13 - 12411	277	204427	12 - 7521	215
484230	07 - 10715	103	08860200	20 - 1347	34	204428	12 - 7474	215
603725	07 - 13281	104	08979600	15 - 6194	319	204429	12 - 7513	215
603925	08 - 3276	112	08979600	15 - 6180	334	204430	12 - 7435	214
603927	08 - 8552	108	09081200	15 - 13624	361	204434	12 - 7436	214
603927	08 - 11522	110	09225400	10 - 11071	164	204435	12 - 7512	215
603971	08 - 11522	110	09232700	10 - 14009	164	204436	12 - 7509	215
603971	08 - 3276	112	09246900	19 - 9464	484	204438	12 - 7522	215
603975	08 - 9500	121	092537	07 - 10714	104	204444	12 - 7508	215
604180	10 - 11664	168	10860	12 - 7440	214	204446	12 - 7439	214
604182	10 - 9913	164	10900	19 - 1386	470	20599100	12 - 7532	215
604182	10 - 11237	167	11193	09 - 6573	133	20600100	12 - 7592	216
604796	31 - 7922	1064	11216	12 - 7837	250	20601300	12 - 7469	215
606242	10 - 14495	164	11234	15 - 1066	345	20609300	23 - 2750	570
606242	10 - 12114	168	11234P1	15 - 1066	345	20609400	19 - 1388	472
833210	09 - 10303	135	11386	06 - 5915	98	20626200	31 - 12792	1071
833210	09 - 7162	134	11387	09 - 8485	142	2063510	12 - 7515	215
833260	09 - 8513	148	11641	09 - 484	133	20636900	08 - 3277	115
902284	09 - 14059	141	11950	09 - 8420	140	20656100	15 - 6194	319
942137	09 - 14060	141	13474	12 - 7577	216	20656100	15 - 6194	319
H	12 - 5156	213	14668	15 - 1126	372	20656151	15 - 6194	319
H	12 - 7574	216	14668	15 - 1065	360	206562	15 - 6013	319

O.E.M. REPLACEMENT CROSS REFERENCE



CROSS REFERENCE 2014

OEM #	Our #	Page #	OEM #	Our #	Page #	OEM #	Our #	Page #
GRAVELY			GRAVELY			GRAVELY		
20715100	19 - 12863	450	34984	15 - 1065	360	59201000	10 - 14252	191
2074050	19 - 1388	472	3498451	15 - 1065	360	59202600	10 - 14230	191
21060	13 - 5714	264	355100	31 - 10772	1071	6267	12 - 7518	215
2124580	09 - 814	134	355100	31 - 5933	1071	7128800	06 - 5874	98
212850	15 - 6214	360	355100	31 - 8943	1071	715095	21 - 13998	526
2128500	15 - 6214	360	35925	09 - 484	133	72038	12 - 7496	215
21512500	19 - 9550	459	36778	09 - 6573	133	7214200	12 - 7477	215
21536900	19 - 9728	468	36880	12 - 7477	215	721660	12 - 5003	211
21541500	20 - 1358	498	36987	12 - 7515	215	721800	12 - 8428	221
21545100	19 - 12374	484	37797	08 - 3277	115	721950	12 - 7519	215
21692	12 - 7430	214	37823	09 - 6573	133	721960	12 - 7837	250
22063	13 - 7176	264	38199	09 - 814	134	721980	12 - 7492	215
23639	12 - 7612	216	38744	12 - 7535	215	7220000	12 - 7489	215
23640	12 - 7643	216	38745	12 - 7533	215	7220100	12 - 7516	215
25124	15 - 3339	361	38946	15 - 6194	319	722020	12 - 7535	215
25129	12 - 7519	215	38947	15 - 6013	319	722030	12 - 7533	215
25659	12 - 5003	211	41200	12 - 7505	215	722050	12 - 7505	215
26096	12 - 5055	212	41545	12 - 7478	215	7220600	12 - 7478	215
26114	12 - 7490	215	41963	12 - 7473	215	7220600	12 - 7478	215
26117	12 - 7469	215	42124	15 - 3381	361	7220800	12 - 7473	215
26122	12 - 7490	215	42206	12 - 7503	215	7220800	12 - 7473	215
26123	12 - 7470	215	43195	12 - 7482	215	722100	12 - 7503	215
26125	12 - 7576	216	43318	12 - 7530	215	722130	12 - 7530	215
26126	12 - 7484	215	43644	19 - 1388	472	72224	12 - 8717	250
26128	12 - 7434	214	44439	12 - 7522	215	722380	12 - 7482	215
26129	12 - 7521	215	44941	10 - 9307	173	72250	12 - 8760	250
26131	12 - 7474	215	45071	31 - 10772	1071	72258	12 - 8711	250
26132	12 - 7513	215	45071	31 - 8943	1071	72266	12 - 7837	250
26137	12 - 7436	214	45071	31 - 5933	1071	7226600	12 - 7837	250
26138	12 - 7512	215	45205	08 - 11217	110	7314800	13 - 5714	264
26139	12 - 7509	215	45205	08 - 8197	111	7316700	13 - 7176	264
26142	12 - 7522	215	45848	31 - 7675	1064	7327800	13 - 2189	264
26143	12 - 7513	215	46346	19 - 2844	472	8563900	19 - 2844	472
26147	12 - 7435	214	46998	15 - 6298	322	8707900	20 - 1347	34
26148	12 - 7508	215	46998	15 - 6181	360	876370	10 - 9307	173
26150	12 - 7439	214	46999	15 - 6303	324	87792	15 - 6181	360
3115200	31 - 1931	1061	46999	15 - 6180	334	8779200	15 - 6298	322
3115200	31 - 8601	1063	47685	15 - 6171	362	8779251	15 - 6181	360
31912	12 - 7492	215	48864	15 - 6285	361	8779251	15 - 6298	322
32322	12 - 7516	215	49029	12 - 8717	250	8781851	15 - 6285	361
34286	13 - 2189	264	51213	12 - 7837	250	8803700	31 - 8910	1059
34289	12 - 7532	215	5163P1	12 - 7474	215	88166	15 - 3381	361
34332	12 - 7478	215	52586	08 - 11217	110	88616	15 - 1066	345
34346	12 - 7592	216	52586	08 - 8197	111	8861651	15 - 1066	345
34382	12 - 7469	215	52927	15 - 6203	361	886670	15 - 6203	361
34426	06 - 5874	98	52928	15 - 6204	361	8866751	15 - 6203	361
345490	31 - 7675	1064	52929	15 - 6213	361	8866800	15 - 6204	361
34640	31 - 8910	1059	540890	09 - 6573	133	8866851	15 - 6204	361
34768	19 - 2844	472	5412000	09 - 484	133	886690	15 - 6213	361
34775	23 - 2750	570	54228	09 - 8971	136	8899300	15 - 1066	345
34776	19 - 1388	472	5520100	09 - 8522	148	8899300	15 - 6013	319
34864	12 - 7473	215	5890320	08 - 8197	111	89046	15 - 3339	361
34944	12 - 7489	215	58903200	08 - 11217	110	8904651	15 - 3339	361



O.E.M. REPLACEMENT CROSS REFERENCE

2014 CROSS REFERENCE

OEM #	Our #	Page #	OEM #	Our #	Page #	OEM #	Our #	Page #
GRAVELY			GREAT DANE			HERR		
89796	15 - 6180	334	TCU18744	07 - 6916	106	B225-M6	36 - 4360	1174
8979600	15 - 6180	334	GREEN MACHINE			N110-24	36 - 8055	1177
8979600	15 - 6303	324	167901	27 - 30169	659	N110-26	36 - 12044	1177
8979651	15 - 6180	334	170078	27 - 7208	490	N110-L7	36 - 1600	1174
89838	15 - 6171	362	20195	27 - 14368	641	N147-A7	36 - 1644	1174
8983851	15 - 6171	362	20735	27 - 14369	641	N148-A7	36 - 1646	1174
92027	09 - 9563	137	237001	16 - 10712	421	N152-M6	36 - 4391	1174
9212P2	15 - 2164	361	237001	16 - 2663	421	N157-A7	36 - 1656	1174
9231	13 - 731	36	237001	16 - 6276	422	N158-M6	36 - 1640	1174
A408	12 - 7616	216	300285	26 - 2444	633	N174-M6	36 - 1634	1175
A409	12 - 7603	216	305901	27 - 3122	486	N176-A7	36 - 1660	1175
M474	12 - 7577	216	309849	26 - 7927	610	N217-M6	36 - 1618	1174
M475	12 - 7575	216	309889	27 - 7926	491	N230-11	36 - 8058	1177
GREAT DANE			309889	27 - 8080	495	N230-A7	36 - 4307	1176
200262	10 - 12778	191	309891	27 - 5864	486	N231-L7	36 - 4355	1176
AM104403	31 - 9664	1066	4600LP	27 - 7411	75	N265-L7	36 - 1604	1175
C39949	15 - 3434	362	HABAN			N304-11	36 - 8061	1177
C39949	15 - 10174	318	30412	13 - 2916	263	N304-A7	36 - 4381	1175
C39949	15 - 9969	319	HAHN ECLIPSE			HILLIARD		
D18000	10 - 11858	167	1362-P	12 - 5003	211	8444-15-003-B	04 - 12467	80
D18007	12 - 10625	250	308442	12 - 5080	212	8444-47-007-B	04 - 12466	80
D18030	10 - 12778	191	326985	09 - 8199	131	8444-47-023	04 - 12468	80
D18031	13 - 10160	278	326985	09 - 481	131	LD45-4L	04 - 10390	80
D18032	13 - 13127	277	451179	13 - 2176	263	LD45-5L	04 - 10389	80
D18032	13 - 6572	264	451182	13 - 719	36	HOFFCO		
D18037	15 - 9968	319	451293	13 - 722	36	206073	26 - 2444	633
D18037	15 - 3404	347	HASTINGS			207575	37 - 3010	633
D18037	15 - 10173	318	AF2342	19 - 9728	468	208645	27 - 6966	485
D18044	13 - 9755	277	HERR			2122085	27 - 6881	659
D18048	10 - 12383	191	081-M6	36 - 4396	1176	HOMELITE/JACOBSEN		
D18083	13 - 10161	278	084-M6	36 - 1621	1176	010119	12 - 7475	215
D18084	13 - 10079	278	183-11	36 - 8062	1177	010390	12 - 7468	215
D18086	15 - 3403	347	183-A7	36 - 1680	1176	010531	12 - 7574	216
D18087	12 - 10623	250	190-L7	36 - 1680	1176	010535	12 - 7574	216
D18097	20 - 9650	515	191-L7	36 - 1617	1176	010536	12 - 7586	216
D18303	12 - 10893	250	193-A7	36 - 1619	1176	010537	12 - 7615	216
D18314	13 - 9756	277	266-L7	36 - 1602	1175	010672	12 - 7574	216
D28028	12 - 10626	250	266-M6	36 - 1603	1175	010673	12 - 7578	216
D28029	12 - 10627	250	3/8-7-1	36 - 1689	1177	010917	12 - 7478	215
D28030	12 - 10628	250	3/8-7-2	36 - 1688	1177	01123	20 - 11510	51
D28031	12 - 10629	250	325-7-2	36 - 1690	1177	011419	12 - 7471	215
D28041	31 - 9664	1066	355-11	36 - 12039	1174	011496	12 - 7500	215
D28041	31 - 9664	1066	355-A7	36 - 4387	1174	011497	12 - 7471	215
D28105	13 - 10168	278	355-11	36 - 12035	1174	011621	12 - 7624	216
D38001	31 - 9663	1066	356-11	36 - 12035	1174	011649	12 - 7571	216
D38001	31 - 9663	1066	359-M6	36 - 1627	1174	011809	12 - 7614	216
D38005	31 - 9656	1064	364-11	36 - 12036	1177	012104	12 - 7478	215
D38085	31 - 9658	1066	404-7-1	36 - 1686	1177	012529	12 - 7429	214
D38155	10 - 12658	169	B224-M6	36 - 4359	1176	012795	12 - 7577	216
D48003	05 - 9757	91				013254	12 - 7430	214
GDA10017	10 - 12658	169						
GDA10122	10 - 14009	164						
TCA15075	31 - 10723	1060						

O.E.M. REPLACEMENT CROSS REFERENCE



CROSS REFERENCE 2014

OEM #	Our #	Page #	OEM #	Our #	Page #	OEM #	Our #	Page #
HOMELITE/JACOBSEN			HOMELITE/JACOBSEN			HOMELITE/JACOBSEN		
013267	12 - 7472	215	311650	12 - 7578	216	329299	12 - 7601	216
02500	39 - 8405	487	311809	12 - 7614	216	330018	12 - 7476	215
04393A	12 - 5053	212	312104	12 - 7478	215	330447	12 - 7510	215
06615	27 - 8239	487	312529	12 - 7429	214	330463	12 - 7519	215
07025	38 - 4996	1200	312571	12 - 7574	216	330503	12 - 7540	215
07522	12 - 7485	215	312711	12 - 7578	216	330527	12 - 7517	215
07870	12 - 7478	215	312795	12 - 7577	216	330559	12 - 7591	216
07913	12 - 5055	212	313254	12 - 7430	214	330675	12 - 7471	215
08832-01	27 - 9686	76	313267	12 - 7472	215	330719	15 - 1058	372
08832-02	27 - 9687	75	313775	12 - 5053	212	330719S	15 - 1058	372
09082	12 - 7443	214	314012	12 - 7485	215	330721	15 - 3346	372
09108	38 - 4996	1200	314042	12 - 5006	211	330790	12 - 7479	215
09255	12 - 7473	215	314207	12 - 7476	215	331594	12 - 7475	215
09255A	12 - 7473	215	314546	12 - 7472	215	331599	12 - 7511	215
09346A	12 - 7483	215	314564	12 - 7472	215	331672	12 - 7491	215
09503A	12 - 5006	211	314600	12 - 7611	216	331673	12 - 7494	215
09507	12 - 5005	211	314804	12 - 5053	212	331807	12 - 7429	214
122464	06 - 7709	97	314874	12 - 5055	212	331808	12 - 7437	214
123073	12 - 7534	215	315206	12 - 7497	215	331846	12 - 7494	215
158458	05 - 300	92	315375	12 - 7623	216	331847	12 - 7489	215
181767	27 - 10468	658	315402	12 - 7475	215	331860	12 - 7489	215
182222	05 - 7787	91	316899	12 - 7484	215	331876	12 - 7512	215
2058	12 - 5063	212	316910	12 - 7486	215	332111	12 - 7487	215
2058	12 - 7473	215	317375	12 - 7474	215	333719	12 - 7607	216
2308	39 - 8818	487	317749	12 - 7496	215	335453	12 - 7484	215
300759003	38 - 4995	48	324136	12 - 5053	212	335832	12 - 7481	215
304393	12 - 5052	212	324361	12 - 7431	214	335856	12 - 7482	215
307522	12 - 7485	215	325074	12 - 7527	215	336006	12 - 7481	215
307867	12 - 7476	215	325221	12 - 7609	216	336055	12 - 7437	214
307870	12 - 7478	215	325267	13 - 729	36	336219	12 - 7473	215
308042003	27 - 8521	660	325275	12 - 7486	215	336262	12 - 7475	215
308055002	27 - 9687	75	325856	12 - 7482	215	336263	12 - 7468	215
309082	12 - 7443	214	325877	12 - 7502	215	336485	12 - 7621	216
309255	12 - 7473	215	325910	12 - 7438	214	336488	12 - 7588	216
309502	12 - 5006	211	325983	12 - 7573	216	337818	12 - 7484	215
309507	12 - 5005	211	325984	12 - 7578	216	339396	12 - 7471	215
310046	12 - 7441	214	326217	12 - 7626	216	342307	12 - 7529	215
310119	12 - 7475	215	326227	12 - 7440	214	342449	41 - 917	1221
310391	12 - 7468	215	326253	12 - 7433	214	342940	12 - 7438	214
310427	09 - 7162	134	326308	12 - 7512	215	343015	12 - 7475	215
310427	09 - 10303	135	326484	15 - 1058	372	343050	12 - 7511	215
310535	12 - 7574	216	326946	12 - 7613	216	343093	12 - 7433	214
310536	12 - 7586	216	328821	12 - 7526	215	343359	12 - 7617	216
310537	12 - 7615	216	328825	12 - 7529	215	343833	12 - 7506	215
310538	12 - 7583	216	328826	12 - 7521	215	344218	12 - 7508	215
310672	12 - 7574	216	328891	12 - 7523	215	344219	12 - 7508	215
310673	12 - 7578	216	328892	12 - 7526	215	344489	12 - 7506	215
310724	12 - 7468	215	328973	12 - 7506	215	344947	12 - 7472	215
310917	12 - 7478	215	329184	12 - 7626	216	344948	12 - 7527	215
311419	12 - 7471	215	329193	12 - 7533	215	344983	12 - 7533	215
311496	12 - 7500	215	329205	12 - 7489	215	345050	09 - 7162	134
311621	12 - 7624	216	329207	12 - 7479	215	345050	09 - 10303	135
311649	12 - 7571	216	329253	12 - 7533	215	345129	12 - 7489	215



O.E.M. REPLACEMENT CROSS REFERENCE

2014 CROSS REFERENCE

OEM #	Our #	Page #	OEM #	Our #	Page #	OEM #	Our #	Page #
HOMELITE/JACOBSEN			HOMELITE/JACOBSEN			HOMELITE/JACOBSEN		
348720	12 - 7515	215	64083-1	38 - 1400	48	JA-992251	12 - 7507	215
349079	12 - 7520	215	65107	37 - 1701	1180	JAC-991488	12 - 7516	215
350759	09 - 10303	135	6615	27 - 8239	487	PS01502	27 - 8566	77
350759	09 - 7162	134	69141	39 - 1547	487	PS02071	27 - 11038	647
358577	12 - 7474	215	69217	37 - 3009	1180	PS03380	38 - 4995	48
364120	12 - 5004	211	69254-1A	39 - 8397	1214	REM1415	12 - 5053	212
372780	12 - 5053	212	69254-2	39 - 8397	1214	UP05137	27 - 11038	647
390008	12 - 7490	215	69451	38 - 7259	519	UP05631	39 - 8818	487
390188	12 - 7487	215	69923	38 - 13903	501	UP06516	38 - 1399	48
390285	12 - 7488	215	69923	38 - 3903	48	UP06807	39 - 1550	487
390422	12 - 5065	212	70310-98	20 - 8645	506	UP07386	39 - 8405	487
390562	12 - 7498	215	870217001	24 - 10188	596			
390704	12 - 7493	215	883201	27 - 9686	76	HONDA		
392406	12 - 7467	215	9108	38 - 4996	1200	06111-ZE2-405	23 - 9783	573
392410	12 - 7484	215	93039	39 - 8396	1214	06111-ZE3-405	23 - 9784	572
392433	12 - 7645	216	94456	39 - 6988	486	06111-ZE6-405	23 - 12593	572
392445	12 - 7471	215	94711-BS	31 - 9720	1077	06111-ZE7-406	23 - 12314	572
392545	12 - 7517	215	94711-CS	31 - 9720	1077	06111-ZF6-406	23 - 9732	573
392602	12 - 7492	215	94711A	31 - 9720	1077	06111-ZH7-405	23 - 9731	572
392606	12 - 7536	215	94711B	31 - 9720	1077	06111-ZH8-405	23 - 9782	573
400120	41 - 917	1221	94952	38 - 4996	1200	06111ZE1405	23 - 9843	572
46073	39 - 6511	486	97768-A	39 - 8287	1216	061A1-ZE0-000	23 - 9842	572
46687	39 - 8333	486	985308001	22 - 11974	547	061A1-ZE1-T01	23 - 9843	572
47867-A	39 - 8335	487	986117001	27 - 8566	77	061A1-ZE7-801	23 - 12314	572
49422	38 - 4995	48	98760	27 - 8238	487	06720-V10-030	41 - 5536	1225
500904	15 - 3346	372	98770-A	26 - 9045	610	08750-960-333	15 - 6458	364
501294	12 - 7438	214	98816	27 - 8566	77	1003375	41 - 5505	1224
518884	41 - 5506	1224	98818	27 - 8565	77	1003391	41 - 5505	1224
525294	12 - 7507	215	990152	05 - 300	92	12251-ZE0-800	23 - 9839	570
545121	12 - 7500	215	990385	41 - 5513	1223	12251-ZE2-800	23 - 9838	570
545171	12 - 7507	215	991296	41 - 5513	1223	12251-ZE3-800	23 - 9786	570
545294	12 - 7507	215	A-00440	39 - 8397	1214	12251-ZE3-W00	23 - 9786	570
545593	12 - 7508	215	A-00982-B	20 - 9652	516	12251-ZE6-000	23 - 14146	570
54620B	39 - 8334	486	A-03908	38 - 4996	1200	12251-ZE7-000	23 - 13515	570
546342	12 - 7576	216	A-55373-A	24 - 6710	599	12251-ZF1-800	23 - 9785	570
546343	12 - 7495	215	A-65170	37 - 1701	1180	12251-ZF1-800	23 - 9785	570
550489	20 - 13536	520	A-65178	39 - 3111	486	12251-ZF6-W00	23 - 13514	570
551761	12 - 7639	216	A-97910-A	27 - 8521	660	12251-ZH7-800	23 - 13516	570
551763	12 - 7581	216	A-98064-11	38 - 4302	1197	12251ZE2801	23 - 9838	570
551776	12 - 7480	215	A03006	27 - 9686	76	12251ZE3W01	23 - 9786	570
551778	12 - 7639	216	A07927A	12 - 5055	212	12251ZF6W01	23 - 13514	570
551779	12 - 7597	216	A29	12 - 5064	212	12251ZH7801	23 - 13516	570
552200	13 - 2188	263	D-04359	16 - 6261	422	1300663	12 - 7470	215
552200	13 - 12891	281	D-06615	27 - 8239	487	1300912	12 - 7480	215
59253	38 - 1399	48	D-98760	27 - 8238	487	13010-ZE1-013	23 - 11286	559
59253-1A	38 - 1399	48	D-98760-B	27 - 8238	487	13010-ZE2-013	23 - 11296	559
59254-1A	38 - 1399	48	D92702B	39 - 1547	487	13010-ZE6-013	23 - 11283	559
63225	39 - 8396	1214	DA-06486	20 - 8899	516	13010-ZF1-023	23 - 11290	559
63589	39 - 1550	487	DA-92701-C	20 - 9164	516	13010-ZF6-003	23 - 11302	559
63589-A	39 - 1550	487	DA-98912	27 - 9224	643	13101-ZE1-010	23 - 11285	564
63744-A	38 - 4972	519	DO-4359	16 - 6261	422	13101-ZE2-010	23 - 11293	564
63745-A	38 - 4972	519	JA-51888-4	41 - 5506	1224	13101-ZE3-000	23 - 11298	564
64083	38 - 1400	48	JA-990738	12 - 5085	212	13101-ZF6-W00	23 - 11301	564

O.E.M. REPLACEMENT CROSS REFERENCE



CROSS REFERENCE 2014

OEM #	Our #	Page #	OEM #	Our #	Page #	OEM #	Our #	Page #
HONDA			HONDA			HONDA		
13101-ZH7-010	23 - 11282	564	16100-ZJ1-892	22 - 13207	547	17211-Z37-W03	19 - 8906	461
13200-ZE0-000	23 - 9832	566	16100-ZL0-W51	22 - 13195	547	17211-ZA0-702	19 - 7042	462
13200-ZE1-000	23 - 9833	566	16100-ZM5-803	22 - 13205	547	17211-ZE7-W03	19 - 8906	461
13200-ZE2-000	23 - 9834	566	16100-ZM7-G17	22 - 13204	547	17211-ZF5-V01	19 - 11793	462
13200-ZE3-010	23 - 9837	566	16100-ZN2-811	22 - 13206	548	17211-ZG9-800	19 - 8903	461
13200Z0T800	23 - 9833	566	16100Z0D013	22 - 13203	547	17211-ZG9-M00	19 - 7980	460
13200Z1D000	23 - 9834	566	16100ZE6W01	22 - 13200	548	17211-ZL8-000	19 - 9953	461
13200ZE2010	23 - 9834	566	16100ZM7G18	22 - 13204	547	17211-ZL8-023	19 - 9953	461
13200ZE3020	23 - 9837	566	16155-883-005	22 - 10945	536	17211ZL8003	19 - 9953	461
14711-ZE0-010	23 - 9820	567	16212-ZL8-000	23 - 10481	578	17218-883-901	19 - 6687	461
14711-ZE3-000	23 - 9830	568	16221-883-800	23 - 10482	578	17218-888-003	19 - 2805	461
14711-ZF0-000	23 - 9822	567	16228-ZL8-000	23 - 10483	578	17218-888-003	19 - 7726	462
14711-ZF0-010	23 - 9822	567	16516-891-000	03 - 10855	74	17218-891-003	19 - 7726	462
14711-ZF1-000	23 - 9826	567	16561-ZE1-810	22 - 10857	532	17218-891-003	19 - 2807	462
14721-ZE0-010	23 - 9821	567	16561-ZE3-000	22 - 11839	532	17218-Z0A-810	19 - 12243	460
14721-ZE2-000	23 - 9829	568	16561-ZM0-000	22 - 11838	532	17218-ZE0-821	19 - 7045	462
14721-ZE3-000	23 - 9831	568	16562-ZE1-020	22 - 10856	529	17218-ZE1-821	19 - 6691	461
14721-ZF1-000	23 - 9827	567	16562-ZE2-000	22 - 10869	529	17218-ZE2-821	19 - 6693	461
15400-679-023	19 - 6681	483	16562-ZMO-000	22 - 10870	529	17218-ZE3-000	19 - 7725	460
15400-P0H-305	19 - 6681	483	16610-ZE1-000	22 - 10863	535	17218-ZF5-V00	19 - 11793	462
15400-PLM-A01PE19	19 - 6681	483	16700-Z0J-003	22 - 10875	535	17218-ZG9-800	19 - 8904	461
15400-PLM-A01PE19	13237	483	16700-ZL8-013	22 - 10875	535	17218-ZG9-M00	19 - 7979	460
15400-PR3-004	19 - 6681	483	16910-Z4E-S21	20 - 13357	496	17218-ZJ1-810	19 - 10961	460
15410-MCJ-003	19 - 10883	483	16950-ZG9-M02	20 - 10478	511	17218ZE0505	19 - 7045	462
15410-MFJ-D01	19 - 10883	483	16950ZG9M03	20 - 10478	511	17218ZE1507	19 - 6691	461
15410-MJ0-004	19 - 6681	483	16955-ZE1-000	20 - 10484	512	17218ZE2505	19 - 6693	461
15410-ZJ4-999AH19	19 - 6681	483	16955ZE1010	20 - 10484	512	17218ZE3505	19 - 7725	460
15410MJ0405	19 - 6681	483	17010-ZJ1-000	19 - 10679	460	17218ZE6505	19 - 7726	462
15558-ZJ1-010AH23	12110	585	17210-759-013	19 - 10680	462	17218ZE6505	19 - 2805	461
15600-ZE1-000	23 - 10471	584	17210-Z1V-003	19 - 6684	461	17220-ZM0-000	19 - 10477	461
15600-ZG4-003	23 - 10864	584	17210-Z6L-010	19 - 13640	460	17220ZM0030	19 - 10477	461
15600ZE1003	23 - 10471	584	17210-ZE0-505	19 - 7044	462	17221-889-003	19 - 6689	461
15650-ZM0-801	23 - 10467	584	17210-ZE0-822	19 - 7044	462	17231-Z0L-000	19 - 10477	461
16010-883-015	23 - 7234	578	17210-ZE1-003	19 - 6684	461	17232-891-000	19 - 6708	462
16010-ZE2-812	23 - 13549	578	17210-ZE1-517	19 - 6690	461	172A-188-3902	19 - 6686	461
16010-ZE2-812	22 - 14272	541	17210-ZE1-821	19 - 6690	461	17510-ZE1-020ZA20	10906	512
16011-ZA0-931	22 - 10475	536	17210-ZE1-822	19 - 6690	461	17510-ZE1-0302A20	10906	512
16011-ZE0-005	22 - 10463	536	17210-ZE2-505	19 - 6692	461	17510-ZE3-010ZA20	11016	512
16013-ZA0-931	22 - 10476	534	17210-ZE2-515	19 - 6692	461	17510-ZE3-020ZA20	11016	512
16013-ZE0-005	22 - 10474	534	17210-ZE2-822	19 - 6692	461	17510ZE1030ZA20	10906	512
16015-ZE1-811	22 - 10479	534	17210-ZE3-505	19 - 7712	460	17510ZE3030ZA20	11016	512
16015-ZE8-005	22 - 10866	534	17210-ZE6-505	19 - 7713	462	17620-ZE7-000	20 - 12127	513
16100-Z0D-003	22 - 13203	547	17210-ZE7-013	19 - 6684	461	17620-ZH2-WOO	20 - 9603	513
16100-ZE1-825	22 - 13193	547	17210-ZE7-505	19 - 6684	461	17620-ZH7-013	20 - 9604	513
16100-ZE2-W71	22 - 13196	548	17210-ZE8-013	19 - 2808	462	17620-ZH7-023	20 - 9603	513
16100-ZE3-V01	22 - 13198	548	17210-ZF5-505	19 - 2808	462	17620-ZL8-003	20 - 10018	513
16100-ZE6-055	22 - 13200	548	17210-ZJ1-842	19 - 10678	460	17620-ZL8-013	20 - 10018	513
16100-ZE7-W21	22 - 13202	547	17210ZA0506	19 - 7042	462	17620ZG9000	20 - 12127	513
16100-ZF6-V01	22 - 13199	548	17211-890-023	19 - 6688	461	17620ZL8023	20 - 10018	513
16100-ZG9-803	22 - 13201	548	17211-891-004AF	19 - 6688	461	17910-VA3-003	03 - 10118	59
16100-ZH7-W61	22 - 13192	547	17211-896-000	19 - 8905	462	17910-VA4-800	03 - 8832	59
16100-ZH8-W61	22 - 13194	547	17211-899-000	19 - 12801	460	17910VA3S01	03 - 10118	59
16100-ZH9-W21	22 - 13197	548	17211-Z0A-013	19 - 10879	460	17910VB5A01	03 - 8832	59



O.E.M. REPLACEMENT CROSS REFERENCE

2014 CROSS REFERENCE

OEM #	Our #	Page #	OEM #	Our #	Page #	OEM #	Our #	Page #
HONDA			HONDA			HONDA		
18300-ZH9-N00	18 - 14594	441	28400-ZH8-033	26 - 12079	623	3526985	41 - 5522	1223
18310-ZE2-013	18 - 10271	441	28400-ZM3-003	26 - 10466	623	36100-ZE1-015	31 - 10859	1071
18310-ZE2-W00	18 - 10272	441	28400-ZM3-0032A	26 - 10466	623	425-1196004	15 - 50113	363
18310-ZE2-W61	18 - 14449	441	28400-ZM3-0ZA	26 - 10466	623	42700-VK6-010ZA	07 - 13399	101
18310-ZE3-003	18 - 9578	441	28400-ZMO-003	26 - 9985	623	42700-VK6-020ZA	07 - 13399	101
18310-ZF1-000	18 - 9577	441	28400-ZOL-V20ZA	26 - 14643	623	42751-VK6-010	08 - 13400	111
18310-ZM0-000	18 - 14450	441	28400Z0T003ZB	26 - 12079	623	42861-VB5-J00	08 - 13401	111
18320-ZE2-W61	18 - 14451	441	28400ZH8033YA	26 - 12079	623	44700-VK6-010ZA	07 - 13398	101
18320-ZE2-W62	18 - 14451	441	28415-ZG9-802	26 - 13355	609	44700VK6020ZA	07 - 13398	101
18333-ZK6-Y00	23 - 13517	578	28420-ZH8-003	26 - 10858	609	53125-VA4-K10	10 - 12749	160
18381-ZE2-W10	23 - 13518	578	28420-ZH8-013	26 - 10858	609	54411-VB3-800	10 - 8504	171
18381-ZE6-820	23 - 13519	578	28421-ZE2-WO1	26 - 10867	609	54510-VB5-800	05 - 8568	71
18381-ZH8-800	23 - 13520	578	28421-ZE3-003	26 - 10868	609	54520-VA3-801	03 - 10119	71
18381-ZL8-305	23 - 10480	578	28421-ZH8-801	26 - 12129	609	54520-VA3-P03	03 - 10120	72
18381ZH8801	23 - 13520	578	28422-ZH8-013	26 - 9180	609	54520-VA3-P04	03 - 10120	72
22100-VB3-803	05 - 12126	89	28434-ZE1-711	26 - 10472	611	54520-VB5-P01	03 - 10121	72
22100-VB3-804	05 - 12126	89	28442-883-000	26 - 2422	630	54520-VB5-POO	03 - 10121	72
22100-VB3-805	05 - 12126	89	28442-896-700	26 - 2421	630	54530-VA3-JO3	03 - 10122	68
22100-VB5-804	05 - 12126	89	28442-ZE1-003	26 - 9526	630	54530-VB3-802	03 - 10124	68
22100-VB5-804	05 - 12126	89	28442-ZE1-711	26 - 9528	630	54530-VE0-003	03 - 10123	68
22100-VB5-805	05 - 12126	89	28442-ZE1-713	26 - 9528	630	6672448	41 - 5536	1225
22100-VB5-807	05 - 12126	89	28442-ZE6-003	26 - 9505	630	6672448	41 - 5537	1223
22100-VB5-L01	05 - 12126	89	28442-ZH8-003	26 - 9527	630	72461-723-700	29 - 8608	666
22431-723-672	12 - 7581	216	28444-ZE2-W01	26 - 10470	611	72465-723-700	29 - 8609	666
22431-723-750	12 - 7578	216	28447-878-810	26 - 2424	630	72511-758-L00	15 - 6151	363
22431-723-751	12 - 7578	216	28461-ZE1-003	25 - 9065	605	72511-763-A00	15 - 6153	365
22431-723-752	12 - 7578	216	28461-ZE1-013	25 - 9065	605	72511-771-L00	15 - 6151	363
22431-727-003	12 - 7584	216	28461-ZG0-004	25 - 9114	605	72511-772-L00	15 - 6153	365
22431-731-671	12 - 7581	216	28461-ZH8-003	25 - 10871	605	72511-960-004	15 - 2160	364
22431-736-003	12 - 7472	215	28461-ZL8-003	25 - 10473	604	72511-VA2-690	15 - 2160	364
22431-738-701	12 - 7475	215	28461ZH8013	25 - 10871	605	72511-VA4-641	15 - 6092	364
22431-738-A01	12 - 7476	215	30500-ZE1-033	31 - 10462	1077	72511-VA4-840	15 - 50101	363
22431727013	12 - 7584	216	30500-ZE2-023	31 - 12083	1077	72511-VA5-700	15 - 50098	363
22432-732-013	12 - 7573	216	30500-ZF6-W02	31 - 12083	1077	72511-VA5-J00	15 - 6787	363
22432-732-671	12 - 7574	216	30500ZE1073	31 - 10462	1077	72511-VA9-010	15 - 50102	363
22432-736-003	12 - 7578	216	30700-ZE1-000	24 - 10865	599	72511-VB3-B51	15 - 50106	363
23161-963-003	12 - 7438	214	31200-ZA1-003	26 - 11489	614	72511-VB3-E41	15 - 50160	364
23510-VB5-803	05 - 13371	92	31200-ZE8-801	26 - 11489	614	72511-VE1-001	15 - 6428	363
23511-VB3-801	05 - 12477	92	31200-ZF5-L32	26 - 12481	614	72511-VE1-010	15 - 6428	363
23520-VB5-803	05 - 13372	92	31200-ZH9-003	26 - 11490	614	72511-VE1-020	15 - 6428	363
28400-883-040ZC	26 - 9063	623	31200-ZH9-013	26 - 11490	614	72511-VE1-651	15 - 50153	364
28400-883-505	26 - 9063	623	31200-ZJ1-004	26 - 11079	613	72511-VE1-652	15 - 50153	364
28400-ZE1-003ZF	26 - 9064	623	31200-ZJ1-841	26 - 12087	614	72511-VE2-000	15 - 6431	364
28400-ZE2-W01ZN	26 - 10469	624	31200-ZJ1-842	26 - 12087	614	72511-VG3-000	15 - 6428	363
28400-ZE2-W02ZN	26 - 10469	624	31200-ZJ4-003	26 - 11079	613	72511-VG4-K00	15 - 6431	364
28400-ZE3-W02ZP	26 - 10379	623	31200-ZJ4-831	26 - 12065	614	72511-VK6-000	15 - 12615	364
28400-ZE3-WO1ZP	26 - 10379	623	31200ZJ4832	26 - 12065	614	72511VE1E50	15 - 50153	364
28400-ZE8-811ZG	26 - 9998	624	31204-ZA0-003	26 - 12050	613	72512-750-305	15 - 3438	363
28400-ZG9-802	26 - 12019	624	31210-ZE1-023	26 - 11488	614	72513-750-305	15 - 3437	363
28400-ZG9-803	26 - 12019	624	31210-ZE3-013	26 - 10674	613	72513-751-020	15 - 2165	365
28400-ZH8-0132A	26 - 9064	623	31210ZE3023	26 - 10674	613	72513-758-N00	15 - 6131	363
28400-ZH8-013YA	26 - 9064	623	31600-890-951	31 - 9209	1080	72521-730-003	41 - 5505	1224
28400-ZH8-023YA	26 - 12079	623	31670-VMS-000	32 - 11998	1094	72521-747-000	41 - 5526	1225

O.E.M. REPLACEMENT CROSS REFERENCE



CROSS REFERENCE 2014

OEM #	Our #	Page #	OEM #	Our #	Page #	OEM #	Our #	Page #
HONDA			HUFFY			HUSQVARNA		
72522-747-000	41 - 5526	1225	9992	13 - 729	36	503 28 13-20	22 - 13286	548
72522-747-010	41 - 5526	1225				503 44 32-01	38 - 9227	498
72523-747-000	41 - 5526	1225	HUSQVARNA			503 50 39-01	39 - 9638	1209
72523-747-010	41 - 5526	1225	102164	42 - 14184	1231	503 50 39-02	39 - 9638	1209
72531-758-L00	15 - 6150	363	102603	10 - 11444	167	503 53 68-02	39 - 9637	1209
72531-771-L00	15 - 6150	363	105476	15 - 6026	334	503 54 39-01	25 - 7290	605
72531-VE2-001	15 - 6430	364	106884	12 - 12653	229	503 61 33-71	39 - 9644	1208
72531-VE2-020	15 - 6430	364	145755	05 - 14023	68	503 69 10-73	39 - 13616	1208
72531-VK6-010	15 - 14657	364	156971	12 - 10830	226	503 85 99-01	26 - 13533	633
72531-ZE2-010	15 - 6430	364	162	39 - 4793	48	503 93 90-03	39 - 13616	1208
72552-730-003	41 - 5505	1224	180	39 - 4793	48	503 93 90-05	39 - 13616	1208
72570-VF9-650-AH	27 - 11830	640	184588	05 - 14023	68	503 9800 71	36 - 13585	1177
72580-VF9-730AH	27 - 11831	640	187256	15 - 14459	331	503-08-97-02	39 - 11588	1215
75150-VA3-JO1	05 - 10862	92	192507	31 - 14222	1072	503-53-20-71	39 - 11057	1209
75150-VK6-000	05 - 10862	92	2100	39 - 4793	48	503-71-79-01	39 - 11588	1215
76131-VE4-003	13 - 5869	263	280	39 - 4793	48	503-81-45-03	39 - 10778	488
76131-VE4-003	13 - 734	36	285	39 - 4793	48	503-9014-01	31 - 12082	1077
76153-736-010	41 - 13043	1228	32S009A1PS	35 - 13190	1161	503169171	39 - 12631	1209
76181-750-003	12 - 7611	216	380	39 - 4793	48	5032890-05	39 - 9918	1209
76181-751-003	12 - 7616	216	405143	12 - 12286	225	5032890-11	39 - 9919	1209
76181-751-0030	12 - 7616	216	408381	12 - 13501	228	503289017	39 - 9917	1209
76181-751-701	12 - 7612	216	427984	15 - 13498	368	503503903	39 - 9638	1209
76181-751-7010	12 - 7612	216	427985	15 - 13500	368	503609102	39 - 12631	1209
76181-763-A000	12 - 7618	216	429532	12 - 13499	228	503609108	39 - 12631	1209
76182-751-013	12 - 7598	216	433499X460	07 - 13495	103	503609171	39 - 12629	1208
76182-751-0130	12 - 7598	216	44	39 - 4793	48	503609172	39 - 12631	1209
76182-758-M01	12 - 7608	216	444	39 - 4793	48	503611071	39 - 12630	1208
76184-751-7	12 - 7608	216	480	39 - 4793	48	503758171	39 - 12632	1209
76184-772-003	12 - 7472	215	4810-75100	26 - 14656	624	503758172	39 - 12632	1209
76322-747-A10	41 - 5522	1223	4898H	10 - 314	39	503859901	26 - 13533	633
76322-V10-010	41 - 5537	1223	501 40 22-01	37 - 3012	1180	503980002	36 - 13585	1177
76322-V10-020	41 - 5537	1223	501 43 14-02	20 - 13363	516	504016802	39 - 12632	1209
81320-VB5-J00	28 - 8666	663	501 46 04-01	37 - 3011	1180	504188101	15 - 13335	366
90102-732-010	41 - 5540	1222	501 52 04-01	37 - 3037	1180	504188201	15 - 13334	365
90105-960-710	17 - 8640	435	501 52 04-02	37 - 3037	1180	504190401	15 - 50292	365
90114-SA0-000	41 - 5540	1222	501 53 71-01	39 - 6440	1214	5055445	15 - 13333	365
91201-890-003	23 - 11990	557	501 55 14-02	25 - 7290	605	505544601	15 - 50293	365
91201-Z0T-801	23 - 11989	557	501 62 87-01	39 - 9630	1217	506 15 55-06	39 - 13015	1208
91201-ZE3-004	23 - 11991	557	501 63 01-01	37 - 3082	1180	506 231901	39 - 12516	488
91202-883-005	23 - 11989	557	501 63 02-01	37 - 3011	1180	506 25 89-01	37 - 13056	1180
96150-60020-10	09 - 8525	131	501 69 94-01	39 - 9631	1217	506 26 67-02	12 - 13118	251
GXV120	23 - 12593	572	501 70 67-01	37 - 3048	1180	506 58 91-01	05 - 8764	72
			501 76 31-01	37 - 3023	1180	506 66 87-01	15 - 6466	365
			501 76 56-02	20 - 9561	516	506 66 87-01	15 - 6093	365
HOWARD			501 80 71-01	39 - 9627	488	506 67 65-01	15 - 6466	365
02-422	31 - 9656	1064	501 81 92-01	39 - 9649	1214	506 67 65-01	15 - 6093	365
02-425	31 - 9659	1066	501 81 96-02	20 - 9562	516	506 75 15-01	15 - 50111	365
09-058	31 - 9660	1066	50169998-01	39 - 9917	1209	506 90 96-01	31 - 9664	1066
			502 10 03-03	22 - 13286	548	506 9663-01	15 - 6489	366
HUFFMAN			502 50 70-01	32 - 14626	1092	506 9697-01	15 - 6488	368
10890	13 - 718	36	503 26 02-04	39 - 4860	1213	506-14-57-01	39 - 9955	488
18090	13 - 718	36	503 26 02-05	39 - 4861	1213	506-14-58-01	39 - 9956	488
24392	13 - 2176	263	503 28 10-16	22 - 13287	548	506-26-34-01	39 - 10779	487



O.E.M. REPLACEMENT CROSS REFERENCE

2014 CROSS REFERENCE

OEM #	Our #	Page #	OEM #	Our #	Page #	OEM #	Our #	Page #
HUSQVARNA			HUSQVARNA			HUSQVARNA		
506-88-52-01	15 - 50141	367	532 13 84-97	15 - 6218	331	532 19 30-03	17 - 12280	435
506016401	39 - 13588	1217	532 13 84-98	15 - 6125	332	532 19 31-97	13 - 11634	270
506263402	39 - 10779	487	532 13 89-71	15 - 6125	332	532 19 39-57	15 - 12240	331
506268601	39 - 13133	488	532 13 95-73	12 - 9368	223	532 19 59-45	13 - 12378	271
506269101	39 - 13132	488	532 13 97-75	15 - 12563	332	532 19 61-03	12 - 11863	224
506367101	39 - 12888	488	532 14 00-67	12 - 8464	223	532 19 61-06	13 - 13175	269
506367202	39 - 12887	488	532 14 04-01	31 - 11219	1069	532 19 61-06	13 - 13179	269
506690001	41 - 5541	1222	532 14 04-02	31 - 11219	1069	532 19 72-42	12 - 11864	224
506714001	41 - 5541	1222	532 14 04-03	31 - 11219	1069	532 19 72-53	12 - 11867	224
510201201	12 - 12653	229	532 14 26-00	10 - 9910	164	532 19 73-79	13 - 13179	269
510201301	12 - 10824	260	532 14 42-00	12 - 7531	215	532 40 31-07	15 - 12974	333
5120254501	10 - 12812	162	532 14 42-00	12 - 8516	223	532 40 31-07	15 - 12721	333
516-40-0500	15 - 50031	367	532 14 49-59	12 - 9697	223	532 40 53-80	15 - 12242	333
520 75 73-02	39 - 12885	1209	532 14 50-28	10 - 9912	164	532 40 67-12	15 - 9810	332
520-75-73-04	39 - 12885	1209	532 14 67-63	13 - 12620	270	532 40 80-07	12 - 14116	225
520757303	39 - 12885	1209	532 14 87-63	12 - 9698	223	532 40 80-10	12 - 14117	225
521981501	15 - 14391	368	532 1463-23	05 - 14623	68	532 40 83-81	12 - 13501	228
521981601	15 - 14392	369	532 15 24-43	15 - 9170	329	532 42 82-87	23 - 6783	586
522449503	15 - 50290	366	532 15 24-43	15 - 6437	329	532 42 95-32	12 - 13499	228
522795901	12 - 10823	260	532 15 35-32	13 - 9148	271	532 42 96-36	12 - 13251	225
525525901	15 - 14078	368	532 16 08-89	10 - 9911	164	532-121305	31 - 9664	1066
528 07 40-01	24 - 14415	596	532 16 38-19	15 - 6437	329	532-137644	10 - 11142	179
530-029811	39 - 12485	487	532 16 38-19	15 - 9170	329	532-170140	12 - 7556	215
531 00 50-09	15 - 50141	367	532 17 34-34	13 - 9121	270	532-174356	10 - 11014	185
531 00 50-11	15 - 6093	365	532 17 34-35	13 - 9148	271	532-1798-31	05 - 5620	92
531 00 50-11	15 - 6466	365	532 17 34-36	13 - 7180	271	532-182419	10 - 11142	179
531 30 07-69	12 - 9698	223	532 17 34-37	13 - 11632	269	532-187925	09 - 5618	134
531 30 07-71	12 - 10077	224	532 17 34-38	13 - 9376	269	532-193406	10 - 11142	179
531 30 73-89	19 - 12861	450	532 17 39-01	13 - 12661	270	532109553	31 - 9659	1066
531 30 73-89	19 - 6929	483	532 17 39-20	15 - 9907	330	5321216-87	10 - 6813	201
531 30 73-89	19 - 12863	450	532 17 39-21	15 - 10377	329	532122147	31 - 2932	1069
531-00-75-85	15 - 6489	366	532 17 39-21	15 - 12475	322	532122147	31 - 10794	1069
531002513	41 - 5541	1222	532 17 43-60	10 - 12308	185	532124035	10 - 13225	181
531005010	15 - 50111	365	532 17 43-68	12 - 10076	224	532127783	13 - 9849	269
531211017	15 - 50289	367	532 17 43-69	12 - 10077	224	532127842	15 - 6124	331
531300767	12 - 10232	224	532 17 48-73	07 - 6916	106	532130794	10 - 12723	184
532 10 14-77	10 - 1171	201	532 17 48-83	12 - 10232	224	532130794	10 - 8479	184
532 10 24-03	13 - 9377	269	532 17 50-80	13 - 11635	270	532130969	12 - 8511	222
532 10 90-81	31 - 10772	1071	532 17 58-20	13 - 11633	269	532137152	10 - 9521	184
532 10 99-46	31 - 10772	1071	532 17 60-84	15 - 6495	329	532137553	10 - 9520	184
532 11 04-85	09 - 8507	132	532 17 79-68	13 - 11634	270	532137646	10 - 8549	184
532 12 16-57	10 - 8649	200	532 18 00-54	15 - 9907	330	532139123	13 - 10396	269
532 12 17-05	10 - 8647	201	532 18 72-54	15 - 11180	331	532139245	13 - 9849	269
532 12 92-06	13 - 9148	271	532 18 72-54	15 - 13239	331	532140186	13 - 12271	271
532 12 98-61	13 - 7180	271	532 18 72-55	15 - 13239	331	532140218	12 - 8781	223
532 12 98-95	09 - 442	134	532 18 72-55	15 - 12121	323	532140294	12 - 9336	223
532 13 14-94	13 - 9376	269	532 18 72-56	15 - 13239	331	532140301	31 - 9623	1060
532 13 39-57	07 - 6916	106	532 18 72-56	15 - 11180	331	532140401	31 - 11218	1069
532 13 41-48	15 - 6190	331	532 18 72-92	10 - 11590	185	532140401	31 - 11219	1069
532 13 41-49	15 - 6189	332	532 18 99-93	13 - 11635	270	532140527	20 - 8935	514
532 13 41-49	15 - 6262	332	532 1845-96	05 - 14623	68	532141226	31 - 10794	1069
532 13 68-19	10 - 8648	200	532 19 28-72	10 - 11592	185	532141226	31 - 2932	1069
532 13 84-97	15 - 6124	331	532 19 30-03	17 - 14457	435	532141416	12 - 9337	223

O.E.M. REPLACEMENT CROSS REFERENCE



CROSS REFERENCE 2014

OEM #	Our #	Page #	OEM #	Our #	Page #	OEM #	Our #	Page #
HUSQVARNA			HUSQVARNA			HUSQVARNA		
532143651	10 - 9519	184	532191273	12 - 11034	224	539102652	13 - 9868	278
532144921	31 - 9158	1059	532192507	31 - 14222	1072	539103257	13 - 12473	278
532145499	31 - 9158	1059	532192507	31 - 5933	1071	539103258	13 - 12474	278
532145673	31 - 8943	1071	532193195	13 - 11635	270	539106884	12 - 12653	229
532145673	31 - 10772	1071	532193350	31 - 12327	1059	539111949	12 - 11032	260
532145755	05 - 14623	68	532194326	13 - 13178	269	539114820	10 - 13091	192
532146154	31 - 8943	1071	532194327	13 - 13179	269	539131383	10 - 13091	192
532146154	31 - 10772	1071	532197725	20 - 8935	514	539919078	13 - 12891	281
5321463-23	05 - 14623	68	532199534	13 - 12385	271	539919078	13 - 2188	263
532146323	05 - 14623	68	532401545	31 - 12091	1067	544-22-28-02	39 - 11057	1209
532153535	13 - 7180	271	532405143	12 - 12286	225	544018401	31 - 12082	1077
532153664	31 - 9665	1066	532408019	12 - 14512	225	544090 84-02	12 - 13118	251
532154855	31 - 9158	1059	532411933	31 - 11218	1069	544102701	15 - 50297	366
532154959	31 - 9656	1064	532411933	31 - 11219	1069	544102801	15 - 13335	366
532156971	12 - 10008	223	532411935	31 - 11219	1069	544103001	15 - 13334	365
532156971	31 - 10794	1069	532411935	31 - 11218	1069	544175701	15 - 50294	368
532158913	31 - 9158	1059	532419274	15 - 12957	333	544175801	15 - 50291	369
532159705	15 - 6495	329	532425162	20 - 8935	514	544222902	39 - 12630	1208
532160395	10 - 13225	181	532428454	12 - 14513	225	544435001	39 - 9919	1209
532160784	31 - 9663	1066	532430220	20 - 8935	514	574481101	15 - 14077	368
532161588	12 - 5116	212	532440620	05 - 5620	92	574845601	12 - 13442	229
532161588	12 - 7526	215	535-4294-01	15 - 50287	367	574845602	12 - 13443	229
532163088	31 - 9654	1063	537-04-41-02	39 - 13586	1212	574845603	12 - 13444	229
532163968	31 - 7015	1060	537092501	39 - 13095	1216	574870801	15 - 13361	367
532163968	31 - 12685	1060	537109 31-01	26 - 13584	633	574870801	15 - 13367	367
532165482	10 - 9575	184	537186301	27 - 12520	487	575-26-91-03	39 - 10778	488
532165579	10 - 9574	184	537201901	39 - 13588	1217	575265901	15 - 14076	368
532165626	13 - 13622	270	537215202	20 - 9562	516	577199901	05 - 8764	72
5321694-17	31 - 9656	1064	539 100-340	15 - 6500	366	581075501	20 - 8935	514
532173902	13 - 12620	270	539 1032-74	15 - 7010	365	601001986	41 - 13397	1221
532174367	10 - 12980	164	539 112078	15 - 12122	365	738220419	09 - 442	134
5321746-51	31 - 9656	1064	539-10-17-33	15 - 10720	368	738220419	09 - 442	134
532175141	31 - 10772	1071	539-102442	12 - 13477	229	917063	10 - 11858	167
532175141	31 - 8943	1071	539-102548	12 - 13474	229	966956101	10 - 13091	192
532175566	31 - 12685	1060	539-102549	12 - 13475	229	LGTH2454	26 - 13473	615
532175566	31 - 7015	1060	539-102903	12 - 13476	229			
532176137	31 - 9665	1066	539-103241	12 - 10949	260	HUSTLER		
532176138	31 - 9665	1066	539-103687	12 - 11032	260	026237	31 - 9369	1064
532178138	12 - 12892	224	539-104335	12 - 10823	260	031997	07 - 6916	106
532178744	31 - 9654	1063	539-104336	12 - 10824	260	032946	12 - 7595	216
532178861	31 - 8943	1071	539-105477	12 - 10825	260	034843	10 - 14036	192
532178861	31 - 10772	1071	539-107709	12 - 10834	229	039677	09 - 11835	134
532179114	13 - 12644	270	539-107710	12 - 10835	229	045872	12 - 7528	215
532179828	41 - 13397	1221	539-109334	05 - 10812	90	045898	31 - 9158	1059
532180808	12 - 10077	224	539-112079	15 - 12124	367	077123	09 - 8488	135
532184058	13 - 11635	270	539-113312	15 - 12125	368	350595	10 - 12241	192
532184219	10 - 11142	179	539-113425	15 - 12123	366	600726	12 - 12318	251
532184588	05 - 14023	68	539-132672	12 - 5086	212	600734	12 - 12264	251
532187256	15 - 14459	331	539-132672	12 - 7496	215	600976	19 - 12374	484
532187494	41 - 13397	1221	539002478	15 - 50294	368	600979	12 - 12689	251
532188243	41 - 13397	1221	539101080	31 - 9659	1066	601015	12 - 12690	251
532188606	07 - 14035	103	5391017-68	31 - 9656	1064	601311	10 - 12454	169
532189687	31 - 12685	1060	539102164	42 - 14184	1231			



O.E.M. REPLACEMENT CROSS REFERENCE

2014 CROSS REFERENCE

OEM #	Our #	Page #	OEM #	Our #	Page #	OEM #	Our #	Page #
HUSTLER			HUSTLER			INTERNATIONAL		
602771	15 - 6441	344	788547	10 - 12833	192	542520-R91	13 - 726	36
602988	12 - 14000	251	788711	12 - 12688	252			
712224	15 - 9173	369	788729	12 - 12695	252			
716886	15 - 9172	369	788737	12 - 12693	252	ISEKI		
745059	20 - 11273	511	788745	12 - 12417	252	2500-220-0001-00	15 - 11312	371
754853	15 - 6728	371	788794	12 - 12414	252	3495550M4	15 - 13593	371
754879	15 - 6628	371	789388	12 - 12320	252	8595-306-06-10-0	15 - 50063	371
767111	15 - 6436	369	791335	12 - 12319	252	FM-041-40	15 - 50062	371
768341	19 - 9361	484	792002	10 - 10356	160			
770339	15 - 6435	370	793794	15 - 6194	319	JOHN BEAN		
77146	31 - 9656	1064	793794	15 - 6180	334	1180477	12 - 5077	212
776476	31 - 9656	1064	793802	15 - 11810	369	AM133094	31 - 10772	1071
779306	20 - 2235	514	793828	12 - 12415	252			
781039K	10 - 11445	169	793836	12 - 12413	252	JOHN DEERE		
781211	31 - 9660	1066	793893	12 - 12416	253	102596	31 - 9208	1079
781310	12 - 10845	251	794206	15 - 11870	369	44178	12 - 7434	214
781385	13 - 10226	279	794230	15 - 6303	324	8188	09 - 813	133
781443	12 - 10844	251	794404	13 - 12299	278	8226	09 - 813	133
781856	13 - 10227	279	794685	15 - 6180	334	8597	09 - 8488	135
781856	13 - 12696	279	795252	15 - 10720	368	89832	12 - 7522	215
781898	15 - 10372	370	795260	15 - 6833	334	9266	09 - 484	133
782177	31 - 14291	1067	795526	15 - 11557	370	9467	09 - 3217	134
782292	12 - 10847	251	795781	12 - 12691	253	A-12-098-13	26 - 9976	617
782516	15 - 10373	370	796227	10 - 12491	192	AM-100137	19 - 8332	458
782532	15 - 10972	369	796235	10 - 12459	192	AM-100465	12 - 7578	216
782557	15 - 10971	370	797167	12 - 12692	253	AM-100538	15 - 6253	375
782771	09 - 14133	143	797480	21 - 13998	526	AM-100946	15 - 6011	374
783506	10 - 11452	192	797514	12 - 12694	253	AM-100946	15 - 1127	372
783555	09 - 3217	134	797696	15 - 11856	370	AM-100991	15 - 1126	372
783571	13 - 11446	278	797704	15 - 12733	370	AM-100991	15 - 6737	374
783753	15 - 11557	370	797704	15 - 13623	370	AM-101054	19 - 6677	483
783936	19 - 9380	484	797712	15 - 12733	370	AM-101191	19 - 2803	463
784207	12 - 10846	251	797720	12 - 12322	253	AM-101191	19 - 6567	463
784223	09 - 8488	135	797928	12 - 12321	253	AM-101207	19 - 5909	483
784231	12 - 10851	251	797936	12 - 12323	253	AM-101207	19 - 6677	483
784249	12 - 10852	251	797936	12 - 12323	253	AM-101207	19 - 12862	450
784256	15 - 10371	369	798496	15 - 11721	371	AM-101207	19 - 12863	450
784322	12 - 10861	252	798702	15 - 10421	355	AM-101207	19 - 7916	483
784504	13 - 10156	37	798710	15 - 9882	355	AM-101378	19 - 6681	483
784504	13 - 12297	278				AM-101378	19 - 6681	483
784827	13 - 12298	278	HYDRO-GEAR			AM-101538	15 - 6328	376
785261	19 - 9583	468	BDP-10A-201	05 - 12093	94	AM-101538	15 - 6327	376
785428	15 - 10973	369	BDP-10A-207	05 - 12093	94	AM-101589	08 - 8551	111
785436	15 - 11556	370	BDP-10A-217	05 - 12093	94	AM-102401	15 - 6252	376
785436	15 - 10972	369	BDP-10A-301	05 - 12092	94	AM-102402	15 - 6255	376
785600	19 - 10678	460	BDP-10A-302	05 - 12092	94	AM-102596	31 - 9208	1079
785618	19 - 10961	460	BDP-10A-308	05 - 12092	94	AM-103052	10 - 9307	173
786483	12 - 10849	252	BDP-10A-313	05 - 12092	94	AM-103119	31 - 9663	1066
786491	12 - 10850	252	HG52114	19 - 12374	484	AM-103286	31 - 8601	1063
786533	12 - 10848	252				AM-104126	07 - 8214	105
786889	13 - 11447	279	INTERNATIONAL			AM-104403	31 - 9664	1066
787226	19 - 10679	460	117210-C	19 - 2774	473	AM-104489	15 - 6222	372
787366	10 - 11237	167	385168-R2	11 - 386	203	AM-104489	15 - 6300	322
			491395-R1	13 - 723	36	AM-104560	19 - 6706	465
						AM-104884	31 - 9660	1066

O.E.M. REPLACEMENT CROSS REFERENCE



CROSS REFERENCE 2014

OEM #	Our #	Page #	OEM #	Our #	Page #	OEM #	Our #	Page #
JOHN DEERE			JOHN DEERE			JOHN DEERE		
AM-106236	10 - 8187	186	AM-37201	19 - 1388	472	AM123342	41 - 918	1221
AM-106564	13 - 5869	263	AM-37489	19 - 1376	451	AM123426	31 - 11219	1069
AM-106953	19 - 2790	476	AM-37540	19 - 2840	453	AM123426	31 - 11218	1069
AM-107423	19 - 6600	483	AM-37816	19 - 2778	453	AM125418	10 - 12450	174
AM-107423	19 - 12864	450	AM-38227	31 - 9166	1060	AM125424	19 - 7916	483
AM-107558	07 - 8215	105	AM-38314	15 - 6255	376	AM126226	10 - 11037	194
AM-107560	07 - 8244	105	AM-38990	19 - 2806	452	AM126304	31 - 14029	1079
AM-107561	07 - 8216	105	AM-39489	31 - 7675	1064	AM127304	09 - 6573	133
AM-108483	31 - 9658	1066	AM-39966	15 - 6012	373	AM130365	31 - 10677	1072
AM-115510	08 - 8550	111	AM-41647	13 - 723	36	AM130453	31 - 14268	1067
AM-115510	08 - 8579	109	AM-47494	19 - 1389	471	AM131017	10 - 9307	173
AM-116299	07 - 10724	105	AM-49396	19 - 1373	451	AM131157	21 - 13343	524
AM-116299	07 - 10250	105	AM-83541	09 - 8240	148	AM131296	26 - 12281	616
AM-118315	09 - 6573	133	AM100644	10 - 2212	174	AM131296	26 - 10262	617
AM-118802	31 - 9657	1064	AM100645	10 - 13457	174	AM131549	31 - 14247	1068
AM-119139	31 - 9657	1064	AM101054	19 - 12864	450	AM131841	31 - 12128	1069
AM-119943	31 - 9666	1066	AM101561	31 - 10723	1060	AM131946	31 - 11219	1069
AM-121238	13 - 727	36	AM101589	08 - 10461	111	AM131946	31 - 11219	1069
AM-121608	19 - 6605	467	AM101589	08 - 10742	110	AM131946	31 - 11218	1069
AM-121608	19 - 12935	449	AM101600	31 - 12128	1069	AM131966	31 - 9657	1064
AM-122115	05 - 300	92	AM102888	09 - 14279	136	AM132235	26 - 9976	617
AM-122796	10 - 8187	186	AM103019	13 - 728	36	AM132303	26 - 13379	615
AM-122881	31 - 9655	1060	AM105172	19 - 6677	483	AM132453	31 - 1781	1077
AM-123355	05 - 7018	93	AM106564	13 - 734	36	AM132702	26 - 10262	617
AM-125424	19 - 12861	450	AM106627	13 - 12419	279	AM132702	26 - 12281	616
AM-125424	19 - 6929	483	AM107139	05 - 14622	71	AM132808	31 - 9655	1060
AM-128925	31 - 9659	1066	AM107206	26 - 12254	615	AM132990	31 - 10677	1072
AM-30698	15 - 1126	372	AM107340	20 - 5841	46	AM133094	31 - 10677	1072
AM-30800	19 - 1385	474	AM108184	19 - 13389	463	AM133627	22 - 13386	535
AM-30900	19 - 1390	479	AM108185	19 - 13390	463	AM133635	26 - 9854	612
AM-31000	19 - 6849	481	AM108390	26 - 12281	616	AM133636	26 - 12279	615
AM-31034	19 - 1384	473	AM108390	26 - 10262	617	AM133756	13 - 734	36
AM-31100	15 - 1127	372	AM108615	26 - 12430	616	AM133756	13 - 5869	263
AM-31100	15 - 6496	321	AM108848	31 - 14029	1079	AM135356	31 - 11218	1069
AM-31159	12 - 7471	215	AM108925	10 - 11274	193	AM135356	31 - 11219	1069
AM-31400	19 - 1386	470	AM109462	31 - 9214	1079	AM135526	13 - 14242	280
AM-32172	12 - 7478	215	AM115459	13 - 14241	279	AM135773	13 - 14255	280
AM-32318	31 - 8601	1063	AM115460	13 - 14240	280	AM136733	10 - 13234	193
AM-32636	12 - 7479	215	AM115510	08 - 9898	109	AM136890	41 - 916	1221
AM-32639	07 - 3320	106	AM115857	41 - 5533	1225	AM137324	15 - 845	375
AM-32639	07 - 6918	104	AM116236	19 - 12941	448	AM137324	15 - 6737	374
AM-32672	13 - 728	36	AM116236	19 - 2838	456	AM137325	15 - 6421	323
AM-33574	13 - 734	36	AM116304	20 - 12619	497	AM137326	15 - 1126	372
AM-33718	07 - 6915	105	AM116304	20 - 1358	498	AM137326	15 - 6737	374
AM-34093	19 - 8332	458	AM11820	08 - 12310	120	AM137327	15 - 12380	376
AM-34963	19 - 1370	451	AM119683	10 - 9911	164	AM137328	15 - 11594	376
AM-34963	19 - 12938	448	AM121229	10 - 11278	193	AM137757	15 - 11595	373
AM-35176	19 - 6680	484	AM121342	10 - 11278	193	AM138068	31 - 14220	1072
AM-35380	12 - 7484	215	AM121814	08 - 8579	109	AM138068	31 - 10677	1072
AM-35443	09 - 6573	133	AM122108	09 - 8869	130	AM138497	31 - 10677	1072
AM-35557	15 - 2120	375	AM122156	41 - 916	1221	AM138497	31 - 10772	1071
AM-35585	13 - 725	36	AM122158	09 - 487	133	AM141032	15 - 12380	376
AM-35590	13 - 727	36	AM123296	31 - 9208	1079	AM141033	15 - 11594	376



O.E.M. REPLACEMENT CROSS REFERENCE

2014 CROSS REFERENCE

OEM #	Our #	Page #	OEM #	Our #	Page #	OEM #	Our #	Page #
JOHN DEERE			JOHN DEERE			JOHN DEERE		
AM141035	15 - 11595	373	GX21784	15 - 11595	373	GY21098	10 - 11964	193
AM141040	15 - 6186	375	GX21786	15 - 11596	373	GY21099	10 - 12495	193
AM141041	15 - 6737	374	GX21833	12 - 12461	230	GY21250	10 - 13440	158
AM141041	15 - 1126	372	GX21986	12 - 7530	215	GY21251	10 - 13441	158
AM143248	20 - 12074	515	GX21986	12 - 14365	241	HE1402522	19 - 2790	476
AM143469	10 - 13234	193	GX21994	09 - 14557	145	HE1402628	19 - 2790	476
AM153650	31 - 11218	1069	GX22036	12 - 10435	230	JD-8188	09 - 813	133
AM153650	31 - 11219	1069	GX22151	15 - 11594	376	JD-8226	09 - 813	133
AM32868	10 - 2212	174	GX22151	15 - 11593	376	JD30198	09 - 7162	134
AM32869	10 - 13457	174	GX22819	12 - 11811	230	JD30198	09 - 10303	135
AM33574	13 - 5869	263	GY20050	10 - 11206	194	JD7677R	09 - 442	134
AM36141	20 - 5841	46	GY20067	13 - 10741	279	JD8187	09 - 10015	135
AM37025	19 - 6680	484	GY20073	31 - 14246	1067	JD8225	09 - 10015	135
AM37249	13 - 12427	279	GY20074	31 - 12685	1060	JD8597	09 - 8488	135
AM37716	10 - 12450	174	GY20074	31 - 7015	1060	JD9296	09 - 484	133
AM38411	31 - 1781	1077	GY20094	31 - 9662	1068	LG270067	19 - 1376	451
AM39206	20 - 12074	515	GY20110	13 - 10737	279	LG270579	19 - 1371	451
AM39889	10 - 12450	174	GY20110	13 - 11207	279	LG270579S	19 - 1371	451
AM54223	07 - 6918	104	GY20454	10 - 11964	193	LG270848	19 - 1398	451
B14482	12 - 7433	214	GY20454	10 - 12910	193	LG271466	19 - 1369	452
B14852	12 - 7432	214	GY20567	15 - 10635	375	LG271794	19 - 2786	452
B5235H	11 - 406	203	GY20568	15 - 10634	373	LG271794S	19 - 2786	452
CH12767	19 - 8328	474	GY20570	12 - 10436	230	LG272490	19 - 2797	452
CH15541	19 - 8279	474	GY20571	12 - 10437	230	LG272490S	19 - 2797	452
ET12340	19 - 2844	472	GY20572	12 - 10388	230	LG273638S	19 - 9304	456
GC00073	12 - 10485	230	GY20573	19 - 13629	449	LG27987	19 - 1370	451
GC00081	12 - 10486	230	GY20573	19 - 10304	456	LG27987	19 - 12938	448
GC00344	15 - 10458	375	GY20574	19 - 12935	449	LG27987S	19 - 12938	448
GC00578	05 - 14622	71	GY20574	19 - 6605	467	LG27987S	19 - 1370	451
GX10065	12 - 10749	231	GY20575	19 - 9273	456	LG391086S	23 - 1445	556
GX10168	07 - 11819	104	GY20576	19 - 8329	470	LG392308	19 - 1396	452
GX10176	12 - 10630	230	GY20577	19 - 12862	450	LG392308S	19 - 1396	452
GX10851	12 - 10749	231	GY20577	19 - 7916	483	LG393957	19 - 1374	452
GX20006	12 - 10434	230	GY20592	10 - 12495	193	LG393957S	19 - 1374	452
GX20072	12 - 10436	230	GY20629	13 - 10737	279	LG396424	19 - 2788	452
GX20241	12 - 10435	230	GY20629	13 - 11207	279	LG396424S	19 - 2788	452
GX20249	15 - 12919	376	GY20639	13 - 10737	279	LG397795	19 - 2789	455
GX20249	15 - 10635	375	GY20661	19 - 8235	467	LG397795S	19 - 2789	455
GX20250	15 - 12920	373	GY20679	15 - 11491	374	LG491588	19 - 2838	456
GX20250	15 - 10634	373	GY20680	31 - 11218	1069	LG491588	19 - 12941	448
GX20286	13 - 10738	280	GY20680	31 - 11219	1069	LG491588JD	19 - 2838	456
GX20287	13 - 9544	279	GY20684	15 - 11491	374	LG491588S	19 - 12941	448
GX20305	12 - 10437	230	GY20770	10 - 13440	158	LG491588S	19 - 2838	456
GX20367	13 - 11449	280	GY20771	10 - 13441	158	LG492932S	19 - 12861	450
GX20513	10 - 11964	193	GY20785	10 - 11206	194	LG492932S	19 - 6929	483
GX20818	09 - 7917	132	GY20852	15 - 11596	373	LG493537S	19 - 8481	456
GX20818	09 - 8507	132	GY20852	15 - 11595	373	LG497595	26 - 9796	612
GX20819	15 - 12920	373	GY20867	10 - 12495	193	LG691060	31 - 11578	1076
GX21030	08 - 11059	122	GY20939	31 - 14248	1065	LG692236	23 - 8797	577
GX21380	15 - 11491	374	GY20962	10 - 12910	193	LG808656	22 - 10875	535
GX21395	12 - 14243	230	GY20962	10 - 11964	193	M-124417	09 - 8446	147
GX21510	09 - 7210	132	GY21055	19 - 12673	453	M-127082	09 - 8445	146
GX21784	15 - 11596	373	GY21098	10 - 12910	193	M-71027	19 - 6517	463

O.E.M. REPLACEMENT CROSS REFERENCE



CROSS REFERENCE 2014

OEM #	Our #	Page #	OEM #	Our #	Page #	OEM #	Our #	Page #
JOHN DEERE			JOHN DEERE			JOHN DEERE		
M110312	12 - 10388	230	M131803	19 - 9728	468	M40015	12 - 7580	216
M110313	12 - 12077	230	M133381	15 - 6479	375	M40222	12 - 7471	215
M110594	05 - 7018	93	M136194	15 - 10284	373	M40223	12 - 14365	241
M110978	12 - 10751	231	M136195	15 - 10072	323	M40223	12 - 7530	215
M111489	07 - 10724	105	M136195	15 - 6480	374	M40223	12 - 7530	215
M111149	07 - 10724	105	M137547	12 - 7546	215	M40224	12 - 7500	215
M111534	12 - 14390	231	M137547	12 - 12051	228	M40244	12 - 7500	215
M112230	12 - 7546	215	M138664	08 - 10660	126	M40514	02 - 9492	53
M112230	12 - 12051	228	M139802	15 - 9959	376	M40757	12 - 7520	215
M112490	12 - 7542	215	M139976	15 - 10074	376	M41237	15 - 1126	372
M112738	15 - 6122	375	M140361	08 - 10760	127	M41244	12 - 7496	215
M112847	15 - 2120	375	M140362	08 - 10761	127	M41314	12 - 7438	214
M112972	15 - 6122	375	M141785	15 - 6253	375	M41335	12 - 7437	214
M112991	15 - 6421	323	M141786	15 - 6255	376	M41592	12 - 7483	215
M112991	15 - 6186	375	M143019	12 - 12078	231	M41642	12 - 7505	215
M113517	15 - 6420	322	M143512	26 - 10709	612	M41668	12 - 7541	215
M113517	15 - 6223	373	M143520	15 - 10292	374	M41967	15 - 1127	372
M113518	15 - 6221	374	M144044	12 - 13035	231	M41985	12 - 7441	214
M113621	19 - 9550	459	M144516	15 - 14475	374	M42226	12 - 7581	216
M113955	07 - 13279	104	M144570	12 - 13036	231	M42261	12 - 7503	215
M115245	07 - 8224	105	M144677	12 - 12078	231	M42485	12 - 7489	215
M115407	12 - 10830	226	M145476	15 - 12821	373	M42538	12 - 7507	215
M115495	15 - 6314	322	M145476	15 - 10291	373	M42779	12 - 7526	215
M115495	15 - 6206	373	M146737	19 - 10880	464	M43095	12 - 7585	216
M115496	15 - 6315	323	M147489	19 - 10304	456	M43106	12 - 7444	214
M115496	15 - 6192	374	M147489	19 - 13629	449	M43489	12 - 7500	215
M115759	15 - 6193	372	M147971	19 - 12943	448	M43569	12 - 7493	215
M115978	19 - 8662	465	M148613	15 - 10074	376	M43586	12 - 7511	215
M118684	12 - 12078	231	M149118	19 - 10880	464	M43795	12 - 7484	215
M118685	12 - 13217	231	M149171	19 - 10184	456	M43820	12 - 7517	215
M118958	15 - 6329	376	M149202	08 - 12478	120	M44121	12 - 7612	216
M122106	12 - 11026	254	M150236	26 - 860	608	M44121	12 - 5194	213
M122107	12 - 11027	254	M151768	19 - 11205	464	M44178	12 - 7434	214
M122455	15 - 6738	374	M153118	15 - 845	375	M44272	12 - 7523	215
M122674	12 - 10435	230	M153118	15 - 12562	375	M44498	12 - 7503	215
M122907	12 - 11028	254	M153118	15 - 6737	374	M45254	12 - 7529	215
M123378	19 - 10080	459	M154061	15 - 12380	376	M45491	12 - 7479	215
M123810	08 - 11141	122	M154157	12 - 13157	231	M45613	12 - 7479	215
M123811	09 - 13359	146	M154158	15 - 6186	375	M45680	12 - 7476	215
M124285	13 - 2181	263	M154158	15 - 6421	323	M45681	12 - 7475	215
M124895	12 - 12678	231	M154159	15 - 6737	374	M45800	19 - 1377	470
M125218	12 - 10749	231	M154296	12 - 13158	232	M45815	12 - 7470	215
M125413	15 - 6122	375	M154601	12 - 12559	232	M45863	12 - 7499	215
M126009	12 - 12898	231	M154621	12 - 12560	232	M45998	12 - 7524	215
M126536	12 - 12373	231	M154958	12 - 12077	230	M46030	12 - 7476	215
M127466	15 - 1127	372	M155343	12 - 7503	215	M47043	12 - 7522	215
M127500	15 - 10291	373	M155343	12 - 5093	212	M47494	19 - 1389	471
M127500	15 - 12821	373	M155435	08 - 10760	127	M47765	12 - 7527	215
M127673	15 - 12821	373	M155438	08 - 10761	127	M47766	12 - 7523	215
M128485	15 - 10073	324	M158131	12 - 13158	232	M47770	12 - 7501	215
M128485	15 - 6479	375	M158692	12 - 12373	231	M47949	19 - 1371	451
M130044	29 - 8611	667	M32636	12 - 7471	215	M48452	15 - 2120	375
M130045	29 - 8610	667	M4-7161	13 - 1262	285	M48520	12 - 7468	215



O.E.M. REPLACEMENT CROSS REFERENCE

OEM #	Our #	Page #	OEM #	Our #	Page #	OEM #	Our #	Page #
JOHN DEERE			JOHN DEERE			JOHN DEERE		
M49000	12 - 7507	215	M82720	12 - 7488	215	M96846	19 - 8505	465
M49155	12 - 7495	215	M82721	12 - 7530	215	M96847	19 - 8662	465
M49920	12 - 7542	215	M82734	12 - 7503	215	M97211	19 - 6706	465
M55258	12 - 7513	215	M83339	19 - 1396	452	M97266	19 - 2828	463
M63810	09 - 10303	135	M83363	15 - 6252	376	M97348	31 - 10673	1079
M63810	09 - 7162	134	M83459	15 - 6737	374	M97348	31 - 14029	1079
M70121	31 - 14029	1079	M83541	09 - 8240	148	MIA10967	26 - 13379	615
M70127	19 - 6517	463	M83646	19 - 2774	473	MIA11408	26 - 12279	615
M70128	19 - 2828	463	M83681	19 - 5863	473	MIA11422	31 - 9293	1076
M70283	19 - 6519	463	M83837	12 - 7531	215	MIA11473	26 - 10262	617
M70284	19 - 6518	463	M84075	12 - 7522	215	MIA12005	26 - 13379	615
M70547	12 - 7524	215	M84136	12 - 7543	215	MIA12346	31 - 11578	1076
M70808	09 - 8366	147	M84223	12 - 7505	215	MIU11251	15 - 14475	374
M71135	12 - 7517	215	M84365	12 - 7502	215	MIU11286	19 - 13049	455
M71529	12 - 7508	215	M84472	15 - 6737	374	MIU11286	19 - 9273	456
M71817	12 - 7539	215	M84472	15 - 845	375	MIU11377	19 - 8662	465
M71952	19 - 7714	465	M84516	09 - 8707	143	MIU11511	19 - 12673	453
M72031	12 - 7503	215	M84655	19 - 2797	452	MIU11513	19 - 12894	453
M72683	12 - 7542	215	M84690	07 - 6916	106	MIU11515	19 - 12282	454
M73223	12 - 7523	215	M84691	10 - 11142	179	MIU11517	19 - 12479	454
M73478	12 - 7502	215	M85442	12 - 7487	215	MIU11517	19 - 12283	454
M74285	19 - 6989	465	M86060	12 - 7486	215	MIU11747	19 - 12786	466
M74747	12 - 10750	230	M86209	15 - 6012	373	MIU11748	19 - 12787	466
M75563	19 - 7841	465	M86248	12 - 12051	228	MIU13038	19 - 10184	456
M76076	19 - 9841	465	M86248	12 - 7546	215	PT10615	25 - 7723	604
M77555	19 - 7052	465	M86421	12 - 7496	215	PT10865	12 - 8432	221
M77988	12 - 7503	215	M86422	12 - 7506	215	PT11025	19 - 2789	455
M78543	24 - 7423	592	M86996	12 - 7530	215	PT14764	15 - 849	379
M79451	19 - 6705	465	M86996	12 - 7530	215	PT15853	19 - 2838	456
M80373	10 - 9143	174	M86996	12 - 14365	241	PT15853	19 - 12941	448
M80386	12 - 7507	215	M87622	15 - 6253	375	PT2254	41 - 5513	1223
M806418	19 - 6681	483	M88184	12 - 7503	215	PT2261	41 - 5506	1224
M80652	12 - 7494	215	M88251	09 - 10303	135	PT6921	15 - 3348	375
M80783	15 - 6255	376	M88251	09 - 7162	134	PT7132	15 - 849	379
M81035	12 - 7476	215	M88571	19 - 5861	463	PT7946	19 - 1369	452
M81036	12 - 7476	215	M89112	12 - 7634	216	PT7953	19 - 2788	452
M81037	12 - 7475	215	M89339	07 - 6914	105	PT8633	10 - 8187	186
M81505	12 - 7494	215	M89454	15 - 6328	376	PT8639	08 - 8196	108
M81716	07 - 6913	105	M89455	15 - 6327	376	PT8649	13 - 12891	281
M81805	12 - 7492	215	M89832	12 - 7522	215	PT8649	13 - 2188	263
M82139	19 - 1398	451	M89840	12 - 7543	215	PT8663	10 - 2218	157
M82167	12 - 7494	215	M90958	12 - 7498	215	PT8670	10 - 2243	156
M82258	12 - 7483	215	M91080	09 - 8706	143	PT8676	12 - 7493	215
M82362	12 - 7531	215	M91147	12 - 7506	215	PT8697	12 - 7577	216
M82408	15 - 6011	374	M91270	12 - 7490	215	PT8698	12 - 7591	216
M82460	12 - 7509	215	M91330	12 - 7507	215	PT8721	15 - 6294	323
M82461	12 - 7482	215	M92359	19 - 12935	449	PT8761	13 - 5869	263
M82462	12 - 7509	215	M92359	19 - 6605	467	PT8761	13 - 734	36
M82538	12 - 7507	215	M92360	19 - 6606	467	PT8999	19 - 2797	452
M82612	12 - 7479	215	M94511	41 - 5531	1223	PT9022	27 - 6881	659
M82638	12 - 7507	215	M94576	41 - 5533	1225	PT9334	19 - 1374	452
M82718	12 - 7533	215	M9574	41 - 5533	1225	R27434	02 - 78	41
M82719	12 - 7493	215	M96098	19 - 2786	452	R90796	08 - 10736	127

2014 CROSS REFERENCE

O.E.M. REPLACEMENT CROSS REFERENCE



CROSS REFERENCE 2014

OEM #	Our #	Page #	OEM #	Our #	Page #	OEM #	Our #	Page #
JOHN DEERE			KAWASAKI			KAWASAKI		
R90798	08 - 10735	127	11013 2194	19 - 10882	464	11013-7034	19 - 10305	465
RE216842	20 - 9650	515	11013-1214	19 - 2828	463	11013-7038	19 - 12786	466
RE64733	20 - 9650	515	11013-2010	19 - 7841	465	11013-7039	19 - 12787	466
T12031	12 - 7452	214	11013-2020	19 - 5861	463	11013-7039	19 - 12001	459
T12042	12 - 7446	214	11013-2021	19 - 6567	463	11013-7046	19 - 12797	466
T199T	12 - 7445	214	11013-2021	19 - 2803	463	11013-7047	19 - 12758	466
T21158	10 - 9150	174	11013-2092	19 - 6519	463	11013-7048	19 - 11842	459
TCA13807	10 - 14168	194	11013-2093	19 - 6518	463	11013-7049	19 - 12758	466
TCA13830	21 - 13358	524	11013-2097	19 - 6517	463	11013-7050	19 - 14207	466
TCA15075	31 - 10723	1060	11013-2098	19 - 2828	463	110130726	19 - 12758	466
TCA17517	10 - 13385	193	11013-2109	19 - 6989	465	110130727	19 - 14207	466
TCA17834	31 - 9657	1064	11013-2110	19 - 6706	465	110137033	19 - 12948	449
TCA20639	10 - 13385	193	11013-2114	19 - 9292	465	11029-2006	19 - 8662	465
TCU13195	12 - 12759	232	11013-2115	19 - 9841	465	11029-2018	19 - 8662	465
TCU13196	12 - 12814	232	11013-2119	19 - 7052	465	11029-2021	27 - 13381	464
TCU13198	12 - 12760	232	11013-2120	19 - 6705	465	11029-7002	19 - 9584	464
TCU15881	15 - 6479	375	11013-2134	19 - 8505	465	11029-7010	19 - 10398	465
TCU15882	15 - 12643	376	11013-2134	19 - 8662	465	11029-7012	19 - 9584	464
TCU16026	12 - 14237	232	11013-2135	19 - 8662	465	11029-7016	19 - 10398	465
TCU16092	12 - 11024	254	11013-2139	19 - 9852	465	11029-7021	19 - 10398	465
TCU16093	12 - 11025	254	11013-2141	19 - 6706	465	11029-7023	19 - 13382	463
TCU18744	07 - 10714	104	11013-2146	19 - 8662	465	14069-2056	20 - 8737	517
TCU18744	07 - 6916	106	11013-2174	19 - 7052	465	14069-2088	20 - 8737	517
TCU30316	15 - 6480	374	11013-2175	19 - 6705	465	15003-2804	22 - 11969	549
TCU30316	15 - 10072	323	11013-21811	19 - 10681	464	16020-7003	22 - 13537	533
UP06687	41 - 5513	1223	11013-2195	19 - 10881	464	21066-2056	31 - 10673	1079
UP06694	41 - 5506	1224	11013-2204	19 - 9852	465	21066-2070	31 - 10673	1079
VG11696	21 - 13346	524	11013-2205	19 - 9841	465	21066-2071	31 - 9214	1079
			11013-2206	19 - 8662	465	21163-2051	26 - 13379	615
			11013-2213	19 - 10881	464	21163-2068	26 - 11487	614
JONSERED			11013-7001	19 - 9611	464	21163-2070	26 - 12254	615
100251	39 - 3113	488	11013-7001	19 - 12948	449	21163-2073A	26 - 10806	615
501188101	15 - 13335	366	11013-7002	19 - 12944	449	21163-2077	26 - 10241	614
504-18-82-01	15 - 13334	365	11013-7002	19 - 9506	464	21163-2081	26 - 12254	615
504-210601	37 - 3016	1180	11013-7009	19 - 9585	464	21163-2093	26 - 12430	616
504-212602	37 - 3017	1180	11013-7010	19 - 9584	464	21163-2101	26 - 10683	615
504-212606	37 - 3041	1180	11013-7016	19 - 10305	465	21163-2120	26 - 13379	615
507-100073	37 - 3048	1180	11013-7017	19 - 10305	465	21163-2130	26 - 13379	615
544-10-30-01	15 - 13334	365	11013-7017	19 - 10313	465	21163-2132	26 - 10683	615
544102801	15 - 13335	366	11013-7018	19 - 10302	465	21163-2138	26 - 10806	615
552188	10 - 1226	186	11013-7019	19 - 9728	468	21163-2141	26 - 10241	614
			11013-7019	19 - 9728	468	21163-2145	26 - 12430	616
K & S TRIM ALL			11013-7019	19 - 11865	468	21163-2148	26 - 11487	614
3999	09 - 3216	144	11013-7020	19 - 9583	468	21163-7001	26 - 10561	615
4L280	12 - 5061	212	11013-7020	19 - 11841	468	21163-7002	26 - 12279	615
4L310	12 - 5064	212	11013-7022	19 - 10880	464	21163-7003	26 - 12697	615
4L340	12 - 5067	212	11013-7024	19 - 9584	464	21163-7010	26 - 10561	615
T16276	09 - 3216	144	11013-7025	19 - 11205	464	21163-7014	26 - 12279	615
			11013-7029	19 - 9550	459	21163-7020	26 - 14378	616
KA AZ			11013-7029	19 - 11842	459	21163-7022	26 - 10561	615
91014-159	15 - 12118	377	11013-7031	19 - 11230	464	21163-7024	26 - 13473	615
91014-165	15 - 11314	377	11013-7032	19 - 10302	465	21163-7026	26 - 12279	615
			11013-7033	19 - 9611	464	21163-7028	26 - 14378	616



O.E.M. REPLACEMENT CROSS REFERENCE

2014 CROSS REFERENCE

OEM #	Our #	Page #	OEM #	Our #	Page #	OEM #	Our #	Page #
KAWASAKI			KAWASAKI			KOHLER		
21163-7029	26 - 10561	615	999997080	26 - 10561	615	1288310S1	19 - 1288310S1	467
21163-7034	26 - 13473	615				14-083-01-S	19 - 1408301S	469
21163-7035	26 - 13473	615	KING-O-LAWN			14-083-01-S1	19 - 1408301S1	469
211630711	26 - 13473	615	1106	12 - 7470	215	14-083-02-S	19 - 1408302S	469
211630714	26 - 13473	615	7192	09 - 6513	133	14-132-03S	24 - 10786	591
211632147	26 - 10683	615				14-132-06-S	24 - 10992	597
211632151	26 - 13379	615	KLIPPO			14-132-07-S	24 - 14492	591
27010-2122	26 - 12130	619	90-805R	15 - 10376	377	14-132-11-S	24 - 14492	591
27010-7005	26 - 12130	619				1408301S	19 - 7980	460
310301-3452A	26 - 2444	633	KOHLER			1408301S	19 - 1408301S	469
310370-6816A	27 - 7909	658	12 050 01 S	19 - 7916	483	1408301S1	19 - 1408301S1	469
310401-6641A	20 - 7407	517	12 050 01 S	19 - 12862	450	1408302S	19 - 1408302S	469
311901-34418	26 - 7930	610	12 132 02	24 - 9872	594	1408304S	19 - 7980	460
3144AA-1312A	19 - 7714	465	12 132 02	24 - 11648	597	1413206-S	24 - 13039	596
49019-2065	27 - 8533	496	12 403 01 S	31 - 10295	1080	15-083-05-S	19 - 9653	473
49019-7001	20 - 12515	496	12 559 02 S	22 - 13386	535	17-083-07-S	19 - 1708307S	469
49019-7001	20 - 10352	500	12-050-01-S	19 - 1205001S	483	17-083-12-S	19 - 1708312S	469
49019-7001	20 - 7998	496	12-050-01-S119	19 - 1205001S1	1483	17-883-03-S1	19 - 1788303S1	471
49019-7005	20 - 12865	496	12-083-05	19 - 12935	449	17-883-07-S1	19 - 1788307S1	469
490190014	20 - 12865	496	12-083-05-S	19 - 1208305S	467	1708307S	19 - 1708307S	469
490190707	20 - 12865	496	12-083-05-S	19 - 6605	467	1708312S	19 - 1708312S	469
49040-7001	22 - 10875	535	12-083-08-S	19 - 6606	467	1788303S1	19 - 1788303S1	471
49043-2063	27 - 9162	658	12-083-08-S	19 - 1208308S	467	18-883-01-S1	19 - 1888301S1	470
49043-2065	27 - 8532	658	12-083-10-S	19 - 1208310S	467	1888301S1	19 - 1888301S1	470
49043-2070	27 - 9162	658	12-083-10-S	19 - 8235	467	20-083-02-S	19 - 2008306S	469
49049-1063	19 - 6600	483	12-083-10-S	19 - 8235	467	20-083-03S	19 - 12289	469
49049-2057	27 - 7864	658	12-083-12-S	19 - 1208312S	467	20-083-04-S	19 - 2008304S	469
49064-2059	19 - 7714	465	12-083-12-S	19 - 8712	467	20-083-04S	19 - 12289	469
49065-2071	19 - 6600	483	12-098-08-S	26 - 9976	617	20-083-06-S	19 - 2008306S	469
49065-2071	19 - 12864	450	12-098-10-S	26 - 9997	617	20-098 05-S	26 - 12709	619
49065-2078	19 - 12864	450	12-098-12-S	26 - 9975	618	20-098 06-S	26 - 12709	619
49065-2078	19 - 6600	483	12-098-13-S	26 - 9976	617	20-883-06-S1	19 - 2088306S1	469
49065-2081	19 - 6600	483	12-098-19-S	26 - 9975	618	2008302S	19 - 2008306S	469
49065-2081	19 - 12864	450	12-098-20-S	26 - 9976	617	2008304S	19 - 2008304S	469
49065-7007	19 - 12861	450	12-098-21-S	26 - 9975	618	2008306S	19 - 2008306S	469
49065-7007	19 - 6929	483	12-098-21-S	26 - 1209821S	618	2009808S	26 - 12709	619
490657010	19 - 12864	450	12-098-22-S	26 - 1209822S	617	2088306S1	19 - 2088306S1	469
490657010	19 - 6600	483	12-098-22-S	26 - 9976	617	210223S	23 - 3556	580
49116-2064	20 - 8737	517	12-757-02-S	22 - 10053	533	210468S	20 - 1503	508
51049-2057	20 - 7408	517	12-883-05-S1	19 - 1288305S1	467	220145S	18 - 2291	442
51049-2058	20 - 7407	517	12-883-10-S1	19 - 1288310S1	467	220157S	23 - 7803	583
51049-2091	20 - 7408	517	1205001S	19 - 1205001S	483	220370S	23 - 7794	581
59101-2057	26 - 7930	610	1205001S1	19 - 1205001S1	483	220521S	18 - 1279	444
59101-2067	26 - 9617	610	1208305S	19 - 1208305S	467	220521Z	18 - 1279	444
717196	26 - 2444	633	1208308S	19 - 1208308S	467	220801S	23 - 6794	561
92045-1163	09 - 7162	134	1208310S	19 - 1208310S	467	220803S	23 - 6795	561
92045-1163	09 - 10303	135	1208312S	19 - 1208312S	467	23-083-02-S	19 - 8966	470
92045-1229	09 - 10303	135	1209819S	26 - 9975	618	230048S	23 - 2739	581
92045-1229	09 - 7162	134	1209820S	26 - 9976	617	230710S	23 - 2834	568
92059-2113	27 - 7909	658	1209821S	26 - 1209821S	618	230840S	19 - 1384	473
92081-2238	26 - 2444	633	1209821S	26 - 9975	618	231281S	31 - 1781	1077
99969-1395	23 - 12111	585	1209822S	26 - 1209822S	617	231847-S	19 - 231847S	471
999990384	19 - 12758	466	1209822S	26 - 9976	617	231847S	19 - 231847S	471
			1288305S1	19 - 1288305S1	467			

O.E.M. REPLACEMENT CROSS REFERENCE



CROSS REFERENCE 2014

OEM #	Our #	Page #	OEM #	Our #	Page #	OEM #	Our #	Page #
KOHLER			KOHLER			KOHLER		
231847S	19 - 1385	474	2408303S	19 - 2408303S	470	2504110S	23 - 3542	580
232575S	23 - 2470	561	2408305S	19 - 2408305S	470	2504110S	23 - 3542	580
232576S	23 - 6796	561	2488303S1	19 - 2488303S1	470	2505007S	20 - 2505007S	496
232577S	23 - 6797	561	25-041-05-S	23 - 3542	580	2505007S1	20 - 2505007S1	496
232578S	23 - 6798	562	25-041-09-S	23 - 3542	580	2505007S	20 - 13652	496
234869S	19 - 2780	474	25-050 02-S	20 - 13652	496	2505008S	20 - 1358	498
234870S	19 - 5934	473	25-050 03-S	20 - 1358	498	2505021S	20 - 2505021S	497
235008S	23 - 2830	568	25-050 07-S	20 - 13652	496	2505021S1	20 - 2505021S1	497
235048S	23 - 2740	581	25-050 08-S	20 - 1358	498	2505022S	20 - 2505022S	498
235057S	23 - 3534	583	25-050 22-S	20 - 1358	498	2505022S1	20 - 2505022S1	498
235116-S	19 - 235116S	470	25-050 42S	20 - 13115	496	2505022S	20 - 1358	498
235116S	19 - 1386	470	25-050-07-S1	20 - 2505007S1	496	2508301S	19 - 2508301S	468
235116S	19 - 235116S	470	25-050-21-S	20 - 2505021S	497	2508302S	19 - 2508302S	468
235287S	23 - 2471	561	25-050-21-S1	20 - 2505021S1	497	2508303S	19 - 2508303S	468
235288S	23 - 6799	561	25-050-22-S	20 - 2505022S	498	2508304S	19 - 2508304S	468
235289S	23 - 6800	561	25-050-22-S1	20 - 2505022S1	498	2508304S	19 - 9728	468
235290S	23 - 6801	562	25-083-01-S	19 - 9583	468	2509807S	26 - 2509807S	619
235582S	23 - 8474	568	25-083-01-S	19 - 2508301S	468	2509807S	26 - 9997	617
235826S	23 - 2833	568	25-083-01S	19 - 11841	468	2509809S	26 - 10262	617
235838S	23 - 8475	568	25-083-02-S	19 - 9550	459	2509811S	26 - 2509811S	616
235889S	23 - 2472	561	25-083-02-S	19 - 2508302S	468	2509932S	31 - 7280	1062
235890S	23 - 6802	561	25-083-02S	19 - 11842	459	2532403S	19 - 12713	467
235891S	23 - 6803	561	25-083-03-S	19 - 2508303S	468	2532404S	19 - 12713	467
235892S	23 - 6804	562	25-083-03S	19 - 12001	459	2540322S	31 - 10297	1080
236763S	23 - 2473	561	25-083-04-S	19 - 2508304S	468	2575701S	22 - 2575701S	541
236764S	23 - 6805	561	25-083-04S	19 - 11865	468	2575702S	22 - 2575702S	541
236765S	23 - 6806	562	25-098-04-S	26 - 9997	617	2588303S1	19 - 2588303S1	470
236766S	23 - 6807	562	25-098-05-S	26 - 9997	617	271030S	23 - 3557	580
237256S	31 - 1781	1077	25-098-07-S	26 - 2509807S	619	275144S	23 - 2741	581
237421-S	19 - 237421S	470	25-098-07-S	26 - 9997	617	275679S	18 - 1277	439
237421S	19 - 1377	470	25-098-09-S	26 - 10262	617	277138S	19 - 1387	473
237421S	19 - 237421S	470	25-098-09S	26 - 12281	616	277233S	19 - 6676	483
237550S	18 - 8284	442	25-098-11-S	26 - 2509811S	616	277233S	19 - 277233S	483
237658S	23 - 2764	570	25-098-11S	26 - 10262	617	277593S	19 - 6516	473
237672S	23 - 8473	568	25-098-11S	26 - 12281	616	28-050-01S	19 - 12861	450
24-050-10-S	20 - 9147	497	25-099-04-S	31 - 7280	1062	28-050-01S	19 - 6929	483
24-050-13-S	20 - 2405013S	497	25-104-01-S	22 - 12813	533	28-083-02-S	19 - 10212	472
24-050-13-S1	20 - 2405013S1	497	25-111-39-S	20 - 11816	506	28-083-04-S	19 - 9989	474
24-083-02-S	19 - 9245	471	25-132-14-S	24 - 14636	592	2808306S	19 - 10213	474
24-083-02-S	19 - 2408302S	471	25-324-02-S	19 - 12713	467	32-083-03-S	19 - 11505	471
24-083-02-S	19 - 7785	471	25-403-03-S	31 - 8969	1079	32-083-03-S	19 - 3208303S	471
24-083-03-S	19 - 8329	470	25-435 04S	26 - 13626	616	32-083-05-S	19 - 3208305S	471
24-083-03-S	19 - 2408303S	470	25-462-03-S	20 - 13116	511	32-083-06-S	19 - 3208306S	472
24-083-05-S	19 - 8966	470	25-462-18-S	23 - 6783	586	32-083-06-S	19 - 12674	472
24-083-05-S	19 - 2408305S	470	25-755-03-S	31 - 8969	1079	32-083-08-S	19 - 12676	472
24-098-01-S	26 - 10262	617	25-755-14-S	23 - 6783	586	32-083-08-S	19 - 5939	452
24-393-04-S	22 - 10876	535	25-757-01-S	22 - 2886	541	32-083-08-S	19 - 3208308S	472
24-393-16-S	22 - 10875	535	25-757-01S	22 - 2575701S	541	32-098-01-S	26 - 12710	619
24-883-03-S1	19 - 2488303S1	470	25-757-02-S	22 - 2575702S	541	32-098-02-S	26 - 12710	619
2405013S	20 - 2405013S	497	25-757-03-S	22 - 11960	534	32-098-03S	26 - 12710	619
2405013S	20 - 9147	497	25-757-09-S	22 - 12878	534	32-098-04-S	26 - 3209804S	619
2405013S1	20 - 2405013S1	497	25-757-11-S	22 - 13231	541	32-098-04S	26 - 12710	619
2408302S	19 - 2408302S	471	25-883-03-S1	19 - 2588303S1	470	32-883-03-S1	19 - 3288303S1	471



O.E.M. REPLACEMENT CROSS REFERENCE

2014 CROSS REFERENCE

OEM #	Our #	Page #	OEM #	Our #	Page #	OEM #	Our #	Page #
KOHLER			KOHLER			KOHLER		
32-883-06-S1	19 - 3288306S1	472	47-032-06-S	23 - 8421	557	52-05025S	19 - 5909	483
3208303S	19 - 3208303S	471	47-032-07-S	23 - 8422	557	52-083-01-S	19 - 5208301S	473
3208305S	19 - 3208305S	471	47-041-04-S	23 - 3542	580	52-083-01-S	19 - 5863	473
3208306S	19 - 3208306S	472	47-041-10-S	23 - 2764	570	52-098-06-S	26 - 9977	616
3208308S	19 - 3208308S	472	47-041-15-S	23 - 2764	570	52-098-11-S	26 - 5209811S	616
3209804S	26 - 3209804S	619	47-067-09-S	23 - 6765	566	52-098-12-S	26 - 5209812S	619
3288303S1	19 - 3288303S1	471	47-067-13-S	23 - 6763	566	52-098-12-S	26 - 9814	619
3288306S1	19 - 3288306S1	472	47-083-01-S	19 - 4708301S	473	52-098-13-S	26 - 9977	616
41-041-03-S	23 - 3533	583	47-083-01-S	19 - 2774	473	52-098-13-S	26 - 5209813S	616
41-041-05-S	23 - 2763	570	47-083-03-S	19 - 4708303S	471	52-435-02S	26 - 12130	619
41-041-10-S	23 - 2763	570	47-083-03-S	19 - 1389	471	52-559-01S	22 - 10273	535
41-041-11-S	23 - 7795	580	47-145-01-S	31 - 1781	1077	52-559-03S	22 - 10273	535
41-067-10-S	23 - 6761	566	47-150-03-S	31 - 4715003S	1075	52-755-12-S	23 - 13211	573
41-068-01-S	18 - 7727	442	47-559-04S	22 - 10211	535	52-755-93-S	23 - 13211	573
41-068-08-S	18 - 7727	442	47-559-11S	22 - 10211	535	5205002S	19 - 5205002S	483
41-083-04-S	19 - 7785	471	47-755-08-S	23 - 2754	573	5205002S1	19 - 5205002S1	483
41-098-06-S	26 - 9800	617	47-755-08-S	23 - 2754	573	5205025S	19 - 12863	450
41-098-08-S	26 - 4109808S	618	47-874-01-S	23 - 6745	564	5205025S	19 - 5909	483
41-098-08-S	26 - 9801	618	47-874-03-S	23 - 6746	564	5208301S	19 - 5208301S	473
41-403-06-S	31 - 10297	1080	47-874-04-S	23 - 6747	564	5209811S	26 - 5209811S	616
41-403-08-S	31 - 9208	1079	47-874-05-S	23 - 6748	564	5209812S	26 - 5209812S	619
41-755-06-S	23 - 2755	573	47-874-06-S	23 - 6749	564	5209813S	26 - 5209813S	616
41-874-05-S	23 - 6741	564	47-874-08-S	23 - 6750	564	5255903S	22 - 10273	535
41-874-07-S	23 - 6742	564	47-874-09-S	23 - 6751	564	62-132-04-S	24 - 14637	592
41-874-08-S	23 - 6743	564	47-874-11-S	23 - 6753	564	82-755-28-S	26 - 9218	628
41-874-09-S	23 - 6744	564	47-874-14-S	23 - 6755	564	82-755-28-S	26 - 9219	628
4109808S	26 - 4109808S	618	47-874-15-S	23 - 6756	564	82755-28S	26 - 9218	628
4140309S	31 - 8969	1079	47-883-01-S1	19 - 4788301S1	473	82755-28S	26 - 9219	628
4140310S	31 - 8969	1079	47-883-03-S1	19 - 4788303S1	471	A235845S	22 - 10873	535
4151921S	31 - 1781	1077	4708301S	19 - 4708301S	473			
45-041-16-S	23 - 2750	570	4708303S	19 - 4708303S	471			
45-041-17-S	23 - 2750	570	4715003S	31 - 4715003S	1075	KUBOTA		
45-052-01-S	23 - 2750	570	4755911S	22 - 10211	535	08101-06205	09 - 7162	134
45-068-01-S	18 - 2285	442	4788301S1	19 - 4788301S1	473	08141-06205	09 - 10303	135
45-083-01-S	19 - 2844	472	4788303S1	19 - 4788303S1	471	08141-06205	09 - 7162	134
45-083-01-S	19 - 7785	471	48-098-02-S	26 - 9813	618	0857706	12 - 7606	216
45-083-01-S	19 - 4508301S	472	48-098-04-S	26 - 4809804S	618	10224-4085	12 - 7477	215
45-083-02-S	19 - 4508302S	472	48-098-04-S	26 - 9813	618	104511	12 - 7477	215
45-083-02-S	19 - 1388	472	48-108-01-S	23 - 2472	561	12581-43012	20 - 9146	497
45-098-09-S	26 - 9802	617	48-108-02-S	23 - 6802	561	12581-68900	31 - 1781	1077
45-098-09-S	26 - 4509809S	617	48-108-03-S	23 - 6803	561	12681-11220	19 - 7046	474
45-098-10-S	26 - 4509810S	618	48-108-04-S	23 - 6804	562	15222-11221	19 - 8279	474
45-098-10-S	26 - 9812	618	48-108-05-S	23 - 2473	561	15241-32090	19 - 12120	483
45-755-04-S	23 - 9381	573	48-108-06-S	23 - 6805	561	15531-64603	31 - 9210	1079
45-883-02-S1	19 - 4588302S1	472	48-108-07-S	23 - 6806	562	15852-11081	19 - 8327	474
4508301S	19 - 4508301S	472	48-108-08-S	23 - 6807	562	15852-11082	19 - 8327	474
4508302S	19 - 4508302S	472	48-340 01-S	31 - 11219	1069	15853-32430	19 - 10883	483
4509809S	26 - 4509809S	617	4809804S	26 - 4809804S	618	1G069-63010	26 - 14551	620
4509810S	26 - 4509810S	618	52 050 02 S	19 - 12863	450	65621-37212	15 - 6173	378
4588302S1	19 - 4588302S1	472	52-041-17-S	23 - 3542	580	70000-00602	15 - 6209	378
46-874-01-S	23 - 6739	564	52-050-02-S	19 - 5909	483	70000-00604	15 - 3386	377
46-874-04-S	23 - 6740	564	52-050-02-S1	19 - 5205002S1	483	70000-11081	19 - 8328	474
47-004-01-S	23 - 2754	573	52-050-02S	19 - 5205002S	483	70000-11221	19 - 8279	474
			52-05025S	19 - 12863	450	70000-25001	15 - 6209	378

O.E.M. REPLACEMENT CROSS REFERENCE



CROSS REFERENCE 2014

OEM #	Our #	Page #	OEM #	Our #	Page #	OEM #	Our #	Page #
KUBOTA			KUBOTA			LAWNBOY		
70000-25004	15 - 6265	378	K564734340	15 - 11558	378	602763	23 - 2973	581
7000025003	15 - 3386	377	K5649-3434-2	15 - 6209	378	602850	23 - 2961	580
7000025005	15 - 6208	377	K5651-34340	15 - 6209	378	602956	12 - 5012	211
7000025006	15 - 3388	378	K5668-42100	07 - 14473	106	602956	12 - 7444	214
7000025008	15 - 3389	378	K5677-34340	15 - 12995	379	602957	12 - 7436	214
7000025025	15 - 6173	378	K7561-82360	19 - 10080	459	602957	12 - 5014	211
7000025044	15 - 3387	377	LA-40	12 - 7484	215	603441	10 - 2964	180
70080-01200	12 - 7526	215	LB-67	12 - 7613	216	603682	12 - 7467	215
70080-01201	12 - 7541	215	LB-69	12 - 7615	216	603703	15 - 1057	379
70712-34330	15 - 3386	377	SB-76	12 - 7624	216	604116	23 - 2759	570
70721-34330	15 - 3387	377				604257	26 - 1333	630
70722-34330	15 - 3388	378	KYNAST			604260	26 - 2240	628
76500-34330	15 - 6208	377	3R-1668	15 - 50123	379	604274	19 - 1378	475
76505-46250	07 - 8299	106				604283	23 - 3544	580
76529-34330	15 - 6265	378	LAMBERT			604498	12 - 7440	214
76539-34330	15 - 11558	378	4-1030	12 - 5068	212	604513	12 - 7578	216
76539-34330	15 - 6209	378				605020	23 - 2956	557
76539-3437-2	17 - 12829	435	LAWNBOY			605255	10 - 440	177
76540-34330	15 - 3389	378	1002948	31 - 1898	1077	605711	12 - 7514	215
76543-46250	07 - 8300	106	1002949	31 - 1897	1077	606248	12 - 7476	215
76550-34330	15 - 6207	379	103321	12 - 7479	215	606250	12 - 7495	215
7655034334	15 - 6207	379	103324	12 - 7480	215	606508	12 - 7491	215
76559-46250	07 - 8300	106	103335	12 - 7480	215	606863	25 - 2230	605
76710-40850	12 - 7477	215	103347	12 - 7596	216	607192	12 - 7483	215
76710-40851	12 - 7497	215	103351	12 - 7623	216	607271	12 - 7487	215
77700-01541	33 - 11993	1120	107-4621	19 - 1380	475	607310	20 - 7236	508
77700-01543	33 - 11994	1120	1074622	19 - 10183	475	607547	26 - 2241	608
HH15032094	19 - 12120	483	121330	12 - 6843	233	607580	19 - 1379	475
HH15032430	19 - 10883	483	145871	12 - 7438	214	607657	05 - 2953	89
K1122-24122	20 - 8936	513	153066	27 - 7235	660	607658	05 - 2958	89
K1122-62282	31 - 9663	1066	153802	06 - 2999	98	607980	12 - 7505	215
K112224120	20 - 8936	513	16146	12 - 7482	215	608014	12 - 7478	215
K112262280	31 - 9663	1066	16386	12 - 7483	215	608014T	12 - 5068	212
K1211-62231	31 - 9657	1064	207925	12 - 7437	214	608025	12 - 7511	215
K1211-82320	19 - 9550	459	208626	12 - 7432	214	608094	15 - 849	379
K121162230	31 - 11470	1065	235000	12 - 7595	216	608362	23 - 2974	581
K121162231	31 - 11470	1065	236914	12 - 7648	216	608474	12 - 7505	215
K2561-62251	31 - 9660	1066	237255	12 - 12051	228	608475	12 - 7513	215
K3111-42750	10 - 13664	159	237255	12 - 7546	215	608476	12 - 7499	215
K3181-82240	19 - 13383	475	240773	12 - 7517	215	609133	26 - 2959	608
K3181-82250	19 - 13384	475	240773L	12 - 7517	215	609229	26 - 2957	628
K5112-71940	15 - 14482	378	245477	12 - 7527	215	609342	23 - 2956	557
K5351-34342	15 - 14483	378	245805	12 - 7450	214	609419	23 - 2972	581
K5371-34340	15 - 14481	378	2499	12 - 7479	215	609420	23 - 2970	580
K5371-42110	07 - 10301	104	25090	12 - 7503	215	609476	23 - 2971	580
K5371-42110	07 - 6917	103	300096	22 - 9558	533	609477	25 - 2230	605
K5576-34350	15 - 14096	377	301996	22 - 2950	538	609493	19 - 1380	475
K5617-34330	15 - 14095	378	42499	12 - 7479	215	609957	12 - 5014	211
K5619-34350	15 - 14488	378	45589	12 - 7480	215	610032	26 - 7722	610
K5645-34340	15 - 6209	378	602016	19 - 2779	475	610040	12 - 7449	214
K5647-34330	15 - 11558	378	602052	23 - 3550	579	610040	12 - 5027	211
K5647-3434-2	15 - 6209	378	602632	23 - 2956	557	610206	41 - 5504	1225
K5647-34340	15 - 6209	378	602717	18 - 2955	442	610302	26 - 13581	633



O.E.M. REPLACEMENT CROSS REFERENCE

2014 CROSS REFERENCE

OEM #	Our #	Page #	OEM #	Our #	Page #	OEM #	Our #	Page #
LAWNBOY			LAWNBOY			LAWNBOY		
610312	27 - 7206	490	700504	41 - 5504	1225	706783	12 - 7493	215
610440	05 - 3269	89	701213	12 - 7528	215	706810	12 - 7535	215
610441	05 - 3270	89	701667	12 - 7450	214	706811	12 - 7584	216
610482	20 - 7236	508	701748	12 - 7517	215	706885	12 - 7496	215
611396	23 - 2956	557	701756	07 - 6914	105	706929	12 - 7444	214
611803	12 - 7438	214	701798	12 - 7432	214	707058	12 - 7476	215
612079	15 - 848	379	702804	07 - 6919	103	707143	12 - 7475	215
612079-03	15 - 848	379	702814	12 - 7635	216	707144	12 - 7472	215
612543	15 - 849	379	702829	12 - 7595	216	707189	12 - 7529	215
612574	23 - 8369	581	702855	15 - 2030	358	740207	31 - 10772	1071
613361	19 - 6659	475	702926	12 - 12051	228	740207	31 - 5933	1071
613435	19 - 6660	475	702926	12 - 7546	215	740280	07 - 6915	105
614245	19 - 6660	475	703025	12 - 7638	216	741316	05 - 300	92
677052	20 - 1347	34	703078	12 - 7509	215	92-4923	23 - 2749	565
677271	22 - 1421	544	703106	12 - 7539	215	92-9697	22 - 2950	538
677525	17 - 2220	428	703107	12 - 7648	216	926389	22 - 9558	533
678071	23 - 2758	573	703422	12 - 7593	216	93-1233	23 - 2970	580
678406	06 - 2976	97	703454	12 - 7542	215	95 5574	19 - 10183	475
678415	22 - 1421	544	703570	12 - 7539	215	98-1362	23 - 2961	580
678513	06 - 2977	97	703621	12 - 7481	215			
678636	06 - 2965	97	703627	12 - 7482	215	LESCO		
678637	06 - 2989	97	703632	12 - 7483	215	021871	15 - 3403	347
678637	06 - 2980	97	703715	13 - 734	36	021871	15 - 6300	322
678638	06 - 2966	97	703715	13 - 5869	263	050062	13 - 2188	263
678638	06 - 2989	97	704008	12 - 7478	215	050062	13 - 12891	281
678882	22 - 2950	538	704070	12 - 7588	216	050073	31 - 1929	1072
679252	23 - 1464	560	704081	12 - 7473	215	050111	15 - 6009	379
679966	28 - 1994	663	704903	12 - 7481	215	050125	15 - 6294	323
681446	20 - 1350	514	705366	12 - 7625	216	050125	15 - 3404	347
681578	31 - 1897	1077	705367	12 - 7499	215	050140	15 - 6294	323
681737	23 - 2954	560	705368	12 - 7585	216	050140	15 - 3442	380
681741	22 - 2950	538	705381	12 - 7517	215	050156	15 - 6008	380
681904	09 - 6542	135	705402	12 - 7521	215	050170	15 - 6299	324
681979	06 - 2977	97	705455	12 - 7437	214	050170	15 - 3434	362
681980	06 - 2976	97	705484	12 - 7476	215	050328	07 - 6918	104
682069	27 - 7235	660	705507	12 - 7430	214	051432	15 - 6209	378
682340	31 - 1897	1077	705508	12 - 7443	214	12242	31 - 9659	1066
682685	05 - 9126	69	705520	12 - 7470	215	18295	20 - 8936	513
682755	20 - 7238	513	705533	07 - 6918	104	21871	15 - 6300	322
682909	15 - 848	379	705553	12 - 7482	215	50125	15 - 6294	323
682972	06 - 2989	97	705594	12 - 7529	215	50140	15 - 6294	323
682972	06 - 2966	97	705595	12 - 7482	215	50170	15 - 6299	324
682974	06 - 2989	97	705682	12 - 7539	215	50445	12 - 5233	257
682974	06 - 2980	97	705687	12 - 7534	215	50623	12 - 7913	242
682986	23 - 2749	565	705730	12 - 7438	214	50643	12 - 6836	242
683129	05 - 3271	89	705758	12 - 7481	215	60561	12 - 8810	242
683210	26 - 2463	630	705766	12 - 7523	215	60563	12 - 9257	246
683215	31 - 1898	1077	705928	12 - 7501	215			
683682	15 - 849	379	706175	12 - 7483	215	LITTLE WONDER		
683777	22 - 10935	540	706205	12 - 7439	214	177	12 - 5063	212
700291	12 - 7439	214	706545	12 - 7450	214	177A	12 - 7473	215
700292	12 - 7446	214	706577	12 - 7516	215	177B	12 - 7473	215
700371	41 - 5504	1225	706618	12 - 7484	215	4164205	08 - 14302	111

O.E.M. REPLACEMENT CROSS REFERENCE



CROSS REFERENCE 2014

OEM #	Our #	Page #	OEM #	Our #	Page #	OEM #	Our #	Page #
MANCO			MAXIM			MTD		
1036	05 - 9195	84	145107	15 - 2137	328	00030352	42 - 14179	1233
12346	12 - 13057	226	272240	12 - 5065	212	00030353	42 - 14185	1231
1414	10 - 8682	173	320372204	12 - 5071	212	01000151	12 - 13551	237
2433	12 - 13627	226	359328	12 - 5083	212	01000152	42 - 14178	1232
4292	12 - 13054	225	M35932580	12 - 5083	212	01000152P	42 - 14178	1232
5959	12 - 8487	226				05002-0637	41 - 9122	1228
8192	12 - 13050	226	MAXTRAC			05080A	05 - 8898	93
9655	12 - 13053	226	1065356	41 - 5548	1227	05080AP	05 - 8898	93
9659	12 - 13053	226				07120	05 - 307	89
MARINA			MERRY TILLER			08253B	09 - 367	137
CP042013	15 - 10199	381	030-0112	12 - 7479	215	09054	05 - 255	88
CP047010	15 - 10198	381	030-0131	12 - 7493	215	09321	10 - 856	197
CP050013	15 - 10201	381	1023	12 - 7486	215	09322	10 - 9145	194
CP056103	15 - 10202	381	1530	12 - 7480	215	09966	10 - 863	160
			1637	12 - 7444	214	1001046	10 - 10189	197
			1984	12 - 7488	215	10769	17 - 1162	428
MARUYAMA			1985	12 - 7476	215	10914	05 - 309	88
216062	16 - 6107	421	2031	12 - 7493	215	14802A-0637	10 - 9512	158
216062	16 - 6477	421	2059	12 - 7493	215	17188B	10 - 8313	161
840084	16 - 6477	421	2278	12 - 7484	215	17188B-0637	10 - 8313	161
840084	16 - 6107	421	227B	12 - 5074	212	17189	10 - 8314	161
			2313	12 - 7450	214	17189B	10 - 8314	161
MARVEL-SCHEBLER			2391	12 - 7479	215	17189B-0637	10 - 8313	161
28-113A	22 - 1423	537	2404	12 - 7435	214	1916946	29 - 8611	667
28-114A	22 - 1424	537	329	12 - 7488	215	1916946001	29 - 8611	667
			471224	29 - 450	666	1916947	29 - 8610	667
MASSEY FERGUSON			48350	12 - 5068	212	1916947001	29 - 8610	667
1023-556-M1	13 - 729	36	594	12 - 7477	215	490-240-0001	20 - 12515	496
1035-991-M1	19 - 1384	473	608-0020	12 - 7484	215	490-241-0006	41 - 5585	1228
1040-013-M1	13 - 728	36	701-0055	12 - 7450	214	54446	07 - 282	101
1044-627-M1	19 - 1388	472	862	12 - 7483	215	5L550	12 - 5182	213
1568	09 - 442	134	MINNEAPOLIS MOLINE			600	18 - 859	440
511-450-M1	13 - 726	36	344217	12 - 5098	212	618-0111	10 - 9284	197
51432M1	12 - 5053	212	MONO			618-0112	10 - 9285	196
831-054-M1	09 - 813	133	G-1080	12 - 5065	212	618-0116	10 - 9284	197
831-055-M1	09 - 813	133	MONTGOMERY WARD			618-0116B	10 - 9284	197
833-411-M1	09 - 484	133	163142	12 - 5074	212	618-0116C	10 - 9284	197
83341M1	09 - 484	133	2038-32	12 - 5065	212	618-0116P	10 - 9284	197
834-336-M1	13 - 731	36	2038-39	12 - 5072	212	618-0117	10 - 9285	196
			754-203	12 - 5188	213	618-0117A	10 - 9285	196
MAX TORQUE			MORIDGE			618-0117B	10 - 9285	196
20-12	04 - 13988	81	183894	31 - 9659	1066	618-0138	10 - 9288	196
21-12-0002	04 - 13990	81	MOUNTFIELD			618-0138A	10 - 9288	196
21-12-0003	04 - 13989	81	M4358	15 - 50022	381	618-0138C	10 - 9288	196
MXT97	12 - 9346	232	RCL29004700	03 - 10222	59	618-0142	10 - 9288	196
MXT98	12 - 9792	232				618-0142A	10 - 9288	196
TCDNS34-IN	04 - 13990	81				618-0142C	10 - 9288	196
TCDNS34-OUT	04 - 13989	81				618-0240	10 - 9286	195
TCDRS34	04 - 13988	81				618-0240A	10 - 9286	195
						618-0240B	10 - 9286	195
MAXIM						618-0240C	10 - 9286	195
130720	29 - 8609	666				618-0241	10 - 9287	196
130721	29 - 8608	666				618-0241B	10 - 9287	196



O.E.M. REPLACEMENT CROSS REFERENCE

2014 CROSS REFERENCE

OEM #	Our #	Page #	OEM #	Our #	Page #	OEM #	Our #	Page #
MTD			MTD			MTD		
618-0241C	10 - 9287	196	717-0913	10 - 8968	197	731-0287	41 - 5521	1225
618-0268	10 - 12659	189	717-1425	41 - 5547	1222	731-0393	05 - 3227	88
618-0268A	10 - 12659	189	717-1554	10 - 13360	182	731-06472	41 - 5584	1228
618-0269	10 - 12660	189	717-1708	10 - 11828	169	731-06472	41 - 5585	1228
618-04129A	10 - 11963	187	717-1709	10 - 11829	169	731-0778	41 - 5523	1223
618-04129B	10 - 11963	187	718-04068	13 - 9600	288	731-0780	41 - 5521	1225
618-0428	10 - 12659	189	720-0241	10 - 863	160	731-0780A	41 - 5521	1225
618-0428A	10 - 12659	189	72004072A	10 - 863	160	731-0781	41 - 5521	1225
618-0429	10 - 12660	189	721-3018A	10 - 12535	187	731-0781A	41 - 5521	1225
618-0429	10 - 12660	189	723-0156	10 - 2210	174	731-0782	41 - 5521	1225
618-0430	10 - 9286	195	723-0179	10 - 2212	174	731-0812	41 - 5523	1223
618-0430A	10 - 9286	195	723-0296	10 - 3242	161	731-0908	05 - 8309	88
618-0430B	10 - 9286	195	723-0351	10 - 9489	174	731-0972	03 - 7717	60
618-0430C	10 - 9286	195	723-0448A	10 - 9159	174	731-1033	41 - 5523	1223
618-0431	10 - 12448	195	723-3018	10 - 2210	174	732-0153	10 - 3207	171
618-04474	10 - 13631	195	725-0128	31 - 6888	1069	732-0157	10 - 254	171
618-04608A	10 - 12612	195	725-0142	10 - 9288	196	732-0307	10 - 3221	172
618-04636	10 - 13029	188	725-0267	31 - 2922	1062	732-0307A	10 - 3221	172
618-04636A	10 - 13029	188	725-0267A	31 - 2922	1062	732-0429A	10 - 9268	172
618-0565	10 - 12066	196	725-04165	31 - 14247	1068	732-0433	10 - 291	171
618-0574	10 - 12066	196	725-04175	31 - 14323	1065	732-0594A	10 - 9717	173
618-0594	10 - 12448	195	725-04228	31 - 9655	1060	732-0638	10 - 9184	173
618-0624	10 - 12219	195	725-04258	31 - 13106	1065	732-0814	10 - 9404	172
618-0625B	10 - 12967	188	725-04347	31 - 9622	1063	732-0815	10 - 9295	172
618-0659	10 - 12219	195	725-04437	31 - 10772	1071	734-04155	07 - 12648	104
618-0660	10 - 12967	188	725-04439	31 - 14220	1072	734-0510	06 - 3240	100
618-0671	10 - 12612	195	725-05013	31 - 14331	1067	734-0949	06 - 433	100
618-0671B	10 - 12612	195	725-0530	31 - 3319	1071	734-0973	07 - 430	106
618-0671D	10 - 12612	195	725-0530	31 - 10771	1071	734-0974	07 - 8297	106
618-3167	10 - 13220	195	725-0771	31 - 3319	1071	734-1661	07 - 9156	102
61TR38	12 - 5064	212	725-0771	31 - 7934	1072	734-1842	07 - 9156	102
629-0071	26 - 13643	621	725-0771	31 - 10771	1071	734-3058	07 - 6916	106
634-3159	07 - 14446	103	725-1341B	31 - 10793	1069	734-3058B	07 - 6916	106
683-0055	10 - 8950	181	725-1396	31 - 9853	1060	735-0149	20 - 7730	510
706-15971	05 - 8898	93	725-1426	31 - 10771	1071	738-0196	10 - 3220	183
710-0405	10 - 863	160	725-1426	31 - 7935	1072	738-0197	10 - 3218	183
710-04484	02 - 9466	52	725-1430	31 - 7724	1057	738-0276	41 - 5546	1222
710-0890	41 - 8627	1221	725-1438	31 - 7724	1057	738-0284	41 - 5545	1222
710-0891	41 - 8628	1221	725-1635	31 - 7724	1057	738-0373	10 - 314	39
710-1174	10 - 863	160	725-1660	31 - 13278	1069	738-04124A	41 - 5549	1222
7100890A	41 - 8627	1221	725-1716	31 - 9657	1064	738-0455	10 - 314	39
711-0169	04 - 467	83	725-1717	31 - 9623	1060	738-0569	10 - 7281	182
712-0417A	10 - 10228	178	725-1741	31 - 12685	1060	738-0933	10 - 9517	196
712-3022	10 - 8447	178	725-1745	31 - 11219	1069	738-1010A	10 - 12926	195
714-0143	10 - 9232	162	725-1752	31 - 9657	1064	738-3056	10 - 11142	179
7140143A	10 - 9232	162	725-2018	31 - 7976	1063	741-0133	09 - 8869	130
717-04080	10 - 12247	165	725-3164A	31 - 9665	1066	741-0155	09 - 8831	132
717-04183	10 - 14327	169	725-3166	31 - 9664	1066	741-0199	09 - 3200	146
717-0900	10 - 7156	195	725-3167	31 - 9663	1066	741-0225	09 - 7836	144
717-0900A	10 - 7156	195	725-3167	31 - 9660	1066	741-0244	09 - 9328	135
717-0906	10 - 7155	197	725-3169A	31 - 9659	1066	741-0293	09 - 3211	146
717-0906A	10 - 7155	197	725-3233	31 - 9657	1064	741-0313	09 - 7720	144
717-0912	10 - 8967	197	727-0162	19 - 6680	484	741-0324	09 - 9326	130

O.E.M. REPLACEMENT CROSS REFERENCE



CROSS REFERENCE 2014

OEM #	Our #	Page #	OEM #	Our #	Page #	OEM #	Our #	Page #
MTD			MTD			MTD		
741-0340	09 - 9572	133	742-0500	15 - 6140	382	746-0630A	03 - 10687	61
741-0374	09 - 9327	147	742-0503	15 - 6028	383	746-0632	03 - 9130	60
741-0376	09 - 8445	146	742-0520	15 - 6005	382	746-0634A	03 - 9855	61
741-0404	09 - 7241	135	742-0521	15 - 6096	383	746-0672	03 - 9131	60
741-041	09 - 6573	133	742-0522	15 - 6004	383	746-0674A	03 - 11516	61
741-0487	09 - 7720	144	742-0537	15 - 6126	382	746-0713	03 - 10684	61
741-0487A	09 - 7720	144	742-0538	15 - 6127	383	746-0737	05 - 11515	71
741-0524	09 - 483	132	742-0539	15 - 6128	381	746-0776	03 - 9569	60
741-0600	09 - 8507	132	742-0542	15 - 1021	385	746-0801	03 - 9840	61
741-0659	09 - 13467	136	742-0543	15 - 1022	385	746-0841	03 - 11516	61
741-0660	09 - 13468	136	742-0563	15 - 6139	383	746-0842	03 - 9133	60
741-0660A	09 - 13468	136	742-0607	15 - 50202	383	746-0843	03 - 9134	60
741-0706	09 - 12856	145	742-0608	15 - 50201	383	746-0845	03 - 9132	60
741-0919	09 - 442	134	742-0610	15 - 11232	386	746-0847	03 - 11518	61
7410324A	09 - 9326	130	742-0611	15 - 1029	385	746-0898	05 - 5616	69
7410487C	09 - 7720	144	742-0612	15 - 1030	340	746-0898A	05 - 5616	69
742-0105	29 - 8610	667	742-0616	15 - 11233	386	746-0946	05 - 11517	71
742-0105-0637	29 - 8610	667	742-0620	15 - 6005	382	746-0968	10 - 12410	73
742-0106	29 - 8611	667	742-0621	15 - 6042	383	746-0970	05 - 10686	70
742-0106-0637	29 - 8611	667	742-0622	15 - 6004	383	746-1085A	03 - 14624	59
742-0118	15 - 1077	381	742-0640	15 - 6439	387	746-1086	03 - 10685	61
742-0120	15 - 997	382	742-0642	15 - 6425	388	746-1113	05 - 13332	69
742-0121	15 - 1014	382	742-0644	15 - 1037	385	746-1115	03 - 11518	61
742-0121B	15 - 1014	382	742-0645	15 - 1038	385	746-1130	05 - 13264	69
742-0122A	15 - 1015	382	742-0656	15 - 1031	386	746-1132	05 - 14040	69
742-0123	15 - 1016	382	742-0677A	15 - 11719	342	746-3021	03 - 11519	59
742-0123B	15 - 1016	382	742-0677A	15 - 12963	382	748-0108	09 - 382	143
742-0124	15 - 1017	383	742-0677B	15 - 11719	342	748-0110	09 - 293	144
742-0124B	15 - 1017	383	742-0721	15 - 6139	383	748-0169	09 - 3222	146
742-0125	15 - 1018	383	742-0722	15 - 6212	384	748-0184	09 - 3201	144
742-0125B	15 - 1018	383	742-0739	15 - 12893	342	748-0203	10 - 3215	182
742-0171	15 - 3356	382	742-0741	15 - 6423	387	748-0227	09 - 3202	144
742-0171B	15 - 3356	382	742-0742	15 - 6424	387	748-0227A	09 - 3202	144
742-0241A	12 - 6906	233	742-3036	15 - 10636	341	748-0235	17 - 7810	429
742-0252	15 - 3408	381	7420677	15 - 11719	342	748-0300	17 - 6626	428
742-0256	15 - 3354	384	746-04092	05 - 13657	71	748-0300B	17 - 6626	428
742-0256A	15 - 3354	384	746-04120	03 - 14324	57	748-0365	17 - 7119	429
742-0295	15 - 3407	384	746-04173A	05 - 12965	73	748-0852	05 - 3205	88
742-0306	15 - 6042	383	746-04173B	05 - 12965	73	748-0855	09 - 3209	144
742-0306A	15 - 6042	383	746-04173C	05 - 12965	73	748-0867	09 - 3213	144
742-04126	15 - 1032	386	746-04206A	05 - 13416	69	748-5038B	41 - 7766	1228
742-04126	15 - 11233	386	746-04214	03 - 14621	58	751-10298	19 - 7980	460
742-04126	15 - 1031	386	746-04618	05 - 14341	73	751-10448C	18 - 14456	442
742-04154	15 - 12909	342	746-0550	03 - 10688	61	751-10517A	23 - 6783	586
742-04308	15 - 1031	386	746-0551	05 - 11511	71	751-3111	20 - 8935	514
742-0473A	15 - 6006	382	746-0552	05 - 11512	71	7510603A	20 - 8935	514
742-0486	15 - 6019	381	746-0553	05 - 10817	69	753-0210	17 - 7810	429
742-0487	15 - 6003	382	746-0554	05 - 11513	71	753-04472	41 - 13167	1223
742-0487A	15 - 6003	382	746-0555	05 - 11514	71	753-0484	17 - 10239	429
742-0496	15 - 6143	382	746-0613A	03 - 9681	59	753-0518	13 - 10672	281
742-0499	15 - 6028	383	746-0614A	03 - 9682	59	753-05319	10 - 7155	197
742-0499	15 - 6295	325	746-0616A	03 - 9683	59	753-0583	17 - 9815	429
742-0499A	15 - 6028	383	746-0629	05 - 8833	72	753-0600	31 - 7724	1057



O.E.M. REPLACEMENT CROSS REFERENCE

2014 CROSS REFERENCE

OEM #	Our #	Page #	OEM #	Our #	Page #	OEM #	Our #	Page #
MTD			MTD			MTD		
753-0608	31 - 7724	1057	754-0136	12 - 7576	216	754-0183	12 - 5156	213
753-0613	41 - 5521	1225	754-0137	12 - 7473	215	754-0183	12 - 7574	216
753-0687	06 - 433	100	754-0138	12 - 5177	213	754-0184	12 - 7495	215
75304856A	07 - 6916	106	754-0138	12 - 7595	216	754-0184	12 - 5085	212
753C0628	41 - 5593	1226	754-0139	12 - 5021	211	754-0185	12 - 7492	215
753C0629	41 - 5594	1226	754-0139	12 - 7443	214	754-0185	12 - 5082	212
754-0016	12 - 5058	212	754-0142	12 - 7436	214	754-0186	12 - 7525	215
754-0100	12 - 5051	212	754-0143	12 - 7433	214	754-0186	12 - 5115	212
754-0101	12 - 7478	215	754-0144	12 - 7600	216	754-0187	12 - 5151	213
754-0101A	12 - 7478	215	754-0144	12 - 5182	213	754-0188	12 - 7596	216
754-0101A	12 - 5068	212	754-0145	12 - 7614	216	754-0188	12 - 5178	213
754-0101A	12 - 10089	233	754-0145A	12 - 5196	213	754-0189	12 - 7487	215
754-0102	12 - 7480	215	754-0145A	12 - 7614	216	754-0189	12 - 5077	212
754-0103	12 - 7470	215	754-0146	12 - 7476	215	754-0190	12 - 5072	212
754-0104	12 - 7475	215	754-0146	12 - 5066	212	754-0190	12 - 7482	215
754-0104	12 - 5065	212	754-0147	12 - 7597	216	754-0191	12 - 5098	212
754-0105	12 - 7473	215	754-0147	12 - 5179	213	754-0191	12 - 7508	215
754-0106	12 - 7468	215	754-0149	12 - 7586	216	754-0192	12 - 7477	215
754-0106	12 - 5058	212	754-0151	12 - 7612	216	754-0192	12 - 5067	212
754-0107	12 - 5063	212	754-0151	12 - 5194	213	754-0193	12 - 7478	215
754-0107	12 - 7473	215	754-0152	12 - 7494	215	754-0193	12 - 5068	212
754-0108	12 - 7489	215	754-0153	12 - 7439	214	754-0194	12 - 7488	215
754-0108	12 - 5079	212	754-0154	12 - 5070	212	754-0194	12 - 5078	212
754-0109	12 - 5076	212	754-0154	12 - 7480	215	754-0195	12 - 5087	212
754-0109	12 - 7486	215	754-0154	12 - 7481	215	754-0195	12 - 7497	215
754-0111	12 - 7488	215	754-0155	12 - 7445	214	754-0195A	12 - 7497	215
754-0111	12 - 5078	212	754-0156	12 - 5053	212	754-0196	12 - 7473	215
754-0112	12 - 5207	213	754-0157	12 - 7573	216	754-0196	12 - 5063	212
754-0112	12 - 7625	216	754-0157	12 - 5155	213	754-0197	12 - 9900	235
754-0113	12 - 7593	216	754-0158	12 - 7580	216	754-0198	12 - 7505	215
754-0113	12 - 5175	213	754-0158	12 - 5162	213	754-0198	12 - 5095	212
754-0114	12 - 7467	215	754-0163	12 - 7471	215	754-0199	12 - 7581	216
754-0114	12 - 5057	212	754-0163	12 - 5061	212	754-0200	12 - 7491	215
754-0115	12 - 7606	216	754-0164	12 - 5096	212	754-0200	12 - 5081	212
754-0115	12 - 5188	213	754-0164	12 - 7506	215	754-0201	12 - 7484	215
754-0116	12 - 7485	215	754-0165	12 - 7477	215	754-0201	12 - 5074	212
754-0118	12 - 7608	216	754-0166	12 - 7607	216	754-0202	12 - 7528	215
754-0124	12 - 7500	215	754-0166	12 - 5189	213	754-0202	12 - 5118	212
754-0126	12 - 5053	212	754-0167	12 - 5191	213	754-0203	12 - 5188	213
754-0127	12 - 7611	216	754-0167	12 - 7609	216	754-0203	12 - 7606	216
754-0127	12 - 5193	213	754-0173	12 - 7582	216	754-0204	12 - 5100	212
754-0128	12 - 7580	216	754-0173	12 - 5164	213	754-0204	12 - 7510	215
754-0128	12 - 7478	215	754-0175	12 - 7627	216	754-0205	12 - 7436	214
754-0129	12 - 5171	213	754-0177	12 - 5065	212	754-0205	12 - 5014	211
754-0129	12 - 7589	216	754-0177	12 - 7475	215	754-0205	12 - 7437	214
754-0130	12 - 7471	215	754-0178	12 - 5209	213	754-0206	12 - 7493	215
754-0131	12 - 8820	260	754-0178	12 - 7627	216	754-0207	12 - 7485	215
754-0131	12 - 8432	221	754-0179	12 - 7493	215	754-0208	12 - 7498	215
754-0134	12 - 7438	214	754-0180	12 - 5181	213	754-0209	12 - 7493	215
754-0134	12 - 5016	211	754-0180	12 - 7599	216	754-0210	12 - 5187	213
754-0135	12 - 7570	216	754-0181	12 - 7543	215	754-0210	12 - 7605	216
754-0135	12 - 5152	213	754-0182	12 - 7626	216	754-0211	12 - 7591	216
754-0136	12 - 5158	213	754-0182	12 - 5208	213	754-0211	12 - 5173	213

O.E.M. REPLACEMENT CROSS REFERENCE



CROSS REFERENCE 2014

OEM #	Our #	Page #	OEM #	Our #	Page #	OEM #	Our #	Page #
MTD			MTD			MTD		
754-0212	12 - 7590	216	754-0241	12 - 7580	216	754-0283	12 - 7538	215
754-0212	12 - 5172	213	754-0241A	12 - 6906	233	754-0284	12 - 7586	216
754-0213	12 - 5086	212	754-0241A	12 - 7580	216	754-0285	12 - 7477	215
754-0213	12 - 7496	215	754-0242	12 - 7475	215	754-0287	12 - 7472	215
754-0214	12 - 5083	212	754-0243	12 - 7489	215	754-0290	12 - 7490	215
754-0214	12 - 7493	215	754-0243	12 - 5079	212	754-0291	12 - 7531	215
754-0215	12 - 7550	215	754-0244	12 - 7483	215	754-0291A	12 - 7531	215
754-0216	12 - 7434	214	754-0244	12 - 5073	212	754-0292	12 - 7469	215
754-0216	12 - 5012	211	754-0245	12 - 5092	212	754-0293	12 - 7517	215
754-0217	12 - 5206	213	754-0245	12 - 7502	215	754-0293	12 - 6841	233
754-0217	12 - 7624	216	754-0247	12 - 7498	215	754-0294	12 - 7532	215
754-0218	12 - 7604	216	754-0248	12 - 5122	212	754-0299	12 - 7492	215
754-0218	12 - 5186	213	754-0248	12 - 7532	215	754-0325	12 - 7500	215
754-0219	12 - 5059	212	754-0249	12 - 7575	216	754-0326	12 - 7505	215
754-0219	12 - 7469	215	754-0250	12 - 7496	215	754-0327	12 - 7573	216
754-0220	12 - 5154	213	754-0250	12 - 5086	212	754-0328	12 - 7594	216
754-0220	12 - 7572	216	754-0251	12 - 7494	215	754-0329	12 - 7614	216
754-0221	12 - 5179	213	754-0252	12 - 5066	212	754-0329	12 - 6842	236
754-0221	12 - 7597	216	754-0252	12 - 7476	215	754-0329A	12 - 6842	236
754-0222	12 - 5077	212	754-0253	12 - 7486	215	754-0330	12 - 7533	215
754-0222	12 - 7487	215	754-0253	12 - 5076	212	754-0338	12 - 7520	215
754-0223	12 - 7441	214	754-0254	12 - 5052	212	754-0339	12 - 7522	215
754-0223	12 - 5019	211	754-0255	12 - 7480	215	754-0340	12 - 7629	216
754-0224	12 - 5153	213	754-0255	12 - 5070	212	754-0341	12 - 7637	216
754-0224	12 - 7571	216	754-0256	12 - 5012	211	754-0342	12 - 7511	215
754-0225	12 - 7550	215	754-0256	12 - 7434	214	754-0343	12 - 7436	214
754-0226	12 - 7525	215	754-0257	12 - 5021	211	754-0344	12 - 7516	215
754-0226	12 - 5115	212	754-0257	12 - 7443	214	754-0346	12 - 6950	233
754-0227	12 - 7608	216	754-0261	12 - 7499	215	754-0347	12 - 7506	215
754-0227	12 - 5190	213	754-0264	12 - 7495	215	754-0349	12 - 7522	215
754-0228	12 - 5189	213	754-0264	12 - 7169	233	754-0349	12 - 6843	233
754-0228	12 - 7607	216	754-0265	12 - 7472	215	754-0350	12 - 6844	233
754-0229	12 - 7495	215	754-0265	12 - 5062	212	754-0350	12 - 7609	216
754-0229	12 - 5085	212	754-0266	12 - 7528	215	754-0351	12 - 7504	215
754-0230	12 - 7499	215	754-0266	12 - 6838	233	754-0355	12 - 6949	235
754-0230	12 - 5089	212	754-0267	12 - 7502	215	754-0356	12 - 7440	214
754-0231	12 - 7471	215	754-0268	12 - 5178	213	754-0357	12 - 7483	215
754-0231	12 - 5061	212	754-0268	12 - 7596	216	754-0358	12 - 9570	233
754-0232	12 - 5053	212	754-0270	12 - 7527	215	754-0362	12 - 9482	235
754-0233	12 - 5054	212	754-0271	12 - 7444	214	754-0364	12 - 7613	216
754-0234	12 - 5074	212	754-0271	12 - 9901	235	754-0365	12 - 7526	215
754-0234	12 - 7484	215	754-0273	12 - 7439	214	754-0366	12 - 7431	214
754-0235	12 - 7478	215	754-0274	12 - 7487	215	754-0367	12 - 13288	233
754-0235	12 - 5068	212	754-0275	12 - 7481	215	754-0370	12 - 6908	235
754-0236	12 - 7528	215	754-0276	12 - 7491	215	754-0371A	12 - 6845	235
754-0236	12 - 5118	212	754-0277	12 - 7514	215	754-04001	12 - 10831	235
754-0238	12 - 7535	215	754-0278	12 - 7473	215	754-04001A	12 - 10831	235
754-0238	12 - 5125	212	754-0279	12 - 7610	216	754-04002	12 - 10833	235
754-0239	12 - 7472	215	754-0280	12 - 6839	233	754-04014	12 - 13567	233
754-0239	12 - 5062	212	754-0281	12 - 6840	233	754-04032	12 - 13232	233
754-0240	12 - 7583	216	754-0282	12 - 7444	214	754-04032A	12 - 13232	233
754-0240	12 - 6907	235	754-0282	12 - 7482	215	754-04032B	12 - 13232	233
754-0241	12 - 6906	233	754-0282A	12 - 7538	215	754-04033	12 - 11843	227



O.E.M. REPLACEMENT CROSS REFERENCE

2014 CROSS REFERENCE

OEM #	Our #	Page #	OEM #	Our #	Page #	OEM #	Our #	Page #
MTD			MTD			MTD		
754-04041	12 - 12610	234	754-0641	12 - 11850	227	756-0627	13 - 8602	264
754-04043	12 - 12382	235	754-0642	12 - 11661	237	756-0627D	13 - 11144	280
754-04043A	12 - 12382	235	754-0644	12 - 10783	228	756-0638	13 - 9708	281
754-04044	12 - 11844	227	754-0645	12 - 10784	228	756-0658	13 - 9590	282
754-04045	12 - 11845	227	754-0737	12 - 7604	216	756-0969	13 - 9588	281
754-04048	12 - 12667	233	754-0935	12 - 7474	215	756-0980	13 - 9587	281
754-04050	12 - 14118	234	754-0935	12 - 5064	212	756-0981	13 - 12891	281
754-04057	12 - 6906	233	754-0936	12 - 7490	215	756-0981	13 - 2188	263
754-04060B	12 - 11660	236	754-0936	12 - 5080	212	756-0981A	13 - 12891	281
754-04062	12 - 11846	227	754-0937	12 - 7604	216	756-0982B	13 - 10185	282
754-04064	12 - 11840	227	754-0938	12 - 7604	216	756-0983B	13 - 10186	282
754-04077	12 - 11847	227	754-262	12 - 5066	212	756-1208	13 - 5869	263
754-04082A	12 - 13653	235	754-3001	12 - 7637	216	756-3062	13 - 14090	280
754-04083	12 - 11661	237	754-3002	12 - 7515	215	756-3105	13 - 12613	281
754-04101	12 - 11137	237	754-3003	12 - 7634	216	75604129B	13 - 12675	281
754-04118	12 - 12609	227	754-3018	12 - 7529	215	75604209	13 - 728	36
754-04122	12 - 11848	234	754-3024	12 - 7534	215	7560487	13 - 734	36
754-04138	12 - 12768	227	754-3036	12 - 10781	228	7560643A	13 - 8588	264
754-04142	12 - 12489	234	754-3038	12 - 10563	228	7561035A	13 - 729	36
754-04153	12 - 12769	227	754-3039	12 - 12051	228	759-3939	15 - 10636	341
754-04158	12 - 10306	223	754-3055A	12 - 11997	227	7595	12 - 5053	212
754-04207	12 - 12770	234	754-3068	12 - 11820	228	761-0168	10 - 8295	162
754-04219	12 - 12790	234	754-3073	12 - 10782	228	761-0168A	10 - 8295	162
754-04240	12 - 12791	234	754-3084	12 - 10901	228	781-0081	16 - 2148	423
754-04252	12 - 13301	234	754-328	12 - 5176	213	784-5038A	41 - 7766	1228
754-0430	12 - 12429	235	756-0116	13 - 728	36	784-5576-0637	41 - 5591	1226
754-0430A	12 - 12429	235	756-0117	13 - 720	36	784-5579A	41 - 5593	1226
754-0430B	12 - 12429	235	756-0137	13 - 719	36	784-5580	41 - 8828	1228
754-0433	12 - 6842	236	756-0166	13 - 729	36	784-5581A	41 - 5592	1226
754-0439	12 - 9119	234	756-0199	13 - 718	36	784-5581A-0637	41 - 5592	1226
754-0440	12 - 9120	234	756-0225	13 - 2176	263	784-5581A-0662	41 - 5592	1226
754-0441	12 - 9847	234	756-0226	13 - 5869	263	784-5581A-0687	41 - 5592	1226
754-0443A	12 - 9581	234	756-0240	13 - 722	36	784-5582A	41 - 5594	1226
754-0446	12 - 9932	234	756-0240	13 - 721	36	7845038B0637	41 - 7766	1228
754-0453	12 - 9480	236	756-0243	13 - 2193	264	790-00117-0637	41 - 5591	1226
754-0460	12 - 11132	236	756-0293A	13 - 5869	263	790-00118-0637	41 - 5594	1226
754-0461	12 - 9903	236	756-0293A	13 - 734	36	790-00119-0637	41 - 5595	1226
754-0465	12 - 13232	233	756-0365	13 - 11144	280	790-00120-0637	41 - 5592	1226
754-0467	12 - 11482	236	756-04002	13 - 12810	281	790-00121-0637	41 - 5593	1226
754-0467A	12 - 11482	236	756-04064A	13 - 12853	282	791-180852B	24 - 12650	592
754-0468	12 - 11483	236	756-04067A	13 - 12854	282	791-61031B	24 - 10950	595
754-0472	12 - 9935	234	756-04129	13 - 12675	281	791-683974	20 - 11510	51
754-0474	12 - 10261	236	756-04195	13 - 12854	282	791683974B	20 - 11510	51
754-0476	12 - 10260	236	756-04196A	13 - 12855	282	794-00043	24 - 14308	592
754-0483	12 - 11135	236	756-04224	13 - 12891	281	831-0796A	03 - 8417	60
754-0485	12 - 10009	235	756-04325	13 - 731	36	910-0405	10 - 863	160
754-0486	12 - 10100	236	756-04325	13 - 14326	280	910-0890	41 - 8627	1221
754-0486A	12 - 10100	236	756-0437	13 - 8588	264	910-0891	41 - 8628	1221
754-0497	12 - 11019	236	756-0486	13 - 8657	281	910-1174	10 - 863	160
754-0498	12 - 10369	237	756-0487	13 - 5869	263	911-0169	04 - 467	83
754-0506	12 - 7493	215	756-0542	13 - 14091	280	914-0122	04 - 461	80
754-0637A	12 - 11137	237	756-0556	13 - 8965	282	917-04080	10 - 12247	165
754-0640	12 - 11849	227	756-0603	13 - 9589	282	917-04183	10 - 14327	169

O.E.M. REPLACEMENT CROSS REFERENCE



CROSS REFERENCE 2014

OEM #	Our #	Page #	OEM #	Our #	Page #	OEM #	Our #	Page #
MTD			MTD			MTD		
917-04622	10 - 14327	169	918-0624	10 - 12219	195	9251426A	31 - 10771	1071
917-0900	10 - 7156	195	918-0625B	10 - 12967	188	9251426A	31 - 7935	1072
917-0900A	10 - 7156	195	918-0659	10 - 12219	195	9251716	31 - 9657	1064
917-0900A	10 - 7156	195	918-0660	10 - 12967	188	9251717	31 - 9623	1060
917-0906	10 - 7155	197	918-0671B	10 - 12612	195	9251745A	31 - 11219	1069
917-0906A	10 - 7155	197	918-0671B	10 - 12612	195	9252018	31 - 7976	1063
917-0912	10 - 8967	197	918-0671D	10 - 12612	195	9253166	31 - 9664	1066
917-0913	10 - 8968	197	918-3167	10 - 13220	195	9253167	31 - 9663	1066
917-1425	41 - 5547	1222	9180138C	10 - 9288	196	9253167	31 - 9660	1066
917-1708	10 - 11828	169	9180142C	10 - 9288	196	9253169A	31 - 9659	1066
917-1709	10 - 11829	169	9180240C	10 - 9286	195	9253233	31 - 9657	1064
917-1774B	10 - 12424	169	91804068	13 - 9600	288	927-0162	19 - 6680	484
91705001	10 - 12424	169	9180428B	10 - 12659	189	929-0071	26 - 13643	621
9171774C	10 - 12424	169	9180624A	10 - 12219	195	9290071A	26 - 13643	621
918-0116	10 - 9284	197	9180659A	10 - 12219	195	931-0393	05 - 3227	88
918-0116B	10 - 9284	197	920-0241	10 - 9565	160	931-0780	41 - 5521	1225
918-0116C	10 - 9284	197	920-0241	10 - 863	160	931-0780A	41 - 5521	1225
918-0117	10 - 9285	196	921-3018A	10 - 12535	187	931-0781	41 - 5521	1225
918-0117A	10 - 9285	196	922-0153	09 - 9502	144	931-0782	41 - 5521	1225
918-0117B	10 - 9285	196	923-0156	10 - 2210	174	931-0782A	41 - 5521	1225
918-0138	10 - 9288	196	923-0296	10 - 3242	161	931-0908	05 - 8309	88
918-0142	10 - 9288	196	923-0351	10 - 9489	174	931-0972	03 - 7717	60
918-0142A	10 - 9288	196	923-0448A	10 - 9159	174	931-1033	41 - 5523	1223
918-0240	10 - 9286	195	923-3018	10 - 11031	174	932-0153	10 - 3207	171
918-0240A	10 - 9286	195	923-3018	10 - 2210	174	932-0157	10 - 254	171
918-0240A	10 - 9286	195	9230179	10 - 2212	174	932-0307	10 - 3221	172
918-0240B	10 - 9286	195	925-0128	31 - 6888	1069	932-0307A	10 - 3221	172
918-0241	10 - 9287	196	925-0267	31 - 2922	1062	932-0433	10 - 291	171
918-0241B	10 - 9287	196	925-0267A	31 - 2922	1062	932-0594A	10 - 9717	173
918-0268	10 - 12659	189	925-04040	31 - 14246	1067	9320429A	10 - 9268	172
918-0269	10 - 12660	189	925-04165	31 - 14247	1068	9322	10 - 9145	194
918-04129A	10 - 11963	187	925-04175	31 - 14323	1065	934-0510	06 - 3240	100
918-04129B	10 - 11963	187	925-05013	31 - 14331	1067	934-0949	06 - 433	100
918-0428	10 - 12659	189	925-0530	31 - 3319	1071	934-0973	07 - 430	106
918-0428A	10 - 12659	189	925-0771	31 - 7934	1072	934-0974	07 - 8297	106
918-0429	10 - 12660	189	925-0771	31 - 10771	1071	934-1842	07 - 9156	102
918-0429A	10 - 12660	189	925-0873	31 - 14672	1062	934-3058	07 - 6916	106
918-0430A	10 - 9286	195	925-1396	31 - 9853	1060	935-0149	20 - 7730	510
918-0430B	10 - 9286	195	925-1426	31 - 10771	1071	935-0243B	41 - 5612	1223
918-0430C	10 - 9286	195	925-1426	31 - 7935	1072	938-0196	10 - 3220	183
918-0431	10 - 9287	196	925-1430	31 - 7724	1057	938-0197	10 - 3218	183
918-0431	10 - 12448	195	925-1438	31 - 7724	1057	938-0373	10 - 314	39
918-0431	10 - 9287	196	925-1635	31 - 7724	1057	938-0455	10 - 314	39
918-0431B	10 - 9287	196	925-1648	31 - 10895	1064	938-0569	10 - 7281	182
918-0431C	10 - 9287	196	925-1657A	31 - 9661	1068	938-3056	10 - 11142	179
918-04474A	10 - 13631	195	925-1741	31 - 12685	1060	938-3056	10 - 7115	179
918-04608A	10 - 12612	195	925-1741	31 - 7015	1060	941-0155	09 - 8831	132
918-04636	10 - 13029	188	925-1745	31 - 11219	1069	941-0185	09 - 10264	134
918-04865	10 - 13029	188	925-3164A	31 - 9665	1066	941-0199	09 - 3200	146
918-04865A	10 - 13029	188	9250267B	31 - 2922	1062	941-0225	09 - 7836	144
918-0565	10 - 12066	196	92504228	31 - 9655	1060	941-0293	09 - 3211	146
918-0574	10 - 12066	196	92504347	31 - 9622	1063	941-0309	09 - 10265	134
918-0574C	10 - 12066	196	9251396A	31 - 9853	1060	941-0313	09 - 7720	144



O.E.M. REPLACEMENT CROSS REFERENCE

2014 CROSS REFERENCE

OEM #	Our #	Page #	OEM #	Our #	Page #	OEM #	Our #	Page #
MTD			MTD			MTD		
941-0404	09 - 7241	135	942-0500	15 - 6140	382	9420611A	15 - 1029	385
941-041	09 - 6573	133	942-0520	15 - 6005	382	9420612A	15 - 1030	340
941-0487	09 - 7720	144	942-0521	15 - 6096	383	9420642A	15 - 6425	388
941-0487A	09 - 7720	144	942-0522	15 - 6004	383	9420677B	15 - 11719	342
941-0524	09 - 483	132	942-0537	15 - 6126	382	9420741A	15 - 6423	387
941-0656A	09 - 13229	145	942-0538	15 - 6127	383	9420742A	15 - 6424	387
941-0659	09 - 13467	136	942-0539	15 - 6128	381	946-04092	05 - 13657	71
941-0660	09 - 13468	136	942-0542	15 - 1021	385	946-04173	05 - 12965	73
941-0706	09 - 12856	145	942-0543	15 - 1022	385	946-04173A	05 - 12965	73
941-0919	09 - 442	134	942-0563	15 - 6139	383	946-04173B	05 - 12965	73
9410170	09 - 9328	135	942-0609	15 - 1023	386	946-04173C	05 - 12965	73
9410340	09 - 9572	133	942-0610	15 - 11232	386	946-04206A	05 - 13416	69
9410376	09 - 8445	146	942-0610	15 - 1024	386	946-04214	03 - 14621	58
9410490	09 - 3200	146	942-0610A	15 - 1026	386	946-04618A	05 - 14341	73
9410524A	09 - 483	132	942-0611	15 - 1029	385	946-0551	05 - 11511	71
9410600	09 - 8507	132	942-0612	15 - 1030	340	946-0552	05 - 11512	71
9410919A	09 - 442	134	942-0616	15 - 1031	386	946-0554	05 - 11513	71
942-0118	15 - 1077	381	942-0616	15 - 11233	386	946-0555	05 - 11514	71
942-0120	15 - 997	382	942-0616	15 - 1032	386	946-0614A	03 - 9682	59
942-0121	15 - 1014	382	942-0616A	15 - 11233	386	946-0616A	03 - 9683	59
942-0121B	15 - 1014	382	942-0620	15 - 6005	382	946-0629	05 - 8833	72
942-0122A	15 - 1015	382	942-0621	15 - 6096	383	946-0632	03 - 9130	60
942-0123	15 - 1016	382	942-0621	15 - 6042	383	946-0672	03 - 9131	60
942-0123B	15 - 1016	382	942-0621A	15 - 6042	383	946-0737	05 - 11515	71
942-0124	15 - 1017	383	942-0622	15 - 6004	383	946-0776	03 - 9569	60
942-0124B	15 - 1017	383	942-0623	15 - 1034	385	946-0841	03 - 11516	61
942-0125	15 - 1018	383	942-0640	15 - 6439	387	946-0842	03 - 9133	60
942-0125B	15 - 1018	383	942-0641	15 - 6450	387	946-0843	03 - 9134	60
942-0171	15 - 3356	382	942-0642	15 - 6425	388	946-0845	03 - 9132	60
942-0171B	15 - 3356	382	942-0644	15 - 1037	385	946-0847	03 - 11518	61
942-0241A	12 - 6906	233	942-0645	15 - 1038	385	946-0898	05 - 5616	69
942-0252	15 - 3408	381	942-0656	15 - 1031	386	946-0946	05 - 11517	71
942-0256	15 - 3354	384	942-0677	15 - 12963	382	946-0970	05 - 10686	70
942-0256A	15 - 3354	384	942-0677	15 - 11719	342	946-1085A	03 - 14624	59
942-0295	15 - 3407	384	942-0677A	15 - 11719	342	946-1113	05 - 13332	69
942-0306	15 - 6042	383	942-0720	15 - 6457	383	946-1132	05 - 14040	69
942-0306A	15 - 6042	383	942-0721	15 - 6139	383	946-3021	03 - 11519	59
942-04053-X	15 - 12809	342	942-0722	15 - 6212	384	94604173E	05 - 12965	73
942-04053A	15 - 12809	342	942-0738	15 - 6448	387	9460550	03 - 10688	61
942-04053B	15 - 12809	342	942-0739	15 - 12893	342	9460553	05 - 10817	69
942-04053C	15 - 12809	342	942-0740	15 - 6438	387	9460613A	03 - 9681	59
942-04154	15 - 12909	342	942-0741	15 - 6423	387	9460630A	03 - 10687	61
942-04244	15 - 12956	386	942-0742	15 - 6424	387	9460634	03 - 9855	61
942-04290	15 - 12956	386	9420122B	15 - 1015	382	9460638	03 - 9569	60
942-0473A	15 - 6006	382	94204058	15 - 1023	386	9460671A	03 - 9130	60
942-0486	15 - 6019	381	94204126	15 - 11233	386	9460674A	03 - 9131	60
942-0486A	15 - 6019	381	94204126	15 - 1032	386	9460713A	03 - 10684	61
942-0487	15 - 6003	382	94204126	15 - 1031	386	9460802A	03 - 9840	61
942-0487A	15 - 6003	382	94204154A	15 - 12909	342	9461086	03 - 10685	61
942-0496	15 - 6143	382	94204244A	15 - 12956	386	9461113A	05 - 13332	69
942-0499	15 - 6028	383	94204308	15 - 1031	386	9461115	03 - 9132	60
942-0499A	15 - 6295	325	9420607C	15 - 50202	383	9461130	05 - 13264	69
942-0499A	15 - 6028	383	9420608C	15 - 50201	383	948-0108	09 - 382	143

O.E.M. REPLACEMENT CROSS REFERENCE



CROSS REFERENCE 2014

OEM #	Our #	Page #	OEM #	Our #	Page #	OEM #	Our #	Page #
MTD			MTD			MTD		
948-0110	09 - 293	144	954-0127	12 - 5193	213	954-0175	12 - 7627	216
948-0169	09 - 3222	146	954-0128	12 - 7478	215	954-0177	12 - 5065	212
948-0184	09 - 3201	144	954-0129	12 - 7589	216	954-0177	12 - 7475	215
948-0203	10 - 3215	182	954-0129	12 - 5171	213	954-0178	12 - 5209	213
948-0227	09 - 3202	144	954-0130	12 - 7471	215	954-0178	12 - 7627	216
948-0227A	09 - 3202	144	954-0131	12 - 8432	221	954-0179	12 - 7493	215
948-0235	17 - 7810	429	954-0131	12 - 8820	260	954-0180	12 - 5181	213
948-0300B	17 - 6626	428	954-0134	12 - 5016	211	954-0180	12 - 7599	216
948-0323	17 - 10238	429	954-0134	12 - 7438	214	954-0181	12 - 7543	215
948-0365	17 - 7119	429	954-0135	12 - 7570	216	954-0182	12 - 7626	216
948-0852	05 - 3205	88	954-0135	12 - 5152	213	954-0182	12 - 5208	213
948-0855	09 - 3209	144	954-0136	12 - 5158	213	954-0183	12 - 5156	213
948-0867	09 - 3213	144	954-0136	12 - 7576	216	954-0183	12 - 7574	216
948-5038B	41 - 7766	1228	954-0137	12 - 7473	215	954-0184	12 - 7495	215
950-0957	09 - 10240	148	954-0138	12 - 7595	216	954-0184	12 - 5085	212
951-10292	24 - 7311	590	954-0138	12 - 5177	213	954-0185	12 - 5082	212
951-10292	24 - 9873	595	954-0139	12 - 7443	214	954-0185	12 - 7492	215
951-10298	19 - 7980	460	954-0139	12 - 5021	211	954-0186	12 - 5115	212
951-10300	20 - 10018	513	954-0142	12 - 7436	214	954-0186	12 - 7525	215
951-10517A	23 - 6783	586	954-0143	12 - 7433	214	954-0187	12 - 5151	213
951-3111	20 - 8935	514	954-0144	12 - 7600	216	954-0188	12 - 5178	213
953-0210	17 - 7810	429	954-0144	12 - 5182	213	954-0188	12 - 7596	216
953-0600	31 - 7724	1057	954-0145	12 - 7614	216	954-0189	12 - 7487	215
953-0608	31 - 7724	1057	954-0145A	12 - 5196	213	954-0189	12 - 5077	212
954-0016	12 - 5058	212	954-0145A	12 - 7614	216	954-0190	12 - 7482	215
954-0100	12 - 5051	212	954-0146	12 - 7476	215	954-0190	12 - 5072	212
954-0101A	12 - 7478	215	954-0146	12 - 5066	212	954-0191	12 - 7508	215
954-0101A	12 - 5068	212	954-0147	12 - 5179	213	954-0191	12 - 5098	212
954-0101A	12 - 10089	233	954-0147	12 - 7597	216	954-0192	12 - 7477	215
954-0103	12 - 7470	215	954-0149	12 - 7586	216	954-0192	12 - 5067	212
954-0104	12 - 7475	215	954-0151	12 - 5194	213	954-0193	12 - 5068	212
954-0104	12 - 5065	212	954-0151	12 - 7612	216	954-0193	12 - 7478	215
954-0106	12 - 7468	215	954-0152	12 - 7494	215	954-0194	12 - 5078	212
954-0106	12 - 5058	212	954-0153	12 - 7439	214	954-0194	12 - 7488	215
954-0107	12 - 7473	215	954-0154	12 - 7480	215	954-0195	12 - 5087	212
954-0107	12 - 5063	212	954-0154	12 - 5070	212	954-0195A	12 - 7497	215
954-0108	12 - 5079	212	954-0155	12 - 7445	214	954-0196	12 - 5063	212
954-0108	12 - 7489	215	954-0156	12 - 5053	212	954-0196	12 - 7473	215
954-0109	12 - 7486	215	954-0157	12 - 7573	216	954-0197	12 - 9900	235
954-0109	12 - 5076	212	954-0157	12 - 5155	213	954-0198	12 - 5095	212
954-0111	12 - 5078	212	954-0158	12 - 7580	216	954-0198	12 - 7505	215
954-0111	12 - 7488	215	954-0158	12 - 5162	213	954-0199	12 - 7581	216
954-0112	12 - 5207	213	954-0163	12 - 7471	215	954-0200	12 - 7491	215
954-0112	12 - 7625	216	954-0163	12 - 5061	212	954-0200	12 - 5081	212
954-0113	12 - 5175	213	954-0164	12 - 7506	215	954-0201	12 - 7484	215
954-0113	12 - 7593	216	954-0164	12 - 5096	212	954-0201	12 - 5074	212
954-0114	12 - 5057	212	954-0165	12 - 7477	215	954-0202	12 - 7528	215
954-0114	12 - 7467	215	954-0166	12 - 7607	216	954-0202	12 - 5118	212
954-0115	12 - 7606	216	954-0166	12 - 5189	213	954-0203	12 - 5188	213
954-0116	12 - 7485	215	954-0167	12 - 7609	216	954-0203	12 - 7606	216
954-0118	12 - 7608	216	954-0167	12 - 5191	213	954-0204	12 - 5100	212
954-0124	12 - 7500	215	954-0173	12 - 5164	213	954-0204	12 - 7510	215
954-0127	12 - 7611	216	954-0173	12 - 7582	216	954-0206	12 - 7493	215



O.E.M. REPLACEMENT CROSS REFERENCE

2014 CROSS REFERENCE

OEM #	Our #	Page #	OEM #	Our #	Page #	OEM #	Our #	Page #
MTD			MTD			MTD		
954-0207	12 - 7485	215	954-0239	12 - 7472	215	954-0281	12 - 6840	233
954-0208	12 - 7498	215	954-0239	12 - 5062	212	954-0282	12 - 7482	215
954-0210	12 - 5187	213	954-0240	12 - 6907	235	954-0283	12 - 7538	215
954-0210	12 - 7605	216	954-0240	12 - 7583	216	954-0284	12 - 7586	216
954-0211	12 - 7591	216	954-0241	12 - 7580	216	954-0285	12 - 7477	215
954-0211	12 - 5173	213	954-0241	12 - 6906	233	954-0287	12 - 7472	215
954-0212	12 - 5172	213	954-0241A	12 - 6906	233	954-0290	12 - 7490	215
954-0212	12 - 7590	216	954-0242	12 - 7475	215	954-0291	12 - 7531	215
954-0213	12 - 7496	215	954-0243	12 - 5079	212	954-0292	12 - 7469	215
954-0213	12 - 5086	212	954-0243	12 - 7489	215	954-0293	12 - 6841	233
954-0214	12 - 5083	212	954-0244	12 - 7483	215	954-0294	12 - 7532	215
954-0214	12 - 7493	215	954-0244	12 - 5073	212	954-0299	12 - 7492	215
954-0216	12 - 7434	214	954-0245	12 - 5092	212	954-0325	12 - 7500	215
954-0216	12 - 5012	211	954-0245	12 - 7502	215	954-0326	12 - 7505	215
954-0217	12 - 7624	216	954-0247	12 - 7498	215	954-0327	12 - 7573	216
954-0217	12 - 5206	213	954-0248	12 - 7532	215	954-0328	12 - 7594	216
954-0218	12 - 5186	213	954-0248	12 - 5122	212	954-0329	12 - 7614	216
954-0218	12 - 7604	216	954-0249	12 - 7575	216	954-0329	12 - 6842	236
954-0219	12 - 5059	212	954-0250	12 - 5086	212	954-0329A	12 - 6842	236
954-0219	12 - 7469	215	954-0250	12 - 7496	215	954-0338	12 - 7520	215
954-0220	12 - 5154	213	954-0251	12 - 7494	215	954-0339	12 - 7522	215
954-0220	12 - 7572	216	954-0252	12 - 5066	212	954-0340	12 - 7629	216
954-0221	12 - 5179	213	954-0252	12 - 7476	215	954-0341	12 - 7637	216
954-0221	12 - 7597	216	954-0253	12 - 7486	215	954-0342	12 - 7511	215
954-0222	12 - 5077	212	954-0253	12 - 5076	212	954-0343	12 - 7436	214
954-0222	12 - 7487	215	954-0254	12 - 5052	212	954-0344	12 - 7516	215
954-0223	12 - 5019	211	954-0255	12 - 7480	215	954-0346	12 - 6950	233
954-0223	12 - 7441	214	954-0255	12 - 5070	212	954-0349	12 - 6843	233
954-0224	12 - 5153	213	954-0256	12 - 7434	214	954-0350	12 - 6844	233
954-0224	12 - 7571	216	954-0256	12 - 5012	211	954-0355	12 - 6949	235
954-0225	12 - 7550	215	954-0257	12 - 5021	211	954-0358	12 - 9570	233
954-0226	12 - 7525	215	954-0257	12 - 7443	214	954-0362	12 - 9482	235
954-0226	12 - 5115	212	954-0261	12 - 7499	215	954-0367	12 - 13288	233
954-0227	12 - 7608	216	954-0264	12 - 7169	233	954-0370	12 - 6908	235
954-0227	12 - 5190	213	954-0264	12 - 7495	215	954-0371A	12 - 6845	235
954-0228	12 - 7607	216	954-0265	12 - 5062	212	954-04001	12 - 10831	235
954-0228	12 - 5189	213	954-0265	12 - 7472	215	954-04001A	12 - 10831	235
954-0229	12 - 5085	212	954-0266	12 - 6838	233	954-04002	12 - 10833	235
954-0229	12 - 7495	215	954-0266	12 - 7528	215	954-04014	12 - 13567	233
954-0230	12 - 7499	215	954-0266A	12 - 7528	215	954-04032	12 - 13232	233
954-0230	12 - 5089	212	954-0268	12 - 5178	213	954-04032A	12 - 13232	233
954-0231	12 - 5061	212	954-0268	12 - 7596	216	954-04032B	12 - 13232	233
954-0231	12 - 7471	215	954-0270	12 - 7527	215	954-04033	12 - 11843	227
954-0232	12 - 5053	212	954-0271	12 - 7444	214	954-04041	12 - 12610	234
954-0233	12 - 5054	212	954-0271	12 - 9901	235	954-04043	12 - 12382	235
954-0234	12 - 7484	215	954-0273	12 - 7439	214	954-04043A	12 - 12382	235
954-0234	12 - 5074	212	954-0274	12 - 7487	215	954-04044	12 - 11844	227
954-0235	12 - 7478	215	954-0275	12 - 7481	215	954-04044A	12 - 11844	227
954-0235	12 - 5068	212	954-0276	12 - 7491	215	954-04045	12 - 11845	227
954-0236	12 - 7528	215	954-0277	12 - 7514	215	954-04048	12 - 12667	233
954-0236	12 - 5118	212	954-0278	12 - 7473	215	954-04050	12 - 14118	234
954-0238	12 - 7535	215	954-0279	12 - 7610	216	954-04057	12 - 6906	233
954-0238	12 - 5125	212	954-0280	12 - 6839	233	954-04060B	12 - 11660	236

O.E.M. REPLACEMENT CROSS REFERENCE



CROSS REFERENCE 2014

OEM #	Our #	Page #	OEM #	Our #	Page #	OEM #	Our #	Page #
MTD			MTD			MTD		
954-04062	12 - 11846	227	954-3038	12 - 10563	228	984-5038A	41 - 7766	1228
954-04064	12 - 11840	227	954-3039	12 - 12051	228	984-5580	41 - 8828	1228
954-04077	12 - 11847	227	954-3055A	12 - 11997	227	A610	12 - 5158	213
954-04082A	12 - 13653	235	954-3068	12 - 11820	228	GW9322099	10 - 9145	194
954-04083	12 - 11661	237	954-3073	12 - 10782	228	TC35062	31 - 13278	1069
954-04118	12 - 12609	227	954-3084	12 - 10901	228			
954-04122	12 - 11848	234	954-328	12 - 5176	213	MURRAY		
954-04138A	12 - 12768	227	9540205	12 - 7437	214	0025X7	02 - 9470	52
954-04142	12 - 12489	234	9540205	12 - 7436	214	0025X7MA	02 - 9470	52
954-04153	12 - 12769	227	9540205	12 - 5014	211	009X10	10 - 312	39
954-04158	12 - 10306	223	9540222A	12 - 7487	215	009X10MA	10 - 312	39
954-04207	12 - 12770	234	9540222A	12 - 5077	212	009X10Z	10 - 312	39
954-04219	12 - 12790	234	9540266A	12 - 7528	215	009X10ZMA	10 - 312	39
954-04240	12 - 12791	234	9540266A	12 - 6838	233	021031	10 - 2210	174
954-04252	12 - 13301	234	9540267	12 - 7502	215	021553	12 - 5081	212
954-04265	12 - 14215	235	9540280A	12 - 6839	233	021553	12 - 7491	215
954-0430A	12 - 12429	235	9540330	12 - 7533	215	024273	31 - 9663	1066
954-0430B	12 - 12429	235	9540339A	12 - 7522	215	037X87MA	12 - 9995	238
954-0433	12 - 6842	236	9540351	12 - 7504	215	037X98	12 - 10042	239
954-0439	12 - 9119	234	9540356	12 - 7440	214	056526	13 - 10164	283
954-0440	12 - 9120	234	9540357	12 - 7483	215	071133	07 - 11021	103
954-0441	12 - 9847	234	9540364	12 - 7613	216	071589	28 - 8978	663
954-0446	12 - 9932	234	9540365	12 - 7526	215	091271SE	18 - 6510	442
954-0453	12 - 9480	236	95404033A	12 - 11843	227	091871E701	15 - 6129	391
954-0460	12 - 11132	236	95404043B	12 - 12382	235	092265	07 - 6916	106
954-0461	12 - 9903	236	95404153A	12 - 12769	227	092317	20 - 8934	514
954-0465	12 - 13232	233	9540443A	12 - 9581	234	092371	03 - 9684	62
954-0467	12 - 11482	236	9540645A	12 - 10784	228	092425	13 - 7995	284
954-0467A	12 - 11482	236	956-0116	13 - 728	36	092466	17 - 5935	430
954-0468	12 - 11483	236	956-0117	13 - 720	36	092683	07 - 10087	106
954-0472	12 - 9935	234	956-0137	13 - 719	36	092683	07 - 6916	106
954-0474	12 - 10261	236	956-0166	13 - 729	36	092849MA	10 - 13605	183
954-0476	12 - 10260	236	956-0199	13 - 718	36	094121MA	10 - 13208	180
954-0483	12 - 11135	236	956-0225	13 - 2176	263	094136	31 - 9662	1068
954-0485	12 - 10009	235	956-0240	13 - 722	36	094136MA	31 - 9662	1068
954-0486A	12 - 10100	236	956-0365	13 - 11144	280	094159	31 - 9664	1066
954-0497	12 - 11019	236	956-04064A	13 - 12853	282	094159MA	31 - 9664	1066
954-0498	12 - 10369	237	956-04067A	13 - 12854	282	094592	13 - 9514	285
954-0637A	12 - 11137	237	956-04129	13 - 9377	269	094692E701	15 - 6470	389
954-0640	12 - 11849	227	956-04129	13 - 12675	281	095100E701	15 - 6476	391
954-0641	12 - 11850	227	956-0437	13 - 8588	264	095100E701A	15 - 6476	391
954-0642	12 - 11661	237	956-0486	13 - 8657	281	095101E701	15 - 6162	391
954-0644	12 - 10783	228	956-0556	13 - 8965	282	095101E701	15 - 9897	391
954-0645	12 - 10784	228	956-0627	13 - 8602	264	095103E701	15 - 6475	390
954-0935	12 - 5064	212	956-0627D	13 - 11144	280	095103E701	15 - 6475	390
954-0935	12 - 7474	215	956-3105	13 - 12613	281	10001709MA	10 - 10189	197
954-0936	12 - 5080	212	95604002	13 - 12810	281	1001200	10 - 10189	197
954-0936	12 - 7490	215	9561189	13 - 9590	282	1101120E701	15 - 6471	392
954-0937	12 - 7604	216	961-0168	10 - 8295	162	1101181	03 - 10691	63
954-0938	12 - 7604	216	961-0168A	10 - 8295	162	1101334	05 - 10689	67
954-262	12 - 5066	212	9610168D	10 - 8295	162	1101366	03 - 10693	63
954-3001	12 - 7637	216	981-0081	16 - 2148	423	1101823	15 - 11868	392
954-3036	12 - 10781	228	983-0055-0637	10 - 8950	181	1102094MA	05 - 12969	70



O.E.M. REPLACEMENT CROSS REFERENCE

2014 CROSS REFERENCE

OEM #	Our #	Page #	OEM #	Our #	Page #	OEM #	Our #	Page #
MURRAY			MURRAY			MURRAY		
1401	41 - 5544	1222	21058	12 - 7506	215	24285	31 - 3319	1071
1501435	05 - 7018	93	21059	12 - 7487	215	24458E701	15 - 844	389
1501435MA	05 - 7018	93	21064	31 - 2922	1062	24458HT	15 - 844	389
15X100	10 - 9329	177	21064PA	31 - 2922	1062	24470	05 - 9125	73
15X72	10 - 9296	177	21096	13 - 2929	284	24578	10 - 2937	183
165X3	10 - 2903	172	21222	03 - 229	62	24615	09 - 2936	145
165X4	10 - 2933	172	21222PA	03 - 229	62	25X7	02 - 9470	52
165X58	10 - 2934	172	21223	03 - 228	62	25X7MA	02 - 9470	52
165X76SE	10 - 9716	173	21223PA	03 - 228	62	27323	12 - 7484	215
1713845	31 - 9654	1063	2122PA	03 - 228	62	28594	12 - 7480	215
1718306	31 - 9654	1063	21261	31 - 10771	1071	313847	12 - 7483	215
1733324SM	12 - 8429	221	21409	13 - 2916	263	313851	12 - 7482	215
1740718AYP	41 - 13042	1228	21508	12 - 5096	212	321205	12 - 11017	237
1740718HMA	41 - 13042	1228	21540PA	03 - 230	62	325890	12 - 8432	221
17X166MA	17 - 14050	434	21614	12 - 7528	215	325890MA	12 - 8432	221
20005SE	03 - 242	62	21615	12 - 7538	215	327350	31 - 11219	1069
20045	15 - 2012	390	21649	12 - 7498	215	327350MA	31 - 11219	1069
20045E701	15 - 2012	390	21913	10 - 858	73	327355	31 - 9654	1063
20045HT	15 - 2012	390	21920	05 - 8970	90	35550	05 - 300	92
20046	15 - 2013	392	22611	12 - 7443	214	37X1	12 - 7484	215
20046E701	15 - 2013	392	22846	12 - 7446	214	37X1	12 - 5074	212
20046E701	15 - 2013	392	22860	15 - 3390	391	37X10	12 - 5118	212
20046HT	15 - 2013	392	22860E701	15 - 3390	391	37X10	12 - 7528	215
20062	02 - 41	39	22860HT	15 - 3390	391	37X106	12 - 10910	239
20066	05 - 308	88	23072	12 - 7486	215	37X11	12 - 7538	215
20105	07 - 283	101	23098	12 - 7505	215	37X110	12 - 10832	239
201153	12 - 7505	215	23180	10 - 7284	183	37X111	12 - 10911	239
20159	12 - 7487	215	23203	07 - 8310	106	37X112	12 - 10912	239
20411	05 - 478	88	23211	13 - 2919	263	37X112MA	12 - 10912	239
20555	12 - 5074	212	23213	10 - 8308	175	37X113	12 - 10913	239
20555	12 - 7484	215	23213Z	10 - 8308	175	37X114	12 - 11029	239
20556	12 - 7491	215	23214	12 - 7502	215	37X115	12 - 11030	239
20556	12 - 5081	212	23223	12 - 7537	215	37X12	12 - 7498	215
20557	12 - 5079	212	23223	12 - 7538	215	37X12	12 - 6876	237
20557	12 - 7489	215	23238	13 - 2917	264	37X125	12 - 12462	239
20558	12 - 5097	212	23257	07 - 8311	106	37X13	12 - 5024	211
20558	12 - 7507	215	23332	03 - 230	62	37X14	12 - 7486	215
20613	13 - 2918	263	23332PA	03 - 230	62	37X15	12 - 7505	215
20615	13 - 2926	284	23339	13 - 2915	263	37X16	12 - 5092	212
20616	10 - 2904	183	23347	12 - 7525	215	37X16	12 - 7502	215
20682	10 - 2934	172	23468	11 - 2905	203	37X17	12 - 7538	215
20683	10 - 2903	172	23496	12 - 7517	215	37X18	12 - 7525	215
20715	12 - 7480	215	23739	13 - 3317	284	37X18	12 - 5115	212
20716	12 - 7480	215	23748	12 - 7504	215	37X19	12 - 7517	215
20717	12 - 7499	215	23749	12 - 7542	215	37X19	12 - 5107	212
20928	15 - 1122	389	23796	12 - 7498	215	37X2	12 - 7491	215
20928E701	15 - 1122	389	23853	12 - 7486	215	37X2	12 - 5081	212
20928HT	15 - 1122	389	23882	12 - 7502	215	37X20	12 - 5110	212
20930	15 - 1124	389	24064	20 - 6965	515	37X20	12 - 7520	215
20930E701	15 - 1124	389	24176	12 - 7538	215	37X21	12 - 7505	215
21022	13 - 2928	284	24256	12 - 7531	215	37X22	12 - 6903	237
21024	10 - 2931	183	24273	31 - 9660	1066	37X22	12 - 7542	215
21031	10 - 2210	174	24285	31 - 10771	1071	37X23	12 - 5076	212

O.E.M. REPLACEMENT CROSS REFERENCE



CROSS REFERENCE 2014

OEM #	Our #	Page #	OEM #	Our #	Page #	OEM #	Our #	Page #
MURRAY			MURRAY			MURRAY		
37X23	12 - 7486	215	37X6	12 - 5070	212	43865	15 - 6142	390
37X24	12 - 7502	215	37X61	12 - 6508	238	491921	10 - 7282	182
37X24	12 - 5092	212	37X62	12 - 6904	238	491922	10 - 6890	182
37X25	12 - 5021	211	37X63	12 - 6509	238	492574	10 - 2925	198
37X25	12 - 7443	214	37X63	12 - 7526	215	492574	10 - 12724	198
37X26	12 - 6502	237	37X64	12 - 8747	238	492574	10 - 12925	198
37X26	12 - 7531	215	37X65	12 - 7245	238	494199	13 - 10820	284
37X27	12 - 5116	212	37X66	12 - 8444	238	49450	12 - 7480	215
37X28	12 - 5081	212	37X68	12 - 8442	238	495104	15 - 11555	390
37X28	12 - 7491	215	37X69	12 - 8443	238	50497	02 - 9470	52
37X29	12 - 7444	214	37X7	12 - 5089	212	50597	12 - 7473	215
37X3	12 - 5079	212	37X7	12 - 7499	215	50660	41 - 5543	1222
37X3	12 - 7489	215	37X70	12 - 7672	238	50755	12 - 7481	215
37X30	12 - 7431	214	37X75	12 - 7673	238	50834	12 - 7473	215
37X31	12 - 5126	212	37X8	12 - 7506	215	51224	12 - 7483	215
37X32	12 - 7488	215	37X8	12 - 7505	215	51458	12 - 7482	215
37X33	12 - 6505	237	37X80	12 - 9994	238	53499	12 - 7473	215
37X34	12 - 7520	215	37X83	12 - 9481	238	54053	15 - 2166	392
37X34	12 - 5110	212	37X86	12 - 9712	238	54053E701	15 - 2166	392
37X35	12 - 6505	237	37X87	12 - 9995	238	54053HT	15 - 2166	392
37X35	12 - 7533	215	37X88	12 - 8972	238	5409D	31 - 10771	1071
37X36	12 - 7498	215	37X89	12 - 9313	239	5409H	31 - 10771	1071
37X36	12 - 5088	212	37X9	12 - 7487	215	54211	17 - 1167	430
37X37	12 - 7493	215	37X9	12 - 5077	212	54390	15 - 6018	389
37X38	12 - 7483	215	37X92	12 - 9713	239	54390E	15 - 6018	389
37X38	12 - 6503	237	37X93	12 - 9714	239	54390E701	15 - 1124	389
37X39	12 - 7526	215	37X96	12 - 9715	239	54390E701	15 - 6018	389
37X4	12 - 5097	212	37X98	12 - 10042	239	54390HT	15 - 6018	389
37X4	12 - 7507	215	3887	12 - 7474	215	55101	13 - 7981	285
37X40	12 - 7505	215	402075	10 - 11996	182	55272	10 - 7283	183
37X40	12 - 6504	237	403010	09 - 2935	146	55793E701	15 - 3443	392
37X41	12 - 7509	215	40899	12 - 7480	215	55793HT	15 - 3443	392
37X43	12 - 7526	215	420005	03 - 8530	62	55962	10 - 7765	197
37X43	12 - 4998	237	42005	03 - 8530	62	55969E701	15 - 3430	392
37X44	12 - 7493	215	420613	13 - 7127	263	55969HT	15 - 3430	392
37X45	12 - 7533	215	421409	13 - 7978	263	56060HT	15 - 6027	392
37X45	12 - 6505	237	42225	15 - 2013	392	56061	15 - 6010	392
37X46	12 - 5060	212	42225E701	15 - 2013	392	56061E701	15 - 6010	392
37X46	12 - 7470	215	42225HT	15 - 2013	392	56061HT	15 - 6010	392
37X47	12 - 5124	212	42363	03 - 8416	63	56105	09 - 9044	145
37X47	12 - 7534	215	424285	31 - 3319	1071	56210	15 - 6215	392
37X49	12 - 7445	214	424285	31 - 10771	1071	56212E701	15 - 6027	392
37X5	12 - 7480	215	42569	03 - 8415	63	56217	15 - 6215	392
37X5	12 - 5069	212	42735	17 - 1237	430	56246E701	15 - 6027	392
37X50	12 - 7497	215	42775	03 - 242	62	56250	15 - 6146	390
37X51	12 - 7480	215	42785E701	15 - 2012	390	56250E701	15 - 6146	390
37X52	12 - 7497	215	42785HT	15 - 2012	390	56251	15 - 6145	390
37X55	12 - 5124	212	42877	03 - 242	62	56251E701	15 - 6145	390
37X55	12 - 7534	215	43749	03 - 8416	63	56252	15 - 6144	391
37X56	12 - 10830	226	43828	03 - 10697	64	56252E701	15 - 6144	391
37X57	12 - 6507	238	43836	15 - 6039	391	56258	17 - 5935	430
37X59	12 - 7522	215	43836E701	15 - 6039	391	56631E701	15 - 6408	389
37X6	12 - 7480	215	43836HT	15 - 6039	391	56992	31 - 7976	1063



O.E.M. REPLACEMENT CROSS REFERENCE

2014 CROSS REFERENCE

OEM #	Our #	Page #	OEM #	Our #	Page #	OEM #	Our #	Page #
MURRAY			MURRAY			MURRAY		
57211	31 - 9663	1066	7701100MA	31 - 3319	1071	92418	15 - 6162	391
579932	12 - 7438	214	774091	10 - 9906	182	92418	15 - 9897	391
579932	12 - 8429	221	7769224MA	31 - 3319	1071	92418E701	15 - 6162	391
579932MA	12 - 8429	221	780048	09 - 5619	136	92418E701	15 - 6460	325
585416MA	12 - 14120	237	780061MA	41 - 13042	1228	92419E701	15 - 6166	391
6201316	31 - 9656	1064	880638BZYP	15 - 50254	389	92425	13 - 7995	284
6203	09 - 481	131	880638YP	15 - 50254	389	924285	31 - 10771	1071
62032-RS-5/8	09 - 481	131	881076YP	15 - 50255	389	92466	17 - 5935	430
6219MA	26 - 13643	621	9-38219	18 - 6510	442	92556	31 - 9623	1060
656631	15 - 6408	389	90035	09 - 9746	145	92574	10 - 12925	198
672059E701	15 - 6471	392	90118	13 - 3236	264	92574	10 - 2925	198
672763	15 - 10066	390	903305E	18 - 6510	442	92683	07 - 6916	106
672763E701	15 - 10066	390	90330SE	18 - 6510	442	92683	07 - 10087	106
672835	03 - 10694	64	90330SE	18 - 891	438	93064	09 - 7716	147
672840	03 - 10695	64	91178	13 - 7127	263	94129	10 - 9906	182
680070	10 - 8682	173	91179	13 - 7978	263	94136	31 - 9662	1068
690-407	13 - 9544	279	91271	18 - 6510	442	94159	31 - 9664	1066
690369	13 - 9546	283	91271SE	18 - 6510	442	94613MA	31 - 3319	1071
690387	13 - 9542	283	91299	31 - 9659	1066	94672MA	31 - 7015	1060
690409	13 - 9544	279	91334	09 - 7258	146	94692	15 - 6470	389
690410	13 - 10131	36	91742E701	15 - 6119	390	94692E701	15 - 6470	389
690411	17 - 10957	429	91742E701	15 - 6017	390	94762	31 - 12685	1060
690452	13 - 7126	264	91742HT	15 - 6017	390	94762	31 - 7015	1060
690488	10 - 2925	198	91742HT	15 - 6119	390	94762MA	31 - 12685	1060
690549	13 - 9543	283	91769	13 - 7417	283	94762MAX	31 - 12685	1060
7017817YP	31 - 14672	1062	91769	13 - 7991	284	94927	31 - 9656	1064
7035500YP	12 - 13541	239	91801	13 - 7126	264	95068	13 - 9865	283
710216	12 - 8444	238	91846	31 - 9330	1061	95100	15 - 6476	391
710217	12 - 9313	239	91871	15 - 6129	391	95100E701A	15 - 6476	391
71113	15 - 6174	392	91871HT	15 - 6034	390	95101E701	15 - 6166	391
71113E701	15 - 6174	392	91921	10 - 7282	182	95103E701	15 - 6475	390
71157	03 - 8960	63	91922	10 - 6890	182	95104E701	15 - 11555	390
71157	03 - 7974	63	91926	17 - 5935	430	95309	13 - 9514	285
71161E701	15 - 6160	391	91943	13 - 7991	284	9924285	31 - 3319	1071
71180	03 - 7974	63	91943	13 - 7417	283	BS5409D	31 - 10771	1071
71499	15 - 6174	392	91951	13 - 7986	284	MJ761507	09 - 5619	136
71499E701	15 - 6174	392	91989	03 - 9684	62	MU0025X7	02 - 9470	52
71548	15 - 6142	390	92002	15 - 6112	390	MU25X7	02 - 9470	52
71548E701	15 - 6142	390	92002E701	15 - 6112	390			
71584E701	15 - 6174	392	92002HT	15 - 6112	390	McCULLOCH		
71584E701	15 - 9228	391	92003E701	15 - 6111	390	102115	39 - 8399	1214
71589	28 - 8978	663	92003HT	15 - 6111	390	110676	39 - 8324	48
71849E701	15 - 6174	392	92117	15 - 6113	389	110950	39 - 8399	1214
740193	05 - 10696	67	92117	15 - 9896	389	120029	39 - 8323	48
740194	03 - 9685	62	92117E701	15 - 6113	389	213883	39 - 6985	485
745000MA	31 - 10771	1071	92117E701	15 - 6491	321	213948	20 - 7293	519
745001MS	31 - 10772	1071	92117E7D	15 - 6113	389	21422	39 - 3108	489
75121	12 - 7491	215	92127	13 - 7993	284	214226	39 - 3108	489
75147	12 - 7444	214	92128	13 - 7994	284	215-495	20 - 7293	519
75370	12 - 7431	214	92265	07 - 6916	106	215013	27 - 6966	485
760928MA	12 - 10090	241	92317	20 - 8934	514	215708	38 - 4971	519
761507MA	09 - 5619	136	92352E701	15 - 6161	389	216640	39 - 4795	48
7701016	03 - 9685	62	92377	31 - 9331	1060	216685	39 - 3109	489

O.E.M. REPLACEMENT CROSS REFERENCE



CROSS REFERENCE 2014

OEM #	Our #	Page #	OEM #	Our #	Page #	OEM #	Our #	Page #
MURRAY			NATIONAL			NGK		
217482	37 - 3010	633	07332	31 - 9666	1066	B8HS	24 - 7186	591
224242-01	20 - 11510	51	340356	29 - 482	666	B8S	24 - 2524	594
300149-01	27 - 9496	76	7325	31 - 9659	1066	BCPR5ES	24 - 14636	592
300385	39 - 6985	485	NELSON			BCPR5ES	24 - 11306	594
300467	38 - 4210	1200	83816A	19 - 8332	458	BCPR5ES	24 - 12551	598
300474	37 - 3010	633	NEW HOLLAND			BCPR5ES	24 - 9872	594
63932	38 - 1391	48	86519867	19 - 9728	468	BCPR6ES	24 - 7423	592
65583	38 - 1556	1190	86549701	19 - 9728	468	BCPR6ES	24 - 7229	590
68656	39 - 8398	1214	NGK			BCPR6ES	24 - 6933	593
68685	39 - 1548	489	5077	24 - 11078	596	BCPR6ES	24 - 8554	594
69922	39 - 3109	489	5469	24 - 13039	596	BKR4E	24 - 12431	594
703251	27 - 7864	658	AB6	24 - 7227	589	BKR5E	24 - 11648	597
83078	26 - 13581	633	AB6	24 - 7422	591	BKR5E	24 - 14636	592
83334	37 - 3025	1180	AB6	24 - 5856	594	BKR5E	24 - 12312	596
84929	39 - 8398	1214	AB6	24 - 7227	589	BKR5E-11	24 - 9872	594
87680	37 - 3025	1180	AB7	24 - 7185	591	BKR5ES	24 - 14559	594
906558	39 - 8398	1214	AB7	24 - 2535	594	BKR6E	24 - 12312	596
91458	39 - 1548	489	B2	24 - 7225	589	BM4A	24 - 11523	597
91824	38 - 4210	1200	B2LM	24 - 6877	593	BM4A	24 - 2532	593
91982	39 - 8399	1214	B2LM	24 - 9371	597	BM4A	24 - 2507	591
92410	39 - 3107	489	B2LM	24 - 5936	591	BM4A	24 - 2523	594
92420	39 - 3109	489	B2LM	24 - 10706	594	BM6A	24 - 5859	589
94362	39 - 8399	1214	B4	24 - 7224	589	BM6A	24 - 2529	593
95213	39 - 3108	489	B4H	24 - 5855	594	BM6A	24 - 9388	597
McLANE			B4H	24 - 7153	589	BM6A	24 - 2551	590
1013B	03 - 866	59	B4L	24 - 6932	591	BM6A	24 - 2504	591
1060	12 - 5052	212	B4LM	24 - 2505	591	BM6A	24 - 2543	589
1060	12 - 8761	232	B4LM	24 - 2530	593	BM6A	24 - 1295	594
1063	13 - 1262	285	B4LM	24 - 2555	590	BM6A	24 - 12542	598
1063-A	13 - 1263	285	B4LM	24 - 2544	589	BM6F	24 - 2547	589
2016-6	06 - 2996	98	B4LM	24 - 6595	589	BM6F	24 - 1289	594
2016-7	06 - 2995	98	B4LM	24 - 9385	597	BM7A	24 - 12549	598
2016-8	06 - 2994	98	B4LM	24 - 1294	594	BM7A	24 - 2510	591
2033	16 - 1248	424	B4LM	24 - 12544	598	BM7A	24 - 2500	594
2036	09 - 7950	131	B5HS	24 - 11304	594	BM7F	24 - 2503	595
2044	17 - 424	434	B6HS	24 - 7150	591	BM7F	24 - 2512	591
2059-HD	16 - 1145	422	B6HS	24 - 2536	594	BMR4A	24 - 11649	597
2059-HD-10	16 - 2673	423	B6HS	24 - 7153	589	BMR4A	24 - 5854	595
4060	12 - 5053	212	B6L	24 - 2542	589	BMR6A	24 - 11650	597
7102	12 - 8780	232	B6L	24 - 2526	594	BMR6A	24 - 12554	598
N2 PARTS			B6S	24 - 2517	594	BMR6A	24 - 2537	595
621-2923	24 - 10994	597	B6S	24 - 2506	591	BMR7A	24 - 10326	595
621-4578	24 - 10988	597	B6S	24 - 5860	589	BP4ES	24 - 7868	591
621-4929	24 - 10991	597	B6S	24 - 12548	598	BP4HS	24 - 7231	589
621-6965	24 - 10995	597	B6S	24 - 2531	593	BP4HS	24 - 5858	595
621-7839	24 - 10992	597	B7HS	24 - 2550	590	BP5ES	24 - 2534	595
695-1121	08 - 10647	126	B7HS	24 - 7187	591	BP5ES	24 - 7311	590
695-1156	08 - 10651	126	B7HS	24 - 2516	594	BP5ES	24 - 12543	598
695-1161	08 - 10659	126	B8ES	24 - 11305	594	BP6ES	24 - 7230	590
695-1391	08 - 10649	126	B8HS	24 - 2552	594	BP6ES	24 - 2519	595
695-1506	08 - 10654	126				BP6ES	24 - 12547	598
						BPM4A	24 - 7149	591
							24 - 2518	595



O.E.M. REPLACEMENT CROSS REFERENCE

2014 CROSS REFERENCE

OEM #	Our #	Page #	OEM #	Our #	Page #	OEM #	Our #	Page #
NGK			NGK			NIPPONDENSO		
BPM6A	24 - 7148	591	BR7HS	24 - 11656	597	M22	24 - 7227	589
BPM6A	24 - 12546	598	BR8ES	24 - 7232	590	M22	24 - 7185	591
BPM6A	24 - 2548	590	BR8ES	24 - 2553	596	T16PR-U	24 - 7019	589
BPM6A	24 - 9993	593	BR9ES	24 - 2554	596	T16PR-U	24 - 7021	596
BPM6A	24 - 2501	595	C7HSA	24 - 12234	597	T20EPR-U	24 - 7222	589
BPM6F	24 - 6835	589	C8HSA	24 - 10370	596	T20EPR-U	24 - 6935	592
BPM6F	24 - 8496	591	CM6	24 - 12558	598	W14F-U	24 - 5855	594
BPM6Y	24 - 7893	595	CM6	24 - 11571	596	W14F-U	24 - 7153	589
BPM7A	24 - 9392	597	CMR-6A	24 - 12376	596	W14FP-L	24 - 5858	595
BPM7A	24 - 12545	598	CMR-7A	24 - 9593	596	W14FP-L	24 - 7231	589
BPM7A	24 - 8882	591	CMR4H	24 - 12064	596	W14FPR	24 - 7231	589
BPM7A	24 - 2513	591	CMR5H	24 - 10427	596	W14L	24 - 2542	589
BPM7A	24 - 2533	595	CMR6H	24 - 10187	596	W14L	24 - 6932	591
BPM7A	24 - 7191	589	CMR7H	24 - 10188	596	W14LM-U	24 - 2555	590
BPM7Y	24 - 11651	597	CMR7H-10	24 - 14415	596	W14LM-U	24 - 2505	591
BPM7Y	24 - 7892	595	CR5HSB	24 - 9405	596	W14LM-U	24 - 2530	593
BPM8Y	24 - 11652	597	CR6E	24 - 10995	597	W14LM-U	24 - 6595	589
BPM8Y	24 - 10020	595	CR7E	24 - 10988	597	W14LM-U	24 - 2544	589
BPMR-6A	24 - 11653	597	CR7HS	24 - 10993	597	W14M-U10	24 - 2532	593
BPMR-6A	24 - 10176	595	CS6	24 - 14636	592	W14M-U10	24 - 5859	589
BPMR4A	24 - 8358	595	CS6	24 - 12312	596	W14M-U10	24 - 2507	591
BPMR6A	24 - 7190	591	CS6 S100	24 - 9872	594	W16EP-U	24 - 2534	595
BPMR6F	24 - 10950	595	DCPR7E	24 - 14492	591	W16EP-U	24 - 7868	591
BPMR7A	24 - 12552	598	DCPR8E	24 - 10998	597	W16EPR-U	24 - 2538	595
BPMR7A	24 - 11654	597	DPR8EA-9	24 - 10991	597	W16EPR-U	24 - 7189	592
BPMR7A	24 - 8883	591	DR7EA	24 - 10992	597	W16EPR-U	24 - 7220	589
BPMR7A	24 - 5850	595	DR7EB	24 - 13039	596	W16EX-U	24 - 7868	591
BPMR7Y	24 - 13373	595	DR7EB	24 - 14492	591	W16EX-U	24 - 7311	590
BPMR8Y	24 - 13362	595	DR8EA	24 - 10990	597	W20EP-U	24 - 7149	591
BPR2ES	24 - 11655	597	DR8ESL	24 - 10994	597	W20EPR-U	24 - 2539	595
BPR4ES	24 - 9873	595	FR4	24 - 9730	592	W20ETR-S	24 - 7230	590
BPR4ES	24 - 12555	598	FR5	24 - 9871	596	W20ETR-S	24 - 7188	592
BPR4HS	24 - 10997	597	LB05EP	24 - 8799	599	W20FS-U	24 - 2536	594
BPR5ES	24 - 12553	598	TR4	24 - 9493	592	W20FS-U	24 - 7150	591
BPR5ES	24 - 2538	595	TR5	24 - 6935	592	W20FS-U	24 - 7153	589
BPR5ES	24 - 7189	592	TR5	24 - 7222	589	W20M-U	24 - 2504	591
BPR5ES	24 - 7220	589	TR5	24 - 5851	596	W20M-U	24 - 2551	590
BPR6ES	24 - 2539	595	UJ81J	24 - 2516	594	W20M-U	24 - 2543	589
BPR6ES	24 - 7188	592	UL4J	24 - 2516	594	W20M-U	24 - 2529	593
BPR6ES	24 - 12550	598	UL81C	24 - 2516	594	W20MP-U	24 - 7148	591
BPR6HS	24 - 12984	595	UR4	24 - 8073	592	W20MP-U	24 - 2548	590
BPR7HS	24 - 10989	597	UR4	24 - 7019	589	W20MPR	24 - 7190	591
BR2LM	24 - 9536	593	UR4	24 - 5857	596	W20MR-U	24 - 2537	595
BR2LM	24 - 6934	592	XR4	24 - 8054	592	W20S	24 - 2531	593
BR2LM	24 - 10234	596	XR5	24 - 7021	596	W20S	24 - 5860	589
BR4HS	24 - 5852	595	ZFR4F-11	24 - 10898	596	W20S	24 - 2506	591
BR4HS	24 - 7231	589	ZGR5A	24 - 11078	596	W22FS	24 - 2550	590
BR4LM	24 - 14560	596				W22M-U	24 - 2510	591
BR6ES	24 - 8497	592	NIPPONDENSO			W22MFV	24 - 5850	595
BR6ES	24 - 8963	589	L14-U	24 - 7227	589	W22MP-U	24 - 7191	589
BR6S	24 - 8571	592	L14-U	24 - 7422	591	W22MP-U	24 - 2513	591
BR6S	24 - 10707	596	M17	24 - 5856	594	W22MP-U	24 - 2533	595
BR7HS	24 - 10999	596	M22	24 - 2535	594	W24ESR-U	24 - 7232	590

O.E.M. REPLACEMENT CROSS REFERENCE



CROSS REFERENCE 2014

OEM #	Our #	Page #	OEM #	Our #	Page #	OEM #	Our #	Page #
NIPPONDENSO			ONAN			PILOTE		
W24ESR-U	24 - 2553	596	191-2227	31 - 12802	1080	31461	15 - 10195	395
W24FS-U	24 - 7186	591	191-2277	31 - 12802	1080	43160	15 - 10199	381
W24FS-U	24 - 7187	591				43485	15 - 10198	381
W24FS-U	24 - 2552	594	OTASCO			72231	15 - 10201	381
W27ESR	24 - 2554	596	754-462	12 - 5095	212	72258	15 - 10202	381
W9-U	24 - 7224	589	758104	12 - 5065	212	72292	15 - 10204	395
W9PR-U	24 - 8054	592				72972	15 - 10203	395
WA20M-U	24 - 2547	589	PARAMOUNT			PIONEER/PARTNER		
WA22M-U	24 - 2512	591	534205300	16 - 6762	421	150A	39 - 4795	48
OGURA			PARKER			295108	37 - 3013	1181
GT25MC04	10 - 12977	167	66-238-A-1100	15 - 8590	394	502-295-126	37 - 3046	1180
MAGTEXM14	10 - 12977	167				5043527-05	37 - 3048	1180
OKLAHOMA TIRE & SUPP			PARTNER			506 09 92-12	39 - 9640	1210
175-145	12 - 7614	216	5032890-17	39 - 9921	1210	506 22 42-01	39 - 9790	489
754-1065	12 - 5058	212	506-23-18-02	39 - 12497	489	PLYMOUTH		
754-925	12 - 5064	212	506-29 42-71	39 - 12628	1209	16368	12 - 7483	215
			506226301	39 - 13136	489	5042	12 - 5088	212
			506268701	39 - 13138	489	POLARIS		
OLYMPYK			506367201	39 - 12887	488	3089463	19 - 10883	483
60-00132	37 - 3026	633	544-18-16-02	39 - 12887	488	POLORON		
			999810	39 - 9954	489	102014	12 - 7468	215
			E-506-53-35-01	17 - 50226	430	115462	12 - 5096	212
ONAN			E-506-53-41-01	17 - 50225	430	965273	13 - 763	266
0140-9071	19 - 11842	459	E-506-67-54-01	17 - 50227	436	966500	12 - 7474	215
0142-0553	22 - 10946	536	E-515-13-10-64	17 - 50223	430	966503	12 - 7496	215
122-0185	19 - 6680	484	E-516-84-20-00	17 - 50224	430	966505	12 - 5172	213
122-0323	19 - 6678	483	K1250	39 - 12628	1209	POULAN/WEEDEATER		
122-0445	19 - 6678	483	K750	39 - 12885	1209	015024	02 - 3250	48
122-0645	19 - 6677	483	PEERLESS			015037	02 - 3251	48
122-0800	19 - 6678	483	700-070A	42 - 14176	1232	015062	02 - 3252	48
140-0495	19 - 2791	476	700-079	42 - 14177	1232	015064	02 - 3260	48
140-1188	19 - 1385	474	700-083	42 - 14178	1232	015074	02 - 3253	48
140-1216	19 - 1388	472	700-134	42 - 14395	1232	015122	02 - 3254	48
140-1228	19 - 2790	476	771834	42 - 14184	1231	015163	02 - 3255	48
140-1496	19 - 7050	454	771841	42 - 14180	1233	015201	02 - 3256	48
140-188	19 - 1385	474	771842	42 - 14179	1233	015229	02 - 3257	48
140-1891	19 - 2792	476	771846	42 - 14182	1233	015329	02 - 3258	48
140-1911	19 - 6583	476	776456	42 - 14183	1233	015385	02 - 3259	48
140-1912	19 - 7209	476	776468	42 - 14181	1233	015445	02 - 3261	48
140-2199	19 - 6585	477	786177	42 - 14185	1231	015653	02 - 3260	48
140-2255	19 - 7420	477	PENNEY'S			14347	20 - 6884	517
140-2331	19 - 6584	476	4-40910	12 - 5068	212	15385	39 - 8400	1214
140-2335	19 - 7419	476	PENNSYLVANIA			15819	39 - 8612	48
140-2379	19 - 2792	476	74238	12 - 5077	212	19045	38 - 1542	1194
140-2522	19 - 2790	476	PHELON			193235	05 - 13380	70
140-2523	19 - 6583	476	FG-6240	31 - 1884	1078	23064	39 - 8400	1214
140-2535	19 - 6584	476				23364	38 - 1400	48
140-2588	19 - 6584	476				24371	27 - 4300	490
140-2597	19 - 6585	477						
140-2628	19 - 2790	476						
140-3010	19 - 10708	476						
140P842	19 - 8279	474						
191-1748	31 - 12802	1080						



O.E.M. REPLACEMENT CROSS REFERENCE

2014 CROSS REFERENCE

OEM #	Our #	Page #	OEM #	Our #	Page #	OEM #	Our #	Page #
POULAN/WEEDEATER			POULAN/WEEDEATER			POWER TRIM		
24548	39 - 3112	490	530-071835	20 - 12642	509	134	12 - 5061	212
2501	39 - 1566	1215	530-091543	37 - 3003	633	237	12 - 5061	212
25DA	39 - 1568	490	530-091868	37 - 3010	633	238	12 - 5062	212
25DA	39 - 1568	490	530-091878	38 - 1399	48	304	16 - 9335	424
26112	25 - 4968	604	530-091886	39 - 6985	485	307	13 - 3316	285
26791	25 - 4969	604	530-091886	27 - 6966	485	332	06 - 2997	98
3000	27 - 7411	75	530-092067	27 - 6968	659	334	13 - 1262	285
34032	38 - 1399	48	530-093216	27 - 6882	659	334-1	13 - 1262	285
42067	26 - 2436	634	530-093898	27 - 6881	659	334-1	13 - 1263	285
520-023369	39 - 1568	490	530-094676	27 - 8567	77	339	12 - 5061	212
530-0015024	02 - 3250	48	530-095086	16 - 6788	422	339	12 - 4999	240
530-0015037	02 - 3251	48	530-095646	38 - 11813	498	4L275	12 - 4999	240
530-0015062	02 - 3252	48	530-340007	27 - 6968	659			
530-0015064	02 - 3260	48	530-402-864	16 - 9886	422	PRO		
530-0015074	02 - 3253	48	530026119	38 - 7259	519	7520026	12 - 5074	212
530-0015122	02 - 3254	48	530036141	39 - 12486	490	7520031	12 - 5073	212
530-0015163	02 - 3255	48	530037793	39 - 13119	490	7522001	12 - 5080	212
530-0015201	02 - 3256	48	530039218	31 - 14460	1077	7523015	12 - 5064	212
530-0015229	02 - 3257	48	530069651	22 - 11151	549	7523020	12 - 5013	211
530-0015329	02 - 3258	48	530071332	22 - 11151	549	7524026	12 - 5076	212
530-0015385	02 - 3259	48	530071637	22 - 11972	549	7524058	12 - 5079	212
530-010729	20 - 6884	517	530095643	38 - 11813	498	7529058	12 - 5078	212
530-014347	20 - 6884	517	530340007	27 - 6968	659			
530-014362	38 - 11813	498	530403094	02 - 3260	48	PRO HARDWARE		
530-015445	02 - 3261	48	532193235	05 - 13380	70	754-100	12 - 5051	212
530-015819	39 - 8612	48	534-235901	02 - 3260	48	754-153	12 - 6906	233
530-019045	38 - 1542	1194	539-109243	12 - 12399	240	754-338	12 - 5021	211
530-019156	38 - 8365	1194	539-110832	12 - 12401	240			
530-023064	39 - 8400	1214	539-112057	10 - 11590	185	RAZOR MAX		
530-023166	38 - 7259	519	545008009	26 - 2436	634	JM775	27 - 12580	426
530-023364	38 - 1400	48	545057701	39 - 12486	490	JM777	27 - 12581	426
530-023369	39 - 1568	490	6975-00	37 - 3003	633			
530-023783	25 - 4969	604	701557	16 - 2662	421	RECO SALES		
530-023791	39 - 1567	490	701568	27 - 4300	490	754-128	12 - 6906	233
530-023877	20 - 13448	509	701583	20 - 6884	517			
530-024371	27 - 4300	490	710567	20 - 6884	517			
530-024451	25 - 7307	604	91543	37 - 3003	633	REDMAX		
530-024548	39 - 3112	490	91868	37 - 3010	633	1148-81001	22 - 11147	549
530-02501	39 - 1566	1215	91886	39 - 6985	485	1260-84160	27 - 7208	490
530-026112	25 - 4968	604	92343	16 - 2662	421	3238-14510	27 - 9049	75
530-026119	38 - 7259	519	93575	27 - 6927	77	4810-75100	26 - 14656	624
530-026791	25 - 4969	604	93831	27 - 6928	77	502843101	26 - 13528	624
530-034032	38 - 1399	48	93935	27 - 6926	77	521342701	26 - 14656	624
530-034032W	38 - 1399	48	952701699	16 - 9886	422	BC00088	27 - 14368	641
530-035497	20 - 9948	51	PP12012	12 - 9697	223	BC00088	27 - 14369	641
530-038874	20 - 12440	509	PP13011	12 - 11034	224	PT104	27 - 14368	641
530-042067	26 - 2436	634	PP21008	12 - 12286	225	PT106	27 - 14369	641
530-069195	27 - 6883	660	PP24001	15 - 12240	331	T4012-82320	27 - 10311	490
530-069232	25 - 4969	604	PP88000	12 - 8781	223	T401282310	27 - 9909	490
530-069286	02 - 3257	48	V015205	02 - 3261	48	T4030-75100	26 - 13528	624
530-069313	39 - 12748	1216						
530-069957	39 - 11860	1206	POWER KING			REO		
530-071259	39 - 11860	1206	03-7301	31 - 7675	1064	8809	12 - 5008	211
						MW-1151	12 - 5050	212

O.E.M. REPLACEMENT CROSS REFERENCE



CROSS REFERENCE 2014

OEM #	Our #	Page #	OEM #	Our #	Page #	OEM #	Our #	Page #
ROBIN			RYAN/RYOBI			SCAG		
106-32704-07	19 - 7036	482	613223	16 - 6477	421	04020-09	10 - 11565	178
20A-32636-00	19 - 14648	477	613223	16 - 6107	421	04021-07	10 - 11076	178
226-32610-07	19 - 7040	482	682030	26 - 8289	610	04066-01	10 - 7181	162
252-32602-07	19 - 14648	477	682039	27 - 10206	658	04070-01	10 - 8689	162
270-50115-08	26 - 13051	633	683856	26 - 8288	610	04070-02	10 - 8690	162
274-32603-07	19 - 14464	477	683974	20 - 11510	51	22383	13 - 10774	290
277-32606-18	19 - 14648	477	7843	22 - 11157	549	424367	10 - 12812	162
277-32611-07	19 - 14648	477	791-180852B	24 - 12650	592	43001-02	10 - 5999	198
279-32607-07	19 - 14431	477	GA1054	12 - 5173	213	43001-02	19 - 8631	484
279-32607-17	19 - 14431	477	S & H MANUFACTURING			43022	09 - 7262	142
EY2263261007	19 - 7040	482	120B	12 - 5083	212	43025	10 - 8985	162
ROL-AIR			303	12 - 5068	212	43037-01	10 - 8190	175
431	19 - 1385	474	549248	12 - 7483	215	43038	10 - 1191	175
ROOF			SABO			43278	10 - 8372	175
2177	15 - 1053	395	450-203-000	15 - 11316	396	43278	10 - 1191	175
ROTO-HOE			527-220-000	15 - 11317	396	43430	09 - 9613	143
101	12 - 5092	212	SANDVIK/WINDSOR			43581	09 - 10017	142
102	12 - 5094	212	12MC50SSR	35 - 10610	1157	43583	09 - 9992	142
1078	12 - 5076	212	12MXL50SSR	35 - 10606	1159	43584	09 - 10064	142
1079	12 - 5070	212	12PKU50SSR	35 - 10597	1157	43584	10 - 8372	175
108	12 - 5094	212	12STA50SLR	35 - 10575	1165	43592	10 - 1191	175
1080	12 - 5084	212	14MC50SSR	35 - 10604	1157	43592	10 - 7125	157
1081	12 - 5079	212	14MXL50SSR	35 - 10605	1159	45006	10 - 5722	198
1542A	12 - 5085	212	14PKU50SSR	35 - 10596	1157	46020	10 - 5722	198
1543	12 - 5080	212	164050SPYA	35 - 10574	1171	46020	10 - 9153	198
1569	29 - 8610	667	16CJL58SPYJ	35 - 10599	1157	461090	10 - 11562	159
1570	29 - 8611	667	16HL50SPYA	35 - 10603	1157	461395	10 - 12977	167
2430	12 - 5076	212	16HS58SPNA	35 - 10612	1161	461663	10 - 9153	198
2540	12 - 5087	212	16MC50SSR	35 - 10601	1157	461663	10 - 5722	198
4059	12 - 5092	212	16MXL50SSR	35 - 10602	1159	461716	10 - 12977	167
4075	12 - 5068	212	16PKU50SSR	35 - 10595	1157	46400	10 - 5722	198
4076	12 - 5098	212	16TMX50SPYA	35 - 10609	1165	46400	10 - 9153	198
5065	12 - 5082	212	18HS58SPNA	35 - 10611	1161	46513	42 - 8250	1231
5065C	12 - 5076	212	18PKU50SSR	35 - 10613	1157	46631	10 - 9153	198
5065D	12 - 5078	212	SARLO			48006-01	08 - 11522	110
804	12 - 5093	212	1511	15 - 6230	396	48006-01	08 - 3276	112
A53	12 - 5088	212	1511-21	15 - 6230	396	48006-06	09 - 5812	137
ROTOTILLER			1512	15 - 6228	396	48006-07	09 - 5812	137
28151	12 - 5067	212	1513	15 - 6231	396	48017	31 - 2922	1062
RYAN/RYOBI			1513-24	15 - 6231	396	48017-02	31 - 2922	1062
153066	27 - 7235	660	1516	15 - 6232	396	48021	31 - 8911	1059
180000	20 - 9316	517	1516-26	15 - 6232	396	48045	03 - 9695	72
180350	27 - 8410	491	1517	15 - 6229	396	48051	10 - 6974	171
181168	20 - 10006	509	3110	42 - 14395	1232	48056	20 - 1347	34
181558	20 - 10006	509	SCAG			48057-02	20 - 6000	46
181767	27 - 10468	658	04001-134	10 - 11040	180	48059-01	20 - 5905	43
181801	20 - 10006	509	04001-167	10 - 11041	180	48062	13 - 10412	286
610675	23 - 7168	580	04001-41	10 - 8343	179	48065	13 - 10413	287
						48068	13 - 5714	264
						48080	12 - 7482	215
						48081	12 - 7625	216
						48083	12 - 7633	216
						48085	12 - 7481	215
						48087	12 - 7789	254



O.E.M. REPLACEMENT CROSS REFERENCE

OEM #	Our #	Page #	OEM #	Our #	Page #	OEM #	Our #	Page #
SCAG			SCAG			SCAG		
48087	12 - 7598	216	481706	15 - 3403	347	482217	13 - 10160	278
48089	12 - 7790	254	481707	15 - 6294	323	482235	15 - 9229	323
48089	12 - 7634	216	481707	15 - 3404	347	482237	15 - 9230	324
48100-01	09 - 8305	147	481708	15 - 3434	362	48226	42 - 8250	1231
48100-01	09 - 5713	147	481709	15 - 6026	334	482281	12 - 10048	256
48100-02	09 - 8476	148	481709	15 - 9883	325	482295	07 - 12245	107
48100-05	10 - 8304	175	481710	15 - 6009	379	482298	13 - 10769	288
481001	12 - 10407	255	481711	15 - 6294	323	482306	13 - 9844	286
48101	09 - 7178	134	481711	15 - 3442	380	482349	23 - 12112	585
48101-02	09 - 7178	134	481712	15 - 10930	398	482352	23 - 12259	585
481022	09 - 13092	136	481749	12 - 10914	255	482413	03 - 10748	64
481024	10 - 13524	198	481769	09 - 5812	137	482416	13 - 11657	286
481048	13 - 8587	285	481770	09 - 5812	137	48244	12 - 7623	216
481048	13 - 13614	287	481774	08 - 908	119	482461	15 - 3403	347
481048	13 - 7983	263	48181	13 - 10414	288	482462	15 - 3404	347
48108	15 - 3404	347	48184	15 - 6009	379	482466	15 - 6009	379
48108	15 - 6294	323	481846	09 - 9463	136	482467	15 - 6294	323
48109	15 - 6008	380	48184HL	15 - 6009	379	482467	15 - 3442	380
48110	15 - 3403	347	48185	15 - 3442	380	482497	20 - 12567	515
48111	15 - 3434	362	48185	15 - 6294	323	482503	08 - 10288	110
48112	15 - 6026	334	481858	09 - 6534	135	482504	08 - 10286	110
48112	15 - 9883	325	481860	08 - 8573	113	482504	08 - 10711	112
48127	13 - 5989	290	481884	13 - 10774	290	482529	12 - 10365	256
48127	13 - 11228	286	48192	08 - 8573	113	482530	12 - 12371	256
48127-01	13 - 5988	290	48192-01	08 - 8573	113	482531	12 - 10319	256
48127-01	13 - 5989	290	48192-02	08 - 8573	113	482547	20 - 9650	515
48141	13 - 5989	290	48193-01	09 - 6534	135	482621	09 - 813	133
48141	13 - 6532	290	481962	13 - 9771	276	482622	10 - 10013	176
481460	12 - 10317	255	48197	13 - 7786	287	482641	12 - 10318	256
481461	12 - 10043	255	48198	13 - 5712	264	482645	13 - 7124	290
481498	12 - 10409	255	481980	12 - 12233	255	482649	13 - 11208	288
481499	12 - 10410	255	48199	13 - 7124	290	48265	12 - 7608	216
481530/461395	10 - 12977	167	48200	13 - 9397	292	482652	12 - 12867	258
481536	13 - 10775	290	482009	12 - 10045	256	482652	12 - 12824	256
481544	03 - 11521	64	48201	13 - 7983	263	482655	13 - 13615	287
481551	08 - 9605	112	48202A	12 - 5235	254	48269	13 - 6572	264
481557	12 - 10411	255	48203	12 - 7791	254	48269	13 - 5712	264
481558	12 - 10044	255	48204	12 - 7627	216	482693	15 - 9230	324
481559	09 - 10665	148	48204	12 - 5236	254	482716	12 - 10319	256
481580	42 - 14176	1232	48206	03 - 6992	64	482724	15 - 9229	323
481581	42 - 9579	1231	482062	13 - 10417	287	482744	13 - 5989	290
481582	42 - 14179	1233	48207	12 - 7631	216	482744	13 - 5988	290
481632	07 - 10225	107	482085	13 - 10773	290	482744	13 - 11228	286
481635	31 - 9657	1064	48209	05 - 9757	91	482745	13 - 11209	289
481635	31 - 11470	1065	48210	05 - 7787	91	482745	13 - 9601	288
481637	31 - 9660	1066	482129	15 - 6008	380	482747	13 - 9602	288
481638	31 - 9663	1066	482137	12 - 10046	256	482747	13 - 11211	289
481638	31 - 9663	1066	482138	12 - 10047	256	482748	13 - 11212	289
481657	09 - 814	134	482139	12 - 10048	256	482751	13 - 10764	287
481661	20 - 12566	515	482140	12 - 10049	256	482752	13 - 11213	289
481662	03 - 11640	64	482171	12 - 10050	256	482754	13 - 11214	289
481666	13 - 10768	288	482209	03 - 8766	57	482755	13 - 11215	289
481687	31 - 9656	1064	482212	20 - 11273	511	482783	13 - 11464	286

2014 CROSS REFERENCE

O.E.M. REPLACEMENT CROSS REFERENCE



CROSS REFERENCE 2014

OEM #	Our #	Page #	OEM #	Our #	Page #	OEM #	Our #	Page #
SCAG			SCAG			SENSATION		
482791	13 - 11216	289	483790	20 - 12566	515	083-106	06 - 2998	97
482794	10 - 11954	159	483792	20 - 9650	515	083-107	06 - 2999	98
48285	12 - 7601	216	48394	03 - 9169	64	123-001	15 - 1076	398
48286	12 - 7638	216	483957	31 - 13248	1065	SHINDAIWA		
482873	12 - 12248	256	483957	31 - 9656	1064	12318140630	20 - 9477	51
482876	12 - 12249	256	484057	08 - 14233	119	17500-23600	27 - 13599	646
482877	15 - 3403	347	484106	03 - 10748	64	17721544430	26 - 7930	610
482878	15 - 6294	323	484466	08 - 14556	119	20000-15131	27 - 9047	657
482878	15 - 3404	347	48462-01	19 - 8631	484	20000-51103	27 - 7928	659
482879	15 - 3434	362	48472	12 - 7487	215	20000-51104	27 - 7928	659
482882	15 - 9883	325	48473	13 - 9844	286	20000-51120	26 - 7927	610
482882	15 - 6026	334	48537	08 - 10016	113	20000-75120	26 - 2444	633
482961	15 - 9229	323	48553	12 - 12049	254	20000-75140	38 - 7925	1185
483049	08 - 10288	110	48586	13 - 10764	287	20000-81170	27 - 7926	491
483050	08 - 10286	110	48587	12 - 10402	255	20000-81701	27 - 5864	486
48307	08 - 3276	112	48609	31 - 14672	1062	20000-81740	27 - 8564	77
48307-02	08 - 908	119	48668	09 - 814	134	20000-83180	20 - 7932	517
483084	12 - 12067	256	48717	31 - 9664	1066	20000-85200	20 - 7933	519
483157	12 - 12067	256	48752	12 - 10404	255	2000085201	20 - 7932	517
483162	31 - 9656	1064	48753	13 - 9601	288	20011-85401	27 - 8534	498
483165	12 - 12085	255	48758	19 - 9380	484	20011-85451	27 - 8535	519
483172	12 - 12068	256	48780	03 - 9693	64	20016-81020	22 - 11166	549
483173	13 - 12930	286	48787	31 - 7922	1064	20016-81021	22 - 11166	549
483208	13 - 13614	287	48792	13 - 10418	287	20018-81750	27 - 12024	492
483208	13 - 8587	285	48798	31 - 7804	1063	2001851100	27 - 7928	659
483208	13 - 7983	263	48799	12 - 10403	255	2001851101	27 - 7928	659
483210	13 - 11464	286	48828	05 - 9694	72	20024-81777	27 - 8658	491
483211	13 - 5712	264	48912	12 - 8714	255	20024-81800	27 - 7929	659
483213	13 - 9844	286	48924	13 - 11228	286	20035-5100	27 - 7929	659
483214	13 - 13615	287	48924	13 - 5988	290	20035-5110	27 - 7929	659
483215	13 - 11464	286	48924	13 - 5989	290	20035-51101	27 - 7929	659
483215	13 - 11657	286	48926	13 - 9600	288	20036-81670	20 - 9477	51
483216	13 - 10417	287	48967	13 - 9602	288	20036-81712	27 - 8519	491
483239	12 - 12069	256	48992	13 - 9758	290	20036-81740	27 - 7926	491
483240	12 - 12070	257	48996	12 - 10405	255	20040-81700	20 - 7931	517
483241	12 - 12071	257	9277	08 - 10288	110	20040-85202	20 - 7931	517
483242	12 - 12072	257	9278	08 - 10286	110	2004085203	27 - 7679	491
483243	12 - 12073	257	A48108	15 - 3404	347	22100-85400	27 - 8528	492
483278	31 - 14427	1061	A48109	15 - 6008	380	22100-85411	27 - 9272	661
483303	09 - 3217	134	A48110	15 - 3403	347	28820-07340	27 - 13600	646
483314	12 - 13257	257	A48110	15 - 6300	322	28820-07370	27 - 13603	646
483317	15 - 9229	323	A48111	15 - 6299	324	28820-07380	27 - 13601	646
483318	15 - 9230	324	A48111	15 - 3434	362	28820-07390	27 - 13602	646
483325	12 - 12718	257	A48184	15 - 6300	322	62074-83110	27 - 12507	77
483326	12 - 12719	257	A48184HL	15 - 6009	379	62074-83111	26 - 13528	624
483415	13 - 12712	286	A48185	15 - 3442	380	68900-82120	27 - 11641	492
483466	09 - 7162	134	HG52114	19 - 12374	484	68900-82320	27 - 11642	492
483466	09 - 10303	135	SCHWEISS			70030-75120	26 - 7930	610
483472	31 - 12839	1061	230010	12 - 8767	257	70036-81002	22 - 11168	549
483518	12 - 7638	216	230018	12 - 6845	235			
483659	08 - 12879	122						
483741	12 - 14593	257						
483788	20 - 12567	515						



O.E.M. REPLACEMENT CROSS REFERENCE

2014 CROSS REFERENCE

OEM #	Our #	Page #	OEM #	Our #	Page #	OEM #	Our #	Page #
SHINDAIWA			SIMPLICITY/ALLIS CHA			SIMPLICITY/ALLIS CHA		
70036-83110	27 - 8563	77	101002	12 - 7507	215	118494	12 - 7439	214
70064-82210	27 - 8713	491	101007	12 - 7506	215	119035	12 - 7519	215
70105-83100	27 - 12509	76	101136	12 - 7507	215	119037	12 - 7521	215
70140-51102	27 - 7928	659	101137	12 - 7532	215	119044	12 - 7516	215
70140-51102	27 - 7929	659	105066	12 - 7603	216	121078	12 - 7478	215
7014051100	27 - 7929	659	105067	12 - 7596	216	121216	12 - 7481	215
7014051101	27 - 7928	659	105068	12 - 7501	215	121228	12 - 7480	215
72910-14320	27 - 7905	75	105115	12 - 7504	215	122039	12 - 7437	214
78890-11330	27 - 13597	646	105122	12 - 7601	216	122046	12 - 7481	215
78890-11340	27 - 13598	646	105217	12 - 7597	216	122060	12 - 7441	214
78890-18001	27 - 13375	646	105280	12 - 7609	216	122069	12 - 7496	215
78890-21001	27 - 13377	646	105287	12 - 7633	216	122120	12 - 7439	214
80401	27 - 14368	641	105340	12 - 7641	216	122146	12 - 7481	215
80403	27 - 14369	641	105372	12 - 7533	215	124025	12 - 7473	215
A021002190	22 - 11166	549	106016	12 - 7489	215	125068	12 - 7475	215
A037000000	27 - 8534	498	106123	12 - 7469	215	147883	12 - 7477	215
A051001520	26 - 13528	624	106390	12 - 7479	215	152017	12 - 7590	216
A056000260	27 - 7929	659	106723	12 - 7522	215	15307	12 - 7478	215
A056000260	27 - 7928	659	106769	12 - 7499	215	153091	12 - 7487	215
A056000500	27 - 7928	659	108012	12 - 7481	215	154307	12 - 7478	215
A226000530	27 - 11641	492	108059	12 - 7480	215	154393	09 - 813	133
A226000550	27 - 11641	492	108099	12 - 7487	215	154486	09 - 813	133
A226000560	27 - 11642	492	108151	12 - 7506	215	154534	13 - 721	36
A226000590	27 - 8713	491	108175	12 - 7499	215	156120	12 - 7506	215
A226000650	27 - 7679	491	108202	09 - 484	133	156124	13 - 721	36
A226000670	27 - 5864	486	108209	12 - 7525	215	156231	12 - 7485	215
A226000740	27 - 12024	492	108248	12 - 7491	215	157230	12 - 5005	211
A369000030	27 - 8529	498	108297	15 - 1116	399	157524	12 - 7444	214
A504000120	26 - 2444	633	108300	12 - 7485	215	157683	12 - 7472	215
A506000250	26 - 7927	610	108386	13 - 723	36	158389	12 - 7472	215
A506000330	26 - 7930	610	108389	12 - 7542	215	158573	12 - 7474	215
P004003390	38 - 7925	1185	108407	12 - 7490	215	1601238	12 - 7439	214
P021017770	20 - 7933	519	108450	12 - 7528	215	1601405	12 - 7483	215
P021034400	27 - 8658	491	108458	12 - 7488	215	1601405SM	12 - 7483	215
V043000420	27 - 12509	76	108495	12 - 7517	215	1601520	12 - 7513	215
V104001650	27 - 9047	657	108501	15 - 1117	399	1601524	12 - 7521	215
V430002820	27 - 12507	77	108505	12 - 7513	215	1601672	12 - 7504	215
V430003400	27 - 8563	77	108505	12 - 5103	212	1601672SM	12 - 7504	215
V450000871	27 - 13599	646	108508	12 - 5111	212	1601695	12 - 7486	215
V470001110	27 - 8535	519	108508	12 - 7521	215	1602157	12 - 7516	215
V494000280	27 - 13601	646	108732	12 - 7438	214	1602969	12 - 7491	215
X472000011	27 - 13598	646	108854	12 - 7488	215	1603075	12 - 7535	215
X472000012	27 - 13598	646	109061	12 - 7471	215	1603075SM	12 - 7535	215
X472000030	27 - 13602	646	109067	12 - 7476	215	1603077	12 - 7525	215
X472000031	27 - 13602	646	110003	12 - 7603	216	1604406	12 - 7526	215
X473000011	27 - 13597	646	117414	13 - 715	263	1604406SM	12 - 7526	215
X473000030	27 - 13603	646	118011	09 - 442	134	1606190	12 - 7525	215
X473000031	27 - 13603	646	118068	12 - 7477	215	1606261	12 - 7524	215
X475000050	27 - 13600	646	118116	12 - 7441	214	16069261	12 - 7524	215
X494000280	27 - 13601	646	118225	12 - 7470	215	1607051	12 - 7513	215
			118312	12 - 7477	215	1607323	12 - 7481	215
			118414	13 - 718	36	1607323	12 - 7443	214
			118488	12 - 7439	214	1607323SM	12 - 7481	215
SHIVERS								
E-6297	31 - 9659	1066						

O.E.M. REPLACEMENT CROSS REFERENCE



CROSS REFERENCE 2014

OEM #	Our #	Page #	OEM #	Our #	Page #	OEM #	Our #	Page #
SIMPLICITY/ALLIS CHA			SIMPLICITY/ALLIS CHA			SIMPLICITY/ALLIS CHA		
1607323SM	12 - 7443	214	1657044SM	12 - 7536	215	167031	12 - 7526	215
1607812	12 - 7525	215	1657589	15 - 2079	399	1670832	12 - 7522	215
1607812SM	12 - 7525	215	1657589A	15 - 2079	399	1671076	12 - 7541	215
1607813	12 - 7526	215	1657589AS	15 - 2079	399	1671076SM	12 - 7541	215
1607889	12 - 7512	215	1657589ASM	15 - 2079	399	1671565	15 - 2078	399
1607967	12 - 7495	215	1657806	12 - 5069	212	1671565A	15 - 2078	399
1607967SM	12 - 7495	215	1657806	12 - 7479	215	1671565AS	15 - 2078	399
1608954	12 - 7476	215	1657827	13 - 2175	263	1671565SM	15 - 2078	399
1608954SM	12 - 7476	215	166172	12 - 7490	215	1671788	12 - 7451	214
1608957	12 - 7492	215	1663009	12 - 7433	214	1671993	31 - 8943	1071
1608960	12 - 7480	215	1664457	12 - 7484	215	1672135	12 - 7523	215
1610191	13 - 721	36	1664457	12 - 7483	215	1672135SM	12 - 7523	215
1610577	12 - 7499	215	1664457	12 - 5074	212	1672732	12 - 7436	214
1610578	12 - 7468	215	1664457SM	12 - 7484	215	1672732SM	12 - 7436	214
16106261	12 - 7524	215	1664457SM	12 - 5074	212	1674308	12 - 7480	215
161098	12 - 7482	215	1664457SM	12 - 7483	215	1674308SM	12 - 7480	215
163011	12 - 7515	215	1664789	12 - 7532	215	1674312	12 - 7480	215
164146	12 - 7477	215	1664789SM	12 - 7532	215	1674312SM	12 - 7480	215
164273	12 - 7587	216	1664804SM	31 - 14672	1062	1674898	12 - 7595	216
165048	12 - 7528	215	1664946	12 - 7500	215	1674898SM	12 - 7595	216
1650502	12 - 7489	215	1664946SM	12 - 7500	215	1674899	12 - 7601	216
1650502SM	12 - 7489	215	1665024	12 - 7497	215	1674899SM	12 - 7601	216
1650954	19 - 6680	484	1665024SM	12 - 7497	215	1674920	12 - 7436	214
1650954SM	19 - 6680	484	1665450	12 - 7530	215	1675005	12 - 7483	215
1651201	12 - 7516	215	1665450SM	12 - 7530	215	1675704	12 - 7477	215
1652231	09 - 442	134	1665638	12 - 6874	240	1675704	12 - 7439	214
1652231SM	09 - 442	134	1665666	12 - 7622	216	1675704SM	12 - 7477	215
1654634	31 - 8910	1059	1665706	12 - 5072	212	1675704SM	12 - 7439	214
1654634SM	31 - 8910	1059	1665706	12 - 7482	215	16771993	31 - 10772	1071
1654930	20 - 7730	510	1665706SM	12 - 7482	215	1678354	12 - 7485	215
1654930SM	20 - 7730	510	1665706SM	12 - 5072	212	1678354SM	12 - 7485	215
1655069	12 - 7534	215	1666324	12 - 7512	215	1679717	12 - 7437	214
1655275	12 - 7528	215	1666324SM	12 - 7512	215	1679835	12 - 7522	215
1655704	12 - 7439	214	1666654	12 - 7437	214	168171	12 - 7453	214
1656143	15 - 2082	399	1666654SM	12 - 7437	214	1685149	13 - 2175	263
1656143	15 - 2082	399	1666655	12 - 7484	215	1685172	15 - 2078	399
1656143A	15 - 2082	399	1666655SM	12 - 7484	215	1685290	31 - 5933	1071
1656143A	15 - 2082	399	1666698	12 - 7533	215	16852980	31 - 10772	1071
1656143AS	15 - 2082	399	1666801	12 - 7523	215	1686734	31 - 9853	1060
1656143AS	15 - 2082	399	1666801SM	12 - 7523	215	1686882	10 - 9912	164
1656143ASM	15 - 2082	399	1667200	12 - 7477	215	1686882SM	10 - 9912	164
1656143ASM	15 - 2082	399	1667506	12 - 7482	215	1686981	31 - 8943	1071
1656144	15 - 2083	399	1668065	12 - 7512	215	1686981SM	31 - 8943	1071
1656144A	15 - 2083	399	1668477	13 - 720	36	16907967	12 - 5085	212
1656144AS	15 - 2083	399	1668477SM	13 - 720	36	1700059	12 - 7507	215
1656144ASM	15 - 2083	399	1668487	07 - 13000	107	1700059SM	12 - 7507	215
1656147	15 - 2081	399	1668487SM	07 - 13000	107	1700184	07 - 6916	106
1656147A	15 - 2081	399	1668513	07 - 12999	107	1700184SM	07 - 6916	106
1656147AS	15 - 2081	399	1668513SM	07 - 12999	107	1700415	12 - 7437	214
1656147ASM	15 - 2081	399	1669394	12 - 7595	216	1700415SM	12 - 7437	214
1656960	12 - 7527	215	1669394SM	12 - 7595	216	1700581	12 - 7495	215
1656960SM	12 - 7527	215	1669937	12 - 7599	216	1700581SM	12 - 7495	215
1657044	12 - 7536	215	1669937SM	12 - 7599	216	1700751	31 - 5933	1071



O.E.M. REPLACEMENT CROSS REFERENCE

2014 CROSS REFERENCE

OEM #	Our #	Page #	OEM #	Our #	Page #	OEM #	Our #	Page #
SIMPLICITY/ALLIS CHA			SIMPLICITY/ALLIS CHA			SIMPLICITY/ALLIS CHA		
1700751	31 - 8943	1071	1714772	31 - 9656	1064	174365	12 - 7600	216
1700751	31 - 10772	1071	1716332	31 - 9656	1064	174486	12 - 7594	216
170164	12 - 7622	216	1716606	41 - 5513	1223	174687	12 - 7516	215
170164	12 - 7520	215	1716606SM	41 - 5513	1223	174731	12 - 7496	215
1702496	12 - 7481	215	1716695A	15 - 10096	399	174883	12 - 7477	215
1702496SM	12 - 7481	215	1716695ASM	15 - 10096	399	174911	12 - 5077	212
1703466	12 - 6874	240	1716696A	15 - 10093	399	174911	12 - 7487	215
1703466SM	12 - 6874	240	1716696ASM	15 - 10093	399	1751423	12 - 7532	215
1703816	10 - 12227	165	1716854	12 - 7533	215	1751423YP	12 - 7532	215
1703816SM	10 - 12227	165	1716854SM	12 - 7533	215	175361	12 - 7472	215
1703836	12 - 7534	215	1717050	31 - 9659	1066	176393	12 - 7442	214
1703836SM	12 - 7534	215	1717050SM	31 - 9659	1066	176439	12 - 7517	215
1703886	12 - 7534	215	1717163	31 - 11219	1069	176917	12 - 7480	215
1704100	15 - 10093	399	1717163SM	31 - 11219	1069	177126	12 - 7522	215
1704100AS	15 - 10093	399	1717393	12 - 7479	215	177452	12 - 7505	215
1704100SM	15 - 10093	399	1717393SM	12 - 7479	215	177945	12 - 7513	215
1704101	15 - 10096	399	1717397	12 - 12708	228	2025236	12 - 7601	216
1704101A	15 - 10096	399	1717397SM	12 - 12708	228	2025309	12 - 7478	215
1704101AS	15 - 10096	399	1718306	31 - 9654	1063	2025341	12 - 7487	215
1704379	31 - 9663	1066	1719746	12 - 7516	215	2025364	12 - 7525	215
1704379SM	31 - 9663	1066	1719746SM	12 - 7516	215	2025436	12 - 7469	215
1704856	15 - 10095	399	1719819	12 - 7525	215	2025461	12 - 7441	214
1704856A	15 - 10095	399	1719819SM	12 - 7525	215	2025463	12 - 7496	215
1704856AS	15 - 10095	399	1719911	12 - 9900	235	2025492	12 - 7590	216
1704856ASM	15 - 10095	399	1719911SM	12 - 9900	235	2025641	12 - 7587	216
1704856BZ	15 - 10095	399	172066	12 - 7472	215	2025663	12 - 7478	215
170771	12 - 7441	214	1721532	12 - 7526	215	2025712	12 - 7594	216
1707740	12 - 7512	215	1721532SM	12 - 7526	215	2025879	12 - 7506	215
1707740SM	12 - 7512	215	1721533	12 - 7499	215	2025893	12 - 7527	215
1708207	31 - 9658	1066	1721533SM	12 - 7499	215	2026066	12 - 7443	214
1708207SM	31 - 9658	1066	1722039	12 - 7515	215	2026081	12 - 7479	215
1708229	15 - 10094	399	1722039SM	12 - 7515	215	2026266	12 - 7481	215
1708229AS	15 - 10094	399	1722887	31 - 9656	1064	2026268	12 - 7482	215
1708536	10 - 9912	164	1722887SM	31 - 9656	1064	2026270	12 - 7480	215
170921	12 - 7467	215	1723391	12 - 7525	215	2026320	13 - 2183	263
171001	12 - 7509	215	1723391SM	12 - 7525	215	2026324	12 - 7534	215
171348	31 - 9656	1064	172420	12 - 7536	215	2026378	12 - 5005	211
1713515	12 - 7521	215	1726357ASM	15 - 2078	399	2026499	12 - 7499	215
1713515	12 - 5111	212	1726453A	15 - 10094	399	2026574	12 - 7506	215
1713515SM	12 - 7521	215	1726453BZ	15 - 10094	399	2026869	12 - 7444	214
1713515SM	12 - 5111	212	1726453BZYP	15 - 10094	399	2027102	12 - 7504	215
1713549	12 - 5103	212	1726471SM	12 - 7516	215	2027114	12 - 7528	215
1713549	12 - 7513	215	1727773SM	12 - 7513	215	2027121	12 - 7488	215
1713549SM	12 - 7513	215	1727773SM	12 - 5103	212	2027134	12 - 7513	215
1713549SM	12 - 5103	212	1727774A	15 - 10093	399	2027145	12 - 7507	215
1713845	31 - 9654	1063	1727774BMA	15 - 10093	399	2027168	12 - 7477	215
171439	19 - 6680	484	1727774SM	15 - 10093	399	2027197	12 - 7499	215
1714519	41 - 5513	1223	172929	12 - 7476	215	2027350	12 - 7522	215
1714760	07 - 12060	107	173037	12 - 7509	215	2027581	12 - 7490	215
1714760SM	07 - 12060	107	173461	12 - 7543	215	2027624	12 - 7539	215
1714770	31 - 9664	1066	173948	12 - 7500	215	2027639	12 - 7633	216
1714771	31 - 9666	1066	174224	12 - 7509	215	2027709	12 - 7472	215
1714771SM	31 - 9666	1066	174364	12 - 7492	215	2028035	12 - 7528	215

O.E.M. REPLACEMENT CROSS REFERENCE



CROSS REFERENCE 2014

OEM #	Our #	Page #	OEM #	Our #	Page #	OEM #	Our #	Page #
SIMPLICITY/ALLIS CHA			SIMPLICITY/ALLIS CHA			SIMPLICITY/ALLIS CHA		
2028077	12 - 7438	214	2118011	09 - 442	134	2174224	12 - 7509	215
2028217	12 - 7486	215	2118011SM	09 - 442	134	2174224SM	12 - 7509	215
2028241	12 - 7474	215	2118225	12 - 7470	215	2174364	12 - 7492	215
2028459	12 - 7467	215	2118225SM	12 - 7470	215	2174364SM	12 - 7492	215
2028474	12 - 7492	215	2118414	13 - 718	36	2174486	12 - 7594	216
2028766	12 - 7536	215	2118414SM	13 - 718	36	2174486SM	12 - 7594	216
2028988	12 - 7594	216	2121078	12 - 7478	215	2174731	12 - 7496	215
2029056	12 - 7500	215	2121078SM	12 - 7478	215	2174731SM	12 - 7496	215
2029223	12 - 7487	215	2121216	12 - 7481	215	2174883	12 - 7477	215
2029348	12 - 7477	215	2121216SM	12 - 7481	215	2174883SM	12 - 7477	215
2029350	12 - 7496	215	2122120	12 - 7439	214	2174911	12 - 7487	215
2029451	12 - 7472	215	2122120SM	12 - 7439	214	2174911SM	12 - 7487	215
2029665	12 - 7543	215	2152017	12 - 7590	216	2175361	12 - 7472	215
2029748	12 - 7477	215	2152017SM	12 - 7590	216	2175361SM	12 - 7472	215
2029789	12 - 7443	214	2154393	09 - 813	133	2176393	12 - 7441	214
2029828	12 - 7442	214	2154393SM	09 - 813	133	2176393SM	12 - 7441	214
2029829	12 - 7480	215	2154486	09 - 813	133	2176439	12 - 7517	215
2056755	12 - 7482	215	2154486SM	09 - 813	133	2176439SM	12 - 7517	215
2087648	12 - 7515	215	2154534	13 - 721	36	2176917	12 - 7480	215
2087731	15 - 1117	399	2154534SM	13 - 721	36	2176917SM	12 - 7480	215
2087732	12 - 7521	215	2156120	12 - 7506	215	2177452	12 - 7504	215
2087759	12 - 7509	215	2156120SM	12 - 7506	215	2177452SM	12 - 7504	215
2087836	12 - 7517	215	2156124	13 - 721	36	24615	12 - 7507	215
2087883	12 - 7439	214	2156124SM	13 - 721	36	2626869	12 - 7444	214
2097654	12 - 7483	215	2156231	12 - 7485	215	296499	12 - 7440	214
2101137	12 - 7532	215	2156231SM	12 - 7485	215	529433	12 - 7590	216
2101137SM	12 - 7532	215	2157230	12 - 5005	211	536986	09 - 484	133
2105122	12 - 7601	216	2157230SM	12 - 5005	211	7013313	09 - 484	133
2105122SM	12 - 7601	216	2157524	12 - 7444	214	7015707	31 - 9663	1066
2105340	12 - 7641	216	2157524SM	12 - 7444	214	7015707YP	31 - 9663	1066
2105340SM	12 - 7641	216	2157683	12 - 7472	215	7023354	31 - 9664	1066
2108202	09 - 484	133	2157683SM	12 - 7472	215	7023354YP	31 - 9664	1066
2108202SM	09 - 484	133	2158573	12 - 7474	215	7029264	07 - 6916	106
2108248	12 - 7491	215	2158573SM	12 - 7474	215	70675233	12 - 7590	216
2108248SM	12 - 7491	215	2161098	12 - 7482	215	71336137	12 - 7611	216
2108297	15 - 1116	399	2161098SM	12 - 7482	215	71352142	12 - 7487	215
2108297A	15 - 1116	399	2162081	12 - 7519	215	71358134	12 - 7631	216
2108297AS	15 - 1116	399	2164146	12 - 7477	215	71601672	12 - 7504	215
2108297ASM	15 - 1116	399	2164146SM	12 - 7477	215	71656960	12 - 7527	215
2108386	13 - 723	36	2165048	12 - 7528	215	71664789	12 - 7532	215
2108386SM	13 - 723	36	2165048SM	12 - 7528	215	71666698	12 - 7533	215
2108389	12 - 7542	215	2166172	12 - 7490	215	7166801	12 - 7523	215
2108389SM	12 - 7542	215	2166172SM	12 - 7490	215	72027114	12 - 7528	215
2108458	12 - 7488	215	2168171	12 - 7453	214	72027134	12 - 7513	215
2108458SM	12 - 7488	215	2168171SM	12 - 7453	214	72087648	12 - 7515	215
2108501	15 - 1117	399	2170164	12 - 7622	216	72088100	12 - 7521	215
2108501A	15 - 1117	399	2170164SM	12 - 7622	216	72102528	12 - 7485	215
2108501AS	15 - 1117	399	2170771	12 - 7441	214	8021036	12 - 7483	215
2108501ASM	15 - 1117	399	2170771SM	12 - 7441	214	8021077	12 - 5072	212
2108732	12 - 7438	214	2170921	12 - 7467	215	8021077	12 - 7482	215
2108732SM	12 - 7438	214	2170921SM	12 - 7467	215	8081053	12 - 7490	215
2108854	12 - 7488	215	2172066	12 - 7472	215	8091017	12 - 7493	215
2108854SM	12 - 7488	215	2172066SM	12 - 7472	215	8151018	12 - 7501	215



O.E.M. REPLACEMENT CROSS REFERENCE

2014 CROSS REFERENCE

OEM #	Our #	Page #	OEM #	Our #	Page #	OEM #	Our #	Page #
SIMPLICITY/ALLIS CHA			SNAPPER/KEES			SNAPPER/KEES		
8161083	12 - 7486	215	1-0987	13 - 438	291	1-2561	12 - 7497	215
8161119	12 - 7476	215	1-1013	10 - 7886	180	1-2579	07 - 855	102
8161164	12 - 7474	215	1-1024	05 - 3244	94	1-2603	06 - 2986	99
8161244	12 - 7481	215	1-1029	13 - 734	36	1-2605	05 - 2699	72
F315882	37 - 3048	1180	1-1035	10 - 7885	180	1-2617	09 - 2940	147
SNAPPER/KEES			1-1050	33 - 9089	1129	1-2623	31 - 1939	1063
1-0034	12 - 7472	215	1-1082	06 - 271	99	1-2828	09 - 442	134
1-0056	12 - 7470	215	1-1083	06 - 272	99	1-2927	17 - 1160	431
1-0063	12 - 7472	215	1-1097	08 - 347	118	1-2931	09 - 813	133
1-0084	12 - 7466	215	1-1125	09 - 2703	130	1-3313	09 - 484	133
1-0085	12 - 7478	215	1-1155	31 - 6545	1061	1-3321	09 - 853	143
1-0108	12 - 7467	215	1-1201	10 - 8448	178	1-3536	12 - 7497	215
1-0109	12 - 7483	215	1-1712	12 - 7495	215	1-3680	09 - 6573	133
1-0121	05 - 8816	93	1-1747	10 - 2908	162	1-3681	29 - 482	666
1-0125	12 - 7485	215	1-1774	05 - 3247	94	1-3850	13 - 719	36
1-0178	12 - 8711	250	1-1777	20 - 11357	499	1-3885	10 - 6973	171
1-0192	12 - 7585	216	1-1777	20 - 1357	46	1-3893	05 - 6931	92
1-0207	12 - 7612	216	1-1807	09 - 327	39	1-3936	12 - 7442	214
1-0252	12 - 7487	215	1-1807	09 - 328	133	1-3937	12 - 7481	215
1-0253	12 - 7488	215	1-1815	10 - 2909	162	1-3938	12 - 7441	214
1-0419	12 - 7469	215	1-1817	05 - 8632	94	1-4022	10 - 11828	169
1-0524	08 - 344	118	1-1853	31 - 1930	1063	1-4225	12 - 7543	215
1-0525	08 - 355	124	1-1887	12 - 669	240	1-4353	12 - 7505	215
1-0525	08 - 358	124	1-1946	12 - 7471	215	1-4359	20 - 11357	499
1-0532	12 - 7575	216	1-1947	12 - 7447	214	1-4359	20 - 1357	46
1-0629	12 - 7541	215	1-1948	12 - 7473	215	1-4397	13 - 776	291
1-0678	12 - 7511	215	1-1969	12 - 7494	215	1-4503	12 - 7491	215
1-0682	12 - 7536	215	1-1991	03 - 234	65	1-4523	05 - 7255	93
1-0694	09 - 2939	144	1-2020	12 - 7480	215	1-4525	12 - 870	224
1-0696	09 - 484	133	1-2061	03 - 233	65	1-4560	12 - 7542	215
1-0708	12 - 7488	215	1-2122	10 - 3306	172	1-4604	07 - 2990	102
1-0729	12 - 7486	215	1-2124	13 - 8478	263	1-4624	09 - 6536	133
1-0745	10 - 2210	174	1-2140	13 - 9508	291	1-4625	09 - 8726	133
1-0746	02 - 9492	53	1-2155	20 - 2232	514	1-4637	12 - 7438	214
1-0747	12 - 7499	215	1-2248	12 - 7470	215	1-4662	05 - 8665	94
1-0748	12 - 7477	215	1-2249	12 - 7480	215	1-4686	12 - 7505	215
1-0749	12 - 673	240	1-2296	09 - 6864	148	1-4716	12 - 7479	215
1-0756	09 - 8199	131	1-2304	09 - 3229	130	1-4747	12 - 7482	215
1-0756	09 - 481	131	1-2309	09 - 2907	142	1-4799	12 - 7129	240
1-0765	05 - 300	92	1-2320	28 - 1995	663	1-4800	12 - 8075	241
1-0820	08 - 341	118	1-2321	28 - 1999	663	1-4801	12 - 7537	215
1-0820	08 - 7328	118	1-2337	20 - 7730	510	1-5151	12 - 7439	214
1-0821	08 - 352	123	1-2345	06 - 286	99	1-5474	09 - 6573	133
1-0836	12 - 7444	214	1-2347	06 - 2985	99	1-5476	05 - 8293	70
1-0837	12 - 7449	214	1-2353	12 - 670	240	1-5477	05 - 8294	70
1-0849	12 - 7430	214	1-2354	12 - 869	240	1-6584	15 - 6258	412
1-0851	12 - 7487	215	1-2390	09 - 7950	131	1-6587	15 - 6259	412
1-0927	05 - 301	93	1-2425	05 - 2700	72	1-6588	15 - 6257	412
1-0935	10 - 8493	177	1-2496	07 - 2990	102	1-6980	15 - 6108	403
1-0941	11 - 8472	94	1-2503	20 - 8678	510	1-6982	15 - 6109	403
1-0948	13 - 718	36	1-2508	12 - 669	240	1-7036	15 - 2172	334
1-0986	09 - 854	145	1-2515	20 - 2235	514	1-7036	15 - 1009	336
			1-2524	12 - 7635	216	1-7037	15 - 6294	323

O.E.M. REPLACEMENT CROSS REFERENCE



CROSS REFERENCE 2014

OEM #	Our #	Page #	OEM #	Our #	Page #	OEM #	Our #	Page #
SNAPPER/KEES			SNAPPER/KEES			SNAPPER/KEES		
1-7037	15 - 2173	334	1-9518	15 - 1103	402	1726357	15 - 10094	399
1-7037	15 - 1010	336	1-9523	15 - 1060	403	1726357A	15 - 10094	399
1-7043	15 - 6300	322	1-9523	15 - 6301	326	1726357ASM	15 - 10094	399
1-7048	05 - 7787	91	1-9534	12 - 7478	215	1726453	15 - 10094	399
1-7063	10 - 11858	167	1-9544	31 - 1929	1072	1726453A	15 - 10094	399
1-7083	05 - 5951	94	1-9545	31 - 7675	1064	1726453BZ	15 - 10094	399
1-7084	05 - 5952	94	1-9550	12 - 7466	215	1726453BZYP	15 - 10094	399
1-7168	15 - 6110	402	1-9551	12 - 7487	215	1727918	10 - 13665	159
1-7168	15 - 6317	324	1-9572	09 - 7162	134	1727918SM	10 - 13665	159
1-7226	41 - 7678	93	1-9581	12 - 7539	215	1731898	15 - 12852	402
1-7326	10 - 3223	172	1-9607	12 - 7482	215	1731898A	15 - 12852	402
1-7696	05 - 8603	92	1-9645	15 - 6317	324	1731898BZ	15 - 12852	402
1-8038	15 - 1089	346	1-9645	15 - 2006	402	1731898BZYP	15 - 12852	402
1-8059	05 - 3246	94	1-9733	15 - 2169	400	1731898MA	15 - 12852	402
1-8060	05 - 3245	94	1-9795	15 - 6317	324	1732006	31 - 9665	1066
1-8068	15 - 1091	403	1-9795	15 - 2006	402	1735326	10 - 14226	199
1-8069	15 - 1092	403	1-9795	15 - 2007	401	1735326YP	10 - 14226	199
1-8069	15 - 6297	326	1-9978	21 - 2227	522	1737228A	15 - 13481	400
1-8069	15 - 6029	403	100022	12 - 7634	216	1737228BZ	15 - 13481	400
1-8177	28 - 1998	664	10008	02 - 41	39	1737228BZYP	15 - 13481	400
1-8186	03 - 239	65	101080	31 - 9659	1066	1737228MA	15 - 13481	400
1-8188	03 - 867	65	10211	02 - 44	40	1737252A	15 - 13482	401
1-8189	07 - 2991	102	102424	31 - 11470	1065	1737252BM	15 - 13482	401
1-8190	07 - 2992	102	11029	13 - 5869	263	1737252BZ	15 - 13482	401
1-8193	15 - 1087	402	11083	06 - 2985	99	1737252BZYP	15 - 13482	401
1-8197	18 - 2288	443	11802	06 - 9875	99	1737252MA	15 - 13482	401
1-8198	18 - 2281	443	11807	09 - 6573	133	18555	05 - 5952	94
1-8214	18 - 2289	443	12163	08 - 10114	114	19175	03 - 7812	66
1-8236	12 - 675	237	13865	41 - 916	1221	19515	15 - 11238	403
1-8288	13 - 731	36	14208	13 - 729	36	19523	15 - 11239	403
1-8574	13 - 9856	290	14340	13 - 2175	263	19645	15 - 6110	402
1-8585	13 - 777	264	14363	20 - 8935	514	19702	15 - 6110	402
1-8604	31 - 5933	1071	14604	06 - 286	99	19710	15 - 6110	402
1-8604	31 - 10772	1071	146071	06 - 2986	99	2-1707	13 - 8547	291
1-8637	41 - 5514	1224	14847	31 - 9660	1066	2-1742	10 - 7154	182
1-8651	13 - 5870	263	15707	31 - 9663	1066	2-1745	05 - 5803	93
1-8764	41 - 5514	1224	15707	31 - 9660	1066	2-1764	13 - 8193	291
1-8767	09 - 3228	131	15753	10 - 2208	174	2-2043	13 - 5949	291
1-8781	13 - 436	291	16343	10 - 12227	165	2-2044	13 - 5950	291
1-8816	31 - 7179	1061	1654930	20 - 7730	510	2-2252	12 - 675	237
1-8817	31 - 10771	1071	1654930SM	20 - 7730	510	2-2252	12 - 7838	241
1-8817	31 - 3319	1071	1674312	12 - 7480	215	2-2319	28 - 1995	663
1-8889	03 - 5805	65	1674312SM	12 - 7480	215	2-2374	07 - 8927	102
1-8889	03 - 231	65	16844	10 - 10703	73	2-2795	07 - 8928	102
1-9125	09 - 3217	134	1700184SM	07 - 6916	106	2-2796	07 - 8929	102
1-9190	07 - 9559	107	17002	15 - 6110	402	2-2797	07 - 8930	102
1-9198	06 - 6709	99	1705897	09 - 7917	132	2-2800	06 - 8263	99
1-9201	06 - 6709	99	1705897SM	09 - 7917	132	2-3354	31 - 9664	1066
1-9251	28 - 1998	664	1716615	13 - 718	36	2-3364	05 - 301	93
1-9254	03 - 6589	66	1716615SM	13 - 718	36	2-3556	09 - 5707	147
1-9378	20 - 2235	514	1719911	12 - 9900	235	2-3744	05 - 5803	93
1-9515	15 - 1098	403	1719911SM	12 - 9900	235	2-3774	28 - 1999	663
1-9515	15 - 6302	326	1723507	31 - 9665	1066	2-4365	41 - 5529	1224



O.E.M. REPLACEMENT CROSS REFERENCE

2014 CROSS REFERENCE

OEM #	Our #	Page #	OEM #	Our #	Page #	OEM #	Our #	Page #
SNAPPER/KEES			SNAPPER/KEES			SNAPPER/KEES		
2-4466	15 - 6197	401	292112	31 - 9666	1066	5-0618	08 - 7285	114
2-4497	12 - 870	224	29246	15 - 6014	338	5-0618	08 - 8278	114
2-4507	20 - 5841	46	29247	15 - 6472	400	5-0711	28 - 1997	664
2-4521	13 - 9508	291	29264	07 - 6916	106	5-0713	08 - 9151	113
2-4596	13 - 5950	291	29604	12 - 7438	214	5-0918	09 - 6863	147
2-4619	41 - 5528	1224	29678	10 - 11857	166	5-1449	08 - 8278	114
2-4725	13 - 8245	264	3-0798	10 - 3307	161	5-1814	10 - 8303	163
2-4819	28 - 1998	664	3-1724	15 - 1132	404	5-1815	10 - 8302	163
2-6182	06 - 8262	99	3-1732	10 - 7919	162	5-1885	10 - 9510	163
2-6428	15 - 6277	402	3-4212	20 - 5841	46	5-1886	10 - 9511	163
2-6693	09 - 328	133	3-5520	10 - 14495	164	5-1996	18 - 7239	443
2-8014	09 - 3229	130	3-5726	06 - 8962	99	5-2267	08 - 7285	114
2-8425	41 - 5528	1224	3-5727	06 - 9875	99	5-2267	08 - 8278	114
2-8426	41 - 5529	1224	3-5739	07 - 8931	102	5-2268	08 - 8278	114
2-8427	41 - 5514	1224	3-5740	07 - 8932	102	5-2270	08 - 9151	113
2-8619	12 - 8767	257	3-7751	17 - 5847	433	5-2305	08 - 7285	114
2-8762	05 - 3245	94	32114	10 - 9513	175	5-7444	05 - 6880	93
2-8784	12 - 8768	257	322042	05 - 8276	91	5-7582	13 - 2189	264
2-9025	10 - 3223	172	323030	12 - 7631	216	5-7582	13 - 2186	267
2-9715	31 - 7922	1064	35358	09 - 7950	131	5-8925	10 - 14495	164
2-9908	12 - 7628	216	35658	31 - 9656	1064	5-9759	10 - 1226	186
2108202SM	09 - 484	133	35727	06 - 271	99	5-9964	10 - 1227	186
2153038	08 - 355	124	362024	10 - 1226	186	5020843	15 - 2172	334
2153038SM	08 - 358	124	362025	42 - 7097	1231	5020843A	15 - 2172	334
2153038SM	08 - 355	124	363055	15 - 1010	336	5020843ASM	15 - 2172	334
21759	13 - 9787	291	363055	15 - 6294	323	5021227	15 - 10719	351
22106	13 - 9806	291	363143	12 - 7634	216	5022158	20 - 9650	515
22151	09 - 7262	142	363144	12 - 7589	216	5022631S	08 - 10288	110
22394	09 - 5812	137	363145	12 - 7581	216	5101651	20 - 9650	515
22395	09 - 5812	137	363194	09 - 8305	147	5101651SM	20 - 9650	515
22886	31 - 9665	1066	363214	13 - 2188	263	5101755	15 - 3434	362
23180	10 - 10704	73	363214	13 - 12891	281	5101756	15 - 3404	347
23355	31 - 9659	1066	363245	15 - 6294	323	5101986	15 - 2172	334
23556	09 - 8240	148	394358	20 - 1357	46	5101986BMYP	15 - 2172	334
23828	08 - 341	118	394358	20 - 11357	499	5102227	15 - 3329	337
23828	08 - 7328	118	394358	20 - 11357	499	52267	08 - 10892	114
23966	13 - 777	264	394358	20 - 1357	46	52270	08 - 10115	114
26122	07 - 6914	105	394358S	20 - 1357	46	525	15 - 6259	412
26691	15 - 6110	402	394358S	20 - 11357	499	525GCS	15 - 6259	412
26808	09 - 7917	132	4-0284	10 - 8301	161	52671	08 - 10114	114
27225	31 - 9658	1066	4-0433	08 - 7744	117	53103	05 - 10169	93
27427	10 - 10701	73	4-0434	08 - 7745	117	53304	08 - 10106	114
27429	10 - 10702	73	4-3844	12 - 9483	241	53740	10 - 9911	164
27698	31 - 2922	1062	4-4637	12 - 8767	257	54246	10 - 8303	163
27717	13 - 8588	264	4-4743	06 - 8962	99	54247	10 - 8302	163
28542	31 - 9657	1064	4-7843	10 - 7747	157	573033	12 - 7482	215
28542	31 - 11470	1065	42998	15 - 6197	401	57423	05 - 10169	93
28761	05 - 3246	94	44785	10 - 7154	182	58518	08 - 10110	114
28779	13 - 438	291	46245	08 - 347	118	58519	08 - 10111	114
28903	20 - 9650	515	46555	09 - 7162	134	58520	08 - 10112	114
29010	07 - 2992	102	46678	06 - 9612	99	58943	08 - 10106	114
29101	12 - 7441	214	483011	15 - 6296	322	58951	08 - 10114	114
29211	31 - 9666	1066	5-0294	08 - 9155	113	58951	08 - 10107	114

O.E.M. REPLACEMENT CROSS REFERENCE



CROSS REFERENCE 2014

OEM #	Our #	Page #	OEM #	Our #	Page #	OEM #	Our #	Page #
SNAPPER/KEES			SNAPPER/KEES			SNAPPER/KEES		
5L290	12 - 5156	213	7010056	12 - 7470	215	7011013	10 - 7886	180
5L300	12 - 5157	213	7010063	12 - 7472	215	7011013YP	10 - 7886	180
6-0278	09 - 8661	137	7010084	12 - 7466	215	7011024	05 - 3244	94
6-0316	18 - 2290	443	7010085	12 - 7478	215	7011024YP	05 - 3244	94
6-0480	15 - 1136	404	7010108	12 - 7467	215	7011029	13 - 734	36
6-0631	41 - 5508	1225	7010109	12 - 7483	215	7011029	13 - 5869	263
6-0710	05 - 6930	92	7010121	05 - 8816	93	7011029YP	13 - 734	36
6-0916	03 - 7812	66	7010121YP	05 - 8816	93	7011035	10 - 7885	180
6-1215	41 - 13170	1225	7010125	12 - 7485	215	7011035YP	10 - 7885	180
60332	15 - 1089	346	7010178	12 - 8711	250	7011082	06 - 271	99
60785	15 - 910	405	7010192	12 - 7585	216	7011082	06 - 9875	99
7-4453	18 - 13625	442	7010207	12 - 7612	216	7011083	06 - 272	99
7-6340	05 - 8276	91	7010211	02 - 44	40	7011125	09 - 2703	130
7-6353	12 - 7632	216	7010211YP	02 - 44	40	7011125YP	09 - 2703	130
7-6379	10 - 1226	186	7010252	12 - 7487	215	7011155	31 - 6545	1061
7-6405	10 - 2219	161	7010253	12 - 7488	215	7011155YP	31 - 6545	1061
7-6409	08 - 905	112	7010419	12 - 7469	215	7011201	10 - 8448	178
7-6436	10 - 1191	175	7010524	08 - 344	118	7011747	10 - 2908	162
7-6439	10 - 2224	172	7010525	08 - 358	124	7011747YP	10 - 2908	162
7-6450	15 - 6294	323	7010525	08 - 355	124	7011774	05 - 3247	94
7-6496	12 - 7634	216	7010532	12 - 7575	216	7011774YP	05 - 3247	94
7-6497	12 - 5233	257	7010629	12 - 7541	215	7011807	09 - 328	133
7-6498	12 - 7581	216	7010678	12 - 7511	215	7011807	09 - 327	39
7-6500	13 - 5714	264	7010682	12 - 7536	215	7011807YP	09 - 327	39
7-6510	09 - 3217	134	7010694	09 - 2939	144	7011807YP	09 - 328	133
7-6514	09 - 8305	147	7010694YP	09 - 2939	144	7011815	10 - 2909	162
7-6515	09 - 5703	147	7010708	12 - 7488	215	7011815YP	10 - 2909	162
7-6520	13 - 2188	263	7010729	12 - 7486	215	7011817	05 - 8632	94
7-6645	10 - 1227	186	7010745	10 - 2210	174	7011817YP	05 - 8632	94
7-6675	15 - 1009	336	7010745YP	10 - 2210	174	7011853	31 - 1930	1063
7-6675	15 - 6296	322	7010746	02 - 9492	53	7011853YP	31 - 1930	1063
7-6676	12 - 7598	216	7010746YP	02 - 9492	53	7011946	12 - 7471	215
7-6677	12 - 7638	216	7010747	12 - 7499	215	7011947	12 - 7447	214
7-6680	12 - 7583	216	7010748	12 - 7477	215	7011948	12 - 7473	215
7-6688	13 - 5714	264	7010749	12 - 673	240	7011969	12 - 7494	215
7-6967	10 - 2225	162	7010749YP	12 - 673	240	7011969YP	12 - 7494	215
7-6988	02 - 24	43	7010756	09 - 481	131	7011991	03 - 234	65
7-7044	12 - 7580	216	7010756	09 - 8199	131	7012061	03 - 233	65
7-7285	13 - 2186	267	7010756YP	09 - 8199	131	7012061YP	03 - 233	65
7-7344	15 - 2173	334	7010756YP	09 - 481	131	7012122	10 - 3306	172
7-7344	15 - 6294	323	7010821	08 - 352	123	7012122YP	10 - 3306	172
7-7355	19 - 12864	450	7010821YP	08 - 352	123	7012124	13 - 8478	263
7-7378	15 - 2172	334	7010836	12 - 7444	214	7012124YP	13 - 8478	263
7-7378	15 - 6296	322	7010837	12 - 7449	214	7012140	13 - 9508	291
7-9197	10 - 11070	170	7010849	12 - 7430	214	7012155	20 - 2232	514
7-9222	15 - 6167	359	7010849YP	12 - 7430	214	7012155YP	20 - 2232	514
7-9222	15 - 6168	360	7010935	10 - 8493	177	7012163	08 - 10114	114
7-9446	10 - 11070	170	7010935SM	10 - 8493	177	7012163YP	08 - 10114	114
7-9813	09 - 7162	134	7010941	11 - 8472	94	7012248	12 - 7470	215
701-9733	15 - 2169	400	7010941YP	11 - 8472	94	7012248YP	12 - 7470	215
7010008	02 - 41	39	7010948	13 - 718	36	7012249	12 - 7480	215
7010008YP	02 - 41	39	7010986	09 - 854	145	7012296	09 - 6864	148
7010034	12 - 7472	215	7010986YP	09 - 854	145	7012296YP	09 - 6864	148



O.E.M. REPLACEMENT CROSS REFERENCE

2014 CROSS REFERENCE

OEM #	Our #	Page #	OEM #	Our #	Page #	OEM #	Our #	Page #
SNAPPER/KEES			SNAPPER/KEES			SNAPPER/KEES		
7012304	09 - 3229	130	7013885	10 - 6973	171	7015151	12 - 7439	214
7012309	09 - 2907	142	7013885YP	10 - 6973	171	7015151YP	12 - 7439	214
7012309YP	09 - 2907	142	7013893	05 - 6931	92	7015474	09 - 6573	133
7012320	28 - 1995	663	7013893YP	05 - 6931	92	7015476	05 - 8293	70
7012321	28 - 1999	663	7013936	12 - 7442	214	7015476YP	05 - 8293	70
7012337	20 - 7730	510	7013936YP	12 - 7442	214	7015477	05 - 8294	70
7012345	06 - 286	99	7013937	12 - 7481	215	7015477YP	05 - 8294	70
7012347	32 - 2347	1084	7013937YP	12 - 7481	215	7015707	31 - 9663	1066
7012353	12 - 670	240	7013939	12 - 8428	221	7015707	31 - 9660	1066
7012353YP	12 - 670	240	7013939YP	12 - 8428	221	7015707YP	31 - 9660	1066
7012354	12 - 869	240	7014208	13 - 729	36	7015707YP	31 - 9663	1066
7012354YP	12 - 869	240	7014208YP	13 - 729	36	7015753	10 - 2208	174
7012425	05 - 2700	72	7014225	12 - 7543	215	7015753YP	10 - 2208	174
7012425YP	05 - 2700	72	7014225YP	12 - 7543	215	7016844	10 - 10703	73
7012503	20 - 8678	510	7014340	13 - 2175	263	7016844YP	10 - 10703	73
7012503YP	20 - 8678	510	7014340YP	13 - 2175	263	7016980	15 - 6108	403
7012508	12 - 669	240	7014353	12 - 7505	215	7016980BZ	15 - 6108	403
7012508	12 - 669	240	7014353YP	12 - 7505	215	7016980BZYP	15 - 6108	403
7012508YP	12 - 669	240	7014359	20 - 1357	46	7016982	15 - 6109	403
7012515	20 - 8000	513	7014359	20 - 11357	499	7017002	15 - 2006	402
7012515	20 - 8935	514	7014359	20 - 11357	499	7017036	15 - 6296	322
7012515	20 - 2235	514	7014359	20 - 1357	46	7017036	15 - 1009	336
7012515	20 - 2235	514	7014397	13 - 776	291	7017036	15 - 1009	336
7012515YP	20 - 2235	514	7014397YP	13 - 776	291	7017036	15 - 2172	334
7012524	12 - 7635	216	7014523	05 - 7255	93	7017036	15 - 2172	334
7012524YP	12 - 7635	216	7014523YP	05 - 7255	93	7017036YP	15 - 2172	334
7012579	07 - 855	102	7014525	12 - 870	224	7017036YP	15 - 1009	336
7012603	06 - 2986	99	7014560	12 - 7542	215	7017063	10 - 11858	167
7012603	07 - 8929	102	7014560YP	12 - 7542	215	7017063YP	10 - 11858	167
7012603	06 - 8263	99	7014604	07 - 8930	102	7017168	15 - 6110	402
7012603YP	06 - 2986	99	7014604	06 - 286	99	7017226	41 - 7678	93
7012605	05 - 2699	72	7014604	07 - 2990	102	7017226YP	41 - 7678	93
7012605YP	05 - 2699	72	7014604	06 - 6709	99	7017696	05 - 8603	92
7012617	09 - 2940	147	7014604YP	06 - 286	99	7017696YP	05 - 8603	92
7012617YP	09 - 2940	147	7014624	09 - 6536	133	7017817	31 - 14672	1062
7012623	31 - 1939	1063	7014624YP	09 - 6536	133	7018038	15 - 1089	346
7012623YP	31 - 1939	1063	7014625	09 - 8726	133	7018068	15 - 1091	403
7012828	09 - 442	134	7014625YP	09 - 8726	133	7018068YP	15 - 1091	403
7012828YP	09 - 442	134	7014662	05 - 8665	94	7018069	15 - 1092	403
7012927	17 - 1160	431	7014662YP	05 - 8665	94	7018069	15 - 6029	403
7012927YP	17 - 1160	431	7014686	12 - 7505	215	7018069	15 - 6297	326
7013313	09 - 484	133	7014686YP	12 - 7505	215	7018069BZ	15 - 1092	403
7013313	09 - 484	133	7014716	12 - 7479	215	7018069BZYP	15 - 6297	326
7013313SM	09 - 484	133	7014716YP	12 - 7479	215	7018069BZYP	15 - 6029	403
7013313SM	09 - 484	133	7014799	12 - 7129	240	7018069BZYP	15 - 1092	403
7013321	09 - 853	143	7014799YP	12 - 7129	240	7018186	03 - 239	65
7013321YP	09 - 853	143	7014800	12 - 8075	241	7018186YP	03 - 239	65
7013536	12 - 7497	215	7014800YP	12 - 8075	241	7018188	03 - 867	65
7013536YP	12 - 7497	215	7014801	12 - 7537	215	7018189	07 - 2991	102
7013681	29 - 482	666	7014801YP	12 - 7537	215	7018189YP	07 - 2991	102
7013681YP	29 - 482	666	7014847	31 - 9660	1066	7018193	15 - 1087	402
7013850	13 - 719	36	7014847YP	31 - 9660	1066	7018197	18 - 2288	443
7013850YP	13 - 719	36	7015115	05 - 5952	94	7018197YP	18 - 2288	443

O.E.M. REPLACEMENT CROSS REFERENCE



CROSS REFERENCE 2014

OEM #	Our #	Page #	OEM #	Our #	Page #	OEM #	Our #	Page #
SNAPPER/KEES			SNAPPER/KEES			SNAPPER/KEES		
7018198	18 - 2281	443	7019550	12 - 7466	215	7023180	10 - 10704	73
7018198YP	18 - 2281	443	7019550YP	12 - 7466	215	7023180YP	10 - 10704	73
7018214	18 - 2289	443	7019551	12 - 7487	215	7023354	31 - 9664	1066
7018214YP	18 - 2289	443	7019551YP	12 - 7487	215	7023354YP	31 - 9664	1066
7018288	13 - 731	36	7019572	09 - 7162	134	7023355	31 - 9659	1066
7018288YP	13 - 731	36	7019572YP	09 - 7162	134	7023355YP	31 - 9659	1066
7018574	13 - 9856	290	7019581	12 - 7539	215	7023364	05 - 301	93
7018574SM	13 - 9856	290	7019607	12 - 7482	215	7023364YP	05 - 301	93
7018651	13 - 5870	263	7019607YP	12 - 7482	215	7023556	09 - 5707	147
7018651YP	13 - 5870	263	7019645	15 - 2006	402	7023556	09 - 8240	148
7018781	13 - 436	291	7019702	15 - 2006	402	7023556YP	09 - 5707	147
7018781BMYP	13 - 436	291	7019733	15 - 2169	400	7023735	10 - 10357	160
7018782	05 - 300	92	7019733BZ	15 - 2169	400	7023790	05 - 14173	93
7018782SM	05 - 300	92	7019733BZYP	15 - 2169	400	7023790YP	05 - 14173	93
7018816	31 - 7179	1061	7019795	15 - 2007	401	7023828	08 - 341	118
7018816YP	31 - 7179	1061	7019795	15 - 2006	402	7023828	08 - 7328	118
7018889	03 - 5805	65	7019795	15 - 6317	324	7023828YP	08 - 341	118
7018889	03 - 231	65	7019795BZ	15 - 2006	402	7023828YP	08 - 7328	118
7018889YP	03 - 5805	65	7019795BZ	15 - 2007	401	7023889	08 - 344	118
7018889YP	03 - 231	65	7019795BZYP	15 - 2006	402	7023889YP	08 - 344	118
7019078	13 - 12891	281	7019795BZYP	15 - 6317	324	7023966	13 - 777	264
7019078	13 - 2188	263	7019978	21 - 2227	522	7023966	13 - 777	264
7019078YP	13 - 12891	281	702153038	08 - 358	124	7023966YP	13 - 777	264
7019078YP	13 - 2188	263	7021707	13 - 8547	291	7024466	15 - 6197	401
7019125	09 - 3217	134	7021707YP	13 - 8547	291	7024497	12 - 870	224
7019125YP	09 - 3217	134	7021759	13 - 9787	291	7024497YP	12 - 870	224
7019175	03 - 7812	66	7021759YP	13 - 9787	291	7024521	13 - 9508	291
7019175YP	03 - 7812	66	7021764	13 - 8193	291	7024521YP	13 - 9508	291
7019190	07 - 9559	107	7021764YP	13 - 8193	291	7024596	13 - 5950	291
7019190YP	07 - 9559	107	7022043	13 - 5949	291	7024596YP	13 - 5950	291
7019199	06 - 272	99	7022043YP	13 - 5949	291	7024725	13 - 8245	264
7019200	06 - 8263	99	7022106	13 - 9806	291	7024725YP	13 - 8245	264
7019254	03 - 6589	66	7022106YP	13 - 9806	291	7024741AYP	15 - 6109	403
7019254YP	03 - 6589	66	7022151	09 - 7262	142	7024741BZ	15 - 6109	403
7019515	15 - 11238	403	7022151	09 - 7262	142	7024819	28 - 1998	664
7019515	15 - 6302	326	7022151YP	09 - 7262	142	7024819YP	28 - 1998	664
7019515	15 - 1098	403	7022252	12 - 675	237	7026122	07 - 6914	105
7019515BZ	15 - 11238	403	7022252	12 - 675	237	7026122SM	07 - 6914	105
7019515BZ	15 - 6302	326	7022252	12 - 7838	241	7026182	06 - 8262	99
7019515BZYP	15 - 1098	403	7022252YP	12 - 675	237	7026245	08 - 347	118
7019515BZYP	15 - 6302	326	7022374	07 - 8927	102	7026428	15 - 6277	402
7019518	15 - 1103	402	7022394	09 - 5812	137	7026428BZ	15 - 6277	402
7019518YP	15 - 1103	402	7022394YP	09 - 5812	137	7026428BZYP	15 - 6277	402
7019523	15 - 11239	403	7022395	09 - 5812	137	7026691	15 - 6110	402
7019523	15 - 1060	403	7022395YP	09 - 5812	137	7026691	15 - 2006	402
7019523	15 - 6301	326	7022795	07 - 8928	102	7026691BZ	15 - 6110	402
7019523BZ	15 - 1060	403	7022795	07 - 2991	102	7026691BZYP	15 - 6110	402
7019523BZ	15 - 6301	326	7022796	07 - 8929	102	7026693	09 - 328	133
7019523BZYP	15 - 1060	403	7022797	07 - 8930	102	7026693	09 - 6573	133
7019523BZYP	15 - 6301	326	7022800	06 - 8263	99	7026693YP	09 - 6573	133
7019544	31 - 1929	1072	7022801	06 - 6709	99	7026808	09 - 7917	132
7019545	31 - 7675	1064	7022886	31 - 9665	1066	7027225	31 - 9658	1066
7019545YP	31 - 7675	1064	7022886YP	31 - 9665	1066	7027225YP	31 - 9658	1066



O.E.M. REPLACEMENT CROSS REFERENCE

2014 CROSS REFERENCE

OEM #	Our #	Page #	OEM #	Our #	Page #	OEM #	Our #	Page #
SNAPPER/KEES			SNAPPER/KEES			SNAPPER/KEES		
7027427	10 - 10701	73	7032114YP	10 - 9513	175	7046555YP	09 - 7162	134
7027427YP	10 - 10701	73	7032831	05 - 14174	93	7046678	07 - 8931	102
7027429	10 - 10702	73	7032831YP	05 - 14174	93	7046678	06 - 9612	99
7027429YP	10 - 10702	73	703331	15 - 909	405	7046784	12 - 11677	257
7027698	31 - 2922	1062	7034212	20 - 5841	46	7046784YP	12 - 11677	257
7027698YP	31 - 2922	1062	7034212YP	20 - 5841	46	7046983	09 - 3228	131
7028014	09 - 3229	130	703459	10 - 8448	178	7046983YP	09 - 3228	131
7028014YP	09 - 3229	130	7034604	05 - 12075	67	7047843	10 - 7747	157
7028427	41 - 5514	1224	7034604YP	05 - 12075	67	7047843YP	10 - 7747	157
7028427	41 - 5514	1224	7035358	09 - 7950	131	7050294	08 - 9155	113
7028427YP	41 - 5514	1224	7035358SM	09 - 7950	131	7050294YP	08 - 9155	113
7028542	31 - 11470	1065	7035658	31 - 9656	1064	7050711	28 - 1997	664
7028542	31 - 9657	1064	7035658	31 - 9656	1064	7050711YP	28 - 1997	664
7028542YP	31 - 9657	1064	7035658YP	31 - 9656	1064	7050918	09 - 6863	147
7028542YP	31 - 11470	1065	7035658YP	31 - 9656	1064	7050918YP	09 - 6863	147
7028722	09 - 6573	133	7035726	07 - 8932	102	7051885	10 - 9510	163
7028722YP	09 - 6573	133	7035726	06 - 8962	99	7051886	10 - 9511	163
7028761	05 - 3246	94	7035726YP	06 - 8962	99	7051996	18 - 7239	443
7028761YP	05 - 3246	94	7035727	07 - 2992	102	7051996YP	18 - 7239	443
7028762	05 - 3245	94	7035727	06 - 9875	99	7052267	08 - 7285	114
7028762YP	05 - 3245	94	7035727	07 - 8927	102	7052267	08 - 8278	114
7028779	13 - 438	291	7035727YP	06 - 271	99	7052267	08 - 10892	114
7028779YP	13 - 438	291	7035739	07 - 8931	102	7052267YP	08 - 8278	114
7028784	12 - 8768	257	7035740	07 - 8932	102	7052267YP	08 - 7285	114
7028784YP	12 - 8768	257	7035947	41 - 5528	1224	7052268	08 - 8278	114
7028793	12 - 7539	215	7035947YP	41 - 5528	1224	7052268	08 - 7285	114
7028793YP	12 - 7539	215	7035948	41 - 5529	1224	7052268YP	08 - 7285	114
7029010	31 - 2922	1062	7035948SM	41 - 5529	1224	7052268YP	08 - 8278	114
7029010	07 - 2992	102	7037751	17 - 5847	433	7052270	08 - 10115	114
7029025	10 - 3223	172	7037751A	17 - 5847	433	7052270	08 - 9151	113
7029025YP	10 - 3223	172	7037751BM	17 - 5847	433	7052270YP	08 - 9151	113
7029101	12 - 7441	214	7037751BMYP	17 - 5847	433	7052305	08 - 7285	114
7029101YP	12 - 7441	214	7040284	10 - 8301	161	7052671	08 - 10114	114
7029211	12 - 7441	214	7040433	08 - 7744	117	7053103	05 - 10169	93
7029211SM	31 - 9666	1066	7040433YP	08 - 7744	117	7053225	05 - 6880	93
7029247	15 - 6472	400	7040434	08 - 7745	117	7053304	08 - 10106	114
7029264	07 - 6916	106	7040434YP	08 - 7745	117	7053679	10 - 12227	165
7029604	12 - 7438	214	7041939	15 - 6110	402	7053679YP	10 - 12227	165
7029604YP	12 - 7438	214	7041939BZ	15 - 6317	324	7054246	10 - 8303	163
7029678	10 - 11857	166	7041939BZYP	15 - 6110	402	7054246YP	10 - 8303	163
7029678YP	10 - 11857	166	7041939BZYP	15 - 6317	324	7054247	10 - 8302	163
7029715	31 - 7922	1064	7042998	15 - 6197	401	7054247YP	10 - 8302	163
7029715YP	31 - 7922	1064	7042998BZ	15 - 6197	401	7057582	13 - 2189	264
7029908	12 - 7628	216	7042998BZYP	15 - 6197	401	7057582	13 - 2186	267
7029908YP	12 - 7628	216	7043844	12 - 9483	241	7057582YP	13 - 2189	264
7030798	10 - 3307	161	7043844YP	12 - 9483	241	7057582YP	13 - 2186	267
7030798Z	10 - 3307	161	7044637	12 - 8767	257	7058295	10 - 12114	168
7030798ZYP	10 - 3307	161	7044637YP	12 - 8767	257	7058295YP	10 - 12114	168
7031724	15 - 1132	404	7044785	10 - 7154	182	7058518	08 - 10110	114
7031724YP	15 - 1132	404	7044785	10 - 7154	182	7058518YP	08 - 10110	114
7031732	10 - 7919	162	7044785YP	10 - 7154	182	7058519	08 - 10111	114
7031732YP	10 - 7919	162	7046245	08 - 347	118	7058519YP	08 - 10111	114
7032114	10 - 9513	175	7046555	09 - 7162	134	7058520	08 - 10112	114

O.E.M. REPLACEMENT CROSS REFERENCE



CROSS REFERENCE 2014

OEM #	Our #	Page #	OEM #	Our #	Page #	OEM #	Our #	Page #
SNAPPER/KEES			SNAPPER/KEES			SNAPPER/KEES		
7058520YP	08 - 10112	114	7075707YP	13 - 8588	264	7076677	12 - 7638	216
7058925YP	10 - 14495	164	7075751	15 - 1010	336	7076677YP	12 - 7638	216
7058943	08 - 10106	114	7075751	15 - 6294	323	7076680	12 - 7583	216
7058943YP	08 - 10106	114	7075751	15 - 6294	323	7076680YP	12 - 7583	216
7058951	08 - 10114	114	7075751	15 - 2173	334	7076688	13 - 5714	264
7058951	08 - 10107	114	7075751	15 - 2173	334	7076967	10 - 2225	162
7059065	08 - 9947	109	7075751	15 - 6014	338	7076967YP	10 - 2225	162
7059212	10 - 8301	161	7075751BZ	15 - 2173	334	7076988	02 - 24	43
7059212BMYP	10 - 8301	161	7075751BZ	15 - 1010	336	7076988YP	02 - 24	43
7059212YP	10 - 8301	161	7075751BZ	15 - 6294	323	7077288	19 - 12864	450
7059964	10 - 1227	186	7075751BZYP	15 - 1010	336	7077288YP	19 - 12864	450
7059964YP	10 - 1227	186	7075751BZYP	15 - 6294	323	7079222	15 - 6168	360
7060278	09 - 8661	137	7075751BZYP	15 - 2173	334	7079222	15 - 6167	359
7060278YP	09 - 8661	137	7075771	15 - 6300	322	7079369	15 - 6426	322
7060316	18 - 2290	443	7075771	15 - 6472	400	7079369	15 - 6185	400
7060316YP	18 - 2290	443	7075771BZ	15 - 6300	322	7079369YP	15 - 6426	322
7060322	15 - 1089	346	7075771BZYP	15 - 6300	322	7079369YP	15 - 6185	400
7060332YP	15 - 1089	346	7076085	12 - 7480	215	7079371BMYP	15 - 6168	360
7060480	15 - 1136	404	7076340	05 - 8276	91	7079371BMYP	15 - 6167	359
7060480SM	15 - 1136	404	7076340YP	05 - 8276	91	7079371YP	15 - 6167	359
7060631	41 - 5508	1225	7076353	12 - 7632	216	7079371YP	15 - 6168	360
7060631YP	41 - 5508	1225	7076353YP	12 - 7632	216	7079388	15 - 6426	322
7060785	15 - 910	405	7076380	42 - 7097	1231	7079388	15 - 6035	401
7060785YP	15 - 910	405	7076380YP	42 - 7097	1231	7079446	10 - 11070	170
7061215	41 - 13170	1225	7076398	13 - 2185	272	7079446YP	10 - 11070	170
7061275	05 - 6930	92	7076405	10 - 2219	161	7079964	10 - 1227	186
7072284	05 - 5803	93	7076409	08 - 905	112	7090228	15 - 909	405
7072284YP	05 - 5803	93	7076436	10 - 1191	175	7090228SM	15 - 909	405
7072684YP	31 - 12839	1061	7076436YP	10 - 1191	175	7090391	15 - 909	405
7073390	05 - 6880	93	7076439	10 - 2224	172	7090391SM	15 - 909	405
7073528	05 - 6930	92	7076439YP	10 - 2224	172	7090392	17 - 8453	433
7073528YP	05 - 6930	92	7076496	12 - 7634	216	7090392YP	17 - 8453	433
7073584	08 - 347	118	7076496YP	12 - 7634	216	7090419	17 - 12268	179
7073584YP	08 - 347	118	7076497	12 - 7589	216	7090509	17 - 8455	433
7074426	28 - 1999	663	7076497	12 - 5233	257	7090509YP	17 - 8455	433
7074426YP	28 - 1999	663	7076497YP	12 - 7589	216	7090559	17 - 8454	433
7074453	18 - 13625	442	7076497YP	12 - 5233	257	7090559YP	17 - 8454	433
7074453YP	18 - 13625	442	7076498	12 - 7581	216	7091297	15 - 909	405
7074734	28 - 1995	663	7076498YP	12 - 7581	216	7091550	41 - 916	1221
7074734YP	28 - 1995	663	7076500	13 - 5714	264	7091550YP	41 - 916	1221
7074810	05 - 7787	91	7076500YP	13 - 5714	264	7092062	10 - 8448	178
7074810YP	05 - 7787	91	7076514	09 - 5713	147	7092062SM	10 - 8448	178
7075115	05 - 5951	94	7076514	09 - 8305	147	7100058	12 - 11811	230
7075115YP	05 - 5951	94	7076514YP	09 - 8305	147	7100058YP	12 - 11811	230
7075622	31 - 5933	1071	7076514YP	09 - 5713	147	7100851	15 - 11868	392
7075622	31 - 10772	1071	7076515	09 - 5703	147	7100851A	15 - 11868	392
7075622SM	31 - 10772	1071	7076515YP	09 - 5703	147	7100851AYP	15 - 11868	392
7075622SM	31 - 5933	1071	7076520	13 - 12891	281	7100851BMA	15 - 11868	392
7075671	31 - 3319	1071	7076520	13 - 2188	263	7100851BZ	15 - 11868	392
7075671	31 - 10771	1071	7076520YP	13 - 12891	281	7102990	10 - 10357	160
7075671YP	31 - 3319	1071	7076520YP	13 - 2188	263	7103205YP	28 - 1995	663
7075671YP	31 - 10771	1071	7076676	12 - 7598	216	7103789	12 - 14166	257
7075707	13 - 8588	264	7076676YP	12 - 7598	216	7103789YP	12 - 14166	257



O.E.M. REPLACEMENT CROSS REFERENCE

2014 CROSS REFERENCE

OEM #	Our #	Page #	OEM #	Our #	Page #	OEM #	Our #	Page #
SNAPPER/KEES			SOUTHLAND			STIGA		
7105085YP	10 - 10357	160	R8-371	12 - 5074	212	1134-4866-01	15 - 14172	405
72284	05 - 5803	93	RR703	12 - 5077	212	1134-5073-01	15 - 14172	405
73584	08 - 347	118	RR705	12 - 5152	213	1134-9002-01	15 - 50061	405
74426	28 - 1999	663	SP2-700	12 - 5071	212	1134-9022-01	05 - 50215	72
74453	18 - 13625	442	SP9-413	12 - 5072	212	1134-9023-01	05 - 50216	72
74734	28 - 1995	663				1134-9074-01	15 - 14172	405
74810	05 - 7787	91	SPEEDEX			1134-9082-01	15 - 14172	405
7501000	05 - 6880	93	3926963	12 - 7608	216	1134-9123-01	15 - 14172	405
7502731	07 - 8931	102	3926974	12 - 6845	235	1134-9124-01	15 - 50295	406
7502731YP	07 - 8931	102				1134-9125-01	15 - 50296	406
75115	05 - 5951	94	SPIRIT II			1621-0050-01	15 - 11643	335
75622	31 - 10772	1071	A48K	12 - 5083	212	329-496-185-00	03 - 10219	67
75622	31 - 5933	1071				9990-1020-19	17 - 50205	436
75671	31 - 10771	1071	STEINER			STIHL		
75671	31 - 3319	1071	31-061	31 - 9659	1066	0000-120 1654	27 - 13160	495
75707	13 - 8588	264	81-8041	12 - 5077	212	0000-190 3400	25 - 12541	605
76-380	42 - 7097	1231	81-A-040	12 - 7485	215	0000-195-7200	39 - 9633	1216
7600109	05 - 6880	93	81-A040	12 - 7485	215	0000-350-0510	39 - 7083	518
7600135	05 - 10169	93	81A035	12 - 5070	212	0000-350-0520	39 - 7081	518
7600179	10 - 9510	163	81A038	12 - 5072	212	0000-350-3500	38 - 10091	500
7600179YP	10 - 9510	163	81A039	12 - 5074	212	0000-350-3500	38 - 7298	500
7600180	10 - 9511	163	81A041	12 - 5076	212	0000-350-3502	38 - 9139	502
7600180YP	10 - 9511	163	81A042	12 - 5077	212	0000-350-6202	20 - 14292	509
76085	12 - 7480	215	81A38	12 - 5073	212	0000-400-1300	31 - 9358	1078
76398	13 - 2185	272	81A40	12 - 7485	215	0000-400-1306	31 - 12220	1078
76400	10 - 2243	156	81A59	12 - 5094	212	0000-930-2803	20 - 12847	520
76514	09 - 5713	147	A40	12 - 5075	212	0000-955-0801	39 - 4796	48
76520	13 - 12891	281	A47	12 - 7492	215	0000-961-5116	39 - 9634	1216
77288	19 - 12864	450				0000-989-0516	20 - 12847	520
79369	15 - 6185	400	STIGA			00001404402	27 - 13160	495
79388	15 - 6426	322	1111-1530	15 - 50030	406	00009375004	20 - 12847	520
79388	15 - 6035	401	1111-2598-01	15 - 50246	406	0812-370-1145	32 - 9062	1101
9-0223	15 - 909	405	1111-2759-01	15 - 50247	405	08123701000	32 - 9062	1101
9-0228	15 - 909	405	1111-9003-01	15 - 50150	405	1106-190-0600	37 - 3034	1181
9-0391	15 - 909	405	1111-9109-01	15 - 10739	406	1106-640-3600	39 - 7770	1207
9-0392	17 - 8453	433	1134-0051-05	10 - 9541	175	1107-191-1200	32 - 12614	1090
9-0509	17 - 8455	433	1134-0323-00	17 - 50204	431	1107-350-0500	39 - 7772	1207
9-0559	17 - 8454	433	1134-0456-00	15 - 50026	405	1108-020-1220	39 - 7055	1211
91297	15 - 909	405	1134-1242-02	10 - 50212	171	1108-029-2300	39 - 7686	1212
91550	41 - 916	1221	1134-1322-01	10 - 50213	171	1108-030-0402	39 - 7876	1208
919098	31 - 9660	1066	1134-1452-01	15 - 50027	405	1108-034-3001	39 - 9925	1211
92062	10 - 8448	178	1134-1875-01	09 - 9109	145	1108-160-2002	39 - 7296	1217
923408	31 - 9658	1066	1134-1903-00	15 - 50007	405	11080300403	39 - 7876	1208
976353	12 - 7631	216	1134-2082-01	17 - 50203	431	1110-029-2300	39 - 7689	1212
976497	12 - 7589	216	1134-2450-01	15 - 50061	405	1110-140-0613	39 - 7297	444
976498	12 - 7581	216	1134-2946-01	31 - 3319	1071	1110-358-1800	38 - 3904	48
MXV4260	12 - 5078	212	1134-2946-02	31 - 50239	1072	1110-664-1500	39 - 7773	1214
			1134-3043-01	13 - 50261	292	1110-664-2400	39 - 7767	1215
SOUTHERN STATES			1134-3053-01	13 - 10152	37	1111-020-1200	39 - 8401	1211
754-325	12 - 7500	215	1134-3767-01	10 - 9696	199	1111-195-1600	37 - 3026	633
			1134-3767-02	10 - 9721	199	1113-195-1600	37 - 3044	1181
SOUTHLAND			1134-3841-02	10 - 9722	199	1114-190-0600	37 - 3024	633
HW677	12 - 5176	213	1134-4093-01	31 - 10710	1062			

O.E.M. REPLACEMENT CROSS REFERENCE



CROSS REFERENCE 2014

OEM #	Our #	Page #	OEM #	Our #	Page #	OEM #	Our #	Page #
STIHL			STIHL			STIHL		
1115-034-3001	39 - 9926	1211	1123-195-0400	39 - 11579	1217	4119-180-1101	27 - 12501	76
1115-350-3503	38 - 7298	500	1123-358-7701	38 - 14257	520	4126-195-1600	26 - 8069	633
11150343010	39 - 9926	1211	1123-358-7702	38 - 14257	520	4126-350-0501C	20 - 7883	517
1116-195-1600	37 - 3045	1181	1123-790-9900	39 - 11582	1218	4126-350-501C	20 - 7883	517
1117-190-0601	26 - 2445	633	1123-791-2800	39 - 11581	1218	4126-642-7600	27 - 14071	426
1117-195-0402	39 - 9636	1216	1123-791-2805	39 - 11583	1218	4128-180-1104	27 - 12500	76
1117-195-7200	39 - 7872	1216	11231201613	39 - 12306	494	41281801112	27 - 12500	76
1117-350-0500	39 - 7299	518	1124-195-7200	39 - 11584	1216	41283500504	20 - 7883	517
1117-350-0500	39 - 7081	518	1124-358-7700	38 - 14277	520	4130-160-2000	27 - 9625	660
1117-350-0510	39 - 7295	518	1125-020-1213	39 - 9642	1210	4130-195-0400	26 - 9781	611
1117-350-0520	39 - 7299	518	1125-034-3001	39 - 9923	1210	4130-195-1600	26 - 13581	633
1117-640-3600	39 - 7083	518	1125-080-2105	26 - 13562	625	4130-195-7200	26 - 9780	611
1117-640-3600	39 - 7295	518	1125-195-0400	39 - 7067	1216	4130-350-6200	20 - 11510	51
11170071014	39 - 7872	1216	1125-195-0401	39 - 7067	1216	41304001250	26 - 9780	611
1118-020-1202	39 - 7057	1211	1125-195-7200	39 - 9633	1216	4133-124-1500	27 - 8716	493
1118-020-1203	39 - 7057	1211	11250201215	39 - 9642	1210	4133-195 1600	26 - 12914	633
1118-034-3001	39 - 9927	1211	1127 080 2103	26 - 13612	625	4133-350-0501	20 - 7883	517
1118-120-1611	39 - 5834	493	1127 080 2103A	26 - 13612	625	4133-713-4101	16 - 6477	421
1118-120-1615	39 - 5834	493	1127 120 1621	39 - 12305	494	4134-141-0300	27 - 11659	493
1118-182-0900	39 - 7775	1212	1127-358-7702	38 - 13171	520	4137-020-1202	39 - 14114	1212
1118-190-0600	37 - 3068	1181	11270343007	39 - 9929	1211	4137-124-1500	27 - 11806	493
1118-195-7200	39 - 7871	1216	11273587703	38 - 13171	520	4137-124-2800	27 - 11807	493
1118-664-1600	39 - 7771	1214	1128-080 2104	26 - 13561	625	4137-180-1100	27 - 12504	76
1118-790-9930	39 - 7085	1217	1128-195-0400	39 - 9635	1217	4137-180-1109	27 - 12503	76
1119-007-1005	39 - 7300	444	1129-007-1062	38 - 14654	1200	4137-190-4000	26 - 14340	624
1119-007-1027	39 - 7300	444	1129-190-0600	37 - 3080	1181	41371901100	26 - 12914	633
1119-007-1062	38 - 13485	1191	11291900601	37 - 3080	1181	4140-124-2800	27 - 13553	495
1119-020-1202	39 - 11056	1211	1130-124-0800	39 - 11580	494	41401242800	27 - 13553	495
1119-020-1204	39 - 13617	1212	1130-350-6200	20 - 12997	509	41401602000	27 - 9625	660
1119-030-0400	39 - 8686	1208	1135 020 1202	39 - 13618	1212	4144-350-0502	20 - 7882	517
1119-120-1615	39 - 5837	493	127-034-3006	39 - 9924	1210	4180-007-1060	38 - 14653	1200
1119-358-7700	38 - 5831	519	16-26-N4-HC	35 - 12538	1171	4180-120-1800	27 - 14085	495
1119-358-7701	38 - 5831	519	3005-000-3905	35 - 13544	1148	4180-120-1800B	27 - 14085	495
1120-120-1600	39 - 11587	494	3005-000-3909	35 - 13546	1148	4180-180-1101	27 - 12499	76
1121-007-1037	36 - 14276	1177	3005-000-4717	35 - 13186	1171	4180-190-4000	26 - 13582	625
1121-020-09	39 - 9641	1210	4001-713-3801	27 - 7855	425	41801801151	27 - 12499	76
1121-034-3010	39 - 9922	1210	4002-713-3017	27 - 14500	645	4201-020-1200	39 - 7059	1211
1121-195-3400	25 - 7301	605	4002-713-9708	27 - 14501	645	4201-034-3000	39 - 9929	1211
1121-430-0200	39 - 7777	1070	4003-713-8301	27 - 14577	645	4201-140-1801	39 - 5906	494
1121-640-2004	36 - 14276	1177	4111-007-1001	27 - 7141	648	4201-140-1802	39 - 8283	494
1121-790-9906	39 - 7087	1217	4111-710-8700	27 - 9043	655	4201-140-1805	27 - 7997	492
1121-790-9909	39 - 7087	1217	4112-124-0801	27 - 7207	493	4201-141-0300	39 - 3116	494
1121-790-9909	39 - 11586	1218	4112-195-1600	26 - 2444	633	4201-141-0310	39 - 5907	494
1121-790-9911	39 - 7086	1217	4112-350-3500	27 - 7159	498	4203-120-1500	27 - 13159	493
1121-790-9912	39 - 7086	1217	4112-713-3801	19 - 7785	471	4203-141-0300	27 - 7997	492
1121-790-9912	39 - 11585	1218	4113-713-4101	16 - 6107	421	4203-141-0301	27 - 10963	493
1122-080-2110	26 - 13560	625	4114-124-0800	39 - 6986	493	4203-141-0310	27 - 9928	492
1122-190-3400	25 - 13098	605	4114-350-0502	20 - 7882	517	4203-190-0405	26 - 13580	625
1122-195-0400	39 - 7068	1216	4114-350-0504	20 - 7882	517	4203-701-6102	27 - 8791	661
1122-400-1314	31 - 14041	1078	4114-358-7000	38 - 7294	518	4205-020-1200	39 - 12267	1210
1122-647-9400	38 - 14278	520	4114-358-7300	38 - 7294	518	4221-007-1002	39 - 12573	495
1123-120 1612	39 - 12306	494	4116-195 7200	39 - 12717	1216	4221-020-1201	39 - 12266	1210
1123-195-0400	33 - 11759	1130	4116-195-7200	39 - 9633	1216	4221-140-1800	39 - 12570	495



O.E.M. REPLACEMENT CROSS REFERENCE

2014 CROSS REFERENCE

OEM #	Our #	Page #	OEM #	Our #	Page #	OEM #	Our #	Page #
STIHL			TECUMSEH			TECUMSEH		
4221-140-4400	39 - 12571	495	26750A	23 - 3651	583	30727	19 - 1390	479
4221-141-0310	39 - 12572	495	26754	23 - 1501	579	30804	19 - 1384	473
4223-020-1200	39 - 9643	1210	26754A	23 - 1501	579	30874	18 - 1270	34
4223-030-0400	39 - 9645	1208	26756	23 - 3551	579	30884	23 - 1437	586
4223-140-1800	19 - 9776	492	27106	22 - 9558	533	30911	18 - 1270	34
4223-141-0300	19 - 9608	492	27109	23 - 3540	578	30911	18 - 2294	438
4223-141-0600	19 - 9609	492	27136A	22 - 1543	532	30963B	23 - 1528	566
4223-190 0401	26 - 13628	626	27181A	18 - 1274	443	31287	18 - 2296	438
4224 141 0300A	39 - 12561	494	27181B	18 - 1274	443	31287	18 - 12296	438
4226-120-0600	22 - 11150	549	27181C	18 - 1274	443	31361	22 - 183	532
4229-120-1800	27 - 14258	495	27234	23 - 2736	581	31380C	23 - 6768	566
4238 020 1202	39 - 12731	1211	27234A	23 - 2736	581	31386	22 - 189	532
4238 140 4402	39 - 12716	494	27272	23 - 3552	579	31390	22 - 1409	544
4238-190-0300	26 - 13591	625	27272A	23 - 3552	579	31506	18 - 2296	438
4238-190-0301	26 - 13591	625	27565	23 - 1458	562	31506	18 - 12296	438
4238-190-0402B	26 - 13591	625	27674	18 - 1270	34	31619A	23 - 2738	581
42381900302	26 - 13591	625	27677	23 - 3650	583	31688A	23 - 1522	579
4282 141 0300B	27 - 12081	492	27677A	23 - 3650	583	31700	19 - 1381	480
4282 190 0600	37 - 13055	1181	27803	20 - 1347	34	31797B	23 - 6734	565
4282-180-1100	27 - 12502	76	27876B	23 - 2712	556	31840	22 - 1408	542
4282-190-0300A	26 - 13529	625	27889	23 - 1459	562	31925	19 - 1385	474
4314 121 4700	38 - 14348	1199	27896	23 - 2737	581	31950	23 - 8561	556
503-08-97-021	39 - 11588	1215	27896A	23 - 2737	581	31958A	23 - 7793	581
9220-260-1100	39 - 7769	48	27897	23 - 2715	556	31987	18 - 2296	438
9220-260-1300	39 - 7768	48	27902	23 - 1437	586	31987	18 - 12296	438
9490 000 7900	12 - 13117	257	27915	23 - 3550	579	32001C	23 - 6736	565
9771-021-2580	39 - 7776	1212	27915A	23 - 3550	579	32004	23 - 6777	562
			27930A	23 - 3553	578	32008	19 - 1386	470
			28396	18 - 1270	34	32043	18 - 2296	438
SWEEPSTER			28427	23 - 2716	556	32043	18 - 12296	438
06-0165	12 - 5070	212	28938C	23 - 1491	570	32043A	18 - 2296	438
			28986	23 - 1456	562	32043A	18 - 1277	439
SWISHER			29155	22 - 1409	544	32043A	18 - 12296	438
6102NC	20 - 8936	513	29183	23 - 1444	556	32043B	18 - 2296	438
688EC	10 - 9911	164	29313C	23 - 1518	568	32043B	18 - 1277	439
			29314B	23 - 1519	568	32080	31 - 1781	1077
TANAKA			29314C	23 - 1519	568	32182A	20 - 13038	509
410-00700-911	27 - 8080	495	29633	18 - 1279	444	32184	20 - 13038	509
410-00731-900	27 - 8080	495	29683	20 - 1347	34	32238B	23 - 6732	565
442-25143-800	20 - 11510	51	29780011	26 - 13101	610	32241	23 - 6775	562
595-01320-930	20 - 8527	518	29953C	23 - 1489	570	32355	19 - 6849	481
595-0165C-91	20 - 8526	518	29961	19 - 1382	480	32401	18 - 2282	443
595-05024-90	20 - 8527	518	30081	23 - 2743	578	32450B	26 - 13643	621
595-0650-A-90	20 - 8526	518	30081A	23 - 2743	578	32544	23 - 3555	579
754-0192	12 - 5067	212	30188	23 - 1449	579	32591C	23 - 6769	566
779-00601-204	26 - 2438	633	30356	23 - 3541	578	32595	23 - 1462	558
785-10207-201	25 - 7410	606	30359	22 - 1409	544	32600	23 - 2711	556
785-51020-7900	25 - 7410	606	30546	31 - 1884	1078	32630	23 - 2713	556
870-33341-900	27 - 7411	75	30547A	31 - 6781	1075	32643A	23 - 13522	570
			30548B	31 - 6781	1075	32649A	23 - 1449	579
TECUMSEH			30560A	31 - 1884	1078	32760A	23 - 7799	579
00632047A	20 - 8751	51	30667	23 - 3652	583	32793	23 - 3532	583
23120003	20 - 13038	509	30684	23 - 3653	583	32796	19 - 1394	479
25492	23 - 1441	556						

O.E.M. REPLACEMENT CROSS REFERENCE



CROSS REFERENCE 2014

OEM #	Our #	Page #	OEM #	Our #	Page #	OEM #	Our #	Page #
TECUMSEH			TECUMSEH			TECUMSEH		
32875	23 - 6767	566	34041B	23 - 2762	570	36262	19 - 12864	450
32875A	23 - 6767	566	34185B	18 - 2283	444	36262	19 - 6929	483
32875B	23 - 6767	566	34340	19 - 2842	481	36262	19 - 12861	450
32972	19 - 1395	479	34443	31 - 8693	1078	36344A	31 - 14315	1077
32985	18 - 12296	438	34443A	31 - 8693	1078	36356	19 - 7732	480
32985	18 - 2296	438	34443C	31 - 8693	1078	36357	19 - 7746	480
33006	19 - 1393	480	34443D	31 - 8693	1078	36443	23 - 2760	570
33015	23 - 2760	570	34503	23 - 6734	565	36473	18 - 8282	443
33015A	23 - 2760	570	34508	23 - 6736	565	36473A	18 - 8282	443
33032	20 - 1350	514	34511	23 - 6732	565	36563	19 - 6929	483
33234A	23 - 2757	574	34531	23 - 6734	565	36563	19 - 12861	450
33234B	23 - 2757	574	34700B	19 - 9533	478	36680	26 - 9979	620
33238D	23 - 1474	574	34782	19 - 6515	479	36745	19 - 8785	479
33238E	23 - 1474	574	34782A	19 - 6515	479	36795	26 - 9980	620
33253	23 - 3531	583	34782B	19 - 6515	479	36853	26 - 9981	620
33253A	23 - 3531	583	34783	19 - 6553	479	36853	26 - 13336	620
33263	23 - 3554	579	34854	23 - 1460	562	36905	19 - 12953	449
33268	19 - 2775	479	34910	19 - 2783	480	36905	19 - 9200	478
33270	23 - 2762	570	34923A	23 - 2762	570	36914	26 - 9981	620
33279G	23 - 2745	574	35056	18 - 12493	443	36959	26 - 11022	628
33279J	23 - 2745	574	35062	31 - 13278	1069	36961	19 - 6929	483
33279L	23 - 2745	574	35066	19 - 14188	479	36961	19 - 12861	450
33280	18 - 2283	444	35066	19 - 12934	449	37050	26 - 12726	627
33280A	18 - 2283	444	35066	19 - 12784	479	37052A	26 - 12726	627
33290D	26 - 10975	621	35066	19 - 2784	479	37130	23 - 3651	583
33290E	26 - 10975	621	35102	19 - 2798	478	37284	26 - 14511	620
33290F	26 - 10975	621	35103	19 - 2799	478	37342	23 - 3531	583
33315	23 - 1460	562	35135	31 - 8692	1078	373600	19 - 11473	478
33328D	26 - 10976	621	35135A	31 - 8692	1078	37425	26 - 9981	620
33328E	26 - 10976	621	35135B	31 - 8692	1078	37442	26 - 11022	628
33329D	26 - 10982	621	35261	23 - 3651	583	37609	23 - 3651	583
33329E	26 - 10982	621	35262	23 - 3531	583	37844	20 - 12055	514
33329F	26 - 10982	621	35262A	23 - 3531	583	37845	20 - 8285	514
33554	23 - 2760	570	35355	20 - 8285	514	37845	20 - 12056	514
33554A	23 - 2760	570	35403	19 - 2829	478	410144B	20 - 1350	514
33631	19 - 1392	480	35404	19 - 5862	478	410245	38 - 4995	48
33652	18 - 1270	34	35435	19 - 6847	479	410263	38 - 4995	48
33652	18 - 2294	438	35500	19 - 5940	478	4151921	31 - 1781	1077
33670A	23 - 7801	578	35603	18 - 8282	443	430173	20 - 1502	505
33679	20 - 7730	510	35603A	18 - 8282	443	450247	19 - 2839	478
33697	18 - 2284	444	35604	19 - 6848	481	570442A	20 - 13038	509
33697A	18 - 2284	444	35705	19 - 5955	478	570629A	20 - 13038	509
33712	26 - 9221	629	35763	26 - 9979	620	570629B	20 - 13038	509
33735	23 - 7800	579	35771	18 - 2284	444	590387	25 - 6780	606
33740F	23 - 13521	574	35771A	18 - 2284	444	590387A	25 - 6780	606
33751A	23 - 7798	579	35857	20 - 9294	511	590413A	26 - 13100	610
33835	26 - 9990	620	35865	23 - 3553	578	590414	26 - 1329	629
33844	26 - 13338	620	35865	23 - 7801	578	590420A	26 - 1325	626
33848	26 - 9220	629	35899	26 - 11022	628	590433	26 - 1334	629
33861	23 - 3554	579	35974	19 - 9795	479	590487	26 - 2430	629
33896	19 - 1383	480	36045	20 - 9289	51	590562	26 - 9534	629
34041	23 - 2762	570	36045A	20 - 9289	51	590574	25 - 7723	604
34041A	23 - 2762	570	36046	19 - 8330	480	590618A	26 - 13101	610



O.E.M. REPLACEMENT CROSS REFERENCE

2014 CROSS REFERENCE

OEM #	Our #	Page #	OEM #	Our #	Page #	OEM #	Our #	Page #
TECUMSEH			TECUMSEH			TILLOTSON		
590621	26 - 10983	626	632795A	22 - 13149	550	16B-248	38 - 3662	50
590686	26 - 10983	626	632802	22 - 10053	533	16B-274	38 - 8129	50
590694	26 - 10983	626	632816	22 - 10053	533	16B-276	38 - 8133	50
590706	26 - 1325	626	640017B	22 - 13150	550	179-59	38 - 8160	51
590737	26 - 10983	626	640020B	22 - 13151	551	179-60	38 - 8161	51
590739	26 - 12655	626	640025C	22 - 13152	551	179-62	38 - 8157	51
590742	26 - 12654	626	640052	22 - 14110	551	237-137	38 - 1553	1189
590746	26 - 12656	626	640054	22 - 14110	551	237-143	38 - 8154	51
590748A	26 - 12656	626	640065A	22 - 13153	551	237-144	38 - 3658	51
590749	26 - 12657	626	640084B	22 - 13141	551	237-153	38 - 3661	51
590749A	26 - 12657	626	640152A	22 - 13154	551	237-600	38 - 1552	1189
590785	26 - 10983	626	640260A	22 - 13155	551	237-604	38 - 8155	51
590787	26 - 12654	626	640260B	22 - 13155	551	237-653	38 - 3654	51
590788	26 - 12656	626	640271	22 - 13566	550	34-216	38 - 3655	47
590789	26 - 12657	626	640303	22 - 13566	550	95-172	38 - 1399	48
610951	23 - 1439	586	640330A	22 - 13142	551	95-177	38 - 8159	51
610961	23 - 1440	586	640349	22 - 14110	551	95-182	38 - 1400	48
610995	23 - 8955	586	640350	22 - 13566	550	95-197	38 - 4918	1189
611004	23 - 8953	586	650886	19 - 7778	453	DG-2HU	38 - 3667	1191
611154	23 - 11812	586	651071	26 - 10364	620	DG-5HS	38 - 1544	1191
630740	02 - 145	43	670103	32 - 9102	1099	DG-5HT	38 - 1544	1191
630740	02 - 146	43	670169	32 - 9103	1099	OW-497	38 - 3902	48
630932	22 - 1430	538	730228A	33 - 11589	1129	OW-802	38 - 3903	48
630932A	22 - 1430	538	730326	26 - 9981	620	OW-802	38 - 13903	501
630978	22 - 1427	528	780086A	09 - 8656	135	RK-14HU	38 - 4183	1191
631021	22 - 1434	538	786201	31 - 13349	1062	RK-23HS	38 - 3644	1191
631021A	22 - 1434	538	790006	42 - 7158	1231	RK-32HK	38 - 4911	1191
631021B	22 - 12263	538	799021	42 - 7158	1231			
631021B	22 - 1434	538	ST105007	18 - 2294	438	TILTON		
631028	23 - 3539	578	ST105106	18 - 2296	438	00570003	39 - 13617	1212
631028A	23 - 3539	578	ST105106	18 - 2296	438	00570004	39 - 13618	1212
631029	22 - 10103	544	ST435823	26 - 9221	629			
631584	22 - 10947	542	ST445015	23 - 1437	586	TORCH		
631700	22 - 8591	533	ST470427	23 - 3652	583	5580	24 - 7220	589
631782	22 - 10948	542	ST495002	23 - 1441	556	5580	24 - 7189	592
631839	22 - 10947	542	ST500058	23 - 1462	558	5580	24 - 2538	595
631867	22 - 8926	533	ST500306	23 - 1456	562	5580	24 - 12553	598
631893	22 - 1411	544	ST510218	23 - 6768	566	A4RTF	24 - 9538	592
631893A	22 - 1411	544	ST510222	23 - 6769	566	A4RTF	24 - 12650	592
631935A	20 - 9217	508	ST520304	22 - 1409	544	A6RTC	24 - 12546	598
631937A	20 - 9216	508	ST750109	32 - 9102	1099	A6TC	24 - 12234	597
631978	22 - 13103	542	ZZF1	38 - 4995	48	A7TC	24 - 12234	597
632019	22 - 9971	534				A8RTC	24 - 10188	596
632019A	22 - 9971	534	TILLOTSON			A8TC	24 - 7150	591
632047	20 - 8751	51	155A-26	38 - 3668	51	A8TC	24 - 10370	596
632047A	20 - 8751	51	155A-29	38 - 8113	51	A8TC	24 - 7153	589
632230	22 - 13146	550	16B-206	38 - 1555	50	A8TC	24 - 2536	594
632334A	22 - 13143	551	16B-216	38 - 8131	50	C7E	24 - 10988	597
632347	22 - 13128	542	16B-226	38 - 3657	51	C7ER	24 - 10995	597
632547	02 - 145	43	16B-227	38 - 3659	51	CR7E	24 - 10988	597
632615	22 - 13147	550	16B-228	38 - 3656	50	D7CA	24 - 10994	597
632671C	22 - 13148	550	16B-246	38 - 3663	51	D7CA	24 - 10990	597
632694A	20 - 9807	51	16B-247	38 - 3664	51	D7CA	24 - 10991	597

O.E.M. REPLACEMENT CROSS REFERENCE



CROSS REFERENCE 2014

OEM #	Our #	Page #	OEM #	Our #	Page #	OEM #	Our #	Page #
TORCH			TORCH			TORO/WHEEL HORSE		
D7RC	24 - 10990	597	GL4	24 - 6595	589	10-0200	15 - 1108	407
D7RC	24 - 10991	597	GL4	24 - 2505	591	10-0230	12 - 7483	215
D7RC	24 - 10994	597	K4RTC3	24 - 14559	594	10-1137	12 - 7532	215
DK7RTC	24 - 10992	597	K5RF11	24 - 14559	594	10-1142	12 - 7625	216
E4RTC	24 - 10997	597	K5RTC	24 - 13039	596	10-1426	12 - 7495	215
E4TC	24 - 5858	595	K5RTC	24 - 6933	593	10-2119	03 - 9135	66
E4TC	24 - 7231	589	K6RF	24 - 11523	597	10-2465	12 - 5004	211
E6C	24 - 7153	589	K6RF11	24 - 11523	597	10-2607	12 - 7532	215
E6C	24 - 2536	594	K6RTC11	24 - 11523	597	10-2742	12 - 7171	241
E6C	24 - 7150	591	K6TC	24 - 11523	597	10-2743	12 - 7612	216
E6RC	24 - 7153	589	L6C	24 - 2543	589	10-3084	12 - 7579	216
E6RTC	24 - 12984	595	L6C	24 - 1295	594	10-3119	10 - 3309	182
E7RTC	24 - 10989	597	L6C	24 - 12542	598	10-3345	12 - 7430	214
E8C	24 - 7186	591	L6C	24 - 2504	591	10-3345	12 - 5008	211
E8C	24 - 2552	594	L6RC	24 - 2537	595	10-3494	12 - 7491	215
F5RF	24 - 7220	589	L6RC	24 - 12554	598	10-3522	12 - 7528	215
F5RF	24 - 7189	592	L6RTC	24 - 10176	595	10-3990	31 - 1931	1061
F5RF	24 - 2538	595	L6RTC	24 - 7190	591	10-3991	31 - 7280	1062
F5RF	24 - 12553	598	L6TC	24 - 2501	595	10-4047	20 - 7730	510
F5RTC	24 - 2538	595	L6TC	24 - 2548	590	10-4290	12 - 7434	214
F5RTC	24 - 12553	598	L6TC	24 - 7148	591	10-4388	12 - 7498	215
F5RTC	24 - 7189	592	L6TC	24 - 12546	598	10-4496	12 - 7480	215
F5RTC	24 - 7220	589	L7RTC	24 - 5850	595	10-4633	12 - 7479	215
F5TC	24 - 7311	590	L7RTC	24 - 8883	591	10-4865	12 - 7498	215
F5TC	24 - 2534	595	L7RTC	24 - 12552	598	10-4974	13 - 8829	292
F5TC	24 - 12543	598	L7TC	24 - 7191	589	10-4975	13 - 8373	264
F6RTC	24 - 2539	595	L7TC	24 - 2533	595	10-5476	12 - 7523	215
F6RTC	24 - 7188	592	L7TC	24 - 8882	591	10-5477	12 - 7483	215
F6RTC	24 - 12550	598	L7TC	24 - 2513	591	10-5874	13 - 721	36
F6TC	24 - 12547	598	L7TC	24 - 12545	598	10-6390	12 - 7479	215
F6TC	24 - 2519	595	N6C	24 - 1289	594	10-6496	12 - 7630	216
F6TC	24 - 7230	590	N6C	24 - 2547	589	10-6497	12 - 7629	216
F6TC	24 - 7149	591	N6RTC	24 - 10950	595	10-6516	12 - 7526	215
F7RTC	24 - 2539	595	N6TC	24 - 8496	591	10-6518	12 - 7530	215
F7RTC	24 - 12550	598	N6TC	24 - 6835	589	10-6523	12 - 7484	215
F7RTC	24 - 7188	592	N7C	24 - 2512	591	10-6533	12 - 7483	215
F7TC	24 - 12550	598	N7C	24 - 2503	595	10-6635	15 - 851	407
F7TC	24 - 7188	592	P5RTC	24 - 5857	596	10-6637	15 - 2001	408
F7TC	24 - 2539	595	Q5RTC	24 - 7222	589	10-6689	12 - 7498	215
F8C	24 - 11305	594	Q5RTC	24 - 6935	592	10-6751	12 - 7524	215
F8RC	24 - 2553	596	Q6RTC	24 - 5851	596	10-6945	20 - 7172	515
F8RC	24 - 7232	590	T1137C	24 - 12234	597	10-7120	12 - 7607	216
G4C	24 - 7224	589	TK9RTC	24 - 14492	591	10-7230	12 - 7503	215
G4RC	24 - 7224	589				10-7298	12 - 7515	215
G6C	24 - 2506	591	TORO/WHEEL HORSE			10-7320	12 - 7503	215
G6C	24 - 12548	598	1-323500	42 - 14176	1232	10-7636	12 - 7471	215
G6C	24 - 5860	589	1-513648	08 - 9898	109	10-7637	12 - 7531	215
G6C	24 - 2517	594	1-603770	20 - 5841	46	10-7647	12 - 7513	215
G6RC	24 - 8571	592	1-633749	12 - 12916	259	10-7740	12 - 7629	216
G6RC	24 - 10707	596	1-653283	12 - 10253	248	10-7741	12 - 7540	215
GL4	24 - 12544	598	1-653283	12 - 13408	259	10-7769	12 - 5122	212
GL4	24 - 2544	589	10	12 - 7625	216	10-7769	12 - 7532	215
GL4	24 - 1294	594	10-0129	12 - 7596	216	10-7939	12 - 7628	216



O.E.M. REPLACEMENT CROSS REFERENCE

2014 CROSS REFERENCE

OEM #	Our #	Page #	OEM #	Our #	Page #	OEM #	Our #	Page #
TORO/WHEEL HORSE			TORO/WHEEL HORSE			TORO/WHEEL HORSE		
10-8195	12 - 7510	215	105-3471	08 - 13337	115	11-0610	12 - 7630	216
10-8195	12 - 5100	212	105-3630	10 - 11075	167	11-0611	12 - 7637	216
10-8196	12 - 5083	212	105-7718-03	15 - 10667	334	11-0771	18 - 891	438
10-8196	12 - 7493	215	105-7718-03	15 - 6083	344	11-0774	18 - 891	438
10-8335	19 - 6680	484	105-7734	13 - 13639	293	11-1309	06 - 2983	98
10-8427	12 - 7531	215	105-7779	15 - 6410	322	11-1389	06 - 2983	98
10-8427	12 - 5121	212	105-7779-03	15 - 6294	323	11-1435	12 - 7535	215
10-8491	12 - 7510	215	105-7781	15 - 10071	351	11-1560	13 - 2176	263
10-8492	12 - 7500	215	105-7781-03	15 - 10719	351	11-1563	12 - 7493	215
10-8501	12 - 7626	216	105-7790	12 - 12805	258	11-1674	31 - 3319	1071
10-8502	12 - 7628	216	105-877	15 - 6303	324	11-1710	12 - 7496	215
10-8503	12 - 7508	215	105-877-03	15 - 6303	324	11-1720	12 - 7496	215
10-8798	07 - 8201	107	105-8783	12 - 12729	258	11-1730	12 - 7478	215
10-8834	12 - 7541	215	106-0888	03 - 8765	66	11-1740	12 - 7503	215
10-8834	12 - 5130	212	106-2175	13 - 12901	292	11-2084	12 - 7473	215
10-8960	12 - 7531	215	106-2247-03	15 - 13129	323	11-2425	13 - 723	36
10-8971	12 - 7492	215	106-2247-03	15 - 11821	411	11-2426	13 - 722	36
10-9427	12 - 7520	215	106-7350	12 - 12730	258	11-2801	12 - 7628	216
10-9427	12 - 5059	212	106-7369	12 - 12867	258	11-2895	13 - 727	36
10-9428	12 - 7519	215	106-8300	05 - 14620	70	11-3072	12 - 7545	215
10-9640	12 - 7499	215	10610	15 - 851	407	11-3105	12 - 7476	215
10-9680	07 - 282	101	107-1887	21 - 13998	526	11-3141	12 - 7519	215
10-9748	12 - 7632	216	107-3195-03	15 - 6300	322	11-3514	09 - 7162	134
10-9807	12 - 7542	215	107-3196-03	15 - 6300	322	11-3579	15 - 3372	343
10-9842	09 - 484	133	107-3196-03	15 - 3403	347	11-3912	12 - 7487	215
10-9908	12 - 7535	215	107-9161	10 - 14132	199	11-3912	12 - 5077	212
10-9918	15 - 3468	409	108-0954-03	15 - 10928	352	11-4421	12 - 7497	215
10-9956	12 - 7545	215	108-0954-03	15 - 13260	354	11-4433	12 - 7526	215
10-9966	09 - 7210	132	108-2693	12 - 13569	258	11-4567	12 - 7491	215
100-1048	09 - 8507	132	108-2694	12 - 13570	258	11-4718	12 - 7489	215
100-2870	06 - 13403	100	108-2715	12 - 13571	259	11-4860	12 - 7536	215
100-3976	10 - 13009	200	108-2716	12 - 13572	259	11-4895	12 - 7628	216
1023084	12 - 7583	216	108-3762-03	15 - 10928	352	11-6160	12 - 7617	216
102742	12 - 12051	228	108-3811	19 - 9550	459	11-6183	12 - 7596	216
102742	12 - 7546	215	108-6163	21 - 13998	526	11-6511	12 - 7537	215
103-1326	19 - 11865	468	108-9764-03	15 - 12649	323	11-7192	15 - 2000	407
103-2683	05 - 14306	69	108-9764-03	15 - 10929	411	110-0803	13 - 7813	264
1035221	31 - 9657	1064	109-0977	13 - 12297	278	110-1857-03	15 - 11821	411
104-1170	08 - 12913	114	109-6873-03	15 - 11495	351	110-5049	12 - 13573	259
104-1170	08 - 10742	110	109-9126	08 - 10288	110	110-6568-03	15 - 11821	411
104-2541	31 - 11822	1059	109966	09 - 8507	132	110-6569	21 - 13998	526
104-2753	41 - 5532	1225	11-0037	12 - 7622	216	110-6774	12 - 14129	259
104-3096	09 - 7162	134	11-0116	31 - 8943	1071	110-6785	08 - 13421	115
104-3096	09 - 10303	135	11-0116	31 - 5933	1071	110-6837-03	15 - 12362	408
104-6325	09 - 10303	135	11-0141	12 - 7484	215	110-6837-03	15 - 12273	408
104-6325	09 - 7162	134	11-0162	31 - 8943	1071	110-6871	12 - 14130	259
104-8697-03	15 - 10929	411	11-0167	31 - 8943	1071	110-6892	12 - 12672	259
105-0828	13 - 9805	292	11-0364	12 - 7476	215	110-8837	09 - 9944	137
105-1671	10 - 11074	170	11-0420	12 - 7491	215	1101162	31 - 10772	1071
105-1688	10 - 13620	200	11-0506	06 - 5873	100	1101167	31 - 10772	1071
105-1814	07 - 14424	102	11-0513	09 - 328	133	112-0037	07 - 430	106
105-1815	07 - 13492	102	11-0513	09 - 6573	133	112-0302	15 - 1030	340
105-1816	07 - 13491	102	11-0513	09 - 327	39	112-0304	15 - 1029	385

O.E.M. REPLACEMENT CROSS REFERENCE



CROSS REFERENCE 2014

OEM #	Our #	Page #	OEM #	Our #	Page #	OEM #	Our #	Page #
TORO/WHEEL HORSE			TORO/WHEEL HORSE			TORO/WHEEL HORSE		
112-0309	31 - 7935	1072	1555	12 - 5077	212	1596	12 - 5084	212
112-0311	10 - 9286	195	1556	12 - 5053	212	1597	12 - 7430	214
112-0316	15 - 11480	341	1558	12 - 7471	215	1597	12 - 5008	211
112-0317	12 - 6843	233	1559	12 - 7470	215	1598	12 - 5055	212
112-0370	10 - 11962	187	1561	12 - 5063	212	16-1098	12 - 7482	215
112-0423	09 - 8507	132	1561	12 - 7473	215	16-9670	12 - 5073	212
112-0460	10 - 13131	188	1562	12 - 7531	215	1633673	31 - 9657	1064
112-0460	10 - 12219	195	1563	12 - 5072	212	17-0850	12 - 7483	215
112-0677	07 - 6916	106	1563	12 - 7482	215	17-6540	12 - 5077	212
112-0677	07 - 12648	104	1566	12 - 7478	215	17-6540	12 - 7487	215
112-0863	10 - 13360	182	1567	12 - 5062	212	18-1520	20 - 9146	497
112-0884	10 - 12926	195	1567	12 - 7472	215	18-2010	12 - 7441	214
112-0917	10 - 9159	174	1569	12 - 7472	215	18-8450	12 - 7441	214
112-3687	13 - 12891	281	1570	12 - 7512	215	18-8890	12 - 7493	215
112-3687	13 - 2188	263	1571	12 - 7475	215	18-9690	05 - 7920	89
112-5800	12 - 11845	227	1572	12 - 7477	215	18-9697	05 - 7920	89
112-6063	10 - 13631	195	1573	12 - 7473	215	19-2220	12 - 7487	215
112-9759	15 - 12362	408	1573	12 - 5063	212	19-2220	12 - 5077	212
112-9759-03	15 - 12273	408	1574	12 - 5066	212	19-2650	12 - 5070	212
112947	15 - 9171	409	1574	12 - 7476	215	19-2790	12 - 7484	215
115-4971	12 - 14318	259	1575	12 - 7469	215	19-2790	12 - 5074	212
115-9613	12 - 14319	259	1576	12 - 5103	212	19-2792	12 - 7484	215
116-0050	31 - 14454	1062	1576	12 - 7513	215	19-6950	12 - 7478	215
116277	10 - 11070	170	1577	12 - 7471	215	19-6960	12 - 7478	215
117-1018	12 - 10306	223	1577	12 - 5061	212	19-6960	12 - 5068	212
117-1192	10 - 14122	199	1578	12 - 7442	214	19-7050	12 - 7496	215
117-2221	31 - 14652	1062	1578	12 - 5020	211	19-7050	12 - 5086	212
117-7386	08 - 13422	115	1578P	12 - 5020	211	19-7420	12 - 7503	215
12-1000	12 - 7519	215	1579	12 - 7467	215	19-7420	12 - 5093	212
12-1519	08 - 3277	115	1579	12 - 5057	212	19-7430	12 - 7496	215
12-2650	12 - 7601	216	1580	12 - 5064	212	19-7430	12 - 5086	212
12-5820	13 - 729	36	1580	12 - 7474	215	2-1950	12 - 7440	214
12-6220	12 - 5066	212	1581	12 - 7450	214	2-4463	13 - 722	36
12-6220	12 - 7486	215	1582	12 - 7517	215	2-4663	12 - 7526	215
12-6420	12 - 7484	215	1583	12 - 7436	214	2-7139	12 - 7488	215
12-6430	12 - 7490	215	1584	12 - 5178	213	2-9319	18 - 1282	444
12-6430	12 - 5079	212	1585	12 - 7519	215	20-0170	12 - 7496	215
12-6550	12 - 7497	215	1585	12 - 5109	212	20-1820	12 - 5072	212
12-6550	12 - 5087	212	1586	12 - 7519	215	20-1820	12 - 7482	215
12-8260	12 - 7488	215	1586	12 - 5109	212	20-2720	15 - 1006	410
12-8410	12 - 7630	216	1587	12 - 7486	215	20-5990	12 - 7455	214
13-2640	12 - 7631	216	1587	12 - 5076	212	20-7159	12 - 7437	214
14-4879	15 - 6267	407	1588	12 - 7502	215	20-8527	12 - 7491	215
14-7799	15 - 6184	409	1589	12 - 7500	215	21-0890	12 - 7617	216
14-9419	15 - 6256	410	1590	12 - 7448	214	21-1810	12 - 7488	215
1526	12 - 5055	212	1591	12 - 7453	214	22-4230	12 - 7574	216
1550	12 - 7484	215	1592	12 - 7525	215	22-5187	12 - 7482	215
1552	12 - 7480	215	1592	12 - 5115	212	22-5282	12 - 7484	215
1552	12 - 5070	212	1593	12 - 5018	211	22-5360	12 - 7506	215
1553	12 - 7479	215	1593	12 - 7440	214	22-5385	12 - 7495	215
1554	12 - 7467	215	1595	12 - 7510	215	23-0080	12 - 7483	215
1554	12 - 5057	212	1595	12 - 5100	212	23-0220	12 - 7442	214
1555	12 - 7487	215	1596	12 - 7494	215	23-0660	31 - 2922	1062



O.E.M. REPLACEMENT CROSS REFERENCE

2014 CROSS REFERENCE

OEM #	Our #	Page #	OEM #	Our #	Page #	OEM #	Our #	Page #
TORO/WHEEL HORSE			TORO/WHEEL HORSE			TORO/WHEEL HORSE		
23-3170	41 - 5515	1224	27-4630	12 - 7472	215	28-4210	31 - 8943	1071
23-3730	41 - 5509	1225	27-7110	19 - 8328	474	28-4250	31 - 8910	1059
23-9080	12 - 5073	212	271-10	12 - 7576	216	28-5250	12 - 7496	215
23-9080	12 - 7483	215	271-100	12 - 7493	215	28-5250	12 - 5167	213
24-5660	12 - 7482	215	271-101	12 - 7591	216	28-8630	12 - 7477	215
24-8940	12 - 7438	214	271-102	12 - 7630	216	28-8630	12 - 5067	212
24-9730	12 - 5019	211	271-104	12 - 7481	215	28-9110	26 - 13037	610
24-9730	12 - 7441	214	271-104	12 - 5071	212	28-9290	09 - 8476	148
25-0105	12 - 7483	215	271-11	12 - 7579	216	29-4650	12 - 7484	215
25-0105	12 - 5073	212	271-12	12 - 7582	216	29-5530	15 - 3362	411
25-0106	12 - 7451	214	271-13	12 - 7471	215	29-5560	31 - 7976	1063
25-1210	09 - 6573	133	271-15	12 - 7479	215	3-0302	12 - 7624	216
25-1210	09 - 327	39	271-16	12 - 5053	212	3-1182	12 - 5013	211
25-5880	13 - 2193	264	271-17	12 - 5054	212	3-1182	12 - 7435	214
25-6430	12 - 7952	241	271-29	12 - 7468	215	3-1183	12 - 5000	211
25-8340	12 - 7438	214	271-3	12 - 7467	215	3-1560	12 - 7493	215
25-9850	12 - 7493	215	271-33	12 - 7474	215	3-1662	12 - 7466	215
251-207	09 - 487	133	271-34	12 - 7574	216	3-1663	12 - 7432	214
251-224	09 - 10264	134	271-39	12 - 7493	215	3-2251	12 - 7470	215
251-257	09 - 10303	135	271-4	12 - 7473	215	3-2451	12 - 7473	215
251-257	09 - 7162	134	271-40	12 - 7472	215	3-2604	12 - 7478	215
251-277	09 - 8507	132	271-42	12 - 7482	215	3-2733	12 - 7468	215
251-297	09 - 442	134	271-43	12 - 7466	215	3-4058	12 - 7473	215
251-299	09 - 6534	135	271-44	12 - 7575	216	3-4243	13 - 728	36
251-318	09 - 442	134	271-5	12 - 7478	215	3-4244	13 - 719	36
251-339	09 - 10303	135	271-50	12 - 7578	216	3-4577	12 - 7490	215
251-339	09 - 7162	134	271-56	12 - 7477	215	3-4663	12 - 7433	214
251-342	09 - 10303	135	271-57	12 - 7430	214	3-4733	12 - 7604	216
251-342	09 - 7162	134	271-58	12 - 7477	215	3-5377	12 - 7482	215
251-82	09 - 10303	135	271-59	12 - 7476	215	3-5585	12 - 7486	215
251-82	09 - 7162	134	271-68	12 - 7588	216	3-5843	12 - 7488	215
251028	12 - 7429	214	271-69	12 - 7513	215	3-5856	12 - 7496	215
251028	12 - 5017	211	271-71	12 - 7450	214	3-5857	12 - 7432	214
251030	12 - 7452	214	271-72	12 - 7469	215	3-6004	12 - 5060	212
251884	12 - 7431	214	271-73	12 - 7480	215	3-6044	12 - 7472	215
253-139	10 - 12756	176	271-78	12 - 7574	216	3-6111	12 - 7486	215
2539	12 - 7439	214	271-8	12 - 7486	215	3-6348	12 - 5076	212
254-78	09 - 813	133	271-80	12 - 7573	216	3-6348	12 - 7486	215
254-79	09 - 813	133	271-81	12 - 7482	215	3-6781	10 - 8418	177
26-0880	15 - 1008	410	271-82	12 - 7481	215	3-7274	12 - 7437	214
26-2770	12 - 7493	215	271-83	12 - 7576	216	3-7274	12 - 5015	211
26-2960	06 - 2983	98	271-84	12 - 7586	216	3-8093	12 - 7469	215
26-3050	12 - 7493	215	271-85	12 - 7493	215	3-8166	12 - 7483	215
26-3050	12 - 5078	212	271-9	12 - 7573	216	3-8445	12 - 7482	215
26-3340	12 - 7486	215	271-91	12 - 7593	216	3-8445	12 - 5071	212
26-3540	12 - 7477	215	271-95	12 - 7480	215	3-8445	12 - 5072	212
26-9670	12 - 5073	212	271-96	12 - 7592	216	30-0910	12 - 7479	215
26-9670	12 - 7483	215	271-97	12 - 7488	215	30-9600	12 - 7506	215
26-9671	12 - 10746	258	271-99	12 - 7504	215	30-9670	12 - 7469	215
26-9672	12 - 10210	258	271-99	12 - 5094	212	30-9850	12 - 7494	215
27-0990	15 - 3361	408	28-1370	19 - 9380	484	304-71	20 - 1347	34
27-1160	12 - 6837	258	28-2650	12 - 7545	215	32153-5	10 - 8447	178
27-2360	31 - 11018	1063	28-2990	12 - 7471	215	325-19	10 - 8419	180

O.E.M. REPLACEMENT CROSS REFERENCE



CROSS REFERENCE 2014

OEM #	Our #	Page #	OEM #	Our #	Page #	OEM #	Our #	Page #
TORO/WHEEL HORSE			TORO/WHEEL HORSE			TORO/WHEEL HORSE		
3285-11	41 - 916	1221	5-4505	12 - 5014	211	6-8400	12 - 7487	215
33-1300	19 - 8279	474	5-4769	18 - 1280	444	6-8428	12 - 7432	214
33-4750	15 - 2171	412	5-7960	12 - 5077	212	6-8850	12 - 7436	214
34-7900	37 - 3010	633	5-9760	12 - 7473	215	61-3380	12 - 7599	216
36-2920	12 - 7504	215	500554	12 - 5079	212	61-8300	10 - 13404	163
36-3220	13 - 731	36	50104	12 - 7474	215	61-9760	07 - 6915	105
36-3220	13 - 727	36	51-4160	13 - 9397	292	6146	12 - 7515	215
36-8070	12 - 7439	214	51-4180	05 - 8296	91	62-3900	12 - 7440	214
36-8070	12 - 5017	211	51-4260	42 - 8250	1231	62-4340	09 - 8434	141
37-0200	09 - 6535	133	51-4270	09 - 12651	132	62-4530	13 - 731	36
37-2610	31 - 7675	1064	51-4290	12 - 5231	258	62-5570	09 - 9002	140
37-5650	12 - 7476	215	51-4480	13 - 5711	264	62-5570	09 - 8440	140
37-5660	12 - 7605	216	51-4700	05 - 8265	91	62-5580	09 - 339	146
37-5670	12 - 7497	215	51-7432	12 - 8432	221	62-5580	09 - 8440	140
37-6570	41 - 7678	93	51-7434	12 - 8432	221	62-5580	09 - 9003	140
37-9090	12 - 7434	214	51-7436	12 - 7487	215	62-7700	15 - 6002	410
38-0080	12 - 7488	215	51-7437	12 - 7489	215	63-2951	12 - 5066	212
38-2930	06 - 2984	98	51-7439	12 - 5066	212	63-2961	12 - 7482	215
38-7820	09 - 8507	132	51-7439	12 - 7476	215	63-8400	06 - 11956	100
39-3770	12 - 7473	215	51-7440	12 - 7477	215	63-9380	19 - 6991	481
39-4390	12 - 7597	216	52-2450	09 - 6625	130	633582	08 - 10288	110
39-6740	13 - 13434	293	52-3272	12 - 7584	216	633971	08 - 10286	110
39-7842	05 - 7177	89	52-4580	13 - 5869	263	6489	12 - 7521	215
39-9160	05 - 8207	89	52-7060	41 - 8993	1229	6489	12 - 5111	212
39-9680	05 - 8770	89	53-7740	08 - 13402	114	65-5948	13 - 9895	274
40-9440	12 - 7440	214	5305	06 - 5873	100	65-7410	31 - 9660	1066
41-1880	20 - 7293	519	54-0010-03	15 - 3441	407	6509	12 - 7475	215
41-9150	12 - 7472	215	54-0010-03	15 - 9885	321	6551	12 - 7436	214
42-0880	12 - 7466	215	54-3150	20 - 5841	46	6552	12 - 7435	214
42-0881	12 - 7466	215	54-4580	13 - 734	36	6573	12 - 7481	215
42-0882	12 - 7466	215	54-5010	15 - 9885	321	66-7330	05 - 13433	89
42-0884	12 - 8887	241	54-5190	27 - 7679	491	66-7560	10 - 13406	163
42-1000	15 - 1008	410	54-8820	08 - 3277	115	66-7561	10 - 13407	163
43-1030	12 - 7480	215	54-9921	41 - 5532	1225	6693	15 - 1108	407
43-9730	39 - 6985	485	55-4210	15 - 3394	409	67-0200	15 - 6001	412
44-6250	15 - 6251	411	55-4940	15 - 3393	407	6737	12 - 5102	212
44-6250	15 - 10209	318	55-7660	12 - 6972	258	6737	12 - 7512	215
44-6260	12 - 10387	258	55-8760	41 - 5524	1224	6738	12 - 5119	212
46-3960	27 - 6966	485	55-9250	41 - 5520	1226	6738	12 - 7529	215
46-5650	13 - 7278	292	55-9250	41 - 5539	1225	6771	12 - 7514	215
46-6560	20 - 7730	510	55-9251	41 - 5520	1226	6771	12 - 5104	212
47-1410	12 - 7491	215	55-9300	12 - 9861	241	68-2730	07 - 6917	103
47-1410	12 - 5820	241	56-2390	15 - 6410	322	68-3030	12 - 7621	216
47-1420	12 - 5821	241	56-2390	15 - 3405	408	68-8970	08 - 8684	114
47-1490	09 - 3274	134	56-6360	20 - 11349	499	68-8970	08 - 8582	118
47-1910	31 - 5933	1071	56-6360	20 - 1349	46	68-8980	09 - 8420	140
47-1910	31 - 10772	1071	56-6360	20 - 6000	46	6849	12 - 7521	215
48-2060	09 - 7674	135	57-4700	15 - 3395	409	69-1180	21 - 13998	526
49-9100	12 - 7445	214	57-7000	12 - 7486	215	69-6920	15 - 6270	409
5-0760	12 - 7487	215	5950	12 - 5061	212	6993	12 - 5055	212
5-0934	12 - 7575	216	5950	12 - 7471	215	7-0056	13 - 718	36
5-1583	12 - 7467	215	6-0154	12 - 7479	215	7-0073	12 - 7477	215
5-4505	12 - 5015	211	6-0155	12 - 7503	215	7-0074	12 - 5014	211



O.E.M. REPLACEMENT CROSS REFERENCE

2014 CROSS REFERENCE

OEM #	Our #	Page #	OEM #	Our #	Page #	OEM #	Our #	Page #
TORO/WHEEL HORSE			TORO/WHEEL HORSE			TORO/WHEEL HORSE		
7-0074	12 - 7438	214	7-3890C	12 - 7488	215	79-3061	15 - 6184	409
7-0161	12 - 7503	215	7-3975	12 - 7493	215	79-5270	19 - 6680	484
7-0162	12 - 7577	216	7-4228	12 - 7491	215	7927	12 - 5111	212
7-0354	12 - 5066	212	7-4228	12 - 5081	212	7927	12 - 7521	215
7-0354	12 - 7476	215	7-4230	12 - 7500	215	8-2759	28 - 8644	664
7-0355	12 - 7436	214	7-4231	12 - 5066	212	8-5230	15 - 1012	410
7-0364	12 - 7476	215	7-4231	12 - 7476	215	8-5240	15 - 1011	409
7-0431	13 - 733	36	7-4232	12 - 5104	212	8-5660	12 - 7434	214
7-0530	12 - 7440	214	7-4232	12 - 7514	215	8-5660	12 - 5016	211
7-0550	12 - 5010	211	7-4233	12 - 7503	215	8-8540	15 - 1011	409
7-0550	12 - 7432	214	7-4750	12 - 7501	215	80-0510-03	15 - 6465	410
7-0657	12 - 7437	214	7-6740	12 - 7486	215	80-0660	41 - 5534	1226
7-0737	12 - 5068	212	7-9160	12 - 5090	212	80-4341	10 - 14121	199
7-0737	12 - 7478	215	7-9160	12 - 7500	215	80-4430	15 - 6118	412
7-0824	12 - 5064	212	7-9170	12 - 7493	215	8005	12 - 7515	215
7-0824	12 - 7474	215	7-9390	12 - 7503	215	81-0100	19 - 2782	481
7-0827	12 - 7474	215	7-9390	12 - 5093	212	81-1220	26 - 8769	628
7-0946	12 - 7473	215	70-1061	03 - 8765	66	81-4120	19 - 2843	481
7-1134	12 - 7597	216	70-1080	05 - 13437	70	8133	12 - 7517	215
7-1137	12 - 7591	216	7041	12 - 7515	215	8160	12 - 7628	216
7-1141	12 - 7593	216	71-5380	12 - 10090	241	82-2190	31 - 9663	1066
7-1147	12 - 7586	216	71-5381	12 - 10090	241	8205	13 - 728	36
7-1150	12 - 7588	216	71-5390	41 - 5525	1224	8231	12 - 7513	215
7-1156	12 - 7485	215	71-5960	20 - 11358	498	83-0020	31 - 7804	1063
7-1160	12 - 7587	216	71-5960	20 - 12619	497	8334	12 - 7628	216
7-1164	12 - 7482	215	71-5960	20 - 1358	498	839-3780	12 - 7470	215
7-1167	12 - 7468	215	72-7690	15 - 6137	407	84-1980	41 - 5596	1226
7-1168	12 - 7439	214	72-7730	15 - 6136	411	84-1980	41 - 5534	1226
7-1172	12 - 7582	216	72-7740	15 - 6135	411	84-4370	15 - 6187	408
7-1178	12 - 7581	216	7236	12 - 5055	212	84-9120	05 - 13430	69
7-1185	12 - 7469	215	7358	12 - 7509	215	8411	12 - 7520	215
7-1191	12 - 7475	215	74-0275	31 - 9664	1066	8412	12 - 7529	215
7-1193	12 - 7494	215	74-0480/99-5878	13 - 9805	292	8430	12 - 7502	215
7-1194	12 - 7473	215	74-1720	06 - 13432	100	85-6040	15 - 6271	412
7-1221	12 - 7497	215	74-1791	05 - 13431	70	8510	13 - 2182	263
7-1241	12 - 7474	215	74-1841	10 - 13405	163	8677	12 - 7495	215
7-1277	12 - 7439	214	74-1851	10 - 13405	163	8687	12 - 7495	215
7-1390	12 - 7512	215	74-1890	05 - 13433	89	8699	12 - 7545	215
7-1410	12 - 7491	215	740207	31 - 10772	1071	88-0771	41 - 5520	1226
7-1420	12 - 7509	215	7430	12 - 5061	212	88-0771	41 - 5539	1225
7-1472	12 - 7591	216	7430	12 - 7471	215	88-5140-03	15 - 6184	409
7-2166	12 - 5015	211	7451	13 - 734	36	88-6250	12 - 7530	215
7-2166	12 - 7437	214	7451	13 - 5869	263	88-6250	12 - 14365	241
7-2366	12 - 7502	215	7473	12 - 7627	216	88-9830	31 - 11822	1059
7-3148	12 - 7482	215	7478	12 - 7629	216	88192	27 - 9226	643
7-3476	12 - 7505	215	75-8780	41 - 5527	1224	8911	12 - 7526	215
7-3887	12 - 5062	212	75-9010	12 - 12687	241	8975	12 - 7501	215
7-3887	12 - 7472	215	75-9420	15 - 6308	324	8976	12 - 7498	215
7-3888	12 - 7489	215	75-9420	15 - 6256	410	91-2256-03	15 - 6257	412
7-3888	12 - 5078	212	7776	12 - 7528	215	91-2256-03	15 - 6308	324
7-3888C	12 - 7490	215	7831	12 - 7431	214	91-2258	12 - 14042	241
7-3890	12 - 7488	215	7832	12 - 7495	215	9151	12 - 7636	216
7-3890	12 - 5078	212	79-2920	15 - 6267	407	92-6282	31 - 14291	1067

O.E.M. REPLACEMENT CROSS REFERENCE



CROSS REFERENCE 2014

OEM #	Our #	Page #	OEM #	Our #	Page #	OEM #	Our #	Page #
TORO/WHEEL HORSE			TORO/WHEEL HORSE			TROY BILT		
92-6328	31 - 7675	1064	E513167	20 - 9700	518	738-3056	10 - 11142	179
92-7101	13 - 723	36	E63-3750	19 - 9361	484	742-04116	29 - 12859	667
92-7103	13 - 8829	292	E63-3752	19 - 9464	484	742-04117	29 - 12860	667
92-7952	15 - 6326	408	E633959	09 - 9992	142	742-04118-0637	29 - 8611	667
926787	31 - 11470	1065	H0364	12 - 5066	212	742-04119-0637	29 - 8610	667
926788	31 - 11470	1065	KW10071	19 - 6567	463	742-04154	15 - 12909	342
93-0107-03	15 - 6187	408	KW10071	19 - 2803	463	742-0656	15 - 1031	386
93-0232	12 - 13247	258	KW10586	19 - 12864	450	742-0677A	15 - 11719	342
93-0241	15 - 6275	409	KW10761	19 - 12864	450	742-0677B	15 - 11719	342
93-1622	13 - 727	36	NN10147	19 - 12863	450	742-3036	15 - 10636	341
93-2195	19 - 9550	459	NN10176	19 - 7050	454	7523058	12 - 5061	212
93-3160	10 - 9913	164	NN10684	19 - 12864	450	754-04083	12 - 11661	237
93-4106-03	15 - 10928	352	NN10774	19 - 2790	476	754-04137	12 - 12373	231
93-9998	31 - 9657	1064	NN10872	19 - 6584	476	756-04224	13 - 2188	263
93-9999	31 - 9657	1064	NN10898	19 - 7419	476	756-04325	13 - 14326	280
9360	12 - 7539	215	TRACTOR SUPPLY			759-3939	15 - 10636	341
939998	31 - 11470	1065	758-121	12 - 5064	212	88174	29 - 8192	666
939999	31 - 11470	1065	TRAILMATE			9095	12 - 7432	214
94-1599	07 - 8201	107	239661	12 - 7441	214	918-0659A	10 - 12973	188
94-1861	15 - 9986	411	50028	12 - 5054	212	9201	12 - 7467	215
94-2501	12 - 7546	215	9022	12 - 5005	211	9245	12 - 10822	241
94-2501	12 - 12051	228	9095	12 - 7432	214	925-0873	31 - 14672	1062
94-4632	10 - 11074	170	TROY BILT			938-3056	10 - 11142	179
94-6136	10 - 11071	164	1026A	29 - 8501	667	942-04154	15 - 12909	342
942697	31 - 11470	1065	10802	29 - 8620	667	942-0656	15 - 1031	386
9430	12 - 7479	215	1128-1	12 - 10821	241	946-04618A	05 - 14341	73
9461	12 - 7482	215	11522	09 - 10015	135	954-0266A	12 - 7528	215
95-4108	31 - 9657	1064	1185651	12 - 7557	215	954-04083	12 - 11661	237
95-7489	31 - 11470	1065	1270-1A	29 - 8610	667	9618	29 - 8406	666
95-7489	31 - 9657	1064	1270-2A	29 - 8611	667	9621	29 - 8407	666
95-7668	13 - 734	36	14115	10 - 13220	195	GW-1270-1A	29 - 8610	667
95-7668	13 - 5869	263	1703896	20 - 1347	34	GW-1270-2A	29 - 8611	667
954108	31 - 11470	1065	1718029	20 - 1347	34	GW-1758145	31 - 14672	1062
9691	12 - 5103	212	1719859	19 - 6680	484	GW-1761083	31 - 9664	1066
9691	12 - 7513	215	1726450	19 - 6680	484	GW-1901	29 - 12703	667
9714	12 - 7519	215	1748723	31 - 9660	1066	P406416	12 - 7485	215
9714	12 - 5109	212	1751328	31 - 9665	1066	T239661	12 - 8432	221
9750	12 - 7614	216	1751597	12 - 7534	215	TRU-CUT		
9782	12 - 7512	215	1754183	31 - 12752	1059	11295-11536	09 - 7166	134
9782	12 - 5102	212	1754183099	31 - 12752	1059	52109	06 - 8263	99
9783	12 - 5104	212	1760097	13 - 10738	280	A26	12 - 5061	212
9783	12 - 7514	215	1772144	15 - 6066	338	TURFCO		
98-0789	42 - 14185	1231	1772335	15 - 6069	338	655319	12 - 5074	212
99-2842	10 - 9874	176	18161410	12 - 6906	233	UNICO		
99-4640	10 - 13621	200	1901118	29 - 8620	667	754-141	12 - 7507	215
99-4647	12 - 10051	258	20557	12 - 5006	211	VELKE		
99-5879	13 - 5711	264	21111	29 - 8192	666	VHITCHBUSH	09 - 8654	144
99-6291	05 - 13436	69	50134	12 - 7433	214	VKAXLE2-2	10 - 8651	180
99-8012	10 - 12227	165	50161	12 - 7468	215	VKBRGKIT	09 - 8670	141
99-9313	41 - 5539	1225	717-04174	10 - 12621	165			
99-9313	41 - 5520	1226						
99-9313	41 - 5597	1226						
A52	12 - 7497	215						



O.E.M. REPLACEMENT CROSS REFERENCE

2014 CROSS REFERENCE

OEM #	Our #	Page #	OEM #	Our #	Page #	OEM #	Our #	Page #
VELKE			WALBRO			WALBRO		
VKPIN2-2	10 - 14221	161	200-547	22 - 2889	538	D10-WAT	38 - 4179	1195
VKPIN2-2	10 - 8671	161	21-413	27 - 8080	495	D10-WJ	38 - 7216	1197
VKRLBRG	09 - 9117	141	57-11	32 - 11321	1092	D10-WJ	38 - 7215	1195
VKSPNNR	09 - 8434	141	75-570	22 - 10053	533	D10-WS	38 - 4181	1194
VKX WHEEL	08 - 9260	112	78-47	22 - 10054	533	D10-WT	38 - 4179	1195
VKXGBRGKIT	09 - 9276	141	82-75	38 - 3655	47	D10-WY	38 - 6568	1197
VKXRLBRG	09 - 9275	141	82-75-7	38 - 3655	47	D11-WJ	38 - 7216	1197
VKXSPNNR	09 - 9274	141	82-82	38 - 8112	47	D2-WJ	38 - 7216	1197
VKXWHEEL	08 - 10816	109	82-82-7	38 - 8112	47	D20-WAT	38 - 4923	1195
VENTZKI			88-110	38 - 8125	47	D20-WYJ	38 - 13415	1196
758136	12 - 5158	213	88-131	38 - 8124	47	D22-HDA	38 - 13490	1196
WALBRO			88-131-8	38 - 8124	47	FPC-1-1	22 - 14655	535
118-16	20 - 9948	51	88-136	38 - 8125	47	FPC-1-1	22 - 10875	535
125-48	27 - 8410	491	88-136-8	38 - 8125	47	H20-WT	38 - 8952	1195
125-48-1	27 - 8410	491	88-171	38 - 8123	47	HD-4	22 - 11145	550
125-527	38 - 9024	502	88-171-8	38 - 8123	47	HD-4-1	22 - 11145	550
125-527-1	38 - 9024	502	88-28	38 - 8123	47	HDA-203-1	22 - 11975	546
125-528	38 - 9025	502	88-89	38 - 8124	47	HDA-98	22 - 13285	548
125-528-1	38 - 9025	502	92-142	38 - 8105	47	K10-HD	38 - 12471	1197
140-69	38 - 8122	47	92-142-8	38 - 8105	47	K10-HDB	38 - 8342	1197
140-69-8	38 - 8122	47	92-170	38 - 8114	47	K10-HDC	38 - 8341	1197
140-70	38 - 8121	47	92-170-8	38 - 8114	47	K10-SDC	38 - 8340	1197
140-70-8	38 - 8121	47	92-188	38 - 8105	47	K10-WA	38 - 4180	1195
154-503	22 - 1543	532	92-206	38 - 8117	47	K10-WAT	38 - 4180	1195
16-101-8	38 - 10267	50	92-206-8	38 - 8117	47	K10-WS	38 - 8259	1195
16-110-8	38 - 10268	50	92-214	38 - 8106	47	K10-WT	38 - 4180	1195
16-42	38 - 8120	47	92-214-8	38 - 8106	47	K10-WY	38 - 8261	1197
16-42-8	38 - 8120	47	92-225	38 - 8110	47	K10-WZ	38 - 8260	1197
166-48	38 - 8337	47	92-225-8	38 - 8110	47	K20-WAT	38 - 8952	1195
166-48	38 - 8113	51	92-228	38 - 8111	47	K20-WT	38 - 8952	1195
166-48-8	38 - 8113	51	92-228-8	38 - 8111	47	K20-WTA	38 - 8952	1195
166-48-8	38 - 8337	47	92-251	38 - 8102	47	K20-WYJ	38 - 13263	1196
166-55	38 - 7217	1192	92-251-8	38 - 8102	47	WA-167	22 - 11147	549
166-55-8	38 - 7217	1192	92-318 WA	38 - 8119	47	WA-167-1	22 - 11147	549
176-64-1	38 - 13230	1189	92-318-8	38 - 8119	47	WT-264	22 - 11150	549
188-11	20 - 9477	51	95-118	38 - 8104	47	WT-264-1	22 - 11150	549
188-11-1	20 - 9477	51	95-526	38 - 8101	47	WT-298	22 - 11151	549
188-12	20 - 9478	51	95-526-9-8	38 - 8101	47	WT-38	22 - 11148	550
188-12-1	20 - 9478	51	95-57	38 - 8115	47	WT-38-1	22 - 11148	550
188-13	20 - 9479	51	95-57-8	38 - 8115	47	WT-424	22 - 11155	546
188-13-1	20 - 9479	51	95-72	38 - 8103	47	WT-424-1	22 - 11155	546
188-506	20 - 10392	51	95-83	38 - 8107	47	WT-539	22 - 11157	549
188-508	20 - 10393	51	95-83-8	38 - 8107	47	WT-589-1	22 - 11968	546
188-509	20 - 10394	51	95-89	38 - 8109	47	WT-628-1	22 - 11972	549
188-511	20 - 10395	51	95-89-8	38 - 8109	47	WT-629-1	22 - 11151	549
188-512	20 - 10006	509	D1-MDC	38 - 4209	1194	WT-827-1	22 - 11157	549
188-512	20 - 11510	51	D1-WJ	38 - 7215	1195	WT-827-1	22 - 11968	546
188-512-1	20 - 10006	509	D10-HD	38 - 12470	1195	WT-99	22 - 13286	548
188-512-1	20 - 11510	51	D10-HDA	38 - 4301	1195	WY-18	22 - 11163	546
200-506	22 - 2889	538	D10-HDB	38 - 4182	1194	WY-18-1	22 - 11163	546
			D10-HDC	38 - 4186	1195	WYJ-192	22 - 11164	545
			D10-HDC	38 - 4186	1195	WYJ-192-1	22 - 11164	545
			D10-SDC	38 - 4184	1195	WYJ-220	22 - 11165	545
			D10-WA	38 - 4179	1195			

O.E.M. REPLACEMENT CROSS REFERENCE



CROSS REFERENCE 2014

OEM #	Our #	Page #	OEM #	Our #	Page #	OEM #	Our #	Page #
WALBRO			WARNER			WARNER		
WYJ-220-1	22 - 11165	545	5210-10	10 - 11858	167	5218-58	10 - 14495	164
WYJ-250-1	22 - 11971	546	5215-129	10 - 11828	169	5218-6.	10 - 12228	165
WYK-128-1	22 - 11969	549	5215-13	10 - 11857	166	5218-65	10 - 11237	167
WYL-19	22 - 11166	549	5215-130	10 - 11829	169	5218-67	10 - 12114	168
WYL-19-1	22 - 11166	549	5215-14	10 - 11858	167	5218-73	10 - 12262	168
WZ-8-1	22 - 11168	549	5215-142	10 - 12247	165	5218-76	10 - 11133	167
WZ-8C	22 - 11168	549	5215-51	10 - 9910	164	5218-80	10 - 12261	168
WALKER			5215-59	10 - 12227	165	5218-94	10 - 14009	164
5037	09 - 7950	131	5215-62	10 - 9913	164	5218-99	10 - 12403	168
5037-1	09 - 7950	131	5215-68	10 - 12230	165	5218-213	10 - 11237	167
5090-01	19 - 9550	459	5215-69	10 - 14045	166	5218-222	10 - 12454	169
5223	10 - 8503	171	5215-73	10 - 12309	164	5219-100	10 - 13469	166
52431	12 - 5172	213	5215-73	10 - 12309	164	5219-21	10 - 13469	166
5245	13 - 9537	292	5215-88	10 - 11070	170	5219-25	10 - 12424	169
5270	09 - 8488	135	5217-14	10 - 12231	165	5219-4	10 - 12658	169
5414-3	09 - 8076	141	5217-147	10 - 12114	168	5219-54	10 - 13554	170
5683	09 - 8211	148	5217-2	10 - 9912	164	5219-79	10 - 12621	165
5705-0	15 - 3423	413	5217-32	10 - 11859	165	5219-98	10 - 14229	166
5705-1	15 - 6176	413	5217-43	10 - 11859	165	5219-99	10 - 14327	169
5705-10	15 - 6176	413	5217-6	10 - 9911	164	WESTERN AUTO		
5705-11	15 - 6177	413	5217-9	10 - 9911	164	100140	12 - 5050	212
5705-3	15 - 6414	325	5218-10	10 - 11071	164	16149	12 - 5072	212
5705-3	15 - 3446	413	5218-100	10 - 12981	167	WHITE FARM		
5705-4	15 - 3445	413	5218-107	10 - 12835	168	32-0021415	12 - 5151	213
5706	17 - 10019	432	5218-110	10 - 11445	169	717-04174	10 - 12621	165
5706	17 - 6793	432	5218-14	10 - 11072	165	917-04174	10 - 12621	165
5714-5	09 - 8210	137	5218-140	10 - 12835	168	WHITE OUTDOOR		
5714-5	09 - 8996	139	5218-150	10 - 12517	168	0109	12 - 5076	212
5715-3	08 - 10162	115	5218-150	10 - 12261	168	32-0000469	12 - 7436	214
5715-4	08 - 7982	115	5218-154	10 - 12454	169	32-0003239	15 - 1014	382
5715-4	08 - 11063	110	5218-159	10 - 14353	166	32-0003484	15 - 1016	382
5740-2	09 - 11833	144	5218-17	10 - 11073	166	32-0005118	12 - 7473	215
6231	12 - 8820	260	5218-201	10 - 11075	167	32-0005843	12 - 7580	216
6250	12 - 12246	260	5218-202	10 - 12403	168	32-0005908	12 - 7573	216
6942	31 - 9369	1064	5218-205	10 - 12517	168	32-0007153	12 - 7582	216
6950	31 - 7675	1064	5218-210	10 - 12835	168	32-0007358	12 - 7614	216
7021	20 - 13536	520	5218-213	10 - 11237	167	32-0007382	12 - 7508	215
7035-1	08 - 8949	119	5218-214	10 - 12114	168	32-0007447	15 - 1015	382
7230	12 - 10320	260	5218-218	10 - 14189	166	32-0009040	12 - 7595	216
7234	12 - 8819	260	5218-219	10 - 11445	169	32-0009059	12 - 7615	216
7234-1	12 - 10321	260	5218-222	10 - 12454	169	32-0009083	15 - 997	382
7235	12 - 8798	260	5218-228	10 - 12981	167	32-0009105	15 - 1018	383
7248	12 - 10322	260	5218-243	10 - 12981	167	32-0009962	12 - 7506	215
7705-1	15 - 6170	413	5218-251-001	10 - 12923	168	32-0009997	12 - 7609	216
7705-2	15 - 6169	413	5218-254	10 - 14353	166	32-0010014	15 - 1077	381
8230	12 - 10323	260	5218-257	10 - 14495	164	32-0011738	12 - 7477	215
8740	09 - 11834	146	5218-26	10 - 14495	164	32-0015148	12 - 7525	215
F002	17 - 8802	436	5218-27	10 - 11664	168	32-0015334	12 - 7492	215
F002	17 - 10019	432	5218-29	10 - 13973	165	32-0015466	12 - 7599	216
F202	17 - 8801	436	5218-33	10 - 11074	170	32-0016470	12 - 7623	216
F202	17 - 10019	432	5218-44	10 - 11075	167			
			5218-5	10 - 11444	167			
			5218-54	10 - 11825	167			



O.E.M. REPLACEMENT CROSS REFERENCE

2014 CROSS REFERENCE

OEM #	Our #	Page #	OEM #	Our #	Page #	OEM #	Our #	Page #
WHITE OUTDOOR			WINDSOR			WINDSOR		
32-0018635	12 - 7595	216	04-3272	36 - 12589	1176	50-2005	15 - 3326	328
32-0018910	12 - 7627	216	04-3272	36 - 1690	1177	50-2010	15 - 6060	328
32-0020028	12 - 7477	215	04-3282	36 - 9499	1177	50-2060	15 - 6068	338
32-0020699	12 - 7495	215	04-3282	36 - 12586	1176	50-2080	15 - 6181	360
32-0021253	12 - 7596	216	04-3771	36 - 1689	1177	50-2081	15 - 11595	373
32-0021407	12 - 7576	216	04-3771	36 - 12584	1176	50-2082	15 - 1066	345
32-0021539	12 - 7477	215	04-3772	36 - 1688	1177	50-2083	15 - 6766	345
32-0027804	12 - 7481	215	04-3772	36 - 12588	1176	50-2095	15 - 6298	322
32-0027898	12 - 7543	215	04-3781	36 - 12582	1176	50-2125	15 - 997	382
32-0029157	12 - 7493	215	04-3781	36 - 9498	1177	50-2126	15 - 11250	342
32-0029483	12 - 7485	215	04-4071	36 - 1686	1177	50-2138	15 - 11480	341
32-0030104	12 - 7476	215	50-1515	15 - 6075	340	50-2139	15 - 11479	341
32-0031909	12 - 7497	215	50-1530	15 - 6128	381	50-2140	15 - 10719	351
32-0041165	12 - 7484	215	50-1535	15 - 2000	407	50-2140	15 - 6178	350
32-0041327	12 - 7480	215	50-1550	15 - 1126	372	50-2141	15 - 10634	373
32-0041971	12 - 7478	215	50-1550	15 - 1065	360	50-2145	15 - 6291	350
32-004391	12 - 7500	215	50-1555	15 - 1065	360	50-2146	15 - 10719	351
32-0044113	12 - 7488	215	50-1555	15 - 1126	372	50-2146	15 - 10173	318
32-0044202	12 - 7478	215	50-1585	15 - 6086	345	50-2148	15 - 3404	347
32-0045527	12 - 7434	214	50-1590	15 - 6087	345	50-2153	15 - 11033	359
32-0048631	12 - 7590	216	50-1600	15 - 2083	399	50-2155	15 - 6082	341
32-0048658	12 - 7605	216	50-1605	15 - 1100	345	50-2160	15 - 6012	373
32-0050024	12 - 7496	215	50-1615	15 - 2030	358	50-2160	15 - 6224	343
32-005096	12 - 7468	215	50-1635	15 - 6019	381	50-2160	15 - 6181	360
32-0051918	12 - 7487	215	50-1680	15 - 3346	372	50-2205	15 - 3401	336
32-0052868	12 - 7471	215	50-1705	15 - 3377	359	50-2210	15 - 1010	336
32-0053295	12 - 7525	215	50-1705	15 - 3378	359	50-2215	15 - 2173	334
32-0054089	12 - 7572	216	50-1735	15 - 3393	407	50-2220	15 - 9968	319
32-0054100	12 - 7597	216	50-1750	15 - 6081	340	50-2235	15 - 2079	399
32-0054682	15 - 3354	384	50-1800	15 - 6066	338	50-2250	15 - 3380	359
32-0055301	12 - 7485	215	50-1805	15 - 3386	377	50-2250	15 - 3379	359
32-0055883	12 - 7441	214	50-1815	15 - 2081	399	50-2270	15 - 6186	375
32-0057088	12 - 7550	215	50-1820	15 - 3332	339	50-2280	15 - 1014	382
32-0060453	12 - 7499	215	50-1825	15 - 6175	349	50-2295	15 - 3404	347
32-0060461	12 - 7608	216	50-1855	15 - 1127	372	50-2295	15 - 2173	334
32-0060801	12 - 7495	215	50-1880	15 - 2001	408	50-2295	15 - 3401	336
32-0061573	15 - 1017	383	50-1885	15 - 6116	338	50-2300	15 - 3442	380
32-0062898	12 - 7502	215	50-1895	15 - 825	346	50-2306	15 - 11267	351
32-0062928	12 - 7483	215	50-1900	15 - 3403	347	50-2306	15 - 11495	351
32-0063916	12 - 7484	215	50-1905	15 - 6009	379	50-2307	15 - 6195	330
322-0024368	12 - 7505	215	50-1905	15 - 3403	347	50-2310	15 - 3361	408
34-0023434	12 - 7441	214	50-1915	15 - 2169	400	50-2320	15 - 3405	408
754-0347	12 - 5096	212	50-1920	15 - 9487	349	50-2336	15 - 6239	342
			50-1930	15 - 1009	336	50-2340	15 - 2078	399
			50-1933	15 - 3400	336	50-2395	15 - 848	379
WICO			50-1936	15 - 11240	349	50-2400	15 - 6143	382
WX15034	31 - 1779	1076	50-1938	16 - 1141	422	50-2425	15 - 3468	409
WX15035	31 - 1780	1076	50-1938	15 - 11493	349	50-2460	15 - 6480	374
X15035	31 - 1780	1076	50-1940	15 - 3403	347	50-2465	15 - 1015	382
			50-1946	15 - 6500	366	50-2470	15 - 6126	382
WIKOV-SLAVIA			50-1965	15 - 6003	382	50-2515	15 - 6011	374
DO225	15 - 50245	414	50-1967	15 - 1009	336	50-2520	15 - 845	375
DO226	15 - 50241	414	50-1980	15 - 2082	399	50-2526	15 - 6737	374

O.E.M. REPLACEMENT CROSS REFERENCE



CROSS REFERENCE 2014

OEM #	Our #	Page #	OEM #	Our #	Page #	OEM #	Our #	Page #
WINDSOR			WINDSOR			WINDSOR		
50-2545	15 - 6184	409	50-3215	15 - 6078	343	50-4190	15 - 6782	345
50-2585	15 - 3400	336	50-3231	15 - 11593	376	50-4207	15 - 10372	370
50-2610	15 - 6147	342	50-3250	15 - 6127	383	50-4208	15 - 10373	370
50-2615	15 - 6006	382	50-3251	15 - 11139	353	50-4209	15 - 10371	369
50-2616	15 - 11477	342	50-3252	15 - 1031	386	50-4211	15 - 10249	352
50-2625	15 - 3395	409	50-3270	15 - 6284	417	50-4215	15 - 3374	338
50-2670	15 - 2007	401	50-3291	15 - 10929	411	50-4215	15 - 3404	347
50-2675	15 - 2006	402	50-3305	15 - 6424	387	50-4215	15 - 2173	334
50-2730	15 - 1016	382	50-3330	15 - 1018	383	50-4215	15 - 6014	338
50-2740	15 - 6140	382	50-3340	15 - 3407	384	50-4215	15 - 1010	336
50-2745	15 - 6005	382	50-3341	15 - 11721	371	50-4220	15 - 9988	349
50-2780	15 - 3322	328	50-3345	15 - 6004	383	50-4225	15 - 9882	355
50-2810	15 - 6290	353	50-3360	15 - 3446	413	50-4245	15 - 9987	357
50-2811	15 - 11249	353	50-3390	15 - 6077	343	50-4385	15 - 6224	343
50-2812	15 - 11242	352	50-3406	15 - 10797	371	50-4385	15 - 6223	373
50-2813	15 - 11224	353	50-3430	15 - 6171	362	50-4390	15 - 6221	374
50-2814	15 - 10667	334	50-3435	15 - 6026	334	50-4395	15 - 6192	374
50-2814	15 - 6083	344	50-3456	15 - 11229	355	50-4405	15 - 6255	376
50-2825	15 - 3339	361	50-3475	15 - 1103	402	50-4410	15 - 6253	375
50-2830	15 - 6285	361	50-3480	15 - 3362	411	50-4420	15 - 6206	373
50-2838	15 - 9171	409	50-3495	15 - 6170	413	50-4426	15 - 10284	373
50-2840	15 - 6180	334	50-3500	15 - 6169	413	50-4435	15 - 9959	376
50-2840	15 - 6083	344	50-3535	15 - 1091	403	50-4440	15 - 10074	376
50-2845	15 - 2120	375	50-3550	15 - 6108	403	50-4441	15 - 10292	374
50-2885	15 - 6096	383	50-3555	15 - 1098	403	50-4442	15 - 10291	373
50-2886	15 - 6430	364	50-3575	15 - 6328	376	50-4485	15 - 6208	377
50-2940	15 - 1076	398	50-3615	15 - 3354	384	50-4490	15 - 6265	378
50-2945	15 - 3421	415	50-3660	15 - 1092	403	50-4495	15 - 6209	378
50-2960	15 - 2160	364	50-3665	15 - 6029	403	50-4550	15 - 6212	384
50-2965	15 - 6092	364	50-3695	15 - 2171	412	50-4676	15 - 10093	399
50-2975	15 - 849	379	50-3700	15 - 6118	412	50-4677	15 - 10096	399
50-2981	15 - 6431	364	50-3720	15 - 1060	403	50-4678	15 - 10095	399
50-2982	15 - 6168	360	50-3760	15 - 1108	407	50-4679	15 - 10094	399
50-2995	15 - 824	417	50-3815	15 - 6254	328	50-4685	15 - 6197	401
50-3006	15 - 6028	383	50-3925	15 - 6069	338	50-4725	15 - 1136	404
50-3035	15 - 6479	375	50-3935	15 - 1029	385	50-4780	15 - 6303	324
50-3036	15 - 10635	375	50-3940	15 - 1030	340	50-4845	15 - 6256	410
50-3046	15 - 10363	342	50-3945	15 - 1032	386	50-4850	15 - 6251	411
50-3047	15 - 11663	347	50-3950	15 - 1032	386	50-4860	15 - 6270	409
50-3050	15 - 3402	337	50-3985	15 - 6088	345	50-4870	15 - 6271	412
50-3055	15 - 2174	337	50-3990	15 - 6434	416	50-4881	15 - 12643	376
50-3065	15 - 6141	339	50-3995	15 - 6433	415	50-4930	15 - 6210	416
50-3110	15 - 1017	383	50-4005	15 - 6404	334	50-4935	12 - 6950	233
50-3120	15 - 6139	383	50-4010	15 - 6833	334	50A	34 - 4294	1141
50-3160	15 - 3434	362	50-4025	15 - 6784	346	50A	34 - 4287	1141
50-3160	15 - 2174	337	50-4065	15 - 6821	348	50J	34 - 4292	1141
50-3161	15 - 10930	398	50-4070	15 - 6820	348	50R	34 - 4284	1141
50-3162	15 - 6168	360	50-4080	15 - 6167	359	50R	34 - 4288	1141
50-3171	15 - 9969	319	50-4080	15 - 6168	360	51-1595	15 - 6316	321
50-3175	15 - 1012	410	50-4165	15 - 1132	404	51-1700	15 - 6415	321
50-3180	15 - 1008	410	50-4170	15 - 6238	342	51-1701	15 - 6496	321
50-3182	15 - 10102	359	50-4180	15 - 6237	343	51-1725	15 - 3441	407
50-3190	15 - 6002	410	50-4185	15 - 6240	341	51-1795	15 - 9884	321



O.E.M. REPLACEMENT CROSS REFERENCE

2014 CROSS REFERENCE

OEM #	Our #	Page #	OEM #	Our #	Page #	OEM #	Our #	Page #
WINDSOR			WISCONSIN/ROBIN			WOODS/HESSTON		
51-1910	15 - 6300	322	227-32803-17	19 - 6694	482	74075	10 - 14495	164
51-1915	15 - 6300	322	227-36210-08	19 - 6699	482	WORLDLAWN		
51-1935	15 - 6296	322	235-32610-08	19 - 6697	482	3602005	15 - 13976	416
51-1935	15 - 6296	322	235-34701-21	19 - 6696	482	4801401	15 - 13975	416
51-1940	15 - 6296	322	261-32601-07	19 - 9748	477	5203434	10 - 14189	166
51-2030	15 - 6314	322	EC02-0098	27 - 7908	658	6001004	15 - 13977	416
51-2035	15 - 6206	373	EY1573620101	19 - 6698	482	WRIGHT		
51-2090	15 - 6298	322	EY2063260107	19 - 6702	482	14990003	09 - 14322	148
51-2095	15 - 6785	322	EY2073260008	19 - 6704	482	34490002	19 - 9464	484
51-2096	15 - 6298	322	EY2073260618	19 - 7038	482	39490001	42 - 14176	1232
51-2220	15 - 11556	370	EY2273261007	19 - 6700	482	39490002	42 - 14179	1233
51-2235	15 - 6410	322	EY2273261308	19 - 6695	482	3949003	42 - 14184	1231
51-2240	15 - 6294	323	EY2273280317	19 - 6694	482	524-10001	31 - 9664	1066
51-2245	15 - 6309	322	EY2273621008	19 - 6699	482	524-10002	31 - 9663	1066
51-2290	15 - 6309	322	EY2353261008	19 - 6697	482	52420003	31 - 9656	1064
51-2305	15 - 6294	323	EY2353470121	19 - 6696	482	71410014	10 - 13554	170
51-2315	15 - 6410	322	LO173B	19 - 2781	481	71410024	10 - 14189	166
51-2440	15 - 6315	323	LO175E	19 - 2785	481	71460001	12 - 5085	212
51-2495	15 - 11558	378	LO194A	19 - 1386	470	71460001	12 - 7495	215
51-2790	15 - 6250	352	LP43	20 - 1348	508	71460007	10 - 14283	200
51-2800	15 - 6303	324	WOLF			71460022	10 - 14282	200
51-2805	15 - 6303	324	171046	15 - 50122	414	71460033	12 - 5086	212
51-2810	15 - 11469	354	171051	15 - 50121	414	71460033	12 - 7496	215
51-2865	15 - 6317	324	WOODS/HESSTON			71460034	12 - 7493	215
51-3150	15 - 6308	324	072262	31 - 11470	1065	71460034	12 - 5083	212
51-3155	15 - 6311	324	13404	15 - 6210	416	71460071	12 - 7641	216
51-3165	15 - 6299	324	15127	15 - 6433	415	71460071	12 - 5223	213
51-3170	15 - 6299	324	15127	15 - 6434	416	71460096	12 - 11864	224
51-3171	15 - 6299	324	19258	32 - 9013	1091	71460119	12 - 11482	236
51-3175	15 - 6311	324	2303	09 - 10015	135	71460123	12 - 5205	213
51-3425	15 - 9883	325	23825	15 - 3421	415	71460123	12 - 7623	216
51-3560	15 - 6302	326	31306	15 - 6210	416	71460126	10 - 14283	200
51-3670	15 - 6297	326	31359	15 - 6432	415	71460128	10 - 12812	162
51-3725	15 - 6301	326	34615	15 - 6433	415	72460004	08 - 10288	110
51-4440	15 - 11233	386	35582	12 - 5061	212	95460018	10 - 14282	200
52-2225	15 - 6014	338	60006	09 - 8488	135	YAMAHA		
58A	34 - 4294	1141	6231	12 - 8820	260	7Y6-51647-01-00	41 - 5541	1222
58B	34 - 4297	1141	6950	15 - 6467	415	90185-06122-00	41 - 5541	1222
58J	34 - 4292	1141	70006	09 - 8488	135	YARDMAN		
63B	34 - 4297	1141	70014	15 - 3377	359	1042	12 - 7473	215
GRA3-255	27 - 13449	425	70062	15 - 3378	359	1063	12 - 7482	215
WISCONSIN/ROBIN			70104	15 - 3379	359	1651-11	12 - 7466	215
1082	27 - 5864	486	70117	15 - 3380	359	1651-13	12 - 7468	215
157-36201-01	19 - 6698	482	70134	15 - 6167	359	1651-14	12 - 7481	215
206-32601-07	19 - 6702	482	70142	15 - 6168	360	1651-15	12 - 7505	215
206-36003-03	19 - 7165	481	70142	15 - 3424	360	1651-17	12 - 7504	215
207-32600-08	19 - 6704	482	70422	31 - 7922	1064	1651-2	12 - 7468	215
207-32606-18	19 - 7038	482	70666	20 - 13536	520	1651-21	12 - 7466	215
207326018	19 - 7038	482	70939	19 - 12863	450	1651-23	12 - 7476	215
210-32601-28	19 - 7715	482	72859	19 - 12864	450			
227-32610-07	19 - 6700	482	73558	10 - 14495	164			
227-32613-08	19 - 6695	482						

O.E.M. REPLACEMENT CROSS REFERENCE



CROSS REFERENCE 2014

OEM #	Our #	Page #	OEM #	Our #	Page #	OEM #	Our #	Page #
YARDMAN			YARDMAN			YAZOO		
1651-28	12 - 7572	216	2651-24	12 - 7474	215	1407	12 - 7490	215
1651-30	12 - 7472	215	2651-25	12 - 7475	215	1508	12 - 7501	215
1651-31	12 - 7488	215	2651-26	12 - 7477	215	1608355	13 - 5869	263
1651-32	12 - 7470	215	2651-28	12 - 7572	216	1608355	13 - 734	36
1651-33	12 - 7478	215	2651-40	12 - 7601	216	1923-025	31 - 9660	1066
1651-37	12 - 7479	215	3651-88	12 - 7485	215	200-013	28 - 1998	664
1651-38	12 - 7483	215	3651-89A	12 - 7498	215	204-019	09 - 483	132
1651-40	12 - 7602	216	40021	12 - 7479	215	204-060	09 - 484	133
1651-41	12 - 7483	215	40041	12 - 7483	215	205-020	12 - 5053	212
1651-42	12 - 7484	215	40207	12 - 7487	215	205-021	12 - 5054	212
1651-43	12 - 7499	215	40216	12 - 7481	215	205-022	12 - 5055	212
1651-46	12 - 7441	214	40346	12 - 7486	215	205-024	12 - 7467	215
1651-52	12 - 5188	213	40572	12 - 7487	215	205-026	12 - 7469	215
1651-53	12 - 7505	215	40591	12 - 7474	215	205-027	12 - 7470	215
1651-54	12 - 7508	215	41969	12 - 7595	216	205-028	12 - 7471	215
1651-59	12 - 7501	215	41980	12 - 7510	215	205-030	12 - 7473	215
1651-60	12 - 7483	215	41993	12 - 7502	215	205-031	12 - 7474	215
1651-61	12 - 5188	213	50018	12 - 7473	215	205-032	12 - 7475	215
1651-62	12 - 7632	216	50S-46-31	12 - 7474	215	205-033	12 - 7476	215
1651-63	12 - 7508	215	50S-84-31	12 - 7474	215	205-034	12 - 7477	215
1651-65	12 - 7510	215	754-0225	12 - 5070	212	205-035	12 - 7478	215
1651-66	12 - 7507	215	754-204	12 - 7510	215	205-036	12 - 7479	215
1651-67	12 - 7596	216	754-206	12 - 7493	215	205-037	12 - 7480	215
1651-68	12 - 7480	215	754-216	12 - 7434	214	205-039	12 - 7482	215
1651-69	12 - 7498	215	754-221	12 - 7597	216	205-040	12 - 7483	215
1651-71	12 - 7608	216	754-224	12 - 7571	216	205-041	12 - 7484	215
1651-72	12 - 7510	215	754-275	12 - 5071	212	205-042	12 - 7485	215
1651-73	12 - 7608	216	75400329	12 - 7614	216	205-044	12 - 7487	215
1651-74A	12 - 7593	216				205-045	12 - 7488	215
1651-75	12 - 7579	216	YAZOO			205-046	12 - 7489	215
1651-76A	12 - 7493	215	101-002	17 - 2947	432	205-047	12 - 7490	215
1651-79	12 - 7623	216	101164	19 - 9361	484	205-048	12 - 7491	215
1651-81	12 - 7482	215	101768	31 - 9656	1064	205-049	12 - 7492	215
1651-82	12 - 7497	215	102652	13 - 9868	278	205-050	12 - 7493	215
1651-83B	12 - 7500	215	102677	09 - 8488	135	205-051	12 - 7494	215
1651-84	12 - 7498	215	103-331	12 - 7436	214	205-053	12 - 7496	215
1651-85	12 - 7480	215	103241	12 - 10949	260	205-055	12 - 7498	215
1651-86A	12 - 7487	215	103581	12 - 7436	214	205-058	12 - 7501	215
1651-87A	12 - 7483	215	104335	12 - 10823	260	205-061	12 - 7504	215
1654-45	12 - 7479	215	104336	12 - 10824	260	205-065	12 - 7611	216
2006	12 - 7471	215	105477	12 - 10825	260	205-070	12 - 7618	216
2034	12 - 7475	215	1202	12 - 5055	212	205-071	12 - 7619	216
2036	12 - 7476	215	1204	12 - 7467	215	205-073	12 - 7621	216
224-565-114	12 - 7483	215	1206	12 - 7469	215	205-128	12 - 7433	214
224-S30-96	12 - 7479	215	1208	12 - 7471	215	205-129	12 - 7434	214
261-30-114	12 - 7481	215	1302	12 - 7475	215	205-137	12 - 7585	216
261-65-90	12 - 7488	215	1304	12 - 7477	215	205-141	12 - 7484	215
262-30-114	12 - 7481	215	1306	12 - 7479	215	205-142	12 - 7485	215
262-65-90	12 - 7488	215	1307	12 - 7480	215	205-144	12 - 7487	215
2651-11	12 - 7466	215	1309	12 - 8427	221	205-147	12 - 7490	215
2651-14	12 - 7481	215	1401	12 - 7484	215	205-154	12 - 7497	215
2651-15	12 - 7505	215	1404	12 - 7487	215	205-155	12 - 7498	215
2651-23	12 - 7476	215	1405	12 - 7488	215	205-307	12 - 7480	215



O.E.M. REPLACEMENT CROSS REFERENCE

2014 CROSS REFERENCE

OEM #	Our #	Page #	OEM #	Our #	Page #	OEM #	Our #	Page #
YAZOO			ZAMA			ZAMA		
205-331	12 - 7438	214	0015030V	09 - 814	134	GND-7	38 - 13488	1202
205-424	12 - 5057	212	0016001	38 - 8140	50	GND-8	38 - 4996	1200
205-425	12 - 7468	215	0016003	38 - 8142	50	GND-91	38 - 14653	1200
205-426	12 - 7469	215	0016005	38 - 8136	50	GND-98	38 - 14654	1200
205-428	12 - 7501	215	0016008	38 - 8142	50	GND2	38 - 5839	1201
205-429	12 - 7472	215	0016014	38 - 8149	50	K015005	38 - 4996	1200
205-448	12 - 7491	215	0016015	38 - 8148	50	K015011	38 - 5839	1201
205-449	12 - 7492	215	0016017	38 - 8147	50	K015019	38 - 4210	1200
205-469	12 - 7512	215	0016039	38 - 8147	50	K015022	38 - 5839	1201
205-505	12 - 7894	260	0037002	38 - 8139	50	K015026	38 - 5840	1201
205-508	12 - 7471	215	0037004	38 - 8153	50	K015027	38 - 5839	1201
205-511	12 - 7611	216	0057004	20 - 9948	51	K015032	38 - 5839	1201
205-515	12 - 7614	216	16008	38 - 8142	50	K015033	38 - 5839	1201
205-516	12 - 7471	215	16039	38 - 8147	50	K015034	38 - 5840	1201
205-517	12 - 7634	216	A015002	38 - 8141	50	RB-114	38 - 13420	1202
205-518	12 - 7617	216	A015005	38 - 8135	50	RB-20	38 - 9244	1200
205-519	12 - 7470	215	A015006	38 - 8146	50	RB-27	38 - 13262	1202
205-521	12 - 7580	216	A015010	38 - 14083	1199	RB-28	38 - 9298	1201
205-523	12 - 7474	215	A015053	38 - 14348	1199	RB-29	38 - 13365	1202
206-622	15 - 9176	417	C1M-K37D	22 - 11970	546	RB-31	38 - 13291	1196
206-660	15 - 6284	417	C1M-K49C	22 - 11170	546	RB-36	38 - 13292	1196
206-760	15 - 824	417	C1M-K76	22 - 11973	546	RB-41	38 - 13293	1196
208-029	12 - 7472	215	C1MK49D	22 - 11170	546	RB-45	38 - 13294	1196
208-038	12 - 7481	215	C1Q-DM1	38 - 13489	1196	RB-61	38 - 12773	1201
2302-023	06 - 6675	100	C1Q-DM6	38 - 13489	1196	RB-66	38 - 12996	1201
2302-099	07 - 5899	103	C1Q-DM7	38 - 13489	1196	RB-69	38 - 13185	1202
2302-100	07 - 5900	103	C1Q-DM8	38 - 13489	1196	RB-71	38 - 13638	1196
2302-126	07 - 6914	105	C1Q-DM9	38 - 13489	1196	RB-77	38 - 13391	1196
2302-127	07 - 6917	103	C1QDM6A	38 - 13489	1196	RB-K66A	22 - 11179	545
510201301	12 - 10824	260	C1QDM7A	38 - 13489	1196	RB-K70A	22 - 11179	545
522795901	12 - 10823	260	C1QDM8A	38 - 13489	1196	RB-K75	22 - 11967	546
539001125	31 - 9660	1066	C1QDM9A	38 - 13489	1196	RBK66B	22 - 11179	545
539001198	06 - 6675	100	C1U-H60D	22 - 11974	547	ZF-2	38 - 9137	502
539001200	07 - 5900	103	C1U-K42B	22 - 11175	545	ZF-3	38 - 9138	502
539101164	19 - 9361	484	C1U-K51	22 - 11176	545	ZF-4	38 - 9139	502
539101768	31 - 9656	1064	C1U-K52	22 - 11177	545	ZF-5	38 - 9140	502
539102652	13 - 9868	278	C1U-K54A	22 - 11178	545			
539103241	12 - 10949	260	C1UH60E	22 - 11974	547			
539103581	12 - 7436	214	GND-1	38 - 4210	1200			
539104335	12 - 10823	260	GND-13	38 - 9199	1202			
539104336	12 - 10824	260	GND-14	38 - 9199	1202			
539105477	12 - 10825	260	GND-16	38 - 9199	1202			
639-19087	13 - 9753	275	GND-17	38 - 9199	1202			
YK	07 - 6917	103	GND-18	38 - 9199	1202			
			GND-28	38 - 12998	1201			
			GND-29	38 - 13489	1196			
ZAMA			GND-31	38 - 12774	1201			
0015001	38 - 8143	50	GND-32	38 - 5839	1201			
0015004	38 - 8137	50	GND-35	38 - 13489	1196			
0015013	38 - 8151	50	GND-39	38 - 13097	1202			
0015014	38 - 8145	50	GND-4	38 - 5840	1201			
0015015	38 - 8150	50	GND-52	38 - 13063	1202			
0015018	38 - 8152	50	GND-56	38 - 14383	1202			
0015030V	38 - 8151	50						

AFTERMARKET CROSS REFERENCE



AFTERMARKET REF. 2014

Part No.	Rotary No.	Page No.	Part No.	Rotary No.	Page No.	Part No.	Rotary No.	Page No.	Part No.	Rotary No.	Page No.	Part No.	Rotary No.	Page No.
OREGON			02-496	10 - 5706	176	07-200	38 - 4995	48	15-026	12 - 12489	234	30-068	27 - 9909	490
02-000	32 - 9086	1102	02-509	02 - 122	41	07-201	38 - 1400	48	15-027	12 - 12790	234	30-070	19 - 1390	479
02-002	02 - 76	41	02-531	02 - 41	39	07-202	38 - 1399	48	15-028	12 - 12791	234	30-073	19 - 10263	455
02-006	02 - 78	41	02-532	02 - 48	40	07-204	38 - 1391	48	158RNDD00935	12349	1157	30-074	19 - 10184	456
02-007	02 - 75	41	02-535	02 - 44	40	07-205	38 - 3904	48	160ATMZ09535	12333	1157	30-076	19 - 10304	456
02-008	02 - 77	41	02-536	02 - 49	40	07-206	38 - 3903	48	160GPEA04135	12235	1149	30-076	19 - 13629	449
02-009	02 - 79	41	02-635	02 - 145	43	07-207	38 - 3902	48	160RNBD02535	12356	1171	30-080	19 - 1386	470
02-010	02 - 163	43	02-640	02 - 147	43	07-208	38 - 9137	502	160RNDD00935	12342	1161	30-081	19 - 1384	473
02-011	02 - 164	44	02-644	02 - 158	43	07-209	38 - 9138	502	160RNDD02535	12355	1171	30-082	19 - 1385	474
02-012	02 - 165	44	02-645	02 - 151	43	07-210	38 - 9139	502	160RNDD17635	12338	1159	30-083	19 - 1382	480
02-013	02 - 168	44	02-648	02 - 146	43	07-211	38 - 9140	502	160RNDDK09535	12331	1157	30-085	19 - 6605	467
02-014	02 - 167	44	02-652	02 - 148	43	07-213	38 - 9227	498	16372AX	36 - 12029	1174	30-088	19 - 8235	467
02-015	02 - 166	44	02-700	20 - 3450	43	07-214	38 - 9024	502	163RNBD02535	13223	1171	30-089	19 - 8329	470
02-020	02 - 9372	53	02-701	20 - 3452	43	07-215	38 - 3905	48	164MLEA07435	12538	1171	30-090	19 - 1394	479
02-040	20 - 5904	43	02-860	20 - 1346	34	07-216	38 - 3906	502	168RNDD00935	12335	1157	30-091	19 - 1395	479
02-041	20 - 5903	43	02-861	20 - 1345	34	07-219	38 - 9025	502	180RNDD00935	12343	1161	30-092	19 - 1387	473
02-098	04 - 267	85	04-001	10 - 8901	184	07-303	20 - 1359	515	180RNDD09535	12352	1161	30-093	19 - 1388	472
02-108	03 - 249	74	04-006	39 - 8323	48	07-304	20 - 6593	512	180SLGK09535	12347	1161	30-094	19 - 2788	452
02-110	03 - 251	74	04-007	39 - 8324	48	07-307	20 - 3462	512	18720	36 - 1688	1177	30-095	19 - 1389	471
02-111	03 - 2701	74	04-008	39 - 4791	48	07-308	20 - 2235	514	18720	36 - 12588	1176	30-097	19 - 2773	453
02-113	03 - 252	74	04-015	10 - 10228	178	07-309	20 - 8935	514	188PXBK09535	13589	1149	30-098	19 - 2774	473
02-114	03 - 2702	74	04-112	17 - 1203	39	07-311	20 - 2232	514	188RNDD09535	12348	1165	30-100	19 - 2775	479
02-115	03 - 250	74	04-114	17 - 1202	39	07-314	20 - 8285	514	19-001	27 - 9597	639	30-101	19 - 2777	452
02-128	18 - 1286	34	04-116	17 - 1204	39	07-314	10 - 8295	162	19-002	27 - 9595	639	30-104	19 - 2806	452
02-129	18 - 897	445	04-117	17 - 1205	39	07-318	20 - 12127	513	19-003	27 - 9594	639	30-105	19 - 2778	453
02-130	18 - 1287	34	04-118	17 - 1207	39	07-390	20 - 8678	510	19-005	27 - 9596	639	30-106	19 - 2840	453
02-175	11 - 411	203	04-119	17 - 1206	39	07-391	20 - 8679	510	200ATMD00935	12346	1161	30-107	19 - 5941	452
02-176	11 - 412	49	04-121	17 - 1208	39	07-392	20 - 7730	510	200ATMD17635	12341	1159	30-111	19 - 2829	478
02-177	11 - 413	49	04-150	10 - 314	39	07-400	20 - 1347	34	200ATMZ90535	12334	1157	30-112	19 - 5940	478
02-178	11 - 414	49	04-151	10 - 2964	180	07-403	20 - 868	511	200RNDD00935	12344	1161	30-116	19 - 6553	479
02-179	11 - 415	203	04-152	10 - 317	39	07-404	20 - 8675	511	200RNDD02535	12357	1171	30-117	19 - 2842	481
02-180	11 - 416	49	04-153	10 - 312	39	07-406	20 - 5841	46	200RNDD09535	12332	1157	30-118	19 - 2783	480
02-181	11 - 420	49	04-154	10 - 311	39	07-407	20 - 13116	511	203ATMD00935	12353	1169	30-121	27 - 12377	485
02-182	11 - 417	203	04-155	10 - 316	39	07-408	20 - 5842	46	203RNDD02535	12358	1171	30-122	19 - 12964	455
02-184	11 - 418	203	04-157	10 - 313	39	07-602	20 - 11016	512	203SLGDD02535	14343	1149	30-125	19 - 2780	474
02-187	11 - 399	203	04-158	10 - 318	39	07-700	22 - 14655	535	208RNDD00935	12345	1161	30-129	19 - 6516	473
02-188	11 - 400	49	04-159	10 - 315	179	07-700	22 - 10875	535	21-105	27 - 3510	636	30-130	19 - 11505	471
02-190	11 - 401	49	04-160	10 - 319	39	08-010	01 - 6577	50	21-131	27 - 3515	636	30-130	19 - 2844	472
02-191	11 - 402	49	04-164	10 - 320	39	08-016	01 - 17	44	21-180	27 - 3505	636	30-132	19 - 1396	452
02-192	11 - 403	203	04-170	01 - 1	39	08-023	10 - 310	179	21-195	27 - 3509	636	30-134	19 - 6604	453
02-193	11 - 408	49	04-245	17 - 8801	436	08-150	01 - 16	44	21-205	27 - 5924	636	30-137	27 - 10963	493
02-194	11 - 404	49	04-304	03 - 8506	74	08-152	01 - 22	45	21-230	27 - 5925	636	30-139	19 - 13049	455
02-195	11 - 405	203	04-536	10 - 9296	177	08-200	01 - 10	41	21-265	27 - 5921	636	30-141	19 - 6515	479
02-196	11 - 406	203	04-554	17 - 8802	436	08-201	01 - 14	42	21-280	27 - 5922	636	30-142	19 - 9533	478
02-220	02 - 139	41	04-556	10 - 321	39	08-225	01 - 12	43	21-295	27 - 5923	636	30-145	19 - 12282	454
02-301	02 - 9373	53	04-615	05 - 8970	90	08-250	01 - 6	40	21-305	27 - 5930	636	30-149	39 - 12497	489
02-320	02 - 70	44	04-620	10 - 5705	178	08-300	01 - 8	41	21-330	27 - 5929	636	30-155	39 - 11587	494
02-327	02 - 67	44	046-324	03 - 11516	61	08-331	01 - 7	38	21-355	27 - 6530	636	30-157	19 - 12786	466
02-330	02 - 69	44	05-001	10 - 9717	173	08-375	01 - 9	40	21-380	27 - 5928	636	30-158	19 - 12787	466
02-361	02 - 91	40	05-060	10 - 3223	172	08-410	01 - 11	41	21-395	27 - 5927	636	30-164	19 - 12758	466
02-362	02 - 92	40	05-061	10 - 3306	172	08-710	01 - 18	44	21-505	27 - 3513	636	30-165	19 - 7980	460
02-363	02 - 100	40	05-070	10 - 9268	172	09-004	17 - 1218	39	21-530	27 - 1368	636	30-166	19 - 7980	460
02-365	02 - 99	40	06-004	10 - 9143	174	09-006	17 - 1214	39	21-580	27 - 1344	636	30-170	39 - 13132	488
02-366	02 - 97	40	06-005	10 - 9150	174	09-008	17 - 1216	39	21-595	27 - 1337	636	30-171	39 - 13133	488
02-368	02 - 96	40	07-001	20 - 1348	508	09-009	17 - 1213	39	22270	36 - 1686	1177	30-205	19 - 1381	480
02-373	02 - 94	40	07-003	20 - 1342	508	09-011	17 - 1215	39	22273	36 - 9498	1177	30-301	19 - 2784	479
02-374	02 - 95	40	07-004	38 - 7259	519	09-012	17 - 1217	39	22273	36 - 12582	1176	30-301	19 - 14188	479
02-377	02 - 107	40	07-007	38 - 5831	519	09-238	17 - 1188	39	240RNDD00935	12337	1157	30-303	19 - 6567	463
02-382	02 - 104	40	07-008	38 - 4972	519	09-255	17 - 1189	434	248RNDD00935	12336	1157	30-304	19 - 2828	463
02-388	02 - 84	40	07-009	38 - 4971	519	09-338	17 - 1190	39	27189X	36 - 12036	1177	30-305	19 - 6518	463
02-389	02 - 89	40	07-010	20 - 7293	519	09-801	10 - 2238	175	30-003	27 - 9066	485	30-309	19 - 6705	465
02-391	02 - 87	40	07-011	27 - 8535	519	09-802	10 - 1191	175	30-009	27 - 9067	485	30-311	19 - 6706	465
02-393	02 - 111	40	07-012	22 - 10273	535	09-804	10 - 6886	175	30-015	19 - 8906	461	30-313	19 - 7714	465
02-402	23 - 1435	586	07-016	20 - 1502	505	09-808	10 - 6885	175	30-018	19 - 9841	465	30-316	19 - 7046	474
02-403	23 - 8953	586	07-017	27 - 10206	658	100791X	36 - 14276	1177	30-019	19 - 8327	474	30-317	19 - 7042	462
02-404	23 - 1440	586	07-022	27 - 10468	658	106114	36 - 1603	1175	30-022	19 - 9168	454	30-318	19 - 7044	462
02-406	23 - 8955	586	07-024	20 - 8899	516	106114	36 - 12046	1176	30-024	19 - 7732	480			



AFTERMARKET CROSS REFERENCE

Part No.	Rotary No.	Page No.	Part No.	Rotary No.	Page No.	Part No.	Rotary No.	Page No.	Part No.	Rotary No.	Page No.	Part No.	Rotary No.	Page No.
OREGON			32798X	36 - 12035	1174	33-345	31 - 8051	1076	34-027	13 - 2190	264	36-242	23 - 11285	564
30-422	19 - 6991	481	33-002	31 - 9657	1064	33-347	31 - 9293	1076	34-028	13 - 2191	264	36-243	23 - 11288	564
30-430	19 - 2790	476	33-003	26 - 9362	627	33-348	31 - 10462	1077	34-029	13 - 2192	264	36-244	23 - 11293	564
30-431	19 - 2791	476	33-005	26 - 8498	627	33-352	31 - 11578	1076	34-030	13 - 728	36	36-245	23 - 11298	564
30-432	19 - 2792	476	33-006	26 - 9854	612	33-362	31 - 1780	1076	34-031	13 - 729	36	36-246	23 - 11301	564
30-433	19 - 6585	477	33-007	26 - 9363	627	33-363	31 - 1884	1078	34-032	13 - 8829	292	36-251	23 - 2749	565
30-434	19 - 6584	476	33-015	31 - 9660	1066	33-365	31 - 1778	1075	34-033	13 - 730	36	36-300	23 - 2721	563
30-438	19 - 10477	461	33-019	31 - 9664	1066	33-376	31 - 12685	1060	34-034	13 - 731	36	36-301	23 - 2722	563
30-506	19 - 6691	461	33-020	31 - 8944	85	33-376	31 - 7015	1060	34-035	13 - 732	36	36-302	23 - 2723	563
30-527	19 - 9585	464	33-024	31 - 14672	1062	33-376	31 - 12685	1060	34-036	13 - 2182	263	36-308	23 - 6722	563
30-700	19 - 2789	455	33-026	31 - 9665	1066	33-377	31 - 10723	1060	34-037	13 - 733	36	36-309	23 - 6723	563
30-702	19 - 11042	458	33-027	31 - 9658	1066	33-379	31 - 12839	1061	34-038	13 - 734	36	36-312	23 - 6725	563
30-705	19 - 11230	464	33-028	31 - 9659	1066	33-383	31 - 9623	1060	34-039	13 - 8373	264	36-314	23 - 8826	563
30-709	19 - 7980	460	33-031	31 - 8087	46	33-384	31 - 7675	1064	34-041	13 - 8602	264	36-315	23 - 6727	563
30-710	19 - 2838	456	33-032	31 - 8491	46	33-385	31 - 1928	1061	34-043	13 - 2919	263	36-324	23 - 9829	568
30-720	19 - 2841	455	33-033	31 - 8088	46	33-386	31 - 2922	1062	34-044	13 - 2183	263	36-325	23 - 9830	568
30-736	19 - 6601	455	33-034	31 - 8897	46	33-387	31 - 6545	1061	34-046	13 - 9376	269	36-326	23 - 9831	568
30-740	19 - 8330	480	33-035	31 - 8089	46	33-389	31 - 1931	1061	34-049	13 - 9849	269	36-500	23 - 1511	567
30-761	19 - 9167	456	33-038	31 - 9931	46	33-390	31 - 1930	1063	34-102	13 - 10738	280	36-501	23 - 1510	567
30-762	19 - 8814	456	33-051	31 - 14268	1067	33-391	31 - 7179	1061	34-104	13 - 14255	280	36-504	23 - 8822	567
30-906	19 - 1370	451	33-055	31 - 1897	1077	33-392	31 - 9331	1060	34-201	13 - 12277	273	36-505	23 - 8821	567
30-917	19 - 6524	451	33-057	31 - 1898	1077	33-393	31 - 8601	1063	34-204	13 - 12675	281	36-506	23 - 1509	567
30-963	19 - 12801	460	33-064	31 - 6552	46	33-396	31 - 9330	1061	34-810	13 - 736	264	36-507	23 - 1508	567
30-966	19 - 11205	464	33-070	31 - 1950	1073	33-397	31 - 9158	1059	34-814	13 - 737	264	36-508	23 - 2811	567
30681X	36 - 1646	1174	33-071	31 - 14246	1067	33-398	31 - 9166	1060	34-820	13 - 7126	264	36-510	23 - 8562	567
30853	35 - 10916	1150	33-084	31 - 9661	1068	33-399	31 - 7804	1063	34-822	13 - 7126	264	36-517	23 - 9822	567
31-004	25 - 7290	605	33-085	31 - 9662	1068	33-400	31 - 10297	1080	34-824	13 - 7127	263	36-521	23 - 9826	567
31-006	39 - 11579	1217	33-089	31 - 13278	1069	33-401	31 - 8969	1079	34-826	13 - 7978	263	36-522	23 - 9827	567
31-007	39 - 7067	1216	33-091	31 - 9656	1064	33-402	31 - 9204	1078	34775	35 - 14338	1150	38033	36 - 12045	1177
31-017	26 - 13355	609	33-099	31 - 11219	1069	33-410	31 - 7922	1064	35-001	18 - 2294	438	38065X	36 - 12038	1174
31-023	26 - 10858	609	33-104	10 - 12424	169	33-414	31 - 9206	1080	35-002	18 - 1272	34	39520	35 - 10916	1150
31-025	26 - 9180	609	33-105	31 - 7015	1060	33-415	31 - 9207	1080	35-004	18 - 1278	439	4-264	23 - 7211	577
31-030	26 - 10867	609	33-106	31 - 9655	1060	33-416	31 - 10294	1079	35-005	18 - 1275	34	40-121	16 - 6172	421
31-049	26 - 10469	624	33-110	10 - 9910	164	33-417	31 - 10293	1078	35-006	18 - 1277	439	40-130	16 - 2671	422
31-050	26 - 10983	626	33-111	10 - 9912	164	33-418	31 - 10296	1079	35-007	18 - 1270	34	40-131	16 - 2670	423
31-051	26 - 1325	626	33-112	10 - 9911	164	33-419	31 - 10295	1080	35-008	18 - 1279	444	40-132	16 - 2669	423
31-052	26 - 9064	623	33-113	10 - 9913	164	33-430	31 - 10771	1071	35-009	18 - 1280	444	40-140	16 - 2663	421
31-053	26 - 9063	623	33-114	10 - 11858	167	33-431	31 - 10772	1071	35-012	18 - 1269	439	40-141	16 - 6107	421
31-056	26 - 10384	610	33-117	10 - 11664	168	33-700	26 - 9796	612	35-014	18 - 1283	440	40-316	16 - 2148	423
31-057	26 - 10324	611	33-118	10 - 11070	170	33-701	26 - 9797	612	35-015	18 - 2283	444	40-402	16 - 1138	422
31-058	26 - 9180	609	33-119	10 - 11071	164	33-702	26 - 9800	617	35-016	18 - 2281	443	40-403	16 - 1143	422
31-061	26 - 10385	622	33-119-1	10 - 11071	164	33-704	26 - 9802	617	35-021	18 - 891	438	40-404	16 - 1144	423
31-062	26 - 12329	622	33-121	10 - 14495	164	33-707	26 - 9814	619	35-022	18 - 8003	440	40-408	16 - 1137	422
31-065	26 - 12330	622	33-122-1	10 - 12980	164	33-708	26 - 9798	612	35-026	18 - 859	440	40-409	16 - 1148	423
31-068	26 - 12368	622	33-123	10 - 12228	165	33-709	26 - 9799	612	35-027	18 - 7867	440	40-411	16 - 1139	423
31-070	26 - 12019	624	33-124	10 - 13973	165	33-710	26 - 9975	618	35-028	18 - 2282	443	40-502	16 - 1145	422
31-100	25 - 1318	604	33-126-1	10 - 11829	169	33-711	26 - 9980	620	35-032	18 - 2284	444	40-503	16 - 2673	423
31-103	26 - 10465	609	33-127	10 - 11073	166	33-712	26 - 9979	620	35-033	18 - 7239	443	40-705	15 - 10968	335
31-107	26 - 7927	610	33-128	10 - 12227	165	33-713	26 - 9981	620	35-034	18 - 10272	441	40-705	15 - 6324	335
31-108	26 - 10464	611	33-133	10 - 11859	165	33-714	26 - 10262	617	35-036	18 - 14449	441	40-707	15 - 8720	335
31-109	25 - 10473	604	33-134	10 - 12621	165	33-715	26 - 9976	617	35-037	18 - 14450	441	40-807	16 - 1147	424
31-140	25 - 9341	603	33-135	10 - 11237	167	33-716	26 - 9990	620	35-045	18 - 14594	441	40-840	16 - 6276	422
31-142	25 - 9342	603	33-137	10 - 11075	167	33-718	26 - 9977	616	35-050	18 - 13625	442	40-843	16 - 2658	424
31-150	25 - 9343	603	33-138	10 - 14009	164	33-719	26 - 9974	612	35-543	18 - 2286	441	40-845	16 - 2661	424
31-152	25 - 9344	603	33-139	10 - 12247	165	33-722	26 - 9997	617	35-903	18 - 2288	443	40469A	33 - 4273	1128
31-160	25 - 9345	603	33-182	31 - 1772	1075	33-730	26 - 10561	615	35-904	18 - 2289	443	4090L	32 - 13060	1115
31-202	25 - 4969	604	33-184	10 - 11072	165	33-733	26 - 12065	614	36-001	23 - 1453	558	4090XL	32 - 13061	1115
31-232	25 - 1300	603	33-185	10 - 14045	166	33-734	26 - 12087	614	36-002	23 - 1461	558	4092E	33 - 7761	1133
31-240	25 - 1301	603	33-186	31 - 6781	1075	33-735	26 - 10674	613	36-004	23 - 1463	558	41-005	05 - 5803	93
31-242	25 - 1302	603	33-187	10 - 11075	167	33-736	26 - 10975	621	36-005	23 - 1466	558	41-008	10 - 8755	182
31-250	25 - 1303	603	33-188	10 - 11445	169	33-737	26 - 10976	621	36-006	23 - 2475	558	42-008	31 - 2932	1069
31-252	25 - 1304	603	33-189	10 - 11074	170	33-738	26 - 10982	621	36-007	23 - 2476	559	42-009	31 - 2938	1068
31-260	25 - 1305	603	33-200	24 - 9370	599	33-740	26 - 10709	612	36-009	23 - 2479	558	42-016-0	32 - 9788	1089
31-540	25 - 1308	603	33-201	24 - 1298	600	33-760	26 - 10084	628	36-010	23 - 8946	559	42-031	32 - 9099	1093
31-542	25 - 1309	603	33-207	31 - 4720	1070	33-763	26 - 10085	628	36-016	23 - 6773	558	42-032	32 - 2302	1083
31-550	25 - 1310	603	33-208	24 - 6710	599	33-768	26 - 11022	62						

AFTERMARKET CROSS REFERENCE



Part No.	Rotary No.	Page No.	Part No.	Rotary No.	Page No.	Part No.	Rotary No.	Page No.	Part No.	Rotary No.	Page No.	Part No.	Rotary No.	Page No.
OREGON														
42-516	32 - 1726	1090	45-025	09 - 6625	130	46-300	03 - 8415	63	49-060	23 - 2709	556	49-262	38 - 8134	50
42-550	33 - 1746	1125	45-028	09 - 8995	139	46-302	05 - 8568	71	49-065	23 - 6529	582	49-263	23 - 7211	577
42-551	33 - 1747	1125	45-030	09 - 8305	147	46-306	03 - 10118	59	49-067	23 - 7963	576	49-301	22 - 1421	544
42-552	33 - 9091	1125	45-031	09 - 6534	135	46-319	03 - 9134	60	49-069	23 - 8746	575	49-302	23 - 3545	575
42-553	33 - 1745	1125	45-032	09 - 10303	135	46-322	05 - 14623	68	49-070	22 - 10086	539	49-303	23 - 3546	575
42-560	33 - 9393	1120	45-032	09 - 7162	134	46-323	03 - 9133	60	49-071	22 - 2885	539	49-304	22 - 10931	541
42-561	33 - 9393	1120	45-034	09 - 327	39	46-325	03 - 9566	68	49-075	23 - 8369	581	49-305	22 - 10237	540
42-912	33 - 7096	1130	45-035	09 - 487	133	46-416	05 - 9694	72	49-076	22 - 7967	538	49-307	22 - 8591	533
43-007	26 - 1339	608	45-037	09 - 7241	135	47-014	31 - 8600	1058	49-077	22 - 1424	537	49-311	23 - 3543	576
43-008	26 - 1338	608	45-040	09 - 8984	147	47-038	31 - 8599	1058	49-078	22 - 11140	540	49-355	23 - 1498	576
43-011	26 - 852	608	45-043	09 - 7258	146	47-050	31 - 8598	1058	49-079	20 - 8959	51	49-358	22 - 1431	537
43-012	26 - 860	608	45-044	10 - 8322	137	47-051	31 - 8597	1058	49-080	22 - 8047	532	49-401	22 - 2886	541
43-014	26 - 8286	609	45-046	09 - 13467	136	47-080	31 - 1940	1057	49-081	23 - 7946	575	49-402	23 - 3551	579
43-026	10 - 6974	171	45-047	09 - 7950	131	47-081	31 - 1932	1057	49-083	22 - 182	530	49-403	23 - 3554	579
43-058	26 - 2240	628	45-048	09 - 10264	134	47-120	31 - 1941	1057	49-084	22 - 12933	534	49-411	23 - 3550	579
43-075	10 - 2224	172	45-050	09 - 10265	134	47-121	31 - 1933	1057	49-085	20 - 9289	51	49-412	23 - 8951	571
43-100	26 - 875	608	45-052	09 - 9041	138	47-160	31 - 1942	1057	49-089	23 - 1497	576	49-420	22 - 13265	542
43-200	26 - 876	608	45-053	09 - 5812	137	47-161	31 - 1934	1057	49-090	23 - 7965	576	49-421	22 - 13266	543
43-399	26 - 5876	629	45-058	09 - 326	39	47-200	31 - 1943	1057	49-095	23 - 7966	577	49-422	22 - 13267	542
43-400	26 - 1326	629	45-060	09 - 8998	140	47-201	31 - 1935	1057	49-098	23 - 3547	575	49-426	22 - 13270	543
43-402	26 - 1327	629	45-062	09 - 9275	141	47-689	31 - 8596	1058	49-099	23 - 1494	576	49-427	22 - 13271	543
43-403	26 - 1327	629	45-071	09 - 13229	145	48-001	10 - 2934	172	49-100	23 - 2734	581	49-428	22 - 13272	543
43-404	26 - 1324	608	45-072	09 - 13468	136	48-003	10 - 3301	171	49-101	22 - 1413	539	49-429	22 - 13273	543
43-407	26 - 1333	630	45-074	09 - 12857	146	48-004	09 - 7839	143	49-102	22 - 2884	539	49-430	22 - 13274	543
43-408	26 - 1329	629	45-078	09 - 5721	146	48-006	10 - 8985	162	49-106	23 - 6525	576	49-433	22 - 13276	543
43-409	26 - 1334	629	45-079	09 - 339	146	48-007	09 - 8586	141	49-107	23 - 2733	581	49-501	23 - 2740	581
43-527	37 - 1701	1180	45-080	09 - 329	39	48-009	09 - 8409	140	49-108	23 - 7173	577	49-502	23 - 2741	581
43-528	37 - 3009	1180	45-081	09 - 854	145	48-011	09 - 8409	140	49-109	23 - 7941	576	49-602	23 - 1469	571
43-540	37 - 3037	1180	45-082	09 - 3200	146	48-043	04 - 486	84	49-110	23 - 7248	582	49-667	23 - 2681	584
43-543	26 - 13533	633	45-083	09 - 853	143	48-045	04 - 472	82	49-111	23 - 3672	576	49-693	22 - 1416	539
43-562	37 - 3023	1180	45-084	09 - 2935	146	48-048	04 - 469	82	49-112	23 - 2735	581	49-694	22 - 10942	536
43-583	37 - 3025	1180	45-085	09 - 382	143	48-049	04 - 470	82	49-114	23 - 8228	582	49-795	22 - 1420	537
43-685	26 - 2444	633	45-087	09 - 2936	145	48-050	04 - 471	82	49-115	23 - 7246	582	49-801	38 - 1551	1191
43-694	37 - 3068	1181	45-088	09 - 3202	144	48-066	10 - 8671	161	49-116	23 - 1493	576	49-802	38 - 1544	1191
43-699	26 - 2445	633	45-089	09 - 3201	144	48-071	10 - 8690	162	49-118	23 - 6523	576	49-803	38 - 3644	1191
44-100	13 - 8657	281	45-091	09 - 3209	144	48-072	10 - 8689	162	49-119	23 - 8414	575	49-804	38 - 3667	1191
44-301	13 - 750	266	45-092	09 - 3211	146	48-080	10 - 2219	161	49-120	23 - 2736	581	49-805	38 - 4183	1191
44-305	13 - 751	266	45-094	09 - 3222	146	48-100	10 - 2221	158	49-122	23 - 3538	576	49-806	38 - 4182	1194
44-306	13 - 752	266	45-098	09 - 3305	146	48-101	10 - 2223	158	49-123	23 - 7943	575	49-807	38 - 4186	1195
44-307	13 - 753	266	45-100	09 - 7836	144	48-132	10 - 6580	157	49-126	23 - 1478	576	49-809	38 - 4209	1194
44-308	13 - 754	266	45-101	09 - 2939	144	48-141	10 - 8372	175	49-127	23 - 7781	577	49-810	38 - 4184	1195
44-310	13 - 756	266	45-103	10 - 2209	174	48-145	05 - 7787	91	49-128	20 - 1503	508	49-812	38 - 4179	1195
44-312	13 - 758	266	45-104	10 - 2210	174	48-146	42 - 8250	1231	49-129	23 - 8226	575	49-814	38 - 4181	1194
44-313	13 - 759	266	45-107	09 - 6863	147	48-200	10 - 2218	157	49-131	23 - 3673	575	49-815	23 - 7234	578
44-315	13 - 761	266	45-108	09 - 367	137	48-202	10 - 7125	157	49-132	23 - 8225	581	49-816	38 - 4180	1195
44-316	13 - 762	266	45-110	05 - 3244	94	48-205	10 - 2243	156	49-133	22 - 10948	542	49-820	38 - 9298	1201
44-318	13 - 764	266	45-111	10 - 11031	174	48-211	09 - 8077	132	49-135	22 - 7969	538	49-822	38 - 9297	1201
44-319	13 - 765	266	45-112	09 - 324	39	48-230	42 - 7097	1231	49-137	22 - 7951	538	49-826	38 - 6893	1203
44-321	13 - 767	266	45-114	10 - 2212	174	48-270	13 - 2184	272	49-141	23 - 10467	584	49-827	38 - 5829	1198
44-322	13 - 768	266	45-117	10 - 13457	174	48-320	09 - 5707	147	49-143	23 - 10480	578	49-829	38 - 4302	1197
44-323	13 - 2926	284	45-125	10 - 8304	175	48-401	04 - 485	84	49-145	22 - 10935	540	49-830	38 - 7218	1198
44-326	13 - 2929	284	45-126	09 - 8488	135	49-001	22 - 8364	529	49-146	22 - 10939	540	49-835	38 - 4301	1195
44-331	13 - 9514	285	45-128	09 - 7279	143	49-002	22 - 1427	528	49-147	22 - 10933	540	49-839	38 - 6568	1197
44-332	13 - 3317	284	45-130	09 - 8437	132	49-003	22 - 1426	528	49-148	22 - 10937	541	49-840	22 - 1408	542
44-340	13 - 7986	284	45-131	09 - 2703	130	49-004	22 - 1425	528	49-149	22 - 10938	540	49-841	23 - 3539	578
44-341	13 - 7417	283	45-132	10 - 9159	174	49-005	22 - 1429	528	49-150	23 - 3552	579	49-843	38 - 7215	1195
44-342	13 - 7993	284	45-158	09 - 481	131	49-006	22 - 1428	528	49-153	23 - 1501	579	49-844	38 - 4923	1195
44-343	13 - 7995	284	45-162	09 - 1264	131	49-007	22 - 7721	528	49-154	23 - 2737	581	49-848	38 - 8260	1197
44-347	13 - 436	291	45-188	09 - 7262	142	49-008	22 - 8380	529	49-155	23 - 2743	578	49-850	38 - 9199	1202
44-348	13 - 769	266	45-201	09 - 8863	134	49-009	22 - 9971	534	49-157	23 - 7801	578	49-854	38 - 4210	1200
44-351	13 - 772	266	45-203	09 - 483	132	49-010	33 - 19088	1129	49-160	23 - 6521	575	49-858	38 - 5839	1201
44-353	13 - 774	266	45-205	09 - 813	133	49-016	23 - 1449	579	49-163	23 - 2747	571	49-860	38 - 4996	1200
44-364	10 - 9145	194	45-208	09 - 3228	131	49-017	38 - 8365	1194	49-170	23 - 7168	580	49-875	38 - 8261	1197
44-365	13 - 10185	282	45-209	09 - 3229	130	49-018	05 - 7255	93	49-193	23 - 11990	557	49-877	38 - 8260	1197
44-367	13 - 10186	282	45-220	09 - 3217	134	49-020	20 - 9478	51	49-201	22 - 1409	544	49-883	38 - 12998	1201
44-368	13 - 8965	282	45-225	09 - 8488	135	49-021	38 - 3655	47	49-204	23 - 8825	556	49-885-0	38 - 5840	



AFTERMARKET CROSS REFERENCE

Part No.	Rotary No.	Page No.	Part No.	Rotary No.	Page No.	Part No.	Rotary No.	Page No.	Part No.	Rotary No.	Page No.	Part No.	Rotary No.	Page No.
OREGON			54-005	33 - 11600	1132	55-401	27 - 11830	640	65-206	17 - 1167	430	70-317	08 - 7025	122
50-105	23 - 3530	582	54-006	33 - 10675	1132	55-402	27 - 11831	640	65-208	17 - 5935	430	70-319	08 - 7026	121
50-201	23 - 3531	583	54-019	33 - 10166	1133	55-450	27 - 7905	75	65-220	17 - 7810	429	70-320	08 - 346	122
50-204	23 - 3651	583	54-029	33 - 9089	1129	55-460	27 - 7141	648	65-221	17 - 6626	428	70-321	08 - 10098	119
50-206	23 - 3653	583	55-001	33 - 2677	1125	55-465	27 - 9043	655	65-228	17 - 7119	429	70-323	08 - 5918	120
50-302	23 - 2745	574	55-002	27 - 30101	642	55-500	27 - 4300	490	65-229	17 - 1178	431	70-324	08 - 8917	121
50-310	23 - 2754	573	55-008	20 - 9026	516	55-501	27 - 7207	493	65-230	17 - 6793	432	70-326	08 - 5947	122
50-311	23 - 9381	573	55-009	20 - 7931	517	55-504	27 - 7206	490	65-233	17 - 423	434	70-327	08 - 7027	121
50-402	23 - 1405	571	55-017	20 - 7408	517	55-506	27 - 6966	485	65-300	17 - 1152	431	70-328	08 - 7028	122
50-403	23 - 1406	571	55-018	20 - 8737	517	55-509	27 - 3122	486	67-001	41 - 5554	1227	70-330	08 - 8541	122
50-405	23 - 1471	571	55-021	27 - 30048	647	55-510	27 - 8713	491	67-002	41 - 5570	1227	70-333	08 - 8939	120
50-408	23 - 13526	572	55-035	27 - 6994	642	55-515	39 - 13119	490	67-005	41 - 5559	1227	70-335	08 - 7029	122
50-410	23 - 14548	572	55-035-1	27 - 6994	642	55-707	27 - 6968	659	67-008	41 - 5565	1227	70-337	08 - 7695	122
50-412	23 - 9261	571	55-068	27 - 9395	643	55-741	27 - 9224	643	67-009	41 - 5550	1227	70-338	08 - 7030	122
50-413	23 - 9842	572	55-092	27 - 7864	658	55-803	27 - 7235	660	67-010	41 - 5553	1227	70-346	08 - 5948	120
50-414	23 - 9731	572	55-095	27 - 7897	642	55-811	39 - 8287	1216	67-012	41 - 5552	1227	70-351	08 - 7033	122
50-415	23 - 9782	573	55-095-1	27 - 7897	642	55-813	26 - 9045	610	67-013	41 - 5551	1227	70-353	08 - 9154	121
50-416	23 - 9843	572	55-097	20 - 7932	517	55-816	27 - 8521	660	67-014	41 - 5571	1227	70-355	08 - 7696	122
50-418	23 - 9784	572	55-102	20 - 7883	517	55-821	27 - 8518	660	67-015	41 - 5556	1227	70-356	08 - 8007	120
50-419	23 - 9732	573	55-109	20 - 7882	517	55-951	27 - 11800	661	67-017	41 - 5558	1227	70-357	08 - 8688	121
50-420	23 - 10481	578	55-111	39 - 7777	1070	55-954	27 - 8572	661	67-018	41 - 5557	1227	70-358	08 - 8919	120
50-422	23 - 10483	578	55-118	27 - 8532	658	55481	27 - 11832	640	67-019	41 - 5572	1227	70-361	08 - 8007	120
50-423	23 - 13518	578	55-119	27 - 8533	496	56-001	39 - 8397	1214	67-020	41 - 5535	1227	70-361	08 - 8006	120
50-424	23 - 13519	578	55-120	20 - 7233	515	56-002	39 - 8398	1214	67-100-0	32 - 7764	1098	70-362	08 - 9549	120
50-425	23 - 13520	578	55-121	27 - 7928	659	56-003	39 - 8399	1214	67-101	33 - 8502	1126	70-364	08 - 9711	120
50-426	23 - 13517	578	55-122	20 - 9048	516	56-005	32 - 12614	1090	67-102	33 - 7762	1126	70-366	08 - 9186	120
50-428	23 - 14146	570	55-123	20 - 7233	515	56-008	39 - 7773	1214	67-103	33 - 10328	1126	70-367	08 - 9187	120
50-429	23 - 13515	570	55-124	20 - 9652	516	56-011	39 - 7771	1214	67-104	33 - 10346	1126	70-368	08 - 9188	120
50-435	23 - 11077	569	55-125	20 - 9603	513	56-017	20 - 9562	516	67-105	32 - 7763	1098	70-370	08 - 9189	120
50-450	23 - 13650	584	55-126	20 - 9604	513	56-018	39 - 7083	518	68-001	08 - 879	119	70-371	08 - 10127	120
50-451	23 - 10471	584	55-132	20 - 8526	518	56-019	39 - 7081	518	68-011	08 - 903	121	70-372	08 - 9744	120
50-454	23 - 10864	584	55-139	20 - 7933	519	57-001	33 - 4223	1134	68-012	08 - 361	121	70-373	08 - 9190	120
50-502	23 - 2961	580	55-140-0	27 - 14368	641	57-002	33 - 4219	1134	68-020	08 - 341	118	70-374	08 - 9283	120
50-503	23 - 2971	580	55-141-0	27 - 14369	641	57-003	33 - 5889	1134	68-021	08 - 342	118	70-375	08 - 8918	120
50-505	23 - 2970	580	55-145-1	27 - 14375	641	57-005	33 - 8977	1134	68-022	08 - 343	118	70-376	08 - 8915	120
50-508	23 - 2956	557	55-146-1	27 - 14377	641	57-006	33 - 4220	1134	68-023	08 - 9324	118	70-377	08 - 8888	122
50-509	23 - 2956	557	55-147-1	27 - 14374	641	57-010	33 - 4215	1134	68-024	08 - 344	118	70-379	08 - 8084	121
50-510	23 - 2974	581	55-148-1	27 - 14376	641	57-020	33 - 14139	1135	68-030	08 - 303	118	70-403	08 - 12764	122
50-520	05 - 3245	94	55-157	20 - 9607	519	57-430	32 - 4253	1103	68-031	08 - 302	118	70-406	08 - 12766	122
50-541	23 - 1484	569	55-158	26 - 9617	610	57-431	32 - 4252	1103	68-040	08 - 906	121	70-700	32 - 8081	1098
50-542	23 - 1480	569	55-185	27 - 3512	655	57-465	33 - 4013	1127	68-050	08 - 5894	121	70-701	08 - 8264	108
50-543	23 - 8413	569	55-186	27 - 8570	655	60-000	03 - 9679	57	68-060	08 - 8636	118	70-703	32 - 8191	1098
50-544	23 - 1479	569	55-187	20 - 10392	51	60-001	03 - 10951	58	68-062	08 - 7328	118	71-001	08 - 368	117
50-545	23 - 8242	569	55-188	20 - 10393	51	60-002	03 - 9681	59	68-063	08 - 828	118	71-002	08 - 364	117
50-546	23 - 8243	569	55-189	20 - 10394	51	60-003	03 - 9683	59	68-067	08 - 883	118	71-003	08 - 7147	124
50-547	23 - 2732	569	55-190	20 - 10395	51	60-004	03 - 9680	57	68-071	08 - 347	118	71-004	08 - 7261	124
50-548	23 - 2760	570	55-201	27 - 8735	485	60-006	03 - 9685	62	68-072	08 - 8542	118	71-096	08 - 9621	123
50-550	23 - 9839	570	55-207	39 - 3111	486	60-009	03 - 866	59	68-075	08 - 362	118	71-098	08 - 899	124
50-553	23 - 9838	570	55-211	39 - 1550	487	60-010	03 - 7717	60	68-077	08 - 348	118	71-100	08 - 7828	124
50-555	23 - 13514	570	55-212	39 - 3109	489	60-012	03 - 9131	60	68-078	08 - 7201	122	71-101	08 - 360	123
50-603	22 - 11164	545	55-214	39 - 3108	489	60-014	03 - 9855	61	68-079	08 - 7202	122	71-102	08 - 7811	123
50-605	22 - 11147	549	55-218	39 - 3105	489	60-022	03 - 9569	60	68-081	08 - 3275	118	71-104	08 - 898	124
50-607	22 - 11166	549	55-226	39 - 3112	490	60-028	03 - 11640	64	68-084	08 - 921	119	71-105	08 - 3265	125
50-608	22 - 11145	550	55-227	39 - 6985	485	60-039	03 - 14624	59	68-086	08 - 913	119	71-106	08 - 6954	125
50-609	22 - 11150	549	55-231	27 - 5864	486	60-048	04 - 262	78	68-110	08 - 8514	119	71-107	08 - 305	125
50-610	22 - 11150	549	55-236	39 - 5834	493	60-059	03 - 14324	57	68-111	08 - 829	119	71-108	08 - 304	125
50-618	22 - 11176	545	55-240	39 - 3116	494	60-061	03 - 233	65	68-113	08 - 830	119	71-110	08 - 6571	124
50-619	22 - 11177	545	55-241	39 - 5907	494	60-065	04 - 264	78	68-114	08 - 10098	119	71-250	08 - 884	123
50-620	22 - 11178	545	55-242	39 - 5906	494	60-068	03 - 14325	57	68-115	08 - 833	119	71-274	08 - 880	123
50-621	22 - 11179	545	55-243	39 - 12570	495	60-082	03 - 6992	64	68-130	08 - 8194	119	71-275	08 - 3266	123
50-634	22 - 13196	548	55-244	19 - 9776	492	60-100	03 - 223	56	68-131	08 - 908	119	71-276	08 - 9620	123
50-636	22 - 13202	547	55-246	39 - 12572	495	60-124	03 - 9682	59	68-132	08 - 349	119	71-278	08 - 9619	123
50-637	22 - 13199	548	55-248	39 - 12571	495	60-125	03 - 9693	64	68-133	08 - 350	119	71-279	08 - 6953	125
50-640	22 - 13141	551	55-249	19 - 9608	492	60-160	03 - 6658	56	68-134	08 - 351	119	71-400	08 - 352	123
50-641	22 - 13142	551	55-253	27 - 7929	659	60-166	03 - 242	62	68-135	08 - 8949	119	71-405	08 - 357	123
50-642	22 - 13143	551	55-255	27 - 9686	76	60-186	03 - 239	65	68-136	08 - 9201	119	71-500	08 - 353	123

AFTERMARKET CROSS REFERENCE



Part No.	Rotary No.	Page No.	Part No.	Rotary No.	Page No.	Part No.	Rotary No.	Page No.	Part No.	Rotary No.	Page No.	Part No.	Rotary No.	Page No.
OREGON			74-317	03 - 9136	74	75-175	12 - 8092	246	75-402	12 - 7545	215	75-498	12 - 7541	215
72-304	07 - 3320	106	74-732	03 - 248	74	75-177	12 - 9257	246	75-403	12 - 7546	215	75-499	12 - 7542	215
72-304	07 - 6918	104	75-000	12 - 9336	223	75-179	12 - 6970	240	75-404	12 - 7547	215	75-500	12 - 7645	216
72-306	07 - 6915	105	75-002	12 - 6839	233	75-180	12 - 8803	242	75-405	12 - 7548	215	75-503	12 - 7648	216
72-307	07 - 6918	104	75-005	12 - 4998	237	75-186	12 - 9016	247	75-406	12 - 7549	215	75-508	12 - 669	240
72-309	07 - 8201	107	75-007	12 - 6896	240	75-187	12 - 10257	247	75-407	12 - 7550	215	75-525	12 - 7570	216
72-311	07 - 6917	103	75-009	12 - 6907	235	75-188	12 - 9014	247	75-408	12 - 7551	215	75-526	12 - 7571	216
72-316	06 - 5873	100	75-010	12 - 5061	212	75-192	12 - 10090	241	75-409	12 - 7552	215	75-527	12 - 7572	216
72-318	07 - 430	106	75-012	12 - 6906	233	75-194	12 - 9945	222	75-410	12 - 7553	215	75-528	12 - 7573	216
72-335	08 - 8684	114	75-016	12 - 6838	233	75-195	12 - 9367	222	75-411	12 - 7554	215	75-529	12 - 7574	216
72-406	06 - 3459	96	75-018	12 - 6841	233	75-196	12 - 8781	223	75-413	12 - 7556	215	75-530	12 - 7575	216
72-407	06 - 3460	96	75-021	12 - 6843	233	75-198	12 - 9312	223	75-414	12 - 7557	215	75-531	12 - 7576	216
72-408	06 - 3461	96	75-022	12 - 6903	237	75-199	12 - 10029	243	75-417	12 - 9900	235	75-532	12 - 7577	216
72-410	06 - 285	97	75-023	12 - 6949	235	75-205	12 - 5231	258	75-423	12 - 7466	215	75-533	12 - 7578	216
72-420	08 - 872	115	75-024	12 - 9570	233	75-208	12 - 10027	243	75-424	12 - 7467	215	75-534	12 - 7579	216
72-427	06 - 274	96	75-026	12 - 6502	237	75-209	12 - 9995	238	75-425	12 - 7468	215	75-535	12 - 7580	216
72-430	06 - 276	96	75-028	12 - 6845	235	75-210	12 - 9713	239	75-426	12 - 7469	215	75-536	12 - 7581	216
72-434	06 - 2985	99	75-029	12 - 6842	236	75-211	12 - 10011	244	75-427	12 - 7470	215	75-537	12 - 7582	216
72-436	06 - 2980	97	75-031	12 - 5867	246	75-212	12 - 6969	242	75-428	12 - 7471	215	75-538	12 - 7583	216
72-437	06 - 278	96	75-035	12 - 6844	233	75-214	12 - 6636	212	75-429	12 - 7472	215	75-539	12 - 7584	216
72-441	07 - 2990	102	75-038	12 - 6503	237	75-215	12 - 10317	255	75-430	12 - 7473	215	75-540	12 - 7585	216
72-442	06 - 286	99	75-040	12 - 6504	237	75-216	12 - 10044	255	75-431	12 - 7474	215	75-541	12 - 7586	216
72-449	06 - 289	97	75-041	12 - 6904	238	75-220	12 - 10023	243	75-432	12 - 7475	215	75-542	12 - 7587	216
72-450	06 - 271	99	75-042	12 - 9994	238	75-223	12 - 5237	242	75-433	12 - 7476	215	75-543	12 - 7588	216
72-500	06 - 2977	97	75-043	12 - 7791	254	75-228	12 - 8812	246	75-434	12 - 7477	215	75-544	12 - 7589	216
72-508	06 - 2976	97	75-044	12 - 8714	255	75-229	12 - 8091	246	75-435	12 - 7478	215	75-545	12 - 7590	216
72-510	06 - 272	99	75-045	12 - 6505	237	75-230	12 - 10037	247	75-436	12 - 7479	215	75-546	12 - 7591	216
72-705	08 - 8494	109	75-052	12 - 10402	255	75-231	12 - 12405	247	75-437	12 - 7480	215	75-547	12 - 7592	216
72-706	08 - 8581	109	75-054	12 - 5236	254	75-232	12 - 10251	247	75-438	12 - 7481	215	75-548	12 - 7593	216
72-707	08 - 8580	109	75-055	12 - 7790	254	75-234	12 - 9863	248	75-439	12 - 8427	221	75-549	12 - 7594	216
72-709	06 - 2984	98	75-057	12 - 6507	238	75-235	12 - 10252	248	75-439	12 - 7482	215	75-550	12 - 7595	216
72-717	08 - 9804	108	75-060	12 - 7952	241	75-240	12 - 5242	242	75-439	12 - 7444	214	75-551	12 - 7596	216
72-727	08 - 7285	114	75-061	12 - 6508	238	75-260	12 - 5235	254	75-440	12 - 7483	215	75-552	12 - 8092	246
72-728	08 - 8278	114	75-063	12 - 6509	238	75-263	12 - 10009	235	75-441	12 - 7484	215	75-553	12 - 7598	216
72-729	08 - 7285	114	75-065	12 - 7245	238	75-264	12 - 10100	236	75-442	12 - 7485	215	75-554	12 - 7599	216
72-730	08 - 9151	113	75-066	12 - 9861	241	75-266	12 - 9712	238	75-443	12 - 7486	215	75-555	12 - 7600	216
72-732	08 - 8197	111	75-068	12 - 673	240	75-267	12 - 9714	239	75-444	12 - 7487	215	75-556	12 - 7601	216
72-733	08 - 11062	110	75-070	12 - 6836	242	75-268	12 - 10043	255	75-445	12 - 7488	215	75-557	12 - 7602	216
72-736	08 - 10711	112	75-073	12 - 675	237	75-270	12 - 10411	255	75-446	12 - 7489	215	75-558	12 - 7603	216
72-737	08 - 11217	110	75-079	12 - 9900	235	75-281	12 - 6840	233	75-447	12 - 7490	215	75-559	12 - 7604	216
72-745	06 - 3239	98	75-084	12 - 8425	221	75-283	12 - 10036	244	75-448	12 - 7491	215	75-560	12 - 7605	216
72-746	06 - 2998	97	75-088	12 - 5078	212	75-288	12 - 6896	240	75-449	12 - 7492	215	75-561	12 - 7606	216
72-747	06 - 2999	98	75-091	12 - 6950	233	75-293	12 - 12256	247	75-450	12 - 7493	215	75-562	12 - 7607	216
72-756	08 - 11063	110	75-094	12 - 8444	238	75-295	12 - 12077	230	75-451	12 - 7494	215	75-563	12 - 7608	216
72-771	08 - 11062	110	75-095	12 - 8810	242	75-296	12 - 14390	231	75-452	12 - 7495	215	75-564	12 - 7609	216
72-795	08 - 3276	112	75-096	12 - 8428	221	75-299	12 - 12373	231	75-453	12 - 7496	215	75-565	12 - 7610	216
72-796	08 - 3276	112	75-097	12 - 8463	222	75-300	12 - 12078	231	75-454	12 - 7497	215	75-566	12 - 7611	216
72-802	08 - 378	116	75-098	12 - 8432	221	75-324	12 - 7429	214	75-455	12 - 7498	215	75-567	12 - 7612	216
72-803	08 - 377	116	75-099	12 - 8516	223	75-325	12 - 7430	214	75-456	12 - 7499	215	75-568	12 - 7613	216
72-804	08 - 379	116	75-101	12 - 5063	212	75-326	12 - 7431	214	75-457	12 - 7500	215	75-569	12 - 7614	216
72-807	08 - 369	117	75-103	12 - 8442	238	75-327	12 - 7432	214	75-458	12 - 7501	215	75-570	12 - 7615	216
73-001	41 - 5508	1225	75-104	12 - 8430	221	75-328	12 - 7433	214	75-459	12 - 7502	215	75-571	12 - 7616	216
73-003	41 - 5509	1225	75-105	12 - 870	224	75-329	12 - 7434	214	75-460	12 - 7503	215	75-572	12 - 7617	216
73-006	41 - 5505	1224	75-106	12 - 8511	222	75-330	12 - 7435	214	75-461	12 - 7504	215	75-573	12 - 7618	216
73-008	41 - 5513	1223	75-107	12 - 6901	222	75-331	12 - 7436	214	75-462	12 - 7505	215	75-574	12 - 7619	216
73-010	41 - 5506	1224	75-108	12 - 8465	222	75-332	12 - 7437	214	75-463	12 - 7506	215	75-575	12 - 7620	216
73-013	41 - 5514	1224	75-109	12 - 9581	234	75-333	12 - 7438	214	75-464	12 - 7507	215	75-576	12 - 7621	216
73-014	41 - 5515	1224	75-112	12 - 6876	237	75-333	12 - 8429	221	75-465	12 - 7508	215	75-577	12 - 7622	216
73-016	41 - 5521	1225	75-113	12 - 8805	246	75-334	12 - 7439	214	75-466	12 - 7509	215	75-578	12 - 7623	216
73-017	41 - 5523	1223	75-116	12 - 8464	223	75-335	12 - 7440	214	75-467	12 - 7510	215	75-579	12 - 7624	216
73-018	41 - 5524	1224	75-117	12 - 8431	221	75-336	12 - 7441	214	75-468	12 - 7511	215	75-580	12 - 7625	216
73-018	41 - 5539	1225	75-118	12 - 9482	235	75-336	12 - 8426	221	75-469	12 - 7512	215	75-581	12 - 7626	216
73-019	41 - 5525	1224	75-119	12 - 6908	235	75-337	12 - 7442	214	75-470	12 - 7513	215	75-582	12 - 7627	216
73-020	41 - 7766	1228	75-120	12 - 5052	212	75-338	12 - 7443	214	75-471	12 - 7514	215	75-583	12 - 7628	216
73-022	41 - 5531	1223	75-122	12 - 8747	238	75-339	12 - 9901	235	75-472	12 - 7515	215	75-584	12 - 7629	216
73-023	41 - 5532	1225	75-123	12 - 8761	232	75-340	12 - 7445	214	75-473	12 - 7516	215	75-585	12 - 7630	216
73-025	09 - 9046	145	75-125	12 - 8811										



AFTERMARKET CROSS REFERENCE

Part No.	Rotary No.	Page No.	Part No.	Rotary No.	Page No.	Part No.	Rotary No.	Page No.	Part No.	Rotary No.	Page No.	Part No.	Rotary No.	Page No.
OREGON			75-917	12 - 10253	248	78-112	13 - 12427	279	82-407	10 - 13131	188	90-348	15 - 10291	373
75-631	12 - 5014	211	75-918	12 - 10486	230	78-118	13 - 10741	279	82-408	10 - 12219	195	90-354	15 - 10292	374
75-631	12 - 12824	256	75-919	12 - 10436	230	78-121	13 - 10414	288	82-408	10 - 12973	188	90-404	15 - 10972	369
75-632	12 - 5015	211	75-932	12 - 7184	222	78-129	13 - 9544	279	82-411	10 - 11961	187	90-407	15 - 6496	321
75-634	12 - 5017	211	75-937	12 - 10031	243	78-133	13 - 10737	279	82-493	10 - 1172	201	90-415	15 - 9465	324
75-635	12 - 5018	211	75-938	12 - 8887	241	78-133	13 - 11207	279	82-495	10 - 8647	201	90-417	15 - 6296	322
75-637	12 - 5020	211	75-957	12 - 10254	245	78-300	13 - 6572	264	82-500	10 - 7155	197	90-424	15 - 6303	324
75-637	12 - 12067	256	75-958	12 - 10255	245	78-640	13 - 2185	272	82-501	10 - 7156	195	90-432	15 - 6314	322
75-641	12 - 5024	211	75-960	12 - 9862	247	78-641	13 - 2186	267	82-502	10 - 8967	197	90-618	14 - 6052	314
75-642	12 - 5025	211	75-961	12 - 10040	248	78-642	13 - 5989	290	82-503	10 - 8968	197	90-619	14 - 6053	314
75-643	12 - 5026	211	75-962	12 - 13109	246	78-643	13 - 2187	272	82-510	10 - 9519	184	90-620	14 - 6044	314
75-644	12 - 5027	211	75-966	12 - 13110	246	78-649	13 - 5991	272	82-511	10 - 9285	196	90-621	14 - 6045	314
75-645	12 - 5028	211	75-967	12 - 10041	248	78-673	13 - 7124	290	82-512	10 - 9284	197	90-622	14 - 6046	314
75-646	12 - 12073	257	75-976	12 - 10485	230	78-675	13 - 1262	285	82-513-2	10 - 9288	196	90-717	15 - 6300	322
75-646	12 - 5029	211	75-978	12 - 10435	230	78-676	13 - 3316	285	82-514	10 - 1170	201	90-969	15 - 6785	322
75-647	12 - 5030	211	75-979	12 - 10434	230	78-677	13 - 1263	285	82-515	10 - 9286	195	91-000	15 - 3326	328
75-647	12 - 13257	257	75-982	12 - 10026	243	78-678	13 - 6608	272	82-516	10 - 9287	196	91-003	15 - 6060	328
75-648	12 - 5031	211	75-983	12 - 13506	221	78-679	13 - 6607	272	82-517	10 - 12066	196	91-005	15 - 3322	328
75-649	12 - 12719	257	75-984	12 - 13217	231	78-680	13 - 9397	292	82-518	10 - 12972	189	91-012	15 - 2137	328
75-653	12 - 10078	223	75-992	12 - 10437	230	78-681	13 - 9805	292	82-519	10 - 12612	195	91-015	15 - 6254	328
75-654	12 - 10077	224	75-997	12 - 10409	255	78-690	13 - 8547	291	82-674	10 - 13009	200	91-038	15 - 6784	346
75-655	12 - 10783	228	75-998	12 - 10410	255	78-691	13 - 5949	291	82-675	10 - 13620	200	91-043	15 - 9882	355
75-656	12 - 10784	228	76-002	05 - 345	92	79-000	10 - 8660	160	82-676	10 - 13621	200	91-056	15 - 6240	341
75-657	12 - 10781	228	76-003	10 - 7747	157	79-001	10 - 8660	160	82-677	10 - 1171	201	91-057	15 - 11477	342
75-658	12 - 10563	228	76-006	08 - 7745	117	79-012	17 - 5847	433	82-678	10 - 6813	201	91-058	15 - 11475	343
75-659	12 - 10782	228	76-007	08 - 7744	117	79-724	15 - 1131	404	82-679	10 - 8649	200	91-064	15 - 6014	338
75-660	12 - 10815	244	76-014	05 - 10169	93	79-728	15 - 1136	404	82-680	10 - 8648	200	91-068	15 - 6116	338
75-661	12 - 10814	243	76-022	05 - 14173	93	79-730	15 - 911	328	83-010	19 - 9361	484	91-069	15 - 6141	339
75-662	12 - 10845	251	76-025	10 - 11996	182	79-732	15 - 910	405	83-011	19 - 9380	484	91-073	15 - 10636	341
75-663	12 - 10844	251	76-067	05 - 300	92	80-014	04 - 5601	82	83-012	19 - 8631	484	91-077	15 - 6738	374
75-664	12 - 10847	251	76-070	05 - 7018	93	80-036	04 - 5600	82	83-013	19 - 6929	483	91-078	15 - 6479	375
75-665	12 - 10846	251	76-073	05 - 8898	93	80-037	05 - 8052	89	83-028	19 - 6676	483	91-079	15 - 10284	373
75-666	12 - 10884	247	76-081	10 - 3307	161	80-038	04 - 5603	82	83-282	19 - 6600	483	91-096	15 - 6068	338
75-668	12 - 10743	248	76-100	10 - 8950	181	80-056	04 - 5602	82	83-283	19 - 5909	483	91-097	15 - 6066	338
75-669	12 - 10745	249	76-110	42 - 7158	1231	80-122	17 - 1182	431	83-284	19 - 7916	483	91-108	15 - 10634	373
75-670	12 - 10894	250	76-643	12 - 12070	257	80-145	17 - 9815	429	83-300	19 - 6680	484	91-112	15 - 3332	339
75-671	12 - 10893	250	76-645	12 - 12072	257	80-146	17 - 10239	429	83-301	19 - 6681	483	91-123	15 - 6035	401
75-672	12 - 10750	230	76-648	12 - 12718	257	80-230	17 - 10019	432	83-302	19 - 13237	483	91-126	15 - 6185	400
75-673	12 - 10831	235	77-201	24 - 1294	594	80-740	41 - 916	1221	84-001	04 - 457	81	91-138	15 - 6480	374
75-675	12 - 9480	236	77-203	24 - 2526	594	80-741	41 - 917	1221	84-002	04 - 456	81	91-139	15 - 10635	375
75-676	12 - 11019	236	77-204	24 - 2517	594	80-742	41 - 918	1221	84-004	04 - 455	81	91-143	15 - 6069	338
75-677	12 - 10369	237	77-207	24 - 2523	594	80-743	41 - 8627	1221	84-005	04 - 463	83	91-144	15 - 10383	342
75-678	12 - 11483	236	77-208	24 - 1295	594	80-744	10 - 7886	180	84-006	04 - 864	81	91-146	15 - 6766	345
75-679	12 - 10832	239	77-209	24 - 1289	594	80-745	10 - 7885	180	84-007	04 - 458	81	91-158	15 - 6782	345
75-680	12 - 10050	256	77-210	24 - 2500	594	80-746	41 - 8628	1221	84-008	04 - 464	83	91-165	15 - 6088	345
75-682	12 - 10365	256	77-212	24 - 2537	595	80-749	41 - 5549	1222	84-009	04 - 865	81	91-166	15 - 6086	345
75-683	12 - 10746	258	77-213	24 - 5858	595	81-012	10 - 863	160	84-010	10 - 3221	172	91-167	15 - 6087	345
75-684	12 - 14042	241	77-214	24 - 2534	595	81-015	10 - 12749	160	84-012	04 - 7680	80	91-169	15 - 6084	346
75-685	12 - 10821	241	77-215	24 - 2519	595	81-101	05 - 5952	94	84-013	04 - 7681	80	91-171	15 - 825	346
75-686	12 - 10822	241	77-216	24 - 2501	595	81-102	05 - 5951	94	84-101	29 - 8620	667	91-180	15 - 1009	336
75-687	12 - 10823	260	77-217	24 - 2533	595	82-015	10 - 11014	185	84-102	29 - 8610	667	91-181	15 - 10719	351
75-688	12 - 10824	260	77-218	24 - 8358	595	82-020	10 - 7251	201	84-103	29 - 8611	667	91-183	15 - 2172	334
75-706	12 - 11843	227	77-219	24 - 10176	595	82-021	10 - 12241	192	85-001	10 - 2904	183	91-184	15 - 2173	334
75-709	12 - 10833	235	77-220	24 - 5850	595	82-022	10 - 12668	190	85-002	10 - 2931	183	91-188	15 - 6250	352
75-714	12 - 11845	227	77-223	24 - 2538	595	82-026	10 - 11590	185	85-005	10 - 2937	183	91-194	15 - 6175	349
75-716	12 - 12667	233	77-224	24 - 2539	595	82-028	10 - 10189	197	85-006	10 - 7283	183	91-209	15 - 9987	357
75-720	12 - 5053	212	77-225	24 - 5852	595	82-041	10 - 14252	191	85-007	10 - 7284	183	91-218	15 - 6178	350
75-722	12 - 5055	212	77-226	24 - 10707	596	82-042	10 - 14230	191	85-008	10 - 6890	182	91-226	15 - 2030	358
75-724	12 - 5057	212	77-227	24 - 5857	596	82-220	10 - 8548	184	85-011	10 - 7154	182	91-238	15 - 6728	371
75-725	12 - 5058	212	77-230	24 - 5851	596	82-221	10 - 9521	184	85-012	10 - 7282	182	91-239	15 - 6285	361
75-726	12 - 5059	212	77-237	24 - 7892	595	82-225	10 - 8479	184	85-017	10 - 8549	184	91-242	15 - 1066	345
75-727	12 - 5060	212	77-238	24 - 5854	595	82-243	10 - 2925	198	85-023	10 - 9520	184	91-244	15 - 1065	360
75-728	12 - 5061	212	77-239	24 - 10234	596	82-244	09 - 2892	145	85-028	10 - 9906	182	91-247	15 - 3339	361
75-753	12 - 5086	212	77-240	24 - 2518	595	82-245	10 - 10189	197	85-032	10 - 11592	185	91-248	15 - 3381	361
75-755	12 - 5088	212	77-253	24 - 9872	594	82-250	10 - 7765	197	85-034	10 - 9575	184	91-251	15 - 6181	361
75-756	12 - 5089	212	77-256	24 - 10427	596	82-305	10 - 5999	198	86-001	28 - 1994	663	91-253	15 - 6180	

AFTERMARKET CROSS REFERENCE



AFTERMARKET REF. 2014

Part No.	Rotary No.	Page No.	Part No.	Rotary No.	Page No.	Part No.	Rotary No.	Page No.	Part No.	Rotary No.	Page No.	Part No.	Rotary No.	Page No.
OREGON			91-918	15 - 6170	413	95-046	15 - 6219	330	98-049	15 - 6423	387	7-01503	31 - 11941	1057
91-374	15 - 6481	355	91-919	15 - 6169	413	95-047	15 - 6218	331	98-050	15 - 6425	388	7-01504	31 - 11942	1057
91-378	15 - 10249	352	91-920	15 - 6170	413	95-048	15 - 6262	332	98-051	15 - 6424	387	7-01504	31 - 11942	1057
91-379	15 - 10718	348	91-930	15 - 10073	324	95-049	15 - 6263	329	98-053	15 - 1031	386	7-01505	31 - 11943	1057
91-380	15 - 6192	374	91-938	15 - 12809	342	95-050	15 - 6264	330	98-054	15 - 1037	385	7-01505	31 - 11943	1057
91-381	15 - 6206	373	91-32791-23715	15 - 11476	340	95-051	15 - 6235	332	98-057	15 - 1021	385	7-01506	31 - 11938	1058
91-383	15 - 6223	373	92-004	15 - 1057	379	95-052	15 - 6495	329	98-058	15 - 1024	386	7-01506	31 - 8600	1058
91-384	15 - 6221	374	92-010	15 - 848	379	95-058	15 - 7010	365	98-059	15 - 1032	386	7-01508	31 - 1937	1058
91-385	15 - 1126	372	92-011	15 - 849	379	95-062	15 - 9907	330	98-061	15 - 1030	340	7-01511	31 - 1932	1057
91-387	15 - 6222	372	92-015	15 - 11250	342	95-067	15 - 9810	332	98-063	15 - 1029	385	7-01511	31 - 11932	1057
91-389	15 - 1127	372	92-025	15 - 11249	353	95-070	15 - 12242	333	98-064	15 - 1034	385	7-01512	31 - 11933	1057
91-391	15 - 2120	375	92-026	15 - 11240	349	95-074	15 - 12242	333	98-065	15 - 6448	387	7-01512	31 - 1933	1057
91-392	15 - 6011	374	92-027	15 - 11241	351	95-076	15 - 13023	333	98-066	15 - 6438	387	7-01513	31 - 1934	1057
91-393	15 - 6012	373	92-028	15 - 11242	352	95-614	15 - 9970	321	98-068	15 - 6439	387	7-01513	31 - 11934	1057
91-394	15 - 6253	375	92-029	15 - 11231	349	95-621	15 - 12732	332	98-069	15 - 1038	385	7-01514	31 - 1935	1057
91-395	15 - 6252	376	92-029	15 - 11231	349	95-915	15 - 12475	322	98-071	15 - 10363	342	7-01514	31 - 11935	1057
91-398	15 - 845	375	92-031	15 - 11248	353	96-003	15 - 1093	393	98-072	15 - 11719	342	7-01515	31 - 1936	1058
91-399	15 - 6328	376	92-033	15 - 11229	355	96-004	15 - 3447	393	98-080	15 - 11805	340	7-01531	24 - 8750	599
91-400	15 - 6737	374	92-037	15 - 6180	334	96-005	15 - 3406	393	98-086	15 - 11480	341	7-016018	31 - 10296	1079
91-402	15 - 6327	376	92-038	15 - 6194	319	96-009	15 - 6031	393	98-087	15 - 11479	341	7-01602	31 - 1764	1075
91-403	15 - 6186	375	92-039	15 - 11810	369	96-011	15 - 6099	394	98-091	15 - 10362	342	7-01603	31 - 1780	1076
91-414	15 - 6081	340	92-043	15 - 10720	368	96-012	15 - 6138	394	98-094	15 - 12909	342	7-01604	31 - 1779	1076
91-415	15 - 6082	341	92-048	15 - 14095	378	96-023	15 - 6286	394	98-096	15 - 12956	386	7-01605	31 - 1778	1075
91-416	15 - 6238	342	92-049	15 - 6209	378	96-120	15 - 6025	393	98-486	15 - 6019	381	7-01612	31 - 1884	1078
91-429	15 - 3388	378	92-090	15 - 10636	341	96-220	15 - 6099	394	98-487	15 - 6003	382	7-01621	31 - 8771	1076
91-430	15 - 3386	377	92-110	15 - 12380	376	96-344	15 - 6294	323	98-493	15 - 6006	382	7-01634	31 - 1781	1077
91-433	15 - 6208	377	92-116	15 - 12995	379	96-347	15 - 6299	324	98-496	15 - 6143	382	7-01641	31 - 7288	1076
91-435	15 - 6208	377	92-205	15 - 12002	350	96-351	15 - 10362	342	98-499	15 - 6028	383	7-01642	31 - 7287	1076
91-436	15 - 6265	378	92-675	15 - 12920	373	96-354	15 - 12821	373	98-521	15 - 6096	383	7-01643	31 - 7286	1076
91-437	15 - 3389	378	93-001	15 - 1036	337	96-354	15 - 10291	373	98-537	15 - 6126	382	7-01644	31 - 8051	1076
91-438	15 - 6209	378	93-002	15 - 1009	336	96-379	15 - 11805	340	98-538	15 - 6127	383	7-01646	31 - 11578	1076
91-440	15 - 6239	342	93-003	15 - 1010	336	96-396	15 - 13129	323	98-539	15 - 6128	381	7-01652	31 - 7287	1076
91-443	15 - 6122	375	93-006	15 - 3404	347	96-606	15 - 13260	354	99-103	15 - 2006	402	7-01655	31 - 8692	1077
91-446	15 - 10074	376	93-007	15 - 3329	337	97-001	15 - 6174	392	99-106	15 - 1103	402	7-01656	31 - 10462	1078
91-449	15 - 9959	376	93-008	15 - 2174	337	97-002	15 - 6160	391	99-107	15 - 2007	401	7-01670	31 - 8943	1071
91-454	15 - 6435	370	93-009	15 - 3400	336	97-003	15 - 6146	390	99-111	15 - 1091	403	7-01684	31 - 7935	1071
91-476	15 - 12919	376	93-010	15 - 3401	336	97-004	15 - 6145	390	99-112	15 - 1092	403	7-01686	31 - 10295	1080
91-482	15 - 11663	347	93-011	15 - 3402	337	97-005	15 - 6144	391	99-114	15 - 1098	403	7-01686	31 - 8969	1079
91-483	15 - 11139	353	93-013	15 - 6272	337	97-006	15 - 6112	390	99-116	15 - 6197	401	7-01687	31 - 9214	1079
91-500	15 - 1100	345	93-025	15 - 3329	337	97-007	15 - 6039	391	99-117	15 - 1060	403	7-01688	31 - 10673	1079
91-501	15 - 6020	343	93-901	15 - 13016	323	97-008	15 - 6162	391	99-118	15 - 6029	403	7-01690	31 - 9209	1080
91-502	15 - 3372	343	93-902	15 - 13017	324	97-009	15 - 6215	392	99-120	15 - 2169	400	7-01692	31 - 10293	1078
91-503	15 - 9171	409	94-001	15 - 6275	409	97-010	15 - 6111	390	99-121	15 - 6110	402	7-01693	31 - 9206	1080
91-505	15 - 6790	343	94-011	15 - 3362	411	97-011	15 - 6010	392	99-124	15 - 6108	403	7-01694	31 - 9205	1080
91-506	15 - 6083	344	94-014	15 - 1006	410	97-013	15 - 9897	391	99-127	15 - 6500	366	7-01695	31 - 9204	1078
91-507	15 - 6404	334	94-017	15 - 1008	410	97-014	15 - 6166	391	99-128	15 - 1010	336	7-01696	31 - 10297	1080
91-508	15 - 6224	343	94-018	15 - 3361	408	97-015	15 - 2013	392	99-920	15 - 6317	324	7-01697	31 - 8969	1079
91-509	15 - 6441	344	94-019	15 - 6251	411	97-016	15 - 2012	390	99-928	15 - 6302	326	7-01698	31 - 9208	1079
91-515	15 - 6833	334	94-021	15 - 2171	412	97-017	15 - 6408	389	99-930	15 - 6297	326	7-01754	31 - 1897	1077
91-516	15 - 6431	364	94-022	15 - 3405	408	97-018	15 - 6470	389	99-933	15 - 6301	326	7-01755	31 - 1898	1077
91-517	15 - 6430	364	94-026	15 - 3441	407	97-019	15 - 6476	391				7-01800	24 - 1295	594
91-531	15 - 13464	360	94-029	15 - 6270	409	97-020	15 - 6166	391				7-01800	24 - 2543	589
91-532	15 - 13463	359	94-032	15 - 6184	409	97-022	15 - 10066	390	PRIME LINE			7-01800	24 - 2551	590
91-544	15 - 6402	360	94-033	15 - 6118	412	97-023	15 - 9228	391	18-1040	32 - 8531	1102	7-01800	24 - 2544	589
91-545	15 - 3377	359	94-038	15 - 3395	409	97-024	15 - 6475	390	18-1082	32 - 8545	1102	7-01800	24 - 5936	591
91-546	15 - 3379	359	94-039	15 - 3393	407	97-100	15 - 844	389	18-1083	32 - 8545	1102	7-01800	24 - 2529	593
91-620	15 - 3403	347	94-040	15 - 6271	412	97-101	15 - 844	389	18-4443	31 - 8596	1058	7-01805	24 - 2544	589
91-621	15 - 6009	379	94-044	15 - 6256	410	97-105	15 - 6018	389	18-5750	24 - 1285	600	7-01805	24 - 2532	593
91-622	15 - 3404	347	94-051	15 - 10928	352	97-106	15 - 1124	389	18-7844	19 - 5909	483	7-01805	24 - 2507	591
91-623	15 - 3442	380	94-069	15 - 11821	411	97-107	15 - 6017	390	18-7844	19 - 6677	483	7-01807	24 - 2510	591
91-624	15 - 6008	380	94-322	15 - 12649	323	97-109	15 - 6034	390	18-7878	19 - 6680	484	7-01808	24 - 7191	589
91-626	15 - 3434	362	94-415	15 - 9885	321	97-110	15 - 3390	391	18-7884	19 - 6677	483	7-01809	24 - 2544	589
91-627	15 - 6026	334	94-618	15 - 6410	322	97-115	15 - 3443	392	18-7884	19 - 5909	483	7-01810	24 - 2501	595
91-633	15 - 3404	347	94-770	15 - 6002	410	97-118	15 - 6119	390	18-9100	32 - 2301	1083	7-01811	24 - 2512	591
91-664	15 - 1076	398	95-003	15 - 6190	331	97-119	15 - 6129	391	18-9101	32 - 2303	1083	7-01813	24 - 1294	594
91-701	15 - 10096													



AFTERMARKET CROSS REFERENCE

Part No.	Rotary No.	Page No.	Part No.	Rotary No.	Page No.	Part No.	Rotary No.	Page No.	Part No.	Rotary No.	Page No.	Part No.	Rotary No.	Page No.
PRIME LINE														
7-01832	31-9853	1060	7-02025	22-7967	538	7-02254	19-2839	478	7-02361	20-9146	497	7-02614	23-2755	573
7-01834	24-7225	589	7-02025	22-1414	539	7-02255	19-2841	455	7-02363	38-9137	502	7-02615	23-2754	573
7-01838	24-2538	595	7-02043	22-1421	544	7-02256	19-2829	478	7-02364	38-9138	502	7-02616	23-2757	574
7-01840	24-2539	595	7-02045	22-2884	539	7-02257	19-2838	456	7-02365	38-9139	502	7-02619	23-2757	574
7-01840	24-7188	592	7-02045	22-2884	539	7-02257-1	19-2838	456	7-02366	38-9140	502	7-02627	23-1469	571
7-01841	24-7222	589	7-02059	22-7968	538	7-02257-10	19-2838	456	7-02370	20-8751	51	7-02633	23-1471	571
7-01841	24-6935	592	7-02100	22-2885	539	7-02258	27-7206	490	7-02375	38-4972	519	7-02635	23-1470	571
7-01842	24-5857	596	7-02101	22-1425	528	7-02259	19-2785	481	7-02377	38-8337	47	7-02644	23-1406	571
7-01843	24-5857	596	7-02101	38-3654	51	7-02260	19-2781	481	7-02377	38-8113	51	7-02655	23-1405	571
7-01844	24-5856	594	7-02101	22-1427	528	7-02261	19-6688	461	7-02378	38-3668	51	7-02666	23-7946	575
7-01849	24-2544	589	7-02102	38-1553	1189	7-02262	19-6691	461	7-02384	38-9024	502	7-02668	23-8746	575
7-01850	31-2922	1062	7-02103	38-1552	1189	7-02262	19-6690	461	7-02387	38-9025	502	7-02679	23-8228	582
7-01853	31-1928	1061	7-02104	22-8227	529	7-02263	19-6849	481	7-02403	23-2764	570	7-02688	23-7173	577
7-01854	31-1931	1061	7-02105	22-1429	528	7-02264	19-2798	478	7-02404	23-2750	570	7-02700	19-6604	453
7-01854	31-2922	1062	7-02106	22-1428	528	7-02265	19-5941	452	7-02408	23-2763	570	7-02701	19-6517	463
7-01855	31-1929	1072	7-02107	22-8364	529	7-02265-1	19-5941	452	7-02412	23-1479	569	7-02701	19-6514	454
7-01860	31-5933	1071	7-02108	23-3538	576	7-02266	19-5940	478	7-02417	23-2753	569	7-02702	19-6602	453
7-01860	31-8943	1071	7-02109	22-8380	529	7-02267	19-6518	463	7-02418	23-1482	569	7-02704	19-6524	451
7-01860-1	31-8943	1071	7-02140	38-8123	47	7-02268	19-7879	454	7-02419	23-1480	569	7-02705	19-8332	458
7-01860-1	31-5933	1071	7-02144	38-8124	47	7-02270	19-2791	476	7-02421	23-2760	570	7-02706	39-6511	486
7-01861	31-3319	1071	7-02150	22-7972	532	7-02272	19-6694	482	7-02424	23-1489	570	7-02708	19-2805	461
7-01861-1	31-3319	1071	7-02199	19-7732	480	7-02272	19-6695	482	7-02426	23-1491	570	7-02708	19-6684	461
7-01862	31-2932	1069	7-02200	19-1390	479	7-02273	19-6696	482	7-02427	23-2732	569	7-02708	19-7726	462
7-01863	24-1298	600	7-02201	19-1389	471	7-02273	19-6697	482	7-02428	23-2761	569	7-02708	19-7980	460
7-01865	24-2536	594	7-02202	19-1384	473	7-02274	19-6698	482	7-02429	23-8242	569	7-02709	19-6692	461
7-01866	24-2542	589	7-02203	19-1385	474	7-02275	19-1369	452	7-02430	23-8243	569	7-02709	19-6693	461
7-01866	24-6932	591	7-02204	19-1386	470	7-02276	19-1377	470	7-02438	23-1484	569	7-02710	19-6686	461
7-01867	24-2506	591	7-02204-1	19-1386	470	7-02277	19-2780	474	7-02439	23-2759	570	7-02711	19-6706	465
7-01867	24-2544	589	7-02204-10	19-1386	470	7-02278	19-2786	452	7-02444	23-2762	570	7-02712	19-6705	465
7-01868	24-6933	593	7-02205	19-1370	451	7-02279	19-2807	462	7-02500	23-2740	581	7-02713	19-6605	467
7-01870	24-2544	589	7-02205-10	19-1370	451	7-02280	19-2805	461	7-025003	23-7168	580	7-02713-1	19-6605	467
7-01870	24-1295	594	7-02206	19-1371	451	7-02280	19-7726	462	7-02501	23-2741	581	7-02713-10	19-6605	467
7-01871	24-1289	594	7-02206-10	19-1371	451	7-02281	19-5861	463	7-02502	23-2733	581	7-02714	19-6659	475
7-01872	24-2500	594	7-02207	19-1372	451	7-02282	19-2797	452	7-02503	23-2735	581	7-02715	19-6583	476
7-01872	24-2510	591	7-02208	19-1382	480	7-02282	19-9245	471	7-02504	23-2734	581	7-02716	19-6585	477
7-01873	24-2503	595	7-02209	19-1381	480	7-02283	19-5939	452	7-02505	23-2739	581	7-02717	19-6584	476
7-01874	24-2544	589	7-02210	19-1374	452	7-02284	19-5934	473	7-02506	23-2736	581	7-02718	39-3116	494
7-01874	24-2537	595	7-02210-1	19-1374	452	7-02285	19-6516	473	7-02507	23-2737	581	7-02721	19-6515	479
7-01876	24-7311	590	7-02210-10	19-1374	452	7-02286	19-8481	456	7-02508	23-2738	581	7-02722	19-6702	482
7-01878	24-2548	590	7-02211	19-1378	475	7-02287	19-7785	471	7-02509	23-6523	576	7-02723	19-6700	482
7-01879	24-5850	595	7-02212	19-1373	451	7-02287	19-2844	472	7-02510	23-1478	576	7-02724	19-6704	482
7-01880	24-8358	595	7-02213	39-1550	487	7-02290	19-2799	478	7-02511	23-8797	577	7-02725	19-8905	462
7-01881	24-10176	595	7-02214	19-1392	480	7-02291	19-6699	482	7-02526	23-3542	580	7-02726	19-6848	481
7-01882	24-5850	595	7-02215	19-1379	475	7-02292	19-6695	482	7-02527	23-7211	577	7-02729	19-7214	453
7-01885	24-2538	595	7-02217	19-1393	480	7-02293	19-6697	482	7-02527	23-3553	578	7-02731	39-8335	487
7-01885	24-7189	592	7-02218	19-1376	451	7-02294	19-5863	473	7-02528	23-3543	576	7-02732	39-8334	486
7-01886	24-2539	595	7-02219	19-1394	479	7-02295	19-7050	454	7-02529	23-3537	576	7-02733	39-8333	486
7-01887	24-5852	595	7-02220	19-1395	479	7-02296	19-6689	461	7-02531	18-2955	442	7-02737	19-7949	453
7-01890	24-5857	596	7-02222	19-2773	453	7-02297	19-6691	461	7-02533	23-3673	575	7-02739	19-8482	455
7-01892	31-1931	1061	7-02223	19-1396	452	7-02298	19-2809	462	7-02534	23-3548	575	7-02740	19-8480	455
7-01892	31-8601	1063	7-02224	19-1375	451	7-02299	19-5862	478	7-02541	23-3532	583	7-02741	19-7051	456
7-01893	31-9166	1060	7-02225	19-1387	473	7-02302	22-8208	532	7-02543	23-7798	579	7-02742	19-7094	453
7-01893	31-7280	1062	7-02226	19-1388	472	7-02303	22-8047	532	7-02550	23-3557	580	7-02742-1	19-7094	453
7-01900	32-1707	1096	7-02227	19-2778	453	7-02304	22-8046	537	7-02551	23-6531	575	7-02743	39-8283	494
7-01901	31-7179	1061	7-02228	19-2777	452	7-02305	22-1431	537	7-02552	23-8414	575	7-02750	19-9167	456
7-01902	31-1930	1063	7-02228-1	19-2777	452	7-02307	22-10940	536	7-02553	23-1493	576	7-02751	19-8814	456
7-01903	31-6545	1061	7-02228-10	19-2777	452	7-02308	22-1434	538	7-02554	23-1494	576	7-02752	19-7712	460
7-01904	31-6888	1069	7-02229	19-6601	455	7-02309	22-1419	537	7-02555	23-3546	575	7-02752	19-7725	460
7-01917	31-9664	1066	7-02230	19-1398	451	7-02310	20-7236	508	7-02556	23-3545	575	7-02753	19-8235	467
7-01920	22-2890	537	7-02231	19-1397	451	7-02311	22-1430	538	7-02557	23-3547	575	7-02754	19-8327	474
7-01931	31-9655	1060	7-02232	19-2775	479	7-02312	22-1543	532	7-02558	23-3556	580	7-02755	19-8279	474
7-01932	31-7015	1060	7-02233	19-1383	480	7-02317	22-1423	537	7-02559	23-3551	579	7-02756	19-8328	474
7-01932	31-12685	1060	7-02234	19-12784	479	7-02318	22-1424	537	7-02560	23-3552	579	7-02757	19-7419	476
7-01950	20-15904	508	7-02234	19-2784	479	7-02319	22-7972	532	7-02561	23-3550	579	7-02759	19-7725	460
7-01959	23-8955	586	7-02235	19-2774	473	7-02320	22-2950	538	7-02562	23-1522	579	7-02779	19-6687	461
7-01960	23-1435	586	7-02236	19-2789	455	7-02322	22-10942	536	7-02563	23-3555				

AFTERMARKET CROSS REFERENCE



Part No.	Rotary No.	Page No.	Part No.	Rotary No.	Page No.	Part No.	Rotary No.	Page No.	Part No.	Rotary No.	Page No.	Part No.	Rotary No.	Page No.
PRIME LINE														
7-02807	23 - 1403	582	7-03238	22 - 170	42	7-03596	07 - 8311	106	7-03781	23 - 8946	559	7-03913	03 - 5805	65
7-02808	23 - 1404	582	7-03239	22 - 189	532	7-03651	18 - 2294	438	7-03782	23 - 6772	559	7-03913	03 - 231	65
7-02809	23 - 3648	582	7-03240	22 - 183	532	7-03651	18 - 1270	34	7-03783	23 - 5875	557	7-03914	03 - 867	65
7-02814	23 - 3650	583	7-03242	22 - 182	530	7-03653	18 - 8003	440	7-03784	23 - 1462	558	7-03918	42 - 7158	1231
7-02815	23 - 3652	583	7-03326	02 - 41	39	7-03654	18 - 1280	444	7-03785	23 - 6777	562	7-03925	04 - 261	78
7-02816	23 - 3653	583	7-03327	02 - 48	40	7-03656	18 - 7867	440	7-03786	23 - 6775	562	7-03926	04 - 262	78
7-02817	23 - 3651	583	7-03328	02 - 42	40	7-03657	18 - 1282	444	7-03801	23 - 2723	563	7-03927	04 - 263	78
7-02820	23 - 3530	582	7-03329	02 - 43	40	7-03658	18 - 1269	439	7-03802	23 - 2722	563	7-03927	04 - 264	78
7-02821	23 - 3531	583	7-03330	02 - 44	40	7-03659	18 - 2283	444	7-03803	23 - 2749	565	7-03928	27 - 7235	660
7-02823	23 - 2757	574	7-03345	02 - 75	41	7-03660	18 - 2284	444	7-03805	23 - 2721	563	7-03929	05 - 9126	69
7-02826	23 - 2745	574	7-03346	02 - 76	41	7-03661	18 - 892	438	7-03806	23 - 2720	563	7-03930	03 - 247	74
7-02834	23 - 8229	577	7-03347	02 - 77	41	7-03662	18 - 859	440	7-03807	23 - 6741	564	7-03931	26 - 2445	633
7-02835	23 - 7421	577	7-03348	02 - 78	41	7-03663	18 - 8282	443	7-03807	23 - 2470	561	7-03931	03 - 245	74
7-02836	23 - 6526	575	7-03349	02 - 79	41	7-03664	18 - 1275	34	7-03808	23 - 6742	564	7-03932	03 - 250	74
7-02837	23 - 7965	576	7-03359	02 - 163	43	7-03664	18 - 12296	438	7-03808	23 - 6796	561	7-03933	04 - 267	85
7-02840	23 - 7945	575	7-03381	01 - 10125	37	7-03664	18 - 2296	438	7-03809	23 - 6797	561	7-03933	04 - 219	85
7-02841	23 - 3672	576	7-03400	26 - 5876	629	7-03665	18 - 1278	439	7-03809	23 - 6743	564	7-03934	04 - 267	85
7-02842	23 - 6971	576	7-03402	26 - 1333	630	7-03666	18 - 1279	444	7-03810	23 - 6798	562	7-03935	03 - 8415	63
7-02847	23 - 7794	581	7-03403	26 - 2463	630	7-03668	18 - 1273	439	7-03810	23 - 6744	564	7-03936	05 - 8294	70
7-02848	23 - 7793	581	7-03404	26 - 1326	629	7-03669	18 - 1272	34	7-03811	23 - 6745	564	7-03937	03 - 8416	63
7-02883	23 - 3542	580	7-03407	26 - 1329	629	7-03669	18 - 1268	439	7-03811	23 - 2471	561	7-03940	05 - 7920	89
7-02903	23 - 10770	556	7-03409	26 - 1334	629	7-03670	18 - 1277	439	7-03812	23 - 6799	561	7-03941	05 - 8293	70
7-02906	23 - 8226	575	7-03410	26 - 2430	629	7-03671	18 - 1267	438	7-03812	23 - 6746	564	7-03944	05 - 9125	73
7-02916	23 - 8225	581	7-03415	26 - 1327	629	7-03672	18 - 1272	34	7-03813	23 - 6800	561	7-03946	27 - 7905	75
7-02917	23 - 7941	576	7-03418	26 - 8288	610	7-03672	18 - 1268	439	7-03813	23 - 6747	564	7-03946	27 - 8673	75
7-02917	23 - 7963	576	7-03419	26 - 8289	610	7-03673	18 - 1283	440	7-03814	23 - 6748	564	7-03951	03 - 5805	65
7-02918	23 - 7966	577	7-034218	26 - 10877	612	7-03674	18 - 2280	440	7-03814	23 - 6801	562	7-03951	03 - 231	65
7-02922	23 - 7247	582	7-03425	26 - 2424	630	7-03674	18 - 862	438	7-03815	23 - 2472	561	7-039580	27 - 9667	75
7-02928	23 - 7246	582	7-03426	26 - 2421	630	7-03675	18 - 2282	443	7-03815	23 - 6749	564	7-03966	05 - 8568	71
7-02929	23 - 7248	582	7-03428	26 - 2422	630	7-03676	18 - 2285	442	7-03816	23 - 6802	561	7-03968	03 - 8832	59
7-02933	23 - 3649	582	7-03429	37 - 3026	633	7-03677	18 - 2291	442	7-03816	23 - 6750	564	7-03969	03 - 8417	60
7-02960	23 - 7964	577	7-03429	37 - 3044	1181	7-03678	18 - 891	438	7-03817	23 - 6803	561	7-03970	03 - 236	56
7-02961	23 - 2961	580	7-03430	37 - 3045	1181	7-03678	18 - 6510	442	7-03817	23 - 6751	564	7-03971	03 - 237	56
7-03002	23 - 1509	567	7-03430	37 - 3044	1181	7-03679	18 - 2286	441	7-03818	23 - 6804	562	7-03972	03 - 239	65
7-03005	23 - 8562	567	7-03431	37 - 3068	1181	7-03680	18 - 8284	442	7-03819	23 - 6753	564	7-03974	03 - 242	62
7-03009	23 - 8822	567	7-03432	37 - 3034	1181	7-03681	18 - 2281	443	7-03819	23 - 2473	561	7-03975	03 - 243	56
7-03014	23 - 1511	567	7-03433	26 - 2445	633	7-03685	18 - 8001	440	7-03820	23 - 6805	561	7-03975	03 - 244	66
7-03015	23 - 2816	567	7-03435	37 - 3060	1181	7-03691	18 - 2288	443	7-03821	23 - 6755	564	7-03976	03 - 244	66
7-03016	23 - 2815	567	7-03436	37 - 3061	1181	7-03692	18 - 2289	443	7-03821	23 - 6806	562	7-03976	03 - 239	65
7-03018	23 - 8821	567	7-03437	26 - 2444	633	7-03693	18 - 2297	444	7-03822	23 - 6756	564	7-03977	03 - 8530	62
7-03021	23 - 8049	567	7-03438	26 - 7930	610	7-03694	18 - 2298	445	7-03822	23 - 6807	562	7-03978	03 - 5805	65
7-03028	23 - 1508	567	7-03439	26 - 9507	608	7-03695	18 - 897	445	7-03827	23 - 6739	564	7-03978	03 - 8961	63
7-03030	23 - 1510	567	7-03440	26 - 9488	609	7-03696	18 - 1286	34	7-03827	23 - 6794	561	7-03978	03 - 6658	56
7-03031	23 - 2811	567	7-03441	26 - 7927	610	7-03697	18 - 1287	34	7-03829	23 - 6740	564	7-03978	03 - 7975	63
7-03034	23 - 1518	568	7-03443	26 - 8498	627	7-03698	18 - 1281	444	7-03829	23 - 6795	561	7-03978	03 - 231	65
7-03035	23 - 1519	568	7-03446	25 - 2230	605	7-03699	18 - 1284	444	7-03831	23 - 6722	563	7-03978	03 - 241	65
7-03039	23 - 2834	568	7-03447	25 - 2230	605	7-03701	23 - 2476	559	7-03832	23 - 6723	563	7-03978	03 - 6589	66
7-03040	23 - 2833	568	7-03449	18 - 2290	443	7-03702	23 - 2954	560	7-03833	23 - 8947	563	7-03978	03 - 239	65
7-03041	23 - 8475	568	7-03450	26 - 6673	608	7-03703	23 - 1464	560	7-03835	23 - 8452	563	7-03979	03 - 6589	66
7-03042	23 - 8473	568	7-03451	26 - 1324	608	7-03707	23 - 8450	558	7-03836	23 - 6720	563	7-03980	03 - 9128	57
7-03043	23 - 2830	568	7-03453	26 - 2240	628	7-03708	23 - 6773	558	7-03837	23 - 8826	563	7-03981	03 - 9127	57
7-03048	23 - 8050	567	7-03454	26 - 2241	608	7-03711	23 - 6794	561	7-03838	23 - 6736	565	7-03984	05 - 9694	72
7-03057	23 - 9822	567	7-03455	26 - 860	608	7-03711	23 - 7213	557	7-03839	23 - 6732	565	7-03987	03 - 7812	66
7-03058	23 - 9826	567	7-03455-25	26 - 10860	608	7-03711	23 - 1453	558	7-03843	23 - 6725	563	7-03987	03 - 239	65
7-03070	23 - 9827	567	7-03455-25	26 - 10860	608	7-03713	23 - 1455	560	7-03845	23 - 6734	565	7-03988	03 - 9130	60
7-03083	23 - 8474	568	7-03456	26 - 875	608	7-03716	23 - 2470	561	7-03848	23 - 6726	563	7-03989	03 - 946	62
7-03100	10 - 5722	198	7-03457	26 - 876	608	7-03719	23 - 1461	558	7-03850	23 - 6761	566	7-03991	03 - 7961	62
7-03100	10 - 9153	198	7-03458	26 - 852	608	7-03720	23 - 1452	558	7-03852	23 - 6763	566	7-03993	03 - 228	62
7-03101	10 - 8187	186	7-03458	26 - 852	608	7-03721	23 - 1462	558	7-03854	23 - 6765	566	7-039956	03 - 9566	68
7-03102	10 - 1227	186	7-03459	26 - 2957	628	7-03722	23 - 1458	562	7-03857	23 - 6767	566	7-039959	05 - 8833	72
7-03103	10 - 1226	186	7-03460	26 - 2959	608	7-03724	23 - 1456	562	7-03860	23 - 6758	566	7-03998	03 - 8800	57
7-03104	09 - 3217	134	7-03463	26 - 8286	609	7-03725	23 - 1459	562	7-03861	23 - 1529	566	7-039998	10 - 7284	183
7-03104	09 - 7178	134	7-03464	37 - 3002	1180	7-03726	23 - 1460	562	7-03862	23 - 2772	566	7-04001	23 - 2956	557
7-03105	10 - 5999	198	7-03469	37 - 1701	1180	7-03729	23 - 8827	559	7-03863	23 - 1528	566	7-04002	23 - 8421	557
7-03106	10 - 1227	186	7-03479	37 - 3048	1180	7-03731	23 - 6774	559	7-03864	23 - 6769	566	7-04003	23 - 8422	5



AFTERMARKET CROSS REFERENCE

Part No.	Rotary No.	Page No.	Part No.	Rotary No.	Page No.	Part No.	Rotary No.	Page No.	Part No.	Rotary No.	Page No.	Part No.	Rotary No.	Page No.
PRIME LINE														
7-04102	09 - 3209	144	7-04220	09 - 339	146	7-04331	06 - 290	97	7-04413	15 - 3387	377	7-04534	15 - 6087	345
7-04104	09 - 2935	146	7-04221	09 - 3305	146	7-04332	07 - 283	101	7-04415	15 - 3336	393	7-04534	15 - 6086	345
7-04105	09 - 2936	145	7-04223	10 - 3220	183	7-04333	08 - 7745	117	7-04416	15 - 3407	384	7-04535	15 - 1108	407
7-04106	09 - 2939	144	7-04224	10 - 3218	183	7-04334	08 - 7744	117	7-04417	15 - 3404	347	7-04537	15 - 3346	372
7-04107	09 - 3200	146	7-04225	10 - 1172	201	7-04335	07 - 5900	103	7-04417	15 - 3408	381	7-04539	22 - 1426	528
7-04108	09 - 3211	146	7-04226	10 - 856	197	7-04336	07 - 5899	103	7-04418	15 - 6012	373	7-04540	15 - 1136	404
7-04109	09 - 853	143	7-04227	10 - 1170	201	7-04338	07 - 8299	106	7-04418	15 - 6181	360	7-04541	15 - 3356	382
7-04110	09 - 854	145	7-04228	10 - 1171	201	7-04339	07 - 8300	106	7-04419	15 - 3323	328	7-04546	15 - 1077	381
7-04111	09 - 2940	147	7-04229	10 - 12925	198	7-04343	06 - 2983	98	7-04420	15 - 2137	328	7-04547	15 - 997	382
7-04112	09 - 7720	144	7-04229	10 - 2925	198	7-04344	06 - 2984	98	7-04421	15 - 6251	411	7-04549	27 - 17090	636
7-04113	05 - 301	93	7-04231	10 - 2210	174	7-04345	06 - 279	97	7-04422	15 - 3438	363	7-04550	27 - 6882	659
7-04114	05 - 3227	88	7-04232	09 - 327	39	7-04346	07 - 280	101	7-04423	15 - 3437	363	7-04551	15 - 851	407
7-04115	05 - 308	88	7-04232	09 - 328	133	7-04347	07 - 281	101	7-04424	15 - 2165	365	7-04552	15 - 3386	377
7-04116	05 - 2953	89	7-04232	09 - 6573	133	7-04348	07 - 282	101	7-04425	15 - 3421	415	7-04553	27 - 1337	636
7-04117	05 - 2958	89	7-04234	10 - 2904	183	7-04350	41 - 7766	1228	7-04427	15 - 2160	364	7-04555	27 - 1344	636
7-04118	05 - 3271	89	7-04235	10 - 2931	183	7-04351	10 - 311	39	7-04428	15 - 2160	364	7-04556	27 - 5928	636
7-04119	05 - 7018	93	7-04237	10 - 3309	183	7-04352	10 - 312	39	7-04430	15 - 2083	399	7-04556	27 - 3518	636
7-04120	05 - 7017	93	7-04240	05 - 2953	89	7-04353	10 - 314	39	7-04431	15 - 6008	380	7-04558	27 - 3521	636
7-04121	27 - 6927	77	7-04243	10 - 7283	183	7-04354	10 - 315	179	7-04432	15 - 6006	382	7-04558	27 - 5929	636
7-04124	27 - 6926	77	7-04249	05 - 8296	91	7-04355	10 - 316	39	7-04433	15 - 6025	393	7-04559	27 - 1368	636
7-04125	27 - 8567	77	7-04250	09 - 484	133	7-04356	10 - 317	39	7-04433	15 - 3406	393	7-04560	15 - 3441	407
7-04126	27 - 6928	77	7-04254	10 - 6813	201	7-04357	10 - 318	39	7-04435	15 - 6108	403	7-04561	15 - 3332	339
7-04127	27 - 8566	77	7-04255	05 - 5951	94	7-04358	10 - 320	39	7-04435	15 - 1098	403	7-04562	15 - 2082	399
7-04128	27 - 8565	77	7-04256	05 - 5952	94	7-04359	10 - 321	39	7-04436	15 - 1057	379	7-04563	15 - 2001	408
7-04129	09 - 487	133	7-04258	10 - 8320	198	7-04360	10 - 310	179	7-04436	15 - 6141	339	7-04563	15 - 1127	372
7-04130	09 - 8869	130	7-04259	10 - 7251	201	7-04360	10 - 10310	179	7-04438	15 - 848	379	7-04564	15 - 1009	336
7-04132	09 - 10264	134	7-04260	09 - 7716	147	7-04361	10 - 313	39	7-04439	15 - 849	379	7-04564	15 - 2172	334
7-04133	09 - 327	39	7-04261	10 - 8649	200	7-04362	10 - 319	39	7-04441	16 - 2673	423	7-04566	15 - 6003	382
7-04133	09 - 328	133	7-04262	10 - 8647	201	7-04363	10 - 2964	180	7-04441	16 - 1148	423	7-04568	15 - 2166	392
7-04133	09 - 6573	133	7-04263	10 - 8648	200	7-04366	41 - 8627	1221	7-04442	16 - 1145	422	7-04571	15 - 2081	399
7-04137	09 - 10303	135	7-04264	10 - 7765	197	7-04367	41 - 8628	1221	7-04443	15 - 824	417	7-04571	15 - 3386	377
7-04137	09 - 7162	134	7-04265	10 - 7156	195	7-04369	41 - 916	1221	7-04444	16 - 2658	424	7-04574	15 - 1065	360
7-04139	09 - 18199	131	7-04266	10 - 7155	197	7-04370	41 - 917	1221	7-04445	16 - 1137	422	7-04574	15 - 1126	372
7-04139	09 - 8198	131	7-04267	10 - 8967	197	7-04370	41 - 918	1221	7-04449	16 - 1147	424	7-04575	15 - 2164	361
7-04139	09 - 8199	131	7-04268	10 - 8968	197	7-04376	06 - 2965	97	7-04453	17 - 1162	428	7-04576	15 - 1015	382
7-04140	09 - 6535	133	7-04269	10 - 1191	175	7-04377	06 - 2980	97	7-04454	15 - 1009	336	7-04577	15 - 1016	382
7-04143	09 - 8077	132	7-04270	10 - 1191	175	7-04377	06 - 2989	97	7-04454	15 - 2172	334	7-04579	15 - 1018	383
7-04144	09 - 481	131	7-04270	10 - 8372	175	7-04377	06 - 2966	97	7-04459	17 - 1167	430	7-04582	15 - 2012	390
7-04144	09 - 18199	131	7-04272	17 - 6626	428	7-04378	06 - 2977	97	7-04460	17 - 1123	39	7-04583	15 - 2013	392
7-04146	09 - 5703	147	7-04273	17 - 7810	429	7-04379	06 - 2976	97	7-04462	15 - 3329	337	7-04584	15 - 1011	409
7-04152	05 - 3205	88	7-04274	17 - 1159	432	7-04380	07 - 8297	106	7-04466	15 - 1089	346	7-04585	15 - 1012	410
7-04153	05 - 422	88	7-04275	17 - 2220	428	7-04380	07 - 3320	106	7-04468	15 - 1044	333	7-04588	15 - 1008	410
7-04155	10 - 2238	175	7-04276	17 - 1152	431	7-04380	07 - 8298	107	7-04469	15 - 2162	329	7-04589	15 - 3362	411
7-04161	10 - 2222	158	7-04278	09 - 3213	144	7-04381	07 - 430	106	7-04471	15 - 3361	408	7-04590	15 - 2171	412
7-04162	10 - 2221	158	7-04279	09 - 3201	144	7-04382	06 - 2985	99	7-04472	15 - 2120	375	7-04592	15 - 3339	361
7-04163	10 - 2223	158	7-04280	05 - 2699	72	7-04382	06 - 272	99	7-04473	15 - 1117	399	7-04593	15 - 1006	410
7-04164	10 - 2224	172	7-04281	05 - 2700	72	7-04383	06 - 271	99	7-04474	15 - 844	389	7-04594	15 - 1011	409
7-04171	09 - 8488	135	7-04285	16 - 1252	424	7-04383	06 - 9875	99	7-04474	15 - 1122	389	7-04599	15 - 1066	345
7-04172	09 - 5721	146	7-04287	10 - 7284	183	7-04384	06 - 2986	99	7-04475	15 - 6106	333	7-04599	15 - 3372	343
7-04173	09 - 5713	147	7-04288	10 - 2937	183	7-04385	07 - 2991	102	7-04482	15 - 1014	382	7-04599	15 - 6013	319
7-04176	09 - 7258	146	7-04290	10 - 858	73	7-04385	07 - 8928	102	7-04485	15 - 2137	328	7-04601	14 - 951	315
7-04177	09 - 9044	145	7-04291	09 - 3228	131	7-04386	07 - 2992	102	7-04486	15 - 1065	360	7-04602	14 - 952	315
7-04178	05 - 3270	89	7-04292	09 - 327	39	7-04386	07 - 8927	102	7-04486	15 - 1126	372	7-04602	14 - 10952	315
7-04180	05 - 3269	89	7-04292	09 - 6573	133	7-04387	07 - 855	102	7-04487	15 - 1127	372	7-04603	14 - 953	315
7-04182	06 - 3239	98	7-04292	09 - 328	133	7-04387	07 - 8929	102	7-04488	15 - 3381	361	7-04603	14 - 10953	315
7-04189	09 - 5848	138	7-04293	09 - 3229	130	7-04392	06 - 286	99	7-04489	15 - 2137	328	7-04604	14 - 954	315
7-04190	09 - 8971	136	7-04294	09 - 8831	132	7-04392	07 - 2990	102	7-04492	15 - 1012	410	7-04604	14 - 10954	315
7-04192	09 - 8408	140	7-04294	09 - 18199	131	7-04394	08 - 8278	114	7-04495	15 - 6075	340	7-04605	14 - 955	315
7-04192	09 - 8998	140	7-04294	09 - 481	131	7-04394	08 - 7285	114	7-04496	15 - 6077	343	7-04605	14 - 10955	315
7-04193	09 - 8994	139	7-04294	09 - 8199	131	7-04395	07 - 8201	107	7-04498	15 - 1060	403	7-04611	14 - 965	316
7-04194	09 - 7917	132	7-04295	09 - 442	134	7-04396	15 - 910	405	7-04498	15 - 6109	403	7-04614	23 - 1497	576
7-04194	09 - 8507	132	7-04296	09 - 6542	135	7-04397	41 - 8993	1229	7-04499	14 - 2009	315	7-04615	15 - 2173	334
7-04194	09 - 7210	132	7-04297	09 - 367	137	7-04398	15 - 6263	329	7-04500	15 - 1132	404	7-04615	15 - 3404	347
7-04195	09 - 7279	143	7-04298	09 - 814	134	7-04398	15 - 6205	329	7-04500	15 - 1131	404	7-04615	15 - 1010	336
7-04196	09 - 9746	145	7-04298	09 - 813	133	7-04399	15 - 6173	378	7-04503	14 - 2008	315	7-04616	15 -	

AFTERMARKET CROSS REFERENCE



Part No.	Rotary No.	Page No.	Part No.	Rotary No.	Page No.	Part No.	Rotary No.	Page No.	Part No.	Rotary No.	Page No.	Part No.	Rotary No.	Page No.
PRIME LINE														
7-04635	23 - 3540	578	7-04754	16 - 1143	423	7-04835	08 - 7033	122	7-04962	15 - 1036	337	7-05213	13 - 729	36
7-04636	23 - 3541	578	7-04758	15 - 3326	328	7-04836	08 - 908	119	7-04965	15 - 1009	336	7-05214	13 - 730	36
7-04639	02 - 158	43	7-04758	15 - 6060	328	7-04837	08 - 8550	111	7-04965	15 - 2172	334	7-05214	13 - 728	36
7-04640	14 - 6052	314	7-04761	15 - 3326	328	7-04838	08 - 364	117	7-04966	15 - 3373	338	7-05215	13 - 728	36
7-04641	14 - 6053	314	7-04761	15 - 6060	328	7-04839	08 - 368	117	7-04968	15 - 6176	413	7-05215	13 - 731	36
7-04642	14 - 6044	314	7-04763	15 - 6222	372	7-04840	07 - 10250	105	7-04969	15 - 1124	389	7-05216	13 - 732	36
7-04643	14 - 6045	314	7-04763	15 - 6116	338	7-04840	07 - 6916	106	7-04969	15 - 6018	389	7-05217	13 - 733	36
7-04644	14 - 6046	314	7-04763	15 - 3403	347	7-04841	07 - 6915	105	7-04971	15 - 6008	380	7-05218	13 - 734	36
7-04645	23 - 3539	578	7-04763	15 - 6115	338	7-04844	08 - 8196	108	7-04973	15 - 3392	331	7-05218	13 - 5869	263
7-04646	15 - 1043	331	7-04764	15 - 1010	336	7-04845	06 - 3240	100	7-04973	15 - 6105	331	7-05220	13 - 736	264
7-04646	15 - 6037	331	7-04764	15 - 3404	347	7-04852	08 - 8278	114	7-04978	15 - 2007	401	7-05223	32 - 1759	1099
7-04648	15 - 6011	374	7-04764	15 - 2173	334	7-04855	06 - 5915	98	7-04978	15 - 6110	402	7-05224	32 - 1758	1099
7-04649	15 - 845	375	7-04764	15 - 6014	338	7-04857	08 - 8098	108	7-04978	15 - 2006	402	7-05225	32 - 1753	1099
7-04649	15 - 6737	374	7-04764	15 - 3374	338	7-04858	08 - 3277	115	7-04979	15 - 3403	347	7-05229	32 - 1704	1091
7-04650	14 - 988	316	7-04765	17 - 1195	44	7-04859	08 - 8552	108	7-04980	15 - 6120	330	7-05231	32 - 1738	1099
7-04652	14 - 990	316	7-04766	15 - 6083	344	7-04860	08 - 8553	108	7-04982	15 - 6125	332	7-05234	32 - 9054	1090
7-04653	14 - 991	316	7-04767	15 - 825	346	7-04862	08 - 8551	111	7-04982	15 - 6262	332	7-05238	32 - 1749	1091
7-04654	14 - 992	316	7-04768	15 - 3404	347	7-04863	08 - 8550	111	7-04983	15 - 6124	331	7-05242	32 - 9055	1091
7-04656	14 - 977	315	7-04768	15 - 1010	336	7-04864	08 - 7285	114	7-04983	15 - 6218	331	7-05247	32 - 1757	1099
7-04657	14 - 978	315	7-04768	15 - 2173	334	7-04869	08 - 8575	112	7-04984	15 - 2078	399	7-05248	32 - 1726	1090
7-04658	14 - 979	315	7-04769	15 - 6250	352	7-04870	06 - 6675	100	7-04989	16 - 2148	423	7-05253	13 - 7182	264
7-04659	14 - 980	315	7-04773	15 - 2030	358	7-04871	08 - 3276	115	7-04991	15 - 1100	345	7-05261	13 - 751	266
7-04660	14 - 981	315	7-04774	15 - 6168	360	7-04872	08 - 7982	112	7-04991	15 - 1126	372	7-05262	13 - 2184	272
7-04664	15 - 3392	331	7-04774	15 - 6167	359	7-04876	08 - 8197	111	7-04994	15 - 6140	382	7-05275	10 - 8549	184
7-04664	15 - 6105	331	7-04774	15 - 6401	360	7-04877	07 - 2990	102	7-04995	15 - 3322	328	7-05292	05 - 8207	89
7-04665	15 - 6111	390	7-04775	15 - 911	328	7-04878	08 - 8098	108	7-04996	15 - 3400	336	7-05293	10 - 9750	190
7-04665	15 - 6119	390	7-04776	15 - 6092	364	7-04879	08 - 8573	113	7-05022	22 - 8591	533	7-05295	42 - 9579	1231
7-04665	15 - 6017	390	7-04781	15 - 3423	413	7-04880	07 - 6917	103	7-05025	10 - 7154	182	7-05303	13 - 438	291
7-04668	15 - 6005	382	7-04785	15 - 6139	383	7-04881	07 - 8224	105	7-05052	17 - 1162	428	7-05304	13 - 776	291
7-04671	15 - 1074	356	7-04787	15 - 6142	390	7-04882	10 - 1191	175	7-05055	17 - 5935	430	7-05305	13 - 5714	264
7-04672	15 - 6253	375	7-04788	15 - 6113	389	7-04896	25 - 7723	604	7-05056	17 - 8453	433	7-05305	13 - 2917	264
7-04673	15 - 3390	391	7-04789	15 - 6099	394	7-04897	25 - 17327	604	7-05057	17 - 1203	39	7-05306	13 - 2916	263
7-04675	15 - 6112	390	7-04790	15 - 6138	394	7-04897	25 - 7327	604	7-05059	17 - 8640	435	7-05307	13 - 5870	263
7-04675	15 - 6034	390	7-04793	15 - 3434	362	7-04898	25 - 11330	604	7-05061	17 - 1187	39	7-05308	13 - 3317	284
7-04675	15 - 6129	391	7-04793	15 - 2174	337	7-04898	25 - 2234	605	7-05064	10 - 5704	178	7-05309	13 - 2929	284
7-04676	15 - 3366	327	7-04794	15 - 6009	379	7-04898	25 - 1330	604	7-05096	38 - 5831	519	7-05310	13 - 2918	263
7-04676	15 - 2051	327	7-04795	15 - 6123	330	7-04900	24 - 1285	600	7-05097	25 - 7723	604	7-05311	13 - 5714	264
7-04679	15 - 6042	383	7-04795	15 - 6219	330	7-04900	24 - 8749	599	7-05098	10 - 6890	182	7-05313	13 - 5989	290
7-04679	15 - 1017	383	7-04797	15 - 6422	324	7-04900	24 - 2268	600	7-05099	10 - 7282	182	7-05313	13 - 5988	290
7-04681	15 - 6028	383	7-04797	15 - 6189	332	7-04901	25 - 6780	606	7-05102	36 - 4396	1176	7-05314	13 - 5989	290
7-04682	15 - 6004	383	7-04801	08 - 7811	123	7-04902	25 - 2239	605	7-05105	36 - 1680	1176	7-05314	13 - 5988	290
7-04683	15 - 6078	343	7-04802	08 - 355	124	7-04902	25 - 1318	604	7-05111	36 - 4387	1174	7-05315	13 - 7124	290
7-04684	15 - 1008	410	7-04803	08 - 358	124	7-04905	24 - 1296	599	7-05115	36 - 4359	1176	7-05316	13 - 6532	290
7-04684	15 - 6002	410	7-04804	08 - 352	123	7-04906	25 - 1320	603	7-05117	36 - 4360	1174	7-05317	13 - 2186	267
7-04686	15 - 3366	327	7-04804	08 - 3266	123	7-04907	23 - 2681	584	7-05118	36 - 1600	1174	7-05318	13 - 5991	272
7-04688	15 - 6210	416	7-04805	08 - 5916	120	7-04909	20 - 1350	514	7-05122	36 - 1644	1174	7-05319	13 - 2187	272
7-04692	15 - 1103	402	7-04805	08 - 7328	118	7-04910	25 - 1302	603	7-05123	36 - 1646	1174	7-05329	13 - 2185	272
7-04697	15 - 6027	392	7-04805	08 - 341	118	7-04910	25 - 1309	603	7-05126	36 - 4391	1174	7-05333	13 - 2185	272
7-04697	15 - 3430	392	7-04806	08 - 898	124	7-04911	25 - 1303	603	7-05128	36 - 1656	1174	7-05334	13 - 6607	272
7-04698	15 - 6019	381	7-04807	08 - 3267	123	7-04912	25 - 1311	603	7-05129	36 - 1640	1174	7-05335	13 - 6608	272
7-04699	15 - 2166	392	7-04807	08 - 353	123	7-04912	25 - 1304	603	7-05131	36 - 1634	1175	7-05336	13 - 9262	276
7-04700	15 - 1058	372	7-04808	08 - 354	123	7-04913	25 - 1305	603	7-05132	36 - 1660	1175	7-05338	13 - 7978	263
7-04701	16 - 6172	421	7-04809	08 - 360	123	7-04914	25 - 1308	603	7-05136	36 - 1618	1174	7-05340	13 - 7126	264
7-04703	16 - 2670	423	7-04810	08 - 361	121	7-04914	25 - 1301	603	7-05139	36 - 4307	1176	7-05341	13 - 7127	263
7-04703	16 - 2673	423	7-04811	08 - 347	118	7-04916	20 - 1359	515	7-05140	36 - 4355	1176	7-05341	13 - 2918	263
7-04703	16 - 1143	423	7-04811	08 - 5947	122	7-04916	20 - 1359	515	7-05144	36 - 4381	1175	7-05342	13 - 2915	263
7-04704	16 - 1138	422	7-04812	08 - 5917	120	7-04918	20 - 2235	514	7-05180	36 - 1689	1177	7-05344	13 - 3236	264
7-04704	16 - 2671	422	7-04812	08 - 342	118	7-04918	20 - 8000	513	7-05181	36 - 1688	1177	7-05346	13 - 726	36
7-04705	15 - 6087	345	7-04813	08 - 359	122	7-04918	20 - 8935	514	7-05183	36 - 1690	1177	7-05350	10 - 2903	172
7-04705	15 - 6086	345	7-04814	08 - 343	118	7-04918	20 - 8934	514	7-05200	13 - 2181	263	7-05352	10 - 2934	172
7-04709	15 - 3377	359	7-04814	08 - 5918	120	7-04919	05 - 3244	94	7-052008	13 - 10128	36	7-05353	10 - 2933	172
7-04709	15 - 3378	359	7-04815	08 - 8920	122	7-04920	20 - 2232	514	7-052009	13 - 9846	269	7-05354	10 - 3301	171
7-04711	15 - 6066	338	7-04815	08 - 7700	121	7-04921	20 - 7238	513	7-052010	13 - 14241	279	7-05355	10 - 3306	172
7-04714	15 - 6068	338	7-04815	08 - 346	122	7-04922	20 - 6593	512	7-052014	13 - 9794	276	7-05358	10 - 291	171
7-04716	15 - 6195	330	7-04816	08 - 350	119	7-04923	20 - 3462	512	7-052016	13 - 10397	276	7-05359	10 - 254	171
7-04718	15 - 3380	359	7-04817	08 - 344	118	7-04924	20 - 8285	514	7-052017	13 - 9793	276	7-05360	10 - 3207	171
7-04718	15 - 3379	359	7-04817	08 - 5948	120	7-04927	20 - 7233	515	7-052018	13 - 9772	276	7-05361	10 - 3221	172
7-04719	15 - 6101	346	7-04818	08 - 349	119	7-04928	20 - 8000	513	7-05202	13 - 718	36	7-05363	10 - 3223	172
7-04719	15 -													



AFTERMARKET CROSS REFERENCE

Part No.	Rotary No.	Page No.	Part No.	Rotary No.	Page No.	Part No.	Rotary No.	Page No.	Part No.	Rotary No.	Page No.	Part No.	Rotary No.	Page No.
PRIME LINE														
7-05406	13 - 758	266	7-05956	32 - 9103	1099	7-06325	15 - 3403	347	7-06420	15 - 6111	390	7-07010	33 - 1564	1127
7-05406	13 - 5978	267	7-05975	33 - 8316	1125	7-06325	15 - 6222	372	7-06421	15 - 6162	391	7-07011	33 - 1561	1127
7-05407	13 - 5879	267	7-05975	33 - 1756	1125	7-06329	15 - 6239	342	7-06422	15 - 6166	391	7-07012	33 - 1562	1127
7-05407	13 - 759	266	7-05976	33 - 2677	1125	7-06330	15 - 6239	342	7-06425	15 - 1010	336	7-07042	27 - 8532	658
7-05408	13 - 769	266	7-05977	32 - 1736	1099	7-06330	15 - 6237	343	7-06425	15 - 3404	347	7-07044	20 - 7933	519
7-05408	13 - 5979	267	7-05978	33 - 1291	1135	7-06331	15 - 6240	341	7-06425	15 - 3442	380	7-07045	27 - 8534	498
7-05409	13 - 5880	267	7-06002	04 - 455	81	7-06332	15 - 6224	343	7-06425	15 - 2173	334	7-07048	38 - 4302	1197
7-05409	13 - 772	266	7-06003	04 - 457	81	7-06332	15 - 6088	345	7-06426	15 - 1076	398	7-07049	38 - 6893	1203
7-05410	13 - 762	266	7-06009	04 - 466	81	7-06332	15 - 6181	360	7-06428	15 - 1098	403	7-07050	22 - 8255	537
7-05411	13 - 763	266	7-06010	04 - 465	81	7-06333	15 - 6101	346	7-06428	15 - 6108	403	7-07052	22 - 7951	538
7-05412	13 - 764	266	7-06012	04 - 463	83	7-06333	15 - 2079	399	7-06429	15 - 6109	403	7-07053	22 - 7967	538
7-05413	13 - 765	266	7-06013	04 - 464	83	7-06333	15 - 6069	338	7-06429	15 - 1060	403	7-07061	20 - 7998	496
7-05413	13 - 5982	267	7-06014	04 - 456	81	7-06334	15 - 6084	346	7-06431	15 - 2169	400	7-07062	38 - 7298	500
7-05414	13 - 770	266	7-06015	04 - 865	81	7-06335	15 - 2078	399	7-06433	15 - 6185	400	7-07079	22 - 10944	536
7-05414	13 - 5983	267	7-06016	04 - 864	81	7-06337	15 - 851	407	7-06433	15 - 6035	401	7-07082	22 - 1420	537
7-05415	13 - 773	266	7-06017	04 - 462	83	7-06337	15 - 1100	345	7-06443	15 - 3394	409	7-07089	22 - 8213	528
7-05416	13 - 5985	267	7-06032	10 - 11444	167	7-06338	15 - 6087	345	7-06444	15 - 3393	407	7-07092	22 - 10945	536
7-05416	13 - 766	266	7-06035	10 - 12309	164	7-06338	15 - 1100	345	7-06444	15 - 6326	408	7-07100	38 - 1391	48
7-05417	13 - 5881	267	7-06035	10 - 12230	165	7-06338	15 - 6086	345	7-06445	15 - 3395	409	7-07102	38 - 3904	48
7-05417	13 - 767	266	7-06035	10 - 12247	165	7-06339	15 - 1089	346	7-06446	15 - 6001	412	7-07103	20 - 16000	499
7-05418	13 - 768	266	7-06049	04 - 486	84	7-06340	15 - 6181	360	7-06447	15 - 6137	407	7-07103	20 - 6000	46
7-05418	13 - 5882	267	7-06050	10 - 8295	162	7-06340	15 - 6088	345	7-06448	15 - 6136	411	7-07103-25	20 - 6000	46
7-05419	13 - 771	266	7-06051	04 - 485	84	7-06340	15 - 6224	343	7-06449	15 - 6135	411	7-07103-25	20 - 16000	499
7-05419	13 - 5986	267	7-06052	04 - 490	84	7-06341	15 - 6178	350	7-06450	15 - 6184	409	7-07104	20 - 11349	499
7-05420	13 - 5883	267	7-06053	04 - 489	84	7-06342	15 - 6175	349	7-06451	15 - 6118	412	7-07104	20 - 1349	46
7-05420	13 - 774	266	7-06054	10 - 2908	162	7-06345	15 - 6216	352	7-06453	15 - 6187	408	7-07104	20 - 2801	499
7-05421	13 - 2189	264	7-06055	10 - 2909	162	7-06346	15 - 6217	351	7-06455	15 - 3378	359	7-07104-25	20 - 2801	499
7-05429	13 - 714	36	7-06056	04 - 488	84	7-06349	15 - 2030	358	7-06455	15 - 3377	359	7-07104-25	20 - 11349	499
7-05431	13 - 8588	264	7-06057	06 - 2999	98	7-06353	15 - 3380	359	7-06456	15 - 50252	330	7-07104-25	20 - 1349	46
7-05432	13 - 6572	264	7-06058	06 - 2998	97	7-06353	15 - 3379	359	7-06457	15 - 50253	330	7-07105	19 - 6600	483
7-05433	13 - 9544	279	7-06059	10 - 8950	181	7-06354	15 - 6167	359	7-06458	15 - 3424	360	7-07106	20 - 1348	508
7-05434	13 - 2176	263	7-06060	10 - 9512	158	7-06354	15 - 6168	360	7-06492	15 - 6425	388	7-07106	20 - 7998	496
7-05434	13 - 722	36	7-06061	10 - 8687	180	7-06354	15 - 6401	360	7-06600	33 - 8502	1126	7-07106-25	20 - 7998	496
7-05435	13 - 722	36	7-06077	10 - 8682	173	7-06356	15 - 6194	319	7-06601	33 - 7762	1126	7-07107	19 - 6678	483
7-05435	13 - 722	36	7-06079	10 - 2213	173	7-06356	15 - 3339	361	7-06602	32 - 7763	1098	7-07110	19 - 5909	483
7-05438	13 - 722	36	7-06080	10 - 2215	173	7-06357	15 - 6203	361	7-06603	32 - 7764	1098	7-07110	19 - 6676	483
7-05438	13 - 7986	284	7-06081	10 - 2214	173	7-06358	15 - 6204	361	7-06611	33 - 19088	1129	7-07112	19 - 6929	483
7-05442	13 - 9856	290	7-06082	10 - 2216	173	7-06359	15 - 6290	353	7-06612	33 - 9089	1129	7-07113	19 - 6681	483
7-05444	13 - 726	36	7-06092	12 - 7581	216	7-06359	15 - 6213	361	7-06625	33 - 7761	1133	7-07114	19 - 7916	483
7-05444	13 - 727	36	7-06097	10 - 8985	162	7-06360	15 - 1066	345	7-06652	33 - 1727	1128	7-07115	23 - 6866	585
7-05449	13 - 11658	275	7-06100	11 - 384	203	7-06360	15 - 6013	319	7-06673	26 - 11022	628	7-07117	39 - 6988	486
7-05453	13 - 2193	264	7-06101	11 - 385	203	7-06361	15 - 6214	360	7-06722	15 - 6471	392	7-07120	38 - 3667	1191
7-05456	13 - 2191	264	7-06102	11 - 386	203	7-06363	15 - 3381	361	7-06723	15 - 6470	389	7-07121	38 - 1544	1191
7-05459	13 - 2192	264	7-06102	11 - 2905	203	7-06364	15 - 6150	363	7-06758	15 - 6476	391	7-07122	38 - 1551	1191
7-05477	13 - 728	36	7-06106	11 - 390	203	7-06364	15 - 6151	363	7-06759	15 - 6161	389	7-07123	38 - 4184	1195
7-05482	13 - 2182	263	7-06115	11 - 2905	203	7-06365	15 - 6151	363	7-06760	15 - 6475	390	7-07125	38 - 4186	1195
7-05485	13 - 5869	263	7-06116	11 - 8472	94	7-06365	15 - 6150	363	7-06768	15 - 1019	329	7-07129	38 - 4209	1194
7-05485	13 - 734	36	7-06150	25 - 1300	603	7-06368	15 - 6131	363	7-06772	15 - 6290	353	7-07131	38 - 3667	1191
7-05489	13 - 9508	291	7-06151	25 - 1301	603	7-06370	15 - 6093	365	7-06776	15 - 9987	357	7-07131	38 - 4183	1191
7-05494	13 - 8588	264	7-06152	25 - 1302	603	7-06373	15 - 3403	347	7-06777	15 - 9810	332	7-07139	38 - 4181	1194
7-05499	13 - 8602	264	7-06153	25 - 1303	603	7-06373	15 - 6115	338	7-06778	15 - 6484	332	7-07143	38 - 3655	47
7-05500	32 - 4803	1107	7-06154	25 - 1304	603	7-06373	15 - 6222	372	7-06779	15 - 6485	332	7-07144	38 - 4182	1194
7-05501	32 - 4802	1107	7-06155	25 - 1305	603	7-06374	15 - 6122	375	7-06780	15 - 9907	330	7-07145	38 - 4301	1195
7-05536	33 - 4818	1127	7-06156	25 - 1313	603	7-06375	15 - 6186	375	7-06784	15 - 9487	349	7-07147	38 - 8340	1197
7-05537	33 - 4817	1127	7-06157	25 - 1305	603	7-06376	15 - 6223	373	7-06787	15 - 6481	355	7-07147	38 - 4184	1195
7-05538	33 - 4819	1127	7-06200	11 - 400	49	7-06377	15 - 6221	374	7-06788	15 - 9884	321	7-07148	38 - 4180	1195
7-05540	39 - 7769	48	7-06201	11 - 401	49	7-06378	15 - 6192	374	7-06790	15 - 6270	409	7-07148	38 - 4179	1195
7-05542	39 - 4796	48	7-06202	11 - 402	49	7-06379	15 - 6193	372	7-06791	15 - 9228	391	7-07148	38 - 4923	1195
7-05542	39 - 4793	48	7-06206	11 - 406	203	7-06380	15 - 3348	375	7-06795	15 - 6448	387	7-07149	38 - 4179	1195
7-05550	10 - 8448	178	7-06250	11 - 412	49	7-06382	15 - 6258	412	7-06796	15 - 6438	387	7-07149	38 - 4180	1195
7-05551	17 - 8454	433	7-06251	11 - 413	49	7-06383	15 - 6259	412	7-06797	15 - 6479	375	7-07150	39 - 1547	487
7-05641	32 - 1563	1108	7-06252	11 - 414	49	7-06384	15 - 6257	412	7-06800	26 - 9812	618	7-07158	38 - 5840	1201
7-05656	33 - 8977	1134	7-06256	11 - 418	203	7-06385	15 - 6208	377	7-06802	26 - 9802	617	7-07160	39 - 3109	489
7-05668	13 - 9121	270	7-06260	10 - 11859	165	7-06386	15 - 6209	378	7-06805	26 - 9977	616	7-07161	38 - 4996	1200
7-05670	13 - 7180	271	7-06260	10 - 11858	167	7-06386	15 - 6208	377	7-06806	26 - 9800	617	7-07164	38 - 1544	1191
7-05671	28 - 1997	664	7-06266	10 - 12231	165	7-06387	15 - 3389	378	7-06807	26 - 9976	617	7-07164	38 - 3644	1191
7-05747	10 - 336	160	7-06279	10 - 12114	168	7-06388	15 - 3404	347	7-06808	26 - 9975	618	7-07165	38 - 4210	1200
7-05747	04 - 257	78	7-06303	15 - 6254	328	7-06388	15 - 1010	336	7-06820	26 - 9796	612	7-07166	38 - 4302	1197
7-05800	16 - 6764	421	7-06305	15 - 6220	332	7-06388	15 - 2173	334	7-06821	26 - 9797	612	7-07167	38 - 5829	1198
7-05805	16 - 1149	422	7-06309	15 - 6219	330	7-06397	15 - 6143	382	7-068					

AFTERMARKET CROSS REFERENCE



Part No.	Rotary No.	Page No.	Part No.	Rotary No.	Page No.	Part No.	Rotary No.	Page No.	Part No.	Rotary No.	Page No.	Part No.	Rotary No.	Page No.
PRIME LINE														
7-07223	18 - 1268	439	7-07803	12 - 7597	216	7-07830	12 - 6949	235	7-07870	12 - 7552	215	7-07935	12 - 7790	254
7-07228	18 - 7727	442	7-07803	12 - 5179	213	7-07830	12 - 7510	215	7-07872	12 - 7629	216	7-07936	12 - 8463	222
7-07237	18 - 1276	444	7-07803	12 - 8092	246	7-07831	12 - 7543	215	7-07872	12 - 5211	213	7-07937	12 - 9367	222
7-07237	18 - 8004	445	7-078030	12 - 7448	214	7-07831	12 - 5133	212	7-07874	12 - 7474	215	7-07938	12 - 9368	223
7-07239	18 - 12296	438	7-078038	12 - 8714	255	7-07832	12 - 5089	212	7-07874	12 - 5064	212	7-07939	12 - 8781	223
7-07239	18 - 1275	34	7-078039	12 - 10405	255	7-07832	12 - 7499	215	7-07875	12 - 7627	216	7-07942	12 - 8803	242
7-07239	18 - 2296	438	7-07804	12 - 5218	213	7-07836	12 - 9767	223	7-07875	12 - 8091	246	7-07943	12 - 11853	242
7-07240	18 - 1273	439	7-07804	12 - 7636	216	7-07836	12 - 7522	215	7-07875	12 - 8803	242	7-07944	12 - 8811	242
7-07241	18 - 1270	34	7-078046	12 - 9016	247	7-07836	12 - 6843	233	7-07875	12 - 5236	254	7-07946	12 - 8808	242
7-07241	18 - 2294	438	7-078047	12 - 9014	247	7-07836	12 - 6901	222	7-07875	12 - 6970	240	7-07948	12 - 7526	215
7-07341	27 - 9224	643	7-078048	12 - 10029	243	7-07836	12 - 5112	212	7-07875	12 - 5209	213	7-07949	12 - 7499	215
7-07344	27 - 9226	643	7-078049	12 - 8432	221	7-07837	12 - 7512	215	7-07876	12 - 8431	221	7-07950	12 - 6906	233
7-07395	27 - 3520	636	7-07805	12 - 5220	213	7-07837	12 - 5102	212	7-07876	12 - 7483	215	7-07951	12 - 7532	215
7-07395	27 - 5930	636	7-07805	12 - 7638	216	7-07837	12 - 8512	222	7-07876	12 - 5073	212	7-07952	12 - 7495	215
7-07396	27 - 3513	636	7-07805	12 - 5823	242	7-07839	12 - 7610	216	7-07876	12 - 7791	254	7-07953	12 - 6949	235
7-07403	37 - 3009	1180	7-078053	12 - 8428	221	7-07839	12 - 6844	233	7-07876	12 - 6503	237	7-07955	12 - 7613	216
7-07426	26 - 2436	634	7-078056	12 - 12077	230	7-07839	12 - 5192	213	7-07877	12 - 5235	254	7-07956	12 - 7438	214
7-07430	09 - 8240	148	7-07806	12 - 5241	242	7-07840	12 - 5175	213	7-07879	12 - 7513	215	7-07957	12 - 9119	234
7-07430	09 - 5707	147	7-07806	12 - 7589	216	7-07840	12 - 6908	235	7-07879	12 - 5103	212	7-07958	12 - 9120	234
7-07434	10 - 7125	157	7-07806	12 - 5171	213	7-07841	12 - 5116	212	7-07880	12 - 8463	222	7-07959	12 - 7519	215
7-07436	10 - 2218	157	7-07806	12 - 5865	246	7-07841	12 - 7526	215	7-07880	12 - 5111	212	7-07962	12 - 7612	216
7-07437	10 - 6886	175	7-07806	12 - 5233	257	7-07841	12 - 4998	237	7-07880	12 - 7521	215	7-07963	12 - 7615	216
7-07438	42 - 7097	1231	7-078066	12 - 5198	213	7-07841	12 - 6509	238	7-07881	12 - 6874	240	7-07964	12 - 6903	237
7-07439	10 - 2226	162	7-078074	12 - 9863	248	7-07842	12 - 5119	212	7-07882	12 - 5008	211	7-07965	12 - 8442	238
7-07440	10 - 7181	162	7-078076	12 - 10041	248	7-07842	12 - 6904	238	7-07882	12 - 669	240	7-07966	12 - 7529	215
7-07440	10 - 2226	162	7-07808	12 - 7446	214	7-07842	12 - 7529	215	7-07882	12 - 7430	214	7-07967	12 - 9712	238
7-07443	10 - 5706	176	7-07808	12 - 5024	211	7-07843	12 - 7446	214	7-07884	12 - 5017	211	7-07968	12 - 8972	238
7-07445	10 - 6580	157	7-078089	12 - 10036	244	7-07843	12 - 5024	211	7-07884	12 - 7477	215	7-07969	12 - 9313	239
7-07449	31 - 8086	46	7-07809	12 - 7557	215	7-07844	12 - 5090	212	7-07884	12 - 7439	214	7-07970	12 - 9713	239
7-07454	41 - 7678	93	7-07809	12 - 6642	212	7-07844	12 - 7500	215	7-07884	12 - 5067	212	7-07971	12 - 9714	239
7-07455	05 - 6880	93	7-078093	12 - 10011	244	7-07845	12 - 6903	237	7-07884	12 - 8430	221	7-07972	12 - 9715	239
7-07456	09 - 7836	144	7-078098	12 - 10435	230	7-07845	12 - 7542	215	7-07884	12 - 8425	221	7-07973	12 - 8443	238
7-07457	05 - 8898	93	7-078099	12 - 10434	230	7-07845	12 - 9120	234	7-07885	12 - 7952	241	7-07974	12 - 7630	216
7-07459	10 - 3242	161	7-07810	12 - 5104	212	7-07845	12 - 8465	222	7-07886	12 - 5099	212	7-07975	12 - 5231	258
7-07460	38 - 7259	519	7-07810	12 - 7514	215	7-07846	12 - 6507	238	7-07886	12 - 7509	215	7-07977	12 - 7500	215
7-07461	20 - 7730	510	7-078103	12 - 10437	230	7-07846	12 - 7497	215	7-07886	12 - 5821	241	7-07979	12 - 7532	215
7-07464	10 - 7886	180	7-07811	12 - 6949	235	7-07846	12 - 5087	212	7-07887	12 - 6837	258	7-07982	12 - 9697	223
7-07465	10 - 7885	180	7-07811	12 - 5100	212	7-07846	12 - 8810	242	7-07888	12 - 7546	215	7-07983	12 - 9698	223
7-07467	05 - 7255	93	7-07812	12 - 6896	240	7-07847	12 - 7489	215	7-07888	12 - 7171	241	7-07984	12 - 9312	223
7-07468	05 - 6930	92	7-07812	12 - 7525	215	7-07847	12 - 5079	212	7-07888	12 - 7129	240	7-07990	12 - 8809	242
7-07472	10 - 8625	156	7-07812	12 - 5115	212	7-07848	12 - 5063	212	7-07888	12 - 6631	212	7-08002	22 - 10873	535
7-07475	09 - 324	39	7-07813	12 - 7623	216	7-07848	12 - 7473	215	7-07889	12 - 5122	212	7-08011	22 - 10211	535
7-07476	09 - 325	39	7-07813	12 - 5205	213	7-07848	12 - 7245	238	7-07889	12 - 7532	215	7-08015	22 - 10876	535
7-07476	09 - 325	39	7-07813	12 - 8509	245	7-07849	12 - 8798	260	7-07890	12 - 5130	212	7-08024	22 - 10875	535
7-07477	09 - 8351	131	7-07814	12 - 6896	240	7-07849	12 - 8444	238	7-07890	12 - 7540	215	7-08026	38 - 9199	1202
7-07477	09 - 327	39	7-07814	12 - 5115	212	7-07849	12 - 5080	212	7-07891	12 - 7550	215	7-08027	38 - 4923	1195
7-07477	09 - 6573	133	7-07814	12 - 4998	237	7-07849	12 - 5820	241	7-07891	12 - 6635	212	7-08028	38 - 4179	1195
7-07477	09 - 328	133	7-07814	12 - 7525	215	7-07849	12 - 7490	215	7-07892	12 - 7487	215	7-08100	41 - 5511	1223
7-07478	09 - 7950	131	7-07814	12 - 6630	212	7-07849	12 - 7490	215	7-07892	12 - 5077	212	7-08101	41 - 5513	1223
7-07478	09 - 326	39	7-07816	12 - 8442	238	7-07850	12 - 7673	238	7-07893	12 - 7894	260	7-08103	41 - 5512	1223
7-07479	10 - 8302	163	7-07816	12 - 7545	215	7-07851	12 - 5128	212	7-07902	12 - 5213	213	7-08105	41 - 5514	1224
7-07480	10 - 8303	163	7-07817	12 - 5029	211	7-07851	12 - 7538	215	7-07902	12 - 7631	216	7-08106	41 - 5528	1224
7-07481	10 - 8663	160	7-07817	12 - 7451	214	7-07851	12 - 8784	222	7-07905	12 - 5124	212	7-08107	41 - 5529	1224
7-07494	10 - 2212	174	7-078176	12 - 11019	236	7-07852	12 - 6505	237	7-07906	12 - 6509	238	7-08108	41 - 5515	1224
7-07496	10 - 9489	174	7-07818	12 - 7437	214	7-07852	12 - 5124	212	7-07906	12 - 7526	215	7-08109	41 - 5502	1224
7-07497	10 - 2210	174	7-07818	12 - 5015	211	7-07852	12 - 7534	215	7-07906	12 - 5116	212	7-08110	41 - 5503	1224
7-07498	10 - 9159	174	7-07819	12 - 6632	212	7-07853	12 - 7484	215	7-07907	12 - 5126	212	7-08111	41 - 5505	1224
7-07501	21 - 8722	523	7-07819	12 - 7547	215	7-07853	12 - 5074	212	7-07907	12 - 7536	215	7-08113	41 - 5506	1224
7-07501	21 - 2227	522	7-078194	12 - 10831	235	7-07853	12 - 6503	237	7-07907	12 - 8511	222	7-08114	41 - 5504	1225
7-07502	21 - 8721	523	7-07820	12 - 5071	212	7-07854	12 - 7672	238	7-07908	12 - 7532	215	7-08115	41 - 5521	1225
7-07502	21 - 2228	522	7-07820	12 - 8760	250	7-07854	12 - 7520	215	7-07908	12 - 5122	212	7-08117	41 - 5508	1225
7-07563	20 - 9650	515	7-07820	12 - 7481	215	7-07854	12 - 5110	212	7-07908	12 - 8516	223	7-08118	41 - 5509	1225
7-07564	20 - 10018	513	7-078206	12 - 12610	234	7-07855	12 - 5128	212	7-07908	12 - 6502	237	7-08119	41 - 5520	1226
7-07600	39 - 4895	1213	7-07822	12 - 8820	260	7-07855	12 - 8784	222	7-07909	12 - 5013	211	7-08120	41 - 5566	1223
7-07601	39 - 4860	1213	7-07822	12 - 8432	221	7-07855	12 - 6508	238	7-07909	12 - 6950	233	7-08121	41 - 5567	1223
7-07602	39 - 4861	1213	7-07822	12 - 7440	214	7-07855	12 - 7538	215	7-07909	12 - 7435	214	7-08122	41 - 5531	1223
7-07670	23 - 8789	584	7-07822	12 - 5018	211	7-07857	12 - 8516	223	7-07911	12 - 8747	238	7-08124	41 - 5523	1223
7-07708	39 - 7686	1212	7-07823	12 - 6842	236	7-07857	12 - 7532	215	7-07915	12 - 670</				



AFTERMARKET CROSS REFERENCE

Part No.	Rotary No.	Page No.	Part No.	Rotary No.	Page No.	Part No.	Rotary No.	Page No.	Part No.	Rotary No.	Page No.	Part No.	Rotary No.	Page No.
PRIME LINE														
7-083023	19-9585	464	7-3H270	12-5010	211	7-4H340	12-7477	215	7-4H670	12-7510	215	7-4H970	12-7540	215
7-083029	19-10313	465	7-3H280	12-5011	211	7-4H340	12-8425	221	7-4H670	12-6949	235	7-4H980	12-7541	215
7-08303	19-8330	480	7-3H280	12-7433	214	7-4H350	12-7478	215	7-4H670	12-5100	212	7-4H980	12-5131	212
7-083034	19-10263	455	7-3H280	12-8819	260	7-4H350	12-5068	212	7-4H680	12-5101	212	7-4H980	12-8462	222
7-083037	19-8712	467	7-3H290	12-7434	214	7-4H360	12-8811	242	7-4H680	12-7511	215	7-4H990	12-8465	222
7-08304	19-8785	479	7-3H290	12-5012	211	7-4H360	12-5069	212	7-4H690	12-7512	215	7-4H990	12-7542	215
7-083047	19-9245	471	7-3H300	12-6950	233	7-4H360	12-8733	248	7-4H690	12-5102	212	7-4H990	12-5132	212
7-083048	19-8966	470	7-3H300	12-7435	214	7-4H360	12-7479	215	7-4H690	12-8510	222	7-4H990	12-9120	234
7-08305	19-9168	454	7-3H300	12-5013	211	7-4H370	12-7480	215	7-4H690	12-8512	222	7-4H990	12-6903	237
7-08306	19-7980	460	7-3H310	12-7436	214	7-4H370	12-5070	212	7-4H700	12-5103	212	7-5H1000	12-5227	213
7-08308	19-7880	455	7-3H310	12-5014	211	7-4H370	12-8428	221	7-4H700	12-7513	215	7-5H1000	12-7645	216
7-08310	19-8483	455	7-3H320	12-7437	214	7-4H380	12-5071	212	7-4H710	12-5104	212	7-5H1030	12-7648	216
7-083106	19-14648	477	7-3H320	12-5015	211	7-4H380	12-7481	215	7-4H710	12-7514	215	7-5H1030	12-6645	213
7-08314	19-7746	480	7-3H330	12-10306	223	7-4H390	12-7482	215	7-4H720	12-7515	215	7-5H260	12-5153	213
7-08315	19-7042	462	7-3H330	12-8429	221	7-4H390	12-8427	221	7-4H720	12-5105	212	7-5H260	12-7571	216
7-08319	19-7040	482	7-3H330	12-7438	214	7-4H390	12-5072	212	7-4H730	12-5106	212	7-5H270	12-7572	216
7-08322	27-6966	485	7-3H330	12-5016	211	7-4H400	12-5073	212	7-4H730	12-7516	215	7-5H270	12-5154	213
7-08328	19-8331	458	7-3H340	12-7439	214	7-4H400	12-8431	221	7-4H740	12-7517	215	7-5H280	12-7573	216
7-08329	19-8903	461	7-3H340	12-8430	221	7-4H400	12-7791	254	7-4H740	12-5107	212	7-5H280	12-5155	213
7-08332	19-8815	454	7-3H340	12-5017	211	7-4H400	12-7483	215	7-4H740	12-6841	233	7-5H290	12-7574	216
7-08334	39-8818	487	7-3H350	12-8820	260	7-4H400	12-6503	237	7-4H750	12-5108	212	7-5H290	12-5156	213
7-08342	27-8735	485	7-3H350	12-8432	221	7-4H410	12-7484	215	7-4H750	12-7518	215	7-5H300	12-7575	216
7-08352	19-11793	462	7-3H350	12-7440	214	7-4H410	12-5074	212	7-4H760	12-7519	215	7-5H300	12-5157	213
7-08355	19-9841	465	7-3H350	12-5018	211	7-4H420	12-7485	215	7-4H760	12-5109	212	7-5H310	12-5158	213
7-08358	19-8622	465	7-3H360	12-8426	221	7-4H420	12-5075	212	7-4H770	12-5110	212	7-5H310	12-7576	216
7-08359	19-9852	465	7-3H360	12-7441	214	7-4H430	12-7486	215	7-4H770	12-7520	215	7-5H320	12-7577	216
7-08360-1	19-9584	464	7-3H370	12-5019	211	7-4H430	12-5076	212	7-4H780	12-8463	222	7-5H320	12-5159	213
7-08369	39-1568	490	7-3H370	12-7442	214	7-4H440	12-5077	212	7-4H780	12-5111	212	7-5H330	12-7578	216
7-08370	39-1567	490	7-3H370	12-5020	211	7-4H440	12-7487	215	7-4H780	12-7521	215	7-5H330	12-5160	213
7-08371	27-4300	490	7-3H380	12-5021	211	7-4H450	12-5078	212	7-4H790	12-6901	222	7-5H340	12-7579	216
7-08372	27-7206	490	7-3H380	12-7443	214	7-4H450	12-7488	215	7-4H790	12-5112	212	7-5H340	12-5161	213
7-08373	27-8589	491	7-3H390	12-7444	214	7-4H460	12-5079	212	7-4H790	12-7522	215	7-5H350	12-7580	216
7-08374	27-11659	493	7-3H390	12-5022	211	7-4H460	12-7489	215	7-4H790	12-6843	233	7-5H350	12-5162	213
7-08375	19-9776	492	7-3H400	12-5023	211	7-4H470	12-8444	238	7-4H800	12-7523	215	7-5H350	12-6906	233
7-08380	19-9609	492	7-3H400	12-7445	214	7-4H470	12-5080	212	7-4H800	12-5113	212	7-5H360	12-7581	216
7-08390	27-8410	491	7-3H410	12-7446	214	7-4H470	12-7490	215	7-4H800	12-6900	222	7-5H360	12-5163	213
7-08392	19-9591	454	7-3H410	12-5024	211	7-4H470	12-5820	241	7-4H800	12-8443	238	7-5H370	12-5164	213
7-08393	27-8585	485	7-3H420	12-5025	211	7-4H470	12-8798	260	7-4H810	12-5114	212	7-5H370	12-7582	216
7-08410	09-9160	136	7-3H420	12-7447	214	7-4H480	12-7491	215	7-4H810	12-7524	215	7-5H380	12-7583	216
7-08412	09-6534	135	7-3H430	12-7448	214	7-4H480	12-5081	212	7-4H820	12-4998	237	7-5H380	12-6907	235
7-08413	09-6625	130	7-3H430	12-5026	211	7-4H490	12-5082	212	7-4H820	12-8464	223	7-5H380	12-5165	213
7-08414	09-3305	146	7-3H440	12-5027	211	7-4H490	12-7492	215	7-4H820	12-5115	212	7-5H390	12-5166	213
7-08415	09-8306	146	7-3H440	12-7449	214	7-4H500	12-7493	215	7-4H820	12-6896	240	7-5H390	12-7584	216
7-08416	09-9572	133	7-3H450	12-7450	214	7-4H500	12-5237	242	7-4H820	12-7525	215	7-5H400	12-5167	213
7-08418	09-8984	147	7-3H450	12-5028	211	7-4H500	12-5231	258	7-4H830	12-5116	212	7-5H400	12-7585	216
7-08420	10-10007	181	7-3H460	12-5029	211	7-4H500	12-5083	212	7-4H830	12-6509	238	7-5H400	12-5238	242
7-08421	09-7262	142	7-3H460	12-7451	214	7-4H510	12-5235	254	7-4H830	12-7526	215	7-5H410	12-7586	216
7-08538	15-6162	391	7-3H470	12-7452	214	7-4H510	12-5084	212	7-4H840	12-8781	223	7-5H410	12-5168	213
7-08539	15-6113	389	7-3H480	12-5030	211	7-4H510	12-7494	215	7-4H840	12-7527	215	7-5H420	12-7587	216
7-08540	15-1127	372	7-3H480	12-7453	214	7-4H520	12-5085	212	7-4H840	12-5117	212	7-5H420	12-5169	213
7-08541	15-9229	323	7-3H490	12-5031	211	7-4H520	12-7169	233	7-4H850	12-6838	233	7-5H430	12-7588	216
7-08542	15-9230	324	7-3H490	12-7454	214	7-4H520	12-7495	215	7-4H850	12-7528	215	7-5H430	12-5170	213
7-08544	15-9465	324	7-3H500	12-7455	214	7-4H530	12-7496	215	7-4H850	12-5118	212	7-5H440	12-5171	213
7-08545	15-9883	325	7-4H1000	12-5133	212	7-4H530	12-6507	238	7-4H860	12-7529	215	7-5H440	12-7589	216
7-08546	15-9885	321	7-4H1020	12-7543	215	7-4H530	12-8711	251	7-4H860	12-5119	212	7-5H440	12-5241	242
7-08548	15-6495	329	7-4H1102	12-6630	212	7-4H530	12-5086	212	7-4H860	12-6904	238	7-5H440	12-5233	257
7-08549	15-10072	323	7-4H1102	12-7545	215	7-4H540	12-6507	238	7-4H870	12-7530	215	7-5H440	12-5865	246
7-08550	15-10073	324	7-4H1102	12-7545	215	7-4H540	12-8810	242	7-4H870	12-5120	212	7-5H450	12-7590	216
7-09000	04-5890	83	7-4H1020	12-6630	212	7-4H540	12-7497	215	7-4H880	12-5121	212	7-5H450	12-5172	213
7-09398	19-9583	468	7-4H1140	12-8442	238	7-4H540	12-5087	212	7-4H880	12-8516	223	7-5H460	12-5173	213
7-09400	32-9087	1100	7-4H1140	12-7557	215	7-4H550	12-5088	212	7-4H880	12-6502	237	7-5H460	12-7591	216
7-09700	23-6857	555	7-4H220	12-6642	212	7-4H550	12-7498	215	7-4H880	12-7184	222	7-5H470	12-5174	213
7-09701	23-6858	555	7-4H230	12-5055	212	7-4H550	12-6876	237	7-4H880	12-8972	238	7-5H470	12-7592	216
7-09702	23-6859	555	7-4H230	12-7466	215	7-4H560	12-7499	215	7-4H880	12-7531	215	7-5H480	12-5175	213
7-09703	23-6860	555	7-4H240	12-5056	212	7-4H560	12-5089	212	7-4H890	12-7532	215	7-5H480	12-7593	216
7-09704	23-6861	555	7-4H240	12-8780	232	7-4H570	12-5090	212	7-4H890	12-5122	212	7-5H480	12-6908	2

AFTERMARKET CROSS REFERENCE



Part No.	Rotary No.	Page No.	Part No.	Rotary No.	Page No.	Part No.	Rotary No.	Page No.	Part No.	Rotary No.	Page No.	Part No.	Rotary No.	Page No.
PRIME LINE			7-5H950	12-5222	213	056-066	19-9200	478	090-366	34-10524	1142	096-378	34-10534	1143
7-5H590	12-7604	216	7-5H950	12-7640	216	056-146	26-12657	626	090-366	34-11524	1142	096-3787	34-10534	1143
7-5H600	12-7605	216	7-5H960	12-7641	216	056-154	22-1434	538	090-3667	34-10524	1142	096-380	34-11687	1144
7-5H600	12-5187	213	7-5H960	12-5223	213	075-010	35-10916	1150	090-368	34-10527	1142	096-410	34-10621	1140
7-5H610	12-7606	216	7-5H970	12-7642	216	075-163	35-10612	1161	090-3687	34-10527	1142	096-4107	34-10621	1140
7-5H610	12-5188	213	7-5H970	12-5224	213	075-166	35-10603	1157	090-370	34-10524	1142	096-425	34-10509	1140
7-5H620	12-5189	213	7-5H980	12-7643	216	075-170	35-10603	1157	090-3707	34-10524	1142	096-4257	34-10509	1140
7-5H620	12-7607	216	7-5H980	12-5225	213	075-183	35-10611	1161	090-372	34-10525	1142	096-464	34-10542	1143
7-5H630	12-5190	213	7-5H990	12-5226	213	075-2007	35-14343	1149	090-3727	34-10525	1142	096-4647	34-10542	1143
7-5H630	12-7608	216	7-5H990	12-7644	216	076-060	35-10610	1157	090-425	34-10496	1140	096-466	34-10543	1143
7-5H640	12-6844	233	7-70839	12-10388	230	076-064	35-10604	1157	090-4257	34-10496	1140	096-4667	34-10543	1143
7-5H640	12-5191	213	SE-14	01-21	43	076-072	35-10597	1157	090-525	34-10498	1140	096-472	34-10544	1143
7-5H640	12-8731	248	SE-15	01-10	41	076-076	35-10596	1157	090-5257	34-10498	1140	096-4727	34-10544	1143
7-5H640	12-7609	216				076-080	35-10595	1157	090130	34-4287	1141	096-525	34-10511	1140
7-5H650	12-7610	216				076-096	35-10602	1159	090230	34-4294	1141	096-5257	34-10511	1140
7-5H650	12-5192	213	STENS			076-100	35-10575	1165	091-325	34-11543	1140	096-562	34-10534	1143
7-5H660	12-5193	213	001-004	34-10532	1143	076-240	35-10840	1152	091-3257	34-11543	1140	096-5627	34-10534	1143
7-5H660	12-7611	216	025-043	05-12093	94	076-248	35-10828	1152	092-310	34-10489	1140	096-567	34-10545	1143
7-5H670	12-7612	216	025-047	05-12093	94	076-252	35-10836	1152	092-325	34-10501	1140	096-5677	34-10545	1143
7-5H670	12-5194	213	025-051	05-12092	94	076-256	35-10837	1152	092-3257	34-10501	1140	096-568	34-10535	1142
7-5H680	12-5195	213	025-055	05-12092	94	076-260	35-10838	1152	092-3597	34-11665	1144	096-5687	34-10535	1142
7-5H680	12-7613	216	025-223	05-12093	94	077-1607	35-14235	1149	092-3597	34-11665	1144	096-574	34-10546	1143
7-5H690	12-6842	236	025-427	05-12093	94	079-160	35-10603	1157	092-360	34-11666	1144	096-5747	34-10546	1143
7-5H690	12-7614	216	025-447	05-12092	94	079-162	35-10603	1157	092-368	34-11669	1144	096-580	34-11055	1143
7-5H690	12-5196	213	025-451	05-12092	94	079-164	35-10609	1165	092-370	34-11670	1144	096-581	34-11528	1143
7-5H700	12-7615	216	050-009	19-7038	482	079-167	35-10612	1161	092-372	34-11671	1144	096-5817	34-11528	1143
7-5H700	12-5197	213	050-021	19-6698	482	079-168	35-10599	1157	092-372	34-11529	1144	096230	34-4292	1141
7-5H710	12-5198	213	050-029	19-7040	482	079-187	35-10611	1161	092-425	34-10503	1140	097-325	34-10508	1140
7-5H710	12-6972	258	050-717	19-9748	477	079-275	35-12433	1171	092-4257	34-10503	1140	097-3257	34-10508	1140
7-5H710	12-7616	216	051-099	21-12522	525	079-282	35-12538	1171	092-464	34-11674	1144	097-366	34-10536	1142
7-5H720	12-5199	213	051-100	21-12512	525	085-001	36-1689	1171	092-472	34-11545	1142	097-3667	34-10536	1142
7-5H720	12-7617	216	054-009	19-11230	464	085-004	36-12036	1177	092-472	34-11529	1144	097-368	34-10537	1142
7-5H730	12-5200	213	054-071	20-12515	496	085-005	36-9498	1177	092-4727	34-11529	1144	097-3687	34-10537	1142
7-5H730	12-7618	216	054-095	31-10673	1079	085-009	36-10987	1177	092-525	34-10505	1140	097-372	34-10538	1142
7-5H740	12-7619	216	054-167	19-10398	465	085-009	36-1688	1177	092-5257	34-10505	1140	097-3727	34-10538	1142
7-5H740	12-6872	240	054-179	19-10880	464	085-012	36-12045	1177	094-310	34-10491	1140	097-425	34-10510	1140
7-5H740	12-6845	235	054-259	19-12758	466	085-013	36-1686	1177	094-3257	34-10517	1140	097-4257	34-10510	1140
7-5H740	12-5201	213	054-303	19-12786	466	085-017	36-9499	1177	095-121	34-10557	1141	097-468	34-10540	1142
7-5H750	12-8767	257	054-307	19-12787	466	085-017	36-1690	1177	095-1217	34-10557	1141	097-472	34-10541	1142
7-5H750	12-5202	213	055-005	19-231847S	471	085-030	36-12044	1177	095-131	34-10551	49	097-4727	34-10541	1142
7-5H750	12-7620	216	055-009	19-235116S	470	085-033	36-4387	1174	095-1317	34-10551	49	097-525	34-10525	1142
7-5H760	12-5203	213	055-017	19-4508302S	472	085-041	36-1618	1174	095-210	34-10664	1140	097-525	34-11525	1140
7-5H760	12-7621	216	055-021	19-4708301S	473	085-053	36-4391	1174	095-225	34-10564	1140	097-5257	34-10525	1142
7-5H770	12-5204	213	055-025	19-4708303S	471	085-057	36-1646	1174	095-2257	34-10564	1140	098-310	34-10493	1140
7-5H770	12-7622	216	055-029	19-1208305S	467	085-059	36-8058	1177	095-231	34-10547	49	098-3107	34-10493	1140
7-5H780	12-8509	245	055-033	19-1208310S	467	085-061	36-1644	1174	095-2317	34-10547	49	098-325	34-10516	1140
7-5H780	12-7623	216	055-041	19-2408303S	470	085-065	36-1640	1174	095-310	34-10488	1140	098-3257	34-10516	1140
7-5H780	12-5205	213	055-049	19-9989	474	085-068	36-8062	1177	095-325	34-10499	1140	098-4107	34-10622	1140
7-5H790	12-5206	213	055-057	19-237421S	470	085-069	36-1656	1174	095-3257	34-10499	1140	098-425	34-10514	1140
7-5H790	12-7624	216	055-065	19-4508301S	472	085-073	36-4381	1175	095-345	34-10522	1142	098-4257	34-10514	1140
7-5H800	12-7625	216	055-069	19-5208301S	473	085-077	36-1600	1174	095-3457	34-10522	1142	098-510	34-11530	1140
7-5H800	12-5207	213	055-073	19-1208308S	467	085-081	36-1660	1175	095-348	35-10606	1159	098-510	34-10622	1140
7-5H800	12-6871	240	055-077	19-1208312S	467	085-085	36-1634	1175	095-349	34-10536	1142	098-510	34-10492	1140
7-5H810	12-7626	216	055-085	19-2408302S	471	085-089	36-4359	1176	095-3497	34-10536	1142	098-525	34-10500	1140
7-5H810	12-5208	213	055-089	19-2408305S	470	085-109	36-4307	1176	095-350	34-10520	1142	098-5257	34-10500	1140
7-5H820	12-8803	242	055-093	19-10212	472	085-113	36-4355	1176	095-3507	34-10520	1142	099-366	34-11681	1144
7-5H820	12-5236	254	055-097	19-10213	474	085-117	36-4360	1174	095-352	34-10518	1142	099-372	34-11684	1144
7-5H820	12-5209	213	055-101	19-277233S	483	085-137	36-4308	1176	095-3527	34-10518	1142	099-4107	34-10530	1143
7-5H820	12-7627	216	055-105	19-1205001S	483	085-141	36-4396	1176	095-353	34-10537	1142	099-574	34-11697	1144
7-5H820	12-6970	240	055-109	19-5205002S	483	085-145	36-1680	1176	095-353	35-10605	1159	100-008	19-1390	479
7-5H820	12-8091	246	055-113	20-2405013S	497	085-149	36-1604	1175	095-3537	34-10537	1142	100-0083	19-1390	479
7-5H830	12-7628	216	055-117	20-13652	496	085-173	36-10819	1175	095-355	34-10538	1142	100-012	19-7725	460
7-5H830	12-5210	213	055-117	20-2505007S	496	085-225	36-12038	1174	095-3557	34-10538	1142	100-012	19-7712	460
7-5H840	12-7629	216	055-121	20-2505022S	498	085-269	36-1619	1176	095-356	34-10528	1142	100-016	19-1389	471
7-5H840														



AFTERMARKET CROSS REFERENCE

Part No.	Rotary No.	Page No.	Part No.	Rotary No.	Page No.	Part No.	Rotary No.	Page No.	Part No.	Rotary No.	Page No.	Part No.	Rotary No.	Page No.
STENS			100-598	19-10752	458	102-004	27-3122	486	102-863	19-7051	456	115-204	20-4198	506
100-127	19-7949	453	100-602	19-1379	475	102-008	19-12282	454	102-871	19-13629	449	115-212	20-4199	506
100-131	19-2777	452	100-606	19-10183	475	102-012	19-13644	457	102-871	19-10304	456	115-212	20-6619	505
100-139	27-8410	491	100-610	19-1381	480	102-016	19-14158	457	102-875	19-10184	456	115-220	20-6620	505
100-149	19-2790	476	100-622	19-9584	464	102-024	19-7877	455	102-906	19-6514	454	115-220	20-4200	506
100-153	19-9273	456	100-628	19-1382	480	102-028	19-9167	456	102-911	39-13166	486	115-284	20-6616	505
100-156	19-2791	476	100-632	19-11547	451	102-032	19-14289	457	102-920	19-10105	454	115-295	20-1502	505
100-160	19-9506	464	100-636	19-1392	480	102-053	19-7045	462	102-941	19-2792	476	115-315	20-11549	505
100-164	19-2806	452	100-640	19-10263	455	102-061	19-6695	482	105-007	18-2294	438	115-319	20-10699	505
100-168	19-9611	464	100-644	19-1393	480	102-087	19-6698	482	105-007	18-1270	34	115-323	20-6616	505
100-172	19-1394	479	100-648	19-10454	455	102-091	19-9592	454	105-0073	18-1270	34	115-327	20-6617	505
100-176	19-9304	456	100-651	19-1383	480	102-095	19-6694	482	105-0073	18-2294	438	115-327	20-4197	506
100-180	19-1395	479	100-655	19-1392	480	102-095	19-6695	482	105-015	18-2294	438	115-331	20-8386	505
100-1803	19-1395	479	100-659	19-8331	458	102-103	19-6575	453	105-015	18-1270	34	115-331	20-8595	506
100-184	19-8815	454	100-663	19-9571	458	102-111	19-5862	478	105-023	18-2280	440	115-335	20-6619	505
100-188	19-6705	465	100-667	19-10398	465	102-119	19-11795	454	105-023	18-862	438	115-335	20-4199	506
100-192	19-8490	454	100-669	19-1369	452	102-129	19-6603	453	105-064	18-1268	439	115-339	20-4200	506
100-198	19-2778	453	100-677	19-2779	475	102-137	19-7209	476	105-064	18-1272	34	115-339	20-6620	505
100-202	19-7052	465	100-685	19-2786	452	102-149	19-8903	461	105-072	18-1280	444	115-343	20-6618	505
100-206	19-2789	455	100-697	19-12960	449	102-149	19-8904	461	105-072	18-1282	444	115-343	20-4198	506
100-2063	19-2789	455	100-705	27-14085	495	102-160	19-6847	479	105-098	18-1275	34	120-006	20-11357	499
100-210	19-9852	465	100-709	27-11807	493	102-164	19-10678	460	105-098	18-2296	438	120-006	20-1357	46
100-214	19-2788	452	100-713	27-11806	493	102-178	19-6848	481	105-098	18-12296	438	120-014	20-11349	499
100-218	19-7714	465	100-719	19-7726	462	102-182	19-10881	464	105-106	18-1275	34	120-014	20-1349	46
100-219	19-7095	453	100-719	19-7713	462	102-186	19-10882	464	105-106	18-2296	438	120-014	20-2801	499
100-222	19-12784	479	100-719	19-2805	461	102-194	19-13641	457	105-106	18-12296	438	120-030	20-1348	508
100-222	19-14188	479	100-727	19-2782	481	102-210	27-7208	490	105-1063	18-12296	438	120-048	20-1503	508
100-222	19-2784	479	100-735	19-2783	480	102-218	19-11793	462	105-1063	18-2296	438	120-055	20-1342	508
100-226	19-8482	455	100-739	27-14258	495	102-222	19-9167	456	105-1063	18-1275	34	120-071	20-1346	34
100-227	19-7949	453	100-743	19-2786	452	102-226	19-8814	456	105-114	18-2283	444	120-089	20-8679	510
100-230	19-2798	478	100-743	19-9245	471	102-230	19-7880	455	105-122	18-8001	440	120-089	20-1345	34
100-234	19-8483	455	100-743	19-2797	452	102-236	19-2828	463	105-122	18-1277	439	120-113	20-5903	43
100-238	19-9841	465	100-750	19-1377	470	102-244	19-2808	462	105-130	18-1279	444	120-113	20-5904	43
100-248	19-6849	481	100-754	19-8966	470	102-244	19-2809	462	105-148	18-1278	439	120-113	20-5905	43
100-263	19-2843	481	100-758	19-2408303S	470	102-263	19-8906	461	105-148	18-892	438	120-113	20-15904	508
100-271	27-7206	490	100-758	19-8329	470	102-285	19-6515	479	105-155	18-1283	440	120-139	20-3450	43
100-289	19-2807	462	100-766	19-12674	472	102-301	19-6704	482	105-163	18-1269	439	120-158	20-7998	496
100-293	27-8735	485	100-768	19-2844	472	102-305	19-2508301S	468	105-171	18-2285	442	120-158	20-10352	500
100-297	27-4300	490	100-768	19-7785	471	102-305	19-9583	468	105-189	18-2281	443	120-174	20-8959	51
100-305	27-7207	493	100-770	19-3208308S	472	102-305	19-11841	468	105-197	18-1282	444	120-178	20-8958	51
100-313	39-6988	486	100-770	19-12676	472	102-319	19-6583	476	105-205	18-2282	443	120-188	20-6000	46
100-317	19-8785	479	100-774	19-11505	471	102-335	19-5863	473	105-213	18-2284	444	120-188	20-16000	499
100-329	27-8239	487	100-780	19-9728	468	102-343	19-5934	473	105-239	18-1267	438	120-196	20-8678	510
100-339	39-6985	485	100-780	19-11865	468	102-350	19-2780	474	105-247	18-2291	442	120-200	20-8751	51
100-347	19-6567	463	100-784	19-6690	461	102-354	19-10313	465	105-254	18-859	440	120-204	20-7236	508
100-347	19-2803	463	100-784	19-6691	461	102-366	19-11205	464	105-262	18-2286	441	120-208	20-8958	51
100-351	19-6585	477	100-792	19-6688	461	102-370	19-11230	464	105-288	18-8003	440	120-212	20-5841	46
100-354	19-5861	463	100-796	27-7679	491	102-388	19-13383	475	105-296	18-8284	442	120-224	20-5842	46
100-362	19-7726	462	100-800	19-6604	453	102-392	19-13384	475	105-300	18-1277	439	120-228	20-9294	511
100-362	19-2805	461	100-808	39-9790	489	102-400	19-6553	479	105-300	18-859	440	120-253	20-8675	511
100-370	19-5955	478	100-812	19-9200	478	102-404	27-11659	493	105-304	18-7239	443	120-265	19-6680	484
100-374	19-6567	463	100-818	19-6693	461	102-412	27-13159	493	105-320	18-8002	440	120-279	20-1347	34
100-374	19-2803	463	100-818	19-6692	461	102-414	27-10963	493	105-346	18-6510	442	120-279	20-11271	511
100-378	19-7980	460	100-822	19-12797	466	102-418	19-6606	467	105-346	18-891	438	120-283	27-8529	498
100-392	27-8713	491	100-826	27-5864	486	102-426	19-10181	454	105-353	18-7867	440	120-295	27-7159	498
100-404	27-6966	485	100-826	39-6986	493	102-450	19-11473	478	105-361	18-8282	443	120-303	20-7998	496
100-412	19-2839	478	100-834	19-12080	452	102-491	19-6517	463	105-445	18-2290	443	120-307	20-11358	498
100-416	27-9066	485	100-842	19-5939	452	102-495	19-7746	480	105-501	18-1268	439	120-311	20-16000	499
100-420	19-2841	455	100-854	19-14648	477	102-499	19-14206	457	105-501	18-1272	34	120-311	20-6000	46
100-428	19-7042	462	100-859	27-8238	487	102-513	19-8966	470	105-501	18-9578	441	120-327	20-10484	512
100-432	19-7043	462	100-863	19-12289	469	102-525	19-6524	451	105-701	18-10272	441	120-345	19-7916	483
100-438	19-2838	456	100-867	19-6602	453	102-533	19-2789	455	105-705	18-14449	441	120-345	19-6677	483
100-446	19-8481	456	100-871	19-9591	454	102-541	19-2841	455	110-007	18-1286	34	120-345	19-5909	483
100-450	19-8330	480	100-875	19-7050	454	102-549	19-2838	456	110-015	18-1287	34	120-360	19-6681	483
100-453	19-6514	454	100-879	19-8480	455	102-561	27-12377	485	110-023	18-897	445	120-372	19-8631	484
100-465	19-8279	474	100-883	19-5940	478	102-565	27-10759	485	110-106	18-1284	444	120-380	19-7916	483
100-														

AFTERMARKET CROSS REFERENCE



Part No.	Rotary No.	Page No.	Part No.	Rotary No.	Page No.	Part No.	Rotary No.	Page No.	Part No.	Rotary No.	Page No.	Part No.	Rotary No.	Page No.
STENS			130-112	24 - 2504	591	130-575	24 - 7227	589	130651	24 - 5859	589	145-979	25 - 1313	603
120-724	20 - 2801	499	130-113	24 - 9385	597	130-595	24 - 2538	595	130667	24 - 6595	589	145-995	25 - 1304	603
120-724	20 - 1349	46	130-115	24 - 13362	595	130-595	24 - 7189	592	130667	24 - 2544	589	146-001	25 - 5810	603
120-724	20 - 11349	499	130-117	24 - 9993	593	130-631	24 - 2542	589	130671	24 - 2547	589	146-001	25 - 11737	602
120-738	19 - 12374	484	130-119	24 - 9872	594	130-639	24 - 2543	589	130671	24 - 2509	591	146-019	25 - 1300	603
120-746	20 - 16000	499	130-130	24 - 12064	596	130-639	24 - 2551	590	130966	24 - 2506	591	146-019	25 - 11738	602
120-746	20 - 6000	46	130-132	24 - 2553	596	130-639	24 - 2544	589	130966	24 - 2544	589	146-019	25 - 9340	603
120-746	20 - 12952	450	130-141	24 - 11305	594	130-643	24 - 5859	589	130978	24 - 2529	593	146-027	25 - 1301	603
120-750	20 - 11357	499	130-143	24 - 10991	597	130-663	24 - 6595	589	130978	24 - 2544	589	146-027	25 - 1308	603
120-750	20 - 1357	46	130-144	24 - 10994	597	130-663	24 - 2544	589	135-004	24 - 8775	599	146-027	25 - 11739	602
120-754	20 - 7998	496	130-146	24 - 5850	595	130-675	24 - 2509	591	135-008	24 - 8749	599	146-027	25 - 9341	603
120-810	20 - 9807	51	130-149	24 - 10992	597	130-675	24 - 2547	589	135-008	24 - 9161	599	146-035	25 - 9342	603
120-818	19 - 9380	484	130-153	24 - 2547	589	130-690	24 - 2537	595	135-012	24 - 1285	600	146-035	25 - 1302	603
120-858	20 - 13448	509	130-161	24 - 2536	594	130-690	24 - 2544	589	135-012	24 - 9161	599	146-035	25 - 11740	602
120-914	20 - 9147	497	130-161	24 - 7150	591	130-694	24 - 10427	596	135-012	24 - 8749	599	146-035	25 - 1309	603
120-970	19 - 12863	450	130-165	24 - 7231	589	130-706	24 - 1294	594	135-012	24 - 1290	600	146-043	25 - 9343	603
120-970	19 - 5909	483	130-170	24 - 14637	592	130-708	24 - 2523	594	135-012	24 - 2268	599	146-043	25 - 1303	603
120-970	19 - 7916	483	130-195	24 - 2544	589	130-712	24 - 7187	591	135-020	24 - 1296	599	146-043	25 - 1310	603
120-970	19 - 6677	483	130-195	24 - 6932	591	130-712	24 - 2536	594	135-038	24 - 1298	600	146-043	25 - 11741	602
120-990	19 - 6600	483	130-195	24 - 2542	589	130-716	24 - 8358	595	135-046	24 - 1290	600	146-050	25 - 1304	603
120-990	19 - 12864	450	130-211	24 - 1294	594	130-724	24 - 5852	595	135-046	24 - 9161	599	146-050	25 - 11742	602
125-005	20 - 1359	515	130-237	24 - 2510	591	130-724	24 - 5855	594	135-046	24 - 1285	600	146-050	25 - 9344	603
125-017	20 - 9652	516	130-241	24 - 11307	591	130-732	24 - 2531	593	135-053	24 - 10190	599	146-050	25 - 1311	603
125-033	20 - 2235	514	130-245	24 - 2516	594	130-732	24 - 1294	594	135-053	24 - 6710	599	146-068	25 - 1312	603
125-033	20 - 8000	513	130-245	24 - 7187	591	130-732	24 - 2544	589	135-061	24 - 8776	599	146-068	25 - 1305	603
125-039	20 - 7238	513	130-245	24 - 7150	591	130-736	24 - 10234	596	135-081	24 - 9161	599	146-068	25 - 9345	603
125-047	20 - 1350	514	130-252	24 - 2544	589	130-740	24 - 5857	596	135-081	24 - 1290	600	146-076	25 - 1313	603
125-051	20 - 8285	514	130-278	24 - 2539	595	130-752	24 - 9872	594	135-081	24 - 1285	600	146-084	25 - 1300	603
125-051	20 - 12056	514	130-278	24 - 7188	592	130-757	24 - 5851	596	135-095	24 - 10190	599	146-092	25 - 1301	603
125-054	20 - 2233	514	130-286	24 - 7191	589	130-765	24 - 5856	594	135-226	24 - 10865	599	146-092	25 - 1308	603
125-062	20 - 2232	514	130-286	24 - 7190	591	130-773	24 - 2544	589	140-012	25 - 2230	605	146-100	25 - 1309	603
125-066	20 - 9315	513	130-294	24 - 7149	591	130-773	24 - 2526	594	140-016	25 - 7723	604	146-100	25 - 1302	603
125-070	20 - 6593	512	130-302	24 - 2510	591	130-773	24 - 2542	589	140-020	25 - 7327	604	146-118	25 - 1303	603
125-078	20 - 3462	512	130-310	24 - 2512	591	130-773	24 - 6932	591	140-020	25 - 17327	604	146-118	25 - 1310	603
125-086	20 - 8899	516	130-328	24 - 2533	595	130-777	24 - 10706	594	140-042	25 - 7290	605	146-126	25 - 1304	603
125-094	20 - 7999	515	130-328	24 - 2513	591	130-781	24 - 2517	594	140-046	25 - 2239	605	146-126	25 - 1311	603
125-094	20 - 9048	516	130-328	24 - 5850	595	130-781	24 - 2544	589	140-046	25 - 1318	604	146-134	25 - 1305	603
125-096	20 - 7233	515	130-344	24 - 2544	589	130-785	24 - 7892	595	140-053	25 - 2234	605	146-134	25 - 1312	603
125-112	20 - 7172	515	130-344	24 - 2504	591	130-793	24 - 10188	596	140-053	25 - 11330	604	146-159	25 - 11744	602
125-120	20 - 12074	515	130-348	24 - 9593	596	130-799	24 - 2532	593	140-053	25 - 1330	604	146-159	25 - 1301	603
125-128	20 - 7932	517	130-351	24 - 2509	591	130-799	24 - 2529	593	140-061	25 - 6780	606	146-159	25 - 1308	603
125-179	20 - 8934	514	130-355	24 - 10187	596	130-799	24 - 1295	594	140-087	25 - 11330	604	146-159	25 - 9348	603
125-179	20 - 8000	513	130-359	24 - 5858	595	130-799	24 - 2544	589	140-087	25 - 1330	604	146-167	25 - 9349	603
125-179	20 - 2235	514	130-369	24 - 2544	589	130-801	24 - 8554	594	140-087	25 - 1330	604	146-167	25 - 11745	602
125-179	20 - 8935	514	130-369	24 - 2506	591	130-805	24 - 12064	596	140-087	25 - 11330	604	146-167	25 - 1309	603
125-195	20 - 7882	517	130-377	24 - 2544	589	130-807	24 - 1289	594	140-091	25 - 11330	604	146-167	25 - 1302	603
125-203	23 - 9811	584	130-377	24 - 2542	589	130-815	24 - 7190	591	140-091	25 - 1330	604	146-175	25 - 11746	602
125-211	23 - 2681	584	130-377	24 - 6932	591	130-815	24 - 10176	595	140-103	25 - 7723	604	146-175	25 - 9350	603
125-215	20 - 8737	517	130-385	24 - 5854	595	130-823	24 - 2539	595	140-129	25 - 7301	605	146-175	25 - 1303	603
125-219	20 - 7408	517	130-385	24 - 2507	591	130-823	24 - 7188	592	140-160	25 - 7290	605	146-175	25 - 1310	603
125-237	23 - 6783	586	130-385	24 - 2544	589	130-831	24 - 2501	595	140-160	25 - 12057	604	150-003	26 - 1325	626
125-245	20 - 6884	517	130-393	24 - 2544	589	130-831	24 - 7148	591	140-212	25 - 10275	604	150-027	26 - 860	608
125-260	20 - 6965	515	130-393	24 - 2530	593	130-835	24 - 11078	596	140-232	25 - 1330	604	150-029	26 - 1324	608
125-294	23 - 9778	585	130-393	24 - 5936	591	130-839	24 - 9871	596	140-232	25 - 11330	604	150-045	26 - 10983	626
125-302	23 - 9965	585	130-435	24 - 8054	592	130-843	24 - 14559	594	140-377	25 - 10871	605	150-045	26 - 1338	608
125-330	23 - 6866	585	130-443	24 - 2532	593	130-849	24 - 2519	595	145-516	25 - 4969	604	150-052	26 - 1339	608
125-334	23 - 8789	584	130-450	24 - 1295	594	130-853	24 - 10999	596	145-524	25 - 7307	604	150-060	26 - 852	608
125-336	20 - 7730	510	130-450	24 - 2544	589	130-856	24 - 8571	592	145-524	25 - 4968	604	150-094	26 - 875	608
125-364	20 - 9604	513	130-450	24 - 2529	593	130-856	24 - 10707	596	145-540	25 - 4968	604	150-102	26 - 2240	628
125-368	20 - 9603	513	130-454	24 - 2544	589	130-864	24 - 2500	594	145-600	25 - 1300	603	150-110	26 - 2957	628
125-436	20 - 10018	513	130-454	24 - 2542	589	130-864	24 - 2510	591	145-604	25 - 1308	603	150-114	26 - 9362	627
125-508	23 - 6783	586	130-468	24 - 2531	593	130-868	24 - 5858	595	145-604	25 - 1301	603	150-118	26 - 8498	627
125-560	20 - 10906	512	130-468	24 - 2517	594	130-872	24 - 2503	595	145-608	25 - 1309	603	150-128	26 - 2241	608
125-568	20 - 11016	512	130-468	24 - 2544	589	130-877	24 - 13373	595	145-608	25 - 1302	603	150-136	26 - 2959	608
125-660	20 - 6593	512	130-476	24 - 7148										



AFTERMARKET CROSS REFERENCE

Part No.	Rotary No.	Page No.	Part No.	Rotary No.	Page No.	Part No.	Rotary No.	Page No.	Part No.	Rotary No.	Page No.	Part No.	Rotary No.	Page No.
STENS			160-180	08 - 7827	118	165-035	08 - 829	119	165-504	08 - 7049	122	175-165	07 - 8299	106
150-703	26 - 12079	623	160-184	08 - 5894	121	165-035	08 - 8456	121	165-508	08 - 9966	120	175-166	08 - 3277	115
150-727	26 - 13582	625	160-188	08 - 7827	118	165-035	08 - 7022	121	165-512	08 - 10620	122	175-182	08 - 8197	111
150-747	26 - 12655	626	160-192	08 - 838	117	165-039	08 - 7700	121	165-520	08 - 11509	122	175-224	08 - 10892	114
150-775	26 - 13580	625	160-200	08 - 348	118	165-039	08 - 8920	122	165-524	08 - 11023	122	175-224	08 - 7285	114
150-787	26 - 13560	625	160-226	08 - 3275	118	165-039	08 - 346	122	165-552	08 - 10970	122	175-224	08 - 8278	114
150-795	26 - 13562	625	160-238	08 - 8084	121	165-043	08 - 8457	122	165-560	08 - 7033	122	175-236	08 - 8573	113
150-803	26 - 13561	625	160-238	08 - 7202	122	165-043	08 - 359	122	165-572	08 - 8920	122	175-305	07 - 5900	103
150-991	26 - 8286	609	160-242	08 - 8084	121	165-047	08 - 7031	122	165-580	08 - 12310	120	175-309	07 - 5899	103
150-995	26 - 876	608	160-242	08 - 7202	122	165-047	08 - 5891	118	165-624	08 - 9494	122	175-425	08 - 8551	111
155-002	26 - 1326	629	160-246	08 - 8542	118	165-050	08 - 8920	122	165-628	08 - 10289	122	175-500	08 - 8581	109
155-010	26 - 1327	629	160-246	08 - 347	118	165-050	08 - 346	122	165-632	08 - 10290	122	175-505	08 - 368	117
155-036	26 - 5876	629	160-246	08 - 5947	122	165-050	08 - 11141	122	165360	08 - 883	118	175-506	08 - 9898	109
155-044	26 - 1334	629	160-246	08 - 7028	122	165-050	08 - 7700	121	165360	08 - 7025	122	175-509	08 - 11062	110
155-069	26 - 1333	630	160-246	08 - 8082	122	165-054	08 - 8918	120	165360	08 - 5945	122	175-510	08 - 8494	109
155-077	26 - 2430	629	160-250	08 - 7694	122	165-058	08 - 7699	121	165376	08 - 3275	118	175-510	08 - 11217	110
155-085	26 - 1329	629	160-259	08 - 303	118	165-058	08 - 7201	122	165392	08 - 7031	122	175-513	08 - 364	117
155-127	26 - 2422	630	160-267	08 - 302	118	165-062	08 - 8688	121	165392	08 - 5891	118	175-549	08 - 9605	112
155-158	26 - 2421	630	160-275	08 - 7025	122	165-066	08 - 7699	121	165400	08 - 913	119	175-600	08 - 3276	112
155-162	26 - 2424	630	160-275	08 - 883	118	165-066	08 - 7201	122	165400	08 - 7033	122	175-600	08 - 8580	109
155-176	26 - 2463	630	160-275	08 - 5945	122	165-068	08 - 7026	121	170-001	08 - 352	123	175-600	08 - 8581	109
155-216	26 - 12914	633	160-283	08 - 903	121	165-068	08 - 830	119	170-001	08 - 3266	123	175-600	08 - 8098	108
155-240	26 - 8072	633	160-291	08 - 879	119	165-072	08 - 6832	121	170-005	08 - 353	123	175-606	08 - 8579	109
155-244	26 - 8071	633	160-303	08 - 8949	119	165-076	08 - 5948	120	170-005	08 - 3266	123	175-606	08 - 9898	109
155-300	26 - 9527	630	160-309	08 - 906	121	165-076	08 - 5894	121	170-005	08 - 352	123	175-606	08 - 8550	111
155-400	26 - 13051	633	160-313	08 - 906	121	165-080	08 - 362	118	170-019	08 - 353	123	175-610	08 - 8197	111
155-523	37 - 3026	633	160-317	08 - 8541	122	165-080	08 - 7029	122	170-019	08 - 3267	123	175-610	08 - 8494	109
155-531	37 - 3009	1180	160-317	08 - 6541	118	165-080	08 - 8083	122	170-023	08 - 3267	123	175-611	08 - 8553	108
155-549	37 - 3003	633	160-325	08 - 5916	120	165-084	08 - 7027	121	170-027	08 - 878	123	175-613	08 - 8866	109
155-556	37 - 3010	633	160-325	08 - 7328	118	165-084	08 - 5947	122	170-035	08 - 354	123	175-619	08 - 8867	109
155-572	26 - 2445	633	160-325	08 - 341	118	165-084	08 - 833	119	170-043	08 - 360	123	175-619	08 - 8865	109
155-580	26 - 2444	633	160-369	08 - 362	118	165-092	08 - 347	118	170-050	08 - 7811	123	175-625	08 - 8264	108
155-584	26 - 8069	633	160-369	08 - 8083	122	165-092	08 - 7028	122	170-054	08 - 357	123	175-629	08 - 9809	110
155-725	26 - 5876	629	160-369	08 - 7029	122	165-092	08 - 5947	122	170-068	08 - 355	124	175-629	08 - 10288	110
155-747	26 - 2436	634	160-801	08 - 10098	119	165-092	08 - 8542	118	170-076	08 - 7146	124	175-633	08 - 10286	110
160-002	08 - 341	118	160-805	08 - 10430	119	165-092	08 - 8082	122	170-076	08 - 358	124	175-681	08 - 9573	113
160-002	08 - 5916	120	160-901	08 - 3275	118	165-096	08 - 7696	122	170-084	08 - 898	124	175-709	08 - 9573	113
160-002	08 - 7328	118	160-905	08 - 8083	122	165-100	08 - 348	118	170-084	08 - 7261	124	175-713	08 - 8684	114
160-006	08 - 7695	122	160-905	08 - 7029	122	165-100	08 - 7695	122	170-084	08 - 7260	124	175-717	08 - 7982	115
160-010	08 - 349	119	160-905	08 - 362	118	165-100	08 - 7030	122	170-092	08 - 899	124	175-717	08 - 11063	110
160-014	08 - 7328	118	160-917	08 - 913	119	165-104	08 - 8896	121	170-100	08 - 7828	124	175-721	08 - 10075	111
160-014	08 - 5916	120	160-917	08 - 7033	122	165-108	08 - 3275	118	170-100	08 - 7147	124	175-725	08 - 10461	111
160-014	08 - 341	118	160-921	08 - 921	119	165-116	08 - 8456	121	170-118	08 - 3265	125	175-725	08 - 8551	111
160-028	08 - 5917	120	160-933	08 - 8083	122	165-116	08 - 829	119	170-126	08 - 10959	125	175-729	08 - 9804	108
160-028	08 - 342	118	160-933	08 - 7029	122	165-116	08 - 7022	121	170-126	08 - 3264	125	175-733	08 - 8580	109
160-036	08 - 350	119	160-933	08 - 362	118	165-122	08 - 8915	120	170-130	08 - 904	123	180-212	41 - 5552	1227
160-044	08 - 343	118	162-001	08 - 883	118	165-126	08 - 7031	122	170-130	08 - 9618	123	180-216	41 - 5550	1227
160-044	08 - 5918	120	162-001	08 - 7025	122	165-126	08 - 5891	118	170-134	08 - 7145	124	180-224	41 - 5553	1227
160-051	08 - 351	119	162-001	08 - 5945	122	165-130	08 - 359	122	170-138	08 - 9620	123	180-228	41 - 5551	1227
160-069	08 - 359	122	162-005	08 - 8542	118	165-130	08 - 8457	122	170-142	08 - 900	124	180-240	41 - 5554	1227
160-069	08 - 8457	122	162-005	08 - 5947	122	165-134	08 - 921	119	170-159	08 - 305	125	180-244	41 - 5559	1227
160-077	08 - 7022	121	162-005	08 - 7028	122	165-138	08 - 8541	122	170-159	08 - 6953	125	180-248	41 - 5557	1227
160-077	08 - 829	119	162-005	08 - 8082	122	165-138	08 - 6541	118	170-167	08 - 6954	125	180-256	41 - 5558	1227
160-077	08 - 8456	121	162-005	08 - 347	118	165-142	08 - 9154	121	170-167	08 - 304	125	180-268	41 - 5556	1227
160-081	08 - 7023	121	162-009	08 - 8541	122	165-150	08 - 7695	122	170-167	08 - 6953	125	180-272	41 - 5561	1227
160-085	08 - 830	119	162-009	08 - 6541	118	165-150	08 - 7030	122	170-175	08 - 7143	123	180-332	41 - 5574	1227
160-085	08 - 7026	121	162-013	08 - 3275	118	165-150	08 - 348	118	170-175	08 - 884	123	180-404	41 - 5564	1227
160-085	08 - 10098	119	162-017	08 - 913	119	165-159	08 - 7033	122	170-183	08 - 8694	123	180-408	41 - 5565	1227
160-093	08 - 8920	122	162-017	08 - 7033	122	165-159	08 - 913	119	170-183	08 - 3268	123	180-416	41 - 5560	1227
160-093	08 - 346	122	162-021	08 - 8687	121	165-163	08 - 5916	120	170-183	08 - 880	123	180100	41 - 5552	1227
160-093	08 - 7700	121	162-025	08 - 7029	122	165-167	08 - 8687	121	170-215	08 - 10429	125	180104	41 - 5550	1227
160-093	08 - 10756	118	162-025	08 - 362	118	165-171	08 - 5917	120	170-225	08 - 3268	123	180108	41 - 5553	1227
160-097	08 - 6594	118	162-025	08 - 8083	122	165-191	08 - 8007	120	170-225	08 - 880	123	180112	41 - 5551	1227
160-101	08 - 344	118	162-029	08 - 7030	122	165-203	08 - 8082	122	175-000	08 - 371	116	180116	41 - 5554	1227
160-109	08 - 9711	120	162-029	08 - 7695	122	165-211	08 - 7025	122	175-004	08 - 8278</				

AFTERMARKET CROSS REFERENCE



Part No.	Rotary No.	Page No.	Part No.	Rotary No.	Page No.	Part No.	Rotary No.	Page No.	Part No.	Rotary No.	Page No.	Part No.	Rotary No.	Page No.
STENS			215-012	09 - 324	39	225-746	09 - 13467	136	235-051	10 - 316	39	240-309	05 - 2958	89
200-030	06 - 3240	100	215-020	09 - 8351	131	225-750	09 - 7720	144	235-069	10 - 319	39	240-325	05 - 345	92
205-005	07 - 8928	102	215-020	09 - 325	39	225-754	09 - 13468	136	235-069	10 - 317	39	240-341	05 - 3271	89
205-005	07 - 2991	102	215-038	09 - 326	39	225-763	09 - 8783	145	235-077	10 - 318	39	240-366	42 - 7158	1231
205-013	07 - 2992	102	215-038	09 - 7950	131	225-797	09 - 2940	147	235-085	10 - 319	39	240-374	05 - 3245	94
205-013	07 - 8927	102	215-046	09 - 6573	133	225-839	09 - 8446	147	235-093	10 - 320	39	240-382	05 - 3246	94
205-021	07 - 2990	102	215-046	09 - 328	133	225-854	09 - 8445	146	235-101	10 - 2964	180	240-394	05 - 300	92
205-025	06 - 6709	99	215-046	09 - 327	39	225-862	09 - 8796	147	235-119	10 - 10310	179	240-398	29 - 8192	666
205-029	06 - 8263	99	215-053	09 - 3228	131	225-900	09 - 8476	148	235-119	10 - 310	179	240-416	10 - 2219	161
205-039	06 - 272	99	215-061	09 - 326	39	225-900	09 - 5707	147	235-127	10 - 321	39	240-432	05 - 7920	89
205-039	06 - 2985	99	215-061	09 - 7950	131	225-904	09 - 8995	139	235-151	10 - 8447	178	240-440	05 - 6880	93
205-047	06 - 9875	99	215-079	09 - 328	133	225-987	09 - 6863	147	235-155	10 - 8419	180	240-452	10 - 8295	162
205-047	06 - 271	99	215-079	09 - 327	39	225-995	09 - 6864	148	235-200	10 - 11142	179	240-473	05 - 3227	88
205-054	06 - 2986	99	215-079	09 - 6573	133	230-003	09 - 18199	131	235-680	10 - 5708	180	240-507	29 - 8406	666
205-062	06 - 286	99	215-087	09 - 813	133	230-003	09 - 8198	131	238-020	12 - 5003	211	240-564	05 - 8309	88
205-062	07 - 2990	102	215-100	09 - 12856	145	230-003	09 - 8831	132	238-021	12 - 5004	211	240-614	29 - 450	666
205-070	06 - 2965	97	215-145	09 - 339	146	230-003	09 - 481	131	238-022	12 - 5005	211	240-630	05 - 5952	94
205-088	06 - 2980	97	215-160	09 - 329	39	230-003	09 - 8199	131	238-023	12 - 5006	211	240-648	05 - 5951	94
205-088	06 - 2989	97	215-178	09 - 330	39	230-011	09 - 7917	132	238-024	12 - 7429	214	240-671	05 - 6930	92
205-088	06 - 2966	97	215-186	09 - 331	39	230-011	09 - 483	132	238-024	12 - 5007	211	240-675	05 - 8603	92
205-096	06 - 2989	97	215-194	09 - 332	39	230-011	09 - 8861	132	238-024	12 - 669	240	240-680	05 - 8207	89
205-096	06 - 2980	97	215-202	09 - 481	131	230-011	09 - 8507	132	238-025	12 - 7430	214	240-713	05 - 12477	92
205-096	06 - 2966	97	215-202	09 - 18199	131	230-015	09 - 483	132	238-025	12 - 5008	211	240-717	05 - 13372	92
205-104	07 - 855	102	215-202	09 - 8831	132	230-015	09 - 8861	132	238-026	12 - 7431	214	240-733	29 - 8501	667
205-104	07 - 8929	102	215-202	09 - 8199	131	230-019	09 - 8198	131	238-026	12 - 5009	211	240-770	11 - 8472	94
205-112	06 - 2998	97	215-210	09 - 328	133	230-019	09 - 8831	132	238-027	12 - 5010	211	240-790	05 - 13371	92
205-120	06 - 2999	98	215-210	09 - 327	39	230-023	09 - 13092	136	238-027	12 - 7432	214	240-804	29 - 8407	666
205-138	06 - 279	97	215-210	09 - 6573	133	230-023	08 - 12913	114	238-028	12 - 5011	211	240-860	42 - 8250	1231
205-146	06 - 2983	98	215-228	09 - 8971	136	230-029	09 - 442	134	238-028	12 - 7433	214	240-888	42 - 9579	1231
205-153	06 - 2965	97	215-236	09 - 5848	138	230-033	09 - 484	133	238-028	12 - 8819	260	240-888	42 - 14184	931
205-161	06 - 2980	97	215-251	09 - 9011	138	230-037	09 - 484	133	238-029	12 - 5012	211	240-975	05 - 10169	92
205-161	06 - 2966	97	215-267	09 - 7869	133	230-045	09 - 487	133	238-029	12 - 7434	214	240-991	41 - 5612	1223
205-161	06 - 2989	97	215-269	09 - 9041	138	230-052	09 - 6535	133	238-030	12 - 5013	211	241-008	42 - 14177	1232
205-179	06 - 2966	97	215-277	09 - 8525	131	230-056	09 - 8077	132	238-030	12 - 7435	214	241-200	10 - 9972	159
205-179	06 - 2980	97	215-285	09 - 814	134	230-060	09 - 7917	132	238-031	12 - 7436	214	241-200	10 - 13664	159
205-179	06 - 2989	97	215-301	09 - 9044	145	230-060	09 - 8507	132	238-031	12 - 5014	211	245-001	10 - 2208	174
205-187	06 - 2984	98	215-305	09 - 7716	147	230-060	09 - 7210	132	238-032	12 - 7437	214	245-005	10 - 13457	174
205-211	06 - 2977	97	215-350	09 - 10015	135	230-060	09 - 6513	133	238-032	12 - 5015	211	245-013	10 - 9159	174
205-229	06 - 2976	97	215-370	09 - 326	39	230-076	09 - 8199	131	238-033	12 - 5016	211	245-019	10 - 2209	174
205-237	06 - 6675	100	215-370	09 - 7950	131	230-076	09 - 18199	131	238-033	12 - 8429	221	245-027	10 - 11031	174
205-268	07 - 13491	102	215-400	09 - 12857	146	230-076	09 - 8198	131	238-033	12 - 7438	214	245-027	10 - 2210	174
205-272	07 - 13492	102	215-565	09 - 3305	146	230-076	09 - 8831	132	238-034	12 - 5017	211	245-035	10 - 2211	174
205-350	07 - 9156	102	215-8050	13 - 7852	38	230-076	09 - 481	131	238-034	12 - 7439	214	245-043	10 - 2212	174
205-374	07 - 10758	103	215-8090	13 - 7851	38	230-078	10 - 3309	182	238-035	12 - 7440	214	245-050	10 - 2213	173
210-013	06 - 5873	100	225-029	09 - 7258	146	230-082	09 - 8994	139	238-035	12 - 8820	260	245-054	10 - 9307	173
210-017	06 - 5874	98	225-045	09 - 293	144	230-086	09 - 7178	134	238-035	12 - 5018	211	245-068	10 - 2214	173
210-029	07 - 12245	107	225-052	09 - 367	137	230-086	09 - 3217	134	238-036	12 - 8426	221	245-076	10 - 2215	173
210-033	07 - 10225	107	225-076	09 - 7839	143	230-090	09 - 3217	134	238-036	12 - 5019	211	245-084	10 - 2216	173
210-037	07 - 12015	104	225-078	09 - 2935	146	230-090	09 - 7178	134	238-036	12 - 7441	214	248-018	12 - 5051	212
210-047	07 - 6915	105	225-086	09 - 2936	145	230-102	09 - 7162	134	238-037	12 - 5020	211	248-019	12 - 8761	232
210-051	07 - 11819	104	225-110	09 - 3201	144	230-102	09 - 10303	135	238-037	12 - 7442	214	248-019	12 - 5052	212
210-054	07 - 6918	104	225-128	09 - 3202	144	230-106	09 - 3229	130	238-038	12 - 5021	211	248-020	12 - 5053	212
210-054	07 - 3320	106	225-144	09 - 3211	146	230-128	09 - 6573	133	238-038	12 - 7443	214	248-021	12 - 5054	212
210-062	07 - 6919	103	225-163	09 - 9746	145	230-128	09 - 327	39	238-039	12 - 9901	235	248-022	12 - 10822	241
210-088	07 - 6909	107	225-164	09 - 3222	146	230-128	09 - 328	133	238-039	12 - 5022	211	248-022	12 - 5055	212
210-100	07 - 13000	107	225-169	09 - 7720	144	230-144	09 - 3228	131	238-039	12 - 7444	214	248-023	12 - 7466	215
210-108	07 - 8300	106	225-205	09 - 8586	141	230-185	09 - 3274	134	238-040	12 - 7445	214	248-023	12 - 5056	212
210-112	06 - 273	96	225-205	10 - 10007	181	230-201	09 - 8437	132	238-040	12 - 5023	211	248-024	12 - 8780	232
210-116	07 - 8311	106	225-217	09 - 8488	135	230-225	09 - 10064	142	238-041	12 - 5024	211	248-024	12 - 7467	215
210-120	07 - 8310	106	225-219	09 - 853	143	230-233	09 - 12119	136	238-041	12 - 7446	214	248-024	12 - 5057	212
210-124	07 - 3320	106	225-227	09 - 854	145	230-237	09 - 9002	140	238-042	12 - 7447	214	248-025	12 - 7468	215
210-124	07 - 8298	107	225-235	09 - 3200	146	230-237	09 - 6534	135	238-042	12 - 5025	211	248-025	12 - 5058	212
210-128	07 - 12999	107	225-243	09 - 1264	131	230-237	09 - 8440	140	238-043	12 - 5026	211	248-026	12 - 5059	212
210-132	07 - 10715	103	225-268	09 - 1266	131	230-241	09 - 325	39	238-043	12 - 7448	214	248-026	12 - 7469	215
210-138	07 - 8298	107	225-276	09 - 8654	144	230-241	09 - 8351	131	238-044	12 - 5027	211	248-027	12 - 4999	240



AFTERMARKET CROSS REFERENCE

2014 AFTERMARKET REF.

Part No.	Rotary No.	Page No.	Part No.	Rotary No.	Page No.	Part No.	Rotary No.	Page No.	Part No.	Rotary No.	Page No.	Part No.	Rotary No.	Page No.
STENS			248-070	12-7513	215	248-101	12-7544	215	255-359	10-12309	164	258-052	12-8092	246
248-036	12-8811	242	248-071	12-7514	215	248-101	12-6629	212	255-363	10-12980	164	258-052	12-7597	216
248-037	12-7480	215	248-071	12-5104	212	248-102	12-6630	212	255-375	10-11825	167	258-053	12-7789	254
248-037	12-8428	221	248-072	12-5105	212	248-102	12-7545	215	255-387	10-11858	167	258-053	12-7598	216
248-037	12-5070	212	248-072	12-7515	215	248-102	12-8442	238	255-407	12-10042	239	258-053	12-6839	233
248-038	12-7481	215	248-073	12-5106	212	248-103	12-12051	228	255-419	10-12228	165	258-053	12-5180	213
248-038	12-5071	212	248-073	12-7516	215	248-103	12-7129	240	255-431	10-13973	165	258-054	12-7599	216
248-039	12-7482	215	248-074	12-6841	233	248-103	12-6631	212	255-435	10-11073	166	258-054	12-5181	213
248-039	12-5072	212	248-074	12-5107	212	248-103	12-7546	215	255-435	10-14045	166	258-055	12-7600	216
248-040	12-5073	212	248-074	12-7517	215	248-103	12-7171	241	255-463	10-11075	167	258-055	12-5182	213
248-040	12-6503	237	248-075	12-5108	212	248-104	12-6632	212	255-475	10-12247	165	258-056	12-5183	213
248-040	12-7483	215	248-075	12-7518	215	248-104	12-6837	258	255-511	10-9911	164	258-056	12-7601	216
248-040	12-7791	254	248-076	12-5109	212	248-104	12-7547	215	255-515	10-9912	164	258-057	12-5184	213
248-041	12-5074	212	248-076	12-7519	215	248-105	12-7548	215	255-519	10-9913	164	258-057	12-7602	216
248-041	12-7484	215	248-077	12-5110	212	248-105	12-6633	212	255-527	10-12977	167	258-058	12-5185	213
248-042	12-5075	212	248-077	12-7520	215	248-106	12-6634	212	255-535	10-11444	167	258-058	12-7603	216
248-042	12-7485	215	248-078	12-7521	215	248-106	12-7549	215	255-539	10-11828	169	258-059	12-5186	213
248-043	12-7486	215	248-078	12-8463	222	248-107	12-6635	212	255-543	10-11829	169	258-059	12-7604	216
248-043	12-5076	212	248-078	12-5111	212	248-107	12-7550	215	255-547	10-12227	165	258-059	12-10914	255
248-044	12-7487	215	248-079	12-6901	222	248-108	12-6636	212	255-551	10-11237	167	258-060	12-5187	213
248-044	12-5077	212	248-079	12-5112	212	248-108	12-7551	215	255-555	10-11133	167	258-060	12-7605	216
248-045	12-7488	215	248-079	12-6843	233	248-109	12-7552	215	255-559	10-12261	168	258-061	12-5188	213
248-045	12-5078	212	248-079	12-7522	215	248-109	12-6637	212	255-627	10-14009	164	258-061	12-7606	216
248-046	12-5079	212	248-080	12-7523	215	248-110	12-6638	212	255-659	10-11445	169	258-062	12-5189	213
248-046	12-7489	215	248-080	12-8443	238	248-110	12-7553	215	255-739	32-4252	1103	258-062	12-7607	216
248-047	12-7490	215	248-080	12-5113	212	248-111	12-6639	212	255-895	10-12114	168	258-063	12-5190	213
248-047	12-8444	238	248-080	12-6900	222	248-111	12-7554	215	255383	12-11867	224	258-063	12-7608	216
248-047	12-8798	260	248-081	12-5114	212	248-112	12-6640	212	258-026	12-5153	213	258-064	12-8731	248
248-047	12-5080	212	248-081	12-7524	215	248-112	12-7555	215	258-026	12-7571	216	258-064	12-5191	213
248-047	12-5820	241	248-082	12-5115	212	248-113	12-6641	212	258-027	12-5154	213	258-064	12-6844	233
248-048	12-7491	215	248-082	12-7525	215	248-113	12-7556	215	258-027	12-7572	216	258-064	12-7609	216
248-048	12-5081	212	248-082	12-4998	237	248-114	12-6642	212	258-028	12-5155	213	258-065	12-5192	213
248-049	12-7492	215	248-082	12-6896	240	248-114	12-7557	215	258-028	12-7573	216	258-065	12-7610	216
248-049	12-5082	212	248-083	12-5116	212	248-117	12-9900	235	258-029	12-5156	213	258-066	12-5193	213
248-050	12-5231	258	248-083	12-6509	238	250-001	11-384	203	258-029	12-7574	216	258-066	12-7611	216
248-050	12-5083	212	248-083	12-7526	215	250-005	11-383	203	258-030	12-5157	213	258-067	12-7612	216
248-050	12-5237	242	248-084	12-8781	223	250-019	11-385	203	258-030	12-7575	216	258-067	12-5194	213
248-050	12-7493	215	248-084	12-5117	212	250-027	11-2905	203	258-031	12-7576	216	258-068	12-5195	213
248-051	12-5235	254	248-084	12-7527	215	250-027	11-386	203	258-031	12-5158	213	258-068	12-8809	242
248-051	12-5084	212	248-085	12-5118	212	250-035	11-388	203	258-032	12-5159	213	258-068	12-7613	216
248-051	12-7494	215	248-085	12-6838	233	250-043	11-389	203	258-032	12-7577	216	258-069	12-6842	236
248-052	12-7495	215	248-085	12-7528	215	250-050	11-390	203	258-033	12-7578	216	258-069	12-7614	216
248-052	12-5085	212	248-086	12-7529	215	250-068	11-2905	203	258-033	12-5160	213	258-069	12-5196	213
248-052	12-7169	233	248-086	12-5119	212	250-080	12-399	203	258-034	12-5161	213	258-070	12-7615	216
248-053	12-7496	215	248-086	12-6904	238	250-084	11-400	49	258-034	12-7579	216	258-070	12-5197	213
248-053	12-5086	212	248-087	12-5120	212	250-092	11-401	49	258-035	12-6906	233	258-071	12-5198	213
248-053	12-8711	250	248-087	12-7530	215	250-100	11-402	49	258-035	12-7580	216	258-071	12-6972	258
248-054	12-8810	242	248-088	12-8516	223	250-118	11-404	49	258-035	12-5162	213	258-071	12-7616	216
248-054	12-7497	215	248-088	12-6502	237	250-126	11-405	203	258-036	12-7581	216	258-072	12-7617	216
248-054	12-6507	238	248-088	12-7531	215	250-134	11-406	203	258-036	12-5163	213	258-072	12-5199	213
248-054	12-5087	212	248-088	12-8972	238	250-138	11-411	203	258-037	12-5164	213	258-073	12-7618	216
248-055	12-5088	212	248-088	12-7184	222	250-142	11-412	49	258-037	12-7582	216	258-073	12-5200	213
248-055	12-7498	215	248-088	12-5121	212	250-159	11-413	49	258-038	12-6907	235	258-074	12-6845	235
248-055	12-6876	237	248-089	12-7532	215	250-167	11-414	49	258-038	12-7583	216	258-074	12-6872	240
248-056	12-5089	212	248-089	12-5122	212	250-175	11-416	49	258-038	12-5165	213	258-074	12-7619	216
248-056	12-7499	215	248-090	12-7533	215	250-183	11-417	203	258-039	12-5166	213	258-074	12-5201	213
248-057	12-5090	212	248-090	12-6505	237	250-191	11-418	203	258-039	12-7584	216	258-075	12-8767	257
248-057	12-7500	215	248-090	12-6902	222	250-223	11-392	203	258-040	12-7585	216	258-075	12-5202	213
248-058	12-5091	212	248-090	12-6898	240	250-227	11-420	49	258-040	12-5238	242	258-075	12-7620	216
248-058	12-7501	215	248-090	12-5123	212	250-231	11-408	49	258-040	12-5167	213	258-076	12-5203	213
248-059	12-5092	212	248-091	12-7534	215	250-266	11-394	203	258-041	12-5168	213	258-076	12-7621	216
248-059	12-7502	215	248-091	12-5124	212	250-274	11-395	203	258-041	12-7586	216	258-077	12-5204	213
248-060	12-9119	234	248-091	12-7673	238	255-000	04-456	81	258-042	12-7587	216	258-077	12-7622	216
248-060	12-7503	215	248-092	12-7535	215	255-018	04-455	81	258-042	12-5169	213	258-078	12-7623	216
248-060	12-5093	212	248-092	12-5125	212	255-075	04-864	81	258-043	12-5170	213	258-078	12-8509	245
248-061	12-5094	212	248-092	12-8511	222	255-109	04-456	81	258-043	12-7588	216	258-078	12-5205	213
248-061	12-7504													

AFTERMARKET CROSS REFERENCE



Part No.	Rotary No.	Page No.	Part No.	Rotary No.	Page No.	Part No.	Rotary No.	Page No.	Part No.	Rotary No.	Page No.	Part No.	Rotary No.	Page No.
STENS			265-009	12 - 6898	240	265-108	12 - 8092	246	265-207	12 - 7532	215	265-346	12 - 5124	212
258-088	12 - 8805	246	265-009	12 - 5123	212	265-110	12 - 10388	230	265-208	12 - 9368	223	265-348	12 - 5073	212
258-088	12 - 5215	213	265-009	12 - 6902	222	265-112	12 - 5090	212	265-211	12 - 12382	235	265-348	12 - 7791	254
258-088	12 - 7633	216	265-013	12 - 6950	233	265-112	12 - 7500	215	265-212	12 - 12768	227	265-348	12 - 6503	237
258-089	12 - 5216	213	265-014	12 - 10751	231	265-116	12 - 5201	213	265-213	12 - 12770	234	265-356	12 - 5071	212
258-089	12 - 5867	246	265-014	12 - 6630	212	265-116	12 - 7619	216	265-214	12 - 11867	224	265-360	12 - 6649	213
258-089	12 - 7634	216	265-015	12 - 7637	216	265-116	12 - 6845	235	265-215	12 - 5235	254	265-360	12 - 7652	216
258-090	12 - 5823	242	265-015	12 - 5219	213	265-116	12 - 6872	240	265-216	12 - 12790	234	265-361	12 - 14117	225
258-090	12 - 5217	213	265-016	12 - 7544	215	265-120	12 - 8760	250	265-217	12 - 11034	224	265-363	12 - 670	240
258-090	12 - 7635	216	265-016	12 - 6629	212	265-120	12 - 5071	212	265-218	12 - 11863	224	265-367	12 - 5214	213
258-091	12 - 5218	213	265-017	12 - 6504	237	265-122	12 - 10815	244	265-219	12 - 12791	234	265-367	12 - 7632	216
258-091	12 - 7636	216	265-017	12 - 7505	215	265-123	12 - 10031	243	265-220	12 - 11864	224	265-371	12 - 5064	212
258-092	12 - 5219	213	265-017	12 - 5095	212	265-124	12 - 7128	240	265-226	12 - 11846	227	265-375	12 - 8714	255
258-092	12 - 7637	216	265-018	12 - 10886	247	265-124	12 - 8509	245	265-227	12 - 14130	259	265-379	12 - 12760	232
258-093	12 - 5220	213	265-020	12 - 10100	236	265-124	12 - 7623	216	265-228	12 - 11849	227	265-383	12 - 10407	255
258-093	12 - 7638	216	265-022	12 - 9712	238	265-124	12 - 5205	213	265-230	12 - 11844	227	265-387	12 - 7790	254
258-094	12 - 7639	216	265-024	12 - 9715	239	265-125	12 - 10010	244	265-232	12 - 13118	251	265-387	12 - 5823	242
258-094	12 - 5221	213	265-025	12 - 6509	238	265-126	12 - 10023	243	265-232	12 - 13117	257	265-387	12 - 5217	213
258-094	12 - 8370	246	265-025	12 - 5116	212	265-129	12 - 10027	243	265-234	12 - 11850	227	265-387	12 - 7635	216
258-095	12 - 7640	216	265-025	12 - 7526	215	265-130	12 - 10036	244	265-237	12 - 10435	230	265-389	12 - 7627	216
258-095	12 - 5222	213	265-026	12 - 9995	238	265-131	12 - 10029	243	265-239	12 - 11026	254	265-389	12 - 8803	242
258-096	12 - 7641	216	265-027	12 - 9713	239	265-133	12 - 10035	243	265-240	12 - 11027	254	265-389	12 - 5209	213
258-096	12 - 5223	213	265-028	12 - 9714	239	265-134	12 - 9016	247	265-242	12 - 12078	231	265-389	12 - 6970	240
258-097	12 - 7642	216	265-029	12 - 7894	260	265-135	12 - 9862	247	265-243	12 - 5163	213	265-389	12 - 5236	254
258-097	12 - 5224	213	265-030	12 - 9313	239	265-136	12 - 5112	212	265-243	12 - 7581	216	265-389	12 - 8091	246
258-098	12 - 7643	216	265-031	12 - 8972	238	265-136	12 - 7522	215	265-243	12 - 5242	242	265-393	12 - 8464	223
258-098	12 - 5225	213	265-033	12 - 5088	212	265-136	12 - 8463	222	265-244	12 - 12559	232	265-401	12 - 7500	215
258-099	12 - 7644	216	265-033	12 - 6876	237	265-136	12 - 6901	222	265-245	12 - 13567	233	265-401	12 - 10402	255
258-099	12 - 5226	213	265-033	12 - 7498	215	265-137	12 - 9014	247	265-246	12 - 11843	227	265-401	12 - 5090	212
258-100	12 - 5227	213	265-037	12 - 6896	240	265-138	12 - 10041	248	265-247	12 - 8805	246	265-405	12 - 7552	215
258-100	12 - 7645	216	265-037	12 - 5115	212	265-139	12 - 10257	247	265-247	12 - 5215	213	265-405	12 - 6637	212
258-101	12 - 6643	213	265-037	12 - 10830	226	265-140	12 - 7509	215	265-247	12 - 7633	216	265-413	12 - 5014	211
258-101	12 - 7646	216	265-037	12 - 7525	215	265-140	12 - 5821	241	265-249	12 - 14118	234	265-413	12 - 7436	214
258-102	12 - 6644	213	265-039	12 - 9768	223	265-140	12 - 5099	212	265-251	12 - 5116	212	265-415	12 - 12708	228
258-102	12 - 7647	216	265-045	12 - 7439	214	265-141	12 - 9863	248	265-251	12 - 6509	238	265-417	12 - 5820	241
258-103	12 - 6645	213	265-045	12 - 5017	211	265-142	12 - 10317	255	265-251	12 - 7526	215	265-417	12 - 8444	238
258-103	12 - 7648	216	265-049	12 - 5121	212	265-142	12 - 12233	255	265-252	12 - 13232	233	265-417	12 - 7490	215
258-104	12 - 7649	216	265-049	12 - 7531	215	265-145	12 - 10411	255	265-255	12 - 5131	212	265-417	12 - 5080	212
258-104	12 - 6646	213	265-049	12 - 6502	237	265-146	12 - 10044	255	265-255	12 - 8462	222	265-421	12 - 5008	211
258-105	12 - 6647	213	265-049	12 - 8516	223	265-147	12 - 10043	255	265-255	12 - 7541	215	265-421	12 - 669	240
258-105	12 - 7650	216	265-049	12 - 8972	238	265-150	12 - 9767	223	265-257	12 - 9480	236	265-421	12 - 7430	214
258-106	12 - 7651	216	265-050	12 - 5119	212	265-152	12 - 5126	212	265-259	12 - 5116	212	265-425	12 - 5016	211
258-106	12 - 6648	213	265-050	12 - 9994	238	265-152	12 - 8511	222	265-259	12 - 8464	223	265-425	12 - 7438	214
258-107	12 - 6649	213	265-050	12 - 7529	215	265-152	12 - 7536	215	265-259	12 - 7526	215	265-429	12 - 10744	249
258-107	12 - 7652	216	265-051	12 - 5122	212	265-153	12 - 10009	235	265-263	12 - 5132	212	265-433	12 - 10089	233
258-108	12 - 6650	213	265-051	12 - 7532	215	265-156	12 - 5055	212	265-263	12 - 6903	237	265-433	12 - 5068	212
258-108	12 - 7653	216	265-053	12 - 6843	233	265-156	12 - 10821	241	265-263	12 - 7542	215	265-433	12 - 7478	215
258-109	12 - 6651	213	265-053	12 - 7522	215	265-159	12 - 10051	258	265-263	12 - 8465	222	265-437	12 - 5016	211
258-109	12 - 7654	216	265-053	12 - 5112	212	265-160	12 - 10822	241	265-264	12 - 11661	237	265-437	12 - 7438	214
258-110	12 - 8768	257	265-053	12 - 9767	223	265-160	12 - 5055	212	265-265	12 - 7473	215	265-443	12 - 5179	213
258-110	12 - 6652	213	265-053	12 - 6901	222	265-162	12 - 14165	245	265-265	12 - 7245	238	265-443	12 - 7597	216
258-110	12 - 7655	216	265-054	12 - 14365	241	265-163	12 - 12426	245	265-265	12 - 5063	212	265-447	12 - 5198	213
258-111	12 - 9014	247	265-057	12 - 5124	212	265-164	12 - 14167	246	265-272	12 - 673	240	265-447	12 - 7616	216
258-111	12 - 7656	216	265-057	12 - 6505	237	265-165	12 - 7629	216	265-273	12 - 14042	241	265-447	12 - 6972	258
258-111	12 - 6653	213	265-057	12 - 11861	224	265-165	12 - 5211	213	265-276	12 - 8972	238	265-451	12 - 5223	213
258-112	12 - 7657	216	265-057	12 - 7534	215	265-167	12 - 10365	256	265-276	12 - 8516	223	265-451	12 - 7641	216
258-112	12 - 6654	213	265-058	12 - 7521	215	265-168	12 - 12371	256	265-276	12 - 6502	237	265-458	12 - 9257	246
258-113	12 - 7658	216	265-058	12 - 5111	212	265-169	12 - 7629	216	265-280	12 - 5127	212	265-459	12 - 13108	246
258-113	12 - 6655	213	265-058	12 - 8463	222	265-169	12 - 5211	213	265-280	12 - 7537	215	265-460	12 - 13110	246
258-114	12 - 6656	213	265-060	12 - 12237	245	265-170	12 - 14217	246	265-280	12 - 9945	222	265-461	12 - 13109	246
260-000	04 - 5600	82	265-062	12 - 5077	212	265-172	12 - 11019	236	265-302	12 - 14243	230	265-466	12 - 5197	213
260-018	04 - 5601	82	265-066	12 - 9570	233	265-173	12 - 5233	257	265-306	12 - 8784	222	265-466	12 - 7615	216
260-026	04 - 5602	82	265-066	12 - 7451	214	265-173	12 - 7589	216	265-306	12 - 5128	212	265-470	12 - 869	240
260-034	04 - 5603	82	265-066	12 - 5029	211	265-173	12 - 5241	242	265-306	12 - 9764	222	265-478	12 - 9861	241
260-042	04 - 469	82	2											



AFTERMARKET CROSS REFERENCE

Part No.	Rotary No.	Page No.	Part No.	Rotary No.	Page No.	Part No.	Rotary No.	Page No.	Part No.	Rotary No.	Page No.	Part No.	Rotary No.	Page No.
STENS			265-653	12 - 14593	257	265-823	12 - 8509	245	265-916	12 - 5131	212	271-510	12 - 5069	212
265-516	12 - 5110	212	265-656	12 - 6969	242	265-823	12 - 7623	216	265-916	12 - 7541	215	271-510	12 - 8733	248
265-516	12 - 7520	215	265-660	12 - 5017	211	265-823	12 - 5205	213	265-918	12 - 9847	234	271-510	12 - 8811	242
265-516	12 - 7672	238	265-660	12 - 7439	214	265-823	12 - 7128	240	265-923	12 - 5220	213	271-528	12 - 5070	212
265-524	12 - 14120	237	265-664	12 - 5089	212	265-824	12 - 10782	228	265-923	12 - 7638	216	271-528	12 - 7480	215
265-525	12 - 8429	221	265-664	12 - 7499	215	265-825	12 - 10077	224	265-927	12 - 5167	213	271-536	12 - 5071	212
265-532	12 - 5218	213	265-672	12 - 5017	211	265-826	12 - 10436	230	265-927	12 - 5238	242	271-544	12 - 5072	212
265-532	12 - 7636	216	265-672	12 - 7439	214	265-827	12 - 7629	216	265-927	12 - 7585	216	271-551	12 - 6503	237
265-536	12 - 7522	215	265-675	12 - 13301	234	265-827	12 - 5211	213	265-931	12 - 6896	240	271-551	12 - 5073	212
265-536	12 - 6901	222	265-678	12 - 7952	241	265-828	12 - 10437	230	265-931	12 - 8464	223	271-551	12 - 7791	254
265-536	12 - 6843	233	265-680	12 - 14237	232	265-829	12 - 10885	247	265-931	12 - 4998	237	271-569	12 - 5074	212
265-536	12 - 5112	212	265-682	12 - 7629	216	265-832	12 - 10252	248	265-931	12 - 5115	212	271-577	12 - 5075	212
265-538	12 - 5024	211	265-682	12 - 5211	213	265-833	12 - 10037	247	265-931	12 - 7525	215	271-577	12 - 7485	215
265-538	12 - 7446	214	265-686	12 - 870	224	265-834	12 - 10251	247	265-938	12 - 9697	223	271-585	12 - 7486	215
265-542	12 - 6843	233	265-690	12 - 8075	241	265-835	12 - 6874	240	265-942	12 - 8733	248	271-585	12 - 5076	212
265-542	12 - 7517	215	265-694	12 - 7440	214	265-838	12 - 12687	241	265-943	12 - 7169	233	271-593	12 - 5077	212
265-542	12 - 5107	212	265-694	12 - 5018	211	265-839	12 - 7514	215	265-943	12 - 5085	212	271-601	12 - 5078	212
265-546	12 - 5119	212	265-694	12 - 8820	260	265-839	12 - 5104	212	265-943	12 - 9765	222	271-619	12 - 7489	215
265-546	12 - 6904	238	265-702	12 - 7547	215	265-840	12 - 10884	247	265-943	12 - 7495	215	271-619	12 - 5079	212
265-546	12 - 7529	215	265-702	12 - 6632	212	265-842	12 - 12405	247	265-947	12 - 5117	212	271-627	12 - 5820	241
265-550	12 - 7610	216	265-711	12 - 12322	253	265-843	12 - 7508	215	265-947	12 - 7527	215	271-627	12 - 8798	260
265-550	12 - 5192	213	265-715	12 - 12653	229	265-843	12 - 5098	212	265-947	12 - 8781	223	271-627	12 - 5080	212
265-553	12 - 6635	212	265-718	12 - 7479	215	265-843	12 - 5821	241	265-951	12 - 5126	212	271-627	12 - 7490	215
265-553	12 - 7550	215	265-718	12 - 5069	212	265-843	12 - 8427	221	265-951	12 - 7536	215	271-627	12 - 8444	238
265-556	12 - 12768	227	265-718	12 - 8733	248	265-844	12 - 10887	247	265-955	12 - 5113	212	271-635	12 - 7491	215
265-557	12 - 5175	213	265-724	12 - 10851	251	265-845	12 - 11504	247	265-955	12 - 6900	222	271-635	12 - 5081	212
265-557	12 - 7593	216	265-725	12 - 10852	251	265-847	12 - 8808	242	265-955	12 - 7523	215	271-643	12 - 5082	212
265-557	12 - 6908	235	265-726	12 - 12320	252	265-847	12 - 5096	212	265-958	12 - 10306	223	271-643	12 - 7492	215
265-561	12 - 5110	212	265-727	12 - 10861	252	265-847	12 - 7506	215	265-959	12 - 5079	212	271-650	12 - 5237	242
265-561	12 - 7520	215	265-728	12 - 7837	250	265-848	12 - 10912	239	265-959	12 - 7489	215	271-650	12 - 5083	212
265-569	12 - 5823	242	265-730	12 - 12319	252	265-848	12 - 10847	251	265-963	12 - 6901	222	271-650	12 - 5231	258
265-569	12 - 5217	213	265-732	12 - 6837	258	265-850	12 - 10845	251	265-963	12 - 5112	212	271-700	12 - 5088	212
265-569	12 - 7635	216	265-736	12 - 8760	250	265-852	12 - 10846	251	265-963	12 - 8463	222	271-700	12 - 6876	237
265-569	12 - 7790	254	265-736	12 - 5071	212	265-854	12 - 12049	254	265-963	12 - 6843	233	271-700	12 - 7498	215
265-573	12 - 7543	215	265-740	12 - 5180	213	265-855	12 - 5100	212	265-963	12 - 7522	215	271-759	12 - 5093	212
265-573	12 - 5133	212	265-740	12 - 7789	254	265-855	12 - 6949	235	265-971	12 - 7515	215	271-767	12 - 5094	212
265-577	12 - 7526	215	265-740	12 - 7598	216	265-856	12 - 10844	251	265-971	12 - 5105	212	271-767	12 - 7504	215
265-577	12 - 5116	212	265-748	12 - 5210	213	265-858	12 - 10254	245	265-975	12 - 7534	215	271-791	12 - 7507	215
265-577	12 - 6509	238	265-748	12 - 8091	246	265-861	12 - 10405	255	265-975	12 - 5124	212	271-791	12 - 5097	212
265-579	12 - 5130	212	265-748	12 - 7628	216	265-862	12 - 10319	256	265-975	12 - 6505	237	271-817	12 - 7509	215
265-579	12 - 7540	215	265-748	12 - 8803	242	265-864	12 - 12067	256	265-979	12 - 5079	212	271-817	12 - 5099	212
265-583	12 - 5181	213	265-751	12 - 5015	211	265-865	12 - 12068	256	265-979	12 - 7489	215	271-833	12 - 5101	212
265-583	12 - 7599	216	265-751	12 - 7437	214	265-866	12 - 12069	256	265-983	12 - 6508	238	271-833	12 - 7511	215
265-587	12 - 7546	215	265-755	12 - 5867	246	265-867	12 - 7521	215	265-983	12 - 8784	222	271-858	12 - 7513	215
265-587	12 - 7129	240	265-755	12 - 5216	213	265-867	12 - 8463	222	265-983	12 - 7538	215	271-858	12 - 5103	212
265-587	12 - 6631	212	265-755	12 - 7634	216	265-867	12 - 5111	212	265-983	12 - 5128	212	271-866	12 - 6874	240
265-587	12 - 7171	241	265-763	12 - 7498	215	265-868	12 - 12070	257	265-987	12 - 8431	221	275-012	13 - 7986	284
265-591	12 - 5017	211	265-763	12 - 6876	237	265-869	12 - 12071	257	265-987	12 - 7791	254	275-020	13 - 5950	291
265-591	12 - 7439	214	265-763	12 - 5088	212	265-870	12 - 12072	257	265-987	12 - 8812	246	275-020	13 - 8547	291
265-591	12 - 7477	215	265-767	12 - 8443	238	265-871	12 - 5124	212	265-987	12 - 5073	212	275-080	13 - 5976	267
265-591	12 - 5067	212	265-767	12 - 5113	212	265-871	12 - 7534	215	265-991	12 - 8428	221	275-100	13 - 12271	271
265-595	12 - 5103	212	265-767	12 - 7523	215	265-871	12 - 7673	238	265-991	12 - 5070	212	275-159	13 - 13423	274
265-595	12 - 7513	215	265-767	12 - 6900	222	265-872	12 - 12073	257	265-991	12 - 7480	215	275-171	13 - 13426	274
265-599	12 - 6949	235	265-769	12 - 5015	211	265-883	12 - 7913	242	265-995	12 - 5015	211	275-175	13 - 2186	267
265-599	12 - 7510	215	265-781	12 - 7837	250	265-886	12 - 13541	239	265-995	12 - 7437	214	275-179	13 - 5883	267
265-599	12 - 5100	212	265-792	12 - 14166	257	265-890	12 - 10387	258	265-999	12 - 8430	221	275-183	13 - 5880	267
265-603	12 - 5074	212	265-793	12 - 5196	213	265-891	12 - 7608	216	265-999	12 - 7439	214	275-187	13 - 5965	267
265-603	12 - 6503	237	265-793	12 - 7614	216	265-891	12 - 5190	213	265-999	12 - 5017	211	275-203	13 - 10161	278
265-607	12 - 8092	246	265-793	12 - 6842	236	265-892	12 - 5199	213	265965	12 - 12246	260	275-207	13 - 10079	278
265-607	12 - 7597	216	265-797	12 - 5115	212	265-892	12 - 7617	216	271-353	12 - 5053	212	275-211	13 - 13427	274
265-607	12 - 5179	213	265-797	12 - 4998	237	265-895	12 - 7610	216	271-361	12 - 5054	212	275-220	13 - 436	291
265-611	12 - 6842	236	265-797	12 - 6896	240	265-895	12 - 5192	213	271-379	12 - 5055	212	275-236	13 - 7995	284
265-611	12 - 7614	216	265-797	12 - 7525	215	265-897	12 - 5055	212	271-387	12 - 5056	212	275-240	13 - 7993	284
265-611	12 - 5196	213	265-801	12 - 7542	215	265-899	12 - 7610	216	271-387	12 - 7466	215	275-260	13 - 5991	272
265-612	12 - 13256	245	265-801											

AFTERMARKET CROSS REFERENCE



Part No.	Rotary No.	Page No.	Part No.	Rotary No.	Page No.	Part No.	Rotary No.	Page No.	Part No.	Rotary No.	Page No.	Part No.	Rotary No.	Page No.
STENS			280-1470	13 - 13425	274	280-750	13 - 8829	292	285-270	10 - 3220	183	285-874	09 - 5721	146
275-412	13 - 769	266	280-149	13 - 2915	263	280-754	13 - 5869	263	285-286	10 - 6580	157	285-878	10 - 8649	200
275-412	13 - 5979	267	280-156	13 - 714	36	280-770	13 - 9849	269	285-296	10 - 3242	161	285-886	10 - 8647	201
275-420	13 - 772	266	280-156	13 - 2188	263	280-773	13 - 14255	280	285-300	10 - 14230	191	285-890	05 - 8099	90
275-446	13 - 761	266	280-156	13 - 12891	281	280-794	13 - 12277	273	285-312	10 - 11962	187	285-891	13 - 2187	272
275-450	13 - 8965	282	280-156	13 - 2916	263	280-798	13 - 14091	280	285-332	10 - 12925	198	285-895	10 - 8648	200
275-453	13 - 762	266	280-164	13 - 2917	264	280-802	13 - 14090	280	285-332	10 - 2925	198	285-908	10 - 2224	172
275-457	13 - 2189	264	280-164	13 - 5714	264	280-822	13 - 5712	264	285-336	10 - 9516	196	285-910	10 - 12668	190
275-457	13 - 2186	267	280-164	13 - 12427	279	280-850	13 - 9891	271	285-342	10 - 8320	198	285-916	10 - 2910	161
275-461	13 - 763	266	280-188	13 - 728	36	280-862	13 - 9864	275	285-342	10 - 8321	198	285-920	05 - 7787	91
275-469	13 - 8657	281	280-198	13 - 2181	263	280-866	13 - 9772	276	285-350	10 - 12383	191	285-928	10 - 12972	189
275-479	13 - 764	266	280-198	13 - 719	36	280-870	13 - 9793	276	285-358	10 - 14252	191	285-936	10 - 12973	188
275-487	13 - 765	266	280-230	13 - 2175	263	280-874	13 - 12696	279	285-369	10 - 9521	184	285-940	10 - 1227	186
275-487	13 - 5982	267	280-234	13 - 10128	36	280-874	13 - 10397	276	285-373	10 - 9520	184	285-952	10 - 8950	181
275-495	13 - 5983	267	280-235	13 - 9846	269	280-880	13 - 12302	275	285-383	10 - 8479	184	285-956	10 - 8314	161
275-495	13 - 770	266	280-236	13 - 11657	286	280-886	13 - 11815	275	285-383	10 - 12723	184	285-956	10 - 8313	161
275-503	13 - 773	266	280-238	13 - 12661	270	280-894	13 - 13417	277	285-387	10 - 2226	162	285-957	10 - 2238	175
275-503	13 - 5984	267	280-239	13 - 11633	269	280-906	13 - 12419	279	285-391	10 - 9232	162	285-957	10 - 9153	198
275-511	13 - 766	266	280-240	13 - 11634	270	280-922	13 - 12299	278	285-399	10 - 13225	181	285-961	10 - 8313	161
275-511	13 - 5985	267	280-242	13 - 11207	279	280-926	13 - 10156	37	285-403	10 - 2909	162	285-969	10 - 12967	188
275-515	13 - 9588	281	280-242	13 - 10737	279	280-934	13 - 12644	270	285-411	10 - 2908	162	285-981	05 - 8293	70
275-519	13 - 9587	281	280-248	13 - 730	36	280-966	13 - 737	264	285-423	05 - 9757	91	290-015	03 - 6657	56
275-529	13 - 5881	267	280-248	13 - 728	36	280-970	13 - 736	264	285-427	10 - 8320	198	290-015	03 - 236	56
275-529	13 - 767	266	280-252	13 - 11464	286	280-974	13 - 735	264	285-427	09 - 2892	145	290-023	03 - 235	56
275-537	13 - 768	266	280-255	13 - 729	36	280236	13 - 6572	264	285-435	10 - 7765	197	290-027	03 - 6992	64
275-537	13 - 5882	267	280-263	13 - 728	36	280507	01 - 717	36	285-441	10 - 8548	184	290-031	03 - 235	56
275-545	13 - 5986	267	280-263	13 - 730	36	285-002	05 - 8265	91	285-445	05 - 2700	72	290-043	27 - 7905	75
275-545	13 - 771	266	280-271	13 - 728	36	285-005	10 - 8671	161	285-449	10 - 8985	162	290-043	27 - 8673	75
275-549	13 - 8193	291	280-271	13 - 731	36	285-007	10 - 2903	172	285-452	10 - 2937	183	290-043	27 - 7411	75
275-552	13 - 774	266	280-289	13 - 732	36	285-011	10 - 6886	175	285-456	10 - 8479	184	290-049	03 - 242	62
275-564	13 - 9397	292	280-297	13 - 2182	263	285-013	10 - 8860	161	285-460	10 - 7283	183	290-0493	03 - 242	62
275-568	02 - 9373	53	280-305	13 - 733	36	285-015	10 - 2934	172	285-464	10 - 8549	184	290-064	03 - 243	56
275-568	13 - 9397	292	280-313	13 - 734	36	285-019	10 - 6885	175	285-476	10 - 8901	184	290-064	03 - 244	66
275-578	13 - 438	291	280-313	13 - 5869	263	285-023	10 - 2933	172	285-486	05 - 3244	94	290-068	03 - 231	65
275-586	13 - 436	291	280-321	13 - 2183	263	285-025	10 - 8504	171	285-498	10 - 7125	157	290-068	03 - 5805	65
275-594	13 - 2926	284	280-325	13 - 5714	264	285-031	10 - 6813	201	285-518	10 - 8625	156	290-102	03 - 8415	63
275-610	13 - 2928	284	280-325	13 - 726	36	285-040	02 - 9374	53	285-532	10 - 10194	156	290-106	03 - 7961	62
275-618	13 - 5950	291	280-333	13 - 9895	274	285-041	10 - 9519	184	285-540	10 - 7181	162	290-106	03 - 242	62
275-626	13 - 5949	291	280-339	13 - 2918	263	285-043	05 - 8294	70	285-544	10 - 3306	172	290-106	03 - 946	62
275-628	13 - 2929	284	280-339	13 - 7127	263	285-047	10 - 7154	182	285-548	10 - 7919	162	290-114	03 - 230	62
275-644	13 - 7991	284	280-347	13 - 2919	263	285-050	10 - 6887	180	285-555	10 - 6672	163	290-122	03 - 228	62
275-644	13 - 7417	283	280-362	13 - 5869	263	285-056	10 - 254	171	285-563	10 - 9517	196	290-122	03 - 229	62
275-689	13 - 5883	267	280-362	13 - 734	36	285-084	10 - 8968	197	285-573	10 - 6670	163	290-130	03 - 9135	66
275-697	13 - 7124	290	280-3700	13 - 11657	286	285-088	10 - 8967	197	285-585	10 - 11590	185	290-134	05 - 10686	70
275-709	13 - 7786	287	280-3700	13 - 11464	286	285-092	10 - 7156	195	285-609	10 - 14132	199	290-171	03 - 9128	57
275-727	13 - 3317	284	280-378	13 - 13622	270	285-093	10 - 11206	194	285-613	10 - 6581	156	290-175	03 - 7974	63
275-750	13 - 776	291	280-382	13 - 7126	264	285-097	10 - 9906	182	285-617	10 - 2222	158	290-191	03 - 8530	62
275-780	13 - 10185	282	280-390	13 - 5714	264	285-104	10 - 10228	178	285-631	10 - 2226	162	290-195	03 - 867	65
275-816	13 - 6607	272	280-408	13 - 714	36	285-104	10 - 11961	187	285-635	10 - 3223	172	290-203	03 - 7975	63
275-828	13 - 7417	283	280-408	13 - 2188	263	285-105	10 - 12066	196	285-643	10 - 7284	183	290-203	03 - 241	65
275-840	13 - 6532	290	280-416	13 - 7983	263	285-106	10 - 3207	171	285-662	10 - 7251	201	290-203	03 - 5805	65
275-875	13 - 2185	272	280-420	13 - 724	36	285-107	10 - 11961	187	285-676	05 - 8970	90	290-203	03 - 6589	66
275-883	13 - 2185	272	280-436	13 - 2184	272	285-108	10 - 11014	185	285-684	10 - 3307	161	290-203	03 - 231	65
275-909	13 - 2186	267	280-438	13 - 8588	264	285-109	10 - 11278	193	285-688	10 - 2218	157	290-203	03 - 239	65
275-945	13 - 5989	290	280-446	13 - 2191	264	285-110	10 - 7155	197	285-692	10 - 7747	157	290-203	03 - 8961	63
275-945	13 - 11228	286	280-453	13 - 2192	264	285-112	10 - 9287	196	285-696	10 - 6974	171	290-205	05 - 9126	69
275-945	13 - 5988	290	280-477	13 - 9856	290	285-113	10 - 9286	195	285-704	05 - 10862	92	290-213	05 - 11512	71
280-008	13 - 715	263	280-479	13 - 2190	264	285-114	10 - 3221	172	285-708	05 - 7788	90	290-217	03 - 9130	60
280-016	13 - 718	36	280-483	13 - 9844	286	285-116	10 - 9284	197	285-726	10 - 858	73	290-245	03 - 9566	68
280-020	13 - 7278	292	280-487	13 - 2193	264	285-117	10 - 9285	196	285-730	10 - 9515	197	290-249	03 - 9680	57
280-024	13 - 2175	263	280-491	13 - 12472	277	285-119	10 - 9288	196	285-738	13 - 9758	290	290-253	03 - 9679	57
280-028	13 - 715	263	280-495	13 - 727	36	285-122	10 - 3301	171	285-759	10 - 7886	180	290-258	03 - 8416	63
280-028	13 - 8478	263	280-499	13 - 7978	263	285-126	05 - 2699	72	285-767	10 - 7885	180	290-262	03 - 6589	66
280-032	13 - 720	36	280-503	01 - 717	36	285-130	10 - 6890	182	285-783	08 - 7745	117	290-262	03 - 239	65
280-032	13 - 719	36	280-511	13 - 12301	275	285-134	02 - 9373	53	285-787	10 - 10013	176	290-262	03 - 7812	66
280-														



AFTERMARKET CROSS REFERENCE

Part No.	Rotary No.	Page No.	Part No.	Rotary No.	Page No.	Part No.	Rotary No.	Page No.	Part No.	Rotary No.	Page No.	Part No.	Rotary No.	Page No.
STENS			301-010	15-3373	338	303-168	15-3400	336	315-077	15-6195	330	325-735	15-11475	343
290-495	03-10121	72	301-014	15-6083	344	305-068	15-6286	394	315-242	15-6020	343	325-742	15-11477	342
290-499	03-10118	59	301-014	15-6180	334	305-516	15-1093	393	315-246	15-6224	343	325-746	15-6240	341
290-503	05-10891	70	301-015	15-6014	338	305-516	15-6021	393	315-254	15-6404	334	325-773	15-6092	364
290-551	03-10688	61	301-015	15-1010	336	305-524	15-6024	393	315-259	15-825	346	325-787	15-6075	340
290-559	05-11513	71	301-015	15-2173	334	305-524	15-3447	393	315-499	15-6833	334	325-795	15-6077	343
290-623	05-14623	68	301-015	15-3374	338	305-524	15-1085	393	315-511	15-6441	344	325-803	15-6086	345
290-635	05-13548	68	301-015	15-3401	336	305-589	15-6254	328	315-511	15-6180	334	325-803	15-6087	345
290-643	05-13332	69	301-015	15-3404	347	305-599	15-6025	393	315-511	15-6083	344	325-827	15-12893	342
290-651	05-14341	73	301-047	15-3372	343	305-599	15-3406	393	315-515	15-1074	356	325-837	15-6081	340
290-665	05-13657	71	301-047	15-1066	345	305-603	15-6060	328	315-762	15-3346	372	325-841	15-6240	341
290-795	03-12218	58	302-008	14-6322	314	305-603	15-3326	328	315-766	15-6084	346	325-845	15-6082	341
290-799	03-13014	58	302-012	15-6296	322	305-615	15-6099	394	315-792	15-6180	334	325-849	15-6239	342
290-807	05-12965	73	302-016	15-3403	347	305-623	15-1093	393	315-792	15-6083	344	325-856	15-6237	343
290-831	03-237	56	302-016	15-6300	322	305-623	15-6021	393	315-792	15-13624	361	325-860	15-6078	343
290-851	05-14040	69	302-016	15-6222	372	305-631	15-3406	393	315-868	15-2172	334	325-880	15-6075	340
290-855	05-11511	71	302-016	15-6115	338	305-631	15-6025	393	315-868	15-3403	347	325-884	15-6077	343
290-863	05-11517	71	302-016	15-6116	338	305-649	15-6024	393	315-868	15-1009	336	325-900	15-6082	341
290-867	05-11514	71	302-020	15-6298	322	305-649	15-1085	393	315-872	15-9987	357	325-904	15-6081	340
290-899	03-9855	61	302-024	15-6294	323	305-649	15-3447	393	315-872	15-3434	362	330-005	15-6208	377
290-904	05-5616	69	302-028	15-6303	324	305-680	15-6031	393	315-872	15-2174	337	330-027	15-1058	372
295-006	03-247	74	302-032	15-3434	362	305-700	15-6138	394	315-876	15-6014	338	330-069	15-11594	376
295-014	03-248	74	302-032	15-3402	337	305-708	15-6099	394	315-876	15-3404	347	330-225	15-6208	377
295-048	03-9136	74	302-032	15-2174	337	305-730	15-3322	328	315-876	15-3374	338	330-233	15-6209	378
295-055	03-245	74	302-032	15-6141	339	305-771	15-6060	328	320-006	15-6401	360	330-258	15-1100	345
295-063	03-246	74	302-032	15-6299	324	305-771	15-3326	328	320-006	15-6167	359	330-258	15-1126	372
295-079	03-8506	74	302-036	15-6316	321	305-821	15-911	328	320-006	15-6168	360	330-258	15-1065	360
295-121	10-337	161	302-040	15-6312	321	305-839	15-2137	328	320-010	15-3377	359	330-262	15-6193	372
295-151	10-8302	163	302-048	15-6311	324	310-003	15-1009	336	320-010	15-3378	359	330-266	15-1127	372
295-162	10-863	160	302-056	15-6315	323	310-003	15-3403	347	320-014	15-6167	359	330-274	15-3381	361
295-162	10-9565	160	302-064	15-6295	325	310-003	15-2172	334	320-014	15-6401	360	330-282	15-2120	375
295-166	03-7717	60	302-068	15-6317	324	310-007	15-6272	337	320-014	15-3424	360	330-290	15-6011	374
295-174	10-8660	160	302-072	15-6302	326	310-011	15-3404	347	320-014	15-6168	360	330-308	15-6012	373
295-182	10-8303	163	302-076	15-6297	326	310-011	15-2173	334	320-026	15-6402	360	330-308	15-6181	360
295-188	10-336	160	302-080	15-6301	326	310-011	15-1010	336	320-028	15-3378	359	330-316	15-845	375
295-196	03-251	74	302-084	15-6308	324	310-037	15-1036	337	320-028	15-3377	359	330-316	15-6737	374
295-204	03-252	74	302-088	15-6314	322	310-045	15-2172	334	320-036	15-3380	359	330-336	15-6329	376
295-220	10-12749	160	302-136	15-6303	324	310-045	15-3403	347	320-036	15-3379	359	330-340	15-6327	376
295-240	10-863	160	302-136	15-9465	324	310-045	15-1009	336	320-040	15-6309	322	330-340	15-6328	376
295-279	03-250	74	302-244	15-6309	322	310-052	15-1010	336	320-040	15-3380	359	330-348	15-6122	375
295-287	04-267	85	302-260	15-6421	323	310-052	15-2173	334	320-040	15-13463	359	330-352	15-6252	376
295-287	04-219	85	302-288	15-6420	322	310-052	15-3404	347	320-044	15-11033	359	330-352	15-6255	376
295-295	04-267	85	302-316	15-6410	322	310-060	15-3329	337	320-044	15-3380	359	330-357	15-6253	375
295-295	04-219	85	302-512	15-11234	391	310-078	15-2174	337	320-044	15-3379	359	330-361	15-6186	375
295-303	10-6891	160	302-532	15-6491	321	310-078	15-3434	362	320-259	15-2030	358	330-365	15-6192	374
295-311	03-2702	74	302-620	15-6303	324	310-086	15-6272	337	320-341	15-1034	385	330-369	15-10291	373
295-337	10-336	160	302-684	15-9988	349	310-086	15-3402	337	320-502	15-6204	361	330-373	15-6206	373
295-406	03-8417	60	302-684	15-6296	322	310-094	15-3404	347	320-506	15-6203	361	330-377	15-9959	376
295-410	03-8800	57	302-692	15-10071	351	310-094	15-6014	338	320-507	15-1065	360	330-385	15-6253	375
295-547	03-9131	60	302-696	15-6303	324	310-094	15-2173	334	320-507	15-1126	372	330-389	15-6223	373
300-004	14-977	315	302-718	15-11776	322	310-094	15-1010	336	320-511	15-3381	361	330-393	15-6221	374
300-012	14-978	315	302-720	15-11784	324	310-094	15-3374	338	320-515	15-1066	345	330-397	15-6737	374
300-020	14-979	315	302-817	15-6300	322	310-102	15-3400	336	320-515	15-6013	319	330-397	15-845	375
300-038	15-2051	327	302-818	15-6294	323	310-110	15-3401	336	320-519	15-6171	362	330-409	15-6012	373
300-038	14-980	315	302-821	15-10971	370	310-110	15-2173	334	320-523	15-2164	361	330-441	15-11593	376
300-046	14-981	315	302-822	15-11469	354	310-110	15-1010	336	320-535	15-6088	345	330-445	15-11595	373
300-087	14-990	316	302-825	15-9883	325	310-177	15-6116	338	320-535	15-6181	360	330-449	15-11491	374
300-095	14-991	316	302-208	14-6322	314	310-177	15-6115	338	320-535	15-6012	373	330-453	15-10074	376
300-103	14-992	316	302-212	15-6296	322	310-177	15-6222	372	320-535	15-6224	343	330-542	15-6265	378
300-129	14-951	315	302-216	15-3403	347	310-177	15-3403	347	320-539	15-6285	361	330-546	15-6173	378
300-137	14-952	315	302-216	15-6300	322	310-185	15-3434	362	320-561	15-6290	353	330-548	15-3388	378
300-137	14-10952	315	302-216	15-6222	372	310-185	15-6141	339	320-561	15-6213	361	330-548	15-3339	361
300-145	14-953	315	302-216	15-6115	338	310-185	15-2174	337	320-564	15-3339	361	330-552	15-6209	378
300-145	14-10953	315	302-216	15-6116	338	310-193	15-3373	338	320-564	15-6083	344	330-555	15-3386	377
300-152	14-954	315	302-220	15-6298	322	310-197	15-6222	372	320-568	15-6194	319	330-559	15-3389	377
300-152	14-10954	315	302-224	15-6294	323	310-197	15-6115	338	320-994	15-2169	400	330-563	15-3387	377
300-160	14-955	315	302-228	15-6303	324	310-197	15							

AFTERMARKET CROSS REFERENCE



Part No.	Rotary No.	Page No.	Part No.	Rotary No.	Page No.	Part No.	Rotary No.	Page No.	Part No.	Rotary No.	Page No.	Part No.	Rotary No.	Page No.
STENS			335-422	15 - 1136	404	340-066	15 - 6189	332	345-314	15 - 3362	411	355-213	15 - 11792	325
330-753	15 - 3404	347	335-463	15 - 3443	392	340-079	15 - 6190	331	345-330	15 - 1011	409	355-229	15 - 11231	349
330-753	15 - 6014	338	335-471	15 - 6144	391	340-091	15 - 10377	329	345-338	15 - 2171	412	355-233	15 - 6250	352
330-753	15 - 2173	334	335-475	15 - 6146	390	340-099	15 - 10930	398	345-338	15 - 6118	412	355-275	15 - 11241	351
330-753	15 - 1010	336	335-525	15 - 1021	385	340-109	15 - 3403	347	345-348	15 - 1006	410	355-279	15 - 11244	355
330-770	15 - 10458	375	335-533	15 - 1022	385	340-113	15 - 6009	379	345-397	15 - 1008	410	355-283	15 - 11229	355
330-779	15 - 6141	339	335-547	15 - 1077	381	340-117	15 - 3434	362	345-405	15 - 3361	408	355-287	15 - 11224	353
330-779	15 - 1057	379	335-554	15 - 997	382	340-117	15 - 2174	337	345-413	15 - 2171	412	355-287	15 - 11248	353
330-795	15 - 6008	380	335-562	15 - 1014	382	340-121	15 - 3442	380	345-421	15 - 10209	318	355-291	15 - 11495	351
330-811	15 - 6141	339	335-570	15 - 1015	382	340-125	15 - 6195	330	345-421	15 - 6251	411	355-291	15 - 11267	351
330-827	15 - 12995	379	335-578	15 - 6197	401	340-129	15 - 6026	334	345-429	15 - 10928	352	355-295	15 - 11242	352
330-831	15 - 14481	378	335-586	15 - 1024	386	340-130	15 - 6026	334	345-439	15 - 3394	409	355-331	15 - 10667	334
330-837	15 - 848	379	335-586	15 - 11232	386	340-137	15 - 6236	333	345-447	15 - 3395	409	355-407	15 - 12002	350
330-845	15 - 849	379	335-588	15 - 1016	382	340-145	15 - 6205	329	345-454	15 - 3441	407	355-411	15 - 12003	350
330429	15 - 6122	375	335-592	15 - 6457	383	340-145	15 - 6263	329	345-462	15 - 3405	408	355-415	15 - 11775	350
335-004	15 - 6010	392	335-596	15 - 1017	383	340-149	15 - 6196	330	345-486	15 - 3393	407	355-419	15 - 12004	352
335-008	15 - 6017	390	335-600	15 - 6127	383	340-149	15 - 6264	330	345-496	15 - 1008	410	355-423	15 - 11779	352
335-008	15 - 6111	390	335-600	15 - 6028	383	340-153	15 - 6219	330	345-496	15 - 6002	410	355-503	15 - 6180	334
335-008	15 - 6119	390	335-604	15 - 1018	383	340-153	15 - 6123	330	345-668	15 - 6433	415	355-511	15 - 6231	396
335-012	15 - 6119	390	335-608	15 - 6424	387	340-157	15 - 6235	332	345-672	15 - 6434	416	355-701	15 - 6176	413
335-012	15 - 6017	390	335-624	15 - 11232	386	340-158	15 - 2173	334	345-769	15 - 6467	415	355-709	15 - 6170	413
335-012	15 - 6111	390	335-624	15 - 1026	386	340-158	15 - 1010	336	345-777	15 - 6432	415	355-713	15 - 6169	413
335-016	15 - 6112	390	335-628	15 - 6212	384	340-158	15 - 3404	347	345-777	15 - 3421	415	365-007	28 - 1995	663
335-016	15 - 6129	391	335-632	15 - 6425	388	340-162	15 - 6124	331	345-785	15 - 6210	416	365-011	28 - 1994	663
335-016	15 - 6034	390	335-646	15 - 3354	384	340-162	15 - 6218	331	350-017	15 - 1108	407	365-015	28 - 1997	664
335-018	15 - 3381	361	335-650	15 - 1034	385	340-166	15 - 6219	330	350-033	15 - 1108	407	365-023	28 - 1994	663
335-030	15 - 6112	390	335-653	15 - 3356	382	340-166	15 - 6123	330	350-041	15 - 1108	407	365-047	28 - 8979	663
335-030	15 - 6129	391	335-657	15 - 6448	387	340-170	15 - 6218	331	350-098	15 - 10363	342	365-080	28 - 1998	664
335-030	15 - 6034	390	335-665	15 - 6439	387	340-170	15 - 6124	331	350-108	15 - 1100	345	365-148	28 - 1999	663
335-038	15 - 9896	389	335-669	15 - 6004	383	340-172	15 - 3403	347	350-108	15 - 851	407	370-0073	14 - 16248	314
335-038	15 - 6113	389	335-677	15 - 6450	387	340-174	15 - 6008	380	350-116	15 - 2000	407	370-0073	14 - 2009	315
335-042	15 - 6110	402	335-691	15 - 1029	385	340-178	15 - 6262	332	350-116	15 - 1126	372	370-019	14 - 6248	314
335-042	15 - 2006	402	335-695	15 - 1030	340	340-178	15 - 6125	332	350-124	15 - 1127	372	370-302	29 - 8610	667
335-042	15 - 2007	401	335-707	15 - 11233	386	340-182	15 - 6125	332	350-124	15 - 2001	408	370-306	29 - 8611	667
335-050	15 - 6408	389	335-707	15 - 1032	386	340-222	15 - 9907	330	350-140	15 - 1126	372	370-322	29 - 8608	666
335-054	15 - 6476	391	335-711	15 - 1031	386	340-226	15 - 11180	331	350-140	15 - 1100	345	370-326	29 - 8609	666
335-058	15 - 6166	391	335-711	15 - 11233	386	340-230	15 - 12242	333	350-157	15 - 3468	409	370007	14 - 2009	315
335-059	15 - 6027	392	335-715	15 - 6438	387	340-248	15 - 9810	332	350-199	15 - 6088	345	370007	14 - 16248	314
335-059	15 - 3430	392	335-719	15 - 1037	385	340-440	15 - 6422	324	350-199	15 - 6224	343	370019	14 - 2009	315
335-067	15 - 6127	383	335-723	15 - 1038	385	340-440	15 - 6262	332	350-199	15 - 6181	360	370019	14 - 16248	314
335-067	15 - 6028	383	335-729	15 - 3408	381	340-509	15 - 6279	347	350-203	15 - 12909	342	373-017	15 - 12714	335
335-071	15 - 6475	390	335-737	15 - 3407	384	340-562	15 - 1020	329	350-372	15 - 10362	342	373-173	15 - 10968	335
335-075	15 - 6470	389	335-757	15 - 12956	386	340-570	15 - 2690	329	350-450	15 - 11663	347	373-173	15 - 6324	335
335-083	15 - 6096	383	335-760	15 - 2012	390	340-588	15 - 3358	330	350-454	15 - 11662	347	373-193	15 - 8720	335
335-117	15 - 6003	382	335-764	15 - 9897	391	340-604	15 - 1019	329	350-528	15 - 10361	341	373-193	15 - 11645	335
335-125	15 - 6019	381	335-764	15 - 6162	391	340-612	15 - 6116	338	350-538	15 - 824	417	373-197	15 - 8720	335
335-166	15 - 6034	390	335-768	15 - 6174	392	340-612	15 - 6115	338	350-603	15 - 6284	417	373-241	15 - 10780	335
335-166	15 - 6129	391	335-772	15 - 6142	390	340-612	15 - 3403	347	350-671	15 - 10373	370	373-373	15 - 6324	335
335-166	15 - 6112	390	335-776	15 - 6140	382	340-612	15 - 6222	372	350-675	15 - 10372	370	373-373	15 - 10968	335
335-168	15 - 1009	336	335-778	15 - 2013	392	340-620	15 - 6106	333	350-679	15 - 10797	371	375-014	16 - 1138	422
335-168	15 - 2172	334	335-782	15 - 6028	383	340-786	15 - 1076	398	350-683	15 - 10371	369	375-022	16 - 1143	423
335-170	15 - 6143	382	335-782	15 - 6127	383	340-878	15 - 3404	347	350-687	15 - 11721	371	375-030	16 - 2671	422
335-174	15 - 6018	389	335-786	15 - 844	389	345-009	15 - 1116	399	350-691	15 - 11557	370	375-048	16 - 1147	424
335-174	15 - 1124	389	335-786	15 - 1122	389	345-017	15 - 1117	399	350-695	15 - 11856	370	375-055	16 - 1137	422
335-182	15 - 6119	390	335-790	15 - 6126	382	345-037	15 - 10929	411	350-995	15 - 2000	407	375-063	16 - 1141	422
335-182	15 - 6111	390	335-798	15 - 6128	381	345-053	15 - 6135	411	355-008	15 - 2172	334	375-071	16 - 1139	423
335-182	15 - 6017	390	335-806	15 - 6160	391	345-070	15 - 10094	399	355-008	15 - 1009	336	375-089	16 - 1149	422
335-214	15 - 6423	387	335-810	15 - 1124	389	345-074	15 - 2081	399	355-016	15 - 3404	347	375-105	16 - 1144	423
335-232	15 - 910	405	335-810	15 - 6018	389	345-074	15 - 3386	377	355-016	15 - 1010	336	375-154	16 - 1149	422
335-240	15 - 2007	401	335-814	15 - 6139	383	345-082	15 - 2082	399	355-016	15 - 2173	334	375-162	16 - 2673	423
335-240	15 - 6110	402	335-818	15 - 6215	392	345-090	15 - 2083	399	355-022	15 - 6178	350	375-162	16 - 1148	423
335-240	15 - 2006	402	335-836	15 - 2166	392	345-102	15 - 10096	399	355-024	15 - 3446	413	375-200	16 - 6107	421
335-252	15 - 2006	402	335-844	15 - 2166	392	345-106	15 - 10095	399	355-028	15 - 6175	349	375-222	16 - 2670	423
335-252	15 - 2007	401	335-851	15 - 844	389	345-108	15 - 6069	338	355-028	15 - 9988	349	375-262	16 - 2673	423
335-252	15 - 6110	402	335-851	15 - 11										



AFTERMARKET CROSS REFERENCE

Part No.	Rotary No.	Page No.	Part No.	Rotary No.	Page No.	Part No.	Rotary No.	Page No.	Part No.	Rotary No.	Page No.	Part No.	Rotary No.	Page No.
STENS			390-211	27-30169	659	410-803	17-1187	39	417-493	02-91	40	418-756	02-45	40
380-179	27-3510	636	390-223	20-8526	518	415-109	01-2	39	417-501	02-87	40	418-764	02-46	40
380-183	27-3515	636	390-229	27-6968	659	415-109	01-1	39	417-519	02-88	40	418-772	02-47	40
380-195	27-3513	636	390-252	27-6927	77	415-141	01-11	41	417-527	02-89	40	418-780	02-48	40
380-199	27-1368	636	390-260	27-6926	77	415-166	01-8	41	417-535	02-93	40	418-798	02-49	40
380-2043	27-12101	636	390-302	27-8565	77	415-170	01-7204	43	417-543	02-94	40	418-806	02-50	40
380-2123	27-12102	636	390-328	27-6928	77	415-174	01-3	39	417-550	02-95	40	419-002	02-3258	48
380-2203	27-17090	636	390-344	27-7860	425	415-190	01-17	44	417-568	02-96	40	419-010	02-3259	48
380-2383	27-12103	636	390-364	27-8567	77	415-198	01-12021	52	417-576	02-97	40	419-028	02-3256	48
380-242	27-5921	636	390-380	27-9496	76	415-224	01-16	44	417-584	02-98	40	419-036	02-3257	48
380-246	27-5922	636	390-412	27-9686	76	415-232	01-19	44	417-592	02-84	40	419-044	02-3251	48
380-250	27-5923	636	390-500	27-9043	655	415-248	01-5897	44	417-600	02-85	40	419-051	02-3250	48
380-254	27-5924	636	395-004	27-7854	425	415-257	01-5896	47	417-618	02-86	40	419-069	02-3252	48
380-261	27-3518	636	395-020	27-4280	425	415-281	01-12	43	417-626	02-112	40	419-077	02-3253	48
380-279	27-3519	636	395-038	27-7862	425	415-299	01-12	43	417-634	02-113	40	419-085	02-3260	48
380-287	27-3520	636	395-046	27-7863	425	415-307	01-9	40	417-642	02-114	40	419-093	02-3261	48
380-295	27-3521	636	395-053	27-4279	425	415-315	01-15	49	417-659	02-108	40	419-101	02-3255	48
380-311	27-5928	636	395-061	27-5957	425	415-323	01-10	41	417-667	02-110	40	419-119	02-3254	48
380-329	27-5927	636	395-079	27-4400	425	415-349	01-7	38	417-675	02-111	40	419-317	32-2347	1084
380-337	27-5929	636	395-087	27-4278	425	415-364	01-22	45	417-683	02-99	40	419-333	02-5910	44
380-345	27-5930	636	395-095	27-7855	425	415-380	01-18	44	417-691	02-100	40	419-337	02-5911	44
380-373	27-9332	636	395-111	27-4405	425	415-414	01-6	40	417-709	02-101	40	419-341	02-5912	44
380-377	27-9157	636	395-129	27-9743	425	415-448	01-1571	48	417-717	02-102	40	419-349	02-5913	44
380-381	27-5922	636	395-129	27-4414	425	415-505	50-8202	1239	417-725	02-103	40	419-357	02-5914	44
380-385	27-5923	636	395-137	27-4413	425	415-513	50-8203	1239	417-733	02-104	40	420-026	21-2227	522
380-389	27-5924	636	395-137	27-9741	425	415-521	50-8204	1239	417-741	02-105	40	420-026	21-8722	523
380-397	27-3518	636	395-202	27-7855	425	416-206	02-135	41	417-758	02-106	40	420-042	21-2228	522
380-401	27-6530	636	395-210	27-7863	425	416-214	02-136	41	417-766	02-107	40	420-046	21-8721	523
380-406	27-3505	636	395-228	27-4405	425	416-222	02-137	41	417-774	02-127	41	420-046	21-2228	522
380-410	27-3506	636	395-317	27-8458	425	416-230	02-138	41	417-790	02-128	41	420-075	21-8722	523
380-428	27-3509	636	395-321	27-8459	425	416-248	02-139	41	417-808	02-120	41	420-075	21-2228	522
380-436	27-3510	636	395-325	27-8460	425	416-255	02-140	41	417-816	02-130	41	420-131	21-6622	522
380-444	27-3515	636	395-329	27-7857	425	416-289	02-71	41	417-824	02-122	41	420-155	21-6623	522
380-451	27-1344	636	395-329	27-8461	425	416-297	02-72	41	417-832	02-126	41	420-179	21-13346	524
380-469	27-1337	636	395-333	27-8458	425	416-305	02-73	41	417-840	02-125	41	420-199	21-6624	522
380-477	27-3513	636	395-337	27-8459	425	416-313	02-74	41	417-857	02-129	41	420-200	21-13358	524
380-485	27-1368	636	395-341	27-8460	425	416-321	02-75	41	417-865	02-119	41	425-009	31-6816	45
380-626	27-5927	636	395-345	27-8461	425	416-339	02-76	41	417-873	02-121	41	425-033	31-1944	1058
380-634	27-5930	636	395-345	27-7857	425	416-347	02-77	41	417-881	02-124	41	425-041	31-1940	1057
385-055	27-13597	646	400-002	17-1159	432	416-354	02-78	41	418-004	02-55	38	425-058	31-1941	1057
385-056	27-13603	646	400-010	17-1156	433	416-362	02-79	41	418-012	02-56	38	425-066	31-1942	1057
385-070	27-13600	646	400-085	17-1162	428	416-537	17-141	39	418-020	02-57	38	425-074	31-1943	1057
385-078	27-3512	655	400-275	17-1182	431	416-552	02-163	43	418-038	02-58	38	425-108	32-9023	1097
385-082	27-8570	655	400-283	17-1160	431	416-560	02-164	44	418-046	02-59	38	425-116	31-8596	1058
385-100	27-9224	643	400-382	17-1237	430	416-578	02-165	44	418-053	02-60	38	425-124	31-8600	1058
385-112	27-11984	640	400-382	17-1235	430	416-586	02-168	44	418-061	02-61	38	425-124	31-1938	1058
385-112	27-30101	642	400-465	17-6626	428	416-594	02-167	44	418-079	02-62	38	425-140	32-8531	1102
385-120	27-9850	643	400-489	17-7119	429	416-602	02-166	44	418-087	02-63	38	425-157	32-9086	1102
385-146	27-30112	647	400-500	17-12728	428	416-644	02-12222	53	418-095	02-64	38	425-165	32-8545	1102
385-185	27-9851	643	403-205	31-9657	1064	416-651	10-8448	178	418-103	02-65	38	425-181	31-8599	1058
385-203	27-30127	642	405-005	17-7810	429	416-669	10-321	39	418-111	02-66	38	425-207	31-1937	1058
385-252	27-11987	640	405-183	17-2220	428	416-719	10-9296	177	418-293	02-210	45	425-215	31-1932	1057
385-252	27-30131	645	405-191	17-1152	431	416-784	02-25	43	418-301	02-204	45	425-223	31-1933	1057
385-272	27-11757	644	405-217	17-1167	430	416-800	02-28	44	418-319	02-202	45	425-231	31-1934	1057
385-284	27-13375	646	405-221	17-8753	428	416-800	02-29	44	418-327	02-206	45	425-249	31-1935	1057
385-288	27-13377	646	405-233	17-1224	431	416-826	02-27	44	418-335	02-208	45	425-264	31-1936	1058
385-300	27-6881	659	405-233	17-1182	431	416-834	02-24	43	418-343	02-203	45	425-272	31-1950	1073
385-336	27-30113	647	405-282	17-423	434	416-842	02-24	43	418-350	02-208	45	425-298	31-2675	1057
385-427	27-10231	644	405-340	17-1178	431	416-958	02-3168	47	418-350	02-213	45	425-306	31-8090	46
385-435	27-10231	644	405-340	17-1160	431	416-966	02-3192	47	418-368	02-218	45	425-314	31-1906	1057
385-563	27-14500	645	405-399	17-5935	430	416-974	02-3196	47	418-368	02-213	45	425-322	31-1908	1057
385-571	27-14501	645	405-403	17-6793	432	416-982	02-3197	47	418-376	02-216	45	425-330	31-1905	1057
385-575	27-14577	645	405-403	17-10019	432	417-006	02-3198	47	418-376	02-209	45	425-449	31-7724	1057
385-629	27-11826	640	405-435	17-8752	428	417-014	02-3199	47	418-400	02-214	45	425-504	31-8089	46
385-649	27-8521	660	405-630	17-10238	429	417-048	02-3151	47	418-418	02-217	45	425-512	31-8088	46
385-653	27-11832	640	405-654	17-2947	432	417-055	02-3152	47	418-418	02-200	45	425-520	31-8491	46
385-658	27-8221	642	410-019	17-1202	39	417-063	02-3154	47	418-426	02-207	45	425-524	31-8087	46
385-690	27-11831	640	410-027	17-1203	39	417-071	02-3156	47	418-426	02-211	45	425-538	31-6552	

AFTERMARKET CROSS REFERENCE



Part No.	Rotary No.	Page No.	Part No.	Rotary No.	Page No.	Part No.	Rotary No.	Page No.	Part No.	Rotary No.	Page No.	Part No.	Rotary No.	Page No.
STENS			435-299	26 - 9974	612	465-039	23 - 2732	569	485-076	23 - 12043	577	495-044	23 - 1447	556
430-120	31 - 14652	1062	435-300	26 - 12494	613	465-043	23 - 11077	569	485-078	23 - 3538	576	495-051	23 - 1448	556
430-128	31 - 10723	1060	435-303	26 - 9796	612	465-054	23 - 1484	569	485-086	23 - 3672	576	495-055	23 - 8825	556
430-144	31 - 7179	1061	435-303	26 - 9798	612	465-062	23 - 2761	569	485-094	23 - 8229	577	495-083	23 - 10770	556
430-161	31 - 9331	1060	435-305	26 - 12087	614	465-310	23 - 2763	570	485-102	23 - 1497	576	495-200	23 - 2711	556
430-165	31 - 1939	1063	435-307	26 - 9799	612	465-328	23 - 2764	570	485-110	23 - 1498	576	495-218	23 - 1444	556
430-173	31 - 7804	1063	435-307	26 - 9797	612	465-336	23 - 2750	570	485-128	23 - 3543	576	495-226	23 - 2712	556
430-173	31 - 9158	1059	435-311	26 - 9990	620	465-393	23 - 2760	570	485-136	23 - 1478	576	495-242	23 - 2715	556
430-193	31 - 8911	1059	435-315	26 - 9979	620	465-427	23 - 1489	570	485-144	23 - 3545	575	495-259	23 - 2716	556
430-210	31 - 12624	1065	435-325	31 - 14222	1072	465-435	23 - 2760	570	485-151	23 - 3546	575	495-267	23 - 2713	556
430-220	31 - 7015	1060	435-327	26 - 9813	618	465-443	23 - 1491	570	485-169	23 - 3547	575	495-275	23 - 8561	556
430-223	31 - 6662	1059	435-331	26 - 10262	617	465-450	23 - 2762	570	485-177	23 - 8414	575	495-507	23 - 2956	557
430-249	31 - 8601	1063	435-331	26 - 12281	616	465-500	23 - 2759	570	485-185	23 - 7781	577	495-622	23 - 8421	557
430-249	31 - 1931	1061	435-351	26 - 9981	620	465-674	23 - 9785	570	485-193	23 - 6525	576	495-630	23 - 8422	557
430-280	31 - 9655	1060	435-355	26 - 9980	620	465-678	23 - 9838	570	485-219	23 - 3673	575	495-703	23 - 11989	557
430-300	31 - 9369	1064	435-3710	26 - 10561	615	465-682	23 - 9786	570	485-235	23 - 6531	575	495-707	23 - 11990	557
430-334	31 - 11822	1059	435-3750	26 - 10683	615	465-758	23 - 13514	570	485-243	23 - 7946	575	495-711	23 - 11991	557
430-401	31 - 11470	1065	435-431	31 - 10771	1071	470-005	23 - 1401	582	485-276	23 - 7942	575	50-441	23 - 13510	569
430-401	31 - 9657	1064	435-431	31 - 3319	1071	470-013	23 - 1402	582	485-326	22 - 12933	534	500-009	23 - 6794	561
430-405	31 - 9660	1066	435-435	31 - 10772	1071	470-021	23 - 1403	582	485-334	23 - 7943	575	500-009	23 - 1453	558
430-409	31 - 9658	1066	435-479	26 - 9976	617	470-037	23 - 8228	582	485-342	23 - 6521	575	500-009	23 - 7213	557
430-413	31 - 9663	1066	435-479	26 - 9977	616	470-039	23 - 1404	582	485-359	23 - 6526	575	500-017	23 - 1461	558
430-413	31 - 9663	1066	435-487	26 - 9975	618	470-047	23 - 3530	582	485-383	23 - 6523	576	500-025	23 - 2475	558
430-413	31 - 9663	1066	435-491	26 - 9812	618	470-088	23 - 7246	582	485-391	23 - 7939	577	500-033	23 - 1452	558
430-445	31 - 12685	1060	435-495	26 - 9802	617	470-232	23 - 13650	584	485-417	23 - 3542	580	500-058	23 - 1462	558
430-445	31 - 7015	1060	435-503	26 - 9814	619	470-310	23 - 3533	583	485-425	23 - 3556	580	500-066	23 - 1463	558
430-457	31 - 14291	1067	435-511	26 - 9997	617	470-328	23 - 3534	583	485-433	23 - 3557	580	500-074	23 - 1466	558
430-465	31 - 12327	1059	435-535	26 - 9218	628	470-401	23 - 3650	583	485-585	05 - 7255	93	500-082	23 - 2479	558
430-488	31 - 6888	1069	435-535	26 - 9219	628	470-419	23 - 3651	583	485-656	23 - 6971	576	500-090	23 - 6773	558
430-492	31 - 13278	1069	435-563	31 - 10295	1080	470-427	23 - 3652	583	485-672	23 - 8414	575	500-108	23 - 6772	559
430-496	31 - 8910	1059	435-611	26 - 10976	621	470-435	23 - 3653	583	485-680	38 - 1542	1194	500-116	23 - 6774	559
430-500	31 - 2946	85	435-615	26 - 10982	621	470-443	23 - 3531	583	485-706	23 - 3551	579	500-124	23 - 2476	559
430-504	31 - 1930	1063	435-627	26 - 10975	621	470-450	23 - 3532	583	485-714	23 - 1501	579	500-132	23 - 8946	559
430-508	31 - 7675	1064	435-711	33 - 9359	1097	475-004	23 - 2733	581	485-722	23 - 3552	579	500-140	23 - 8827	559
430-512	31 - 1931	1061	435-711	33 - 10408	1097	475-012	23 - 2734	581	485-748	23 - 1522	579	500-152	23 - 8795	558
430-520	31 - 6545	1061	435-803	26 - 10562	629	475-016	23 - 8225	581	485-755	23 - 3554	579	500-156	23 - 8790	559
430-538	31 - 2922	1062	435-811	26 - 10084	628	475-020	23 - 2735	581	485-789	23 - 1449	579	500-177	23 - 8794	558
430-559	31 - 14248	1065	435-815	26 - 9354	629	475-042	23 - 2734	581	485-805	23 - 7801	578	500-229	23 - 11290	559
430-602	31 - 10859	1071	435-819	26 - 10085	628	475-319	23 - 2739	581	485-813	23 - 7798	579	500-233	23 - 11296	559
430-670	31 - 2932	1069	435-823	26 - 9221	629	475-327	23 - 2740	581	485-839	23 - 2743	578	500-245	23 - 11302	559
430-670	31 - 2938	1068	435-827	26 - 9220	629	475-335	23 - 2741	581	485-862	23 - 3539	578	500-280	23 - 6777	562
430-674	31 - 9623	1060	435-831	26 - 9353	629	475-400	23 - 2736	581	485-866	10 - 14226	199	500-284	39 - 9923	1210
430-686	31 - 9659	1066	435-843	26 - 13338	620	475-418	23 - 2737	581	485-870	23 - 3540	578	500-298	23 - 6800	561
430-690	31 - 9664	1066	435-847	26 - 11022	628	475-426	23 - 2738	581	485-888	23 - 3541	578	500-306	23 - 1456	562
430-694	31 - 11219	1069	435-859	26 - 9854	612	480-004	23 - 1469	571	485-904	23 - 3553	578	500-314	23 - 1458	562
430-694	31 - 11218	1069	435-907	26 - 10674	613	480-012	23 - 1471	571	485-920	23 - 8797	577	500-322	23 - 1459	562
430-702	31 - 9665	1066	435-911	26 - 13643	621	480-016	23 - 13526	572	485-938	22 - 7973	534	500-355	23 - 1460	562
430-706	31 - 9654	1063	440-040	31 - 1897	1077	480-016	23 - 1471	571	485-950	23 - 11123	577	500-389	23 - 6803	561
430-770	31 - 9853	1060	440-044	31 - 14315	1077	480-020	23 - 1405	571	485-995	23 - 7966	577	500-409	39 - 9921	1210
430-785	31 - 14268	1067	440-073	31 - 1898	1077	480-024	23 - 13290	572	486-001	23 - 3544	580	500-417	39 - 9926	1211
430-954	31 - 11018	1063	440-101	31 - 12083	1077	480-028	23 - 1405	571	486-019	23 - 2974	581	500-504	23 - 1464	560
435-008	31 - 1929	1072	440-105	31 - 10462	1077	480-028	23 - 14548	572	486-035	23 - 3550	579	500-512	23 - 2954	560
435-012	26 - 12279	615	440-401	31 - 7288	1076	480-036	23 - 1469	571	486-076	23 - 2961	580	500-611	23 - 1531	557
435-020	26 - 12065	614	440-409	31 - 7287	1076	480-038	23 - 1470	571	486-118	18 - 2955	442	500-629	23 - 1532	557
435-024	31 - 10297	1080	440-417	31 - 7286	1076	480-042	23 - 1470	571	486-159	23 - 2970	580	500-637	23 - 2466	557
435-032	31 - 3319	1071	440-425	31 - 8771	1076	480-053	23 - 2747	571	486-167	23 - 2971	580	500-645	23 - 5875	557
435-040	31 - 1927	1078	440-433	31 - 9293	1076	480-057	23 - 2747	571	486-175	23 - 2972	581	500-710	23 - 2470	561
435-057	31 - 9208	1079	440-441	31 - 8051	1076	480-079	23 - 1406	571	486-191	23 - 2973	581	500-728	23 - 2471	561
435-061	31 - 10293	1078	440-445	31 - 11578	1076	480-083	23 - 1406	571	486-255	23 - 8226	575	500-736	23 - 2472	561
435-065	31 - 7935	1072	440-465	31 - 8786	1074	480-087	23 - 8951	571	486-340	23 - 7173	577	500-744	23 - 2473	561
435-065	31 - 7934	1072	440-505	31 - 8693	1078	480-091	23 - 8951	571	486-365	23 - 7963	576	500-769	23 - 6805	561
435-081	31 - 8969	1079	445-015	23 - 1437	586	480-149	23 - 9261	571	486-385	23 - 7941	576	500-777	23 - 6806	562
435-097	31 - 3319	1071	445-039	23 - 11812	586	480-319	23 - 2755	573	486-385	23 - 7963	576	500-785	23 - 6807	562
435-099	31 - 8943	1071	445-049	23 - 1440	586	480-323	23 - 2755	573	486-507	23 - 13517	578			



AFTERMARKET CROSS REFERENCE

**2014
AFTERMARKET REF.**

Part No.	Rotary No.	Page No.	Part No.	Rotary No.	Page No.	Part No.	Rotary No.	Page No.	Part No.	Rotary No.	Page No.	Part No.	Rotary No.	Page No.
STENS			520-702	22-13192	547	605-238	39-3108	489	615-021	38-3667	1191	615-570	38-8342	1197
505-206	23-1519	568	520-718	22-13195	547	605-246	39-3109	489	615-037	22-11155	546	615-574	38-13638	1196
505-210	23-8822	567	520-722	22-13194	547	605-250	39-10778	488	615-043	22-11165	545	615-578	38-4301	1195
505-305	23-1518	568	520-726	22-13196	548	605-253	39-1548	489	615-047	22-11166	549	615-590	38-4179	1195
505-503	23-2834	568	520-730	22-13197	548	605-257	39-12516	488	615-051	22-11145	550	615-590	38-4180	1195
505-511	23-2833	568	520-734	22-13198	548	605-273	39-13138	489	615-054	38-5829	1198	615-594	38-4184	1195
505-529	23-8475	568	520-738	22-13199	548	605-283	39-13136	489	615-058	38-4186	1195	615-598	38-4186	1195
505-537	23-8473	568	520-902	22-13141	551	605-283	39-9954	489	615-058	38-8341	1197	615-609	38-4918	1189
510-016	23-1529	566	520-926	22-14110	551	605-291	39-10779	487	615-062	38-12471	1197	615-614	38-13365	1202
510-032	23-2772	566	520-934	22-13154	551	605-295	39-9955	488	615-070	38-5840	1201	615-617	38-8159	51
510-040	23-2770	566	520164	22-2884	539	605-299	39-9956	488	615-074	22-11170	546	615-641	38-8121	47
510-057	23-6757	566	520522	22-7967	538	605-337	39-13133	488	615-078	38-13293	1196	615-690	38-8123	47
510-065	23-6758	566	525-006	22-10940	536	605-341	39-13132	488	615-086	38-12996	1201	615-708	38-8157	51
510-206	23-1528	566	525-014	22-1431	537	605-357	39-13135	488	615-098	38-13097	1202	615-716	38-8160	51
510-214	23-6767	566	525-022	22-1423	537	605-361	39-9958	491	615-104	38-1544	1191	615-724	38-8161	51
510-218	23-6768	566	525-030	22-1424	537	605-377	39-12888	488	615-104	38-3644	1191	615-736	20-9477	51
510-222	23-6769	566	525-055	22-2888	537	605-381	39-12887	488	615-108	38-12998	1201	615-740	20-9478	51
510-313	23-6761	566	525-063	22-1419	537	605-402	39-3112	490	615-112	38-3667	1191	615-744	20-9479	51
510-321	23-6763	566	525-071	22-170	42	605-428	39-1567	490	615-112	38-4183	1191	615-748	20-10392	51
510-339	23-6765	566	525-079	22-10946	536	605-436	39-1568	490	615-116	22-11175	545	615-752	20-10393	51
515-007	23-2720	563	525-089	22-1420	537	605-575	39-12887	488	615-120	38-6893	1203	615-756	20-10394	51
515-015	23-2721	563	525-101	19-7778	453	605-672	27-13160	495	615-128	22-11177	545	615-760	20-10395	51
515-023	23-8826	563	525-139	22-2890	537	605-679	29-12305	494	615-132	22-11178	545	615-764	20-11510	51
515-049	23-6722	563	525-154	22-8208	532	605-687	39-12306	494	615-156	38-8105	47	615-768	20-12642	509
515-056	23-6725	563	525-162	22-8047	532	605-691	39-5907	494	615-160	38-8114	47	615-788	20-12440	509
515-064	23-8947	563	525-170	22-10943	536	605-709	27-7997	492	615-176	38-8117	47	615-792	20-9948	51
515-072	23-2723	563	525-188	22-8046	537	605-709	39-3116	494	615-180	38-8106	47	615-811	20-9478	51
515-080	23-6720	563	525-196	22-9558	533	605-717	39-12570	495	615-180	38-8110	47	615-815	38-4996	1200
515-098	23-6721	563	525-200	22-11959	533	605-725	39-5906	494	615-192	38-8102	47	615-823	38-4996	1200
515-106	23-2722	563	525-204	22-1430	538	605-733	39-5834	493	615-207	38-9199	1202	615-827	38-4996	1200
515-114	23-6723	563	525-212	22-1434	538	605-741	19-9776	492	615-211	38-3655	47	615-831	38-4302	1197
515-122	23-6726	563	525-212	22-12263	538	605-749	39-12561	494	615-214	22-11176	545	615-839	38-13292	1196
515-130	23-6742	564	525-216	22-11960	534	605-805	39-11587	494	615-216	38-12773	1201	615-843	38-5840	1201
515-148	23-6746	564	525-220	22-1543	532	605-840	39-9957	491	615-218	38-9199	1202	615-853	38-13263	1196
515-155	23-6750	564	525-228	20-9217	508	605-900	19-13394	493	615-223	22-11164	545	615-854	38-6568	1197
515-205	23-6739	564	525-232	20-9216	508	605-998	39-6511	486	615-224	38-12774	1201	615-856	38-4301	1195
515-213	23-6741	564	525-246	22-10941	536	610-006	38-3902	48	615-225	38-13391	1196	615-857	38-4182	1194
515-221	23-6745	564	525-253	22-10942	536	610-014	38-13903	501	615-227	38-13185	1202	615-858	38-4923	1195
515-239	23-6749	564	525-265	22-1434	538	610-014	38-3903	48	615-229	38-8112	47	615-859	22-11147	549
515-247	23-6747	564	525-281	22-13455	533	610-022	38-1400	48	615-237	38-8340	1197	615-860	38-4923	1195
515-254	23-6751	564	525-291	22-10944	536	610-030	38-1400	48	615-237	38-4184	1195	615-865	38-8259	1195
515-262	23-6753	564	525-303	22-2950	538	610-030	38-1399	48	615-245	38-4179	1195	615-870	38-13263	1196
515-288	23-6755	564	525-402	22-2889	538	610-038	38-9227	498	615-245	38-4180	1195	615-887	22-11163	546
515-296	23-6756	564	525-418	22-10945	536	610-048	38-1391	48	615-270	38-13415	1196	615-919	22-11168	549
515-312	23-6727	563	525-422	22-10479	534	610-055	38-3904	48	615-286	38-4184	1195	615-935	22-11148	550
515-320	23-6744	564	525-451	22-7971	532	610-063	38-3905	48	615-310	38-8115	47	615-951	22-11151	549
515-338	23-6748	564	525-489	22-10866	534	610-063	38-13903	501	615-314	38-8104	47	615-971	22-11157	549
515-354	23-8793	563	525-554	22-10475	536	610-071	38-3906	502	615-334	38-8103	47	622-068	39-4860	1213
515-362	23-8792	563	525-638	22-10863	535	610-071	38-1400	48	615-334	38-8101	47	622-076	39-4861	1213
515-446	23-11288	564	525-663	22-10474	534	610-079	20-9607	519	615-346	38-7217	1192	622-506	39-4895	1213
515-454	23-11293	564	525-675	22-7972	532	610-087	38-4995	48	615-356	38-13262	1202	623-383	39-7686	1212
515-458	23-11298	564	525-691	22-10476	534	610-087	38-18387	501	615-360	38-9297	1200	623-512	38-8129	50
515-462	23-11301	564	525-699	22-10463	536	610-087	38-14995	501	615-364	38-9298	1201	623-520	38-1555	50
515-502	23-2749	565	525-806	22-8926	533	610-089	38-14995	501	615-366	38-5839	1201	623-538	38-8126	50
520-007	22-1407	539	525-808	22-8591	533	610-089	38-18387	501	615-370	38-9244	1200	623-546	38-3662	50
520-015	22-1413	539	525-816	22-9971	534	610-089	38-4995	48	615-390	38-13420	1202	623-553	38-8127	50
520-023	22-1414	539	525-840	22-10055	537	610-093	38-9024	502	615-393	38-4301	1195	623-561	38-8130	50
520-031	22-1415	539	525-856	22-10053	533	610-101	38-9025	502	615-394	38-13185	1202	623-579	38-3656	50
520-049	22-1416	539	525-864	22-12304	533	610-121	38-5831	519	615-397	38-12470	1195	623-587	38-8131	50
520-064	22-2884	539	525-899	22-11958	533	610-125	38-9024	502	615-401	38-4301	1195	625-012	37-3002	1180
520-072	22-2885	539	525-901	22-8255	537	610-170	38-7298	500	615-405	38-4186	1195	625-087	37-3048	1180
520-080	22-10086	539	527-111	22-10931	541	610-170	38-9140	502	615-417	38-8342	1197	625-095	37-3048	1180
520-106	22-8380	529	527-986	22-10054	533	610-174	20-9146	497	615-419	38-4182	1194	625-137	37-1701	1180
520-114	22-10103	544	530-006	22-1425	528	610-174	38-9137	502	615-423	38-12773	1201	625-202	37-3012	1180
520-130	22-10873	535	530-014	22-1426	528	610-178	38-9138	502	615-435	38-4209	1194	625-208	37-13055	1181
520-167	22-14655	535	530-018											

AFTERMARKET CROSS REFERENCE



Part No.	Rotary No.	Page No.	Part No.	Rotary No.	Page No.	Part No.	Rotary No.	Page No.	Part No.	Rotary No.	Page No.	Part No.	Rotary No.	Page No.
STENS			700-401	33 - 1559	1127	750-265	32 - 1743	1090	753-111	32 - 2310	1083	780-312	41 - 8993	1229
632-018	39 - 7055	1211	700-419	33 - 1560	1127	750-299	32 - 1742	1085	753-160	32 - 2326	1083	780-320	41 - 5527	1224
632-022	39 - 9638	1209	700-518	32 - 4237	1107	750-299	32 - 1741	1085	753-178	32 - 2324	1083	780-324	41 - 5534	1226
632-026	39 - 7059	1211	700-526	32 - 4238	1107	750-307	32 - 1741	1085	753-202	32 - 2320	1083	780-340	41 - 5533	1225
632-030	39 - 9637	1209	700-534	32 - 4239	1103	750-315	32 - 9052	1091	753-210	32 - 2315	1083	780-416	41 - 7766	1228
632-034	39 - 7057	1211	700-550	33 - 1559	1127	750-323	32 - 1749	1091	753-228	32 - 2314	1083	780-420	41 - 8828	1228
632-044	39 - 9643	1210	700-558	33 - 1560	1127	750-331	32 - 9053	1091	753-236	32 - 2313	1083	780-684	41 - 5522	1223
632-056	39 - 9642	1210	700-566	33 - 1564	1127	750-356	32 - 9055	1091	753-244	32 - 2308	1083	780-688	41 - 5526	1225
632-064	39 - 7876	1208	700-574	33 - 1561	1127	750-372	32 - 1704	1091	753-251	32 - 2323	1083	785-295	23 - 6862	555
632-068	39 - 8401	1211	700-582	33 - 4013	1127	750-380	32 - 1705	1091	753-269	32 - 2325	1083	785-311	23 - 6860	555
632-080	39 - 12267	1210	700-724	33 - 9042	1128	750-414	32 - 1736	1099	753-277	32 - 2327	1083	785-329	23 - 6858	555
632-084	39 - 9641	1210	700-732	33 - 12058	1128	750-430	32 - 1733	1102	758-015	48 - 9443	1237	785-337	23 - 6852	554
632-088	39 - 9645	1208	700-740	33 - 12059	1128	750-448	32 - 9071	1102	758-175	48 - 9448	1237	785-352	23 - 6850	554
632-140	39 - 9640	1210	700-815	32 - 12614	1090	750-455	32 - 1720	1099	758-199	48 - 9446	1236	785-410	05 - 300	92
632-212	39 - 12266	1210	700-856	32 - 4230	1107	750-489	32 - 1725	1100	758-239	48 - 9408	1236	785-444	23 - 6855	554
632-344	39 - 12731	1211	700-864	32 - 4232	1107	750-497	32 - 1725	1100	758-307	48 - 9427	1236	785-568	23 - 6861	555
632-460	39 - 12815	1209	700-898	32 - 4802	1107	750-510	33 - 1745	1125	758-311	48 - 9428	1236	785-576	23 - 6859	555
635-052	39 - 7771	1214	700-906	33 - 4246	1128	750-554	32 - 1707	1096	758-315	48 - 9426	1236	785-584	23 - 6857	555
635-060	39 - 7773	1214	700-914	33 - 4246	1128	750-562	33 - 1745	1125	758-319	48 - 9430	1236	880-100	03 - 236	56
635-078	39 - 4833	1214	700-914	33 - 4282	1127	750-570	33 - 1746	1125	758-323	48 - 9431	1236	890-204	27 - 9914	643
635-110	39 - 8397	1214	700-930	32 - 4803	1107	750-588	33 - 1747	1125	758-327	48 - 9432	1236	890-244	27 - 10192	639
635-136	39 - 8396	1214	705-020	32 - 11321	1092	750-660	33 - 8502	1126	758-330	48 - 9429	1236	890200	27 - 8569	656
635-177	39 - 7769	48	705-020	32 - 8338	1092	750-660	33 - 9212	1126	758-331	48 - 9433	1236	890200	27 - 3512	655
635-177	39 - 4793	48	705-040	33 - 4817	1127	750-664	33 - 10328	1126	758-332	48 - 9437	1236	901-108	50 - 94196	1241
635-219	39 - 8399	1214	705-044	33 - 4818	1127	750-664	33 - 10909	1126	758-333	48 - 9441	1236	901-116	50 - 94195	1241
635-227	39 - 4795	48	705-048	33 - 4819	1127	750-668	33 - 10346	1126	758-335	48 - 9434	1236	954-0439	12 - 9119	234
635-235	39 - 8324	48	705-103	33 - 4242	1125	750-672	32 - 9551	1098	758-339	48 - 9435	1236			
635-243	39 - 8398	1214	705-111	33 - 4241	1125	750-672	32 - 7763	1098	758-343	48 - 9436	1236			
635-268	39 - 4830	1214	705-129	33 - 4240	1125	750-676	33 - 7762	1126	758-351	48 - 9438	1236			
635-292	39 - 4796	48	705-149	32 - 10798	1106	750-676	33 - 9215	1126	758-355	48 - 9439	1236			
635-293	39 - 4796	48	705-165	32 - 10803	1106	750-760	32 - 12800	1111	758-359	48 - 9440	1236			
635-300	39 - 8323	48	705-169	32 - 10802	1106	750-810	32 - 5827	1096	758-363	48 - 9442	1236			
635-304	39 - 6440	1214	705-169	32 - 10804	1106	750-893	32 - 9027	1101	758-403	48 - 9420	1235			
635-308	39 - 9648	1214	705-173	32 - 10800	1106	750-901	32 - 9029	1101	758-563	48 - 9416	1235			
635-324	39 - 9649	1214	705-301	32 - 1563	1108	750-919	32 - 9030	1101	758-563	48 - 9414	1235			
635-375	39 - 8400	1214	705-319	32 - 4281	1108	750-943	32 - 9010	1102	758-567	48 - 9412	1235			
635-433	39 - 4792	48	705-335	32 - 4265	1107	751-032	32 - 1709	1084	758-575	48 - 9413	1235			
635-512	39 - 9630	1217	705-343	32 - 11465	1107	751-065	32 - 2346	1084	758-583	48 - 9411	1235			
635-524	39 - 7086	1217	705-343	32 - 4266	1107	751-065	32 - 2344	1084	758-591	48 - 9421	1235			
635-561	39 - 11860	1206	705-368	32 - 4260	1107	751-081	32 - 2345	1084	758-595	48 - 9419	1235			
635-717	39 - 7300	444	705-376	32 - 4271	1107	751-164	32 - 8543	1087	758-599	48 - 9422	1235			
642-045	35 - 10599	1157	705-384	32 - 4272	1107	751-164	32 - 2683	1087	758-683	48 - 9447	1237			
642-053	35 - 10609	1165	705-400	32 - 4248	1108	751-180	32 - 9073	1096	765-184	33 - 11992	1120			
642-057	35 - 10603	1157	705-400	33 - 4242	1125	751-198	32 - 9074	1095	765-188	33 - 11993	1120			
642-078	35 - 10612	1161	705-509	33 - 4221	1134	751-206	32 - 9036	1092	770-107	33 - 7761	1133			
642-086	35 - 10611	1161	705-517	33 - 4219	1134	751-222	32 - 9019	1096	770-115	33 - 6569	1130			
642-157	35 - 10603	1157	705-525	33 - 4215	1134	751-248	32 - 5895	1109	770-123	33 - 9089	1129			
645-010	36 - 4359	1176	705-533	33 - 4216	1134	751-255	33 - 1727	1128	770-127	33 - 9089	1129			
645-036	36 - 4360	1174	705-574	33 - 4218	1134	751-263	32 - 6661	1109	770-127	33 - 19088	1129			
645-135	36 - 1644	1174	705-574	33 - 8977	1134	751-271	32 - 9057	1108	770-131	33 - 11589	1129			
645-143	36 - 1646	1174	705-586	33 - 14139	1135	751-317	33 - 1728	1128	770-164	33 - 7096	1130			
645-184	36 - 1656	1174	705-608	33 - 5889	1134	751-343	32 - 9453	1115	770-172	33 - 9089	1129			
645-200	36 - 1640	1174	705-616	33 - 4223	1134	751-446	32 - 9077	1099	770-180	33 - 9098	1132			
645-226	36 - 1634	1175	705-632	33 - 4220	1134	751-589	33 - 11608	1117	770-435	33 - 12958	1133			
645-242	36 - 1660	1175	705-806	33 - 4273	1128	751-605	33 - 11612	1117	775-068	32 - 6621	574			
645-341	36 - 4355	1176	705-822	33 - 5802	1128	751-629	33 - 11606	1117	775-080	32 - 9087	1100			
645-358	36 - 1618	1174	705-822	32 - 9018	1109	751-665	33 - 9393	1120	780-007	41 - 5509	1225			
645-382	36 - 4307	1176	705-830	33 - 5801	1128	751-830	41 - 9962	1229	780-015	41 - 5506	1224			
645-444	36 - 1617	1176	705-856	32 - 9452	1113	751-909	32 - 9052	1091	780-023	41 - 5508	1225			
645-507	36 - 4381	1175	705305	32 - 1563	1108	751-949	50 - 9246	1239	780-027	41 - 5521	1225			
645-523	36 - 4396	1176	750339	32 - 4265	1107	751-994	33 - 7729	1120	780-031	41 - 5505	1224			
645-580	36 - 1680	1176	750-004	33 - 8502	1126	751-998	33 - 7729	1120	780-035	41 - 13167	1223			
645-614	36 - 4308	1176	750-008	32 - 7265	1087	751-998	33 - 9076	1119	780-049	41 - 5511	1223			
645-705	36 - 4387	1174	750-018	32 - 1754	1096	752-121	33 - 6668	1126	780-049	41 - 5503	1224			
645-739	36 - 1600	1174	750-022	32 - 7763	1098	752-178	32 - 8081	1108	780-056	41 - 5502	1224			
645-754	36 - 4391	1174	750-026	33 - 1291	1135	752-246	32 - 1755	1102	780-064	41 - 5504	1225			
645-903	36 - 1690	1177	750-030	32 - 7764	1098	752-253	32 - 9028	1103	780-088	41 - 5532	1225			
645-929	36 - 1689	1177	750-034	33 - 2677	1125	752-287	33 - 9982	1129						



AFTERMARKET CROSS REFERENCE

Part No.	Rotary No.	Page No.	Part No.	Rotary No.	Page No.	Part No.	Rotary No.	Page No.	Part No.	Rotary No.	Page No.	Part No.	Rotary No.	Page No.
SUNBELT			B1AF102	19-8332	458	B1AF99	27-7208	490	B1BR8ES	24-2553	596	B1CO76	10-1226	186
B158245	12-10831	235	B1AF104	19-9304	456	B1AM37	42-7158	1231	B1BR90	23-7211	577	B1CO77	10-1227	186
B158247	12-7436	214	B1AF105	19-7949	453	B1AM45	09-8306	146	B1BR91	23-8797	577	B1CO7787	05-7787	91
B158251	12-10783	228	B1AF106	19-9167	456	B1AM46	07-8298	107	B1CO225	10-9375	186	B1CO78	10-8187	186
B158255	12-10830	226	B1AF109	19-8279	474	B1AM91	10-6813	201	B1CO046	13-5714	264	B1CO7861	13-7861	264
B158402	12-10323	260	B1AF110	19-8328	474	B1ASB9810	15-9810	332	B1CO047	13-2188	263	B1CO7913	12-7913	242
B159398	13-9148	271	B1AF113	19-9273	456	B1AY15	10-11592	185	B1CO62	08-8196	108	B1CO7918	13-7918	263
B159398	13-9148	271	B1AF117	27-8735	485	B1AY16	31-9158	1059	B1CC010	12-12610	234	B1CO7937	13-7937	264
B159399	13-9121	270	B1AF12	39-1550	487	B1AY21	10-9520	184	B1CC111	10-11962	187	B1CO7950	09-7950	131
B159399	13-9121	270	B1AF123	19-9292	465	B1AY31	13-9121	270	B1CC1406	15-10361	341	B1CO7982	08-7982	115
B159404	13-6608	272	B1AF128	19-8903	461	B1AY32	13-9148	271	B1CC1413	15-10362	342	B1CO7983	13-7983	263
B1600020	31-9209	1080	B1AF129	19-10679	460	B1AY35	13-9376	269	B1CC1418	15-10363	342	B1CO8005	13-8005	263
B160004	31-9214	1079	B1AF13	39-3111	486	B1AY36	13-9377	269	B1CC1419	15-11479	341	B1CO8076	09-8076	141
B160011	31-9369	1064	B1AF130	19-8483	455	B1AY37	13-10128	36	B1CC1422	15-11506	341	B1CO8091	12-8091	246
B160012	31-9205	1080	B1AF131	19-8482	455	B1AY38	13-9846	269	B1CK051	38-8130	50	B1CO8092	12-8092	246
B160016	31-9210	1079	B1AF132	19-7094	453	B1AY46	13-11633	269	B1CK108	01-6577	50	B1CO8093	13-8093	277
B160016	31-9210	1079	B1AF132B	19-12936	448	B1AY47	13-11634	270	B1CK120	38-4302	1197	B1CO8188	10-8188	186
B160020	31-9209	1080	B1AF138	19-8480	455	B1AY48	13-11632	269	B1CK170	38-5829	1198	B1CO8196	08-8196	108
B160020	31-9209	1080	B1AF145	39-8405	487	B1B10	39-4792	48	B1CK241	38-6893	1203	B1CO8210	09-8210	137
B160025	31-7015	1060	B1AF15	39-6511	486	B1B109069	26-9362	627	B1CK250	38-7218	1198	B1CO8211	09-8211	148
B160025	31-12685	1060	B1AF171	19-9506	464	B1B11S	39-4796	48	B1CK45	22-7967	538	B1CO8214	07-8214	105
B160049	31-8911	1059	B1AF171	19-9506	464	B1B13	39-4795	48	B1CK47	22-7971	532	B1CO8215	07-8215	105
B165050	33-5801	1128	B1AF171B	19-12944	449	B1B14	39-4797	48	B1CK48	22-7972	532	B1CO8216	07-8216	105
B168210	36-1689	1177	B1AF172	19-9168	454	B1B4LM	24-1294	594	B1CK97	22-8380	529	B1CO8224	07-8224	105
B170501	33-1562	1127	B1AF173	19-9611	464	B1B6HS	24-2536	594	B1CK99	22-7968	538	B1CO8240	09-8240	148
B170504	33-1559	1127	B1AF173	19-9611	464	B1B6L	24-2526	594	B1CKMR7A	24-9593	596	B1CO8244	07-8244	105
B172000	27-9067	485	B1AF179	19-9592	454	B1B8	39-4791	48	B1CO100	42-7097	1231	B1CO8266	05-8266	91
B1720010	27-9181	655	B1AF19	39-3108	489	B1B8HS	24-2552	594	B1CO108	07-8299	106	B1CO8276	05-8276	91
B172004	20-9607	519	B1AF20	39-3105	489	B1BB100	27-4400	425	B1CO109	07-8300	106	B1CO8304	10-8304	175
B172069	27-9686	76	B1AF200	19-9550	459	B1BB107	27-5957	425	B1CO111	20-9147	497	B1CO8318	09-8318	139
B172102	27-9496	76	B1AF201B	19-9728	468	B1BB113	27-4413	425	B1CO130	13-2186	267	B1CO8319	09-8319	139
B172195	27-9272	661	B1AF204	19-9583	468	B1BB116	27-7855	425	B1CO135	13-5991	272	B1CO8343	10-8343	175
B173013	27-9394	661	B1AF205	19-9841	465	B1BB156	27-7862	425	B1CO136	13-2187	272	B1CO8372	10-8372	175
B180505	33-1564	1127	B1AF206	19-9591	454	B1BB159	27-5959	425	B1CO137	13-2185	272	B1CO8373	13-8373	264
B19378	13-9378	275	B1AF206	19-9591	454	B1BB178	27-4278	425	B1CO142A	13-5989	290	B1CO84	08-3276	112
B19379	13-9379	275	B1AF208	19-2838	456	B1BB179	27-4279	425	B1CO150	12-5242	242	B1CO8418	10-8418	177
B1A305	25-1305	603	B1AF208	19-9953	461	B1BB180	27-4280	425	B1CO151	12-5241	242	B1CO8434	09-8434	141
B1A401	25-1301	603	B1AF21	39-1548	489	B1BB4414	27-4414	425	B1CO152	12-5823	242	B1CO8485	09-8485	142
B1A40115	25-1308	603	B1AF210	19-10304	456	B1BB7857	27-7857	425	B1CO155	12-6969	242	B1CO85	08-8197	111
B1A402	25-1302	603	B1AF210	19-13629	449	B1BB8459	27-8459	425	B1CO157	12-6836	242	B1CO8503	10-8503	171
B1A40215	25-1309	603	B1AF211	19-10184	456	B1BCPR6ES	24-8554	594	B1CO16	10-1191	175	B1CO8550	08-8550	111
B1A403	25-1303	603	B1AF211B	19-12943	448	B1BE21	09-8351	131	B1CO161	12-5233	257	B1CO8577	08-8577	109
B1A40315	25-1310	603	B1AF213	19-10263	455	B1BM4A	24-2523	594	B1CO167	12-5867	246	B1CO8579	08-8579	109
B1A404	25-1304	603	B1AF214	19-10313	465	B1BM6A	24-1295	594	B1CO17	09-3217	134	B1CO8580	08-8580	109
B1A40415	25-1311	603	B1AF215	19-9591	454	B1BM6F	24-1289	594	B1CO172	12-5237	242	B1CO8581	08-8581	109
B1A406	25-1313	603	B1AF217	19-10398	465	B1BM7A	24-2500	594	B1CO173	12-5238	242	B1CO8587	13-8587	285
B1A427	25-5810	603	B1AF228	19-9583	468	B1BMR4A	24-5854	595	B1CO180	12-5235	254	B1CO86	09-8586	141
B1A428	25-1300	603	B1AF23	39-3109	489	B1BMR6A	24-2537	595	B1CO184	12-7648	216	B1CO8651	10-8651	180
B1AC08	31-9667	1069	B1AF230	19-9748	477	B1BPM6A	24-2501	595	B1CO185	12-7634	216	B1CO8652	10-8652	180
B1AC100	32-5885	1109	B1AF280	19-6567	463	B1BPM7A	24-2533	595	B1CO185	12-7790	254	B1CO8653	10-8653	180
B1AC1012	32-9238	1088	B1AF285	19-9584	464	B1BPM7Y	24-7892	595	B1CO186	12-7791	254	B1CO8654	09-8654	144
B1AC11	31-9654	1063	B1AF285	19-9584	464	B1BPMR7A	24-5850	595	B1CO199	10-2910	161	B1CO8671	10-8671	161
B1AC115	33-6569	1130	B1AF286	19-9585	464	B1BPR5ES	24-2538	595	B1CO200	20-2235	514	B1CO8684	08-8684	114
B1AC12	20-6965	515	B1AF286	19-9585	464	B1BPR6ES	24-2539	595	B1CO201	10-2222	158	B1CO8694	08-8694	123
B1AC1208	32-8543	1087	B1AF288	19-9852	465	B1BR1	31-7286	1076	B1CO202	05-8099	90	B1CO8711	12-8711	250
B1AC127	33-1728	1128	B1AF29	39-1568	490	B1BR11	31-9207	1080	B1CO206	42-8250	1231	B1CO8714	12-8714	255
B1AC132	33-1727	1128	B1AF30	39-3112	490	B1BR130	26-9796	612	B1CO222	12-7789	254	B1CO8717	12-8717	250
B1AC152	31-7935	1072	B1AF31	39-1567	490	B1BR131	26-9797	612	B1CO24	31-9657	1064	B1CO8731	12-8731	248
B1AC154	31-8943	1071	B1AF313	19-7714	465	B1BR132	26-9354	629	B1CO25	09-5721	146	B1CO8747	12-8747	238
B1AC155	29-8192	666	B1AF38	39-3114	491	B1BR135	26-9799	612	B1CO254	09-7839	143	B1CO8760	12-8760	250
B1AC16	31-8596	1058	B1AF41	39-5834	493	B1BR135	26-9799	612	B1CO26	09-5707	147	B1CO8761	12-8761	232
B1AC161	31-10772	1071	B1AF42	39-5837	493	B1BR15	23-7781	577	B1CO28	12-9257	246	B1CO8767	12-8767	257
B1AC17	20-7730	510	B1AF44	39-5906	494	B1BR16	31-9204	1078	B1CO300	10-2224	172	B1CO8768	12-8768	257
B1AC18	10-9910	164	B1AF45	39-8283	494	B1BR19	22-8047	532	B1CO302	10-6886	175	B1CO8798	12-8798	260
B1AC20	10-9911	164	B1AF46	39-3116	494	B1BR2	31-7287	1076	B1CO32	09-5703	147	B1CO8805	12-8805	246
B1AC21	03-8800	57	B1AF47	39-5907	494	B1BR26	23-8789	584	B1CO33	09-8305	147	B1CO8808	12-8808	242
B1AC229	09-7162	134	B1AF50	39-8334	486	B1BR28	23-6758	566	B1CO34	09-5713	147	B1CO8809	12-8809	242
B1AC229	09-10303	135	B1AF52	39-6988	486	B1BR29	23-6757	566	B1CO344	10-8190	175	B1CO8810	12-8810	242
B1AC24	10-9912	164	B1AF53	27-7207	493	B1BR3	31-7288	1076	B1CO345	10-2238	175	B1CO8811	12-8811	242
B1AC26	10-9912	164	B1AF54	27-7679	491	B1BR30	23-7945	575	B1CO38	10-81				

AFTERMARKET CROSS REFERENCE



Part No.	Rotary No.	Page No.	Part No.	Rotary No.	Page No.	Part No.	Rotary No.	Page No.	Part No.	Rotary No.	Page No.	Part No.	Rotary No.	Page No.
SUNBELT			B1FF172	38 - 1399	48	B1KO15	23 - 6765	566	B1MT97	12 - 9932	234	B1RS21	10 - 8549	184
B1DC28	10 - 9950	189	B1FF173	38 - 3904	48	B1KO42	31 - 9208	1079	B1MT97	12 - 7590	216	B1RS25	10 - 8479	184
B1DC29	10 - 10081	175	B1FF174	38 - 1391	48	B1KO8473	23 - 8473	568	B1MT99	12 - 10100	236	B1RS30	10 - 8548	184
B1DC51	12 - 10024	243	B1FF175	38 - 4971	519	B1KO8474	23 - 8474	568	B1MTD92	03 - 9855	61	B1RS35	10 - 7782	182
B1DC52	12 - 10025	243	B1FF176	38 - 4972	519	B1KO8475	23 - 8475	568	B1MTSB9159	10 - 9159	174	B1RS4	02 - 9373	53
B1DC53	12 - 10026	243	B1FF177	38 - 5831	519	B1L155A26	38 - 3668	51	B1MU100	13 - 9543	283	B1RS43	12 - 9336	223
B1DC54	12 - 10027	243	B1FF178	27 - 7159	498	B1L16B247	38 - 3664	51	B1MU12	12 - 6876	237	B1RS46	09 - 8507	133
B1DC55	12 - 10031	243	B1FF179	19 - 6677	483	B1L34216	38 - 3655	47	B1MU120	12 - 8972	238	B1RS47	10 - 11590	185
B1DC56	12 - 10032	244	B1FF180	19 - 5909	483	B1LB15	31 - 1898	1077	B1MU122	12 - 5023	211	B1RS49	10 - 11591	185
B1DC57	12 - 10030	243	B1FF181	19 - 6681	483	B1LB40	31 - 1897	1077	B1MU122	12 - 7445	214	B1RS5	02 - 9374	53
B1DC58	12 - 10022	243	B1FF182	38 - 1400	48	B1LB53	05 - 3271	89	B1MU123	12 - 5087	212	B1RS54	12 - 8465	222
B1DC59	12 - 5210	213	B1FF203	38 - 7298	500	B1LB80	20 - 7236	508	B1MU123	12 - 7497	215	B1RS60	10 - 8648	200
B1DC59	12 - 10029	243	B1FF298	38 - 3905	48	B1LDG2HU	38 - 3667	1191	B1MU124	12 - 5128	212	B1RY22	27 - 10206	658
B1DC59	12 - 7628	216	B1FF299	38 - 3906	502	B1LRK14HU	38 - 4183	1191	B1MU124	12 - 6508	238	B1SB1	01 - 1	39
B1DC60	12 - 10033	244	B1FF8528	27 - 8528	492	B1LRK23HS	38 - 3644	1191	B1MU124	12 - 7538	215	B1SB10	01 - 10	41
B1DC61	12 - 10034	244	B1FF8533	27 - 8533	496	B1MT100	12 - 6841	233	B1MU125	12 - 6509	238	B1SB1006	15 - 1006	410
B1DC62	12 - 10035	243	B1FFH4	33 - 9042	1128	B1MT101	12 - 6842	236	B1MU125	12 - 7526	215	B1SB10066	15 - 10066	390
B1DC62	12 - 5124	212	B1FFP109	08 - 9804	108	B1MT102	12 - 6843	233	B1MU125	12 - 5116	212	B1SB1008	15 - 1008	410
B1DC62	12 - 7534	215	B1FFP112	08 - 8551	111	B1MT102	12 - 7522	215	B1MU126	12 - 5063	212	B1SB1009	15 - 1009	336
B1DC63	12 - 10036	244	B1FFP113	33 - 10166	1133	B1MT103	12 - 6844	233	B1MU126	12 - 7473	215	B1SB1010	15 - 1010	336
B1DC63	12 - 6648	213	B1G106B	33 - 4282	1127	B1MT104	12 - 6845	235	B1MU126	12 - 7245	238	B1SB1011	15 - 1011	409
B1DC63	12 - 7651	216	B1G6825	12 - 7468	215	B1MT105	12 - 7580	216	B1MU127	12 - 5110	212	B1SB1012	15 - 1012	410
B1DC64	12 - 10010	244	B1G6880	12 - 7523	215	B1MT105	12 - 6906	233	B1MU127	12 - 7520	215	B1SB10125	01 - 10125	37
B1DC65	12 - 10011	244	B1G6953	12 - 7598	216	B1MT106	12 - 5165	213	B1MU127	12 - 7672	238	B1SB10131	13 - 10131	36
B1DC73	09 - 9606	143	B1G6980	12 - 7625	216	B1MT106	12 - 6907	235	B1MU128	12 - 7534	215	B1SB1014	15 - 1014	382
B1DX1600	15 - 1066	345	B1GA187	22 - 7973	534	B1MT106	12 - 7583	216	B1MU128	12 - 5124	212	B1SB1015	15 - 1015	382
B1DX1601	15 - 6086	345	B1GA287	39 - 7686	1212	B1MT107	12 - 7592	216	B1MU128	12 - 7673	238	B1SB1016	15 - 1016	382
B1DX51	12 - 5227	213	B1GA728	23 - 7941	576	B1MT107	12 - 5174	213	B1MU129	12 - 8442	238	B1SB1017	15 - 1017	383
B1DX51	12 - 7644	216	B1GA784	23 - 7965	576	B1MT107	12 - 6908	235	B1MU130	12 - 8443	238	B1SB10172	15 - 10172	318
B1E7082521	27 - 12501	76	B1GA936	23 - 7966	577	B1MT108	12 - 7510	215	B1MU130	12 - 7524	215	B1SB1018	15 - 1018	383
B1EC21	27 - 4299	659	B1GH25	09 - 10303	135	B1MT108	12 - 5100	212	B1MU130	12 - 5114	212	B1SB1019	15 - 1019	329
B1EC23	39 - 6985	485	B1GI53	07 - 6915	105	B1MT108	12 - 6949	235	B1MU131	12 - 7490	215	B1SB1020	15 - 1020	329
B1EC24	27 - 8585	485	B1GND1	38 - 4210	1200	B1MT109	12 - 6950	233	B1MU131	12 - 5080	212	B1SB1026	15 - 1026	386
B1EC28	20 - 7999	515	B1GR03	32 - 4237	1107	B1MT109	12 - 7435	214	B1MU131	12 - 8444	238	B1SB10269	27 - 10269	485
B1EC60	27 - 7160	485	B1GR04	32 - 4239	1103	B1MT109	12 - 5013	211	B1MU132	12 - 7538	215	B1SB1030	15 - 1030	340
B1EC90	27 - 10759	485	B1GR06	32 - 4238	1107	B1MT11	09 - 7836	144	B1MU132	12 - 5128	212	B1SB1033	15 - 1033	358
B1EHP1000	15 - 1020	329	B1HO14	18 - 9578	441	B1MT113	12 - 9480	236	B1MU133	12 - 5121	212	B1SB1036	15 - 1036	337
B1EHP1011	15 - 6189	332	B1HO63	18 - 9577	441	B1MT126	13 - 10186	282	B1MU133	12 - 6502	237	B1SB104	02 - 104	40
B1EHP1020	15 - 6262	332	B1HN17	22 - 10463	536	B1MT17	10 - 7155	197	B1MU133	12 - 7531	215	B1SB1043	15 - 1043	331
B1EL1400	15 - 10373	370	B1HN18	22 - 10475	536	B1MT18	09 - 7720	144	B1MU134	12 - 5115	212	B1SB1044	15 - 1044	333
B1EM101	10 - 10353	190	B1HN35	03 - 10118	59	B1MT20	05 - 11512	71	B1MU134	12 - 7525	215	B1SB1053	15 - 1053	395
B1EM105	10 - 10307	156	B1HN47	03 - 10120	72	B1MT20	05 - 8309	88	B1MU134	12 - 9481	238	B1SB1057	15 - 1057	379
B1EM1850	15 - 9988	349	B1HN48	03 - 10122	68	B1MT200	17 - 7810	429	B1MU138	12 - 9995	238	B1SB1058	15 - 1058	372
B1EM1851	15 - 10071	351	B1HN49	03 - 10124	68	B1MT205	17 - 9815	429	B1MU150	10 - 9906	182	B1SB1060	15 - 1060	403
B1EM1852	15 - 9882	355	B1HN71	03 - 10119	71	B1MT21	03 - 7717	60	B1MU21	12 - 6504	237	B1SB1065	15 - 1065	360
B1EM1870	15 - 11770	350	B1HN72	03 - 10121	72	B1MT30	03 - 9840	61	B1MU22	12 - 6903	237	B1SB1066	15 - 1066	345
B1EM1872	15 - 11774	350	B1HN73	03 - 10123	68	B1MT300	17 - 6626	428	B1MU23	12 - 7489	215	B1SB1074	15 - 1074	356
B1EM1874	15 - 11778	352	B1HN75	26 - 9998	624	B1MT303	17 - 7119	429	B1MU24	12 - 6904	238	B1SB1076	15 - 1076	398
B1EM1876	15 - 11782	354	B1HN76	26 - 9985	623	B1MT304	10 - 8313	161	B1MU25	12 - 6505	237	B1SB1077	15 - 1077	381
B1EM1878	15 - 11786	354	B1HO12	20 - 9603	513	B1MT305	10 - 8314	161	B1MU2601	15 - 2013	392	B1SB1085	15 - 1085	393
B1EM1879	15 - 11790	355	B1HO14	18 - 10272	441	B1MT31	10 - 8295	162	B1MU2628	15 - 6166	391	B1SB1087	15 - 1087	402
B1EM27	10 - 10013	176	B1HO14	18 - 9578	441	B1MT32	10 - 8967	197	B1MU2629	15 - 6491	321	B1SB1089	15 - 1089	346
B1EM99	12 - 12237	245	B1HO20	20 - 8899	516	B1MT326	12 - 11820	228	B1MU2629	15 - 6113	389	B1SB1091	15 - 1091	403
B1EP1027	15 - 6495	329	B1HO63	18 - 9577	441	B1MT345	12 - 10901	228	B1MU2631	15 - 6129	391	B1SB1092	15 - 1092	403
B1EP1040	15 - 10377	329	B1HS1001	15 - 10371	369	B1MT39	03 - 9132	60	B1MU39	13 - 3317	284	B1SB1093	15 - 1093	393
B1EP1050	15 - 11180	331	B1HS1003	15 - 10372	370	B1MT401	13 - 12276	273	B1MU43	12 - 4998	237	B1SB1098	15 - 1098	403
B1EP150	09 - 9747	137	B1HU50	25 - 7290	605	B1MT402	13 - 12277	273	B1MU48	10 - 6890	182	B1SB11	01 - 11	41
B1EP50	12 - 10078	223	B1IG32	39 - 7777	1070	B1MT41	03 - 9133	60	B1MU50	09 - 2892	145	B1SB110	02 - 110	40
B1EP51	12 - 10008	223	B1IG5	24 - 6710	599	B1MT42	03 - 9134	60	B1MU52	10 - 7765	197	B1SB1100	15 - 1100	345
B1EP52	12 - 10077	224	B1IG72	32 - 1754	1096	B1MT45	10 - 8950	181	B1MU53	13 - 7991	284	B1SB1103	15 - 1103	402
B1EP53	12 - 10076	224	B1IG73	31 - 4720	1070	B1MT57	10 - 9145	194	B1MU54	10 - 8320	198	B1SB1108	15 - 1108	407
B1EP54	12 - 10005	224	B1IH91	18 - 8284	442	B1MT59	13 - 9708	281	B1MU55	07 - 10087	106	B1SB1116	15 - 1116	399
B1EP56	12 - 9964	224	B1JD1044	15 - 10291	373	B1MT59	13 - 9708	281	B1MU56	13 - 7986	284	B1SB1117	15 - 1117	399
B1EP57	12 - 8784	222	B1JD11	13 - 11207	279	B1MT60	12 - 10009	235	B1MU63	03 - 8416	63	B1SB1122	15 - 1122	389
B1EP59	12 - 9337	223	B1JD125	31 - 10723	1060	B1MT72	03 - 9131	60	B1MU67	10 - 8308	175	B1SB1124	15 - 1124	389
B1EP60	12 - 9765	222	B1JD22	13 - 10741	279	B1MT73	03 - 9130	60	B1MU69	03 - 8415	63	B1SB1126	15 - 1126	372
B1EP62	12 - 9767	223	B1JD23	13 - 10738	280	B1MT80	12 - 6839	233	B1MU7961	03 - 7961	62	B1SB1127	15 - 1127	372
B1EP63	12 - 9768	223	B1JD250	12 - 7548	215	B1MT81	12 - 6840	233	B1MU7978	13 - 7978	263	B1SB1131	15 - 1131	404
B1EP64	12 - 984													



AFTERMARKET CROSS REFERENCE

Part No.	Rotary No.	Page No.	Part No.	Rotary No.	Page No.	Part No.	Rotary No.	Page No.	Part No.	Rotary No.	Page No.	Part No.	Rotary No.	Page No.
SUNBELT			B1SB1345	20-1345	34	B1SB1471	23-1471	571	B1SB1772	31-1772	1075	B1SB2137	15-2137	328
B1SB1162	17-1162	428	B1SB1346	20-1346	34	B1SB1474	23-1474	574	B1SB1778	31-1778	1075	B1SB214	02-214	45
B1SB1167	17-1167	430	B1SB1347	20-1347	34	B1SB1478	23-1478	576	B1SB1779	31-1779	1076	B1SB2147	16-2147	424
B1SB1170	10-1170	201	B1SB1348	20-1348	508	B1SB1479	23-1479	569	B1SB178	22-178	42	B1SB2148	16-2148	423
B1SB1171	10-1171	201	B1SB1349	20-1349	46	B1SB148	02-148	43	B1SB1780	31-1780	1076	B1SB216	02-216	45
B1SB1172	10-1172	201	B1SB1350	20-1350	514	B1SB1480	23-1480	569	B1SB1781	31-1781	1077	B1SB2160	15-2160	364
B1SB1182	17-1182	431	B1SB1351	20-1351	505	B1SB1482	23-1482	569	B1SB18	01-18	44	B1SB2162	15-2162	329
B1SB1184	17-1184	431	B1SB1352	20-1352	34	B1SB1484	23-1484	569	B1SB181	22-181	530	B1SB2164	15-2164	361
B1SB1187	17-1187	39	B1SB1353	20-1353	34	B1SB1489	23-1489	570	B1SB182	22-182	530	B1SB2165	15-2165	365
B1SB1188	17-1188	39	B1SB1354	20-1354	34	B1SB149	02-149	43	B1SB183	22-183	532	B1SB2166	15-2166	392
B1SB1189	17-1189	434	B1SB1357	20-1357	46	B1SB1491	23-1491	570	B1SB184	22-184	42	B1SB2169	15-2169	400
B1SB119	02-119	41	B1SB1358	20-1358	498	B1SB1493	23-1493	576	B1SB187	22-187	530	B1SB217	02-217	45
B1SB1190	17-1190	39	B1SB1359	20-1359	515	B1SB1494	23-1494	576	B1SB188	22-188	531	B1SB2171	15-2171	412
B1SB1195	17-1195	44	B1SB136	02-136	41	B1SB1497	23-1497	576	B1SB1884	31-1884	1078	B1SB2172	15-2172	334
B1SB1196	17-1196	44	B1SB137	02-137	41	B1SB1498	23-1498	576	B1SB189	22-189	532	B1SB2173	15-2173	334
B1SB1197	17-1197	44	B1SB1374	19-1374	452	B1SB15	01-15	49	B1SB19	01-19	44	B1SB2174	15-2174	337
B1SB1198	17-1198	44	B1SB138	02-138	41	B1SB150	02-150	43	B1SB190	02-190	41	B1SB2175	13-2175	263
B1SB1199	17-1199	44	B1SB1381	19-1381	480	B1SB1501	23-1501	579	B1SB1905	31-1905	1057	B1SB2176	13-2176	263
B1SB12	01-12	43	B1SB1382	19-1382	480	B1SB1502	20-1502	505	B1SB1906	31-1906	1057	B1SB218	02-218	45
B1SB1200	17-1200	44	B1SB1383	19-1383	480	B1SB1503	20-1503	508	B1SB1908	31-1908	1057	B1SB2181	13-2181	263
B1SB1201	17-1201	44	B1SB1384	19-1384	473	B1SB1508	23-1508	567	B1SB19088	33-19088	1129	B1SB2182	13-2182	263
B1SB1202	17-1202	39	B1SB1385	19-1385	474	B1SB1509	23-1509	567	B1SB191	02-191	41	B1SB2183	13-2183	263
B1SB1203	17-1203	39	B1SB1386	19-1386	470	B1SB151	02-151	43	B1SB192	02-192	41	B1SB2189	13-2189	264
B1SB1204	17-1204	39	B1SB1387	19-1387	473	B1SB1510	23-1510	567	B1SB1927	31-1927	1078	B1SB219	04-219	85
B1SB1205	17-1205	39	B1SB1388	19-1388	472	B1SB1511	23-1511	567	B1SB1928	31-1928	1061	B1SB2190	13-2190	264
B1SB1206	17-1206	39	B1SB1389	19-1389	471	B1SB1518	23-1518	568	B1SB1929	31-1929	1072	B1SB2191	13-2191	264
B1SB1207	17-1207	39	B1SB139	02-139	41	B1SB1519	23-1519	568	B1SB193	02-193	41	B1SB2192	13-2192	264
B1SB1208	17-1208	39	B1SB1390	19-1390	479	B1SB152	02-152	43	B1SB1930	31-1930	1063	B1SB22	01-22	45
B1SB121	02-121	41	B1SB1392	19-1392	480	B1SB1522	23-1522	579	B1SB1931	31-1931	1061	B1SB2208	10-2208	174
B1SB1213	17-1213	39	B1SB1393	19-1393	480	B1SB1528	23-1528	566	B1SB1932	31-1932	1057	B1SB2209	10-2209	174
B1SB1214	17-1214	39	B1SB1394	19-1394	479	B1SB1529	23-1529	566	B1SB1933	31-1933	1057	B1SB2210	10-2210	174
B1SB1215	17-1215	39	B1SB1396	19-1396	452	B1SB153	02-153	43	B1SB1934	31-1934	1057	B1SB2211	10-2211	174
B1SB1216	17-1216	39	B1SB14	01-14	42	B1SB1531	23-1531	557	B1SB1935	31-1935	1057	B1SB2212	10-2212	174
B1SB1217	17-1217	39	B1SB140	02-140	41	B1SB1532	23-1532	557	B1SB1936	31-1936	1058	B1SB2213	10-2213	173
B1SB1218	17-1218	39	B1SB1401	23-1401	582	B1SB154	02-154	43	B1SB1937	31-1937	1058	B1SB2214	10-2214	173
B1SB1219	17-1219	39	B1SB1402	23-1402	582	B1SB1542	38-1542	1194	B1SB1938	31-1938	1058	B1SB2215	10-2215	173
B1SB122	02-122	41	B1SB1403	23-1403	582	B1SB1543	22-1543	532	B1SB1939	31-1939	1063	B1SB2216	10-2216	173
B1SB1220	17-1220	39	B1SB1404	23-1404	582	B1SB1544	38-1544	1191	B1SB194	02-194	41	B1SB2217	10-2217	174
B1SB1221	17-1221	39	B1SB1405	23-1405	571	B1SB155	02-155	43	B1SB1940	31-1940	1057	B1SB2220	17-2220	428
B1SB1237	17-1237	430	B1SB1406	23-1406	571	B1SB1556	38-1556	1190	B1SB1941	31-1941	1057	B1SB2227	21-2227	522
B1SB124	02-124	41	B1SB1407	22-1407	539	B1SB156	02-156	43	B1SB1942	31-1942	1057	B1SB2227C	21-6623	522
B1SB1248	16-1248	424	B1SB1408	22-1408	542	B1SB157	02-157	43	B1SB1943	31-1943	1057	B1SB2228	21-2228	522
B1SB125	02-125	41	B1SB1409	22-1409	544	B1SB1571	01-1571	48	B1SB1944	31-1944	1058	B1SB2228C	21-6624	522
B1SB1252	16-1252	424	B1SB141	17-141	39	B1SB158	02-158	43	B1SB1945	31-1945	1073	B1SB2229C	21-6622	522
B1SB126	02-126	41	B1SB1411	22-1411	544	B1SB159	02-159	43	B1SB1946	31-1946	1073	B1SB223	03-223	56
B1SB1261	13-1261	266	B1SB1413	22-1413	539	B1SB16	01-16	44	B1SB1947	31-1947	1073	B1SB2230	25-2230	605
B1SB1262	13-1262	285	B1SB1414	22-1414	539	B1SB160	02-160	43	B1SB1948	31-1948	46	B1SB2231	25-6780	606
B1SB1263	13-1263	285	B1SB1415	22-1415	539	B1SB16000	20-16000	499	B1SB1949	31-1949	1073	B1SB2232	20-2232	514
B1SB1264	09-1264	131	B1SB1416	22-1416	539	B1SB161	02-161	43	B1SB195	02-195	41	B1SB2233	20-2233	514
B1SB1266	09-1266	131	B1SB1419	22-1419	537	B1SB162	02-162	43	B1SB1950	31-1950	1073	B1SB2234	25-2234	605
B1SB1267	18-1267	438	B1SB1420	22-1420	537	B1SB163	02-163	43	B1SB1994	28-1994	663	B1SB2240	26-2240	628
B1SB1268	18-1268	439	B1SB1421	22-1421	544	B1SB164	02-164	44	B1SB1995	28-1995	663	B1SB2241	26-2241	608
B1SB1269	18-1269	439	B1SB1423	22-1423	537	B1SB165	02-165	44	B1SB1997	28-1997	664	B1SB2268	24-2268	599
B1SB127	02-127	41	B1SB1424	22-1424	537	B1SB166	02-166	44	B1SB1998	28-1998	664	B1SB228	03-228	62
B1SB1270	18-1270	34	B1SB1425	22-1425	528	B1SB167	02-167	44	B1SB1999	28-1999	663	B1SB2280	18-2280	440
B1SB1272	18-1272	34	B1SB1426	22-1426	528	B1SB168	02-168	44	B1SB2	01-2	39	B1SB2281	18-2281	443
B1SB1273	18-1273	439	B1SB1427	22-1427	528	B1SB17	01-17	44	B1SB20	01-20	41	B1SB2282	18-2282	443
B1SB1275	18-1275	34	B1SB1428	22-1428	528	B1SB170	22-170	42	B1SB200	02-200	45	B1SB2283	18-2283	443
B1SB1276	18-1276	444	B1SB1429	22-1429	528	B1SB1704	32-1704	1091	B1SB2000	15-2000	407	B1SB2284	18-2284	444
B1SB1277	18-1277	439	B1SB1430	22-1430	538	B1SB1705	32-1705	1091	B1SB2001	15-2001	408	B1SB2285	18-2285	442
B1SB1278	18-1278	439	B1SB1431	22-1431	537	B1SB1707	32-1707	1096	B1SB2006	15-2006	402	B1SB2286	18-2286	441
B1SB1279	18-1279	444	B1SB1434	22-1434	538	B1SB1709	32-1709	1084	B1SB2007	15-2007	401	B1SB2288	18-2288	443
B1SB128	02-128	41	B1SB1435	23-1435	586	B1SB171	22-171	42	B1SB2008	14-2008	315	B1SB2289	18-2289	443
B1SB1280	18-1280	444	B1SB1437	23-1437	586	B1SB172	22-172	42	B1SB2009	14-2009	315	B1SB229	03-229	62
B1SB1281	18-1281	444	B1SB1439	23-1439	586	B1SB1720	32-1720	1099	B1SB201	02-201	45	B1SB2290	18-2290	443
B1SB1282	18-1282	444	B1SB1440	23-1440	586	B1SB1725	32-1725	1100	B1SB2012	15-2012	390	B1SB2291	18-2291	442
B1SB1283	18-1283	440	B1SB1441	23-1441	556	B1SB1726	32-1726	1090	B1SB2013	15-2013	392	B1SB2294	18-2294	438
B1SB1284	18-1284	444	B1SB1442	23-1442	556	B1SB1729	32-1729	1102	B1SB202	02-202	45	B1SB2296	18-2296	438
B1SB1285	24-1285	600	B1SB1444	23-1444	556	B1SB1731	32-1731	1090	B1SB203	02-203	45	B1SB2297	18-2297	444
B1SB1286	18-1286	34	B1SB1445	23-1445	556	B1SB1732</								

AFTERMARKET CROSS REFERENCE



Part No.	Rotary No.	Page No.	Part No.	Rotary No.	Page No.	Part No.	Rotary No.	Page No.	Part No.	Rotary No.	Page No.	Part No.	Rotary No.	Page No.
SUNBELT			B1SB2743	23 - 2743	578	B1SB2926	13 - 2926	284	B1SB3200	09 - 3200	146	B1SB3393	15 - 3393	407
B1SB2403	02 - 2403	42	B1SB2745	23 - 2745	574	B1SB2928	13 - 2928	284	B1SB3201	09 - 3201	144	B1SB3394	15 - 3394	409
B1SB2406	02 - 2406	42	B1SB2749	23 - 2749	565	B1SB2929	13 - 2929	284	B1SB3202	09 - 3202	144	B1SB3395	15 - 3395	409
B1SB241	03 - 241	65	B1SB275	06 - 275	96	B1SB293	09 - 293	144	B1SB3205	05 - 3205	88	B1SB34	02 - 34	40
B1SB242	03 - 242	62	B1SB2750	23 - 2750	570	B1SB2931	10 - 2931	183	B1SB3207	10 - 3207	171	B1SB3400	15 - 3400	336
B1SB2422	26 - 2422	630	B1SB2753	23 - 2753	569	B1SB2932	31 - 2932	1069	B1SB3209	09 - 3209	144	B1SB3401	15 - 3401	336
B1SB2423	32 - 2324	1083	B1SB2754	23 - 2754	573	B1SB2933	10 - 2933	172	B1SB321	10 - 321	39	B1SB3402	15 - 3402	337
B1SB2424	26 - 2424	630	B1SB2755	23 - 2755	573	B1SB2934	10 - 2934	172	B1SB3211	09 - 3211	146	B1SB3403	15 - 3403	347
B1SB243	03 - 243	56	B1SB2757	23 - 2757	574	B1SB2935	09 - 2935	146	B1SB3213	09 - 3213	144	B1SB3404	15 - 3404	347
B1SB244	03 - 244	66	B1SB2758	23 - 2758	573	B1SB2936	09 - 2936	145	B1SB3216	09 - 3216	144	B1SB3405	15 - 3405	408
B1SB245	03 - 245	74	B1SB2759	23 - 2759	570	B1SB2937	10 - 2937	183	B1SB3218	10 - 3218	183	B1SB3406	15 - 3406	393
B1SB246	03 - 246	74	B1SB276	06 - 276	96	B1SB2938	31 - 2938	1068	B1SB3220	10 - 3220	183	B1SB3407	15 - 3407	384
B1SB2463	26 - 2463	630	B1SB2761	23 - 2761	569	B1SB2939	09 - 2939	144	B1SB3221	10 - 3221	172	B1SB3408	15 - 3408	381
B1SB2466	23 - 2466	557	B1SB2762	23 - 2762	570	B1SB2940	09 - 2940	147	B1SB3222	09 - 3222	146	B1SB341	08 - 5916	120
B1SB247	03 - 247	74	B1SB2770	23 - 2770	566	B1SB2941	31 - 2941	1061	B1SB3223	10 - 3223	172	B1SB342	08 - 342	118
B1SB2470	23 - 2470	561	B1SB2772	23 - 2772	566	B1SB2942	31 - 2942	1062	B1SB3227	05 - 3227	88	B1SB3421	15 - 3421	415
B1SB2471	23 - 2471	561	B1SB2773	19 - 2773	453	B1SB2947	17 - 2947	432	B1SB3228	09 - 3228	131	B1SB3423	15 - 3423	413
B1SB2472	23 - 2472	561	B1SB2774	19 - 2774	473	B1SB2950	22 - 2950	538	B1SB3229	09 - 3229	130	B1SB343	08 - 343	118
B1SB2473	23 - 2473	561	B1SB2775	19 - 2775	479	B1SB2953	05 - 2953	89	B1SB3236	13 - 3236	264	B1SB3430	15 - 3430	392
B1SB2475	23 - 2475	558	B1SB2777	19 - 2777	452	B1SB2954	23 - 2954	560	B1SB324	09 - 324	39	B1SB3434	15 - 3434	362
B1SB2476	23 - 2476	559	B1SB2778	19 - 2778	453	B1SB2955	18 - 2955	442	B1SB3240	06 - 3240	100	B1SB3437	15 - 3437	363
B1SB2479	23 - 2479	558	B1SB2779	19 - 2779	475	B1SB2956	23 - 2956	557	B1SB3242	10 - 3242	161	B1SB3438	15 - 3438	363
B1SB248	03 - 248	74	B1SB278	06 - 278	96	B1SB2957	26 - 2957	628	B1SB3244	05 - 3244	94	B1SB344	08 - 344	118
B1SB249	03 - 249	74	B1SB2780	19 - 2780	474	B1SB2958	05 - 2958	89	B1SB3245	05 - 3245	94	B1SB3441	15 - 3441	407
B1SB25	02 - 25	43	B1SB2781	19 - 2781	481	B1SB2959	26 - 2959	608	B1SB3246	05 - 3246	94	B1SB3442	15 - 3442	380
B1SB250	03 - 250	74	B1SB2782	19 - 2782	481	B1SB2961	23 - 2961	580	B1SB3247	05 - 3247	94	B1SB3443	15 - 3443	392
B1SB251	03 - 251	74	B1SB2783	19 - 2783	480	B1SB2964	10 - 2964	180	B1SB325	09 - 325	39	B1SB3445	15 - 3445	413
B1SB252	03 - 252	74	B1SB2784	19 - 2784	479	B1SB2965	06 - 2965	97	B1SB3250	02 - 3250	48	B1SB3446	15 - 3446	413
B1SB254	10 - 254	171	B1SB2784B	19 - 12934	449	B1SB2966	06 - 2966	97	B1SB3256	02 - 3256	48	B1SB3447	15 - 3447	393
B1SB2542	24 - 2542	589	B1SB2785	19 - 2785	481	B1SB2970	23 - 2970	580	B1SB3257	02 - 3257	48	B1SB345	05 - 345	92
B1SB2543	24 - 2543	589	B1SB2788	19 - 2788	452	B1SB2971	23 - 2971	580	B1SB3258	02 - 3258	48	B1SB3450	20 - 3450	43
B1SB2547	24 - 2547	589	B1SB2789	19 - 2789	455	B1SB2972	23 - 2972	581	B1SB3259	02 - 3259	48	B1SB3451	20 - 3451	43
B1SB255	05 - 255	88	B1SB279	06 - 279	97	B1SB2973	23 - 2973	581	B1SB326	09 - 326	39	B1SB3452	20 - 3452	43
B1SB2550	24 - 2550	590	B1SB2790	19 - 2790	476	B1SB2974	23 - 2974	581	B1SB3264	08 - 3264	125	B1SB3459	06 - 3459	96
B1SB2551	24 - 2551	590	B1SB2791	19 - 2791	476	B1SB2976	06 - 2976	97	B1SB3265	08 - 3265	125	B1SB346	08 - 346	122
B1SB257	04 - 257	78	B1SB2792	19 - 2792	476	B1SB2977	06 - 2977	97	B1SB3266	08 - 3266	123	B1SB3460	06 - 3460	96
B1SB258	04 - 258	78	B1SB2798	19 - 2798	478	B1SB2980	06 - 2980	97	B1SB3267	08 - 3267	123	B1SB3461	06 - 3461	96
B1SB26	02 - 26	44	B1SB2799	19 - 2799	478	B1SB2983	06 - 2983	98	B1SB3268	08 - 3268	123	B1SB3462	20 - 3462	512
B1SB261	04 - 261	78	B1SB28	02 - 28	44	B1SB2984	06 - 2984	98	B1SB3269	05 - 3269	89	B1SB3468	15 - 3468	409
B1SB262	04 - 262	78	B1SB280	07 - 280	101	B1SB2985	06 - 2985	99	B1SB327	09 - 327	39	B1SB347	08 - 347	118
B1SB263	04 - 263	78	B1SB2801	20 - 2801	499	B1SB2986	06 - 2986	99	B1SB3270	05 - 3270	89	B1SB348	08 - 348	118
B1SB264	04 - 264	78	B1SB2805	19 - 2805	461	B1SB2988	06 - 2988	98	B1SB3274	09 - 3274	134	B1SB349	08 - 349	119
B1SB2658	16 - 2658	424	B1SB2806	19 - 2806	452	B1SB2989	06 - 2989	97	B1SB3275	08 - 3275	118	B1SB35	02 - 35	40
B1SB266	04 - 266	78	B1SB2807	19 - 2807	462	B1SB2990	07 - 2990	102	B1SB328	09 - 328	133	B1SB350	08 - 350	119
B1SB2661	16 - 2661	424	B1SB2808	19 - 2808	462	B1SB2991	07 - 2991	102	B1SB329	09 - 329	39	B1SB351	08 - 351	119
B1SB2662	16 - 2662	421	B1SB2809	19 - 2809	462	B1SB2992	07 - 2992	102	B1SB33	02 - 33	40	B1SB352	08 - 352	123
B1SB2663	16 - 2663	421	B1SB281	07 - 281	101	B1SB2994	06 - 2994	98	B1SB330	09 - 330	39	B1SB353	08 - 353	123
B1SB2668	16 - 2668	423	B1SB2811	23 - 2811	567	B1SB2995	06 - 2995	98	B1SB3301	10 - 3301	171	B1SB3530	23 - 3530	582
B1SB2669	16 - 2669	423	B1SB2815	23 - 2815	567	B1SB2996	06 - 2996	98	B1SB3303	09 - 3303	146	B1SB3531	23 - 3531	583
B1SB267	04 - 267	85	B1SB282	07 - 282	101	B1SB2997	06 - 2997	98	B1SB3305	09 - 3305	146	B1SB3532	23 - 3532	583
B1SB2670	16 - 2670	423	B1SB2828	19 - 2828	463	B1SB3	01 - 3	39	B1SB3306	10 - 3306	172	B1SB3533	23 - 3533	583
B1SB2671	16 - 2671	422	B1SB2829	19 - 2829	478	B1SB300	05 - 300	92	B1SB3307	10 - 3307	161	B1SB3534	23 - 3534	583
B1SB2672	16 - 2672	422	B1SB283	07 - 283	101	B1SB301	05 - 301	93	B1SB331	09 - 331	39	B1SB3537	23 - 3537	576
B1SB2673	16 - 2673	423	B1SB2830	23 - 2830	568	B1SB302	08 - 302	118	B1SB3316	13 - 3316	285	B1SB3538	23 - 3538	576
B1SB2675	31 - 2675	1057	B1SB2833	23 - 2833	568	B1SB303	08 - 303	118	B1SB3319	31 - 3319	1071	B1SB3539	23 - 3539	578
B1SB2677	33 - 2677	1125	B1SB2834	23 - 2834	568	B1SB304	08 - 304	125	B1SB332	09 - 332	39	B1SB354	08 - 354	123
B1SB268	04 - 268	84	B1SB2838	19 - 2838	456	B1SB305	08 - 305	125	B1SB3320	07 - 3320	106	B1SB3540	23 - 3540	578
B1SB2681	23 - 2681	584	B1SB2838B	19 - 12941	448	B1SB307	05 - 307	89	B1SB3322	15 - 3322	328	B1SB3541	23 - 3541	578
B1SB2682	32 - 2682	1087	B1SB2839	19 - 2839	478	B1SB308	05 - 308	88	B1SB3323	15 - 3323	328	B1SB3542	23 - 3542	580
B1SB2683	32 - 2683	1087	B1SB2840	19 - 2840	453	B1SB309	05 - 309	88	B1SB3326	15 - 3326	328	B1SB3543	23 - 3543	576
B1SB269	04 - 269	78	B1SB2841	19 - 2841	455	B1SB31	29 - 31	666	B1SB3329	15 - 3329	337	B1SB3544	23 - 3544	580
B1SB2690	15 - 2690	329	B1SB2842	19 - 2842	481	B1SB310	10 - 310	179	B1SB3332	15 - 3332	339	B1SB3545	23 - 3545	575
B1SB2699	05 - 2699	72	B1SB2843	19 - 2843	481	B1SB311	10 - 311	39	B1SB3336	15 - 3336	393	B1SB3546	23 - 3546	575
B1SB27	02 - 27	44	B1SB2844	19 - 2844	472	B1SB312	10 - 312	39	B1SB3339	15 - 3339	361	B1SB3547	23 - 3547	575
B1SB2701	03 - 2701	74	B1SB285	06 - 285	97	B1SB313	10 - 313	39	B1SB3346	15 - 3346	372	B1SB3548	23 - 3548	575
B1SB2702	03 - 2702	74	B1SB286	06 - 286	99	B1SB314	10 - 314	39	B1SB3348	15 - 3348	375	B1SB355	08 - 355	124
B1SB2703	09 - 2703	130	B1SB287	06 - 287	96	B1SB315	10 - 315	179	B1SB3354	15 - 3354	384	B1SB3550	23 - 3550	579
B1SB271	06 - 271	99	B1SB288	06 - 288	96	B1SB3152	02 - 3152	47	B1SB3356	15 - 3356	382	B1SB3551		



AFTERMARKET CROSS REFERENCE

Part No.	Rotary No.	Page No.	Part No.	Rotary No.	Page No.	Part No.	Rotary No.	Page No.	Part No.	Rotary No.	Page No.	Part No.	Rotary No.	Page No.
SUNBELT			B1SB471	04 - 471	82	B1SB5086	12 - 5086	212	B1SB5191	12 - 5191	213	B1SB5879	13 - 5879	267
B1SB3673	23 - 3673	575	B1SB472	04 - 472	82	B1SB5087	12 - 5087	212	B1SB5192	12 - 5192	213	B1SB5880	13 - 5880	267
B1SB368	08 - 368	117	B1SB473	04 - 473	82	B1SB5088	12 - 5088	212	B1SB5193	12 - 5193	213	B1SB5881	13 - 5881	267
B1SB369	08 - 369	117	B1SB474	04 - 474	82	B1SB5089	12 - 5089	212	B1SB5194	12 - 5194	213	B1SB5882	13 - 5882	267
B1SB37	02 - 37	40	B1SB475	04 - 475	82	B1SB5090	12 - 5090	212	B1SB5195	12 - 5195	213	B1SB5883	13 - 5883	267
B1SB370	08 - 370	117	B1SB476	04 - 476	82	B1SB5091	12 - 5091	212	B1SB5196	12 - 5196	213	B1SB5884	13 - 5884	267
B1SB371	08 - 371	116	B1SB478	05 - 478	88	B1SB5092	12 - 5092	212	B1SB5197	12 - 5197	213	B1SB5885	13 - 5885	267
B1SB372	08 - 372	116	B1SB48	02 - 48	40	B1SB5093	12 - 5093	212	B1SB5198	12 - 5198	213	B1SB5886	13 - 5886	267
B1SB373	08 - 373	116	B1SB481	09 - 481	131	B1SB5094	12 - 5094	212	B1SB5199	12 - 5199	213	B1SB5887	13 - 5887	267
B1SB374	08 - 374	116	B1SB482	29 - 482	666	B1SB5095	12 - 5095	212	B1SB5200	12 - 5200	213	B1SB5890	04 - 5890	83
B1SB375	08 - 375	116	B1SB483	09 - 483	132	B1SB5096	12 - 5096	212	B1SB5201	12 - 5201	213	B1SB5894	08 - 5894	121
B1SB376	08 - 376	116	B1SB484	09 - 484	133	B1SB5097	12 - 5097	212	B1SB5202	12 - 5202	213	B1SB5896	01 - 5896	47
B1SB377	08 - 377	116	B1SB485	04 - 485	84	B1SB5098	12 - 5098	212	B1SB5203	12 - 5203	213	B1SB5897	01 - 5897	44
B1SB378	08 - 378	116	B1SB486	04 - 486	84	B1SB5099	12 - 5099	212	B1SB5204	12 - 5204	213	B1SB5898	31 - 5898	1073
B1SB379	08 - 379	116	B1SB487	09 - 487	133	B1SB5100	12 - 5100	212	B1SB5205	12 - 5205	213	B1SB5899	07 - 5899	103
B1SB38	02 - 38	40	B1SB488	04 - 488	84	B1SB5101	12 - 5101	212	B1SB5206	12 - 5206	213	B1SB59	02 - 59	38
B1SB382	09 - 382	143	B1SB489	04 - 489	84	B1SB5102	12 - 5102	212	B1SB5207	12 - 5207	213	B1SB5900	07 - 5900	103
B1SB383	11 - 383	203	B1SB49	02 - 49	40	B1SB5103	12 - 5103	212	B1SB5208	12 - 5208	213	B1SB5901	09 - 5901	103
B1SB384	11 - 384	203	B1SB490	04 - 490	84	B1SB5104	12 - 5104	212	B1SB5209	12 - 5209	213	B1SB5903	20 - 5903	43
B1SB385	11 - 385	203	B1SB4999	12 - 4999	240	B1SB5105	12 - 5105	212	B1SB5210	12 - 5210	213	B1SB5904	20 - 5904	43
B1SB386	11 - 386	203	B1SB5	01 - 5	34	B1SB5106	12 - 5106	212	B1SB5211	12 - 5211	213	B1SB5905	20 - 5905	43
B1SB387	11 - 387	203	B1SB50	02 - 50	40	B1SB5107	12 - 5107	212	B1SB5213	12 - 5213	213	B1SB5910	02 - 5910	44
B1SB388	11 - 388	203	B1SB5000	12 - 5000	211	B1SB5108	12 - 5108	212	B1SB5214	12 - 5214	213	B1SB5911	02 - 5911	44
B1SB389	11 - 389	203	B1SB5001	12 - 5001	211	B1SB5109	12 - 5109	212	B1SB5215	12 - 5215	213	B1SB5912	02 - 5912	44
B1SB39	02 - 39	40	B1SB5002	12 - 5002	211	B1SB5110	12 - 5110	212	B1SB5216	12 - 5216	213	B1SB5913	02 - 5913	44
B1SB390	11 - 390	203	B1SB5003	12 - 5003	211	B1SB5111	12 - 5111	212	B1SB5217	12 - 5217	213	B1SB5914	02 - 5914	44
B1SB3902	38 - 3902	48	B1SB5004	12 - 5004	211	B1SB5112	12 - 5112	212	B1SB5218	12 - 5218	213	B1SB5915	06 - 5915	98
B1SB3903	38 - 3903	48	B1SB5005	12 - 5005	211	B1SB5113	12 - 5113	212	B1SB5219	12 - 5219	213	B1SB5933	31 - 5933	1071
B1SB392	11 - 392	203	B1SB5006	12 - 5006	211	B1SB5114	12 - 5114	212	B1SB5220	12 - 5220	213	B1SB5934	19 - 5934	473
B1SB393	11 - 393	203	B1SB5007	12 - 5007	211	B1SB5115	12 - 5115	212	B1SB5221	12 - 5221	213	B1SB5935	17 - 5935	430
B1SB394	11 - 394	203	B1SB5008	12 - 5008	211	B1SB5116	12 - 5116	212	B1SB5222	12 - 5222	213	B1SB5941	19 - 5941	452
B1SB395	11 - 395	203	B1SB5010	12 - 5010	211	B1SB5117	12 - 5117	212	B1SB5223	12 - 5223	213	B1SB5949	13 - 5949	291
B1SB399	11 - 399	203	B1SB5011	12 - 5011	211	B1SB5118	12 - 5118	212	B1SB5224	12 - 5224	213	B1SB5950	13 - 5950	291
B1SB4	01 - 4	39	B1SB5012	12 - 5012	211	B1SB5119	12 - 5119	212	B1SB5225	12 - 5225	213	B1SB5955	19 - 5955	478
B1SB400	11 - 400	49	B1SB5013	12 - 5013	211	B1SB5120	12 - 5120	212	B1SB5226	12 - 5226	213	B1SB5961	13 - 5961	267
B1SB401	11 - 401	49	B1SB5014	12 - 5014	211	B1SB5121	12 - 5121	212	B1SB5227	12 - 5227	213	B1SB5962	13 - 5962	267
B1SB40142	16 - 6261	422	B1SB5015	12 - 5015	211	B1SB5122	12 - 5122	212	B1SB5231	12 - 5231	258	B1SB5963	13 - 5963	267
B1SB40144	16 - 6477	421	B1SB5016	12 - 5016	211	B1SB5123	12 - 5123	212	B1SB55	02 - 55	38	B1SB5964	13 - 5964	267
B1SB402	11 - 402	49	B1SB5017	12 - 5017	211	B1SB5124	12 - 5124	212	B1SB5502	41 - 5502	1224	B1SB5965	13 - 5965	267
B1SB403	11 - 403	203	B1SB5018	12 - 5018	211	B1SB5125	12 - 5125	212	B1SB5505	41 - 5505	1224	B1SB5966	13 - 5966	267
B1SB404	11 - 404	49	B1SB5019	12 - 5019	211	B1SB5126	12 - 5126	212	B1SB5506	41 - 5506	1224	B1SB5967	13 - 5967	267
B1SB405	11 - 405	203	B1SB5020	12 - 5020	211	B1SB5127	12 - 5127	212	B1SB5508	41 - 5508	1225	B1SB5968	13 - 5968	267
B1SB406	11 - 406	203	B1SB5021	12 - 5021	211	B1SB5128	12 - 5128	212	B1SB5509	41 - 5509	1225	B1SB5969	13 - 5969	267
B1SB408	11 - 408	49	B1SB5022	12 - 5022	211	B1SB5129	12 - 5129	212	B1SB5510	41 - 5510	1223	B1SB5970	13 - 5970	267
B1SB409	11 - 409	203	B1SB5023	12 - 5023	211	B1SB5130	12 - 5130	212	B1SB5512	41 - 5512	1223	B1SB5971	13 - 5971	267
B1SB41	02 - 41	39	B1SB5024	12 - 5024	211	B1SB5131	12 - 5131	212	B1SB5513	41 - 5513	1223	B1SB5973	13 - 5973	267
B1SB411	11 - 411	203	B1SB5025	12 - 5025	211	B1SB5132	12 - 5132	212	B1SB5515	41 - 5515	1224	B1SB5974	13 - 5974	267
B1SB412	11 - 412	49	B1SB5026	12 - 5026	211	B1SB5133	12 - 5133	212	B1SB5517	41 - 5517	1229	B1SB5975	13 - 5975	267
B1SB413	11 - 413	49	B1SB5027	12 - 5027	211	B1SB5150	12 - 5150	213	B1SB5518	41 - 5518	1229	B1SB5976	13 - 5976	267
B1SB414	11 - 414	49	B1SB5028	12 - 5028	211	B1SB5151	12 - 5151	213	B1SB5519	41 - 5519	1229	B1SB5977	13 - 5977	267
B1SB415	11 - 415	203	B1SB5029	12 - 5029	211	B1SB5152	12 - 5152	213	B1SB5521	41 - 5521	1225	B1SB5978	13 - 5978	267
B1SB416	11 - 416	49	B1SB5030	12 - 5030	211	B1SB5153	12 - 5153	213	B1SB56	02 - 56	38	B1SB5979	13 - 5979	267
B1SB417	11 - 417	203	B1SB5031	12 - 5031	211	B1SB5154	12 - 5154	213	B1SB5600	04 - 5600	82	B1SB5980	13 - 5980	267
B1SB418	11 - 418	203	B1SB5050	12 - 5050	212	B1SB5155	12 - 5155	213	B1SB5601	04 - 5601	82	B1SB5982	13 - 5982	267
B1SB42	02 - 42	40	B1SB5051	12 - 5051	212	B1SB5156	12 - 5156	213	B1SB5602	04 - 5602	82	B1SB5983	13 - 5983	267
B1SB420	11 - 420	49	B1SB5052	12 - 5052	212	B1SB5157	12 - 5157	213	B1SB5603	04 - 5603	82	B1SB5984	13 - 5984	267
B1SB421	11 - 421	203	B1SB5053	12 - 5053	212	B1SB5158	12 - 5158	213	B1SB57	02 - 57	38	B1SB5985	13 - 5985	267
B1SB422	05 - 422	88	B1SB5054	12 - 5054	212	B1SB5159	12 - 5159	213	B1SB5704	10 - 5704	178	B1SB5986	13 - 5986	267
B1SB423	17 - 423	434	B1SB5055	12 - 5055	212	B1SB5160	12 - 5160	213	B1SB5705	10 - 5705	178	B1SB5988	13 - 5988	290
B1SB424	17 - 424	434	B1SB5056	12 - 5056	212	B1SB5161	12 - 5161	213	B1SB5706	10 - 5706	176	B1SB5997	13 - 5997	267
B1SB4245	32 - 4245	1108	B1SB5057	12 - 5057	212	B1SB5162	12 - 5162	213	B1SB5708	10 - 5708	180	B1SB6	01 - 6	40
B1SB4248	32 - 4248	1108	B1SB5058	12 - 5058	212	B1SB5163	12 - 5163	213	B1SB5711	13 - 5711	264	B1SB60	02 - 60	38
B1SB4260	32 - 4260	1107	B1SB5059	12 - 5059	212	B1SB5164	12 - 5164	213	B1SB5712	13 - 5712	264	B1SB6000	20 - 6000	46
B1SB4265	32 - 4265	1107	B1SB5060	12 - 5060	212	B1SB5165	12 - 5165	213	B1SB58	02 - 58	38	B1SB6001	15 - 6001	412
B1SB43	02 - 43	40	B1SB5061	12 - 5061	212	B1SB5166	12 - 5166	213	B1SB5803	05 - 5803	93	B1SB6002	15 - 6002	410
B1SB430	07 - 430	106	B1SB5062	12 - 5062	212	B1SB5167	12 - 5167	213	B1SB5805	03 - 5805	65	B1SB6003	15 - 6003	382
B1SB433	06 - 433	100	B1SB5063	12 - 5063	212	B1SB5168	12 - 5168	213	B1SB5811	11 - 5811	203	B1SB6004	15 - 6004	383
B1SB435	13 - 435	666	B1SB5064	12 - 5064	212	B1SB5169	12 - 5169	213	B1SB5812	09 - 5812				

AFTERMARKET CROSS REFERENCE



Part No.	Rotary No.	Page No.	Part No.	Rotary No.	Page No.	Part No.	Rotary No.	Page No.	Part No.	Rotary No.	Page No.	Part No.	Rotary No.	Page No.
SUNBELT			B1SB6199	15 - 1022	385	B1SB6470	15 - 6470	389	B1SB6651	12 - 6651	213	B1SB6782	15 - 6782	345
B1SB6035	15 - 6035	401	B1SB62	02 - 62	38	B1SB6472	15 - 6472	400	B1SB6652	12 - 6652	213	B1SB6784	15 - 6784	346
B1SB6037	15 - 6037	331	B1SB6203	15 - 6203	361	B1SB65	02 - 65	38	B1SB6653	12 - 6653	213	B1SB6787	15 - 6787	363
B1SB6038	15 - 6038	332	B1SB6204	15 - 6204	361	B1SB6500	15 - 6500	366	B1SB6654	12 - 6654	213	B1SB6790	15 - 6790	343
B1SB6039	15 - 6039	391	B1SB6205	15 - 6205	329	B1SB6502	12 - 6502	237	B1SB6655	12 - 6655	213	B1SB6793	17 - 6793	432
B1SB6044	14 - 6044	314	B1SB6207	15 - 6207	379	B1SB6503	12 - 6503	237	B1SB6657	03 - 6657	56	B1SB6794	23 - 6794	561
B1SB6045	14 - 6045	314	B1SB6208	15 - 6208	377	B1SB6507	12 - 6507	237	B1SB6658	03 - 6658	56	B1SB6795	23 - 6795	561
B1SB6046	14 - 6046	314	B1SB6210	15 - 6210	416	B1SB6508	12 - 6508	238	B1SB6659	19 - 6659	475	B1SB6796	23 - 6796	561
B1SB6052	14 - 6052	314	B1SB6213	15 - 6213	361	B1SB6509	12 - 6509	238	B1SB6660	19 - 6660	475	B1SB6797	23 - 6797	561
B1SB6053	14 - 6053	314	B1SB6214	15 - 6214	360	B1SB6510	18 - 6510	442	B1SB6662	31 - 6662	1059	B1SB6799	23 - 6799	561
B1SB6060	15 - 6060	328	B1SB6215	15 - 6215	392	B1SB6513	09 - 6513	133	B1SB6663	33 - 6663	1130	B1SB68	02 - 68	44
B1SB6066	15 - 6066	338	B1SB6216	15 - 6216	352	B1SB6514	19 - 6514	454	B1SB6670	10 - 6670	163	B1SB6800	23 - 6800	561
B1SB6069	15 - 6069	338	B1SB6217	15 - 6217	351	B1SB6515	19 - 6515	479	B1SB6671	10 - 6671	163	B1SB6801	23 - 6801	562
B1SB6077	15 - 6077	343	B1SB6218	15 - 6218	331	B1SB6516	19 - 6516	473	B1SB6672	10 - 6672	163	B1SB6802	23 - 6802	561
B1SB6081	15 - 6081	340	B1SB6219	15 - 6219	330	B1SB6517	19 - 6517	463	B1SB6673	26 - 6673	608	B1SB6803	23 - 6803	561
B1SB6083	15 - 6083	344	B1SB6220	15 - 6220	332	B1SB6518	19 - 6518	463	B1SB6675	06 - 6675	100	B1SB6804	23 - 6804	562
B1SB6083R	15 - 6083	344	B1SB6221	15 - 6221	374	B1SB6519	19 - 6519	463	B1SB6676	19 - 6676	483	B1SB6805	23 - 6805	561
B1SB6084	15 - 6084	346	B1SB6224	15 - 6222	372	B1SB6521	23 - 6521	575	B1SB6678	19 - 6678	483	B1SB6806	23 - 6806	562
B1SB6086	15 - 6086	345	B1SB6223	15 - 6223	373	B1SB6522	23 - 6522	582	B1SB6684	19 - 6684	461	B1SB6807	23 - 6807	562
B1SB6087	15 - 6087	345	B1SB6224	15 - 6224	343	B1SB6523	23 - 6523	576	B1SB6686	19 - 6686	461	B1SB6815	31 - 6815	45
B1SB6088	15 - 6088	345	B1SB6228	15 - 6228	396	B1SB6524	19 - 6524	451	B1SB6687	19 - 6687	461	B1SB6816	31 - 6816	45
B1SB6092	15 - 6092	364	B1SB6229	15 - 6229	396	B1SB6524B	19 - 12939	448	B1SB6689	19 - 6689	461	B1SB6817	31 - 6817	45
B1SB6093	15 - 6093	365	B1SB6231	15 - 6231	396	B1SB6525	23 - 6525	576	B1SB669	12 - 669	240	B1SB6818	31 - 6818	45
B1SB6099	15 - 6099	394	B1SB6232	15 - 6232	396	B1SB6526	23 - 6526	575	B1SB6691	19 - 6691	461	B1SB6819	31 - 6819	45
B1SB61	02 - 61	38	B1SB6235	15 - 6235	332	B1SB6528	23 - 6528	582	B1SB6693	19 - 6693	461	B1SB6832	08 - 6832	121
B1SB6100	15 - 6256	410	B1SB6236	15 - 6236	333	B1SB6529	23 - 6529	582	B1SB6695	19 - 6695	482	B1SB6837	12 - 6837	258
B1SB6101	15 - 6101	346	B1SB6237	15 - 6237	343	B1SB6530	27 - 6530	636	B1SB6697	19 - 6697	482	B1SB6838	12 - 6838	233
B1SB6105	15 - 6105	331	B1SB6238	15 - 6238	342	B1SB6531	23 - 6531	575	B1SB67	02 - 67	44	B1SB6841	12 - 6841	233
B1SB6107	16 - 6107	421	B1SB6239	15 - 6239	342	B1SB6532	13 - 6532	290	B1SB670	12 - 670	240	B1SB6842	12 - 6842	236
B1SB6109	15 - 6109	403	B1SB6240	15 - 6240	341	B1SB6534	09 - 6534	135	B1SB6700	19 - 6700	482	B1SB6843	12 - 6843	233
B1SB6110	15 - 6110	402	B1SB6245	14 - 6245	314	B1SB6535	09 - 6535	135	B1SB6701	19 - 6701	482	B1SB6844	12 - 6844	233
B1SB6111	15 - 6111	390	B1SB6246	14 - 6246	314	B1SB6536	09 - 6536	133	B1SB6702	19 - 6702	482	B1SB6845	12 - 6845	235
B1SB6112	15 - 6112	390	B1SB6247	14 - 6247	314	B1SB6540	08 - 6540	118	B1SB6703	19 - 6703	482	B1SB6847	19 - 6847	479
B1SB6113	15 - 6113	389	B1SB6248	14 - 6248	314	B1SB6541	08 - 6541	118	B1SB6704	19 - 6704	482	B1SB6847	19 - 2784	479
B1SB6115	15 - 6115	338	B1SB6250	15 - 6250	352	B1SB6542	09 - 6542	135	B1SB6705	19 - 6705	465	B1SB6848	19 - 6848	481
B1SB6116	15 - 6116	338	B1SB6252	15 - 6252	376	B1SB6545	31 - 6545	1061	B1SB6706	19 - 6706	465	B1SB6850	23 - 6850	554
B1SB6118	15 - 6118	412	B1SB6254	15 - 6254	328	B1SB6548	31 - 6548	46	B1SB6707	19 - 6707	462	B1SB6852	23 - 6852	554
B1SB6119	15 - 6119	390	B1SB6255	15 - 6255	376	B1SB6549	31 - 6549	46	B1SB6708	19 - 6708	462	B1SB6854	23 - 6854	554
B1SB6120	15 - 6120	330	B1SB6256	15 - 6256	410	B1SB6550	31 - 6550	46	B1SB6709	06 - 6709	99	B1SB6855	23 - 6855	554
B1SB6123	15 - 6123	330	B1SB6257	15 - 6257	412	B1SB6551	31 - 6551	46	B1SB6711	31 - 6711	45	B1SB6857	23 - 6857	555
B1SB6124	15 - 6124	331	B1SB6258	15 - 6258	412	B1SB6552	31 - 6552	46	B1SB6712	31 - 6712	45	B1SB6858	23 - 6858	555
B1SB6125	15 - 6125	332	B1SB6262	15 - 6262	332	B1SB6553	19 - 6553	479	B1SB6713	31 - 6713	45	B1SB6859	23 - 6859	555
B1SB6126	15 - 6126	382	B1SB6263	15 - 6263	329	B1SB6571	08 - 6571	124	B1SB6714	31 - 6714	45	B1SB6860	23 - 6860	555
B1SB6127	15 - 6127	383	B1SB6264	15 - 6264	330	B1SB6572	13 - 6572	264	B1SB6715	31 - 6715	45	B1SB6861	23 - 6861	555
B1SB6128	15 - 6128	381	B1SB6272	15 - 6272	337	B1SB6573	09 - 6573	133	B1SB6716	31 - 6716	45	B1SB6862	23 - 6862	555
B1SB6131	15 - 6131	363	B1SB6275	15 - 6275	409	B1SB6576	01 - 6576	47	B1SB6717	31 - 6717	45	B1SB6865	27 - 6865	639
B1SB6135	15 - 6135	411	B1SB6276	16 - 6276	422	B1SB6580	10 - 6580	157	B1SB6718	32 - 6718	45	B1SB6871	12 - 6871	240
B1SB6136	15 - 6136	411	B1SB6277	15 - 6277	402	B1SB6581	10 - 6581	156	B1SB6720	23 - 6720	563	B1SB6872	12 - 6872	240
B1SB6137	15 - 6137	407	B1SB6285	15 - 6285	361	B1SB6583	19 - 6583	476	B1SB6721	23 - 6721	563	B1SB6874	12 - 6874	240
B1SB6138	15 - 6138	394	B1SB6290	15 - 6290	353	B1SB6584	19 - 6584	476	B1SB6722	23 - 6722	563	B1SB6878	23 - 6878	559
B1SB6139	15 - 6139	383	B1SB6291	15 - 6291	350	B1SB6585	19 - 6585	477	B1SB6723	23 - 6723	563	B1SB6891	10 - 6891	160
B1SB6140	15 - 6140	382	B1SB6298	15 - 6298	322	B1SB6589	03 - 6589	66	B1SB6725	23 - 6725	563	B1SB6892	10 - 6892	160
B1SB6143	15 - 6143	382	B1SB63	02 - 63	38	B1SB6594	08 - 6594	118	B1SB6726	23 - 6726	563	B1SB6896	12 - 6896	240
B1SB6144	15 - 6144	391	B1SB6303	15 - 6303	324	B1SB6595	24 - 6595	589	B1SB6727	23 - 6727	563	B1SB6898	12 - 7533	215
B1SB6145	15 - 6145	390	B1SB6323	15 - 6323	359	B1SB6596	32 - 6596	1102	B1SB6728	15 - 6728	371	B1SB6898	12 - 6898	240
B1SB6146	15 - 6146	390	B1SB6324	15 - 6324	335	B1SB6599	32 - 6599	1097	B1SB673	12 - 673	240	B1SB69	02 - 69	44
B1SB6147	15 - 6147	342	B1SB6326	15 - 6326	408	B1SB66	02 - 66	38	B1SB6732	23 - 6732	565	B1SB6900	12 - 6900	222
B1SB6151	15 - 6151	363	B1SB6328	15 - 6328	376	B1SB6601	19 - 6601	455	B1SB6734	23 - 6734	565	B1SB6906	12 - 6906	233
B1SB6153	15 - 6153	365	B1SB6329	15 - 6329	376	B1SB6602	19 - 6602	453	B1SB6736	23 - 6736	565	B1SB6907	12 - 6907	235
B1SB6160	15 - 6160	391	B1SB6330	15 - 6330	359	B1SB6603	19 - 6603	453	B1SB6737	15 - 6737	374	B1SB6908	12 - 6908	235
B1SB6161	15 - 6161	389	B1SB64	02 - 64	38	B1SB6604	19 - 6604	453	B1SB6738	15 - 6738	374	B1SB6913	07 - 6913	105
B1SB6162	15 - 6162	391	B1SB6401	15 - 6401	360	B1SB6605	19 - 6605	467	B1SB6739	23 - 6739	564	B1SB6914	07 - 6914	105
B1SB6166	15 - 6166	391	B1SB6406	15 - 6406	356	B1SB6607	13 - 6607	272	B1SB6740	23 - 6740	564	B1SB6917	07 - 6917	103
B1SB6167	15 - 6167	359	B1SB6407	15 - 6407	356	B1SB6608	13 - 6608	272	B1SB6741	23 - 6741	564	B1SB6918	07 - 6918	104
B1SB6168	15 - 6168	360	B1SB6408	15 - 6408	389	B1SB6621	32 - 6621	574	B1SB6742	23 - 6742	564	B1SB6929	19 - 6929	483
B1SB6169	15 - 6169	413	B1SB6416	15 - 1026	386	B1SB6625	09 - 6625	130	B1SB6743	23 - 6743	564	B1SB6949	12 - 6949	235
B1SB6170	15 - 6170	413	B1SB6417	15 - 1032	386	B1SB6628	15 - 6628	371	B1SB6744	23				



AFTERMARKET CROSS REFERENCE

Part No.	Rotary No.	Page No.	Part No.	Rotary No.	Page No.	Part No.	Rotary No.	Page No.	Part No.	Rotary No.	Page No.	Part No.	Rotary No.	Page No.
SUNBELT			B1SB7408	20 - 7408	517	B1SB7735	22 - 7735	42	B1SB820	29 - 820	666	B1SB8506	03 - 8506	74
B1SB7046	19 - 7046	474	B1SB7419	19 - 7419	476	B1SB7736	22 - 7736	42	B1SB8207	05 - 8207	89	B1SB8507	09 - 8507	132
B1SB7047	19 - 7047	474	B1SB7420	19 - 7420	477	B1SB7737	22 - 7737	42	B1SB8208	22 - 8208	532	B1SB8509	12 - 8509	245
B1SB7050	19 - 7050	454	B1SB7421	23 - 7421	577	B1SB7738	22 - 7738	42	B1SB8209	22 - 8209	532	B1SB851	15 - 851	407
B1SB7051	19 - 7051	456	B1SB75	02 - 75	41	B1SB7739	22 - 7739	42	B1SB8212	22 - 8212	529	B1SB8513	09 - 8513	148
B1SB7095	19 - 7095	453	B1SB750	13 - 750	266	B1SB774	13 - 774	266	B1SB8213	22 - 8213	528	B1SB8519	27 - 8519	491
B1SB7096	33 - 7096	1130	B1SB751	13 - 751	266	B1SB7740	22 - 7740	42	B1SB8218	27 - 8218	642	B1SB852	26 - 852	608
B1SB71	02 - 71	41	B1SB752	13 - 752	266	B1SB7741	22 - 7741	42	B1SB8219	27 - 8219	642	B1SB8522	09 - 8522	148
B1SB7115	10 - 7115	179	B1SB753	13 - 753	266	B1SB7743	01 - 7743	42	B1SB8220	27 - 8220	642	B1SB8529	27 - 8529	498
B1SB7116	10 - 7116	179	B1SB7530	12 - 7530	215	B1SB7746	19 - 7746	480	B1SB8221	27 - 8221	642	B1SB853	09 - 853	143
B1SB7117	10 - 7117	179	B1SB754	13 - 754	266	B1SB776	13 - 776	291	B1SB8222	27 - 8222	642	B1SB8531	32 - 8531	1102
B1SB7118	10 - 7118	179	B1SB7543	12 - 7543	215	B1SB777	13 - 777	264	B1SB8223	27 - 8223	642	B1SB8532	27 - 8532	658
B1SB7124	13 - 7124	290	B1SB7544	12 - 7544	215	B1SB7778	19 - 7778	453	B1SB8225	23 - 8225	581	B1SB854	09 - 854	145
B1SB7126	13 - 7126	264	B1SB7545	12 - 7545	215	B1SB7783	20 - 7783	515	B1SB8226	23 - 8226	575	B1SB8545	32 - 8545	1102
B1SB7127	13 - 7127	263	B1SB7546	12 - 7546	215	B1SB7785	19 - 7785	471	B1SB8227	22 - 8227	529	B1SB8546	20 - 8546	511
B1SB7128	12 - 7128	240	B1SB7547	12 - 7547	215	B1SB7786	13 - 7786	287	B1SB8228	23 - 8228	582	B1SB855	07 - 855	102
B1SB7129	12 - 7129	240	B1SB7548	12 - 7548	215	B1SB7788	05 - 7788	90	B1SB8229	23 - 8229	577	B1SB8551	08 - 8551	111
B1SB714	13 - 714	36	B1SB7549	12 - 7549	215	B1SB7793	23 - 7793	581	B1SB8239	27 - 8239	487	B1SB8552	08 - 8552	108
B1SB715	13 - 715	263	B1SB755	13 - 755	266	B1SB7798	23 - 7798	579	B1SB824	15 - 824	417	B1SB8553	08 - 8553	108
B1SB7153	24 - 7153	589	B1SB7550	12 - 7550	215	B1SB7799	23 - 7799	579	B1SB8242	23 - 8242	569	B1SB8555	27 - 8555	660
B1SB7156	10 - 7156	195	B1SB7551	12 - 7551	215	B1SB78	02 - 78	41	B1SB8243	23 - 8243	569	B1SB8556	27 - 8556	660
B1SB7157	13 - 7157	264	B1SB7552	12 - 7552	215	B1SB7800	23 - 7800	579	B1SB8245	13 - 8245	264	B1SB8557	27 - 8557	661
B1SB7162	09 - 7162	134	B1SB7553	12 - 7553	215	B1SB7801	23 - 7801	578	B1SB8247	04 - 8247	82	B1SB8558	27 - 8558	661
B1SB7165	19 - 7165	481	B1SB7554	12 - 7554	215	B1SB7804	31 - 7804	1063	B1SB8248	04 - 8248	82	B1SB856	10 - 856	197
B1SB7169	12 - 7169	233	B1SB7555	12 - 7555	215	B1SB7811	08 - 7811	123	B1SB8249	04 - 8249	82	B1SB8561	23 - 8561	556
B1SB717	01 - 717	36	B1SB7556	12 - 7556	215	B1SB7812	03 - 7812	66	B1SB825	15 - 825	346	B1SB8563	27 - 8563	77
B1SB7171	12 - 7171	241	B1SB7557	12 - 7557	215	B1SB7813	13 - 7813	264	B1SB8255	22 - 8255	537	B1SB8564	27 - 8564	77
B1SB7173	23 - 7173	577	B1SB756	13 - 756	266	B1SB7814	32 - 7814	1110	B1SB8262	06 - 8262	99	B1SB8568	05 - 8568	71
B1SB7176	13 - 7176	264	B1SB757	13 - 757	266	B1SB7821	08 - 7821	124	B1SB8263	06 - 8263	99	B1SB8570	27 - 8570	655
B1SB718	13 - 718	36	B1SB758	13 - 758	266	B1SB7822	08 - 7822	124	B1SB8265	05 - 8265	91	B1SB8572	27 - 8572	661
B1SB7180	13 - 7180	271	B1SB7582	12 - 7582	216	B1SB7823	08 - 7823	125	B1SB827	33 - 827	34	B1SB8573	08 - 8573	113
B1SB7181	10 - 7181	162	B1SB759	13 - 759	266	B1SB7824	08 - 7824	124	B1SB828	08 - 828	118	B1SB8575	08 - 8575	112
B1SB7182	13 - 7182	264	B1SB76	02 - 76	41	B1SB7825	08 - 7825	124	B1SB8282	18 - 8282	443	B1SB858	10 - 858	73
B1SB719	13 - 719	36	B1SB760	13 - 760	266	B1SB7826	08 - 7826	125	B1SB8286	26 - 8286	609	B1SB8582	08 - 8582	118
B1SB72	02 - 72	41	B1SB761	13 - 761	266	B1SB7827	08 - 7827	118	B1SB829	08 - 829	119	B1SB8586	09 - 8586	141
B1SB720	13 - 720	36	B1SB7613	12 - 7613	216	B1SB7828	08 - 7828	124	B1SB8296	05 - 8296	91	B1SB8588	13 - 8588	264
B1SB7200	17 - 7200	429	B1SB762	13 - 762	266	B1SB7829	32 - 7829	1095	B1SB830	08 - 830	119	B1SB8589	27 - 8589	491
B1SB72004	20 - 9607	519	B1SB763	13 - 763	266	B1SB7838	12 - 7838	241	B1SB8327	19 - 8327	474	B1SB8590	15 - 8590	394
B1SB7202	08 - 7202	122	B1SB764	13 - 764	266	B1SB7841	19 - 7841	465	B1SB8330	19 - 8330	480	B1SB8591	22 - 8591	533
B1SB7203	01 - 7203	48	B1SB7641	12 - 7641	216	B1SB7842	01 - 7842	38	B1SB8331	19 - 8331	458	B1SB859S	18 - 859	440
B1SB7204	01 - 7204	43	B1SB7642	12 - 7642	216	B1SB7847	13 - 7847	38	B1SB8351	09 - 8351	131	B1SB860	26 - 860	608
B1SB7205	01 - 7205	46	B1SB7645	12 - 7645	216	B1SB7849	13 - 7849	38	B1SB8364	22 - 8364	529	B1SB8601	31 - 8601	1063
B1SB7209	19 - 7209	476	B1SB7646	12 - 7646	216	B1SB7851	13 - 7851	38	B1SB837	08 - 837	117	B1SB8602	13 - 8602	264
B1SB721	13 - 721	36	B1SB7647	12 - 7647	216	B1SB7877	19 - 7877	455	B1SB8377	08 - 8377	116	B1SB8607	01 - 8607	48
B1SB7210	09 - 7210	132	B1SB7648	12 - 7648	216	B1SB7880	19 - 7880	455	B1SB8379	08 - 8379	116	B1SB8618	33 - 8618	1119
B1SB7212	10 - 7212	179	B1SB7649	12 - 7649	216	B1SB7894	12 - 7894	260	B1SB838	08 - 838	117	B1SB862	18 - 862	438
B1SB7213	23 - 7213	557	B1SB765	13 - 765	266	B1SB789	02 - 79	41	B1SB8385	14 - 8385	314	B1SB8625	10 - 8625	156
B1SB7214	19 - 7214	453	B1SB7650	12 - 7650	216	B1SB7920	05 - 7920	89	B1SB8386	20 - 8386	505	B1SB8626	03 - 8626	58
B1SB722	13 - 722	36	B1SB7651	12 - 7651	216	B1SB7922	31 - 7922	1064	B1SB840	08 - 840	117	B1SB8627	41 - 8627	1221
B1SB7220	24 - 7220	589	B1SB7652	12 - 7652	216	B1SB7934	31 - 7934	1072	B1SB8404	09 - 8404	140	B1SB8628	41 - 8628	1221
B1SB7225	24 - 7225	589	B1SB7653	12 - 7653	216	B1SB7940	22 - 7940	531	B1SB8405	11 - 405	203	B1SB863	10 - 863	160
B1SB7229	24 - 7229	590	B1SB7655	12 - 7655	216	B1SB7942	23 - 7942	575	B1SB8407	29 - 8407	666	B1SB8631	19 - 8631	484
B1SB723	13 - 723	36	B1SB7656	12 - 7656	216	B1SB7943	23 - 7943	575	B1SB8408	09 - 8408	140	B1SB8637	26 - 8637	627
B1SB7230	24 - 7230	590	B1SB7657	12 - 7657	216	B1SB7944	23 - 7944	575	B1SB8409	09 - 8409	140	B1SB8638	27 - 8638	655
B1SB7232	24 - 7232	590	B1SB7658	12 - 7658	216	B1SB7946	23 - 7946	575	B1SB841	08 - 841	117	B1SB8638	04 - 864	81
B1SB7234	23 - 7234	578	B1SB7659	12 - 7659	216	B1SB7948	22 - 7948	531	B1SB8410	27 - 8410	491	B1SB8640	17 - 8640	435
B1SB7238	20 - 7238	513	B1SB766	13 - 766	266	B1SB7951	22 - 7951	538	B1SB8411	10 - 8411	179	B1SB8644	28 - 8644	664
B1SB724	13 - 724	36	B1SB767	13 - 767	266	B1SB7963	23 - 7963	576	B1SB8412	10 - 8412	176	B1SB8645	20 - 8645	506
B1SB7241	09 - 7241	135	B1SB7672	12 - 7672	238	B1SB7964	23 - 7964	577	B1SB8413	23 - 8413	569	B1SB8647	10 - 8647	201
B1SB7245	12 - 7245	238	B1SB7673	12 - 7673	238	B1SB7967	22 - 7967	538	B1SB8414	23 - 8414	575	B1SB8649	10 - 8649	200
B1SB7246	23 - 7246	582	B1SB7674	09 - 7674	135	B1SB7969	22 - 7969	538	B1SB8417	03 - 8417	60	B1SB865	04 - 865	81
B1SB7247	23 - 7247	582	B1SB7675	31 - 7675	1064	B1SB7981	13 - 7981	285	B1SB8419	10 - 8419	180	B1SB8651	10 - 8651	180
B1SB7248	23 - 7248	582	B1SB7678	41 - 7678	93	B1SB7993	13 - 7993	284	B1SB8420	09 - 8420	140	B1SB8652	10 - 8652	180
B1SB725	13 - 725	36	B1SB768	13 - 768	266	B1SB7994	13 - 7994	284	B1SB8430	12 - 8430	221	B1SB8653	10 - 8653	180
B1SB7251	10 - 7251	201	B1SB7680	04 - 7680	80	B1SB7995	13 - 7995	284	B1SB8433	09 - 8433	138	B1SB8654	09 - 8654	144
B1SB7258	09 - 7258	146	B1SB7681	04 - 7681	80	B1SB7998	20 - 7998	496	B1SB8437	09 - 8437	132	B1SB8656	09 - 8656	135
B1SB726	13 - 726	36	B1SB769	13 - 769	266	B1SB8	01 - 8	41	B1SB8438	09 - 8438	140	B1SB8657	13 - 8657	281
B1SB7262	09 - 7262	142	B1SB770	13 - 770	266</									

AFTERMARKET CROSS REFERENCE



Part No.	Rotary No.	Page No.	Part No.	Rotary No.	Page No.	Part No.	Rotary No.	Page No.	Part No.	Rotary No.	Page No.	Part No.	Rotary No.	Page No.
SUNBELT			B1SB9020	32-9020	1100	B1SB94019	15-6251	411	B1SN13	10-7886	180	B1TI557	08-10730	122
B1SB870	12-870	224	B1SB9023	32-9023	1097	B1SB94029	15-6270	409	B1SN15	10-2909	162	B1TI61	08-8541	122
B1SB8706	09-8706	143	B1SB9027	32-9027	1101	B1SB94030	15-6267	407	B1SN25	05-2700	72	B1TI66	08-7028	122
B1SB8707	09-8707	143	B1SB9028	32-9028	1103	B1SB946	03-946	62	B1SN29	31-7179	1061	B1TI67	08-7027	121
B1SB871	08-871	115	B1SB9029	32-9029	1101	B1SB9483	12-9483	241	B1SN3001	15-1060	403	B1TI76	08-7029	122
B1SB8712	19-8712	467	B1SB903	08-903	121	B1SB9483	12-9483	241	B1SN3003	15-1092	403	B1TO50	10-9874	176
B1SB8713	27-8713	491	B1SB9030	32-9030	1101	B1SB9487	15-9487	349	B1SN3004	15-1098	403	B1TO8420	09-8420	140
B1SB8716	27-8716	493	B1SB9031	32-9031	1096	B1SB9487	15-9487	349	B1SN33	08-7744	117	B1TO8440	09-8440	140
B1SB872	08-872	115	B1SB9034	32-9034	1090	B1SB95	02-95	40	B1SN34	08-7745	117	B1TO8441	09-8441	140
B1SB8726	09-8726	133	B1SB9036	32-9036	1092	B1SB95005	15-6422	324	B1SN35	10-7885	180	B1TO8476	09-8476	148
B1SB8735	27-8735	485	B1SB9037	32-9037	1092	B1SB95022	15-6106	333	B1SN38	10-7154	182	B1TR151	12-10090	241
B1SB8737	20-8737	517	B1SB9038	32-9038	1103	B1SB95052	15-6437	329	B1SN41	18-7239	443	B1TR18	29-8406	666
B1SB8741	10-8741	176	B1SB9039	32-9039	1103	B1SB9508	13-9508	291	B1SN42	10-8301	163	B1TR26	29-8610	667
B1SB8746	23-8746	575	B1SB904	08-904	123	B1SB9508	13-9508	291	B1SN43	10-7747	157	B1TR27	29-8611	667
B1SB8749	24-8749	599	B1SB9050	32-9050	1090	B1SB951	14-951	315	B1SN44	10-6973	171	B1TR30	12-7952	241
B1SB875	26-875	608	B1SB9051	32-9051	1090	B1SB9515	10-9515	197	B1SN47	10-2908	162	B1TR3100	15-1008	410
B1SB8750	24-8750	599	B1SB9052	32-9052	1091	B1SB9516	10-9516	196	B1SN48	05-8632	94	B1TR3106	15-10209	318
B1SB8752	17-8752	428	B1SB9053	32-9053	1091	B1SB9517	10-9517	196	B1SN54	05-5951	94	B1TR55	09-10015	135
B1SB8753	17-8753	428	B1SB9054	32-9054	1090	B1SB9518	10-9518	195	B1SN55	05-5952	94	B1TR8621	29-8621	667
B1SB8755	10-8755	182	B1SB9055	32-9055	1091	B1SB952	14-952	315	B1SN57	11-8472	94	B1TR8622	29-8622	667
B1SB876	26-876	608	B1SB9057	32-9057	1108	B1SB953	14-953	315	B1SN58	17-8454	433	B1TU10	08-7144	125
B1SB8762	12-8762	221	B1SB906	08-906	121	B1SB954	14-954	315	B1SN59	17-8453	433	B1TU15	08-7145	124
B1SB8764	05-8764	72	B1SB9065	25-9065	604	B1SB955	14-955	315	B1SN61	09-6864	148	B1TU20	08-7146	124
B1SB8765	03-8765	66	B1SB9065	25-9065	605	B1SB96023	15-6286	394	B1SN64	05-7255	93	B1TU25	08-7261	124
B1SB8766	03-8766	57	B1SB9066	27-9066	485	B1SB965	14-965	316	B1SN69	10-7919	162	B1TU30	08-7260	124
B1SB8769	26-8769	628	B1SB9069	32-9069	1091	B1SB97	02-97	40	B1SN77	05-8294	70	B1TU35	08-7147	124
B1SB8770	05-8770	89	B1SB9071	32-9071	1102	B1SB97018	15-6470	389	B1SN78	05-8293	70	B1TU5	08-7143	123
B1SB8771	31-8771	1076	B1SB9072	32-9072	1090	B1SB97119	15-6129	391	B1SN7869	09-7869	133	B1UN3206	14-981	315
B1SB878	08-878	123	B1SB9073	32-9073	1096	B1SB97121	15-6142	390	B1SN8193	13-8193	291	B1VPD6072	20-13536	520
B1SB8781	12-8781	223	B1SB9074	32-9074	1095	B1SB977	14-977	315	B1SN8322	10-8322	137	B1W125527	38-9024	502
B1SB8783	09-8783	145	B1SB9077	32-9077	1099	B1SB978	14-978	315	B1SN8455	17-8455	433	B1W125528	38-9025	502
B1SB8785	19-8785	479	B1SB908	08-908	119	B1SB979	14-979	315	B1SND26	15-3527	404	B1W95526	38-8101	47
B1SB8786	31-8786	1074	B1SB9086	32-9086	1102	B1SB980	14-980	315	B1SND28	15-3528	404	B1WB10	09-8525	131
B1SB879	08-879	119	B1SB9089	33-9089	1129	B1SB98002	15-6096	383	B1SND30	15-3526	404	B1WD10HDB	38-4182	1194
B1SB8791	27-8791	661	B1SB909	15-909	405	B1SB98004	15-6457	383	B1SND33	15-3524	404	B1WD10HDC	38-4186	1195
B1SB8792	23-8792	563	B1SB9091	33-9091	1125	B1SB98005	15-6212	384	B1SP107	37-3009	1180	B1WD10SDC	38-4184	1195
B1SB8793	23-8793	563	B1SB90916	15-6296	322	B1SB98045	15-6042	383	B1SP13	25-1318	604	B1WD10WAT	38-4179	1195
B1SB8794	23-8794	558	B1SB90917	15-6300	322	B1SB981	14-981	315	B1SP203	37-3025	1180	B1WD10WS	38-4181	1194
B1SB8796	09-8796	147	B1SB90921	15-6299	324	B1SB9810	15-9810	332	B1SP24	25-7301	605	B1WD1MDC	38-4209	1194
B1SB8799	24-8799	599	B1SB90929	15-6309	322	B1SB988	14-988	316	B1SP25	39-1566	1215	B1WE1	27-3512	655
B1SB8801	17-8801	436	B1SB90932	15-6314	322	B1SB990	14-990	316	B1SP26	25-4969	604	B1WE102	27-6975	659
B1SB8802	17-8802	436	B1SB9099	32-9099	1093	B1SB9909	27-9909	490	B1SP401	37-3012	1180	B1WE103	27-30169	659
B1SB8826	23-8826	563	B1SB910	15-910	405	B1SB991	14-991	316	B1SP501	37-3044	1181	B1WE106	27-8521	660
B1SB8827	23-8827	559	B1SB91069	15-6141	339	B1SB99124	15-6108	403	B1SP502	37-3045	1181	B1WE107	27-8518	660
B1SB8829	13-8829	292	B1SB9108	32-9108	211	B1SB992	14-992	316	B1SP70	39-1570	1215	B1WE110	27-8566	77
B1SB883	08-883	118	B1SB91096	15-6068	338	B1SB997	15-997	382	B1SP753	26-2436	634	B1WE115	38-9137	502
B1SB8832	03-8832	59	B1SB91097	15-6066	338	B1SB99920	15-6317	324	B1ST10	39-7876	1208	B1WE116	38-9138	502
B1SB8833	05-8833	72	B1SB911	15-911	328	B1SB99930	15-6297	326	B1ST134	39-7085	1217	B1WE117	38-9139	502
B1SB8834	23-8834	569	B1SB9114	25-9114	605	B1SC13	13-11657	286	B1ST135	39-7086	1217	B1WE118	38-9140	502
B1SB884	08-884	123	B1SB91188	15-6250	352	B1SC20	12-10048	256	B1ST136	39-7087	1217	B1WE119	27-7928	659
B1SB8863	09-8863	134	B1SB9119	12-9119	234	B1SC21	12-10049	256	B1ST14	39-7296	1217	B1WE12	20-7407	517
B1SB8868	09-8199	131	B1SB91253	15-6180	334	B1SC22	12-10047	256	B1ST35	39-7772	1207	B1WE16	27-6882	659
B1SB8869	09-8869	130	B1SB91295	15-6150	363	B1SC23	12-10046	256	B1ST36	39-7770	1207	B1WE17	26-7930	610
B1SB8897	31-8897	46	B1SB913	08-913	119	B1SC24	12-10045	256	B1ST39	20-7882	517	B1WE19	26-7927	610
B1SB8903	19-8903	461	B1SB91318	15-6078	343	B1SC25	12-10044	255	B1ST40	20-7883	517	B1WE2	31-7946	85
B1SB8904	19-8904	461	B1SB91321	15-6075	340	B1SC26	12-10043	255	B1ST60	39-7775	1212	B1WE20	27-6968	659
B1SB8906	19-8906	461	B1SB91328	15-6147	342	B1SC3	33-11993	1120	B1ST61	39-7776	1212	B1WE200	27-6994	642
B1SB8907	19-8907	461	B1SB91374	15-6481	355	B1SC3	33-11992	1120	B1ST62	39-7767	1215	B1WE207	27-7003	642
B1SB891	18-891	438	B1SB91381	15-6206	373	B1SC79	09-9463	136	B1ST74	27-9043	655	B1WE208	27-7004	642
B1SB892	18-892	438	B1SB91394	15-6253	375	B1SC85	13-9600	288	B1SU136	32-4250	1103	B1WE21	27-7897	642
B1SB8924	08-8924	118	B1SB91397	15-6122	375	B1SC89	12-12371	256	B1TC100	03-9136	74	B1WE22	27-9599	645
B1SB8927	07-8927	102	B1SB91399	15-6328	376	B1SDS1000	33-9215	1126	B1TC58	03-9566	68	B1WE229	27-7926	491
B1SB8928	07-8928	102	B1SB91402	15-6327	376	B1SDS500	33-9212	1126	B1TC59	03-9680	57	B1WE231	27-7906	75
B1SB8929	07-8929	102	B1SB9143	10-9143	174	B1SL1080B	27-5928	636	B1TC62	03-9679	57	B1WE232	27-8080	495
B1SB8930	07-8930	102	B1SB9143	10-9143	174	B1SL1095B	27-5927	636	B1TC76	03-9128	57	B1WE234	31-7302	656
B1SB8931	07-8931	102	B1SB91436	15-6265	378	B1SL1105	27-3520	636	B1TC86	03-7975	63	B1WE237	27-7411	75
B1SB8932	07-8932	102	B1SB91438	15-6209	378	B1SL1105B	27-5930	636	B1TC88	03-9129	57	B1WE245	25-7410	606
B1SB8934	20-8934	514	B1SB9150	10-9150	174	B1SL1130	27-3521	636	B1TC91	03-7974	63	B1WE248	20-8526	618
B1SB8935	20-8935	514	B1SB9159	10-9159	174	B1SL1130B	27-5929	636	B1TE08	20-8285	514	B1WE250	27-7909	658
B1SB8936	20-8936	513	B1SB916	41-916										



AFTERMARKET CROSS REFERENCE

Part No.	Rotary No.	Page No.	Part No.	Rotary No.	Page No.	Part No.	Rotary No.	Page No.	Part No.	Rotary No.	Page No.	Part No.	Rotary No.	Page No.
SUNBELT														
B1WE6	27 - 7235	660												
B1WE60	27 - 7929	659												
B1WE67	20 - 6884	517												
B1WE7	27 - 4300	490												
B1WE72	20 - 7293	519												
B1WE73	27 - 7864	658												
B1WE7932	20 - 7932	517												
B1WE7997	27 - 7997	492												
B1WE8527	20 - 8527	518												
B1WE8534	27 - 8534	498												
B1WE8535	27 - 8535	519												
B1WE92	25 - 4968	604												
B1WE95	27 - 6883	660												
B1WE98	27 - 6881	659												
B1WH1	10 - 2226	162												
B1WH19	10 - 3309	182												
B1WH2	10 - 2225	162												
B1WH23	03 - 9135	66												
B1WH35	19 - 6680	484												
B1WK10WAT	38 - 4180	1195												
B1WL10	07 - 6919	103												
B1WL20	07 - 6916	106												
B1WL28	08 - 7285	114												
B1WL31	07 - 8311	106												
B1WL32	07 - 8310	106												
B1WL35	08 - 9803	108												
B1WL35	08 - 9803	108												
B1WL36	08 - 9804	108												
B1WL36	08 - 9804	108												
B1WL37	08 - 10075	111												
B1WL38	08 - 10016	113												
B1WL39	08 - 10162	115												
B1WL42	07 - 6909	107												
B1WL43	07 - 8201	107												
B1WL51	07 - 6916	106												
B1WR101	19 - 6698	482												
B1WR121	19 - 6696	482												
B1WR307	19 - 6694	482												
BSB9150	10 - 9150	174												
D28105	13 - 10168	278												
HN-18	22 - 10475	536												
HN-7	22 - 10463	536												
KO-40	31 - 10297	1080												
M1MT337	12 - 11850	227												
MT-301	17 - 10239	429												
MU15	13 - 2915	263												
RY-22	27 - 10206	658												
SB91701	15 - 10096	399												
SB91723	15 - 10095	399												
SB94019	15 - 10209	318												
WL-20	07 - 10250	105												

2014 AFTERMARKET REF.

CARBURETOR KIT CHART



Carburetor Kit Application Chart for Chainsaws, Trimmers, Blowers, etc.

DESA (WALBRO)				ECHO (WALBRO) (cont.)			
MODEL	CARBURETOR MODEL	GSKT. / DIA. ORDER NO.	REPAIR KIT ORDER NO.	MODEL	CARBURETOR MODEL	GSKT. / DIA. ORDER NO.	REPAIR KIT ORDER NO.
CHAINSAWS							
PL-4	SDC-33	38-4184	-	CS-401EVL	WA-96, 96A	38-4179	38-4180
				CS-440EVL	WA-133	38-4179	38-4180
				CS-451VL, 452VL	WA-38	38-4179	38-4180
				CS-500VL	HDA-3A	38-4301	-
				CS-500VL, 501VL, 502EVL, 500VLP	HDB-3A, 9, 9A	38-4182	-
				CS-510EVL	HDA-20, 20A, 20B	38-4301	-
				CS-550EVL	HDA-14B	38-4301	-
				CS-610EVL	HDA-7A	38-4301	-
				CS-610VL	SDC-70, 70A	38-4184	-
				CS-650EVL	HDB-10, 10A, 10B, 11, 11A, 11B	38-4182	-
				CS-651, 651EVL	HDB-11, 11A, 11B, 12	38-4182	-
				CS-660EVL, 660EVL P	HDB-17	38-4182	-
				CS-661EVL	HDA-21, 21A, 21B	38-4301	-
				CS-661EVL	HDB-17	38-4182	-
				CS-702EVL, 702VL	SDC-70, 70A	38-4184	-
				CS-750EVL, 803EVL	SDC-70, 70A	38-4184	-
				CS-900EVL	SDC-77	38-4184	-
				CS-1001VL	SDC-52, 52A, 52B, 76	38-4184	-
				CS-1160VL, 1100VL	SDC-84, 84B	38-4184	-
				CS-3600	WT-88, 88A	38-4179	38-4180
				CS-5500	HDA-53	38-4301	-
				CS-6700	HDA-47, 47A, 47B	38-4301	-
				CS-8000	HDA-63	38-4301	-
				CS-8000	HDA-7A	38-4301	-
				CSV-361	WT-86, 86A	38-4179	38-4180
				CS-2800	WYP-4A	38-6568	-
				CSV-281, 288	WYP-3A, 4	38-6568	-
				CSV-391, 451, 4000, 4500	HDA-28, 28B, 28C, 28D, 28E	38-4301	-
				TRIMMERS			
				-FS-200-AV	WA-87	38-4179	38-4180
				GT-1000	WA-168	38-4179	38-4180
				SRM-200BE, 210AE	WA-143	38-4179	38-4180
				SRM-204DE	WA-50	38-4179	38-4180
				SRM-3800	WT-74	38-4179	38-4180
				SRM-4600	WT-77	38-4179	38-4180
				G-1A	WA-80, 80A	38-4179	38-4180
				GT-140	WA-46, 80, 80A	38-4179	38-4180
				GT-150	WA-68, 68A	38-4179	38-4180
				GT-160	WA-123, 123A	38-4179	38-4180
				GT-160A, 160AE	WA-138A	38-4179	38-4180
				GT-200	WA-59, 59R	38-4179	38-4180
				GT-200A	WA-81	38-4179	38-4180
				GT-200B	WA-143	38-4179	38-4180

DESA (WALBRO)			
MODEL	CARBURETOR MODEL	GSKT. / DIA. ORDER NO.	REPAIR KIT ORDER NO.
CHAINSAWS			
122	SDC-47A	38-4184	-
144	SDC-45A	38-4184	-
CA-113	SDC-46	38-4184	-

DOLMAR (WALBRO)			
MODEL	CARBURETOR MODEL	GSKT. / DIA. ORDER NO.	REPAIR KIT ORDER NO.
CHAINSAWS			
122	SDC-47A	38-4184	-
144	SDC-45A	38-4184	-
CA-113	SDC-46	38-4184	-

ECHO (TILLOTSON)			
MODEL	CARBURETOR MODEL	GSKT. / DIA. ORDER NO.	REPAIR KIT ORDER NO.
CHAINSAWS			
CS-60	HS-25A	38-1544	38-3644
CSL-80, 100	HL-226A	38-1551	-
CS-301	HU-1C	38-3667	38-4183
CS-302	HU-25A, 14A, 14C	38-3667	38-4183
CS-451	HU-9A, B, C	38-3667	38-4183
CS-451VL	HU-9A	38-3667	38-4183
CS-601, 601VL	HS-94A	38-1544	38-3644
CS-701	HS-54A, 166A	38-1544	38-3644
CS-701VL	HS-54VB	38-1544	38-3644
CS-702VL	HS-166A	38-1544	38-3644
SRM-201T, 202D	HU-8A, 1C	38-3667	38-4183
SRM-301, 401	HU-8A	38-3667	38-4183
ASRM-302, ADX	HU-1C	38-3667	38-4183
CS-900EVL	HS-215A	38-1544	38-3644
CXS-1100VL	HS-220A	38-1544	38-3644

ECHO (WALBRO)			
MODEL	CARBURETOR MODEL	GSKT. / DIA. ORDER NO.	REPAIR KIT ORDER NO.
CHAINSAWS			
CS-100	SDC-76	38-4184	-
CS-281EVL, CS-282	WA-108, 108A, WT-35, 68	38-4184	-
CS-302, 302S	WA-5, 5A, 5B	38-4179	38-4180
CS-304VL	WA-26, 33A	38-4179	38-4180
CS-315	WA-25, 32, 33, 33A	38-4179	38-4180
CS-330EVL	WA-96	38-4179	38-4180
CS-340EVL	WA-75, 75A	38-4179	38-4180
CS-351VL	WA-25	38-4179	38-4180
CS-361, 361VL, 362EVL	WA-137, 137A, B, 196	38-4179	38-4180
CS-400EVL	WA-93, 93A, 96	38-4179	38-4180



CARBURETOR KIT CHART

ECHO (WALBRO) (cont.)				ECHO (ZAMA)			
MODEL	CARBURETOR MODEL	GSKT. / DIA. ORDER NO.	REPAIR KIT ORDER NO.	MODEL	CARBURETOR MODEL	GSKT. / DIA. ORDER NO.	REPAIR KIT ORDER NO.
GTL-140	WA-68, 68A	38-4179	38-4180	CHAINSaws			
SRM-200D, 202DA	WA-21	38-4179	38-4180	CS-280E, 280EVL	C1S-K1, K1A	38-5839	-
SRM-200DA, 200DB	WA-59, 59R	38-4179	38-4180	CS-280E, 280EVL, 290EVL, 290EVL	C1S-K1B, K1C	38-5839	-
SRM-250E	WA-163	38-4179	38-4180	CS-330EVL	C1S-K3A, K3B, K3C, K3D	38-5839	-
SRM-300, 300E/1	WA-87, 87A	38-4179	38-4180				
SRM-300AE	WA-141	38-4179	38-4180				
SRM-302AD	WA-7B, 7C	38-4179	38-4180				
SRM-400E, 402E	WA-106, 106A	38-4179	38-4180				
SRM-400AE	WA-142	38-4179	38-4180				
SRM-3800	WT-74	38-4179	38-4180				
HC-140	WA-81	38-4179	38-4180				
HC-160, 160A	WA-89	38-4179	38-4180				
HC-200	WA-91, 91A, 91B	38-4179	38-4180				
HC-200AE	WA-91B	38-4179	38-4180				
HT-200	WA-81, 28A	38-4179	38-4180				
K3	WA-45, 45A	38-4179	38-4180				
K3-AW	WA-59	38-4179	38-4180				
KEH-202DA	WA-28, 28A	38-4179	38-4180				
MDL-160	WA-138, 138A	38-4179	38-4180				
RM-401	WA-5B	38-4179	38-4180				
RS-202	WA-21	38-4179	38-4180				
S-2AR	WA-59	38-4179	38-4180				
SRM-100AM	WA-100	38-4179	38-4180				
SRM-140D, 140DA	WA-46	38-4179	38-4180				
SRM-160	WA-123	38-4179	38-4180				
SRM-190	WA-132, 132A	38-4179	38-4180				
SRM-200	WA-81	38-4179	38-4180				
SRM-207DE	WA-107, 107A	38-4179	38-4180				
SRM-210E, 250	WA-81	38-4179	38-4180				
SRM-302	WA-7A, 7B, 131, 131A	38-4179	38-4180				
SRM-302BDX	WA-131, 131A	38-4179	38-4180				
SRM-303	WA-67, 67A	38-4179	38-4180				
SRM-310	WA-175	38-4179	38-4180				
SRM-501DE	WA-39	38-4179	38-4180				
SRM-610M	WA-161	38-4179	38-4180				
SRM-2102E	WA-143	38-4179	38-4180				
SRM-2501D	WA-163	38-4179	38-4180				
SV-3	WA-51, 51A	38-4179	38-4180				
AT-250	WY-57	38-6568	-				
E3 2200	WY-28	38-6568	-				
SRM 2000, 2200, 2500, 3000, 3010	WY-18, 20, 21, 28	38-6568	-				
GT-2200	WY-18	38-6568	-				
BLOWERS							
-PB-200	WA-66, 66A	38-4179	38-4180				
PB-210E	WA-157	38-4179	38-4180				
PB-300E	WA-162	38-4179	38-4180				
PB-400	WA-55, 55A	38-4179	38-4180				
PB-4500	WA-191, 191A	38-4179	38-4180				
SBF-80	SDC-75	38-4184	-				
				FUJI ROBIN (WALBRO)			
MODEL	CARBURETOR MODEL	GSKT. / DIA. ORDER NO.	REPAIR KIT ORDER NO.	MODEL	CARBURETOR MODEL	GSKT. / DIA. ORDER NO.	REPAIR KIT ORDER NO.
				CHAINSaws			
				EC-10	SDC-83, 86	38-4184	-
				TRIMMERS			
				-EC-01E, 01ER, 01R			
				EC-02	WY-35, 61	38-6568	-
				EC-02R	WY-27, 36	38-6568	-
				EC-02E	WY-10, 22	38-6568	-
				EC-02EH	WY-19B, 25A	38-6568	-
				EC-02EF	WY-34	38-6568	-
				EC-02EHR	WY-32	38-6568	-
				EC-02ER	WY-58, 60, WYJ-1	38-6568	-
					WYP-5A, WY-22, 26A, 29, 37, 38, 44	38-6568	-
				EC-02F	WY-31	38-6568	-
				EC-03F	WY-30A	38-6568	-
				NB-23M	WY-17	38-6568	-
				GRANDEUR (WALBRO)			
MODEL	CARBURETOR MODEL	GSKT. / DIA. ORDER NO.	REPAIR KIT ORDER NO.	MODEL	CARBURETOR MODEL	GSKT. / DIA. ORDER NO.	REPAIR KIT ORDER NO.
				BRUSH CUTTER			
				22.5cc	WY-12	38-6568	-
				25.4cc	WY-11, 20	38-6568	-
				GREEN MACHINE (WALBRO)			
MODEL	CARBURETOR MODEL	GSKT. / DIA. ORDER NO.	REPAIR KIT ORDER NO.	MODEL	CARBURETOR MODEL	GSKT. / DIA. ORDER NO.	REPAIR KIT ORDER NO.
				CHAINSaws			
				7600	HDA-27B	38-4301	-
				7700	HDA-31D, 31E	38-4301	-
				TK for Green Machine	Used on Green Machine and Shindaiwa with Shindaiwa, John Deere, Hafele, Robin with Fuji engines	38-5829	-
				TRIMMERS			
				1600	WT-25	38-4179	38-4180
				1700	WA-102	38-4179	38-4180

2014

CARB. KIT CHART



CARBURETOR KIT CHART

GREEN MACHINE (WALBRO) (cont.)			
MODEL	CARBURETOR MODEL	GSKT. / DIA. ORDER NO.	REPAIR KIT ORDER NO.
1730	WA-105	38-4179	38-4180
1800, 2230	WT-25	38-4179	38-4180
2100, 2200, 2300	WA-105	38-4179	38-4180
2400, 2500LP, 25101LP	WY-1	38-6568	-
2800	WY-50	38-6568	-
3000LP	WY-4	38-6568	-
3000SS	WY-43	38-6568	-

HITACHI KOKI (WALBRO)			
MODEL	CARBURETOR MODEL	GSKT. / DIA. ORDER NO.	REPAIR KIT ORDER NO.
CHAINSAWS			
-CG-33	WY-13	38-6568	-

HOMELITE (TILLOTSON)			
MODEL	CARBURETOR MODEL	GSKT. / DIA. ORDER NO.	REPAIR KIT ORDER NO.
CHAINSAWS			
XL-901	HS-26A, 73A	38-1544	38-3644
XL-903, E, EAM	HS-73A	38-1544	38-3644
HL-904, EAM	HS-73A	38-1544	38-3644
XL-913, M, MS, MST, FD	HS-86B	38-1544	38-3644
XL-914M	HS-86B	38-1544	38-3644
XL-921, 923, FP, ST, KT	HS-151A	38-1544	38-3644
XL-924, SXL-925	HS-151A, 151B	38-1544	38-3644
Special SXL	HS-202A	38-1544	38-3644
XP-1000, W, WAO	HL-261A	38-1551	38-3644
XP-1020, AO, W, WAO,	HL-222A	38-1551	-
1020 Auto			
SXP-1020, Auto	HL-222A	38-1551	-
SXP-1020W&W Auto	HL-261A	38-1551	-
XP-1050 Auto	HL-222A	38-1551	-
SXP-1050E, Auto	HL-222A, 294A	38-1551	-
XP-1100, W, W-1	HL-261A	38-1551	-
XP-1130, W, W-1, 1, E,	HL-222A	38-1551	-
1 Auto			
SXP-1130, 1 Auto	HL-222A	38-1551	-
SXP-1130 2, W Auto	HL-261A	38-1551	-
SXP-1130 G Auto	HL-294A	38-1551	-
SXP-1130 M Auto	HL-273A	38-1551	-
2000 Auto, E Auto	HL-261A	38-1551	-
2000 M Auto, S2000	HL-273A	38-1551	-
2100, 2100S	HL-273A	38-1551	-
SXL-Auto	HS-4D, 142A	38-1544	38-3644
XLS-1 1/2-1A, 2	HS-5C, 5D	38-1544	38-3644
XLS-2	HS-154A	38-1544	38-3644
XLBC-4 (Bushcutter)	HS-109A	38-1544	38-3644
XL-2, Super 2	HK-36A	38-4922	38-4914
XL-12	HS-4D, 142A, 179B, 195A	38-1544	38-3644

HOMELITE (TILLOTSON) (cont.)			
MODEL	CARBURETOR MODEL	GSKT. / DIA. ORDER NO.	REPAIR KIT ORDER NO.
SXL-12, Auto	HS-4D, 142A	38-1544	38-3644
SXL-15, XL-15	HS-4D	38-1544	38-3644
XL-76	HS-125B	38-1544	38-3644
XL-98A	HS-135A	38-1544	38-3644
XL-98A/AP	HS-135B	38-1544	38-3644
XL-123-2	HS-132A	38-1544	38-3644
SXL-130, VI-130	HS-125B	38-1544	38-3644
XL-500, 660F	HS-4D	38-1544	38-3644
XL-700, XL-800, AM, EAM,	HS-26A	38-1544	38-3644
XL-850, XL-900, E, EAM	HS-73A	38-1544	38-3644
XL-850, 875	HS-104A	38-1551	-
4-20, 5-63, 6-663, 17L	HL-104A, 117C	38-1551	-
5-20L	HL-117C	38-1551	-
6-22, 7-19, 21, 63	HL-119A	38-1551	-
9-23, 26	HK-3B, 3C, 3D	38-4922	38-4915
150	HL-82A	38-1551	-
500, 500MOD	HL-104A	38-1551	-
600D, DI, MOD	HL-117C, 117E	38-1551	-
600D, 700 & 707, D&G,			
700, D, G, GS, 775, DI,			
DAI, GI, GAI, G2, GA2	HL-119A	38-1551	-
900, 909, 990D, G	HL-119A	38-1551	-
995, D, G, GI	HL-141D, 141E	38-1551	-
C5, C7, C9, C51, C52, C71,			
C72, C91			
DM-20	HS-202A	38-1544	38-3644
XL	HK-27A	38-4922	38-4915
XL	HS-4D, 142A	38-1544	38-3644
XL-Auto	HL-273A	38-1551	-
Super 2100 Auto, 3100G	HS-132A	38-1544	38-3644
VI-123, 125	HS-151A	38-1544	38-3644
VI-944, C, VI-955, C	HS-103B	38-1551	-
VI-944, VI-955	HL-82A	38-1551	-
Buz Buz	HL-104A	38-1551	-
EZ	HL-104A	38-1551	-
Wiz, A, B, Super Wiz, A	HL-104A	38-1551	-
Super Wiz 55, 66, 80, Wiz 55	HL-117C, 117E	38-1551	-
Super 2	HK-16C, 16D	38-4922	-
Super 77, 77-1, 71-1	HL-117C, 117E	38-1551	-
Zip A, B, 5, 5E, 5EX	HL-104A	38-1551	-
TRIMMERS			
ST-100	HU-42A	38-3667	38-4183
ST-400	HS-207A	38-1544	38-3644

HOMELITE (TK)			
MODEL	CARBURETOR MODEL	GSKT. / DIA. ORDER NO.	REPAIR KIT ORDER NO.
-Homelite ST80, 100, 120, 160, 200		38-4302	-



CARBURETOR KIT CHART

HOMELITE (WALBRO) (cont.)

MODEL	CARBURETOR MODEL	GSKT. / DIA. ORDER NO.	REPAIR KIT ORDER NO.
913FP, 914M, 921, 923, 924, 922, 925, XL Auto, 400AV	SDC-26, 8, 9, 13, 23, 27, 28, 82	38-4184	-
XL Mini, Mini Auto Generator	HDC-1, 4 HDC-7	38-4186 38-4186	- -
TRIMMERS			
ST-80, 100, 120	WA-43, 43A, 43B, 83, 83A	38-4179	38-4180
ST-155	WT-71, 71A, 95	38-4179	38-4180
ST-160, 200	HDC-59, 66, 69, 69A, 69B, 69C, 73	38-4186	-
BLOWERS			
HB-380, 480, 680	WT-69	38-4179	38-4180
J-501	SDC-68A	38-4184	-

HOMELITE (ZAMA)

MODEL	CARBURETOR MODEL	GSKT. / DIA. ORDER NO.	REPAIR KIT ORDER NO.
CHAINSAWS			
XL12, Super XL	20-02	38-4996	-
330	C1S-H3	38-5839	-
240	C1S-H4, H4A	38-5839	-
330 (2 fuel connector type)	C1S-H7	38-5839	-
245	C1S-H8	38-5840	-

HUSQVARNA (TILLOTSON)

MODEL	CARBURETOR MODEL	GSKT. / DIA. ORDER NO.	REPAIR KIT ORDER NO.
CHAINSAWS			
36R (Clearing Saw)	HU-37B, 37C	38-3667	38-4183
61	HS-163A, 163B	38-1544	38-3644
65, 65L	HS-123A, 23A	38-1544	38-3644
77, 77L	HS-123A, 23A, 23B	38-1544	38-3644
140R	HU-37B, 37C	38-3667	38-4183
160	HS-123A, 123B	38-1544	38-3644
162SE-G	163A, 16B	38-1544	38-3644
162	HS-163B	38-1544	38-3644
163	HS-122A	38-1544	38-3644
163S	HS-122A	38-1544	38-3644
165R (Clearing Saw)	HS-121A, 121B	38-1544	38-3644
170	HS-163A	38-1544	38-3644
180	HS-122A	38-1544	38-3644
180S	HS-122A	38-1544	38-3644
181	HS-216A, 216B	38-1544	38-3644
181SE, SG	HS-216A, 216B	38-1544	38-3644
185	HS-136A	38-1544	38-3644
244R (Clearing Saw)	HU-37B	38-3667	38-4183
260	HS-123A	38-1544	38-3644

HOMELITE (WALBRO)

MODEL	CARBURETOR MODEL	GSKT. / DIA. ORDER NO.	REPAIR KIT ORDER NO.
CHAINSAWS			
150 Auto	HDC-20, 45, 54	38-4186	-
190	HDC-57	38-4186	-
220	WT-1	38-4179	38-4180
240	WT-2, 6, 6A	38-4179	38-4180
245	WT-19, 19A	38-4179	38-4180
290	WT-72	38-4179	38-4180
330	WT-1, 4, 23	38-4179	38-4180
340	WT-72	38-4179	38-4180
350	HDA-75	38-4301	-
350	HDC-16, 21, 23, 33, 39, 39A, 46, 47, 78, 81	38-4186	-
350P	HDC-26, 46, 47	38-4186	-
360	HDA-75	38-4301	-
360	HDC-39, 39A, 46, 47, 77, 78, 81	38-4186	-
410	WB-22	38-4920	-
410	WS-16, 16A, 16B, 21, 21A, 21B, 22	38-4181	-
450	SDC-54, 54A, 54B, 54C, 62A, 63, 63A, 64	38-4184	-
550	SDC-66, 66A, 69, 69A	38-4184	-
650	WB-2	38-4920	-
700, 800	SDC-9	38-4184	-
750	WB-4, 9, 19	38-4920	-
1050A, 1130GA	SDC-60, 74	38-4184	-
DM-50	SDC-71	38-4184	-
EZ Auto, EZ, EZ 250, Auto, EZ Mini, EZ Mini Auto	HDC-1, 2, 4, 44, 64	38-4186	-
Super 1050A, 1130GA	SDC-60, 74	38-4184	-
Super 2	HDA-38, 60	38-4301	-
Super 2 VI	HDC-37, 41, 48A, 49, 58	38-4186	-
Super 2	HDC-27, 40, 48, 48A, 55, 57, 65	38-4186	-
Super EZ Auto	HDC-44, 64	38-4186	-
Super XL, Super XL Auto, XL12 Auto, XL15	SDC-6, 8, 29, 62, 62A, 82, 87	38-4184	-
Super XL Mini, VI Super 2, VI Super 2 SL	HDC-4, 58, 67B, 81, 81A	38-4186	-
VI 130	SDC-81, 81A	38-4184	-
Super XL-AO, Super 2, VI Super 2 SL	SDC-87	38-4184	-
XL, XL2, XL2 VI, XL2 XL	HDC-15, 28, 28A, 34, 35, 42, 43, 48, 48A, 49, 55, 65, 65A, 67, 67A, 67B, 67C	38-4186	-
XL12, XL12 Auto, XL100, XL101, 102, 102 Auto, 103, 104, XL112, 113, 114, 121, 122, 122E, 123, 123E	SDC-8, 1, 12, 21, 25, 29, 31, 32, 32, 48, 62, 62A	38-4184	-
XL150 Mini Auto	HDC-3	38-4186	-
XL400 Auto, 400 Auto FP, 700, 800, 800AM, 850, 900E, 900EAM, 901, 913, 913M,	SDC-26, 8, 9, 13, 23, 27, 28, 82	38-4184	-

2014 CARB. KIT CHART

CARBURETOR KIT CHART



HUSQVARNA (TILLOTSON) (cont.)			
MODEL	CARBURETOR MODEL	GSKT. / DIA. ORDER NO.	REPAIR KIT ORDER NO.
260CD	HS-122A	38-1544	38-3644
263	HS-123A	38-1544	38-3644
263CD	HS-122A	38-1544	38-3644
266SE, SG	HS-163A	38-1544	38-3644
280	HS-169A, 169B	38-1544	38-3644
280S	HS-122A	38-1544	38-3644
285CD	HS-136B, 136	38-1544	38-3644
380CD	HS-122A	38-1544	38-3644
380	HS-169A, 169B	38-1544	38-3644
380K	HS-141A, 170A, 170B	38-1544	38-3644
480K (Power Cutter)	HS-21	38-1544	38-3644
480CD	HS-205A	38-1544	38-3644
1100CD	HS-136B	38-1544	38-3644
2100	HS-13B	38-1544	38-3644
2100	HS-136D	38-1544	38-3644
2100CD	HS-136C	38-1544	38-3644
Husky 34	HU-4B	38-3667	38-4183
Husky 35	HU-18C	38-3667	38-4183
Husky 35VR	HU-18C	38-3667	38-4183

HUSQVARNA (WALBRO)			
MODEL	CARBURETOR MODEL	GSKT. / DIA. ORDER NO.	REPAIR KIT ORDER NO.
CHAINSaws			
33	WT-67, 67A, 79, 98	38-4179	38-4180
34	WA-8A	38-4179	38-4180
35, 37	WT-13	38-4179	38-4180
39R, 40	WT-17B, 17C, 17D	38-4179	38-4180
44	HDC-32A, 51B	38-4186	—
44	HDA-24	38-4301	—
61P	WS-17, 17A, 17B	38-4181	—
133	HDA-1, 12	38-4301	—
140	HDC-10, 32, 32A	38-4186	—
154	HDA-17, 17A, 18, 18A	38-4301	—
234	HDA-12	38-4301	—
234, 238	HDA-19, 19A, 34, 34A	38-4301	—
240S	HDC-32, 32A	38-4186	—
244RX	WT-17, 17A, 17B, 17C, 17D	38-4179	38-4180
254	HDA-35A, 35B	38-4301	—
444	HDC-51, 51A, 51B	38-4186	—
P400, Rancher 40	WT-17B, 17C, 17D	38-4179	38-4180
Rancher 40	WA-82, 82A	38-4179	38-4180
TRIMMERS			
16R	WA-74	38-4179	38-4180
22R, 22RL, 25R, 25RL	WY-55	38-6568	—

JACOBSEN (WALBRO)			
MODEL	CARBURETOR MODEL	GSKT. / DIA. ORDER NO.	REPAIR KIT ORDER NO.
BLOWERS			
J-501	SDC-68A	38-4184	—
JONSEREDS (WALBRO)			
MODEL	CARBURETOR MODEL	GSKT. / DIA. ORDER NO.	REPAIR KIT ORDER NO.
CHAINSaws			
52E	WS-5	38-4181	—
370	WT-67, 67A, 79, 98	38-4179	38-4180
410, 420, 435, 440, 450	HDA-3, 6, 6A, 40, 52, 52A, 68	38-4301	—
490	WA-121, 121A, 158, 158A	38-4179	38-4180
510, 520, 525	HDA-3, 52, 52A	38-4301	—
RS-45	HDA-6, 6A	38-4301	—

KAWASAKI (WALBRO)			
MODEL	CARBURETOR MODEL	GSKT. / DIA. ORDER NO.	REPAIR KIT ORDER NO.
TRIMMERS			
TG-24-DX	WT-103	38-4179	38-4180
TG18, 20, 28DX, 33DX	WA-204, 205	38-4179	38-4180
TF022-BA	WY-59	38-6568	—
TF22-DVX	WY-51, 64, 66, 67	38-6568	—
BLOWERS			
-TE48, 56	HDA-71, 72	38-4301	—

KOMATSU ZENOAH (WALBRO)			
MODEL	CARBURETOR MODEL	GSKT. / DIA. ORDER NO.	REPAIR KIT ORDER NO.
TRIMMERS			
BC260DUH, G2K	WY-4	38-6568	—
G2D20, G2D30	WY-14A	38-6568	—
G2D30D	WY-1, 14B, 63	38-6568	—
G2D31D	WY-2	38-6568	—
G2D39	WY-16	38-6568	—
G2K30D	WY-7	38-6568	—
G2KC	WY-33A, 52, 62, WYJ-9	38-6568	—
G3C65	WY-3	38-6568	—
XE14	WY-33	38-6568	—
G2D52	WY-39	38-6568	—
G2D46	WY-23	38-6568	—



CARBURETOR KIT CHART

McCULLOCH (WALBRO) (cont.)

MODEL	CARBURETOR MODEL	GSKT. / DIA. ORDER NO.	REPAIR KIT ORDER NO.
CHAINSaws			
Super 10-10, 710	SDC-16, 18	38-4184	-
Super Pro 60, 70, 81, 81X, 125, 125C	SDC-20, 38A, 50, 50A, 51, 51A, 51B, 58, 58A, 61	38-4184	-
TRIMMERS			
Mac-60, 80, 85, 95a	WA-81, 146, 147, 152, WT--37, 92	38-4179	38-4180
CUT OFF SAWS			
Pro Mac 650	HDB-2, 5, 7, 7A, 7B, 13	38-4182	-
MINI BIKE			
49E	SDC-43A	38-4184	-

McCULLOCH (ZAMA)

MODEL	CARBURETOR MODEL	GSKT. / DIA. ORDER NO.	REPAIR KIT ORDER NO.
CHAINSaws			
Super Pro 40, 300, 510	17-01, 01A, 01B, 01C, 17-02, 02A	38-4210	-
Pro Pump	61S-M9	38-5839	-
TRIMMERS			
Mac-60A, 80A	C1S-M8A, C1S-M11A	38-5839	-
Blower/Vac	C1S-M12	38-5839	-
Blower	C1S-M13	38-5839	-

MITSUBISHI (NIKKI)

MODEL	CARBURETOR MODEL	GSKT. / DIA. ORDER NO.	REPAIR KIT ORDER NO.
BLOWERS			
Mitsubishi T300 & up	BA401 Engines on Snapper, Toro, Red Max Blowers	38-6893	-

MITSUBISHI (WALBRO)

MODEL	CARBURETOR MODEL	GSKT. / DIA. ORDER NO.	REPAIR KIT ORDER NO.
BRUSH CUTTER			
T110, 140	WY-50, 55	38-6568	-
TM-24PSE	WYK-6A, 17	38-6568	-
TM-33PFD	WYK-15	38-6568	-

OLYMPIK (WALBRO)

MODEL	CARBURETOR MODEL	GSKT. / DIA. ORDER NO.	REPAIR KIT ORDER NO.
CHAINSaws			
95A	HDA-30	38-4301	-
233, 234, 240, 340	WA-73, 73A, 73B, 203	38-4179	38-4180

MARUZEN KOHGYO (WALBRO)

MODEL	CARBURETOR MODEL	GSKT. / DIA. ORDER NO.	REPAIR KIT ORDER NO.
DRILL/BREAKER			
MA-120	SDC-78B	38-4184	-
ML-150	SDC-78A	38-4184	-

McCULLOCH (TILLOTSON)

MODEL	CARBURETOR MODEL	GSKT. / DIA. ORDER NO.	REPAIR KIT ORDER NO.
CHAINSaws			
10-100EM	HS-152A	38-1544	38-3644
SP-60	HS-111A	38-1544	38-3644
G-70	HS-71A, 127A	38-1544	38-3644
PM-105	HL-291A	38-1551	-
SP-105, 125	HS-124A	38-1544	38-3644
710A	HS-127A	38-1544	38-3644
895	HL-291A	38-1544	38-3644

McCULLOCH (WALBRO)

MODEL	CARBURETOR MODEL	GSKT. / DIA. ORDER NO.	REPAIR KIT ORDER NO.
CHAINSaws			
2-10, 3-10, 5-10, 5-10A	SDC-2, 3	38-4184	-
6-10			
7-10, 7-10A	SDC-22, 44, 44A, 58, 58A	38-4184	-
10-10, 10-10A	SDC-37, 37A, 44, 44A, 65	38-4184	-
210, 210AV	SDC-18	38-4184	-
380	WT-55A	38-4179	38-4180
510, 610AV, 710	SDC-18, 44, 44A	38-4184	-
CT125, CP55, CP80	SDC-20, 37A, 38, 38A	38-4184	-
Double Eagle 50	HDA-36, 66	38-4301	-
Double Eagle 80	SDC-85	38-4184	-
Double Eagle 150	HDC-46	38-4186	-
Eagle Beaver I, II, III	WA-146, 152	38-4179	38-4180
Mac 15	SDC-7	38-4184	-
Mac 30A	WT-55A	38-4179	38-4180
Mac 55A	WA-152	38-4179	38-4180
Mini Mac 6, 20, 25, 30, 35, 110, 120, 130, 140, 140A, 150, 150A, 160	MDC-2, 3, 4, 5, 6, 7, 8, 9, 13, 15, 15A, 16	38-4209	-
Power Mac 6			
Power Mac 555	SDC-44	38-4184	-
Power Mac 570, 850	SDC-38A	38-4184	-
Power Mac 655	HDB-7A	38-4182	-
Pro Mac 38AV	WT-102	38-4179	38-4180
Pro Mac 10, 10A, 55, 60	SDC-43, 44, 44A, 49, 58, 58A	38-4184	-
Pro Mac 155, 165	MDC-15, 15A, 16	38-4209	-
Pro Mac 300, 510	WA-48, 52, 52A	38-4179	38-4180
Pro Scraper I	WA-146	38-4179	38-4180
Pro Mac 610, 650, 690	HDB-1, 2, 4, 5, 6, 6A, 6B, 7A, 7B, 13, 14, 14A	38-4182	-

2014

CARB. KIT CHART



CARBURETOR KIT CHART

CARB. KIT CHART 2014

PIONEER/PARTNER (WALBRO)

MODEL	CARBURETOR MODEL	GSKT. / DIA. ORDER NO.	REPAIR KIT ORDER NO.
CHAINSaws			
360	WT-98	38-4179	38-4180
A55, F55, 65	WS-10, 10A, 18, 18A	38-4181	—
F360	WT-67, 67A, 79	38-4179	38-4180
P20, 25	WA-22, 22A	38-4179	38-4180
P30	HDC-30	38-4186	—
P41, 42, 50, 51, 52, 61, 62, 70	SDC-53A, 53B, 53C, 53D, 80	38-4184	—
P400	WT-17, 17B, 17C, 17D	38-4179	38-4180
P500, 5000	WA-82, 82A, 158, 158A	38-4179	38-4180
P5500	WT-109	38-4179	38-4180
P7000	WA-18A	38-4181	—
R39, 40	WT-17B, 17C	38-4179	38-4180
K500	WT-34, 34A	38-4179	38-4180
1073, 1074	WA-22, 22A	38-4179	38-4180
TMC	WT-13	38-4179	38-4180
R30	SDC-30	38-4184	—
Multimot 100	SDC-79A	38-4184	—

POULAN (TILLOTSON)

MODEL	CARBURETOR MODEL	GSKT. / DIA. ORDER NO.	REPAIR KIT ORDER NO.
CHAINSaws			
20	HU-22A	38-3667	38-4183
25, 25D, 25DA	HU-10A	38-3667	38-4183
Micro 25	HU-10A	38-3667	38-4183
Micro 25D	HU-10A	38-3667	38-4183
Micro 25CVA	HU-10A	38-3667	38-4183
Super 25	HU-10B	38-3667	38-4183
53, 53A	HL-276A	38-1551	—
54, 568	HL-284A	38-1551	—
71, 71A	HL-276A	38-1551	—
72, S72	HL-284A	38-1551	—
100, 100E	HS-58A, 58B	38-1544	38-3644
201, 202, 203	HS-59A, 59B	38-1544	38-3644
221, 222, 223	HS-59A, 59B	38-1544	38-3644
245, 245A	HS-59A, 59B	38-1544	38-3644
252	HS-83A	38-1544	38-3644
306, 306A, 306SA	HS-59A, 59B, 198A	38-1544	38-3644
360, 361, 400	HS-59A, 59B	38-1544	38-3644
401, 450, 451	HS-59A, 59B	38-1544	38-3644
744	HS-83A	38-1544	38-3644
4200, 4400, 4900	HS-168A	38-1544	38-3644
5200, 5400	HS-176A	38-1544	38-3644
B520	HL-202A	38-1551	—
TRIMMERS			
TC14	WA-120, 120A	38-4179	38-4180
TC21	WA-120, 120A	38-4179	38-4180

PIONEER/PARTNER (TILLOTSON)

MODEL	CARBURETOR MODEL	GSKT. / DIA. ORDER NO.	REPAIR KIT ORDER NO.
CHAINSaws			
P41	HS-147D	38-1544	38-3644
P41S	HS-147D	38-1544	38-3644
P40	HS-147A, 147B, 147C, 147D	38-1544	38-3644
Farm Saw	HS-147D	38-1544	38-3644
3071	HS-116A, 116B	38-1544	38-3644
3270SC	HS-146A	38-1544	38-3644
3270S	HS-39B	38-1544	38-3644
3270	HS-39B	38-1544	38-3644
3200	HS-39B	38-1544	38-3644
2460	HS-39A	38-1544	38-3644
2400	HS-39A	38-1544	38-3644
1560	HS-39A	38-1544	38-3644
1500	HS-39A	38-1544	38-3644
1450	HS-39A	38-1544	38-3644
1420	HS-39A	38-1544	38-3644
1410A	HS-16B	38-1544	38-3644
1410	HS-16B	38-1544	38-3644
1200A	HS-44A	38-1544	38-3644
1200	HS-44A	38-1544	38-3644
2270	HS-66A	38-1544	38-3644
2200	HS-66A	38-1544	38-3644
GTA	HS-16B	38-1544	38-3644
1150	HS-16B	38-1544	38-3644
1130GT	HS-16B	38-1544	38-3644
1130	HS-16B	38-1544	38-3644
1120	HS-16B	38-1544	38-3644
1100G	HS-44B	38-1544	38-3644
1100W	HS-44A	38-1544	38-3644
1100V	HS-44A	38-1544	38-3644
1100	HS-12A	38-1544	38-3644
P28	HU-15E	38-3667	38-4183
P25	HU-15E	38-3667	38-4183
P21	HU-15E	38-3667	38-4183
P20	HU-15A	38-3667	38-4183
2037	HU-15A	38-3667	38-4183
1073	HU-15A	38-3667	38-4183
P12	HU-18C	38-3667	38-4183
650	HL-129A	38-1551	—
S650	HL-129A	38-1551	—
600, 610, 620	HL-22A	38-1551	—
450, 550	HL-108A	38-1551	—
NUJ-17	HL-108A	38-1551	—
P51T	HS-211A	38-1544	38-3644
P60T	HS-211A	38-1544	38-3644
P61	HS-213A	38-1544	38-3644
P61S	HS-213A	38-1544	38-3644
P41T	HS-214A	38-1544	38-3644



CARBURETOR KIT CHART

SHINDAIWA (WALBRO) (cont.)

MODEL	CARBURETOR MODEL	GSKT. / DIA. ORDER NO.	REPAIR KIT ORDER NO.
TRIMMERS			
F-21 or RE-21	WY-24B	38-6568	-
R-25	WY-43	38-6568	-
F-18, T-18	WYP-1A	38-6568	-

SOLO (WALBRO)

MODEL	CARBURETOR MODEL	GSKT. / DIA. ORDER NO.	REPAIR KIT ORDER NO.
CHAINSAWS			
640	SDC-24	38-4184	-

STIHL (TILLOTSON)

MODEL	CARBURETOR MODEL	GSKT. / DIA. ORDER NO.	REPAIR KIT ORDER NO.
CHAINSAWS			
Contra	HL-74A, 102A, 112	38-1551	-
07 Series	HL-121A, 121B, 147B, 155A	38-1551	-
08	HL-166B, 292B	38-1551	-
08S	HL-166A, 166B	38-1551	-
020AV, 020	HU-74	38-3667	38-4183
020S	HU-60A	38-3667	38-4183
024	HU-54A, 54B	38-3667	38-4183
028AV	HU-40A	38-3667	38-4183
030, 031 Series	HU-3C	38-3667	38-4183
032	HU-51A	38-3667	38-4183
038 Series	HK-29A, HK-42A	38-4922	38-4912
041 Series	HS-29A, 29B, 29C, 29D, 77A, 77B, 77C, 87A, 100A, 138A, 208A	38-1544	38-3644
041FB	HS-181A	38-1544	38-3644
045AV	HS-118A	38-1544	38-3644
050AV	HS-60A, 60B	38-1544	38-3644
051AV	HS-60A, 60B, 60C, 60D, 60E	38-1544	38-3644
056AV	HS-118A	38-1544	38-3644
056Z	HS-221A	38-1544	38-3644
070	HL-244A, 324A	38-1551	-
075	HS-60C	38-1544	38-3644
090	HL-244A, 324A	38-1551	-
090G	HL-244A	38-1551	-
090AV	HL-244A	38-1551	-
S10	HL-62A, 62B	38-1551	-
TS08	HL-292B	38-1551	-

POULAN (WALBRO)

MODEL	CARBURETOR MODEL	GSKT. / DIA. ORDER NO.	REPAIR KIT ORDER NO.
CHAINSAWS			
Model 20, 20D	WA-18	38-4179	38-4180
CS-1800, 2000, 2300	WT-3, 20	38-4179	38-4180
CS-2800	HDA-49	38-4301	-
CS-2800	HDB-18	38-4182	-
CS-3000, 3400, 3700, 4000	HDB-8, 8A, 8B, 8C, 18, 19	38-4182	-
Micro XXV	WT-3, 20	38-4179	38-4180
PB-20, 25	WA-18, 19, 19A	38-4179	38-4180
S25D, S25DA, XXV	WA-19A, 20	38-4179	38-4180
Super 25	WT-83	38-4179	38-4180
TRIMMERS			
599	WA-46, 46A, 80, 80A	38-4179	38-4180
600, 607, 608	WA-45, 45A	38-4179	38-4180
1400, 1500, 1600	WA-79, 149, 149A, 198	38-4179	38-4180
1700, 1740, 2215	WT-63	38-4179	38-4180

RYAN (WALBRO)

MODEL	CARBURETOR MODEL	GSKT. / DIA. ORDER NO.	REPAIR KIT ORDER NO.
TRIMMERS			
99	WA-62, 62A	38-4179	38-4180
551, 5511	WT-5, 11, 18, 24, 26, 58, 59	38-4179	38-4180
1300, 1360, 1330	WA-62B, 62C	38-4179	38-4180

RYAN (ZAMA)

MODEL	CARBURETOR MODEL	GSKT. / DIA. ORDER NO.	REPAIR KIT ORDER NO.
TRIMMERS			
K & S Brand	C1S-P1	38-5839	-

ROPER/SEARS (WALBRO)

MODEL	CARBURETOR MODEL	GSKT. / DIA. ORDER NO.	REPAIR KIT ORDER NO.
CHAINSAWS			
Anti Vibe	SDC-73	38-4184	-
CJD Sears	SDC-67, 67A	38-4184	-

SHINDAIWA (WALBRO)

MODEL	CARBURETOR MODEL	GSKT. / DIA. ORDER NO.	REPAIR KIT ORDER NO.
CHAINSAWS			
E300	WYM-1A	38-6568	-



CARBURETOR KIT CHART

STIHL (WALBRO)

MODEL	CARBURETOR MODEL	GSKT. / DIA. ORDER NO.	REPAIR KIT ORDER NO.
CHAINSAWS			
009, 010, 011, 011AV	WA-56, 56A, 56B, 56C, 56D, 99, 99A, 99B	38-4179	38-4180
015, 015AV	HDC-17, 17A, 17B	38-4186	-
020, 020AV, 020AVP	WA-10, 86D, 1A, 1B, 1C, 1D, 86, 86A, 86B, 86C, 86D	38-4179	38-4180
020, 020AV, 020AVP, 024	WT-15A, 15A, 22A, 22B	38-4179	38-4180
028AV	WA-128	38-4179	38-4180
028AV, 028AVE	WT-16, 16A, 16B	38-4179	38-4180
031AV	WA-2, 2A, 2B, 2C	38-4179	38-4180
032	WT-27	38-4179	38-4180
032AV, 032AVE	WA-49, 49A, 49B, 49C	38-4179	38-4180
042, 043, 051, 051AV, 075, 075AV, 076 Super	WS-3, 11, 13, 26A	38-4181	-
1116	HDC-17, 17A, 17B	38-4186	-
1120	WA-99B, WT-21, 29, 29A	38-4179	38-4180
SG-17	HDC-17B	38-4186	-
TRIMMERS			
H-24D	WT-45A	38-4179	38-4180
FS-50, 51, 61, 65, 90	WT-38, 38A, 38B	38-4179	38-4180
FS-150, 200AV	WA-86B, 86C, 86D	38-4179	38-4180
FS-220	WT-70	38-4179	38-4180
TS-200AV	WA-1B, 86B, 86C, 86D	38-4179	38-4180
HS-151	HDC-17B	38-4179	38-4180

STIHL (ZAMA)

MODEL	CARBURETOR MODEL	GSKT. / DIA. ORDER NO.	REPAIR KIT ORDER NO.
CHAINSAWS			
011AV, 011AVEQ	C1S-S1, C1S-S1A, C1S-S1B	38-5840	-
TRIMMERS			
FS-220	C1S-S2	38-5840	-
FS-280/300	C1S-S3, S3A, S3B, S3C	38-5840	-

TANAKA (WALBRO)

MODEL	CARBURETOR MODEL	GSKT. / DIA. ORDER NO.	REPAIR KIT ORDER NO.
CHAINSAWS			
ECS-3, 35A, 35B, 35E	WA-13, 13A, 65	38-4179	38-4180
ECS-290, 300	WT-50, 50A, 65	38-4179	38-4180
ECS-350, 351, 355, 356	WA-65	38-4179	38-4180
ECS-370, 405	WA-126	38-4179	38-4180
ECS-415	WA-154, 155	38-4179	38-4180
ECS-505	WA-119, 119A	38-4179	38-4180
ECS-506	HDA-13, 13A, 13B, 15, 15A, 54	38-4301	-

TANAKA (WALBRO) (cont.)

MODEL	CARBURETOR MODEL	GSKT. / DIA. ORDER NO.	REPAIR KIT ORDER NO.
CHAINSAWS			
ECS-650	HDA-13, 13A, 13B, 54	38-4301	-
EHC-120	HDA-13B	38-4301	-
SP-411	WA-151A	38-4179	38-4180
SP-471D	WA-206	38-4179	38-4180
TRIMMERS			
ST-1600	WA-182	38-4179	38-4180
T-322	WA-127, 127A	38-4179	38-4180
TBC-160, 162	WA-110	38-4179	38-4180
TBC-205	WA-117	38-4179	38-4180
TBC-215	WA-134, 134A	38-4179	38-4180
TBC-262	WA-164	38-4179	38-4180
TBC-322	WA-127, 127A	38-4179	38-4180
TC-215	WA-195, 195A	38-4179	38-4180
TEA-500	HDA-43, 43A	38-4301	-
TED-232	WA-12, 12A, 12B, 12C	38-4179	38-4180
THT-16, 162	WA-110	38-4179	38-4180
THT-262	WA-164	38-4179	38-4180
HD-200	WY-68	38-6568	-
SW-162	WY-48	38-6568	-
TBC-160, 202	WY-5B	38-6568	-
TBC-202	WY-6B	38-6568	-
TBC-220	WY-45, 53	38-6568	-
TBC-240	WY-47	38-6568	-
TBC-265	WY-49	38-6568	-
TBC-5000	WY-56	38-6568	-
TC-202	WY-5B, 6B	38-6568	-
TC-212, 212AJ	WY-42, 68	38-6568	-
TC-219	WY-8C	38-6568	-
TST218	WY-54A	38-6568	-
SW-163	WY-65	38-6568	-
THT-200	WY-9C	38-6568	-
THT-212, 230	WY-8C	38-6568	-
POWER BLOWER			
PB-30, THB-300	WY-15	38-6568	-

TECUMSEH (WALBRO)

MODEL	CARBURETOR MODEL	GSKT. / DIA. ORDER NO.	REPAIR KIT ORDER NO.
CHAINSAWS			
TC-200	WTA-3, 3A	38-4179	38-4180

TORO (WALBRO)

MODEL	CARBURETOR MODEL	GSKT. / DIA. ORDER NO.	REPAIR KIT ORDER NO.
SNOWBLOWERS			
21CC	WA-66, WTA-2	38-4179	38-4180



TORO (WALBRO) (cont.)

MODEL	CARBURETOR MODEL	GSKT. / DIA. ORDER NO.	REPAIR KIT ORDER NO.
TRIMMERS			
TC14, 21	WA-120, 120A	38-4179	38-4180
TC21-TA	WT-14	38-4179	38-4180
TC700	WA-81	38-4179	38-4180

WEEDEATER (WALBRO)

MODEL	CARBURETOR MODEL	GSKT. / DIA. ORDER NO.	REPAIR KIT ORDER NO.
TRIMMERS			
202D	WA-28	38-4179	38-4180
599	WA-46, 46A, 80, 80A	38-4179	38-4180
600 Engine KEH	WA-28	38-4179	38-4180
600 Engine K3W	WA-45, 45A	38-4179	38-4180
607, 608	WA-28	38-4179	38-4180
609 Engine K3AW	WA-59A	38-4179	38-4180
609 Engine K3W	WA-45, 45A	38-4179	38-4180
1500	WA-79, 149, 149A	38-4179	38-4180
XR Series	WA-79, 149, 149A	38-4179	38-4180



OEM REPLACEMENT BELT APPLICATION GUIDE

2014 BELT APPLICATION

OEM No.	Size	Premium Order No.	Aramid Order No.	OEM No.	Size	Premium Order No.	Aramid Order No.	OEM No.	Size	Premium Order No.	Aramid Order No.
ALLIS CHALMERS See SIMPLICITY				ARIENS (Cont.)				AYP (Cont.)			
AMF See NOMA				72110	1/2" x 70"	12-5103	12-7513	5029H	5/8" x 96"	12-5223	12-7641
ARIENS				72111	1/2" x 34"	12-5067	12-7477	5091H	5/8" x 82"	12-5209	12-7627
*72023	1/4" x 27.153	12-8762		72112	3/8" x 35"	12-5018	12-7440	5125R	1/2" x 68"	12-5101	12-7511
72024	1/2" x 29"	12-5062	12-7472	72113	1/2" x 65"	12-5098	12-7508	518J	1/2" x 69"	12-5102	12-7512
72026	5/8" x 41"	12-5168	12-7586	72114	1/2" x 34"	12-5067	12-7477	52918	1/2" x 34"	12-5067	12-7477
72029	5/8" x 49"	12-5176	12-7594	*72114	1/2" x 34"	12-8425		53013	1/2" x 32"	12-5065	12-7475
72030	1/2" x 53"		12-7496	72115	1/2" x 67"	12-5100	12-7510	53558	1/2" x 35"	12-5068	12-7478
72031	3/8" x 28"	12-5011	12-7433	72116	1/2" x 71"	12-5104	12-7514	5357H1	5/8" x 53"	12-5180	12-7598
72038	1/2" x 53"	12-5086	12-7496	72117	1/2" x 30"	12-5063	12-7473	53598	1/2" x 33"	12-5066	12-7476
72040	3/8" x 39"	12-5022	12-7444	72118	1/2" x 47"	12-5080	12-7490	53987	1/2" x 29"	12-5062	12-7472
72042	3/8" x 33"	12-5016	12-7438	72119	1/2" x 31"	12-5064	12-7474	5417J	1/2" x 52"	12-5085	12-7495
72042	3/8" x 34"	12-5017	12-7439	72121	1/2" x 34"	12-5067	12-7477	54622	1/2" x 25"	12-5058	12-7468
72043	3/8" x 32"	12-5015	12-7437	72122	1/2" x 72"	12-5105	12-7515	5437R	1/2" x 51"	12-5084	12-7494
72044	5/8" x 49"	12-5176	12-7594	72123	1/2" x 52"	12-5085	12-7495	5559H	5/8" x 80"	12-5207	12-7625
72045	5/8" x 36"	12-5163	12-7581	72124	1/2" x 65"	12-5098	12-7508	5559J	1/2" x 94"	12-5127	12-7537
72046	3/8" x 31"	12-5014	12-7436	72125	1/2" x 21"	12-5054		55936	5/8" x 80"	12-5207	12-7625
*72047	3/8" x 35-1/2"	12-8432		72128	1/2" x 63"	12-5096	12-7506	55941	5/8" x 71"	12-5198	12-7616
72048	3/8" x 28"	12-5011	12-7433	72130	1/2" x 39"	12-5072	12-7482	5600H	5/8" x 48"	12-5175	12-7593
72049	5/8" x 47"	12-5174	12-7592	72130	1/2" x 39"	12-8427		56823	5/8" x 82"	12-5209	12-7627
72050	5/8" x 44"	12-5171	12-7589	72131	3/8" x 36"	12-5019	12-7441	57955	1/2" x 70"	12-5103	12-7513
72052	5/8" x 69"	12-5196	12-7614	*72131	3/8" x 36"	12-8426		58406	1/2" x 65"	12-5098	12-7508
72053	5/8" x 48"	12-5175	12-7593	72132	1/2" x 42"	12-5075	12-7485	584J	3/8" x 36"	12-5019	12-7441
72055	3/8" x 39"	12-7444		72134	5/8" x 33"	12-5160	12-7578	58558	1/2" x 49"	12-5082	12-7492
72056	1/2" x 32"	12-5065	12-7475	72135	5/8" x 68"	12-5195	12-7613	58577	1/2" x 63"	12-5096	12-7506
72059	5/8" x 43"	12-5170	12-7588	72138	3/8" x 33"	12-5016	12-7438	5859H	5/8" x 57"	12-5184	12-7602
72060	1/2" x 28"	12-5061	12-7471	72142	1/2" x 34"	12-5067	12-7477	5904H	1/2" x 80"	12-5113	12-7523
72061	1/2" x 37"	12-5070	12-7480	72144	1/2" x 89"	12-5122	12-7532	5928J	1/2" x 88"	12-5121	12-7531
72062	1/2" x 48"	12-5081	12-7491	72145	1/2" x 65"	12-5098	12-7508	59311	3/8" x 21"	12-5004	
72065	3/8" x 36"	12-5019	12-7441	72157	3/8" x 36"	12-5019	12-7441	59786	1/2" x 28"	12-5061	12-7471
72066	3/8" x 34"	12-5017	12-7439	72169	1/2" x 65"	12-5098	12-7508	59849	1/2" x 73"	12-5106	12-7516
*72066	3/8" x 34"	12-8430		*7200004	1/2" x 35.4"	12-13505		59884	1/2" x 41"	12-5074	12-7484
72067	1/2" x 37"	12-5070	12-7480	*7200007	1/2" x 34-7/8"	12-13509		6095R	1/2" x 66"	12-5099	12-7509
72069	5/8" x 41"	12-5168	12-7586	*7200020	1/2" x 37-1/8"	12-13508		6118R	5/8" x 76"	12-5203	12-7621
72070	5/8" x 46"	12-5173	12-7591	*7200021	1/2" x 38"	12-13507		62411	5/8" x 36"	12-5163	12-7581
72071	1/2" x 38"	12-5071	12-7481	*7207400	1/4" x 27"	12-13284		62828	1/2" x 70"	12-5103	12-7513
72072	1/2" x 37"	12-5070	12-7480	*7236200	1/2" x 37-1/2"	12-13506		62828	1/2" x 69-1/2"	12-8510	
72073	3/8" x 28"	12-5011	12-7433	AYP-SEARS/ROPER							
*72074	1/4" x 27"	12-13284		530H	5/8" x 38"	12-5165	12-7583	634A563	1/2" x 37"	12-5070	12-7480
72075	1/2" x 55"	12-5088	12-7498	1125H	1/2" x 42"	12-5075	12-7485	6474H	5/8" x 81"	12-5208	12-7626
72076	1/2" x 50"	12-5083	12-7493	1310R	1/2" x 29"	12-5062	12-7472	65016	5/8" x 46"	12-5173	12-7591
72077	1/2" x 51"	12-5084	12-7494	1322H	5/8" x 29"	12-5156	12-7574	65133	3/8" x 32"	12-5015	12-7437
72078	5/8" x 77"	12-5204	12-7622	1323H	5/8" x 70"	12-5197	12-7615	6517H	5/8" x 100"	12-5227	12-7645
72079	5/8" x 45"	12-5172	12-7590	1563R	5/8" x 50"	12-5177	12-7595	66114	5/8" x 57"	12-5184	12-7602
72082	3/8" x 29"	12-5012	12-7434	1568R	5/8" x 50"	12-5177	12-7595	67346	1/2" x 39"	12-5072	12-7482
72084	3/8" x 30"	12-5013	12-7435	1629J	1/2" x 83"	12-5116	12-7526	67398	1/2" x 53"	12-5086	12-7496
72085	3/8" x 32"	12-5015	12-7437	1693H	1/2" x 53"	12-5086	12-7496	67403	1/2" x 60"	12-5093	12-7503
72086	1/2" x 40"	12-5073	12-7483	1835R	5/8" x 56"	12-5183	12-7601	6774H	5/8" x 81"	12-5208	12-7626
*72086	1/2" x 40"	12-8431		1836R	5/8" x 55"	12-5182	12-7600	67788	1/2" x 78"	12-5111	12-7521
72087	5/8" x 48"	12-5175	12-7593	187H	3/8" x 24"	12-5007	12-7429	68620	1/2" x 56"	12-5089	12-7499
72088	3/8" x 22"	12-5005		2049109	1/2" x 43"	12-5076	12-7486	6942R	1/2" x 87"	12-5120	12-7530
72089	1/2" x 36"	12-5069	12-7479	2295R	5/8" x 82"	12-5209	12-7627	6943R	1/2" x 92"	12-5125	12-7535
72091	1/2" x 48"	12-5081	12-7491	2614J	3/8" x 44"	12-5027	12-7449	6944R	5/8" x 71"	12-5198	12-7616
72092	5/8" x 44"	12-5171	12-7589	2630R	5/8" x 68"	12-5195	12-7613	70637	1/2" x 40"	12-5073	12-7483
72093	1/2" x 31"	12-5064	12-7474	2692R	5/8" x 84"	12-5211	12-7629	7080J	1/2" x 61"	12-5094	12-7504
72094	3/8" x 27"	12-5010	12-7432	2851H	1/2" x 92"	12-5125	12-7535	71240	1/2" x 92"	12-5125	12-7535
72095	1/2" x 46"	12-5079	12-7489	2920J	1/2" x 36"	12-5069	12-7479	71635	1/2" x 63"	12-5096	12-7506
72096	1/2" x 50"	12-5083	12-7493	2921J	1/2" x 47"	12-5080	12-7490	7140R	1/2" x 40"	12-5073	12-7483
72097	3/8" x 26"	12-5009	12-7431	311J	3/8" x 41"	12-5024	12-7446	72561	1/2" x 51"	12-5084	12-7494
72098	3/8" x 33"	12-5016	12-7438	3350R	1/2" x 91"	12-5124	12-7534	72927	1/2" x 57"	12-5090	12-7500
*72098	3/8" x 33"	12-8429		3496H	1/2" x 27"	12-5060	12-7470	7303J	1/2" x 100"	12-5133	12-7543
72099	3/8" x 31"	12-5014	12-7436	3541R	5/8" x 71"	12-5198	12-7616	7304J	5/8" x 100"	12-5227	12-7645
72101	1/2" x 58"	12-5091	12-7501	3555R	5/8" x 103"	12-6645	12-7648	7335H	1/2" x 45"	12-5078	12-7488
72102	1/2" x 75"	12-5108	12-7518	3568H	5/8" x 28"	12-5155	12-7573	73794	1/2" x 94"	12-5127	12-7537
72103	1/2" x 90"	12-5123	12-7533	3703J	1/2" x 99"	12-5132	12-7542	74164	1/2" x 51"	12-5084	12-7494
72105	1/2" x 37"	12-5070	12-7480	3717R	1/2" x 92"	12-5125	12-7535	74212	1/2" x 57"	12-5090	12-7500
72106	3/8" x 37"	12-5020	12-7442	3746R	1/2" x 87"	12-5120	12-7530	74277	1/2" x 61"	12-5094	12-7504
72108	1/2" x 37"	12-5070	12-7480	3747R	1/2" x 92"	12-5125	12-7535	74278	1/2" x 80"	12-5113	12-7523
72108	1/2" x 37"	12-8428		3754H	3/8" x 33"	12-5016	12-7438	7445J	1/2" x 52"	12-5085	12-7495
*72108	1/2" x 37"	12-5065	12-7475	4029H	5/8" x 96"	12-5223	12-7641	75443	3/8" x 34"	12-5017	12-7439
72109	1/2" x 32"	12-5065	12-7475	4376J	1/2" x 49"	12-5082	12-7492	75794	1/2" x 93"	12-5126	12-7536
				4797J	1/2" x 61"	12-5094	12-7504	76018	1/2" x 41"	12-5074	12-7484
				4798J	1/2" x 78"	12-5111	12-7521	76019	1/2" x 55"	12-5088	12-7498
				4833H	1/2" x 41"	12-5074	12-7484	76274	1/2" x 59"	12-5092	12-7502
				4897H	1/2" x 37"	12-5070	12-7480	76275	1/2" x 76"	12-5109	12-7519
				4965R	5/8" x 64"	12-5191	12-7609	74278	1/2" x 80"	12-5113	12-7523
				5000H	5/8" x 25"	12-5152	12-7570	7445J	1/2" x 52"	12-5085	12-7495
								75443	3/8" x 34"	12-5017	12-7439
								75794	1/2" x 93"	12-5126	12-7536
								76018	1/2" x 41"	12-5074	12-7484
		</									

OEM REPLACEMENT BELT APPLICATION GUIDE



OEM		Premium	Aramid	OEM		Premium	Aramid	OEM		Premium	Aramid
No.	Size	Order No.	Order No.	No.	Size	Order No.	Order No.	No.	Size	Order No.	Order No.
AYP (Cont.)				AYP (Cont.)				BOLENS			
77386	1/2" x 35"	12-5068	12-7478	139573	1/2" x 83-1/2"		12-9368	150175	5/8" x 47"	12-5174	12-7592
78750	1/2" x 39"	12-5072	12-7482	*140067	1/2" x 82-1/2"		12-8464	150180	1/2" x 49"	12-5082	12-7492
78303	1/2" x 36"	12-5069	12-7479	140218	1/2" x 84.5"		12-8781	1108450	1/2" x 17"	12-5050	
8100H	5/8" x 79"	12-5206	12-7624	140294	1/2" x 81-1/16"		12-9336	1108453	1/2" x 20"	12-5053	
81229	3/8" x 36"	12-5019	12-7441	*141416	1/2" x 82-11/16		12-9337	1108454	1/2" x 21"	12-5054	
81784	1/2" x 27"	12-5060	12-7470	141416	1/2" x 82-11/16		12-9337	1108455	1/2" x 22"	12-5055	
8225R	1/2" x 37"	12-5070	12-7480	*144200	1/2 x 88-3/8"		12-8516	1108456	1/2" x 23"	12-5056	12-7466
83691	3/8" x 35"	12-5018	12-7440	144959	1/2" x 95-1/2"		12-9697	1108459	1/2" x 26"	12-5059	12-7469
8377J	1/2" x 59"	12-5092	12-7502	*144959	1/2" x 94-1/16"		12-9333	1108460	1/2" x 27"	12-5060	12-7470
8718H	5/8" x 49"	12-5176	12-7594	146527	3/8" x 32-1/2"	12-9848		1108461	1/2" x 28"	12-5061	12-7471
8833H	5/8" x 73"	12-5200	12-7618	148763	5/8" x 85-3/8"	12-9698		1108462	1/2" x 29"	12-5062	12-7472
8845R	1/2" x 74"	12-5107	12-7517	156971	1/2" x 82"		12-10008	1108463	1/2" x 30"	12-5063	12-7473
9179R	3/8" x 39"	12-5022	12-7444	*157769	3/8" x 32-3/16"	12-10306		1108464	1/2" x 31"	12-5064	12-7474
9180R	1/2" x 41"	12-5074	12-7484	158818	1/2" x 83-5/8"		12-9312	1108466	1/2" x 33"	12-5066	12-7476
*9180R	1/2" x 41-1/2"		12-9769	*106412X	1/2" x 69"		12-8512	1108467	1/2" x 34"	12-5067	12-7477
930R	5/8" x 55"	12-5182	12-7600	*106729X	5/8" x 47-1/2"		12-8659	1108468	1/2" x 35"	12-5068	12-7478
9495H	1/2" x 87"	12-5120	12-7530	161597	1/2" x 82-1/2"		12-10078	1108469	1/2" x 36"	12-5069	12-7479
9496H	1/2" x 92"	12-5125	12-7535	161741	1/2" x 79"		12-9767	1108470	1/2" x 37"	12-5070	12-7480
9517H	5/8" x 49"	12-5176	12-7594	163817	1/2" x 95"		12-9768	1108473	1/2" x 40"	12-5073	12-7483
973R	5/8" x 55"	12-5182	12-7600	165555	1/2" x 108.5"		12-10005	1108474	1/2" x 41"	12-5074	12-7484
9787M	1/2" x 43"	12-5076	12-7486	*169178	AA x 114"		12-12423	1108475	1/2" x 42"	12-5075	12-7485
9801M	1/2" x 28"	12-5061	12-7471	174368	5/8" x 90"	12-10076		1108476	1/2" x 43"	12-5076	12-7486
5357H1	5/8" x 53"	12-5180	12-7598	174883	21/32" x 97.4"	12-10232		1108477	1/2" x 44"	12-5077	12-7487
100670N	1/2" x 79"	12-5112	12-7522	174978	1/2" x 84-1/2"		12-9964	1108478	1/2" x 45"	12-5078	12-7488
100717N	1/2" x 69"	12-5102	12-7512	*175436	3/8" x 32"		12-12480	1108481	1/2" x 48"	12-5081	12-7491
101342N	1/2" x 94"	12-5127	12-7537	180217	1/2" x 108.5"		12-10005	1108485	1/2" x 52"	12-5085	12-7495
102143X	1/2" x 53"	12-5086	12-7496	180808	5/8" x 89"	12-10077		1108487	1/2" x 54"	12-5087	12-7497
102655X	1/2" x 38"	12-5071	12-7481	*191273	5/8" x 142.57"		12-11034	1108488	1/2" x 55"	12-5088	12-7498
104022X	1/2" x 43"	12-5076	12-7486	*193214	1/2" x 90.2"		12-11861	1108495	1/2" x 62"	12-5095	12-7505
104776	1/2" x 89"	12-5122	12-7532	*194346	1/2" x 97.4"		12-11862	1108500	1/2" x 67"	12-5100	12-7510
105372	1/2" x 90"	12-5123	12-7533	*196103	5/8" x 148"		12-11863	1108501	1/2" x 68"	12-5101	12-7511
105380X	1/2" x 88"	12-5121	12-7531	*197242	5/8" x 138.75"		12-11864	1108503	1/2" x 68"	12-5101	12-7511
105372X	1/2" x 90"	12-5123	12-7533	*197253	1/2" x 100.97"		12-11867	1108535	5/8" x 26"	12-5153	12-7571
105876X	1/2" x 94"	12-5127	12-7537	*199612	1/2" x 96-7/8"		12-12052	1108536	5/8" x 27"	12-5154	12-7572
105876X	1/2" x 93	12-5126	12-7536	*401603	1/2" x 95.68"		12-12398	1108539	5/8" x 30"	12-5157	12-7575
106085X	1/2" x 79"	12-5112	12-7522	*402009	AA x 114"		12-12423	1108540	5/8" x 31"	12-5158	12-7576
*106085X	1/2" x 79"		12-6901	*405123	1/2" x 105-3/4"		12-12286	1108544	5/8" x 35"	12-5162	12-7580
106381X	1/2" x 92"	12-5125	12-7535	*429636	1/2" x 101.4"		12-13251	1108547	5/8" x 38"	12-5165	12-7583
106412X	1/2" x 69"	12-5102	12-7512	634A563	1/2" x 83-5/8"		12-9312	1108552	5/8" x 43"	12-5170	12-7588
106863X	1/2" x 92"	12-5125	12-7535	BOBCAT				1108554	5/8" x 45"	12-5172	12-7590
1071249	1/2" x 50"	12-5083	12-7493	35032	1/2" x 35"	12-5068	12-7478	1108562	5/8" x 53"	12-5180	12-7598
10830	1/2" x 60"	12-5093	12-7503	38016	5/8" x 36"	12-5163	12-7581	1108566	5/8" x 57"	12-5184	12-7602
*180214	1/2" x 87"		12-11130	38016	5/8" x 36"	12-5163	12-7581	1108572	5/8" x 63"	12-5190	12-7608
*180216	1/2" x 83"		12-11129	38011	5/8" x 87"	12-5214	12-7632	1108576	5/8" x 67"	12-5194	12-7612
108597X	1/2" x 94"	12-5127	12-7537	*38015N	21/32" x 86-7/8"		12-5243	1108642	1/2" x 29"	12-5062	12-7472
*110883X	1/2" x 99"		12-8465	38016	5/8" x 36"	12-5163	12-7581	1109439	1/2" x 30"	12-5063	12-7473
110884X	1/2" x 94"	12-5127	12-7537	38016N	5/8" x 36"	12-5163	12-7581	1109539	5/8" x 30"	12-5157	12-7575
110884X	1/2" x 93-1/2"		12-9945	*38016N	21/32" x 35-19/32"		12-5242	1185434	3/8" x 37"	12-5020	12-7442
110885X	1/2" x 94"	12-5127	12-7537	38017N	5/8" x 44"	12-5171	12-7589	1185487	3/8" x 32"	12-5015	12-7437
120302X	1/2" x 90"	12-5123	12-7533	*38017N	5/8" x 44-1/8"		12-5241	150168	5/8" x 59"	12-5186	12-7604
120418X	1/2" x 80"	12-5113	12-7523	38030	5/8" x 93	12-5220	12-7638	150169	5/8" x 60"	12-5187	12-7605
121879X	1/2" x 93"	12-5126	12-7536	*38030N	5/8" x 90"		12-5823	150173	5/8" x 56"	12-5183	12-7601
121979X	1/2" x 88"	12-5121	12-7531	38031	5/8" x 52"	12-5179	12-7597	150175	5/8" x 47"	12-5174	12-7592
123461X	1/2" x 81"	12-5114	12-7524	*38031N	5/8" x 51-13/16"		12-5824	150176	5/8" x 57"	12-5184	12-7602
123554X	1/2" x 94"	12-5127	12-7537	35032	1/2" x 35"	12-5068	12-7478	150180	1/2" x 49"	12-5082	12-7492
123796X	1/2" x 95"	12-5128	12-7538	38039N	5/8" x 82"	12-5209	2-7627	1700101	1/2" x 24"	12-5057	12-7467
*124293X	1/2" x 80"		12-6900	38075	5/8" x 82"	12-5209	12-7627	17005034	1/2" x 35"	12-5068	12-7478
124293X	1/2" x 80"	12-5113	12-7523	38076	5/8" x 87"	12-5214	12-7632	1702443	1/2" x 24"	12-5057	12-7467
124525X	1/2" x 89"	12-5122	12-7532	38111	5/8" x 87"	12-5214	12-7632	1702727	1/2" x 46"	12-5079	12-7489
125907X	1/2" x 90"	12-5123	12-7533	*38111	5/8" x 86-3/4"		12-5818	1703084	1/2" x 35"	12-5068	12-7478
*125907X	1/2" x 90"		12-6902	*38212	1-1/4" x 55-31/32"		12-6969	1703085	1/2" x 20"	12-5053	
125908X	1/2" x 93"	12-5126	12-7536	*38249	1-1/4" x 44-11/16"		12-6836	1704403	1/2" x 48"	12-5081	12-7491
126520	1/2" x 89"	12-5122	12-7532	*38440	42/64" x 82.25"		12-8803	1704595	1/2" x 43"	12-5076	12-7486
126576X	1/2" x 82"	12-5115	12-7525	*38442	21/32" x 67.75"		12-8809	1705033	1/2" x 22"	12-5055	
130801	1/2" x 95"		12-9764	*38523	1/2" x 54"		12-8810	1705034	1/2" x 35"	12-5068	12-7478
*130969	1/2" x 92-1/2"		12-8511	65032	1/2" x 35"	12-5068	12-7478	1705061	1/2" x 20"	12-5053	
*131006	1/2" x 98-1/4"		12-8462	65082	1/2" x 37"	12-5070	12-7480	1705326	1/2" x 37"	12-5070	12-7480
131290X	1/2" x 88"	12-7531		78030	3/8" x 26"	12-5009	12-7431	1706238	1/2" x 34"	12-5067	12-7477
*131290X	1/2" x 88		12-7184	78030N	3/8" x 26"	12-5009	12-7431	1706239	1/2" x 38"	12-5071	12-7481
*131264	1/2" x 78-1/2"		12-8463	*78030N	3/8" x 25-11/16"		12-5817	1706383	1/2" x 28"	12-5061	12-7471
132801	1/2" x 52"		12-9765	78031	3/8" x 36"	12-5019	12-7441	1706462	5/8" x 40"	12-5167	12-7585
*137078	3/8" x 32-3/16"	12-10306		78031N	3/8" x 36"	12-5019	12-7441	1706799	1/2" x 70"	12-5103	12-7513
*137153	1/2" x 83.1/2"		12-9367	*78031N	3/8" x 36-3/16"		12-5816	1706907	1/2" x 24"	12-5057	12-7467
137153	1/2" x 83-1/2"		12-9367	*128003		12-11853		1706967	1/2" x 24"	12-5057	12-7467
*138255	1/2" x 95.25		12-8784	*128099	1/2" x 36.12"		12-8811	1707233	1/2" x 26"	12-5059	12-7469
138399	1/2" x 59"		12-9766	*2188128	1/2" x 63"		12-8808	1707640	1/2" x 22"		



OEM REPLACEMENT BELT APPLICATION GUIDE

2014 BELT APPLICATION

OEM No.	Size	Premium Order No.	Aramid Order No.	OEM No.	Size	Premium Order No.	Aramid Order No.	OEM No.	Size	Premium Order No.	Aramid Order No.
BOLENS (Cont.)				BOLENS (Cont.)				BOLENS (Cont.)			
1709698	5/8" x 43"	12-5170	12-7588	1723060	1/2" x 51"	12-5084	12-7494	1800365	1/2" x 34"	12-5067	12-7477
1709821	5/8" x 43"	12-5170	12-7588	1723661	3/8" x 41"	12-5024	12-7446	1800366	1/2" x 36"	12-5069	12-7479
1710457	5/8" x 36"	12-5163	12-7581	1724035	1/2" x 68"	12-5101	12-7511	1800367	1/2" x 33"	12-5066	12-7476
1710555	1/2" x 28"	12-5061	12-7471	1724148	1/2" x 75"	12-5108	12-7518	1812039	5/8" x 64"	12-5191	12-7609
1710556	1/2" x 50"	12-5083	12-7493	1724261	1/2" x 51"	12-5084	12-7494	1813220	1/2" x 37"	12-5070	12-7480
1710811	1/2" x 19"	12-5052		1724729	1/2" x 35"	12-5068	12-7478	1813271	1/2" x 55"	12-5088	12-7498
1710812	1/2" x 22"	12-5055		1725253	1/2" x 34"	12-5067	12-7477	1813561	1/2" x 55"	12-5088	12-7498
1710957	1/2" x 22"	12-5055		1725407	1/2" x 37"	12-5070	12-7480	1860801	5/8" x 54"	12-5181	12-7599
1711844	1/2" x 36"	12-5069	12-7479	1725469	1/2" x 35"	12-5068	12-7478	1863848	1/2" x 45"	12-5078	12-7488
1711845	5/8" x 45"	12-5172	12-7590	1725603	1/2" x 43"	12-5076	12-7486	1892436	3/8" x 28"	12-5011	12-7433
1711880	1/2" x 35"	12-5068	12-7478	1726573	1/2" x 34"	12-5067	12-7477	1893200	3/8" x 28"	12-5011	12-7433
1711916	1/2" x 30"	12-5063	12-7473	1726701	1/2" x 77"	12-5110	12-7520	1894063	3/8" x 28"	12-5011	12-7433
1711959	1/2" x 58"	12-5091	12-7501	1726929	1/2" x 38"	12-5071	12-7481	1894272	3/8" x 35"	12-5018	12-7440
1712113	3/8" x 33"	12-5016	12-7438	1728133	1/2" x 92"	12-5125	12-7535	1894335	3/8" x 36"	12-5019	12-7441
1712719	3/8" x 30"	12-5013	12-7435	1728183	1/2" x 92"	12-5125	12-7535	1813220	1/2" x 37"	12-5070	12-7480
1712911	5/8" x 29"	12-5156	12-7574	1729626	1/2" x 37"	12-5070	12-7480	390377	1/2" x 26"	12-5059	12-7469
1712912	5/8" x 35"	12-5162	12-7580	1729716	5/8" x 46"	12-5173	12-7591				
1713067	1/2" x 29"	12-5062	12-7472	1731273	1/2" x 35"	12-5068	12-7478				
1713533	3/8" x 34"	12-5017	12-7439	1731718	1/2" x 51"	12-5084	12-7494	BUNTON			
1713714	1/2" x 43"	12-5076	12-7486	1731719	1/2" x 51"	12-5084	12-7494	PLO019	1/2" x 36"	12-5069	12-7479
1713716	1/2" x 35"	12-5068	12-7478	1732171	1/2" x 31"	12-5064	12-7474	PLO020	1/2" x 37"	12-5070	12-7480
1713853	1/2" x 57"	12-5090	12-7500	1732192	1/2" x 44"	12-5077	12-7487	PLO021	1/2" x 39"	12-5072	12-7482
1714106	1/2" x 21"	12-5054		1732582	1/2" x 31"	12-5064	12-7474	PLO148	1/2" x 28"	12-5061	12-7471
1714107	1/2" x 46"	12-5079	12-7489	1732719	1/2" x 51"	12-5084	12-7494	PLO321	1/2" x 45"	12-5078	12-7488
1714115	1/2" x 32"	12-5065	12-7475	1732726	1/2" x 71"	12-5104	12-7514	PLO511	5/8" x 54"	12-5181	12-7599
1714251	1/2" x 20"	12-5053		1732780	1/2" x 44"	12-5077	12-7487	*PLO511	21/32" x 53-3/4"		12-5239
1714285	1/2" x 23"	12-5056	12-7466	1732880	1/2" x 44"	12-5077	12-7487	PLO543	1/2" x 43"	12-5076	12-7486
1714286	1/2" x 48"	12-5081	12-7491	1733152	1/2" x 35"	12-5068	12-7478	PLO619	5/8" x 44"	12-5077	12-7589
1714513	3/8" x 23"	12-5006		1733439	1/2" x 35"	12-5068	12-7478	*PLO619	21/32" x 44-1/8"		12-5240
1714673	5/8" x 34"	12-5161	12-7579	1733770	1/2" x 35"	12-5068	12-7478	*PLO619	5/8" x 43-27/32"		12-7915
1714690	1/2" x 32"	12-5065	12-7475	1733805	3/8" x 35"	12-5018	12-7440	*PLO619	5/8" x 44.125"		12-5241
1714785	1/2" x 30"	12-5063	12-7473	1735996	3/8" x 35"	12-5018	12-7440	PL0643	1/2" x 50"	12-5083	12-7493
1714799	1/2" x 75"	12-5108	12-7518	1736248	1/2" x 64"	12-5097	12-7507	*PL0643	1/2" x 49-7/8"		12-5237
1715006	5/8" x 34"	12-5161	12-7579	1736259	1/2" x 34"	12-5067	12-7477	PL0661	5/8" x 58"	12-5185	12-7603
1715010	1/2" x 34"	12-5067	12-7477	1736279	1/2" x 36"	12-5069	12-7479	PL0848	5/8" x 42"	12-5169	12-7587
1715212	1/2" x 53"	12-5086	12-7496	1736903	3/8" x 48"	12-5031	12-7453	*PL0848	5/8" x 39-7/8"		12-5238
1715213	1/2" x 61"	12-5094	12-7504	1737187	5/8" x 95"	12-5222	12-7640	PL0861	5/8" x 46"	12-5173	12-7591
1715214	3/8" x 28"	12-5011	12-7433	1737347	1/2" x 69"	12-5102	12-7512	PL0961	5/8" x 96"	12-5223	12-7641
1715611	3/8" x 25"	12-5008	12-7430	1737459	1/2" x 59"	12-5092	12-7502				
1715614	3/8" x 28"	12-5011	12-7433	1737574	1/2" x 54"	12-5087	12-7497	CASTLEGARDEN			
1715621	3/8" x 30"	12-5013	12-7435	1737574	1/2" x 54"	12-5087	12-7497	*35065460/0 15/16" x 70.86"		12-12370	
1715740	5/8" x 43"	12-5170	12-7588	1738015	1/2" x 49"	12-5082	12-7492				
1715942	1/2" x 47"	12-5080	12-7490	1738496	1/2" x 65"	12-5098	12-7508				
1715972	1/2" x 38"	12-5071	12-7481	1738496	1/2" x 65"	12-5098	12-7508				
1716036	1/2" x 31"	12-5064	12-7474	1738511	1/2" x 66"	12-5099	12-7509				
1716161	1/2" x 31"	12-5064	12-7474	1739080	1/2" x 79"	12-5112	12-7522	CASE			
171627	1/2" x 47"	12-5080	12-7490	1739943	1/2" x 32"	12-5065	12-7475	C11124	5/8" x 39"	12-5166	12-7584
1716307	1/2" x 70"	12-5103	12-7513	1739944	1/2" x 37"	12-5070	12-7480	C11384	5/8" x 68"	12-5195	12-7613
1716557	1/2" x 85"	12-5118	12-7528	1741135	1/2" x 71"	12-5104	12-7514	C11514	3/8" x 40"	12-5023	12-7445
1716570	1/2" x 42"	12-5075	12-7485	1741334	1/2" x 85"	12-5118	12-7528	C11945	1/2" x 82"	12-5115	12-7525
1716571	1/2" x 34"	12-5067	12-7477	1741534	1/2" x 85"	12-5118	12-7528	C11946	5/8" x 63"	12-5190	12-7608
1717120	1/2" x 44"	12-5077	12-7487	1741568	1/2" x 95"	12-5128	12-7538	C11948	5/8" x 62"	12-5189	12-7607
1717195	1/2" x 58"	12-5091	12-7501	1741576	1/2" x 81"	12-5114	12-7524	C11988	5/8" x 61"	12-5188	12-7606
1717837	1/2" x 60"	12-5093	12-7503	1741577	1/2" x 83"	12-5116	12-7526	C13184	5/8" x 73"	12-5200	12-7618
1717861	1/2" x 55"	12-5088	12-7498	1741577	1/2" x 83"	12-5116	12-7526	C14116	1/2" x 41"	12-5074	12-7484
1719203	1/2" x 32"	12-5065	12-7475	1741578	1/2" x 43"	12-5076	12-7486	C14345	3/8" x 34"	12-5017	12-7439
1719731	1/2" x 63"	12-5096	12-7506	1741634	1/2" x 85"	12-5118	12-7528	C14965	1/2" x 80"	12-5113	12-7523
1719783	1/2" x 44"	12-5074	12-7484	1742006	3/8" x 39"	12-5022	12-7444	C15370	1/2" x 63"	12-5096	12-7506
1720131	1/2" x 44"	12-5077	12-7487	1742476	3/8" x 35"	12-5018	12-7440	C15411	1/2" x 92"	12-5125	12-7535
1720573	1/2" x 30"	12-5063	12-7473	1743519	1/2" x 90"	12-5123	12-7533	C15552	1/2" x 33"	12-5066	12-7476
1720718	5/8" x 33"	12-5160	12-7578	1743876	1/2" x 98"	12-5131	12-7541	C15943	1/2" x 70"	12-5103	12-7513
1720726	1/2" x 33"	12-5066	12-7476	1744493	1/2" x 68"	12-5101	12-7511	C15944	1/2" x 66"	12-5099	12-7509
1720727	1/2" x 46"	12-5079	12-7489	1744706	3/8" x 34"	12-5017	12-7439	C16088	1/2" x 67"	12-5100	12-7510
1720938	3/8" x 36"	12-5019	12-7441	1745047	1/2" x 35"	12-5068	12-7478	C16093	1/2" x 69"	12-5102	12-7512
1721574	1/2" x 62"	12-5095	12-7505	1745058	1/2" x 45"	12-5078	12-7488	C16094	1/2" x 76"	12-5109	12-7519
1721967	1/2" x 53"	12-5086	12-7496	1745059	1/2" x 44"	12-5077	12-7487	C17413	1/2" x 32"	12-5065	12-7475
1721995	1/2" x 57"	12-5090	12-7500	1745368	1/2" x 55"	12-5088	12-7498	A65717	1/2" x 73"	12-5106	12-7516
1722074	5/8" x 35"	12-5162	12-7580	1746868	1/2" x 38"	12-5071	12-7481	A70205	3/8" x 35"	12-5018	12-7440
1722095	5/8" x 44"	12-5171	12-7589	1747188	1/2" x 97"	12-5130	12-7540	A70226	5/8" x 62"	12-5189	12-7607
1722238	1/2" x 65"	12-5098	12-7508	1747199	1/2" x 97"	12-5130	12-7540	A70227	1/2" x 68"	12-5101	12-7511
1722258	1/2" x 31"	12-5064	12-7474	1747232	1/2" x 45"	12-5078	12-7488	A70296	5/8" x 64"	12-5191	12-7609
1722344	1/2" x 62"	12-5095	12-7505	1747359	1/2" x 63"	12-5096	12-7506	A70304	1/2" x 82"	12-5115	12-7525
1722523	1/2" x 49"	12-5082	12-7492	1747515	1/2" x 69"	12-5102	12-7512	A70525	5/8" x 61"	12-5188	12-7606
1722639	1/2" x 35"	12-5068	12-7478	1747938	1/2" x 97"	12-5130	12-7540	C10507	3/8" x 30"	12-5013	12-7435
1722992	1/2" x 35"	12-5068	12-7478	1748271	1/2" x 59"	12-5092	12-7502	C11949	5/8" x 64"	12-5191	12-7609
1722993	1/2" x 45"	12-5078	12-7488	1751597	1/2" x 91"	12-5124	12-7534	C18634	1/2" x 82"	12-5115	12-7525
1723056	1/2" x 54"	12-5087	12-7497	1751601	1/2" x 31"	12-5064	12-7474	C18707	1/2" x 82"	12-5115	12-7525
				1751872	1/2" x 84"	12-5117	12-7527	C18708	1/2" x 65"	12-5098	12-7508
				1752194	3/8" x 36"	12-5019	12-7441	C18709	1/2" x 71"	12-5104	12-7514
				1752751	1/2" x 36"	12-5069	12-7479	C18918	1/2" x 68"	12-5101	12-7511

OEM REPLACEMENT BELT APPLICATION GUIDE



OEM		Premium	Aramid	OEM		Premium	Aramid	OEM		Premium	Aramid
No.	Size	Order No.	Order No.	No.	Size	Order No.	Order No.	No.	Size	Order No.	Order No.
CASE (Cont.)				CUB CADET (Cont.)				CUB CADET (Cont.)			
C19161	5/8" x 71"	12-5198	12-7616	490489-R2	1/2" x 81-1/2"	12-10830		754-3038	1/2" x 60"	12-5093	12-7503
C19162	1/2" x 41"	12-5074	12-7484	492103R1	5/8" x 103"	12-6645	12-7648	*754-3055A	5/8" x 112.5"		12-11997
C12706	1/2" x 69"	12-5102	12-7512	49364R1	1/2" x 73"	12-5106	12-7516	*754-3068	5/8" x 110.9"		12-11820
C12707	5/8" x 76"	12-5203	12-7621	493649R1	1/2" x 73"	12-5106	12-7516	*754-3084	1/2" x 37-5/8"		12-10901
C22706	1/2" x 69"	12-5102	12-7512	493650R1	1/2" x 50"	12-5083	12-7493	954-3036	1/2" x 63"		12-10781
C22707	1/2" x 76"	12-5109	12-7519	549107R1	1/2" x 39"	12-5072	12-7482	954-3038	1/2" x 60-1/2"		12-10563
C22708	1/2" x 80"	12-5113	12-7523	549108R1	1/2" x 38"	12-5071	12-7481	*954-3039	1/2" x 103" +B61		12-12051
C23358	1/2" x 66"	12-5099	12-7509	549599R1	1/2" x 54"	12-5087	12-7497	954-3073	1/2" x 62"		12-10782
C23359	1/2" x 71"	12-5104	12-7514	549609R1	1/2" x 50"	12-5083	12-7493	*954-3084	1/2" x 37-5/8"		12-10901
C23538	1/2" x 75"	12-5108	12-7518	549821R1	1/2" x 31"	12-5064	12-7474	*954-0641	1/2" x 105"		12-11850
C23539	1/2" x 81"	12-5114	12-7524	549822R1	1/2" x 68"	12-5101	12-7511	954-0644	1/2" x 60"		12-10783
C23685	1/2" x 68"	12-5101	12-7511	56235C1	1/2" x 68"	12-5101	12-7511	954-0645	1/2" x 67"		12-10784
C23805	1/2" x 66"	12-5099	12-7509	57842C1	1/2" x 34"	12-5067	12-7477				
C23807	1/2" x 64"	12-5097	12-7507	58663C1	1/2" x 71"	12-5104	12-7514	DIXIE CHOPPER			
C23808	1/2" x 73"	12-5106	12-7516	59003C1	1/2" x 44"	12-5077	12-7487	*2006A62R	1/2" x 64-1/2"		12-13366
C23809	1/2" x 70"	12-5103	12-7513	59004C1	1/2" x 40"	12-5073	12-7483	*2006B98R	5/8" x 101.1"		12-12442
C23810	1/2" x 69"	12-5102	12-7512	59636C1	1/2" x 30"	12-5063	12-7473	*2006B99W	5/8" x 102"		12-12238
C23837	1/2" x 71"	12-5104	12-7514	61083C1	1/2" x 32"	12-5065	12-7475	*2006B144R	5/8" x 147.1"		12-12443
C23949	1/2" x 77"	12-5110	12-7520	62817C1	1/2" x 39"	12-5072	12-7482	*2006B160R	5/8" x 162.8"		12-12452
C23950	1/2" x 82"	12-5115	12-7525	73806C1	3/8" x 31"	12-5014	12-7436	*2006B44R	5/8" x 47"		12-12239
C24018	1/2" x 73"	12-5106	12-7516	751-3012	1/2" x 32"	12-5065	12-7475	*2008B100R	1/2" x 102-7/8"		12-13456
C24296	1/2" x 65"	12-5098	12-7508	751-3013	1/2" x 38"	12-5071	12-7481	*20256	21/32" x 40.9"		12-10023
C24342	1/2" x 36"	12-5069	12-7479	754-0106	1/2" x 25"	12-5058	12-7468	*30203	21/32" x 105.8"		12-10036
C24394	1/2" x 60"	12-5093	12-7503	754-0189	1/2" x 44"	12-5077	12-7487	*30204	21/32" x 80.9"		12-10027
C26437	1/2" x 31"	12-5064	12-7474	754-0201	1/2" x 41"	12-5074	12-7484	*30236-0	21/32" x 130.8"		12-10011
C27707	1/2" x 76"	12-5109	12-7519	754-0219	1/2" x 26"	12-5059	12-7469	*63203	1/2" x 91.3"		12-10035
C27708	1/2" x 80"	12-5113	12-7523	754-0226	1/2" x 82"	12-5115	12-7525	*63204	21/32" x 44.8"		12-10026
CLO507	3/8" x 30"	12-5013	12-7435	754-0241	5/8" x 35"	12-5162	12-7580	*65080	21/32" x 82.9"		12-10029
				754-0241A	5/8" x 35"	12-5162	12-7580	*68081	21/32" x 83.8"		12-10030
				754-0284	5/8" x 41"	12-5168	12-7586	*68082	21/32" x 84.8"		12-10031
COMET				754-0290	1/2" x 47"	12-5080	12-7490	*68162	21/32" x 164.8"		12-10010
*203589A	3/4" x 27-3/8"	12-8487		754-0344	1/2" x 73"	12-5106	12-7516	*97345	21/32" x 42.8"		12-10024
*203591	3/4" x 29.28"	12-10052		754-0347	1/2" x 63"	12-5096	12-7506	*9907A96	1/2" x 98.3"		12-10022
*203783A	.875" x 31.9"	12-13627		754-0351	1/2" x 61"	12-5095	12-7504	*9907B41	21/32" x 43.8"		12-10025
*203784	.875" x 32.9"	12-13592		*754-04033	1/2" x 118-1/4"	12-11843		*9907B57	1/2" x 59.9"		12-11223
				*754-04044	1/2" x 134"	12-11844		*9907B84	5/8" x 90"		12-10814
CUB CADET				*754-04045	1/2" x 109.10"	12-11845		*9907B85	21/32" x 87.8"		12-10032
59701C1	1/2" x 77"	12-5110	12-7520	*754-04062	1/2" x 77-3/4"	12-11846		*9907B92	1/2" x 94.9"		12-11225
59702C1	1/2" x 85"	12-5118	12-7528	*754-04064	5/8" x 68-1/4"	12-11840		*9907B94	1/2" x 96.9"		12-11226
61084C1	1/2" x 59"	12-5092	12-7502	*754-04077	5/8" x 133.7"	12-11847		*9907B112	21/32" x 114.8"		12-10033
106465C1	1/2" x 51"	12-5084	12-7494	*754-04138	1/2" x 142"	12-12768		*9907B130	21/32" x 132.8"		12-10034
106990C1	1/2" x 45"	12-5078	12-7488	*754-04153	1/2" x 122"	12-12769		*97346C158	7/8" x 162-1/8"		12-10815
106991C1	1/2" x 55"	12-5088	12-7498	*754-04185	1/2" x 89.24"	12-12873					
126496C1	1/2" x 33"	12-5066	12-7476	*754-0640	5/8" x 79.24"	12-11849					
132013C1	1/2" x 30"	12-5063	12-7473	*754-0641	1/2" x 105"	12-11850					
132407C1	1/2" x 69"	12-5102	12-7512	754-3000	1/2" x 33"	12-5066	12-7476	DIXON			
135462C1	5/8" x 93"	12-5250	12-7638	754-3001	5/8" x 92"	12-5219	12-7637	1300	5/8" x 100"		12-7645
140080C91	1/2" x 32"	12-5065	12-7475	754-3002	1/2" x 72"	12-5105	12-7515	1539	5/8" x 41"		12-5168 12-7586
144409C1	5/8" x 92"	12-5219	12-7638	754-3003	5/8" x 88"	12-5215	12-7633	1664	1/2" x 42"		12-7485
197810984	1/2" x 39"	12-5072	12-7482	754-3004	1/2" x 78"	12-5111	12-7521	1684	1/2" x 42"		12-7485
214878C1	3/8" x 36"	12-5019	12-7441	754-3005	1/2" x 86"	12-5119	12-7529	1684	1/2" x 43"		12-5076 12-7486
473462R4	1/2" x 81"	12-5114	12-7524	754-3006	5/8" x 93"	12-5220	12-7638	1714	1/2" x 52"		12-7495
2214878R1	3/8" x 36"	12-5019	12-7441	754-3007	1/2" x 59"	12-5092	12-7502	1744	1/2" x 29"		12-7472
249730	3/8" x 36"	12-5019	12-7441	754-3008	1/2" x 32"	12-5065	12-7475	1765	1/2" x 27"		12-7470
251428R1	5/8" x 31"	12-5158	12-7576	754-3009	1/2" x 68"	12-5101	12-7511	1860	1/2" x 57"		12-7500
351321R1	1/2" x 21"	12-5054		754-3010	1/2" x 30"	12-5063	12-7473	2412	5/8" x 74"		12-7619
386160R1	3/8" x 33"	12-5016	12-7438	754-3011	5/8" x 92"	12-5219	12-7637	*2412	5/8" x 74"		12-8508
464351R1	1/2" x 30"	12-5063	12-7473	754-3012	1/2" x 32"	12-5065	12-7475	2426	5/8" x 44"		12-5171 1 2-7589
464362R1	1/2" x 82"	12-5115	12-7525	754-3013	1/2" x 38"	12-5071	12-7481	2469	1/2" x 45"		12-7488
473468R2	1/2" x 72"	12-5105	12-7515	754-3014	1/2" x 39"	12-5072	12-7482	2469	1/2" x 46"		12-5079 12-7489
475595R1	1/2" x 27"	12-5060	12-7470	754-3015	1/2" x 49"	12-5082	12-7492	4812	1/2" x 66"		12-7509
475610R1	3/8" x 28"	12-5011	12-7433	754-3016	1/2" x 51"	12-5084	12-7494	4934	1/2" x 68"		12-7511
477599R2	1/2" x 77"	12-5110	12-7520	754-3017	1/2" x 55"	12-5088	12-7498	4983	1/2" x 54"		12-7497
478263R91	5/8" x 57"	12-5184	12-7602	754-3018	1/2" x 86"	12-5119	12-7529	6011	5/8" x 44"		12-5171 12-7589
481099R1	1/2" x 83"	12-5116	12-7526	754-3019	1/2" x 71"	12-5104	12-7514	6109	1/2" x 82"		12-7525
481099R2	1/2" x 83"	12-5116	12-7526	754-3020	1/2" x 45"	12-5078	12-7488	6111	5/8" x 78"		12-5205 12-7623
485610R1	1/2" x 38"	12-5071	12-7481	754-3023	5/8" x 94"	12-5127	12-7639	*6111	5/8" x 78"		12-8509
487043R1	3/8" x 28"	12-5011	12-7433	754-3024	1/2" x 91"	12-5124	12-7534	6938	5/8" x 83"		12-7628
487994R1	1/2" x 37"	12-5070	12-7480	754-3025	1/2" x 77"	12-5110	12-7520	*7650	1/2" x 41-1/2"		12-8469
487996R1	1/2" x 35"	12-5068	12-7478	754-3026	1/2" x 87"	12-5120	12-7530	7725	5/8" x 72"		12-7617
488077R1	1/2" x 48"	12-5081	12-7491	754-3026A	1/2" x 87"	12-5120	12-7530	8772	1/2" x 33"		12-7476
488082R1	1/2" x 52"	12-5085	12-7495	754-3027	1/2" x 86"	12-5119	12-7529	9236	5/8" x 93"		12-7638
488082R2	1/2" x 52"	12-5085	12-7495	754-3028	1/2" x 78"	12-5111	12-7521				
489397R1	1/2" x 77"	12-5110	12-7520	754-3029	1/2" x 59"	12-5092	12-7502	EDCO			
489397R3	1/2" x 77"	12-5110	12-7520	754-3030	1/2" x 59"	12-5092	12-7502	20560	1/2" x 50"		12-5083 12-7493
489399R1	1/2" x 81"	12-5114	12-7524	754-3036	1/2" x 63"	12-5096	12-7506	20824	1/2" x 30"		12-5063 12-7473
490489C1	1/2" x 81"	12-5114	12-7524	754-3037	1/2" x 80"	12-5113	12-7523	20825	5/8" x 66"		



OEM REPLACEMENT BELT APPLICATION GUIDE

2014 BELT APPLICATION

Premium Aramid				Premium Aramid				Premium Aramid			
OEM No.	Size	Order No.	Order No.	OEM No.	Size	Order No.	Order No.	OEM No.	Size	Order No.	Order No.
EDCO (Cont.)				GILSON (Cont.)				GILSON (Cont.)			
20939	5/8" x 62"	12-5189	12-7607	1526	1/2" x 22"	12-5055		209373	1/2" x 41"	12-5074	12-7484
21416	5/8" x 46"	12-5173	12-7591	2434	1/2" x 34"	12-5067	12-7477	209375	1/2" x 44"	12-5077	12-7487
27055	5/8" x 62"	12-5189	12-7607	3045	1/2" x 41"	12-5074	12-7484	209581	1/2" x 86"	12-5119	12-7529
ENCORE				GILSON (Cont.)				GILSON (Cont.)			
032946	5/8" x 50"	12-5177	12-7595	3053	1/2" x 44"	12-5077	12-7487	209630	1/2" x 39"	12-5072	12-7482
045872	1/2" x 85"	12-5118	12-7528	3660	1/2" x 25"	12-5058	12-7468	209652	5/8" x 56"	12-5183	12-7601
EXMARK				GILSON (Cont.)				GILSON (Cont.)			
DH3012	5/8" x 52"	12-5179	12-7597	3866	1/2" x 26"	12-5059	12-7469	210392	1/2" x 96"	12-5129	12-7539
*413093	5/8" x 136.64"	12-10037		4051	3/8" x 31"	12-5014	12-7436	210692	1/2" x 96"	12-5129	12-7539
*523175	1/2" x 134-1/4"	12-10038		4052	1/2" x 55"	12-5088	12-7498	210754	1/2" x 91"	12-5124	12-7534
*633569	5/8" x 57.19"	12-9863		4332	1/2" x 31"	12-5064	12-7474	211650	3/8" x 33"	12-5016	12-7438
*643052	5/8" x 169.46"	12-10041		4638	1/2" x 30"	12-5063	12-7473	212086	1/2" x 40"	12-5073	12-7483
*653368	21/32" x 154"	12-10040		4816G	1/2" x 87"	12-5120	12-7530	212183	1/2" x 38"	12-5071	12-7481
*653438	1/2" x 39-13/32"	12-10717		4825	1/2" x 60"	12-5093	12-7503	212261	1/2" x 80"	12-5113	12-7523
1-213077	1/2" x 37"	12-5070	12-7480	4953	1/2" x 62"	12-5095	12-7505	212776	1/2" x 66"	12-5099	12-7509
1-303078	5/8" x 36"	12-5163	12-7581	5283	1/2" x 63"	12-5096	12-7506	213676	1/2" x 85"	12-5118	12-7528
1-303079	5/8" x 44"	12-5171	12-7589	5286	1/2" x 66"	12-5099	12-7509	214170	1/2" x 58"	12-5091	12-7501
1-303080	5/8" x 89"	12-5216	12-7634	6163	1/2" x 38"	12-5071	12-7481	214886	1/2" x 49"	12-5082	12-7492
*1-303080	21/32" x 88 3/4"	12-5867		10463	1/2" x 37"	12-5070	12-7480	217773	1/2" x 40"	12-5073	12-7483
1-323017	5/8" x 83"	12-5210	12-7628	10755	1/2" x 43"	12-5076	12-7486	212775	1/2" x 57"	12-5090	12-7500
*1-323051	5/8" x 44 29/32"	12-5865		10897	1/2" x 51"	12-5084	12-7494	214776	1/2" x 49"	12-5082	12-7492
*1-323280	1/2" x 39.64"	12-8812		10923	1/2" x 30"	12-5063	12-7473	218152	3/8" x 34"	12-5017	12-7439
*1-323288	1/2" x 48-13/16"	12-9257		11144	1/2" x 41"	12-5074	12-7484	219981	1/2" x 30"	12-5063	12-7473
*1-323299	5/8" x 82-11/32"	12-8091		11793	5/8" x 90"	12-5217	12-7635	231362	3/8" x 45"	12-5028	12-7450
*1-323300	5/8" x 87.92"	12-8805		11901	1/2" x 36"	12-5069	12-7479	23141	1/2" x 42"	12-5075	12-7485
*1-323301	5/8" x 93-17/32"	12-9256		11943	5/8" x 35"	12-5162	12-7580	231511	1/2" x 73"	12-5106	12-7516
*1-323344	5/8" x 48-11/16"	12-9258		12023	3/8" x 21"	12-5004		234110	1/2" x 50"	12-5083	12-7493
*1-323345	5/8" x 80-5/8"	12-9259		12684	5/8" x 96"	12-5223	12-7641	234292	5/8" x 93"	12-5220	12-7638
1-403024	5/8 x 78 1/2	12-5220	12-7638	13009	1/2" x 41"	12-5074	12-7484	234360	1/2" x 99"	12-5132	12-7542
*1-403024	5/8" x 93"	12-8370		13072	1/2" x 72"	12-5105	12-7515	234419	1/2" x 92"	12-5125	12-7535
1-403025	5/8" x 52"	12-5179	12-7597	13436	1/2" x 54"	12-5087	12-7497	234420	5/8" x 39"	12-5166	12-7584
*1-403025	5/8" x 51-29/32"	12-8092		13487	1/2" x 37"	12-5070	12-7480	234594	3/8" x 46"	12-5029	12-7451
1-403018	5/8" x 37"	12-5164	12-7582	13560	1/2" x 60"	12-5093	12-7503	235000	5/8" x 50"	12-5177	12-7595
*1-413095	1/2" x 50-1/2"	12-10887		14159	1/2" x 40"	12-5073	12-7483	235459	1/2" x 53"	12-5086	12-7496
*1-413096	5/8" x 36.081"	12-12405		14167	1/2" x 65"	12-5098	12-7508	235955	3/8" x 39"	12-5022	12-7444
*1-403105	21/32" x 55-7/16"	12-9255		14168	1/2" x 51"	12-5084	12-7494	236705	1/2" x 33"	12-5066	12-7476
*1-413308	5/8" x 143.15"	12-10251		14365	1/2" x 51"	12-5084	12-7494	236907	1/2" x 96"	12-5129	12-7539
*1-413174	5/8" x 115-9/32"	12-13454		14790	1/2" x 38"	12-5071	12-7481	236914	5/8" x 103"	12-6645	12-7648
1-503016	5/8" x 39"	12-5166	12-7584	14843	1/2" x 29"	12-5062	12-7472	236928	1/2" x 107"	12-6635	12-7550
*1-603045	1/2" x 112-1/2"	12-10886		15365	1/2" x 51"	12-5084	12-7494	237452	1/2" x 32"	12-5065	12-7475
*1-603306	5/8" x 81-1/4"	12-10885		16146	1/2" x 39"	12-5072	12-7482	237453	1/2" x 29"	12-5062	12-7472
*1-603576	1/2" x 101-1/4"	12-12256		16348	1/2" x 38"	12-5071	12-7481	237685	5/8" x 48"	12-5175	12-7593
*1-613271	1/2" x 58"	12-10884		16366	1/2" x 37"	12-5070	12-7480	237738	1/2" x 86"	12-5119	12-7529
*1-633127	5/8" x 146.17"	12-9016		16386	1/2" x 40"	12-5073	12-7483	240684	3/8" x 46"	12-5029	12-7451
*1-633162	3/4" x 58"	12-10257		16711	1/2" x 60"	12-5093	12-7503	243110	1/2" x 50"	12-5083	12-7493
*1-633173	5/8" x 111.44"	12-9014		17518	1/2" x 60"	12-5093	12-7503	244104	3/8" x 33"	12-5016	12-7438
*1-633366	5/8" x 128-13/16"	12-9862		17569	1/2" x 43"	12-5076	12-7486	244105	1/2" x 44"	12-5077	12-7487
*1-653163	1/2" x 52-1/4"	12-10252		17569	1/2" x 41"	12-5074	12-7484	244106	1/2" x 41"	12-5074	12-7484
*1-653332	1/2" x 37-3/4"	12-10167		17643	1/2" x 47"	12-5080	12-7490	372030	1/2" x 38"	12-5071	12-7481
*1-653333	1/2" x 38-1/2"	12-10039		18263	1/2" x 44"	12-5077	12-7487	700370	3/8" x 31"	12-5014	12-7436
*1-653416	1/2" x 51-3/8"	12-10253		23144	1/2" x 102"	12-6630	12-7545	703561	3/8" x 46"	12-5029	12-7451
*103-0866	1/2" x 40-13/32"	12-10716		23145	1/2" x 46"	12-5079	12-7489	705455	3/8" x 32"	12-5015	12-7437
*103-0881	17/32" x 120-5/16"	12-10254		23181	1/2" x 82"	12-5115	12-7525				
*103-6317	5/8" x 38"	12-13254		34491	1/2" x 90"	12-5123	12-7533				
*103-0882	17/32" x 70-3/4"	12-10255		35545	1/2" x 40"	12-5073	12-7483				
*103-1297	.700" x 25"	12-10256		36019	3/8" x 20"	12-5003					
*103-4014	5/8" x 116-1/8"	12-12237		36751	1/2" x 89"	12-5122	12-7532				
*103-4761	1/2" x 52-3/4"	12-12641		36770	1/2" x 34"	12-5067	12-7477				
*109-4199	5/8" x 123"	12-13255		37169	1/2" x 36"	12-5069	12-7479				
*109-5018	5/8" x 158"	12-13256		37230	1/2" x 38"	12-5071	12-7481				
EZ ROLL				GILSON (Cont.)				GRASSHOPPER			
22-0064	3/8" x 30"	12-5013	12-7435	200413	1/2" x 39"	12-5072	12-7482	231362	3/8" x 45"	12-5028	12-7450
A-209	5/8" x 50"	12-5177	12-7595	200414	1/2" x 83"	12-5116	12-7526	38000	5/8" x 90"	12-5217	12-7635
A-211	5/8" x 53"	12-5180	12-7598	200416	5/8" x 32"	12-5159	12-7577	381100	5/8" x 29"	12-5156	12-7574
S-333	1/2" x 22"	12-505		200555	3/8" x 46"	12-5029	12-7451	381904	1/2" x 34"	12-5067	12-7477
S-335	1/2" x 30"	12-5063	12-7473	200624	5/8" x 80"	12-5207	12-7625	*381914	1/2" x 36"		12-8733
GILSON				GILSON (Cont.)				GRASSHOPPER			
1019	3/8" x 37"	12-5020	12-7442	200625	1/2" x 56"	12-5089	12-7499	382000	5/8" x 32"	12-5159	12-7577
1040	1/2" x 32"	12-5065	12-7475	200626	5/8" x 40"	12-5167	12-7585	*382034	5/8" x 60-1/2"		12-12094
1110	1/2" x 35"	12-5068	12-7478	200804	1/2" x 74"	12-5107	12-7517	*382034	5/8" x 135-1/2"		12-12097
1111	3/8" x 37"	12-5020	12-7442	200973	1/2" x 78"	12-5111	12-7521	*382035	5/8" x 65-3/4"		12-10743
1409	5/8" x 52"	12-5179	12-7597	200982	1/2" x 78"	12-5111	12-7521	382037	5/8" x 65"	12-5192	12-7610
1434	5/8" x 58"	12-5185	12-7603	207925	3/8" x 32"	12-5015	12-7437	*382037	5/8" x 64"		12-8731
				208301	1/2" x 33"	12-5066	12-7476	382049	5/8" x 65"	12-5192	12-7610
				208525	3/8" x 25"	12-5008	12-7430	*382049	5/8" x 82"	12-5209	12-7627
				208526	3/8" x 38"	12-5021	12-7443	*382080	5/8" x 112-1/2"		12-12095
				208527	1/2" x 48"	12-5081	12-7491	*382082	5/8" x 120-1/2"		12-12096
				208625	1/2" x 27"	12-5060	12-7470	*382085	5/8" x 137-1/2"		12-10744
				208626	3/8" x 27"	12-5010	12-7432	*382086	5/8" x 110-1/2"		12-12098
				209310	1/2" x 39"	12-5072	12-7482	*382090	5/8" x 141"		12-12099

OEM REPLACEMENT BELT APPLICATION GUIDE



OEM No.	Size	Premium Order No.	Aramid Order No.	OEM No.	Size	Premium Order No.	Aramid Order No.	OEM No.	Size	Premium Order No.	Aramid Order No.
GRASSHOPPER (Cont.)				GRAVELY (Cont.)				HONDA (Cont.)			
382627	1/2" x 37"	12-5070	12-7480	34944	1/2" x 46"	12-5079	12-7489	76181-763A02	5/8"x72"		12-7617
382730	5/8" x 35"	12-5162	12-7580	34945	1/2" x 96"	12-5129	12-7539	76181-763-A000	5/8"x73"	12-5200	12-7618
382740	5/8" x 39"	12-5166	12-7584	36880	1/2" x 34"	12-5067	12-7477	76182-751-0130	5/8"x53"	12-5180	12-7598
382750	5/8" x 39"	12-5166	12-7584	36987	1/2" x 60"	12-5093	12-7503	76184-751-7	5/8"x63"	12-5190	12-7608
382753	5/8" x 41"	12-5168	12-7586	36987	1/2" x 72"	12-5105	12-7515	HUSQVARNA			
382765	5/8" x 45"	12-5172	12-7590	38402	1/2" x 34"	12-5067	12-7477	*501-201201	5/8" x 159.08"		12-12653
383000	5/8" x 90"	12-5217	12-7635	38744	1/2" x 92"	12-5125	12-7535	*539-102442	5/8" x 57-15/32"		12-13477
383820	5/8" x 35"	12-5162	12-7580	38745	1/2" x 90"	12-5123	12-7533	*539-102548	5/8" x 112-1/4"		12-13474
GRAVELY				GRAZER				HUSTLER/EXCEL			
A408	5/8" x 71"	12-5198	12-7616	*38745	1/2" x 89 3/4"		12-5230	*600726	1/2" x 114.3"		12-12318
A409	5/8" x 58"	12-5185	12-7603	41200	1/2" x 62"	12-5095	12-7505	*600734	1/2" x 132"		12-12264
D18005	5/8" x 82-1/4"		12-10624	41545	1/2" x 35"	12-5068	12-7478	*600979	1/2" x 70.5"		12-12689
D18007	5/8" x 88-3/4"		12-10625	*41545	1/2" x 35 1/32"		12-5229	*601015	5/8" x 204.5"		12-12690
D18087	5/8" x 77-1/2"		12-10623	41599	5/8" x 46"	12-5173	12-7591	*781443	1/2" x 62-1/4"		12-10844
D18303	1/2" x 68-1/2"		12-10893	*41599	21/32" x 45 13/16"		12-5228	*782292	5/8" x 165-1/2"		12-10847
D28028	5/8" x 134-5/16"		12-10626	41963	1/2" x 30"	12-5063	12-7473	*784207	5/8" x 195"		12-10846
D28029	5/8" x 108-1/4"		12-10627	42206	1/2" x 60"	12-5093	12-7503	*784231	1/2" x 73-3/4"		12-10851
D28030	1/2" x 76"		12-10628	43195	1/2" x 39"	12-5072	12-7482	*784249	5/8" x 145-3/8"		12-10852
D28031	5/8" x 118-7/8"		12-10629	43213	1/2" x 37"	12-5070	12-7480	*788711	1/2" x 47.382"		12-12688
D118348	5/8" x 108"		12-10894	43318	1/2" x 87"	12-5120	12-7530	*788729	5/8" x 65.08"		12-12695
M474	5/8" x 32"	12-5159	12-7577	44439	1/2" x 79"	12-5112	12-7522	*788737	1/2" x 50.125"		12-12693
M475	5/8" x 30"	12-5157	12-7575	*49029	5/8" x 46.6"		12-8717	*788745	5/8" x 86.306"		12-12417
6267	1/2" x 75"	12-5108	12-7518	*51213	1/2" x 126 3/4"		12-7837	*788794	1/2" x 64"		12-12414
6565	5/8" x 53"	12-5180	12-7598	5163P1	1/2" x 31"	12-5064	12-7474	*789388	5/8" x 152"		12-12320
6566	1/2" x 49"	12-5082	12-7492	5070A22	5/8" x 56"	12-5183	12-7601	*791335	5/8" x 143"		12-12319
9240	1/2" x 38"	12-5071	12-7481	72038	1/2" x 53"	12-5086	12-7496	*793828	1/2" x 116"		12-12415
044439	1/2" x 79"	12-5112	12-7522	72116	1/2" x 71"	12-5104	12-7514	*793836	1/2" x 63"		12-12413
10860	3/8" x 35"	12-5018	12-7440	72117	1/2" x 30"	12-5063	12-7473	*793893	1/2" x 127.3"		12-12416
*11216	1/2" x 126 3/4"		12-7837	72118	1/2" x 47"	12-5080	12-7490	*795781	5/8" x 213.5"		12-12691
13472P1	1/2" x 30"	12-5063	12-7473	*72224	1/2" x 46.6"		12-8717	*797167	5/8" x 228.71"		12-12692
13474	5/8" x 32"	12-5159	12-7577	*72250	1/2" x 37.6"		12-8760	*797514	1/2" x 66.378"		12-12694
15242	1/2" x 29"	12-5062	12-7472	*72258	1/2" x 52.8"		12-8711	*797720	5/8" x 176.79"		12-12322
15243	1/2" x 88"	12-5121	12-7531	*72266	1/2" x 126.75"		12-7837	*797928	5/8" x 160.2"		12-12321
15355	1/2" x 38"	12-5071	12-7481	*7225800	1/2" x 52.8"		12-8711	*797936	5/8" x 184.79"		12-12323
17798	1/2" x 40"	12-5073	12-7483	HONDA				*784322	5/8" x 138-1/4"		12-10861
21692	3/8" x 25"	12-5008	12-7430	900-3000	1/2" x 38"	12-5071	12-7481	*786483	5/8" x 148-1/2"		12-10849
20068	1/2" x 69"	12-5102	12-7512	900-3002	1/2" x 55"	12-5088	12-7498	*786491	5/8" x 140"		12-10850
23639	5/8" x 67"	12-5194	12-7612	900-3003	1/2" x 95"	12-5128	12-7538	*786533	1/2" x 57-3/8"		12-10848
23640	5/8" x 98"	12-5225	12-7643	900-3004	1/2" x 54"	12-5087	12-7497	*788794	HA x 64"		12-10905
23690	5/8" x 95"	12-5222	12-7640	900-3006	1/2" x 53"	12-5086	12-7496	*7781310	5/8" x 160"		12-10845
25129	1/2" x 76"	12-5109	12-7519	900-3007	1/2" x 48"	12-5081	12-7491	NT'L. HARVESTER--(See Cub Cadet)			
25659	3/8" x 20"	12-5003		900-3009	1/2" x 58"	12-5091	12-7501	JACOBSEN			
26096	1/2" x 22"	12-5055		900-3010	1/2" x 35"	12-5068	12-7478	010119	1/2" x 32"	12-5065	12-7475
26114	1/2" x 47"	12-5080	12-7490	900-3011	1/2" x 39"	12-5072	12-7482	010390	1/2" x 25"	12-5058	12-7468
26117	1/2" x 26"	12-5059	12-7469	900-3012	5/8" x 57"	12-5184	12-7602	010531	5/8" x 29"	12-5156	12-7574
26120	1/2" x 28"	12-5061	12-7471	900-3013	1/2" x 34"	12-5067	12-7477	010535	5/8" x 29"	12-5156	12-7574
26122	3/8" x 31"	12-5014	12-7436	HAHN - ECLIPSE				010536	5/8" x 41"	12-5168	12-7586
26123	1/2" x 27"	12-5060	12-7470	1362-P	3/8" x 20"	12-5003		010537	5/8" x 70"	12-5197	12-7615
26125	1/2" x 31"	12-5064	12-7474	308442	1/2" x 47"	12-5080	12-7490	010672	5/8" x 29"	12-5156	12-7574
26126	1/2" x 41"	12-5074	12-7484	HOMELITE				010673	5/8" x 33"	12-5160	12-7578
26128	3/8" x 29"	12-5012	12-7434	LM0108 2-48	1/2" x 44"	12-5077	12-7487	010674	5/8" x 29"	12-5156	12-7574
26129	1/2" x 78"	12-5111	12-7521	64498	1/2" x 38"	12-5071	12-7481	010675	5/8" x 33"	12-5160	12-7578
26130	1/2" x 54"	12-5087	12-7497	HONDA				010917	1/2" x 35"	12-5068	12-7478
26131	1/2" x 31"	12-5064	12-7474	1300663	1/2"x27"	12-5060	12-7470	011149	1/2" x 28"	12-5061	12-7471
26132	1/2" x 70"	12-5103	12-7513	1300912	1/2"x37"	12-5070	12-7480	011496	1/2" x 57"	12-5090	12-7500
26136	1/2" x 52"	12-5085	12-7495	22431-723-671	5/8"x36"	12-5163	12-7581	011497	1/2" x 28"	12-5061	12-7471
26137	3/8" x 31"	12-5014	12-7436	22431-723-672	5/8"x36"	12-5163	12-7581	011621	5/8" x 79"	12-5206	12-7624
26138	1/2" x 69"	12-5102	12-7512	22431-723-673	5/8"x36"	12-5163	12-7581	011649	5/8" x 26"	12-5153	12-7571
26139	1/2" x 66"	12-5099	12-7509	22431-723-750	5/8"x33"	12-5160	12-7578	011650	5/8" x 25"	12-5152	12-7570
26140	3/8" x 20"	12-5011		22431-723-751	5/8"x33"	12-5160	12-7578	011809	5/8" x 69"	12-5196	12-7614
26142	1/2" x 79"	12-5112	12-7522	22431-723-752	5/8"x33"	12-5160	12-7578	012104	1/2" x 35"	12-5068	12-7478
26143	1/2" x 70"	12-5103	12-7513	22431-723-753	5/8"x33"	12-5160	12-7578	012104	3/8" x 24"	12-5007	12-7429
26145	1/2" x 56"	12-5089	12-7499	22431-723-754	5/8"x33"	12-5160	12-7578				
26147	3/8" x 30"	12-5013	12-7435	22431-723-755	5/8"x33"	12-5160	12-7578				
26148	1/2" x 65"	12-5098	12-7508	22431-723-756	5/8"x33"	12-5160	12-7578				
26149	1/2" x 68"	12-5101	12-7511	22431-727-003	5/8"x39"	12-5166	12-7584				
26150	3/8" x 34"	12-5017	12-7439	22431-731-671	5/8"x36"	12-5163	12-7581				
31912	1/2" x 49"	12-5082	12-7492	22431-736-003	1/2"x29"	12-5062	12-7472				
32140	3/8" x 37"	12-5020	12-7442	22432-732-013	5/8"x28"	12-5155	12-7573				
32322	1/2" x 73"	12-5106	12-7516	22432-732-671	5/8"x29"	12-5156	12-7574				
34289	1/2" x 89"	12-5122	12-7532	22432-736-003	5/8"x33"	12-5160	12-7578				
34322	1/2" x 32"	12-5065	12-7475	23161-952-771	3/8"x35"	12-5018	12-7440				
34332	1/2" x 35"	12-5068	12-7478	23161-960-771	3/8"x36"	12-5019	12-7441				
34346	5/8" x 47"	12-5174	12-7592	23161-963-003	3/8"x33"	12-5016	12-7438				
34382	1/2" x 26"	12-5059	12-7469	76181-750-003	5/8"x66"	12-5193	12-7611				
34864	1/2" x 30"	12-5063	12-7473	76181-750-0030	5/8"x66"	12-5193	12-7611				
				76181-751-0030	5/8"x71"	12-5198	12-7616				
				76181-751-7010	5/8"x67"	12-5194	12-7612				

BELT APPLICATION 2014

* indicates original type belt



OEM REPLACEMENT BELT APPLICATION GUIDE

OEM No.	Size	Premium Order No.	Aramid Order No.	OEM No.	Size	Premium Order No.	Aramid Order No.	OEM No.	Size	Premium Order No.	Aramid Order No.
JACOBSEN (Cont.)				JACOBSEN (Cont.)				JACOBSEN (Cont.)			
012529	3/8" x 24"	12-5007	12-7429	328825	1/2" x 86"	12-5119	12-7529	501294	3/8" x 33"	12-5016	12-7438
012795	5/8" x 32"	12-5159	12-7577	328826	1/2" x 78"	12-5111	12-7521	525294	1/2" x 64"	12-5097	12-7507
013254	3/8" x 25"	12-5008	12-7430	328891	1/2" x 80"	12-5113	12-7523	545124	1/2" x 57"	12-5090	12-7500
013267	1/2" x 29"	12-5062	12-7472	328892	1/2" x 83"	12-5116	12-7526	545171	1/2" x 64"	12-5097	12-7507
04393A	1/2" x 20"	12-5053		328973	1/2" x 63"	12-5096	12-7506	545294	1/2" x 64"	12-5097	12-7507
07522	1/2" x 42"	12-5075	12-7485	329184	5/8" x 84"	12-5211	12-7629	545593	1/2" x 64"	12-5098	12-7508
07870	1/2" x 35"	12-5068	12-7478	329193	1/2" x 90"	12-5123	12-7533	546342	5/8" x 31"	12-5158	12-7576
07913	1/2" x 22"	12-5055		329205	1/2" x 46"	12-5079	12-7489	546343	1/2" x 52"	12-5085	12-7495
09082	3/8" x 38"	12-5021	12-7443	329207	1/2" x 36"	12-5069	12-7479	551761	5/8" x 94"	12-5221	12-7639
09255	1/2" x 30"	12-5063	12-7473	329253	1/2" x 90"	12-5123	12-7533	551763	5/8" x 36"	12-5163	12-7581
09255A	1/2" x 30"	12-5063	12-7473	329299	5/8" x 56"	12-5183	12-7601	551776	1/2" x 37"	12-5070	12-7480
09346A	1/2" x 40"	12-5073	12-7483	330018	1/2" x 33"	12-5066	12-7476	551778	5/8" x 94"	12-5221	12-7639
09503A	3/8" x 23"	12-5006		330447	1/2" x 67"	12-5100	12-7510	551779	5/8" x 52"	12-5179	12-7597
09507	3/8" x 22"	12-5005		330463	1/2" x 76"	12-5109	12-7519	JA992251	1/2" x 64"	12-5097	12-7507
2058	1/2" x 30"	12-5063	12-7473	330503	1/2" x 97"	12-5130	12-7540				
307522	1/2" x 42"	12-5075	12-7485	330527	1/2" x 74"	12-5107	12-7517				
307867	1/2" x 33"	12-5066	12-7476	330559	5/8" x 46"	12-5173	12-7591				
307870	1/2" x 35"	12-5068	12-7478	330599	1/2" x 38"	12-5071	12-7481	JOHN DEERE			
307913	3/8" x 22"	12-5005		330675	1/2" x 28"	12-5061	12-7471	AM31159	1/2" x 28"	12-5061	12-7471
309082	3/8" x 38"	12-5021	12-7443	330790	1/2" x 36"	12-5069	12-7479	AM32172	1/2" x 35"	12-5068	12-7478
309255	1/2" x 30"	12-5063	12-7473	331594	1/2" x 32"	12-5065	12-7475	AM32636	1/2" x 36"	12-5069	12-7479
309502	3/8" x 23"	12-5006		331599	1/2" x 68"	12-5101	12-7511	AM35380	1/2" x 41"	12-5074	12-7484
309507	3/8" x 22"	12-5005		331672	1/2" x 48"	12-5081	12-7491	AM100465	5/8" x 33"	12-5160	12-7578
310046	3/8" x 36"	12-5019	12-7441	331673	1/2" x 32"	12-5065	12-7494	B14482	3/8" x 28"	12-5011	12-7433
310119	1/2" x 32"	12-5065	12-7475	331807	3/8" x 24"	12-5007	12-7429	B14852	3/8" x 27"	12-5010	12-7432
310391	1/2" x 25"	12-5058	12-7468	331808	3/8" x 32"	12-5015	12-7437	GC00073	3/8" x 39-1/16"	12-10485	
310535	5/8" x 29"	12-5156	12-7574	331846	1/2" x 51"	12-5084	12-7494	GC00081	3/8" x 34-3/4"	12-10486	
310536	5/8" x 41"	12-5168	12-7586	331847	1/2" x 46"	12-5079	12-7489	GX10176	1/2" x 143-5/16"	12-10630	
310537	5/8" x 70"	12-5197	12-7615	331847	1/2" x 46"	12-5079	12-7489	GX20006	17/32" x 88-5/8"	12-10434	
310538	5/8" x 38"	12-5165	12-7583	331860	1/2" x 46"	12-5079	12-7489	GX20072	17/32" x 103-3/4"	12-10436	
310672	5/8" x 29"	12-5156	12-7574	331876	1/2" x 69"	12-5102	12-7512	GX20241	17/32" x 91-13/16"	12-10435	
310673	5/8" x 33"	12-5160	12-7578	332111	1/2" x 44"	12-5077	12-7487	GX20305	17/32" x 138-7/8"	12-10437	
310724	1/2" x 25"	12-5058	12-7468	333719	5/8" x 62"	12-5189	12-7607	GX22819	3/8" x 37-3/4"	12-11811	
310917	1/2" x 35"	12-5068	12-7478	335453	1/2" x 41"	12-5074	12-7484	GY20572	9/16" x 64-1/4"	12-10388	
311419	1/2" x 28"	12-5061	12-7471	335832	1/2" x 38"	12-5071	12-7481	*M144044	1/2" x 91-7/8"	12-13035	
311496	1/2" x 57"	12-5090	12-7500	335856	1/2" x 39"	12-5072	12-7482	*M144570	1/2" x 97"	12-13036	
311621	5/8" x 79"	12-5206	12-7624	336006	1/2" x 38"	12-5071	12-7481	*M154157	1/2" x 42-1/4"	12-13157	
311649	5/8" x 26"	12-5153	12-7571	336055	3/8" x 32"	12-5015	12-7437	*M158131	1/2" x 152-1/4"	12-13158	
311650	5/8" x 33"	12-5160	12-7578	336219	1/2" x 30"	12-5063	12-7473	M32636	1/2" x 28"	12-5061	12-7471
311809	5/8" x 69"	12-5196	12-7614	336262	1/2" x 32"	12-5065	12-7475	M40015	5/8" x 35"	12-5162	12-7580
312104	1/2" x 35"	12-5068	12-7478	336263	1/2" x 25"	12-5058	12-7468	M40222	1/2" x 28"	12-5061	12-7471
312529	3/8" x 24"	12-5007	12-7429	336481	1/2" x 32"	12-5065	12-7475	M40223	1/2" x 87"	12-5120	12-7530
312571	5/8" x 29"	12-5156	12-7574	336485	5/8" x 76"	12-5203	12-7621	M40224	1/2" x 57"	12-5090	12-7500
312711	5/8" x 33"	12-5158	12-7578	336488	5/8" x 43"	12-5170	12-7588	M40757	1/2" x 77"	12-5110	12-7520
312795	5/8" x 32"	12-5159	12-7577	337818	1/2" x 41"	12-5074	12-7484	M41244	1/2" x 53"	12-5086	12-7496
313254	3/8" x 25"	12-5008	12-7430	339396	1/2" x 28"	12-5061	12-7471	M41314	3/8" x 33"	12-5016	12-7438
313267	1/2" x 29"	12-5062	12-7472	342307	1/2" x 86"	12-5119	12-7529	M41335	3/8" x 32"	12-5015	12-7437
313775	1/2" x 20"	12-5053		342660	5/8" x 77"	12-5204	12-7622	M41592	1/2" x 40"	12-5073	12-7483
314012	5/8" x 40"	12-5167	12-7585	342940	3/8" x 33"	12-5016	12-7438	M41642	1/2" x 62"	12-5095	12-7505
314042	3/8" x 23"	12-5006		343015	1/2" x 32"	12-5065	12-7475	M41668	1/2" x 98"	12-5131	12-7541
314545	1/2" x 29"	12-5062	12-7472	343050	1/2" x 68"	12-5101	12-7511	M41985	3/8" x 36"	12-5019	12-7441
314564	1/2" x 29"	12-5062	12-7472	343093	1/2" x 90"	12-5123	12-7433	M42226	5/8" x 36"	12-5163	12-7581
314600	5/8" x 66"	12-5193	12-7611	343359	5/8" x 72"	12-5199	12-7617	M42261	1/2" x 60"	12-5093	12-7503
314804	1/2" x 20"	12-5053		343833	1/2" x 63"	12-5096	12-7506	M42485	1/2" x 46"	12-5079	12-7489
314874	1/2" x 22"	12-5055		344218	1/2" x 65"	12-5098	12-7508	M42538	1/2" x 64"	12-5097	12-7507
315206	1/2" x 54"	12-5087	12-7497	344219	1/2" x 65"	12-5098	12-7508	M42779	1/2" x 83"	12-5116	12-7526
315375	5/8" x 78"	12-5205	12-7623	344489	1/2" x 63"	12-5096	12-7506	M43095	5/8" x 40"	12-5167	12-7585
315402	1/2" x 32"	12-5065	12-7475	344947	1/2" x 29"	12-5062	12-7472	M43106	3/8" x 39"	12-5022	12-7444
316899	1/2" x 41"	12-5074	12-7484	344948	1/2" x 84"	12-5117	12-7527	M43489	1/2" x 57"	12-5090	12-7500
316910	1/2" x 43"	12-5076	12-7486	344983	1/2" x 90"	12-5123	12-7533	M43569	1/2" x 50"	12-5083	12-7493
317375	1/2" x 31"	12-5064	12-7474	345129	1/2" x 46"	12-5079	12-7489	M43586	1/2" x 68"	12-5101	12-7511
317749	1/2" x 53"	12-5086	12-7496	348720	1/2" x 72"	12-5105	12-7515	M43795	1/2" x 41"	12-5074	12-7484
324136	1/2" x 20"	12-5053		349079	1/2" x 77"	12-5110	12-7520	M43820	1/2" x 74"	12-5107	12-7517
324361	3/8" x 26"	12-5009	12-7431	358577	1/2" x 31"	12-5064	12-7474	M44178	3/8" x 29"	12-5012	12-7434
325074	1/2" x 84"	12-5117	12-7527	364120	3/8" x 21"	12-5004		M44272	1/2" x 80"	12-511312-7523	
325221	5/8" x 64"	12-5191	12-7609	372780	1/2" x 20"	12-5053		M44498	1/2" x 60"	12-5093	12-7503
325275	1/2" x 43"	12-5076	12-7486	390008	1/2" x 47"	12-5080	12-7490	M45254	1/2" x 86"	12-5119	12-7529
325856	1/2" x 39"	12-5072	12-7482	390188	1/2" x 44"	12-5077	12-7487	M45491	1/2" x 36"	12-5069	12-7479
325877	1/2" x 59"	12-5092	12-7502	390285	1/2" x 45"	12-5078	12-7488	M45613	1/2" x 36"	12-5069	12-7479
325910	3/8" x 33"	12-5016	12-7438	390562	1/2" x 55"	12-5088	12-7498	M45680	1/2" x 33"	12-5066	12-7476
325983	5/8" x 28"	12-5155	12-7573	390704	1/2" x 50"	12-5083	12-7493	M45681	1/2" x 32"	12-5065	12-7475
325984	5/8" x 33"	12-5160	12-7578	392406	1/2" x 24"	12-5057	12-7467	M45815	1/2" x 27"	12-5060	12-7470
326227	3/8" x 35"	12-5018	12-7440	392410	1/2" x 41"	12-5074	12-7484	M45863	1/2" x 56"	12-5089	12-7499
326253	3/8" x 28"	12-5011	12-7433	392433	5/8" x 100"	12-5227	12-7645	M45998	1/2" x 81"	12-5114	12-7524
326308	1/2" x 69"	12-5102	12-7512	392445	1/2" x 28"	12-5061	12-7471	M46030	1/2" x 33"	12-5066	12-7476
326946	5/8" x 68"	12-5195	12-7613	392545	1/2" x 74"	12-5107					



OEM REPLACEMENT BELT APPLICATION GUIDE

OEM No.	Size	Premium Order No.	Aramid Order No.	OEM No.	Size	Premium Order No.	Aramid Order No.	OEM No.	Size	Premium Order No.	Aramid Order No.
LOCKE				MTD (Cont.)				MTD (Cont.)			
3280	1/2" x 48"	12-5081	12-7491	754-0109	1/2" x 43"	12-5076	12-7486	754-0210	5/8" x 60"	12-5187	12-7605
3400	1/2" x 49"	12-5082	12-7492	754-0111	1/2" x 45"	12-5078	12-7488	754-0211	5/8" x 46"	12-5173	12-7591
3592	3/8" x 35"	12-5018	12-7440	754-0112	5/8" x 80"	12-5207	12-7625	754-0212	5/8" x 45"	12-5172	12-7590
6087	1/2" x 26"	12-5059	12-7469	754-0113	5/8" x 48"	12-5175	12-7593	754-0213	1/2" x 53"	12-5086	12-7496
6088	1/2" x 29"	12-5062	12-7472	754-0114	1/2" x 24"	12-5057	12-7467	754-0214	1/2" x 50"	12-5083	12-7493
6304	1/2" x 34"	12-5067	12-7477	754-0115	5/8" x 61"	12-5188	12-7606	754-0215	1/2" x 107"	12-6635	12-7550
MANG				754-0116	1/2" x 42"	12-5075	12-7485	754-0216	3/8" x 29"	12-5012	12-7434
JR5311	1/2" x 38"	12-5071	12-7481	754-0118	5/8" x 63"	12-5190	12-7608	754-0217	5/8" x 79"	12-5206	12-7624
JH5343	5/8" x 43"	12-5170	12-7588	754-0121	1/2" x 32"	12-5065	12-7475	754-0218	5/8" x 59"	12-5186	12-7604
Q2808	5/8" x 44"	12-5171	12-7589	754-0124	1/2" x 57"	12-5090	12-7500	754-0219	1/2" x 26"	12-5059	12-7469
Q2808K	5/8" x 46"	12-5173	12-7591	754-0126	1/2" x 20"	12-5053		754-0220	5/8" x 27"	12-5154	12-7572
MAXIM				754-0127	5/8" x 66"	12-5193	12-7611	754-0221	5/8" x 52	12-5179	12-7597
320272201	1/2" x 51"	12-5084	12-7494	754-0128	5/8" x 35"	12-5162	12-7580	754-0222	1/2" x 44"	12-5077	12-7487
320272204	1/2" x 30"	12-5063	12-7473	754-0129	5/8" x 44"	12-5171	12-7589	754-0223	3/8" x 36"	12-5019	12-7441
320272205	1/2" x 40"	12-5073	12-7483	754-0130	1/2" x 28"	12-5061	12-7471	754-0224	5/8" x 26"	12-5153	12-7571
320272213	1/2" x 47"	12-5080	12-7490	754-0134	3/8" x 33"	12-5016	12-7438	754-0225	1/2" x 82"	12-5115	12-7525
320272216	1/2" x 31"	12-5064	12-7474	754-0135	5/8" x 25"	12-5152	12-7570	754-0226	1/2" x 82"	12-5115	12-7525
320272217	1/2" x 76"	12-5109	12-7519	754-0136	5/8" x 31"	12-5158	12-7576	754-0227	5/8" x 63"	12-5190	12-7608
320359328	1/2" x 50"	12-5083	12-7493	754-0137	1/2" x 30"	12-5063	12-7473	754-0228	5/8" x 62"	12-5189	12-7607
MAX-TORQUE				754-0138	1/2" x 50"	12-5083	12-7493	754-0229	1/2" x 52"	12-5085	12-7495
MXT97	11/16" x 29-1/16"	12-9346		754-0138	5/8" x 50"	12-5177	12-7595	754-0230	1/2" x 56"	12-5089	12-7499
MXT98	11/16" x 29-3/8"	12-9792		754-0139	3/8" x 38"	12-5021	12-7443	754-0231	1/2" x 55"	12-5088	12-7498
McLANE				754-0142	3/8" x 31"	12-5014	12-7436	754-0231	1/2" x 28"	12-5061	12-7471
1060	1/2" x 19"	12-5052		754-0143	3/8" x 28"	12-5011	12-7433	754-0232	1/2" x 20"	12-5053	
*1060	1/2" x 19.5"	12-8761		754-0144	5/8" x 55"	12-5182	12-7600	754-0233	1/2" x 21"	12-5054	
2058	1/2" x 30"	12-5063	12-7473	754-0145	5/8" x 69"	12-5196	12-7614	754-0234	1/2" x 41"	12-5074	12-7484
4060	1/2" x 20"	12-5053		754-0146	1/2" x 33"	12-5066	12-7476	754-0235	1/2" x 35"	12-5068	12-7478
*7102	1/2" x 24.5"	12-8780		754-0147	5/8" x 52"	12-5179	12-7597	754-0235	1/2" x 35"	12-5068	12-7478
MERRY TILLER				754-0149	5/8" x 41"	12-5168	12-7586	754-0236	1/2" x 85"	12-5118	12-7528
329	1/2" x 45"	12-5078	12-7488	754-0151	5/8" x 67"	12-5194	12-7612	754-0236	1/2" x 92"	12-5125	12-7535
594	1/2" x 34"	12-5067	12-7477	754-0152	1/2" x 51"	12-5084	12-7494	754-0239	1/2" x 29"	12-5062	12-7472
596	1/2" x 32"	12-5065	12-7475	754-0153	3/8" x 34"	12-5017	12-7439	754-0240	5/8" x 38-3/16"	12-5165	12-7583
862	1/2" x 40"	12-5073	12-7483	754-0154	1/2" x 37"	12-5070	12-7480	*754-0240	5/8" x 38-3/16"	12-6907	
1023	1/2" x 43"	12-5076	12-7486	754-0155	3/8" x 40"	12-5023	12-7445	754-0241A	5/8" x 35"	12-5162	12-7580
1530	1/2" x 37"	12-5070	12-7480	754-0156	1/2" x 20"	12-5053		*754-0241A	5/8" x 35"	12-6906	
1637	1/2" x 50"	12-5083	12-7493	754-0157	5/8" x 28"	12-5155	12-7573	754-0241	5/8" x 35-1/4"	12-6906	
1984	1/2" x 45"	12-5078	12-7488	754-0158	5/8" x 35"	12-5162	12-7580	754-0242	1/2" x 32"	12-5065	12-7475
1985	1/2" x 33"	12-5066	12-7476	754-0163	1/2" x 28"	12-5061	12-7471	754-0243	1/2" x 46"	12-5079	12-7489
2031	1/2" x 50"	12-5083	12-7493	754-0164	1/2" x 63"	12-5096	12-7506	754-0244	1/2" x 40"	12-5073	12-7483
2059	1/2" x 50"	12-5083	12-7493	754-0165	1/2" x 34"	12-5067	12-7477	754-0245	1/2" x 59"	12-5092	12-7502
2270	1/2" x 41"	12-5074	12-7484	754-0166	5/8" x 62"	12-5189	12-7607	754-0247	1/2" x 55"	12-5088	12-7498
2278	1/2" x 41"	12-5074	12-7484	754-0167	5/8" x 64"	12-5191	12-7609	754-0248	1/2" x 89"	12-5122	12-7532
2313	3/8" x 45"	12-5028	12-7450	754-0173	5/8" x 37"	12-5164	12-7582	754-0249	5/8" x 30"	12-5157	12-7575
2391	1/2" x 36"	12-5069	12-7479	754-0175	5/8" x 82"	12-5209	12-7627	754-0250	1/2" x 53"	12-5086	12-7496
2404	3/8" x 30"	12-5013	12-7435	754-0177	1/2" x 32"	12-5065	12-7475	754-0251	1/2" x 51"	12-5084	12-7494
030-0112	1/2" x 36"	12-5069	12-7479	754-0178	5/8" x 82"	12-5209	12-7627	754-0252	1/2" x 33"	12-5066	12-7476
030-0131	1/2" x 50"	12-5083	12-7493	754-0179	1/2" x 50"	12-5083	12-7493	754-0253	1/2" x 43"	12-5076	12-7486
608-0020	1/2" x 41"	12-5074	12-7484	754-0180	5/8" x 54"	12-5181	12-7599	754-0254	1/2" x 19"	12-5052	
701-0055	3/8" x 45"	12-5028	12-7450	754-0181	1/2" x 100"	12-5133	12-7543	754-0255	1/2" x 37"	12-5070	12-7480
MIDDLESWORTH				754-0182	5/8" x 81"	12-5208	12-7626	754-0256	3/8" x 29"	12-5012	12-7434
10560	1/2" x 35"	12-5068	12-7478	754-0183	5/8" x 29"	12-5156	12-7574	754-0257	3/8" x 38"	12-5021	12-7443
10561	1/2" x 76"	12-5109	12-7519	754-0184	1/2" x 52"	12-5085	12-7495	754-0261	1/2" x 56"	12-5089	12-7499
10562	1/2" x 29"	12-5062	12-7472	754-0185	1/2" x 49"	12-5082	12-7492	754-0262	1/2" x 32"	12-5065	12-7475
10563	1/2" x 41"	12-5074	12-7484	754-0186	1/2" x 82"	12-5115	12-7525	754-0264	1/2" x 52"	12-5085	12-7495
MONTGOMERY WARD				754-0187	5/8" x 24"	12-5151		*754-0264	1/2" x 52"	12-7169	
See MTD, MURRAY & NOMA				754-0188	5/8" x 51"	12-5178	12-7596	754-0265	1/2" x 29"	12-5062	12-7472
MTD				754-0189	1/2" x 44"	12-5077	12-7487	754-0266	1/2" x 85"	12-5118	12-7528
*754-329A	21/32" x 69-9/32"	12-6842		754-0190	1/2" x 39"	12-5072	12-7482	*754-0266	1/2" x 85"	12-6838	
754-0100	1/2" x 18"	12-5051		754-0191	1/2" x 65"	12-5098	12-7508	754-0267	1/2" x 59"	12-5092	12-7502
754-0101	1/2" x 35"	12-5068	12-7478	754-0192	1/2" x 34"	12-5067	12-7477	754-0268	5/8" x 51"	12-5178	12-7596
754-0101A	1/2" x 35"	12-5068	12-7478	754-0193	1/2" x 35"	12-5068	12-7478	754-0270	1/2" x 84"	12-5117	12-7527
754-0102	1/2" x 37"	12-5070	12-7480	754-0194	1/2" x 45"	12-5078	12-7488	754-0271	3/8" x 39"	12-5022	12-7444
754-0103	1/2" x 27"	12-5060	12-7470	754-0195	1/2" x 54"	12-5087	12-7497	754-0273	3/8" x 34"	12-5017	12-7439
754-0104	1/2" x 32"	12-5065	12-7475	754-0196	1/2" x 30"	12-5063	12-7473	754-0274	1/2" x 44"	12-5077	12-7487
754-0105	1/2" x 30"	12-5063	12-7473	754-0198	1/2" x 62"	12-5095	12-7505	754-0275	1/2" x 38"	12-5071	12-7481
754-0106	1/2" x 25"	12-5058	12-7468	754-0199	5/8" x 36"	12-5163	12-7581	754-0276	1/2" x 48"	12-5081	12-7491
754-0107	1/2" x 30"	12-5063	12-7473	754-0200	1/2" x 48"	12-5081	12-7491	754-0277	1/2" x 71"	12-5104	12-7514
754-0108	1/2" x 46"	12-5079	12-7489	754-0201	1/2" x 41"	12-5074	12-7484	754-0278	1/2" x 30"	12-5063	12-7473
				754-0202	1/2" x 85"	12-5118	12-7528	754-0279	5/8" x 65"	12-5192	12-7610
				754-0203	5/8" x 61"	12-5188	12-7606	754-0280	5/8" x 53"	12-5180	12-7598
				754-0204	1/2" x 67"	12-5100	12-7510	*754-0280	5/8" x 53"	12-6839	
				754-0205	1/2" x 32"	12-5065	12-7475	754-0281	5/8" x 44"	12-5171	12-7589
				754-0206	1/2" x 50"	12-5083	12-7493	*754-0281	5/8" x 44"	12-6840	
				754-0207	1/2" x 42"	12-5075	12-7485	754-0282	1/2" x 39"	12-5072	12-7482
				754-0208	1/2" x 55"	12-5088	12-7498	754-0282A	1/2" x 95"	12-5128	12-7538
				754-0209	1/2" x 50"	12-5083	12-7493	754-0283	1/2" x 95"	12-5128	12-7538
								754-028			

OEM REPLACEMENT BELT APPLICATION GUIDE



OEM No.	Size	Premium Order No.	Aramid Order No.	OEM No.	Size	Premium Order No.	Aramid Order No.	OEM No.	Size	Premium Order No.	Aramid Order No.
MTD (Cont.)				MTD (Cont.)				MURRAY (Cont.)			
754-0285	1/2" x 34"	12-5067	12-7477	754-3001	5/8" x 92"	12-5219	12-7637	37X12	1/2" x 55"	12-5088	12-7498
754-0287	1/2" x 29"	12-5062	12-7472	754-3002	1/2" x 72"	12-5105	12-7515	*37X12	1/2" x 54 15/16"	12-6876	
754-0290	1/2" x 47"	12-5080	12-7490	754-3003	5/8" x 89"	12-5216	12-7634	37X13	1/2" x 41"	12-5074	12-7484
754-0291	1/2" x 88"	12-5121	12-7531	754-3007	1/2" x 60"	12-5093	12-7503	37X14	1/2" x 43"	12-5076	12-7486
754-0291A	1/2" x 88"	12-5121	12-7531	754-3018	1/2" x 36"	12-5119	12-7529	37X15	1/2" x 62"	12-5095	12-7505
754-0292	1/2" x 26"	12-5059	12-7469	754-3024	1/2" x 91"	12-5124	12-7534	37X16	1/2" x 59"	12-5092	12-7502
754-0293	1/2" x 74"	12-5107	12-7517	754-3025	1/2" x 77"	12-5110	12-7520	37X17	1/2" x 95"	12-5128	12-7538
*754-0293	1/2" x 74"		12-6841	754-3028	1/2" x 78"		12-7521	37X18	1/2" x 82"	12-5115	12-7525
754-0293	1/2" x 76"	12-5109	12-7519	754-3029	1/2" x 59"	12-5092	12-7502	37X19	1/2" x 74"	12-5107	12-7517
754-0294	1/2" x 89"	12-5122	12-7532	754-3038	1/2" x 60"	12-5093	12-7503	37X20	1/2" x 77"	12-5110	12-7520
754-0299	1/2" x 49"	12-5082	12-7492	*954-0197	1/2" x 117"		12-9900	37X21	1/2" x 62"	12-5095	12-7505
754-0325	1/2" x 57"	12-5090	12-7500	*954-0240	5/8" x 38-3/16"		12-6907	37X22	1/2" x 99"	12-5132	12-7542
754-0326	1/2" x 62"	12-5095	12-7505	*954-0271	3/8" x 39"		12-9901	*37X22	1/2" x 99"		12-6903
754-0327	3/8" x 28"	12-5011	12-7433	*954-0291A	1/2" x 88"		12-9902	37X23	1/2" x 43"	12-5076	12-97486
754-0328	5/8" x 49"	12-5176	12-7594	*954-0355	1/2" x 67"		12-6949	37X24	1/2" x 59"	12-5092	12-7502
754-0329	5/8" x 69"	12-5196	12-7614	*954-0371A	5/8" x 74"		12-6845	37X25	3/8" x 38"	12-5021	12-7443
754-0330	1/2" x 90"	12-5123	12-7533	*954-04043	1/2" x 57.7"		12-12382	37X26	1/2" x 88"	12-5121	12-7531
754-0338	1/2" x 77"	12-5110	12-7520	*954-04048	5/8" x 130-1/4"		12-12667	*37X26	1/2" x 88 5/16"		12-6502
754-0339	1/2" x 79"	12-5112	12-7522	*954-04082A	3/8" x 31.68"		12-13653	38X27	1/2" x 83"	12-5116	12-7526
754-0340	5/8" x 84"		12-7629	*954-04118	1/2" x 122.5"		12-12609	37X28	1/2" x 48"	12-5081	12-7491
754-0341	5/8" x 89"		12-7634	*954-0430	3/8" x 35"		12-12429	37X29	3/8" x 39"	12-5022	12-7444
754-0342	1/2" x 68"	12-5101	12-7511	*954-0433	5/8" x 69-9/32"		12-6842	37X30	3/8" x 29"	12-5009	12-7431
754-0343	3/8" x 31"	12-5014	12-7436	*954-0453	5/8" x 36-1/4"		12-9480	37X31	1/2" x 96"	12-5127	12-7537
754-0344	1/2" x 73"	12-5106	12-7516	*954-0461	1/2" x 78-1/2"		12-9903	37X32	1/2" x 45"	12-5078	12-7488
*754-0346	3/8" x 30 3/16"		12-6950	*954-0467	5/8" x 91"		12-9933	*37X33	1/2" x 90 1/2"		12-6505
754-0347	1/2" x 63"	12-5096	12-7506	954-0474	5/8" x 100-3/16"		12-10261	37X34	1/2" x 77"	12-5110	12-7520
754-0349	1/2" x 79"	12-5112	12-7522	*954-0476	5/8" x 100-3/16"		12-10260	37X35	1/2" x 90"	12-5123	12-7533
*754-0349	1/2" x 79"		12-6843	*954-0485	5/8" x 97"		12-10009	*37X35	1/2" x 90 1/2"		12-6505
754-0350	5/8" x 64"	12-5191	12-7609	*954-0498	1/2" x 67"		12-10369	37X36	1/2" x 55"	12-5088	12-7498
*754-0350	5/8" x 64"		12-6844	*954-0497	1/2" x 60.06"		12-11019	37X37	1/2" x 50"	12-5083	12-7493
754-0351	1/2" x 61"	12-5094	12-7504	*954-04001	5/8" x 69-3/16"		12-10831	37X38	1/2" x 40"	12-5073	12-7483
754-0352	5/8" x 48"	12-5175	12-7593	*954-0101A	1/2" x 35"		12-10089	*37X38	1/2" x 40 5/16"		12-6503
754-0353	1/2" x 48"	12-5081	12-7491	*01000151	1/2" x 51-3/4"		12-13551	37X39	1/2" x 83"	12-5116	12-7526
*754-0355	1/2" x 67"		12-6949					37X40	1/2" x 62	12-5095	12-7505
754-0355	1/2" x 68"	12-5101	12-7511	MURRAY				*37X40	1/2" x 62 3/32"		12-6504
754-0356	3/8" x 35"	12-5018	12-7440	201153	1/2" x 62"	12-5095	12-7505	37X41	1/2" x 66"	12-5099	12-7509
754-0357	1/2" x 40"	12-5073	12-7483	20159	1/2" x 44"	12-5077	12-7487	*37X43	1/2" x 82.1"		12-4998
*754-0358	7/8" x 53-1/4"		12-9570	20555	1/2" x 41"	12-5074	12-7484	37X43	1/2" x 83"	12-5116	12-7526
754-0364	5/8" x 68"	12-5195	12-7613	20556	1/2" x 48"	12-5081	12-7491	37X44	1/2" x 50"	12-5083	12-7493
754-0365	1/2" x 83"	12-5116	12-7526	20557	1/2" x 46"	12-5079	12-7489	37X45	1/2" x 90"	12-5123	12-7533
754-0366	3/8" x 26"	12-5009	12-7431	20558	1/2" x 64"	12-5097	12-7507	*37X45	1/2" x 90 1/2"		12-6505
*754-0367	3/8" x 34.4"		12-13288	20715	1/2" x 37"	12-5070	12-7480	37X46	1/2" x 27"	12-5060	12-7470
754-0370	5/8" x 48"	12-5175	12-7593	20716	1/2" x 37"	12-5070	12-7480	37X47	1/2" x 91"	12-5124	12-7534
*754-0370	5/8" x 48"		12-6908	20717	1/2" x 56"	12-5089	12-7499	37X49	3/8" x 40"	12-5023	12-7445
754-0371A	5/8" x 74"	12-5201	12-7619	21058	1/2" x 63"	12-5096	12-7506	*37X49	3/8" x 40 5/32"		12-6506
*754-371A	5/8" x 74"		12-6845	21059	1/2" x 44"	12-5077	12-7487	37X50	1/2" x 54"	12-5087	12-7497
*754-0374	3/8" x 18 1/4"		12-6951	21614	1/2" x 85"	12-5118	12-7528	37X51	1/2" x 37"	12-5070	12-7480
*754-0430	3/8" x 35"	12-12429		21615	1/2" x 95"	12-5128	12-7538	37X52	1/2" x 54"	12-5087	12-7497
*754-04014	3/8" x 27"	12-13567		21649	1/2" x 55"	12-5088	12-7498	37X55	1/2" x 91"	12-5124	12-7534
*754-04032	3/8" x 35-5/8"	12-13232		22611	3/8" x 38"	12-5021	12-7443	37X57	1/2" x 54"	12-5087	12-7497
*754-04033	1/2" x 90-1/4"	12-11848		22846	3/8" x 41"	12-5024	12-7446	*37X57	1/2" x 53 11/16"		12-6507
*754-04043	1/2" x 57.7"	12-12382		23072	1/2" x 43"	12-5076	12-7486	37X59	1/2" x 79"	12-5112	12-7522
*754-04048	5/8" x 130-1/4"	12-12667		23098	1/2" x 62"	12-5095	12-7505	37X61	1/2" x 95"	12-5128	12-7538
*754-04118	1/2" x 122.5"	12-12609		23214	1/2" x 59"	12-5092	12-7502	*37X61	1/2" x 95"		12-6508
*754-04207	1/2" x 79.3"	12-12770		23223	1/2" x 95"	12-5128	12-7538	*37X62	1/2" x 85 15/16"		12-6904
*754-04219	1/2" x 103.24"	12-12790		23347	1/2" x 82"	12-5115	12-7525	37X63	1/2" x 83"	12-5116	12-7526
*754-04240	1/2" x 162.9"	12-12791		23496	1/2" x 74"	12-5107	12-7517	*37X63	1/2" x 83 3/32"		12-6509
*754-04252	1/2" x 84.17"	12-13301		23748	1/2" x 62"	12-5095	12-7505	*37X64	1/4" x 36.78"		12-8747
*754-0433	5/8" x 69-9/32"	12-6842		23749	1/2" x 99"	12-5132	12-7542	*37X65	1/2" x 30-3/16"		12-7245
*754-0439	1/2" x 60"	12-9119		23796	1/2" x 55"	12-5088	12-7498	*37X66	1/2" x 47.1"		12-8444
*754-0440	1/2" x 99"	12-9120		23853	1/2" x 43"	12-5076	12-7486	*37X68	1/2" x 101.68"		12-8442
754-0440	1/2" x 99"	12-9120		23882	1/2" x 59"	12-5092	12-7502	*37X69	1/2" x 80.3		12-8443
754-0441	1/2" x 76"	12-5109	12-7519	24176	1/2" x 95"	12-5128	12-7538	*37X70	1/2" x 77-11/16"		12-7672
*754-0441	1/2" x 76"		12-9847	24256	1/2" x 88"	12-5121	12-7531	*37X75	1/2" x 90-5/8"		12-7673
*754-0433	5/8" x 69-9/32"	12-6842		*321205	5/8" x 97.23"		12-11017	*37X80	1/2" x 86-1/4"		12-9994
*754-0467	5/8" x 91"	12-9933		37X1	1/2" x 41"	12-5074	12-7484	*37X83	1/2" x 81-3/4"		12-9481
*754-0468	5/8" x 41-1/2"	12-9934		37X2	1/2" x 48"	12-5081	12-7491	*37X86	1/2" x 84"		12-9712
754-0472	5/8" x 82"	12-5209	12-7627	37X3	1/2" x 46"	12-5079	12-7489	*37X88	1/2" x 88.24"		12-8972
*754-0472	5/8" x 83"	12-9935		37X4	1/2" x 64"	12-5097	12-7507	*37X87	1/2" x 97"		12-9995
*754-0485	5/8" x 97"	12-10009		37X5	1/2" x 37"	12-5070	12-7480	*37X89	1/2" x 87"		12-9313
754-0506	1/2" x 50"	12-5083	12-7493	37X6	1/2" x 37"	12-5070	12-7480	*37X92	1/2" x 52"		12-9713
754-0737	5/8" x 59"	12-5186	12-7604	37X7	1/2" x 56"	12-5089	12-7499	*37X93	5/8" x 109"		12-9714
*754-0754	5/8" x 52"	12-9936		37X8	1/2" x 62"	12-5095	12-7505	*37X96	1/2" x 88-1/4"		12-9715
754-0935	1/2" x 31"	12-5064	12-7474	37X9	1/2" x 44"	12-5077	12-7487	*37X98	3/4" x 35.37"		12-10042
754-0936	1/2" x 47"	12-5080	12-7490	37X10	1/2" x 85"	12-5118	12-7528	*37X106	1/2" x 89"		12-10910
754-0937	5/8" x 59"	12-5186	12-7604	37X11	1/2" x 95"	12-5128	12-7538	*37X110	1/2" x 43-7/8"		12-10832
*754-0101A	1/2" x 35"	12-10089		*37X11	1/2" x 9						



OEM REPLACEMENT BELT APPLICATION GUIDE

Premium Aramid				Premium Aramid				Premium Aramid			
OEM No.	Size	Order No.	Order No.	OEM No.	Size	Order No.	Order No.	OEM No.	Size	Order No.	Order No.
MURRAY (Cont.)				NOMA (Cont.)				NOMA (Cont.)			
*37X125	1/2" x 66"	12-12462		300719	1/2" x 87"	12-5120	12-7530	150100	1/2" x 90"	12-5123	12-7533
75121	1/2" x 48"	12-5081	12-7491	300747	1/2" x 68"	12-5101	12-7511	*300142	1/2" x 40 1/2"		12-6894
75147	1/2" x 39"	12-5072	12-7482	301935	1/2" x 108"	12-6636	12-7551	300575	1/2" x 35"	12-5068	12-7478
75370	3/8" x 26"	12-5009	12-7431	*302289	5/8" x 73.75		12-6872	*300575	1/2" x 35		12-6895
*7035500YP	1/2" x 85-3/8"	12-13541		302291	5/8" x 64"	12-5191	12-7609	*300749	1/2" x 43 7/16"		12-6869
NOMA				303241	1/2" x 90"	12-5123	12-7533	*300680	5/8" x 77-3/4"		12-7128
2363	1/2" x 24"	12-5057	12-7467	*305148	5/8" x 83"		12-6899	*302289	5/8" x 73 3/4"		12-6872
2543	1/2" x 28"	12-5061	12-7471	305698	1/2" x 73"	12-5106	12-7516	*303241	1/2" x 90"		12-6898
20317	1/2" x 20"	12-5053		*308701	5/8" x 80"		12-6871	*305148	5/8" x 83"		12-6899
20368	1/2" x 29"	12-5062	12-7472	313886	1/2" x 81"	12-5114	12-7524	*305698	1/2" x 73"		12-9149
20582	1/2" x 43"	12-5076	12-7486	344148	1/2" x 63"	12-5096	12-7506	308701	5/8" x 80"	12-9149	12-7625
21865	1/2" x 26"	12-5059	12-7469	451186	1/2" x 63"	12-5096	12-7506	*308701	5/8" x 80"		12-6871
23164	1/2" x 25"	12-5058	12-7468	512275M1	1/2" x 102"	12-6630	12-7545	POULAN			
24829	1/2" x 30"	12-5063	12-7473	751253	1/2" x 43"	12-5076	12-7486	*539109243	5/8" x 135.5"		12-12399
25807	5/8" x 33"	12-5160	12-7578	754109	1/2" x 43"	12-5076	12-7486	*539110411	1/2" x 56"		12-12400
25883	5/8" x 43"	12-5170	12-7588	754248	1/2" x 89"	12-5122	12-7532	*539110832	5/8" x 145"		12-12401
26659	5/8" x 72"	12-5199	12-7617	23164	1/2" x 25"	12-5058	12-7468	POWER TRIM			
27016	1/2" x 36"	12-5069	12-7479	24829	1/2" x 30"	12-5063	12-7473	134	1/2" x 28"	12-5061	12-7471
27323	1/2" x 41"	12-5074	12-7484	27016	1/2" x 36"	12-5069	12-7479	237	1/2" x 28"	12-5061	12-7471
28148	1/2" x 26"	12-5059	12-7469	43066	5/8" x 71"	12-5198	12-7616	238	1/2" x 29"	12-5062	12-7472
28165	1/2" x 26"	12-5059	12-7469	43124	1/2" x 29"	12-5062	12-7472	339	1/2" x 28"	12-5061	12-7471
28594	1/2" x 37"	12-5070	12-7480	43779	1/2" x 56"	12-5089	12-7499	*339	1/2" x 27 1/2"		12-4999
29281	5/8" x 78"	12-5205	12-7623	43946	1/2" x 46"	12-5079	12-7499	530	1/2" x 28"	12-5061	12-7471
29798	1/2" x 27"	12-5060	12-7470	43947	1/2" x 55"	12-5088	12-7498	*4L275	1/2" x 27 1/2"		12-4999
383	1/2" x 87"	12-5120	12-7530	43979	1/2" x 56"	12-5089	12-7499	PRO			
3145	3/8" x 23"	12-5006		44039	1/2" x 44"	12-5077	12-7487	7520026	1/2" x 41"	12-5074	12-7484
303241	1/2" x 90"		12-6898	44148	1/2" x 63"	12-5096	12-7506	7520031	1/2" x 40"	12-5073	12-7483
30839	5/8" x 73"	12-5200	12-7618	44150	1/2" x 41"	12-5074	12-7484	7522001	1/2" x 47"	12-5080	12-7490
30997	1/2" x 47"	12-5080	12-7490	44190	1/2" x 32"	12-5065	12-7475	7523015	1/2" x 31"	12-5064	12-7474
30998	1/2" x 42"	12-5075	12-7485	44264	1/2" x 98"	12-5131	12-7541	7524026	1/2" x 43"	12-5076	12-7486
31053	1/2" x 27"	12-5060	12-7470	44313	1/2" x 52"	12-5085	12-7495	7524058	1/2" x 46"	12-5079	12-7489
32131	1/2" x 38"	12-5071	12-7481	45186	1/2" x 63"	12-5096	12-7506	7529058	1/2" x 45"	12-5078	12-7488
32132	1/2" x 39"	12-5072	12-7482	*45186	1/2" x 63"		12-6870	7523020	3/8" x 30"	12-5013	12-7435
36607	5/8" x 63"	12-5190	12-7608	45187	1/2" x 44"	12-5077	12-7487	ROTO-HOE			
39454	1/2" x 88"	12-5121	12-7531	45217	1/2" x 39"	12-5072	12-7482	101	1/2" x 59"	12-5092	12-7502
39455	1/2" x 63"	12-5096	12-7506	45495	1/2" x 53"	12-5086	12-7496	102	1/2" x 61"	12-5094	12-7504
39456	5/8" x 69"	12-5196	12-7614	45509	1/2" x 53"	12-5086	12-7496	108	1/2" x 61"	12-5094	12-7504
40899	1/2" x 37"	12-5070	12-7480	45919	1/2" x 37"	12-5070	12-7480	804	1/2" x 60"	12-5093	12-7503
41505	1/2" x 35"	12-5068	12-7478	45920	1/2" x 72"	12-5105	12-7515	1078	1/2" x 43"	12-5076	12-7486
41740	1/2" x 38"	12-5071	12-7481	47200	1/2" x 29"	12-5062	12-7472	1079	1/2" x 37"	12-5070	12-7480
42035	3/8" x 40"	12-5023	12-7445	47201	1/2" x 25"	12-5058	12-7468	1080	1/2" x 51"	12-5084	12-7494
42111	5/8" x 70"	12-5197	12-7615	47390	1/2" x 71"	12-5104	12-7514	1081	1/2" x 46"	12-5079	12-7489
42132	1/2" x 35"	12-5068	12-7478	48044	5/8" x 82"	12-5209	12-7627	1542A	1/2" x 52"	12-5085	12-7495
42132	1/2" x 34"	12-5067	12-7477	*48044	5/8" x 82"		12-6970	1543	1/2" x 47"	12-5080	12-7490
42846	1/2" x 50"	12-5083	12-7493	48259	3/8" x 45"	12-5028	12-7450	2430	1/2" x 43"	12-5076	12-7486
42858	1/2" x 39"	12-5072	12-7482	48530	3/8" x 43"	12-5026	12-7448	2540	1/2" x 54"	12-5087	12-7497
42881	5/8" x 71"	12-5198	12-7616	49405	1/2" x 88"	12-5121	12-7531	4059	1/2" x 59"	12-5092	12-7502
42946	1/2" x 50"	12-5083	12-7493	49450	1/2" x 37"	12-5070	12-7480	4075	1/2" x 35"	12-5068	12-7478
44186	1/2" x 63"	12-5096	12-7506	49570	1/2" x 30"	12-5070	12-7480	_4076	1/2" x 65"	12-5098	12-7508
45216	1/2" x 43"	12-5076	12-7486	49580	1/2" x 40"	12-5073	12-7483	5065	1/2" x 49"	12-5082	12-7492
46466	5/8" x 84"	12-5211	12-7629	49581	1/2" x 37"	12-5070	12-7480	SCAG			
47611	1/2" x 88"	12-5121	12-7531	49878	5/8" x 84"	12-5211	12-7629	48080	1/2" x 39"	12-5072	12-7482
47793	1/2" x 27"	12-5060	12-7470	50272	1/2" x 27"	12-5070	12-7480	48081	5/8" x 80"	12-5207	12-7625
48044	5/8" x 82"		12-6970	50273	3/8" x 34"	12-5017	12-7439	*48083	21/32" x 88-3/8"		12-5819
48529	3/8" x 45"	12-5028	12-7450	50307	3/8" x 28"	12-5011	12-7433	*48085	1/2" x 38 1/8"		12-5244
48570	1/2" x 37"	12-5070	12-7480	50597	1/2" x 30"	12-5063	12-7473	*48086	21/32" x 106 3/32"		12-5814
49045	1/2" x 88"	12-5121	12-7531	50737	1/2" x 84"	12-5117	12-7527	48087	3/8" x 43"	12-5026	12-7448
49233	3/8" x 44"	12-5027	12-7449	50876	3/8" x 38"	12-5021	12-7443	*48087	5/8" x 52.9"		12-7789
51467	1/2" x 87"	12-5120	12-7530	50877	3/8" x 31"	12-5014	12-7436	*48089	5/8" x 89.6"		12-7790
53162	1/2" x 51"	12-5084	12-7494	51249	3/8" x 34"	12-5017	12-7439	48089	5/8" x 89"	12-5216	12-7634
53307	3/8" x 43"	12-5026	12-7448	51304	1/2" x 37"	12-5070	12-7480	48202	1/2" x 28"	12-5061	12-7471
53363	1/2" x 69"	12-5102	12-7512	51855	1/2" x 41"	12-5074	12-7484	*48202A	1/2" x 51 1/2"		12-5235
53443	3/8" x 34"	12-5017	12-7439	52450	3/8" x 29"	12-5012	12-7434	48203	1/2" x 28"	12-5061	12-7471
53499	1/2" x 30"	12-5063	12-7473	52467	1/2" x 87"	12-5120	12-7530	*48203	1/2" x 28"		12-7791
53833	1/2" x 81"	12-5114	12-7524	53124	3/8" x 37"	12-5020	12-7442	*48204	21/32" x 82"		12-5236
54829	1/2" x 30"	12-5063	12-7473	53162A	1/2" x 51"	12-5084	12-7494	*48207	21/32" x 86 1/8"		12-5866
57214	1/2" x 85"	12-5118	12-7528	53170	3/8" x 35"	12-5018	12-7440	*48207	5/8" x 86-1/8"		12-7631*
*57214	1/2" x 84-3/4"		12-6952	54758	1/2" x 82"	12-5115	1 2-7525	48244	5/8" x 78"	12-5205	12-7623
57800	1/2" x 51"	12-5084	12-7494	*54758	1/2" x 82"		12-6896	48265	5/8" x 63"	12-5190	12-7608
58170	5/8" x 75"	12-5202	12-7620	54830	1/2" x 71"	12-5104	12-7514	48285	5/8" x 56"	12-5183	12-7601
58170	5/8" x 75-1/4"		12-7183	55442	1/2" x 58"	12-5091	12-7501	48286	5/8" x 93"	12-5220	12-7638
8271	1/2" x 27"	12-5060	12-7470	55450	1/2" x 42"	12-5075	12-7485	48472	1/2" x 44"	12-5077	12-7487
992	1/2" x 23"	12-5056	12-7466	55914	3/8" x 31"	12-5014	12-7436	*48553	1/2" x 50-1/2"		12-12049
150100	1/2" x 90"	12-5123	12-7533	56625	1/2" x 38"	12-5071	12-7481	* indicates original type belt			
*300142	1/2" x 40.5		12-6894	*57214	1/2" x 84 3/4"		12-6952	www.mymowerparts.com			
300575	1/2" x 34"	12-5067	12-7477	*57556	1/2" x 89 1/4"		12-6897	1417			
300680	5/8" x 77-3/4"		12-7128	*58170	21/32" x 75-1/4"		12-7183	2014 BELT APPLICATION			

2014 BELT APPLICATION

OEM REPLACEMENT BELT APPLICATION GUIDE



Premium Aramid				Premium Aramid				Premium Aramid			
OEM No.	Size	Order No.	Order No.	OEM No.	Size	Order No.	Order No.	OEM No.	Size	Order No.	Order No.
SCAG (Cont.)				SIMPLICITY (Cont.)				SIMPLICITY (Cont.)			
*48587	17/32" x 57"	12-10402		108495	1/2" x 74"	12-5107	12-7517	165048	1/2" x 85"	12-5118	12-7528
*48752	21/32" x 120-3/8"	12-10404		108505	1/2" x 70"	12-5103	12-7513	1650502	1/2" x 46"	12-5079	12-7489
*48799	11/16" x 115"	12-10403		108508	1/2" x 80"	12-5111	12-7521	1651201	1/2" x 73"	12-5106	12-7516
*48912	5/8" x 117.5"	12-8714		108732	3/8" x 33"	12-5016	12-7438	1655069	1/2" x 91"	12-5124	12-7534
*48996	21/32" x 135-1/2"	12-10405		108854	1/2" x 45"	12-5078	12-7488	1655275	1/2" x 85"	12-5118	12-7528
*481001	21/32" x 128-13/32"	12-10407		109061	1/2" x 28"	12-5061	12-7471	1656960	1/2" x 84"	12-5117	12-7527
*481460	5/8" x 43"	12-10317		109067	1/2" x 33"	12-5066	12-7476	*1656960	1/2" x 84 3/32"	12-6873	
*481461	1/2" x 60.86	12-10043		110003	5/8" x 58"	12-5185	12-7603	1657044	1/2" x 93"	12-5126	12-7536
*481498	1/2" x 41-3/4"	12-10409		118068	1/2" x 34"	12-5067	12-7477	1657589	1/2" x 70"	12-5103	12-7513
*481499	1/2" x 34"	12-10410		118116	3/8" x 36"	12-5019	12-7441	1657800	1/2" x 36"	12-5069	12-7479
*481557	21/32" x 123-15/16"	12-10411		118225	1/2" x 27"	12-5060	12-7470	1657806	1/2" x 36"	12-5069	12-7479
*481558	5/8" x 139.95	12-10044		118312	1/2" x 34"	12-5067	12-7477	166172	1/2" x 47"	12-5080	12-7490
*481749	1/2" x 59"	12-10914		118488	3/8" x 34"	12-5017	12-7439	1663009	3/8" x 28"	12-5011	12-7433
*481980	5/8" x 162-1/2"	12-12233		118494	3/8" x 34"	12-5017	12-7439	1664457	1/2" x 41"	12-5074	12-7484
*482009	1/2" x 52"	12-10045		119035	1/2" x 76"	12-5109	12-7519	1664789	1/2" x 89"	12-5122	12-7532
*482137	21/32" x 116.75"	12-10046		119037	1/2" x 78"	12-5111	12-7521	1664946	1/2" x 57"	12-5090	12-7500
*482138	21/32" x 50"	12-10047		119044	1/2" x 73"	12-5106	12-7516	1665024	1/2" x 54"	12-5087	12-7497
*482139	21/32" x 120"	12-10048		121078	1/2" x 35"	12-5068	12-7478	1665450	1/2" x 87"	12-5120	12-7530
*482140	21/32" x 55"	12-10049		121216	1/2" x 38"	12-5071	12-7481	*1665638	1/2" x 126.14"	12-6874	
*482171	1/2" x 60"	12-10050		121228	1/2" x 37"	12-5070	12-7480	1665666	5/8" x 77"	12-5204	12-7622
*482529	21/32" x 148"	12-10365		121398	1/2" x 43"	12-5076	12-7486	1665706	1/2" x 39"	12-5072	12-7482
*482530	5/8" x 148-1/4"	12-12371		122046	1/2" x 38"	12-5071	12-7481	1666324	1/2" x 69"	12-5102	12-7512
*482641	1/2" x 79-13/16"	12-10318		122039	3/8" x 32"	12-5015	12-7437	1666654	3/8" x 32"	12-5015	12-7437
*482716	1/2" x 61-5/8"	12-10319		122060	3/8" x 36"	12-5019	12-7441	1666655	1/2" x 41"	12-5074	12-7484
*482873	1/2" x 79-1/2"	12-12248		122069	1/2" x 53"	12-5086	12-7496	1666698	1/2" x 90"	12-5123	12-7533
*482876	5/8" x 43-3/4"	12-12249		122120	3/8" x 33"	12-5016	12-7438	*1666698	1/2" x 90 13/32"	12-6875	
*483157	43/64" x 65"	12-12067		122146	3/8" x 38"	12-5021	12-7443	1666801	1/2" x 80"	12-5113	12-7523
*483165	5/8" x 80"	12-12085		123073	1/2" x 91"	12-5124	12-7534	1667200	1/2" x 34"	12-5067	12-7477
*483172	43/64" x 65-5/8"	12-12068		124025	1/2" x 30"	12-5063	12-7473	1668065	1/2" x 69"	12-5102	12-7512
*483239	43/64" x 50"	12-12069		125068	1/2" x 32"	12-5065	12-7475	1669394	5/8" x 50"	12-5177	12-7595
*483240	43/64" x 54-1/2"	12-12070		152017	5/8" x 45"	12-5172	12-7590	1669937	5/8" x 54"	12-5181	12-7599
*483241	5/8" x 117-1/2"	12-12071		15307	1/2" x 35"	12-5068	12-7478	167031	1/2" x 83"	12-5116	12-7526
*483242	5/8" x 125-1/2"	12-12072		153091	1/2" x 44"	12-5077	12-7487	1670832	1/2" x 79"	12-5112	12-7522
*483243	5/8" x 135-1/2"	12-12073		154273	5/8" x 42"	12-5169	12-7587	1675342	1/2" x 98"	12-5131	12-7541
*483314	1/2" x 80.755"	12-13257		154307	1/2" x 35"	12-5068	12-7478	1675704	1/2" x 34"	12-5067	12-7477
*483325	5/8" x 140-3/4"	12-12718		155004	5/8" x 49"	12-5176	12-7594	1671076	1/2" x 98"	12-5131	12-7541
*483326	5/8" x 148.255"	12-12719		156120	1/2" x 63"	12-5096	12-7506	1671788	3/8" x 46"	12-5029	12-7451
				156210	1/2" x 63"	12-5096	12-7506	1672135	1/2" x 80"	12-5113	12-7523
				156231	1/2" x 42"	12-5075	12-7485	1672732	3/8" x 31"	12-5014	12-7436
				157230	3/8" x 22"	12-5005		1674312	1/2" x 37"	12-5070	12-7480
				157524	3/8" x 39"	12-5022	12-7444	1674898	5/8" x 50"	12-5177	12-7595
				157683	1/2" x 29"	12-5062	12-7472	1674899	5/8" x 56"	12-5183	12-7601
				158389	1/2" x 29"	12-5062	12-7472	1674920	3/8" x 31"	12-5014	12-7436
				158460	1/2" x 31"	12-5064	12-7474	1675005	1/2" x 40"	12-5073	12-7483
				158573	1/2" x 31"	12-5064	12-7474	1675704	3/8" x 34"	12-5017	12-7439
				1601238	3/8" x 34"	12-5017	12-7439	1679717	3/8" x 32"	12-5015	12-7437
				1601405	1/2" x 40"	12-5073	12-7483	1679835	1/2" x 79"	12-5112	12-7522
				1601520	1/2" x 70"	12-5103	12-7513	168171	3/8" x 48"	12-5031	12-7453
				1601524	1/2" x 78"	12-5111	12-7521	1700415	3/8" x 32"	12-5015	12-7437
				1601672	1/2" x 61"	12-5094	12-7504	1700581	1/2" x 52"	12-5085	12-7495
				1601695	1/2" x 43"	12-5076	12-7486	170164	5/8" x 77"	12-5204	12-7622
				1602157	1/2" x 73"	12-5106	12-7516	170164	1/2" x 77"	12-5110	12-7520
				1602969	1/2" x 48"	12-5081	12-7491	1702496	1/2" x 38"	12-5071	12-7481
				1603075	1/2" x 92"	12-5125	12-7535	*1703466	1/2" x 126.14"	12-6874	
				1603077	1/2" x 82"	12-5115	12-7525	1703886	1/2" x 91"	12-5124	12-7534
				1604406	1/2" x 83"	12-5116	12-7526	170771	3/8" x 36"	12-5019	12-7441
				1606190	1/2" x 82"	12-5115	12-7525	1707740	1/2" x 69"	12-5102	12-7512
				1606261	1/2" x 81"	12-5114	12-7524	170921	1/2" x 24"	12-5057	12-7467
				16069261	1/2" x 81"	12-5114	12-7524	171001	1/2" x 66"	12-5099	12-7509
				1607051	1/2" x 70"	12-5103	12-7513	*1713549	1/2" x 69-1/2"	12-8510	
				1607284	1/2" x 76"	12-5109	12-7519	172066	5/8" x 29"	12-5156	12-7574
				1607323	1/2" x 38"	12-5071	12-7481	172420	1/2" x 93"	12-5126	12-7536
				1607323	3/8" x 38"	12-5021	12-7443	172426	1/2" x 93"	12-5126	12-7536
				1607812	1/2" x 55"	12-5115	12-7525	172929	1/2" x 33"	12-5066	12-7476
				1607813	1/2" x 83"	12-5116	12-7526	173037	1/2" x 66"	12-5099	12-7509
				1607889	1/2" x 69"	12-5102	12-7512	173461	1/2" x 100"	12-5133	12-7543
				1607967	1/2" x 52"	12-5085	12-7495	173948	1/2" x 57"	12-5090	12-7500
				1608954	1/2" x 33"	12-5066	12-7476	174224	1/2" x 66"	12-5099	12-7509
				1608957	1/2" x 49"	12-5082	12-7492	174364	1/2" x 49"	12-5082	12-7492
				1608960	1/2" x 37"	12-5070	12-7480	174365	5/8" x 55"	12-5182	12-7600
				1610577	1/2" x 56"	12-5089	12-7499	174486	5/8" x 49"	12-5176	12-7594
				1610578	1/2" x 25"	12-5058	12-7468	174687	1/2" x 73"	12-5106	12-7516
				16106261	1/2" x 81"	12-5114	12-7524	174731	1/2" x 53"	12-5086	12-7496
				161098	1/2" x 39"	12-5072	12-7482	174833	1/2" x 32"	12-5065	12-7475
				162081	1/2" x 76"	12-5109	12-7519	174911	1/2" x 44"	12-5077	12-7487
				163011	1/2" x 72"	12-5105	12-7515	175361	1/2" x 29"	12-5062	12-7472
				164146	1/2" x 34"	12-5067	12-7477	176393	3/8" x 37"	12-5020	12-7442
				164273	5/8" x 42"	12-5169	12-7587	176439	1/2" x 74"	12-5107	12-7517

* indicates original type belt



OEM REPLACEMENT BELT APPLICATION GUIDE

SIMPLICITY (Cont.)				SIMPLICITY (Cont.)				SNAPPER (Cont.)			
OEM No.	Size	Premium Order No.	Aramid Order No.	OEM No.	Size	Premium Order No.	Aramid Order No.	OEM No.	Size	Premium Order No.	Aramid Order No.
176917	1/2" x 37"	12-5070	12-7480	71666698	1/2" x 90"	12-5123	12-7533	*14800	1/2" x 139"		12-8075
177126	1/2" x 79"	12-5112	12-7522	7166801	1/2" x 80"	12-5113	12-7523	14801	1/2" x 94"	12-5127	12-7537
177452	1/2" x 62"	12-5095	12-7505	72027114	1/2" x 85"	12-5118	12-7528	15151	3/8" x 34"	12-5017	12-7439
177945	1/2" x 70"	12-5103	12-7513	72027134	1/2" x 70"	12-5103	12-7513	*17053	1 1/4" x 55-3/32"		12-7244
179929	3/8" x 33"	12-5016	12-7438	72087648	1/2" x 72"	12-5105	12-7515	*18236	1/2" x 73"		12-675
*1703466	1/2" x 126 1/8"		12-6874	72088100	1/2" x 78"	12-5111	12-7521	19534	1/2" x 35"	12-5068	12-7478
2025236	5/8" x 56"	12-5183	12-7601	72102528	1/2" x 42"	12-5075	12-7485	19550	1/2" x 23"	12-5056	12-7466
2025309	1/2" x 35"		12-7478	8021036	1/2" x 40"	12-5073	12-7483	19551	1/2" x 44"	12-5077	12-7487
2025341	1/2" x 44"	12-5077	12-7487	8021077	1/2" x 39"	12-5072	12-7482	19581	1/2" x 96"	12-5129	12-7539
2025364	1/2" x 82"	12-5115	12-7525	8081053	1/2" x 47"	12-5080	12-7490	19607	1/2" x 39"	12-5072	12-7482
2025436	1/2" x 26"	12-5059	12-7469	8091017	1/2" x 50"	12-5083	12-7493	*22252	1/2" x 73"		12-7838
2025461	3/8" x 36"	12-5019	12-7441	8151018	1/2" x 58"	12-5091	12-7501	*24497	1/2" x 105"		12-870
2025463	1/2" x 53"	12-5086	12-7496	8161083	1/2" x 43"	12-5076	12-7486	*28619	5/8" x 75-1/2"		12-8767
2025492	5/8" x 45"	12-5172	12-7590	8161119	1/2" x 33"	12-5066	12-7476	*28784	5/8" x 110.28"		12-6768
2025641	5/8" x 42"	12-5169	12-7587	8161164	1/2" x 31"	12-5064	12-7474	29908	5/8" x 83"	12-5210	12-7628
2025663	1/2" x 35"	12-5068	12-7478	8161244	1/2" x 38"	12-5071	12-7481	*43844	1/2" x 73-3/4"		12-9483
2025712	5/8" x 49"	12-5176	12-7594					*44637	5/8" x 75-1/8"		12-8767
2025879	1/2" x 63"	12-5096	12-7506	SNAPPER				*46784	3/8" x 24-1/2"		12-11677
2025893	1/2" x 84"	12-5117	12-7527	10034	1/2" x 29"	12-5062	12-7472	*75901	3/8" x 29-1/4"		12-12687
2026066	3/8" x 38"	12-5021	12-7443	10056	1/2" x 27"	12-5060	12-7470	76353	5/8" x 87"	12-5214	12-7632
2026081	1/2" x 36"	12-5069	12-7479	10063	1/2" x 29"	12-5062	12-7472	76496	5/8" x 89"	12-5216	12-7634
2026266	1/2" x 38"	12-5071	12-7481	10084	1/2" x 23"	12-5056	12-7466	76497	5/8" x 44"	12-5171	12-7589
2026268	1/2" x 39"	12-5072	12-7482	10085	1/2" x 35"	12-5068	12-7478	*76496	5/8" x 88 7/8"		12-5232
2026270	1/2" x 37"	12-5070	12-7480	10108	1/2" x 24"	12-5057	12-7467	*76497	5/8" x 44"		12-5233
2026324	1/2" x 91"	12-5124	12-7534	10109	1/2" x 40"	12-5073	12-7483	76498	5/8" x 36"	12-5163	12-7581
2026378	3/8" x 22"	12-5005		10125	1/2" x 42"	12-5075	12-7485	*76498	5/8" x 36 3/16"		12-5234
2026499	1/2" x 56"	12-5089	12-7499	10178	1/2" x 53"	12-5086	12-7496	76676	5/8" x 52"	12-5179	12-7597
2026574	1/2" x 63"	12-5096	12-7506	10192	5/8" x 40"	12-5167	12-7585	76677	5/8" x 94"	12-5221	12-7639
2026869	3/8" x 39"	12-5022	12-7444	10193	5/8" x 25"	12-5152	12-7570	76680	5/8" x 37"	12-5164	12-7582
2027102	1/2" x 61"	12-5094	12-7504	10207	5/8" x 67"	12-5194	12-7612	77044	5/8" x 35"	12-5162	12-7580
2027114	1/2" x 85"	12-5118	12-7528	10252	1/2" x 44"	12-5077	12-7487	100022	5/8" x 89"	12-5216	12-7634
2027121	1/2" x 45"	12-5078	12-7488	10253	1/2" x 45"	12-5078	12-7488	323030	5/8" x 86"	12-5213	12-7631
2027134	1/2" x 70"	12-5103	12-7513	10419	1/2" x 26"	12-5059	12-7469	363143	5/8" x 89"	12-5216	12-7634
2027145	1/2" x 64"	12-5097	12-7507	10431	5/8" x 24"	12-5151		363144	5/8" x 44"	12-5171	12-7589
2027168	1/2" x 34"	12-5067	12-7477	10467	1/2" x 43"	12-5076	12-7486	363145	5/8" x 36"	12-5163	12-7581
2027197	1/2" x "56	12-5089	12-7499	10532	5/8" x 30"	12-5157	12-7575	573033	1/2" x 39"	12-5072	12-7482
2027350	1/2" x 79"	12-5112	12-7522	10629	1/2" x 98"	12-5131	12-7541	976353	5/8" x 86"	12-5213	12-7631
2027581	1/2" x 47"	12-5080	12-7490	10678	1/2" x 68"	12-5101	12-7511	976497	5/8" x 44"	12-5171	12-7589
2027624	1/2" x 96"	12-5129	12-7539	10682	1/2" x 93"	12-5126	12-7536	976498	5/8" x 36"	12-5163	12-7581
2027639	5/8" x 88"	12-5215	12-7633	10708	1/2" x 45"	12-5078	12-7488				
2027709	1/2" x 29"	12-5062	12-7472	10729	1/2" x 43"	12-5076	12-7486				
2028035	1/2" x 85"	12-5118	12-7528	10747	1/2" x 56"	12-5089	12-7499				
2028077	3/8" x 33"	12-5016	12-7438	10748	1/2" x 34"	12-5067	12-7477	SOUTHLAND			
2028217	1/2" x 43"	12-5076	12-7486	*10749	1/2" x 68"		12-673	HW677	5/8" x 49"	12-5176	12-7594
2028241	1/2" x 31"	12-5064	12-7474	10836	3/8" x 39"	12-5022	12-7444	R8-371	1/2" x 41"	12-5074	12-7484
2028474	1/2" x 49"	12-5082	12-7492	10837	3/8" x 44"	12-5027	12-7449	RR703	1/2" x 44"	12-5077	12-7487
2028459	1/2" x 24"	12-5057	12-7467	10849	3/8" x 25"	12-5008	12-7430	RR705	5/8" x 25"	12-5152	12-7570
2028766	1/2" x 93"	12-5126	12-7536	10851	1/2" x 44"	12-5077	12-7487	SP2-700	1/2" x 38"	12-5071	12-7481
2028988	5/8" x 49"	12-5176	12-7594	11712	1/2" x 52"	12-5085	12-7495	SP9-413	1/2" x 39"	12-5072	12-7482
2029056	1/2" x 57"	12-5090	12-7500	*11887	3/8" x 24-1/2"		12-669	STIHL			
2029223	1/2" x 44"	12-5077	12-7487	_11946	1/2" x 28"	12-5061	12-7471	9490-000-78401	1/2" x 29"	12-5062	12-7472
2029348	1/2" x 34"	12-5067	12-7477	11947	3/8" x 42"	12-5025	12-7447	9490-000-78911	1/2" x 27"	12-5060	12-7470
2029350	1/2" x 53"	12-5086	12-7496	11948	1/2" x 30"	12-5063	12-7473				
2029451	1/2" x 29"	12-5062	12-7472	11969	1/2" x 51"	12-5084	12-7494				
2029665	1/2" x 100"	12-5133	12-7543	12020	1/2" x 37"	12-5070	12-7480	TORO/WHEEL HORSE			
2029748	1/2" x 34"	12-5067	12-7477	12248	1/2" x 27"	12-5060	12-7470	100129	5/8" x 50"	12-5177	12-7595
2029789	3/8" x 38"	12-5021	12-7443	12249	1/2" x 37"	12-5070	12-7480	100230	1/2" x 40"	12-5073	12-7483
2029828	3/8" x 37"	12-5020	12-7442	*12353	3/8" x 25-1/2"		12-670	101137	1/2" x 68"	12-5101	12-7511
2029829	1/2" x 37"	12-5070	12-7480	*12354	3/32" x 22"		12-869	101140	5/8" x 80"	12-5207	12-7625
2056755	1/2" x 39"	12-5072	12-7482	12524	5/8" x 90"	12-5217	12-7635	101142	5/8" x 80"	12-5207	12-7625
2087648	1/2" x 72"	12-5105	12-7515	*12508	3/8" x 24-1/2"		12-669	101426	1/2" x 52"	12-5085	12-7495
2087732	1/2" x 78"	12-5111	12-7521	12561	1/2" x 54"	12-5087	12-7497	1023084	5/8" x 38"	12-5165	12-7583
2087759	1/2" x 66"	12-5099	12-7509	13436	1/2" x 54"	12-5087	12-7497	102465	3/8" x 21"	12-5004	
2087836	1/2" x 74"	12-5107	12-7517	13536	1/2" x 54"	12-5087	12-7497	102607	1/2" x 89"	12-5122	12-7532
2087883	3/8" x 34"	12-5017	12-7439	13936	3/8" x 37"	12-5020	12-7442	102741	1/2" x 97"	12-5130	12-7540
2097654	1/2" x 40"	12-5073	12-7483	13937	1/2" x 38"	12-5071	12-7481	*102742	1/2" x 103"		12-7171
24615	1/2" x 64"	12-5097	12-7507	13938	3/8" x 36"	12-5019	12-7441	102743	5/8" x 67"	12-5194	12-7612
2626869	3/8" x 39"	12-5022	12-7444	14225	1/2" x 100	12-5133	12-7543	103084	5/8" x 38"	12-5165	12-7583
296499	3/8" x 35"	12-5018	12-7440	14353	1/2" x 62"	12-5095	12-7505	103345	3/8" x 25"	12-5008	12-7430
529433	5/8" x 45"	12-5172	12-7590	14503	1/2" x 48"	12-5081	12-7491	103494	1/2" x 48"	12-5081	12-7491
6184	3/8" x 39"	12-5022	12-7444	*14525	1/2" x 105"		12-870	103522	1/2" x 85"	12-5118	12-7528
70675233	5/8" x 45"	12-5172	12-7590	14560	1/2" x 99"	12-5132	12-7542	104290	3/8" x 29"	12-5012	12-7434
71336137	5/8" x 66"	12-5193	12-7611	14637	3/8" x 33"	12-5016	12-7438	104388	1/2" x 55"	12-5088	12-7498
71352142	1/2" x 44"	12-5077	12-7487	14686	1/2" x 62"	12-5095	12-7505	104633	1/2" x 36"	12-5069	12-7479
71358134	5/8" x 86"	12-5213	12-7631	14716	1/2" x 36"	12-5069	12-7479	104865	1/2" x 55"	12-5088	12-7498
71601672	1/2" x 61"	12-5094	12-7504	14717	1/2" x 39"	12-5072	12-7482	105476	1/2" x 80"	12-5113	12-7523
71656960	1/2" x 84"	12-5117	12-7527	14747	1/2" x 39"	12-5072	12-7482	105477	1/2" x 40"	12-5073	12-7483
71664789	1/2" x 89"	12-5122	12-7532	*14799	1/2" x 103-3/32"		12-7129	*1058783	5/8" x 242"		12-12729

* indicates original type belt

OEM REPLACEMENT BELT APPLICATION GUIDE



OEM No.	Size	Premium Order No.	Aramid Order No.	OEM No.	Size	Premium Order No.	Aramid Order No.	OEM No.	Size	Premium Order No.	Aramid Order No.
TORO/WHEEL HORSE (Cont.)				TORO/WHEEL HORSE (Cont.)				TORO/WHEEL HORSE (Cont.)			
106125	1/2" x 89"	12-5122	12-7532	121000	1/2" x 76"	12-5109	12-7519	201820	1/2" x 39"	12-5072	12-7482
106390	1/2" x 36"	12-5069	12-7479	121228	1/2" x 37"	12-5070	12-7480	205990	3/8" x 50"	12-7455	
106496	5/8" x 85"	12-5212	12-7630	122650	5/8" x 56"	12-5183	12-7601	207159	3/8" x 32"	12-5015	12-7437
106497	5/8" x 84"	12-5211	12-7629	124780	1/2" x 47"	12-5080	12-7490	208527	1/2" x 48"	12-5081	12-7491
106516	1/2" x 83"	12-5116	12-7526	124790	1/2" x 43"	12-5076	12-7486	208626	3/8" x 27"	12-5010	12-7432
106518	1/2" x 87"	12-5120	12-7530	125580	1/2" x 72"	12-5105	12-7515	210890	5/8" x 72"	12-5199	12-7617
106523	1/2" x 41"	12-5074	12-7484	126220	1/2" x 33"	12-5066	12-7476	211810	1/2" x 45"	12-5078	12-7488
106533	1/2" x 40"	12-5073	12-7483	126420	1/2" x 41"	12-5074	12-7484	21950	3/8" x 35"	12-5018	12-7440
106689	1/2" x 55"	12-5088	12-7498	126430	1/2" x 47"	12-5080	12-7490	224230	5/8" x 29"	12-5156	12-7574
*1067350	5/8" x 264"	12-12730		126550	1/2" x 54"	12-5087	12-7497	225187	1/2" x 39"	12-5072	12-7482
106751	1/2" x 80"	12-5113	12-7523	128200	1/2" x 45"	12-5078	12-7488	225282	1/2" x 41"	12-5074	12-7484
107120	5/8" x 62"	12-5189	12-7607	128260	1/2" x 45"	12-5078	12-7488	225360	1/2" x 63"	12-5096	12-7506
107230	1/2" x 60"	12-5093	12-7503	128410	5/8" x 85"	12-5212	12-7630	225385	1/2" x 52"	12-5085	12-7495
107298	1/2" x 72"	12-5105	12-7515	132640	5/8" x 86"	12-5213	12-7631	230080	1/2" x 40"	12-5073	12-7483
107320	1/2" x 60"	12-5093	12-7503	1526	1/2" x 22"	12-5055		230220	3/8" x 37"	12-5020	12-7442
107636	1/2" x 28"	12-5061	12-7471	1550	1/2" x 42"	12-5075	12-7485	245660	1/2" x 39"	12-5072	12-7482
107637	1/2" x 88"	12-5121	12-7531	1552	1/2" x 37"	12-5070	12-7480	24663	1/2" x 83"	12-5116	12-7526
107647	1/2" x 70"	12-5103	12-7513	1553	1/2" x 36"	12-5069	12-7479	248940	3/8" x 33"	12-5016	12-7438
107740	1/2" x 94"	12-5127	12-7537	1554	1/2" x 24"	12-5057	12-7467	239080	1/2" x 40"	12-5073	12-7483
107741	1/2" x 97"	12-5130	12-7540	1555	1/2" x 44"	12-5077	12-7487	249730	3/8" x 36"	12-5019	12-7441
107746	5/8" x 84"	12-5211	12-7629	1556	1/2" x 20"	12-5053		250105	1/2" x 40"	12-5073	12-7483
107769	1/2" x 89"	12-5122	12-7532	1558	1/2" x 28"	12-5061	12-7471	250106	3/8" x 46"	12-5029	12-7451
107939	5/8" x 82"	12-5209	12-7627	1559	1/2" x 27"	12-5060	12-7470	251028	3/8" x 34"	12-5017	12-7439
108195	1/2" x 67"	12-5100	12-7510	1561	1/2" x 30"	12-5063	12-7473	251030	3/8" x 47"	12-5030	12-7452
108196	1/2" x 50"	12-5083	12-7493	1562	1/2" x 88"	12-5121	12-7531	251884	3/8" x 26"	12-5009	12-7431
108427	1/2" x 88"	12-5121	12-7531	1563	1/2" x 39"	12-5072	12-7482	2539	3/8" x 34"	12-5017	12-7439
108491	1/2" x 67"	12-5100	12-7510	1564	1/2" x 19"	12-5052		*256430	3/32" x 33"	12-7952	
108492	1/2" x 57"	12-5090	12-7500	1566	1/2" x 35"	12-5068	12-7478	258340	3/8" x 33"	12-5061	12-7438
108501	5/8" x 81"	12-5208	12-7626	1567	1/2" x 29"	12-5062	12-7472	259850	1/2" x 50"	12-5083	12-7493
108502	5/8" x 82"	12-5209	12-7627	1569	1/2" x 29"	12-5062	12-7472	262770	1/2" x 50"	12-5083	12-7493
108503	1/2" x 65"	12-5098	12-7508	1570	1/2" x 69"	12-5102	12-7512	263050	1/2" x 50"	12-5083	12-7493
108834	1/2" x 98"	12-5131	12-7541	1571	1/2" x 32"	12-5065	12-7475	263340	1/2" x 43"	12-5076	12-7486
108960	1/2" x 88"	12-5121	12-7531	1572	1/2" x 34"	12-5067	12-7477	263540	1/2" x 34"	12-5067	12-7477
108971	1/2" x 49"	12-5082	12-7492	1573	1/2" x 30"	12-5063	12-7473	269670	1/2" x 40"	12-5073	12-7483
109427	1/2" x 77"	12-5110	12-7520	1574	1/2" x 33"	12-5066	12-7476	*269671	1/2" x 39-5/16"	12-10746	
109428	1/2" x 76"	12-5109	12-7519	1575	1/2" x 26"	12-5059	12-7469	*269672	1/2" x 30"	12-10210	
109640	1/2" x 56"	12-5089	12-7499	1576	1/2" x 70"	12-5103	12-7513	27110	5/8" x 31"	12-5158	12-7576
109748	5/8" x 87"	12-5214	12-7632	1577	1/2" x 28"	12-5061	12-7471	271100	1/2" x 52"	12-5085	12-7495
109807	1/2" x 99"	12-5132	12-7542	1578	3/8" x 37"	12-5020	12-7442	271101	5/8" x 46"	12-5173	12-7591
109908	1/2" x 92"	12-5125	12-7535	1578P	3/8" x 37"	12-5020	12-7442	271102	5/8" x 85"	12-5118	12-7630
109956	1/2" x 102"	12-6630	12-7545	1579	1/2" x 24"	12-5057	12-7467	271104	1/2" x 38"	12-5071	12-7481
110037	5/8" x 77"	12-5204	12-7622	1580	1/2" x 31"	12-5064	12-7474	27111	5/8" x 34"	12-5161	12-7579
110141	1/2" x 41"	12-5074	12-7484	1581	3/8" x 45"	12-5028	12-7450	27112	5/8" x 37"	12-5164	12-7582
110364	1/2" x 33"	12-5066	12-7476	1582	1/2" x 74"	12-5107	12-7517	27113	1/2" x 28"	12-5061	12-7471
110420	1/2" x 48"	12-5081	12-7491	1583	3/8" x 31"	12-5014	12-7436	27114	5/8" x 42"	12-5075	12-7587
110610	5/8" x 85"	12-5212	12-7630	1584	5/8" x 51"	12-5178	12-7596	27115	1/2" x 36"	12-5069	12-7479
110611	5/8" x 29"	12-5156	12-7574	1585	1/2" x 76"	12-5109	12-7519	27116	1/2" x 20"	12-5053	
111435	1/2" x 92"	12-5125	12-7535	1586	1/2" x 76"	12-5109	12-7519	*271160	1/2" x 103 1/2"	12-6837	
111563	1/2" x 50"	12-5083	12-7493	1587	1/2" x 43"	12-5076	12-7486	27117	1/2" x 21"	12-5054	
111710	1/2" x 53"	12-5086	12-7496	1588	1/2" x 59"	12-5092	12-7502	27129	1/2" x 25"	12-5058	12-7468
111720	1/2" x 53"	12-5086	12-7496	1589	1/2" x 57"	12-5090	12-7500	2713	1/2" x 24"	12-5057	12-7467
111730	1/2" x 35"	12-5068	12-7478	1590	3/8" x 43"	12-5026	12-7448	27133	1/2" x 31"	12-5064	12-7474
111740	1/2" x 60"	12-5093	12-7503	1591	3/8" x 48"	12-5031	12-7453	27134	5/8" x 29"	12-5156	12-7574
112084	1/2" x 30"	12-5063	12-7473	1592	1/2" x 82"	12-5115	12-7525	27138	5/8" x 29"	12-5156	12-7574
112801	5/8" x 83"	12-5210	12-7628	1593	3/8" x 35"	12-5018	12-7440	27139	1/2" x 50"	12-5083	12-7493
113072	1/2" x 102"	12-6630	12-7545	1595	1/2" x 67"	12-5100	12-7510	2714	1/2" x 30"	12-5063	12-7473
113105	1/2" x 33"	12-5066	12-7476	1596	1/2" x 51"	12-5084	12-7494	27140	1/2" x 39"	12-5072	12-7482
113141	1/2" x 76"	12-5109	12-7519	1597	3/8" x 25"	12-5008	12-7430	27142	1/2" x 39"	12-5072	12-7482
113288	1/2" x 42"	12-5075	12-7485	1598	1/2" x 22"	12-5055		27143	1/2" x 23"	12-5056	12-7466
113303	1/2" x 43"	12-5076	12-7486	161098	1/2" x 39"	12-5072	12-7482	27144	5/8" x 30"	12-5157	12-7575
113912	1/2" x 44"	12-5077	12-7487	*1653283	1/2" x 52-1/4"	12-13408		2715	1/2" x 35"	12-5068	12-7478
114421	1/2" x 54"	12-5087	12-7497	170850	1/2" x 40"	12-5073	12-7483	27150	5/8" x 33"	12-5160	12-7578
114433	1/2" x 83"	12-5116	12-7526	176540	1/2" x 40"	12-5073	12-7483	27154	5/8" x 25"	12-5152	12-7570
114567	1/2" x 48"	12-5081	12-7491	182010	3/8" x 36"	12-5019	12-7441	27156	1/2" x 34"	12-5067	12-7477
114718	1/2" x 46"	12-5079	12-7489	188450	3/8" x 36"	12-5019	12-7441	27157	3/8" x 25"	12-5008	12-7430
114860	1/2" x 93"	12-5126	12-7536	188890	1/2" x 50"	12-5083	12-7493	27158	1/2" x 34"	12-5067	12-7477
114895	5/8" x 83"	12-5210	12-7628	192220	1/2" x 44"	12-5077	12-7487	27159	1/2" x 33"	12-5066	12-7476
116160	5/8" x 72"	12-5199	12-7617	192650	1/2" x 37"	12-5070	12-7480	2716	1/2" x 18"	12-5051	
116183	5/8" x 51"	12-5178	12-7596	192790	1/2" x 41"	12-5074	12-7484	27168	5/8" x 43"	12-5170	12-7588
11624	1/2" x 76"	12-5109	12-7519	192792	1/2" x 41"	12-5074	12-7484	27169	1/2" x 70"	12-5103	12-7513
116511	1/2" x 94"	12-5127	12-7537	196950	1/2" x 35"	12-5068	12-7478	27171	3/8" x 45"	12-5028	12-7450
11740	1/2" x 60"	12-5093	12-7503	196960	1/2" x 35"	12-5068	12-7478	27172	1/2" x 26"	12-5059	12-7469
118068	1/2" x 34"	12-5067	12-7477	196980	1/2" x 35"	12-5068	12-7478	27173	1/2" x 37"	12-5070	12-7480
118116	3/8" x 36"	12-5019	12-7441	197050	1/2" x 53"	12-5086	12-7496	27174	1/2" x 34"	12-5067	12-7477
118190	1/2" x 60"	12-5093	12-7503	197420	1/2" x 60"	12-5093	12-7503	27178	5/8" x 29"	12-5156	12-7574
118225											



OEM REPLACEMENT BELT APPLICATION GUIDE

OEM No.	Size	Premium Order No.	Aramid Order No.	OEM No.	Size	Premium Order No.	Aramid Order No.	OEM No.	Size	Premium Order No.	Aramid Order No.
TORO/WHEEL HORSE (Cont.)				TORO/WHEEL HORSE (Cont.)				TORO/WHEEL HORSE (Cont.)			
27182	1/2" x 38"	12-5071	12-7481	51583	1/2" x 24"	12-5057	12-7467	71221	1/2" x 54"	12-5087	12-7497
27183	5/8" x 31"	12-5158	12-7576	517436	1/2" x 44"	12-5077	12-7487	71241	1/2" x 31"	12-5064	12-7474
27184	5/8" x 41"	12-5168	12-7586	517437	1/2" x 46"	12-5079	12-7489	71277	3/8" x 34"	12-5017	12-7439
27185	1/2" x 50"	12-5083	12-7493	517439	1/2" x 22"	12-5066		71390	1/2" x 69"	12-5102	12-7512
2719	5/8" x 28"	12-5155	12-7573	517440	1/2" x 34"	12-5067	12-7477	71410	1/2" x 48"	12-5081	12-7491
27191	5/8" x 48"	12-5175	12-7593	5203320	1/2" x 29"	12-5062	12-7472	71420	1/2" x 66"	12-5099	12-7509
27195	1/2" x 37"	12-5070	12-7480	523272	5/8" x 39"	12-5166	12-7584	71472	5/8" x 46"	12-5173	12-7591
27196	5/8" x 47"	12-5174	12-7592	534650	1/2" x 28"	12-5061	12-7471	*715381	3/8" x 34-1/2"		12-10090
27197	1/2" x 45"	12-5078	12-7488	541360	1/2" x 49"	12-5082	12-7492	72160	3/8" x 32"	12-5015	12-7437
27199	1/2" x 61"	12-5094	12-7504	541380	1/2" x 74"	12-5107	12-7517	72166	3/8" x 32"	12-5015	12-7437
274630	1/2" x 29"	12-5062	12-7472	541390	1/2" x 56"	12-5089	12-7499	7236	1/2" x 22"	12-5055	
282650	1/2" x 102"	12-6630	12-7545	542750	5/8" x 70"	12-5197	12-7615	72366	1/2" x 59"	12-5092	12-7502
282990	1/2" x 28"	12-5061	12-7471	54505	3/8" x 31"	12-5014	12-7436	73148	1/2" x 39"	12-5072	12-7482
285250	1/2" x 53"	12-5086	12-7496	557660	5/8" x 71"	12-5198	12-7616	73476	1/2" x 62"	12-5095	12-7505
288630	1/2" x 34"	12-5067	12-7477	*557660	5/8" x 71"		12-6972	7358	1/2" x 66"	12-5099	12-7509
294650	1/2" x 41"	12-5074	12-7484	*559300	9/16" x 34"		12-9861	73887	1/2" x 29"	12-5062	12-7472
30302	5/8" x 79"	12-5206	12-7624	565570	1/2" x 54"	12-5087	12-7497	73888	1/2" x 45"	12-5078	12-7488
309010	1/2" x 36"	12-5069	12-7479	573650	1/2" x 57"	12-5090	12-7500	73888C	1/2" x 47"	12-5080	12-7490
309600	1/2" x 60"	12-5093	12-7503	574750	1/2" x 58"	12-5091	12-7501	73890	1/2" x 45"	12-5078	12-7488
309670	1/2" x 26"	12-5059	12-7469	576990	1/2" x 82"	12-5115	12-7525	73890C	1/2" x 45"	12-5078	12-7488
309850	1/2" x 51"	12-5084	12-7494	577000	1/2" x 43"	12-5076	12-7486	73975	1/2" x 50"	12-5083	12-7493
31182	3/8" x 30"	12-5013	12-7435	5950	1/2" x 28"	12-5061	12-7471	74228	1/2" x 48"	12-5081	12-7491
31183	3/8" x 17"	12-5000		59760	1/2" x 44"	12-5077	12-7487	74226	1/2" x 48"	12-5081	12-7491
31560	1/2" x 50"	12-5083	12-7493	59770	1/2" x 48"	12-5081	12-7491	74230	1/2" x 57"	12-5090	12-7500
31662	1/2" x 23"	12-5056	12-7466	60154	1/2" x 36"	12-5069	12-7479	74231	1/2" x 33"	12-5066	12-7476
31663	3/8" x 27"	12-5010	12-7432	60155	1/2" x 60"	12-5093	12-7503	74232	1/2" x 71"	12-5104	12-7514
32251	1/2" x 27"	12-5060	12-7470	613380	5/8" x 54"	12-5181	12-7599	74233	1/2" x 60"	12-5093	12-7509
32451	1/2" x 30"	12-5063	12-7473	6146	1/2" x 72"	12-5105	12-7515	74234	1/2" x 33"	12-5066	12-7476
32604	1/2" x 35"	12-5068	12-7478	623900	3/8" x 35"	12-5018	12-7440	7430	1/2" x 28"	12-5061	12-7471
32733	1/2" x 25"	12-5058	12-7468	6489	1/2" x 78"	12-5111	12-7521	7473	5/8" x 82"	12-5209	12-7627
34058	1/2" x 30"	12-5063	12-7473	6506	1/2" x 32"	12-5065	12-7475	74750	1/2" x 58"	12-5091	12-7501
34577	1/2" x 47"	12-5080	12-7490	6509	1/2" x 32"	12-5065	12-7475	7478	5/8" x 84"	12-5211	12-7629
34663	3/8" x 28"	12-5011	12-7433	6551	3/8" x 31"	12-5014	12-7436	76740	1/2" x 43"	12-5076	12-7486
34733	5/8" x 29"	12-5156	12-7574	6552	3/8" x 30"	12-5013	12-7435	7776	1/2" x 87"	12-5120	12-7530
35377	1/2" x 39"	12-5166	12-7482	_6570	1/2" x 38"	12-5071	12-7481	7831	3/8" x 26"	12-5009	12-7431
35585	1/2" x 43"	12-5170	12-7486	6573	1/2" x 38"	12-5071	12-7481	7832	1/2" x 52"	12-5085	12-7495
35843	1/2" x 45"	12-5078	12-7488	671390	1/2" x 51"	12-5084	12-7494	79160	1/2" x 57"	12-5090	12-7500
35856	1/2" x 53"	12-5086	12-7496	*671390	1/2" x 51"		12-7170	79170	1/2" x 50"	12-5083	12-7493
35857	3/8" x 27"	12-5010	12-7432	6737	1/2" x 69"	12-5102	12-7512	7927	1/2" x 78"	12-5111	12-7521
36044	1/2" x 27"	12-5060	12-7470	6738	1/2" x 86"	12-5119	12-7529	79390	1/2" x 60"	12-5093	12-7503
36111	1/2" x 43"	12-5076	12-7486	6771	1/2" x 71"	12-5104	12-7514	8005	1/2" x 72"	12-5105	12-7515
362920	1/2" x 61"	12-5094	12-7504	683030	5/8" x 76"	12-5203	12-7621	8133	1/2" x 74"	12-5107	12-7517
36348	1/2" x 43"	12-5076	12-7486	68400	1/2" x 44"	12-5077	12-7487	8160	5/8" x 83"	12-5210	12-7628
36593	1/2" x 41"	12-5074	12-7484	68428	3/8" x 27"	12-5010	12-7432	8231	1/2" x 70"	12-5103	12-7513
368070	3/8" x 34"	12-5017	12-7439	6849	1/2" x 78"	12-5111	12-7521	8334	5/8" x 84"	12-5211	12-7629
37274	3/8" x 32"	12-5015	12-7437	68850	3/8" x 31"	12-5014	12-7436	8411	1/2" x 77"	12-5110	12-7520
375650	1/2" x 33"	12-5066	12-7476	6993	1/2" x 22"	12-5055		8412	1/2" x 86"	12-5119	12-7529
375660	5/8" x 60"	12-5187	12-7605	70073	1/2" x 34"	12-5067	12-7477	8430	1/2" x 59"	12-5092	12-7502
375670	1/2" x 54"	12-5087	12-7497	70074	3/8" x 31"	12-5014	12-7436	85660	3/8" x 33"	12-5016	12-7438
379080	3/8" x 30"	12-5012	12-7434	70161	1/2" x 60"	12-5093	12-7503	8677	1/2" x 52"	12-5085	12-7495
379090	3/8" x 29"	12-5012	12-7434	70162	5/8" x 32"	12-5159	12-7577	8687	1/2" x 52"	12-5085	12-7495
380080	1/2" x 45"	12-5078	12-7488	70354	1/2" x 33"	12-5066	12-7476	8699	1/2" x 102"	12-6630	12-7545
38093	1/2" x 26"	12-5059	12-7469	70355	3/8" x 31"	12-5014	12-7436	8911	1/2" x 83"	12-5116	12-7526
38095	1/2" x 34"	12-5067	12-7477	70364	1/2" x 33"	12-5066	12-7476	8975	1/2" x 58"	12-5091	12-7501
38166	1/2" x 40"	12-5073	12-7483	7041	1/2" x 72"	12-5105	12-7515	8976	1/2" x 55"	12-5088	12-7498
38445	1/2" x 38"	12-5071	12-7481	70530	3/8" x 35"	12-5018	12-7440	9151	5/8" x 90"	12-5217	12-7635
393770	1/2" x 30"	12-5063	12-7473	70550	3/8" x 27"	12-5010	12-7432	9360	1/2" x 96"	12-5129	12-7539
393780	1/2" x 27"	12-5060	12-7470	70657	3/8" x 32"	12-5015	12-7437	9430	1/2" x 36"	12-5069	12-7479
394390	5/8" x 52"	12-5179	12-7597	70737	3/8" x 35"	12-5018	12-7440	9431	1/2" x 39"	12-5072	12-7482
409440	3/8" x 35"	12-5018	12-7440	70824	1/2" x 31"	12-5064	12-7474	9691	1/2" x 70"	12-5103	12-7513
419150	1/2" x 29"	12-5062	12-7472	70827	1/2" x 31"	12-5064	12-7474	9714	1/2" x 76"	12-5109	12-7519
420880	1/2" x 23"	12-5056	12-7466	70946	1/2" x 30"	12-5063	12-7473	9750	5/8" x 69"	12-5196	12-7614
420881	1/2" x 23"	12-5056	12-7466	71134	5/8" x 52"	12-5179	12-7597	9782	1/2" x 69"	12-5102	12-7512
420882	1/2" x 33"	12-5066	12-7476	71137	5/8" x 46"	12-5173	12-7591	9783	1/2" x 71"	12-5104	12-7514
*420884	1/2" x 23.92"		12-8887	71141	5/8" x 48"	12-5175	12-7593	*994647	21/32" x 142.10"		12-10051
431030	1/2" x 37"	12-5070	12-7480	71147	5/8" x 41"	12-5168	12-7586	*93-0232	3/8" x 31.939"		12-13247
*446260	1/2" x 122-1/8"		12-10387	71150	5/8" x 43"	12-5170	12-7588	*108-2693	5/8" x 81-3/4"		12-13569
471410	1/2" x 48"	12-5081	12-7491	71156	1/2" x 43"	12-5076	12-7486	*108-2694	5/8" x 111"		12-13570
*471410	1/2" x 47-1/2"		12-5820	71160	5/8" x 42"	12-5169	12-7587	*108-2715	5/8" x 78-21/64"		12-13571
*471420	1/2" x 65 17/32"		12-5821	71164	1/2" x 39"	12-5072	12-7482	*108-2716	5/8" x 105-19/64"		12-13572
499100	3/8" x 40"	12-5023	12-7445	71167	1/2" x 25"	12-5058	12-7468	*110-5049	1/2" x 46-15/16"		12-13573
50104	1/2" x 31"	12-5064	12-7474	71168	3/8" x 34"	12-5017	12-7439				
50760	1/2" x 44"	12-5077	12-7487	71172	5/8" x 37"	12-5164	12-7582				
50934	5/8" x 30"	12-5157	12-7575	71178	5/8" x 36"	12-5163	12-7581				
*514290	1-3/16" x 50 3/8"		12-5231	71185	1/2" x 26"	12-5059	12-7469				
513530	1/2" x 51"	12-5084	12-7494	71191	1/2" x 32"	12-5065	12-7475				
513600	1/2" x 63"	12-5096	12-7506	71193	1/2" x 51"	12-5084	12-7494				
				71194	1/2" x 30"	12-5063	12-7473				

* indicates original type belt

OEM REPLACEMENT BELT APPLICATION GUIDE



OEM No.	Size	Premium Order No.	Aramid Order No.	OEM No.	Size	Premium Order No.	Aramid Order No.	OEM No.	Size	Premium Order No.	Aramid Order No.
TROY BILT (Cont.)				WHITE (Cont.)				YARDMAN (Cont.)			
20565	1/2" x 24"	12-5057	12-7467	32-0054100	5/8" x 52"	12-5179	12-7597	165187	1/2" x 40"	12-5073	12-7483
237452	1/2" x 32"	12-5065	12-7475	32-0055301	1/2" x 42"	12-5075	12-7485	165187A	1/2" x 40"	12-5073	12-7483
237453	1/2" x 29"	12-5062	12-7472	32-0055883	3/8" x 36"	12-5019	12-7441	165445	1/2" x 36"	12-5069	12-7479
239661	3/8" x 36"	12-5019	12-7441	32-0057088	1/2" x 107"	12-6635	12-7550	2006	1/2" x 28"	12-5061	12-7471
50028	1/2" x 21"	12-5054		32-0060453	1/2" x 56"	12-5089	12-7499	2034	1/2" x 32"	12-5065	12-7475
50134	3/8" x 28"	12-5011	12-7433	32-0060461	5/8" x 63"	12-5190	12-7608	2036	1/2" x 33"	12-5066	12-7476
50161	1/2" x 25"	12-5058	12-7468	32-0060801	1/2" x 52"	12-5085	12-7495	224565114	1/2" x 40"	12-5073	12-7483
839-3780	1/2" x 27"	12-5060	12-7470	32-0062898	1/2" x 59"	12-5092	12-7502	224S3096	1/2" x 36"	12-5069	12-7479
9022	3/8" x 22"	12-5005		32-0062928	1/2" x 40"	12-5073	12-7483	26130114	1/2" x 38"	12-5071	12-7481
9095	3/8" x 27"	12-5010	12-7432	32-0063916	1/2" x 41"	12-5074	12-7484	2616590	1/2" x 45"	12-5078	12-7488
9200	3/8" x 22"	12-5005		322-0024368	1/2" x 62"	12-5095	12-7505	26230114	1/2" x 38"	12-5071	12-7481
9201	1/2" x 24"	12-5057	12-7467	34-0023434	3/8" x 36"	12-5019	12-7441	2626590	1/2" x 45"	12-5078	12-7488
9245	1/2" x 22"	12-5055		YARDMAN				265111	1/2" x 23"	12-5056	12-7466
*9245	1/2" x 22-1/4"	12-10822		1042	1/2" x 22"	12-5055		265114	1/2" x 38"	12-5071	12-7481
WALKER				1063	1/2" x 39"	12-5072	12-7482	265115	1/2" x 62"	12-5095	12-7505
*6231	3/8" x 35.5"	12-8820		1651020	1/2" x 18"	12-5051		265123	1/2" x 33"	12-5066	12-7476
*6250	3/8" x 37-1/2"	12-12246		165110	3/8" x 17"	12-5000		265125	1/2" x 32"	12-5065	12-7475
*7230	1-1/4" x 38"	12-10320		165111	1/2" x 23"	12-5056	12-7466	265126	1/2" x 34"	12-5067	12-7477
*7234	3/8" x 28"	12-8819		165112	3/8" x 19"	12-5002		265128	5/8" x 27"	12-5154	12-7572
*7234-1	9/16" x 28-17/32"	12-10321		165113	1/2" x 25"	12-5058	12-7468	265140	5/8" x 56"	12-5183	12-7601
*7235	1/2" x 47.08"	12-8798		165114	1/2" x 38"	12-5071	12-7481	30SB31	1/2" x 36"	12-5069	12-7479
*7248	9/16" x 47"	12-10322		165115	1/2" x 62"	12-5095	12-7505	30SB31	1/2" x 31"	12-5064	12-7474
*8230	1-1/4" x 40-7/16"	12-10323		165117	1/2" x 61"	12-5094	12-7504	365188	1/2" x 42"	12-5075	12-7485
WESTERN INT'L (See NOMA)				165118	1/2" x 38"	12-5071	12-7481	365189A	1/2" x 55"	12-5088	12-7498
WHEEL HORSE (See TORO/WHEEL HORSE)				165119	1/2" x 25"	12-5058	12-7468	40021	1/2" x 36"	12-5069	12-7479
WHITE				165120	1/2" x 18"	12-5051		40041	1/2" x 40"	12-5073	12-7483
32-0000469	3/8" x 31"	12-5014	12-7436	165121	1/2" x 23"	12-5056	12-7466	40207	1/2" x 45"	12-5078	12-7488
32-0005118	1/2" x 30"	12-5063	12-7473	165123	1/2" x 33"	12-5066	12-7476	40216	1/2" x 38"	12-5071	12-7481
32-0005843	5/8" x 35"	12-5162	12-7580	165128	5/8" x 27"	12-5154	12-7572	40346	1/2" x 43"	12-5076	12-7486
32-0005908	5/8" x 28"	12-5155	12-7573	165130	1/2" x 29"	12-5062	12-7472	40572	1/2" x 44"	12-5077	12-7487
32-0007153	5/8" x 37"	12-5164	12-7582	165131	1/2" x 45"	12-5078	12-7488	40591	1/2" x 31"	12-5064	12-7474
32-0007358	5/8" x 69"	12-5196	12-7614	165132	1/2" x 27"	12-5060	12-7470	41969	5/8" x 50"	12-5177	12-7595
32-0007382	1/2" x 65"	12-5098	12-7508	165133	1/2" x 35"	12-5068	12-7478	41980	1/2" x 67"	12-5100	12-7510
32-0009040	5/8" x 50"	12-5177	12-7595	165137	1/2" x 36"	12-5069	12-7479	41993	1/2" x 59"	12-5092	12-7502
32-0009059	5/8" x 70"	12-5197	12-7615	165138	1/2" x 40"	12-5073	12-7483	50S4631	1/2" x 31"	12-5064	12-7474
32-0009962	1/2" x 63"	12-5096	12-7506	165139	1/2" x 56"	12-5089	12-7499	50S4631	1/2" x 31"	12-5064	12-7474
32-0009997	5/8" x 64"	12-5191	12-7609	165140	5/8" x 56"	12-5183	12-7601	50018	1/2" x 30"	12-5063	12-7473
32-0011738	1/2" x 34"	12-5067	12-7477	165141	1/2" x 40"	12-5073	12-7483	7540106	1/2" x 25"	12-5058	12-7468
32-0015148	1/2" x 82"	12-5115	12-7525	165142	1/2" x 41"	12-5074	12-7484	7540107	1/2" x 30"	12-5063	12-7473
32-0015334	1/2" x 49"	12-5082	12-7492	165143	1/2" x 56"	12-5089	12-7499	7540109	1/2" x 43"	12-5076	12-7486
32-0015466	5/8" x 54"	12-5181	12-7599	165144	1/2" x 36"	12-5069	12-7479	7540138	5/8" x 50"	12-5177	12-7595
32-0016470	5/8" x 78"	12-5205	12-7623	165145	1/2" x 36"	12-5069	12-7479	7540154	1/2" x 37"	12-5070	12-7480
32-0018635	5/8" x 50"	12-5177	12-7595	165146	3/8" x 36"	12-5019	12-7441	7540189	1/2" x 44"	12-5077	12-7487
32-0018910	5/8" x 82"	12-5209	12-7627	165151	1/2" x 63"	12-5096	12-7506	7540201	1/2" x 41"	12-5074	12-7484
32-0020028	1/2" x 34"	12-5067	12-7477	165152	5/8" x 61"	12-5188	12-7606	7540204	1/2" x 67"	12-5100	12-7510
32-0020699	1/2" x 52"	12-5085	12-7495	1165152	5/8" x 60"	12-5187	12-7605	7540210	5/8" x 60"	12-5187	12-7605
32-0021253	5/8" x 51"	12-5178	12-7596	165153	1/2" x 62"	12-5095	12-7505	7540212	5/8" x 45"	12-5172	12-7590
32-0021407	5/8" x 31"	12-5158	12-7576	165154	1/2" x 64"	12-5097	12-7507	7540223	3/8" x 36"	12-5091	12-7441
32-0021539	1/2" x 34"	12-5067	12-7477	165159	1/2" x 58"	12-5091	12-7501	7540935	1/2" x 31"	12-5064	12-7474
32-0027804	1/2" x 38"	12-5071	12-7481	165160	1/2" x 40"	12-5073	12-7483	754204	1/2" x 67"	12-5100	12-7510
32-0027898	1/2" x 100"	12-5133	12-7543	165161	5/8" x 61"	12-5188	12-7606	754206	1/2" x 50"	12-5083	12-7493
32-0029157	1/2" x 50"	12-5083	12-7493	165162	5/8" x 87"	12-5214	12-7632	754216	3/8" x 29"	12-5012	12-7434
32-0029483	1/2" x 42"	12-5075	12-7485	165163	1/2" x 65"	12-5098	12-7508	754221	5/8" x 52"	12-5179	12-7597
32-0030104	1/2" x 33"	12-5066	12-7476	165165	1/2" x 67"	12-5100	12-7510	754224	5/8" x 26"	12-5153	12-7571
32-0031909	1/2" x 54"	12-5087	12-7497	165166	1/2" x 64"	12-5097	12-7507	75400329	5/8" x 69"	12-5196	12-7614
32-0041165	1/2" x 41"	12-5074	12-7484	165167	5/8" x 51"	12-5178	12-7596	YAZOO			
32-0041327	1/2" x 37"	12-5070	12-7480	165168	1/2" x 37"	12-5070	12-7480	1202	1/2" x 22"	12-5055	
32-0041971	1/2" x 35"	12-5068	12-7478	165168D	1/2" x 37"	12-5070	12-7480	1204	1/2" x 24"	12-5057	12-7467
32-004391	1/2" x 57"	12-5090	12-7500	165169	1/2" x 55"	12-5088	12-7498	1206	1/2" x 26"	12-5059	12-7469
32-0044113	1/2" x 45"	12-5078	12-7488	165171	5/8" x 63"	12-5190	12-7608	1208	1/2" x 28"	12-5061	12-7471
32-0044202	1/2" x 35"	12-5068	12-7478	165172	1/2" x 67"	12-5100	12-7510	1302	1/2" x 32"	12-5065	12-7475
32-0045527	3/8" x 29"	12-5012	12-7434	165173	5/8" x 63"	12-5190	12-7608	1304	1/2" x 34"	12-5067	12-7477
32-0048631	5/8" x 45"	12-5172	12-7590	165174	5/8" x 48"	12-5175	12-7593	1306	1/2" x 36"	12-5069	12-7479
32-0048658	5/8" x 60"	12-5187	12-7605	165174A	5/8" x 48"	12-5175	12-7593	1307	1/2" x 37"	12-5070	12-7480
32-0050024	1/2" x 53"	12-5086	12-7496	165175	5/8" x 34"	12-5161	12-7579	1401	1/2" x 41"	12-5074	12-7484
32-005096	1/2" x 42"	12-5058	12-7468	165176	1/2" x 50"	12-5083	12-7493	1404	1/2" x 44"	12-5077	12-7487
32-0051918	1/2" x 44"	12-5077	12-7487	165176A	1/2" x 50"	12-5083	12-7493	1405	1/2" x 45"	12-5078	12-7488
32-0052868	1/2" x 28"	12-5061	12-7471	165179	5/8" x 78"	12-5205	12-7623	1407	1/2" x 47"	12-5080	12-7490
32-0053295	1/2" x 82"	12-5115	12-7525	165181	1/2" x 39"	12-5072	12-7482	1508	1/2" x 58"	12-5091	12-7501
32-0054089	5/8" x 27"	12-5154	12-7572	165182	1/2" x 54"	12-5087	12-7497	103331	3/8" x 31"	12-5014	12-7436
				165183	1/2" x 57"	12-5090	12-7500	*104335	5/8" x 163-1/2"	12-10823	
				165183B	1/2" x 25"	12-5090	12-7500	*104336	5/8" x 183-3/8"	12-10824	
				165184	1/2" x 55"	12-5088	12-7498	*105477	5/8" x 198-1/2"	12-10825	
				165185	1/2" x 37"	12-5070	12-7480	205020	1/2" x 20"	12-5053	
				165186	1/2" x 44"	12-5077	12-7487	205021	1/2" x 21"	12-5054	
				165186A	1/2" x 44"	12-5077	12-7487	205022	1/2" x 22"	12-5055	



OEM REPLACEMENT BELT APPLICATION GUIDE

OEM No.	Size	Premium Order No.	Aramid Order No.	OEM No.	Size	Premium Order No.	Aramid Order No.	OEM No.	Size	Premium Order No.	Aramid Order No.
YAZOO (Cont.)											
205024	1/2" x 24"	12-5057	12-7467								
205026	1/2" x 26"	12-5059	12-7469								
205027	1/2" x 27"	12-5060	12-7470								
205028	1/2" x 28"	12-5061	12-7471								
205030	1/2" x 30"	12-5063	12-7473								
205031	1/2" x 31"	12-5064	12-7474								
205032	1/2" x 32"	12-5065	12-7475								
205033	1/2" x 33"	12-5066	12-7476								
205034	1/2" x 34"	12-5067	12-7477								
205035	1/2" x 35"	12-5068	12-7478								
205036	1/2" x 36"	12-5069	12-7479								
205037	1/2" x 37"	12-5070	12-7480								
205039	1/2" x 39"	12-5072	12-7482								
205040	1/2" x 40"	12-5073	12-7483								
205041	1/2" x 41"	12-5074	12-7484								
205042	1/2" x 42"	12-5075	12-7485								
205044	1/2" x 44"	12-5077	12-7487								
205045	1/2" x 45"	12-5078	12-7488								
205046	1/2" x 46"	12-5079	12-7489								
205047	1/2" x 47"	12-5080	12-7490								
205048	1/2" x 48"	12-5081	12-7491								
205049	1/2" x 49"	12-5082	12-7492								
205050	1/2" x 50"	12-5083	12-7493								
205051	1/2" x 51"	12-5084	12-7494								
205053	1/2" x 53"	12-5086	12-7496								
205055	5/8" x 58"	12-5185	12-7603								
205058	1/2" x 58"	12-5091	12-7501								
205061	1/2" x 61"	12-5094	12-7504								
205065	5/8" x 66"	12-5193	12-7611								
205070	5/8" x 73"	12-5200	12-7618								
205071	5/8" x 74"	12-5201	12-7619								
205073	5/8" x 76"	12-5203	12-7621								
205074	5/8" x 77"	12-5204	12-7622								
205128	3/8" x 28"	12-5011	12-7433								
205129	3/8" x 29"	12-5012	12-7434								
205137	5/8" x 40"	12-5167	12-7585								
205141	1/2" x 41"	12-5074	12-7484								
205142	1/2" x 42"	12-5075	12-7485								
205144	1/2" x 44"	12-5077	12-7487								
205147	1/2" x 47"	12-5080	12-7490								
205154	1/2" x 54"	12-5087	12-7497								
205155	1/2" x 55"	12-5088	12-7498								
205307	1/2" x 37"	12-5070	12-7480								
205331	3/8" x 33"	12-5016	12-7438								
205425	1/2" x 25"	12-5058	12-7468								
205426	1/2" x 26"	12-5059	12-7469								
205428	1/2" x 28"	12-5061	12-7471								
205429	1/2" x 29"	12-5062	12-7472								
205448	1/2" x 48"	12-5081	12-7491								
205449	1/2" x 49"	12-5082	12-7492								
205469	1/2" x 69"	12-5102	12-7512								
*205505	1/2" x 80-1/8"	12-7894									
205508	1/2" x 28"	12-5061	12-7471								
205511	5/8" x 66"	12-5193	12-7611								
205515	5/8" x 69"	12-5196	12-7614								
205516	1/2" x 28"	12-5061	12-7471								
205517	5/8" x 89"	12-5216	12-7634								
205518	5/8" x 72"	12-5199	12-7617								
205519	1/2" x 27"	12-5060	12-7470								
205521	5/8" x 35"	12-5162	12-7580								
205523	1/2" x 31"	12-5064	12-7474								
208-029	1/2" x 29"	12-5062	12-7472								
208-038	1/2" x 38"	12-5071	12-7481								

* indicates original type belt

SPARK PLUG REFERENCE CHART



**2014
PLUG REF. CHART**

Order No.	Autolite No.	Order No.	Champion No.	Order No.	NGK No.	Order No.	ND No.	Order No.	Bosch No.
24-8964	3076		W14		---	---	---		---
24-8963	403		RN3C		BR6ES	---	---		---
24-7191	2974	24-8882	CJ6Y	24-7892	BPM7Y		Echo		WS5F
24-7191	2974	24-8883	RCJ6Y		BPMR7A		---		WRS5F
24-5859	258	24-2507	CJ-14	24-2523	BM4A		W14M-U		WS9E
---	---	---	---	24-5854	BMR4A		W14MR-U		---
---	---	---	---	24-2518	BPM4A		W14MP-U		---
24-2543	255	24-2504	CJ-8	24-1295	BM6A		W20M-U		WS8E
---	---	---	---	24-7893	BPM6Y		Echo		---
---	---	---	---	24-7892	BPM7Y		Echo		---
24-7223	245	---	RCJ-8C	24-2537	BMR6A		W20MR-U		WSR9E
24-2548	2976	24-7148	CJ-8Y	24-2501	BPM6A		W20MP-U		WS8F
24-7151	2985	24-7190	RCJ-8Y	---	BPMR6A		W20MPR-U10	24-14012	WSR7F
24-7152	254	24-2510	CJ-6C	24-2500	BM7A		W22M-U		WS5E
24-7191	2974	24-2513	CJ-7Y	24-2533	BPM7A		W22MP-U		WS5F
24-7228	2984	24-8883	RCJ-6Y	24-5850	BPMR7A		Stihl Plug	24-14011	WSR5F
24-7151	2985	---	RCJ-7Y	---	BPMR6A		Echo	24-14014	WSR8F
24-7224	306	---	J-11YC	---	B4		W-14		W9E
24-2544	456	24-2505	J-17LM	24-1294	B4LM		W14LM-U		W9EO
24-6595	458	24-5936	J-19LM	24-1294	B4LM		W14LM-U		W9EO
24-7225	308	24-6934	RJ-19LM	---	BR2LM		W9-U		WR9EC
24-7221	86	24-8054	RJ18YC	24-7021	XR5		T16PR-U		WR7F
24-7223	245	24-11309	RJ17LM	24-5854	BMR4A		W14MR-U		WSR9E
---	---	24-11307	RCJ-7Y	24-8358	BPMR4A		---		---
24-5860	295	24-2506	J-8C	24-2517	B6S		W20S		W8EC
---	308	24-8571	RJ12YC	---	BR6S		---		---
---	313	---	J-4, 5	---	B7S		W22S		W5EC
24-7226	353	---	J-4C	24-2524	B8S		W24S-U		---
---	417	---	L-14	24-5855	B4H		W14F-U		W9A
---	517	---	L92YC	24-5858	BP4HS		W14FP-L		---
24-7231	275	---	RL92YC	24-5852	BR4HS		W14FR-U		WR10AC
24-7019	26	24-8073	RV17YC	24-5857	UR4		T16PR-U		HR8B
24-7153	425	---	RL90C	---	B5HS		W16FS		W8AC
---	2655	24-7150	L86C	24-2536	B6HS		W20FS-U		W7AC
---	2655	24-7187	L82C	24-2536	B6HS		W20FS-U		W7AC
24-2550	4093	--	UL-81J	24-2516	B7HS		W22FS		W5A
24-7311	4265	24-7868	N-11YC	24-2534	BP5ES		W16EX-U		W9DC
24-2547	2956	24-2509	DJ-8J	24-1289	BM6F		WA20M-U		HS8E
24-2546	2954	24-2512	DJ-6J	24-2503	BM7F		WA22M-U		HS5E
24-6835	2554	24-8496	DJ-7Y	---	BPM6F		---		---
24-2542	216	24-6932	H-10	24-2526	B6L		W14L		---
24-7229	3924	24-7423	RC12YC	24-9872	BKR5E				
				33-11523	BKR6E				
24-12431	3926	---	RC12YC	---					
24-7229	3924	24-7423	RC12YC	---	BCPR5ES		Q16PR-U		FR8DC
24-9871	3924	---	RC144C	24-9871	FR5				
24-7222	106	24-6935	RS14YC	24-5851	TR5		T20EPR-U		H6DC
24-7220	64	24-7189	RN-11YC	24-2538	BPR5ES		W16EPR-U	24-14013	WR8DC
24-7311	4265	24-7868	N-11YC	24-2534	BP5ES		W16EX-U		W9DC
24-2545	4253	24-7149	N-9YC	24-2519	BP6ES		W20EP-U		W7DO
				24-9873	BPR4ES				
24-7230	4263	24-7188	RN-9YC	24-2539	BPR6ES		W20EX-U		WR6DC



SPARK PLUG REFERENCE CHART

**2014
PLUG REF. CHART**

Order No.	Autolite No.	Order No.	Champion No.	Order No.	NGK No.	Order No.	ND No.	Order No.	Bosch No.
24-7232	4063	---	RN-3C	24-2553	BR8ES		W24ESR-U		W3C
24-7310	4092	24-7186	L78C	24-2552	B8HS		W24FS-U		W4A1
24-2549	4053	---	N-2C	24-2541	B9ES		W27ES-U		W3CO
---	---	---	RN-2C	24-2554	BR9ES		---		---
24-7227	386	24-7185	D14	24-2535	A7		M22		M7AC
24-8964	3076	24-7422	D16	24-5856	A6		M17		M10ACO
				24-10427	CMR5H			24-14010	USR7AC
				24-11571	CM6				
				24-12376	CMR6A				
		24-10786	QC12YC						
		24-10788	QJ19LM						
24-6595	458 303	24-2507	846 & CJ14 RJ8C	24-10706	B2LM				
				24-10707	BR6S				
				24-10950	BPMR6F				
				24-13373	BPMR7Y				
				24-13362	BPMR8Y				
24-2550	4093		874, RL82C	24-10999	BR7HS				
				24-11078	ZGR5A				
				24-11304	B5HS				
				24-11305	B8ES				
				24-11306	BCPR5ES				
		24-11220	RC14YC						
		24-11308	RCJ8						

EDGER BLADES REFERENCE CHART



EDGER BLADES BY LENGTH

EDGER BLADE REF. 2014

Length	Center Hole	Outside Hole	Center to Center	Width	Steel Thickness	Order No.	Page No.
4-7/8"						16 - 1248	424
6-3/16"	1/2"			1-1/2"	.095"	16 - 6764	421
7"				1-1/2"	.095"	16 - 2662	421
7-1/2"				1-1/2"	.095"	16 - 6762	421
7-17/32"	7/16"			1-1/2"	.095"	16 - 6172	421
7-11/16"	1"			2"	.095"	16 - 2663	421
7-11/16"	1"			2"	.125"	16 - 6107	421
7-11/16"	1"			2"	.125"	16 - 6477	421
8"1"					.095"	16 - 6276	422
8-9/16"	1/2"			2"	.095"	16 - 2672	422
8-3/4"	1/2"			2-1/4"	.150"	16 - 1145	422
8-3/4"	1"			2"	.095"	16 - 6261	422
9"3/8"				2"	.117"	16 - 1137	422
9"1/2"				2"	.117"	16 - 1138	422
9"5/8"				2"	.117"	16 - 1139	423
9"				2"	.095"	16 - 1140	422
9"				1-1/2"	.117"	16 - 1141	422
9"1/2"						16 - 1147	424
9"				2"	.117"	16 - 1149	422
9"5/8"						16 - 2147	424
9"1/2"						16 - 2658	424
9"5/8"						16 - 2661	424
9"1/2"				2"	.095"	16 - 2671	422
9-1/4"	5/8"			2-1/2"	.095"	16 - 2148	423
9-13/16"				2-1/4"	.150"	16 - 1151	423
10"	1/2"			2"	.125"	16 - 1143	423
10"	5/8"			2"	.117"	16 - 1144	423
10"	1/2"			2"	.117"	16 - 1148	423
10"				2"	.125"	16 - 1150	423
10"	1/2"			2"	.125"	16 - 2670	423
10"	1/2"			2"	.150"	16 - 2673	423
12-1/16"	1/2"			2"	.125"	16 - 2668	423
12-1/8"	1/2"			2"	.125"	16 - 2669	423

UNIVERSAL BLADES REFERENCE CHART



UNIVERSAL BLADES BY LENGTH

Length	Center Hole	Outside Hole	Center to Center	Width	Steel Thickness	Order No.	Page No.
16"	1"			2-1/4"	.150"	14 - 16248	314
16"	3/8"			2-1/4"	.150"	14 - 2009	315
16"	1"			2-1/4"	.150"	14 - 6248	314
18"	3/8"			2-1/4"	.150"	14 - 2094	315
18"	3/8"			2-1/4"	.150"	14 - 6052	314
18"	1"			2-1/4"	.150"	14 - 951	315
18"	3/8"			2-1/4"	.150"	14 - 977	315
18"	3/8"			2-1/4"	.150"	14 - 988	316
19"	1"			2-1/4"	.150"	14 - 10952	315
19"	3/8"			2-1/4"	.150"	14 - 6053	314
19"	1"			2-1/4"	.150"	14 - 952	315
19"	3/8"			2-1/4"	.150"	14 - 978	315
20"	1"			2-1/4"	.150"	14 - 10953	315
20"	3/8"			2-1/4"	.150"	14 - 6044	314
20"	1"			2-1/4"	.150"	14 - 6245	314
20"	1"			2-1/4"	.150"	14 - 953	315
20"	3/8"			2-1/4"	.150"	14 - 979	315
20"	3/8"			2-1/4"	.150"	14 - 990	316
21"	1"			2-1/4"	.150"	14 - 10954	315
21"	3/8"			2-1/4"	.150"	14 - 6045	314
21"	1"			2-1/4"	.150"	14 - 6246	314
21"	1"			2-1/4"	.150"	14 - 954	315
21"	1"			2-1/4"	.150"	14 - 965	316
21"	3/8"			2-1/4"	.150"	14 - 980	315
21"	3/8"			2-1/4"	.150"	14 - 991	316
22"	1"			2-1/4"	.150"	14 - 10955	315
22"	3/8"			2-1/4"	.150"	14 - 6046	314
22"	1"			2-1/4"	.150"	14 - 6247	314

UNIV. BLADE REF. 2014



UNIVERSAL BLADES REFERENCE CHART

UNIVERSAL BLADES BY LENGTH

Length	Center Hole	Outside Hole	Center to Center	Width	Steel Thickness	Order No.	Page No.
22"	3/8"			2-1/2"	.150"	14 - 6322	314
22"	1"			2-1/4"	.150"	14 - 955	315
22"	3/8"			2-1/4"	.150"	14 - 981	315
22"	3/8"			2-1/4"	.150"	14 - 992	316

BLADES REFERENCE CHART



O.E.M. REPLACEMENT BLADES BY LENGTH

Length	Center Hole	Outside Hole	Center to Center	Width	Steel Thickness	Order No.	Page No.
3-7/16"	17/32"			1"	.125"	15 - 6278	358
3-17/32"	17/32"			1"	.125"	15 - 11643	335
3-17/32"	17/32"			1"	.125"	15 - 11645	335
3-17/32"	17/32"			1"	.125"	15 - 8720	335
4" 1/2"				1"	.125"	15 - 10968	335
4" 17/32"				1"	.125"	15 - 11644	335
4" 1/2"				1"	.125"	15 - 6324	335
4-1/4"	17/32"			1"	.117"	15 - 11647	347
4-1/4"	17/32"			1"	.117"	15 - 6279	347
4-11/16"	29/64"			1-1/4"	.095"	15 - 9173	369
5-1/2"	5/16"			2"		15 - 50150	405
6-3/8"	3/8"			1-1/2"	.095"	15 - 3408	381
6-7/16"	29/64"			1-1/4"	.095"	15 - 9172	369
6-39/64"	21/64"					15 - 14172	405
7" 1/2"				2-1/2"	.160"	15 - 6834	348
9-5/8"	3/8"			2"	.134"	15 - 6031	393
10-1/2"	5/8"			2-1/2"	.134"	15 - 6137	407
11"	3/4"			2-1/2"	.204"	15 - 6075	340
11-9/16"	1-3/8"	3/8"		2-1/2"	.150"	15 - 1116	399
11-7/8"	13/32"	21/64"		2"	.150"	15 - 6093	365
11-7/8"				2-1/2"	.187"	15 - 6466	365
12-1/4"				2"	.150"	15 - 50027	405
12-3/8"	1-1/2"	7/16"		3-3/4"	.117"	15 - 6128	381
12-11/16"	3/4"			1-9/16"	.095"	15 - 50247	405
13"	1-3/8"	3/8"		2-1/2"	.150"	15 - 1117	399
13-3/4"	5/8"			2-1/2"	.204"	15 - 11810	369
13-3/4"	5/8"			2-1/2"	.204"	15 - 11870	369
13-3/4"				2"	.150"	15 - 50111	365
13-7/8"	5/8"			2"	.204"	15 - 1065	360
13-7/8"	3/4"			2"	.187"	15 - 2000	407
14"		1/4"		2"	.187"	15 - 1108	407
14"	11/16"			2"	.187"	15 - 1126	372
14-1/16"	11/16"			2-1/2"	.204"	15 - 6193	372
14-1/8"	3/8"			2"	.160"	15 - 13333	365
14-1/8"					.160"	15 - 50293	365
14-3/8"	11/16"			2"	.187"	15 - 1100	345
14-7/16"	45/64"			2-1/2"	.187"	15 - 6312	321
14-1/2"	3/4"	13/32"		2"	.150"	15 - 2083	399
14-1/2"				2"	.150"	15 - 50007	405
14-1/2"				2"	.150"	15 - 50026	405
14-1/2"	5/8"			2-1/2"	.203"	15 - 6020	343
14-1/2"	11/16"			2-1/2"	.187"	15 - 6086	345
14-1/2"	11/16"			2-1/2"	.187"	15 - 6087	345
14-1/2"	3/4"			2-1/2"	.187"	15 - 6267	407
14-1/2"	11/16"			2-1/2"	.204"	15 - 6316	321
14-1/2"	3/4"			2"	.204"	15 - 851	407
14-9/16"	5/8"			2-3/4"	.187"	15 - 6131	363

BLADE REF. CHART 2014



BLADES REFERENCE CHART

O.E.M. REPLACEMENT BLADES BY LENGTH

Length	Center Hole	Outside Hole	Center to Center	Width	Steel Thickness	Order No.	Page No.
14-19/32"	1-1/8"	25/64"		2-1/2"	.134"	15 - 2030	358
14-5/8"				2-1/2"	.204"	15 - 12122	365
14-3/4"	13/32"	5/16"		3"	.150"	15 - 6019	381
14-13/16"		5/16"		3"	.125"	15 - 1022	385
14-13/16"		3/8"		2-1/2"	.150"	15 - 1030	340
14-13/16"		21/64"		3"	.125"	15 - 1038	385
14-7/8"	3/4"			2-1/2"	.204"	15 - 11476	340
14-7/8"	5/8"			2-1/4"	.187"	15 - 14540	328
14-7/8"	7/16"	1/2"		2"	.150"	15 - 3346	372
14-7/8"	5/8"			2-1/2"	.204"	15 - 7010	365
15"	3/4"			3"	.204"	15 - 11805	340
15"	5/8"			2-1/2"	.250"	15 - 12868	357
15"	1/2"			2"	.204"	15 - 3377	359
15"	1/2"			2"	.204"	15 - 3378	359
15"	13/32"	11/32"	3-9/32"	2"	.150"	15 - 50061	405
15"	1/2"			2-1/2"	.240"	15 - 6330	359
15"	1/2"			2-1/2"	.204"	15 - 6415	321
15-1/32"				2-1/4"	.150"	15 - 844	389
15-1/8"	3/4"			2-1/2"	.204"	15 - 6081	340
15-3/16"				2-1/4"	.150"	15 - 1122	389
15-3/16"	25/32"			2-3/4"	.125"	15 - 50123	379
15-1/4"	5/8"			2-1/2"	.204"	15 - 10420	348
15-1/4"	15/16"			2-1/2"	.204"	15 - 11243	348
15-1/4"	15/16"			2-1/2"	.204"	15 - 11269	348
15-1/4"	15/16"			2-1/2"	.204"	15 - 11500	348
15-1/4"	3/8"			2"	.160"	15 - 13334	365
15-1/4"	5/8"			2-1/2"	.204"	15 - 6820	348
15-5/16"	3/8"	5/16"		2"	.150"	15 - 1077	381
15-5/16"	3/4"	13/32"		2"	.150"	15 - 2081	399
15-5/16"	11/16"	11/32"		2"	.204"	15 - 3386	377
15-5/16"						15 - 50292	365
15-5/16"	3/8"	3/8"		2"	.204"	15 - 6066	338
15-5/16"	5/8"			2-1/2"	.204"	15 - 6821	348
15-5/16"	5/8"			2-1/2"	.204"	15 - 9884	321
15-3/8"	3/8"			2-1/4"	.187"	15 - 2162	329
15-3/8"				2-1/4"	.160"	15 - 6205	329
15-3/8"				2-1/4"	.187"	15 - 6263	329
15-1/2"	5/8"			2-1/2"	.187"	15 - 3393	407
15-1/2"	5/8"			2-1/2"	.187"	15 - 3441	407
15-1/2"	5/8"			2-1/2"	.187"	15 - 6326	408
15-1/2"				2-1/4"	.160"	15 - 6437	329
15-1/2"				2-1/4"	.160"	15 - 6495	329
15-1/2"	5/8"			2-1/2"	.187"	15 - 9885	321
15-9/16"	1-1/4"	7/16"		2-1/2"	.187"	15 - 3332	339
15-9/16"				2-1/4"	.187"	15 - 9170	329
15-9/16"				2-1/2"	.000"	15 - 9970	321
15-5/8"	5/8"			2-1/2"	.204"	15 - 10371	369
15-5/8"	5/8"			2-1/2"	.204"	15 - 10973	369

BLADES REFERENCE CHART



O.E.M. REPLACEMENT BLADES BY LENGTH

Length	Center Hole	Outside Hole	Center to Center	Width	Steel Thickness	Order No.	Page No.
15-11/16"	27/32"			2-1/4"	.134"	15 - 6161	389
15-11/16"	7/8"			2-1/4"	.134"	15 - 6408	389
15-3/4"	27/32"			2-1/4"	.134"	15 - 6113	389
15-3/4"	27/32"			2-1/2"	.150"	15 - 6491	321
15-3/4"	27/32"			2-1/4"	.187"	15 - 9896	389
16"	3/4"	5/16"	2-1/2"	2-1/2"	.204"	15 - 10636	341
16"	11/16"			2"	.187"	15 - 1127	372
16"	3/4"			2"	.187"	15 - 2001	408
16"	5/8"			2-1/2"	.204"	15 - 3373	338
16"	11/16"			2"	.187"	15 - 6496	321
16-5/64"	47/64"	23/64"		2-13/64"	.125"	15 - 50146	339
16-3/32"				2-1/2"	.204"	15 - 13481	400
16-1/8"	3/4"			2"	.203"	15 - 10095	399
16-1/8"	3/8"			1-15/16"	.134"	15 - 6021	393
16-9/64"	3/4"			2"	.203"	15 - 10093	399
16-3/16"	31/32"			2"	.150"	15 - 6489	366
16-1/4"	5/8"			2-1/2"	.150"	15 - 1009	336
16-1/4"	5/8"			2-1/2"	.204"	15 - 10172	318
16-1/4"		5/16"		3"	.125"	15 - 1021	385
16-1/4"		3/8"		2-1/2"	.000"	15 - 1029	385
16-1/4"		21/64"		3"		15 - 1037	385
16-1/4"	5/8"			2-1/2"	.204"	15 - 10419	349
16-1/4"	5/8"			2-1/2"	.204"	15 - 10718	348
16-1/4"	3/8"			2"	.150"	15 - 1093	393
16-1/4"	15/16"			2-1/2"	.204"	15 - 11231	349
16-1/4"	15/16"			2-1/2"	.204"	15 - 11240	349
16-1/4"	15/16"			2-1/2"	.204"	15 - 11279	349
16-1/4"	3/4"			2-1/2"	.204"	15 - 11478	341
16-1/4"	15/16"			2-1/2"	.204"	15 - 11493	349
16-1/4"	15/16"			2-1/2"	.204"	15 - 11494	349
16-1/4"	15/16"			3"	.204"	15 - 11769	350
16-1/4"	15/16"			3"	.204"	15 - 11770	350
16-1/4"	15/16"			3"	.204"	15 - 11771	350
16-1/4"	15/16"			3"	.204"	15 - 11772	322
16-1/4"	15/16"			3"	.204"	15 - 12002	350
16-1/4"				2-1/2"	.204"	15 - 12123	366
16-1/4"	5/8"	11/32"		2-1/2"	.240"	15 - 2172	334
16-1/4"	5/8"			2-1/2"	.204"	15 - 3400	336
16-1/4"	13/32"	5/16"		3"	.150"	15 - 6003	382
16-1/4"	5/8"			2-1/2"	.160"	15 - 6175	349
16-1/4"	5/8"			2-1/2"	.204"	15 - 6296	322
16-1/4"	5/8"			2-1/2"	.204"	15 - 6500	366
16-1/4"	5/8"			2-1/2"	.204"	15 - 9487	349
16-1/4"	5/8"			2"	.240"	15 - 9967	319
16-1/4"	5/8"			2-1/2"	.204"	15 - 9988	349
16-17/64"	13/32"		2-9/16"	2-13/64"	.160"	15 - 10199	381
16-1/2"	3/4"			3"	.000"	15 - 11564	341

BLADE REF. CHART 2014



BLADES REFERENCE CHART

O.E.M. REPLACEMENT BLADES BY LENGTH

Length	Center Hole	Outside Hole	Center to Center	Width	Steel Thickness	Order No.	Page No.
16-1/2"	9/16"			2-1/4"	.204"	15 - 12251	347
16-1/2"	3/8"			2"	.160"	15 - 13335	366
16-1/2"	5/8"			2-1/2"	.204"	15 - 13975	416
16-1/2"	57/64"			2-1/2"	.250"	15 - 14096	377
16-1/2"	3/8"			2-3/4"	.160"	15 - 2169	400
16-1/2"	5/8"			2-1/2"	.204"	15 - 3403	347
16-1/2"	1-3/32"			2-1/4"	.095"	15 - 50102	363
16-1/2"					.160"	15 - 50297	366
16-1/2"	5/8"			3"	.204"	15 - 6009	379
16-1/2"	5/8"			2-1/2"	.204"	15 - 6115	338
16-1/2"	5/8"			2-1/2"	.204"	15 - 6116	338
16-1/2"	5/8"			2-1/2"	.204"	15 - 6222	372
16-1/2"	3/4"	5/16"		2-1/2"	.204"	15 - 6240	341
16-1/2"	5/8"			2-1/2"	.204"	15 - 6300	322
16-1/2"	5/8"			2-1/2"	.204"	15 - 6472	400
16-1/2"	3/4"			2-1/4"	.187"	15 - 825	346
16-5/8"				2-1/2"	.204"	15 - 10377	329
16-5/8"				2-1/2"	.204"	15 - 12475	322
16-5/8"	3/4"			2-1/2"	.180"	15 - 3326	328
16-5/8"	11/16"	11/32"		2"	.204"	15 - 3387	377
16-5/8"	3/4"			2-1/2"	.204"	15 - 6060	328
16-5/8"	13/16"			2-1/2"	.204"	15 - 6206	373
16-5/8"	23/32"			2"	.204"	15 - 6208	377
16-5/8"	13/16"			2-1/2"	.204"	15 - 6223	373
16-5/8"	13/16"			2-1/2"	.204"	15 - 6314	322
16-5/8"	13/16"			2-1/2"	.204"	15 - 6420	322
16-11/16"	3/4"	13/32"		2"	.150"	15 - 2082	399
16-11/16"					.204"	15 - 50295	406
16-3/4"				2-1/2"	.204"	15 - 9907	330
16-13/16"	1/2"			2-1/2"	.204"	15 - 6185	400
16-27/32"				2"	.150"	15 - 50063	371
16-7/8"	21/32"			2-1/2"	.125"	15 - 6187	408
16-31/32"	1/2"			2-1/2"	.204"	15 - 6436	369
17"				2-1/2"	.240"	15 - 10284	373
17"				2-1/2"	.204"	15 - 10291	373
17"	3/4"			3"	.204"	15 - 10361	341
17"				2-1/2"	.150"	15 - 10634	373
17"	5/8"			2"	.204"	15 - 1066	345
17"	7"			2-3/4"	.160"	15 - 11595	373
17"	7"			2-3/4"	.160"	15 - 11596	373
17"				2-1/2"	.204"	15 - 12821	373
17"				2-1/2"	.160"	15 - 12920	373
17"	5/8"			2"	.204"	15 - 3372	343
17"	5/8"			2"	.240"	15 - 6013	319
17"	1/2"			2-1/2"	.204"	15 - 6035	401
17"	3/8"	3/8"		2"	.204"	15 - 6068	338

BLADES REFERENCE CHART



O.E.M. REPLACEMENT BLADES BY LENGTH

Length	Center Hole	Outside Hole	Center to Center	Width	Steel Thickness	Order No.	Page No.
17"	5/8"			2-1/2"	.187"	15 - 6088	345
17"	5/8"			2-1/2"	.240"	15 - 6181	360
17"	5/8"			2-1/2"	.240"	15 - 6204	361
17"	5/8"			2-1/2"	.240"	15 - 6214	360
17"	5/8"			2-1/2"	.204"	15 - 6224	343
17"	5/8"			2-1/2"	.204"	15 - 6298	322
17"	1/2"			2-1/2"	.204"	15 - 6426	322
17"	5/8"			3"	.240"	15 - 6442	343
17"	11/16"			2-1/2"	.187"	15 - 6766	345
17"	11/16"			2-1/2"	.187"	15 - 6782	345
17"	11/16"			2-1/2"	.204"	15 - 6785	322
17"	5/8"			2-1/2"	.240"	15 - 6790	343
17-3/16"	11/16"			2-1/2"	.204"	15 - 6012	373
17-3/16"	3/4"			2-1/2"	.204"	15 - 6082	341
17-1/4"	3/8"	5/16"		2-1/2"	.204"	15 - 3356	382
17-1/4"	3/8"	5/16"		2"	.150"	15 - 997	382
17-5/16"		21/64"		2-1/2"	.187"	15 - 1034	385
17-11/32"	5/8"			2-1/4"	.187"	15 - 13177	328
17-3/8"	3/8"			2-1/4"	.187"	15 - 6195	330
17-3/8"				2-1/4"	.160"	15 - 6196	330
17-3/8"				2-1/4"	.187"	15 - 6264	330
17-1/2"	15/16"			3"	.204"	15 - 11773	350
17-1/2"	15/16"			3"	.204"	15 - 11774	350
17-1/2"	15/16"			3"	.204"	15 - 11775	350
17-1/2"	15/16"			3"	.204"	15 - 11776	322
17-1/2"	15/16"			3"	.204"	15 - 12003	350
17-1/2"	5/8"			2-1/4"	.160"	15 - 12273	408
17-1/2"	5/8"			2-1/4"	.187"	15 - 12362	408
17-41/64"				2-1/4"	.150"	15 - 6470	389
17-11/16"	5/8"			2"	.240"	15 - 3381	361
17-11/16"	5/8"			2-1/2"	.240"	15 - 6203	361
17-3/4"				2-1/2"	.204"	15 - 13361	367
17-3/4"				2-1/2"	.204"	15 - 13367	367
17-53/64"	25/64"		2-23/64"	2-23/64"	.204"	15 - 10203	395
17-7/8"	5/8"			3"	.240"	15 - 10372	370
17-7/8"	5/8"			3"	.204"	15 - 10972	369
17-7/8"				5/8"		15 - 11556	370
17-7/8"				5/8"		15 - 11557	370
17-7/8"	5/8"			2-1/2"	.204"	15 - 13976	416
17-7/8"	1/2"				.204"	15 - 50287	367
17-57/64"				2-1/2"	.188"	15 - 12809	342
17-57/64"				2-1/2"	.156"	15 - 12909	342
17-29/32"	3/4"			2-1/2"	.204"	15 - 11250	342
17-29/32"	3/4"			2-1/2"	.150"	15 - 11479	341
17-29/32"				2-1/2"	.150"	15 - 11480	341
17-29/32"				2-1/2"	.187"	15 - 11506	341

BLADE REF. CHART 2014



BLADES REFERENCE CHART

O.E.M. REPLACEMENT BLADES BY LENGTH

Length	Center Hole	Outside Hole	Center to Center	Width	Steel Thickness	Order No.	Page No.
17-29/32"				2-1/2"	.187"	15 - 11507	341
17-29/32"	5/8"			2-1/2"	.204"	15 - 6291	350
17-15/16"	5/8"			2-1/2"	.160"	15 - 6178	350
18"	5/8"			2-1/2"	.204"	15 - 10071	351
18"	5/8"	1/4"		2-1/2"	.150"	15 - 1010	336
18"	3/8"	5/16"		2"	.150"	15 - 1014	382
18"	5/8"			2-1/2"	.204"	15 - 10173	318
18"	5/8"			2-1/2"	.204"	15 - 10719	351
18"	1/2"			2-1/2"	.240"	15 - 11033	359
18"	15/16"			2-1/2"	.204"	15 - 11241	351
18"	15/16"			2-1/2"	.204"	15 - 11267	351
18"	15/16"			2-1/2"	.204"	15 - 11450	351
18"	15/16"			2-1/2"		15 - 11451	352
18"	15/16"			2-1/2"	.204"	15 - 11495	351
18"				3"	.187"	15 - 12121	323
18"				2-1/2"	.204"	15 - 12124	367
18"	9/16"			2-1/4"	.204"	15 - 12375	347
18"	5/8"			2-1/2"	.204"	15 - 13016	323
18"	1/2"			2-1/2"	.240"	15 - 13463	359
18"				2-1/2"	.203"	15 - 14391	368
18"	5/8"			2-1/2"	.240"	15 - 2173	334
18"	1/2"			2-1/2"	.187"	15 - 3361	408
18"	5/8"			2-1/2"	.204"	15 - 3374	338
18"	1/2"			2"	.204"	15 - 3379	359
18"	1/2"			2"	.204"	15 - 3380	359
18"	5/8"			2"	.187"	15 - 3394	409
18"	5/8"			2-1/2"	.204"	15 - 3401	336
18"	5/8"			2-1/2"	.204"	15 - 3404	347
18"	1/2"			2-1/2"	.187"	15 - 3405	408
18"	5/8"			3"	.204"	15 - 3442	380
18"	5/8"			2-27/32"	.117"	15 - 50022	381
18"				3"	.095"	15 - 50034	346
18"				2-1/4"	.187"	15 - 50252	330
18"				2-1/4"	.187"	15 - 50253	330
18"						15 - 50289	367
18"	5/8"			2-1/2"	.204"	15 - 6014	338
18"				2-1/4"	.150"	15 - 6123	330
18"	5/8"			2-1/2"	.204"	15 - 6183	337
18"	1/2"			2-1/2"	.204"	15 - 6217	351
18"	5/8"			2-1/2"	.204"	15 - 6294	323
18"	1/2"			2-1/2"	.204"	15 - 6309	322
18"	1/2"			2-1/2"	.240"	15 - 6323	359
18"	1/2"			2-1/2"	.187"	15 - 6410	322
18"		5/16"		2-1/4"	.134"	15 - 6448	387
18"	5/8"			2-1/2"	.204"	15 - 9229	323
18"	5/8"			2"	.240"	15 - 9968	319

BLADES REFERENCE CHART



O.E.M. REPLACEMENT BLADES BY LENGTH

Length	Center Hole	Outside Hole	Center to Center	Width	Steel Thickness	Order No.	Page No.
18-3/64"	47/64"	23/64"		2-13/64"	.125"	15 - 50145	339
18-3/32"	45/64"		1-49/64"	2-13/64"	.160"	15 - 10198	381
18-1/8"	3/8"			2"	.134"	15 - 3447	393
18-1/8"				2"	.134"	15 - 50030	406
18-1/8"				3"	.095"	15 - 50122	414
18-1/8"					.204"	15 - 50296	406
18-1/8"				2-1/4"	.134"	15 - 6018	389
18-9/64"	3/4"			2"	.203"	15 - 10094	399
18-5/32"	3/8"			2"	.150"	15 - 1085	393
18-3/16"				2-1/4"	.150"	15 - 1124	389
18-3/16"			2-1/2"	2-1/4"	.117"	15 - 11310	339
18-3/16"			2-1/2"	2-1/4"	.117"	15 - 11311	339
18-3/16"				2-1/4"	.150"	15 - 50098	363
18-3/16"	13/32"	5/16"		3"	.150"	15 - 6143	382
18-1/4"	3/8"			2-1/4"	.187"	15 - 6120	330
18-3/8"				2-1/4"	.150"	15 - 10841	330
18-3/8"				3"	.187"	15 - 11180	331
18-3/8"			3-1/2"	2-1/4"	.160"	15 - 11314	377
18-3/8"				3"	.187"	15 - 13239	331
18-7/16"				3-3/8"	.150"	15 - 50101	363
18-7/16"	3/4"	13/32"		2-3/4"	.187"	15 - 6084	346
18-7/16"	27/32"	27/64"		2-1/4"	.204"	15 - 6787	363
18-1/2"	5/8"	11/32"		2-1/4"	.150"	15 - 1033	358
18-1/2"				3"	.204"	15 - 11719	342
18-1/2"	5/8"			2-1/2"	.204"	15 - 11856	370
18-1/2"				3"	.204"	15 - 12963	382
18-1/2"				2-1/2"	.204"	15 - 13482	401
18-1/2"	5/8"			2-1/2"	.204"	15 - 13623	370
18-1/2"				2-1/2"	.203"	15 - 14459	331
18-1/2"	3/4"	13/32"		2-1/2"	.187"	15 - 2078	399
18-1/2"	3/4"	13/32"		2"	.187"	15 - 2079	399
18-1/2"	3/4"	13/32"		2"	.187"	15 - 6069	338
18-1/2"	11/16"			2"	.187"	15 - 6101	346
18-1/2"	1-7/32"			2-1/4"	.150"	15 - 6104	327
18-1/2"	3/4"			3"	.204"	15 - 6239	342
18-5/8"				2-3/4"	.187"	15 - 11491	374
18-5/8"	23/32"			2-1/2"	.250"	15 - 14095	378
18-5/8"	57/64"			2-1/2"	.250"	15 - 14483	378
18-5/8"	57/64"			2-1/2"	.250"	15 - 14488	378
18-5/8"				2-1/2"	.134"	15 - 50031	367
18-5/8"				2-1/4"	.150"	15 - 50113	363
18-5/8"	3/8"			2-1/16"	.134"	15 - 6024	393
18-5/8"	13/16"			2-1/2"	.204"	15 - 6192	374
18-5/8"	13/16"			2-1/2"	.204"	15 - 6221	374
18-5/8"	13/16"			2-1/2"	.204"	15 - 6315	323
18-11/16"	1-1/8"			2-1/2"	.240"	15 - 6265	378

BLADE REF. CHART 2014



BLADES REFERENCE CHART

O.E.M. REPLACEMENT BLADES BY LENGTH

Length	Center Hole	Outside Hole	Center to Center	Width	Steel Thickness	Order No.	Page No.
18-11/16"				2-1/2"	.204"	15 - 6738	374
18-45/64"				2-1/2"	.134"	15 - 50060	346
18-3/4"	3/4"			2"	.204"	15 - 3468	409
18-49/64"	5/8"		2-9/16"	2-13/64"	.160"	15 - 10201	381
18-27/32"	47/64"	23/64"		2-13/64"	.160"	15 - 50144	340
18-15/16"				2"	.150"	15 - 6488	368
18-15/16"	5/8"	17/32"		3"	.134"	15 - 848	379
19"	7/8"			2-1/2"	.249"	15 - 10072	323
19"	7/16"			2-1/2"	.125"	15 - 1011	409
19"	3/8"	5/16"		2"	.150"	15 - 1015	382
19"				2-3/4"	.204"	15 - 10292	374
19"	3/4"			3"	.204"	15 - 10362	342
19"	9/16"			2-1/2"	.204"	15 - 11662	347
19"				2-1/4"	.125"	15 - 12893	342
19"				2-1/4"	.150"	15 - 13498	368
19"				2-1/4"	.150"	15 - 13500	368
19"	5/8"			2-1/2"	.240"	15 - 14076	368
19"	5/8"			2-1/2"	.240"	15 - 14077	368
19"	5/8"			2-1/2"	.240"	15 - 14078	368
19"			1-7/8"	2-1/2"	.240"	15 - 14475	374
19"	13/32"			2-1/4"	.134"	15 - 50254	389
19"	13/32"			3"	.150"	15 - 6126	382
19"				2-1/4"	.187"	15 - 6218	331
19"	1/2"			2-1/2"	.204"	15 - 6435	370
19"				2-1/2"	.000"	15 - 6480	374
19"	1-1/4"			2-1/4"	.125"	15 - 6760	358
19-1/8"					.240"	15 - 50294	368
19-1/4"				2-1/4"	.150"	15 - 12240	331
19-1/4"	3/8"			2-1/4"	.187"	15 - 6105	331
19-1/4"	5/8"			2-1/2"	.187"	15 - 6184	409
19-5/16"		5/16"		3"	.150"	15 - 1024	386
19-5/16"		5/16"		3"	.150"	15 - 1026	386
19-5/16"		5/16"		3"	.150"	15 - 11232	386
19-5/16"	5/8"			2-1/2"	.187"	15 - 3395	409
19-5/16"	13/32"	5/16"		3"	.150"	15 - 6006	382
19-5/16"				2-1/4"	.150"	15 - 6124	331
19-5/16"	3/4"			3"	.204"	15 - 6147	342
19-11/32"	3/8"			2-1/4"	.150"	15 - 3392	331
19-3/8"	3/4"			2-3/4"	.204"	15 - 11477	342
19-3/8"	27/32"			2-1/4"	.150"	15 - 6111	390
19-3/8"	13/32"			2-1/4"	.134"	15 - 6142	390
19-3/8"	3/4"	5/16"		3"	.204"	15 - 6238	342
19-7/16"	53/64"	27/64"		2-1/4"	.150"	15 - 3437	363
19-7/16"	53/64"	27/64"		2-3/4"	.160"	15 - 3438	363
19-7/16"	1"			2-1/4"	.204"	15 - 6197	401
19-1/2"						15 - 11555	390

BLADES REFERENCE CHART



O.E.M. REPLACEMENT BLADES BY LENGTH

Length	Center Hole	Outside Hole	Center to Center	Width	Steel Thickness	Order No.	Page No.
19-1/2"	15/16"			3"	.204"	15 - 11777	352
19-1/2"	15/16"			3"	.204"	15 - 11778	352
19-1/2"	15/16"			3"	.204"	15 - 11779	352
19-1/2"	15/16"			3"	.204"	15 - 11780	323
19-1/2"	15/16"			3"	.204"	15 - 12004	352
19-1/2"	15/16"			3"	.204"	15 - 12562	375
19-1/2"	11/16"			2-1/2"	.204"	15 - 6011	374
19-1/2"	27/32"			2-1/4"	.134"	15 - 6017	390
19-1/2"	27/32"			2-1/4"	.187"	15 - 6119	390
19-1/2"	27/32"			2-3/4"	.134"	15 - 6146	390
19-1/2"	5/8"			2-3/4"	.187"	15 - 6150	363
19-1/2"	5/8"			2-3/4"	.187"	15 - 6151	363
19-1/2"	11/16"			2-1/2"	.204"	15 - 6186	375
19-1/2"	11/16"			2-1/2"	.204"	15 - 6421	323
19-1/2"	11/16"			3"	.204"	15 - 6737	374
19-1/2"	11/16"			3"	.204"	15 - 845	375
19-5/8"	3/8"			2-1/8"	.134"	15 - 6025	393
19-5/8"	3/8"			2-1/4"	.134"	15 - 6190	331
19-11/16"	3/8"			2"	.134"	15 - 3406	393
19-7/8"	3/8"			1-3/4"	.150"	15 - 1074	356
19-15/16"	13/32"	13/32"		2-1/4"	.150"	15 - 2012	390
19-31/32"				3"	.095"	15 - 50121	414
20"	3/8"			2-3/4"	.150"	15 - 10066	390
20"	3/8"	5/16"		2"	.150"	15 - 1016	382
20"	5/8"			2-1/2"	.134"	15 - 1043	331
20"	7/16"	15/32"		2"	.187"	15 - 1058	372
20"	15/16"			2-1/2"	.204"	15 - 11469	354
20"	18"			2-3/16"	.150"	15 - 13215	340
20"	5/8"			2-1/2"	.240"	15 - 13419	344
20"	3/8"	5/16"		2"	.150"	15 - 3336	393
20"	5/8"	3/16"		2-3/4"	.160"	15 - 3423	413
20"	13/16"	3/8"		2"	.150"	15 - 6005	382
20"	5/8"			2-1/2"	.204"	15 - 6008	380
20"	5/8"	3/8"		2-1/2"	.134"	15 - 6037	331
20"	13/16"	3/8"		2-1/4"	.125"	15 - 6140	382
20"	5/8"	3/8"		2-1/4"	.134"	15 - 6235	332
20"	5/8"			2-1/2"	.240"	15 - 6270	409
20"		5/16"		2-1/4"	.125"	15 - 6438	387
20"		5/16"		2-1/4"	.125"	15 - 6439	387
20"	13/16"	3/8"		2-1/4"	.125"	15 - 6457	383
20-1/16"	13/32"	5/16"		3-5/16"	.095"	15 - 50246	406
20-1/8"	10"			2"	.160"	15 - 10739	406
20-1/8"					.117"	15 - 11317	396
20-5/32"	5/8"			2"	.204"	15 - 3421	415
20-3/16"	5/8"			2"	.204"	15 - 6467	415
20-13/64"	25/64"		2-23/64"	2-23/64"	.204"	15 - 10195	395

BLADE REF. CHART 2014



BLADES REFERENCE CHART

O.E.M. REPLACEMENT BLADES BY LENGTH

Length	Center Hole	Outside Hole	Center to Center	Width	Steel Thickness	Order No.	Page No.
20-1/4"					.095"	15 - 11316	396
20-1/4"	3/8"		2-1/2"	2-3/4"	.134"	15 - 6099	394
20-1/4"	7/16"			2-1/2"	.134"	15 - 6275	409
20-1/4"	5/8"			2"	.204"	15 - 6432	415
20-5/16"	3/4"			2-1/2"	.204"	15 - 6254	328
20-5/16"		13/32"		2-1/4"	.134"	15 - 6428	363
20-23/64"	27/64"	21/64"			2"	.150"	15 - 50201
20-23/64"	27/64"	21/64"		2"	.150"	15 - 50202	383
20-3/8"	3/8"	3/8"		2-1/2"	.187"	15 - 1076	398
20-3/8"	27/32"			2-1/4"	.134"	15 - 6034	390
20-3/8"	27/32"			2-1/4"	.150"	15 - 6112	390
20-3/8"	27/32"			2-1/4"	.187"	15 - 6129	391
20-3/8"	27/32"			2-3/4"	.134"	15 - 6145	390
20-3/8"				2-1/4"	.134"	15 - 6475	390
20-7/16"	11/16"			2"	.204"	15 - 3388	378
20-15/32"	15/16"			2-1/4"	.240"	15 - 3389	378
20-1/2"	5/8"			2-1/2"	.203"	15 - 10249	352
20-1/2"	3/4"			3"	.204"	15 - 10383	342
20-1/2"	5/8"			2-1/2"	.204"	15 - 10667	334
20-1/2"	5/8"			3"	.204"	15 - 11139	353
20-1/2"	15/16"			2-1/2"	.204"	15 - 11224	353
20-1/2"	15/16"			3"	.204"	15 - 11242	352
20-1/2"	15/16"			2-1/2"	.240"	15 - 11248	353
20-1/2"	15/16"			2-1/2"	.240"	15 - 11249	353
20-1/2"	15/16"			2-1/2"	.204"	15 - 11496	353
20-1/2"	1-1/8"			2-1/2"	.240"	15 - 11558	378
20-1/2"	5/8"			2-1/2"	.240"	15 - 13624	361
20-1/2"	5/8"			2-1/2"	.204"	15 - 13977	416
20-1/2"	57/64"			2-1/2"	.250"	15 - 14481	378
20-1/2"	23/32"			2-1/2"	.250"	15 - 14482	378
20-1/2"	25/32"			2"	.187"	15 - 2120	375
20-1/2"	1"			2-1/4"	.250"	15 - 2164	361
20-1/2"	13/32"			2-3/4"	.160"	15 - 3322	328
20-1/2"	5/8"			2"	.240"	15 - 3339	361
20-1/2"	23/32"	23/64"		2-13/64"	.160"	15 - 50142	340
20-1/2"	23/32"	23/64"		2-13/64"	.160"	15 - 50143	340
20-1/2"	5/8"			2-1/2"	.240"	15 - 6083	344
20-1/2"	5/8"			2-1/2"	.240"	15 - 6180	334
20-1/2"	1-1/8"			2-1/2"	.240"	15 - 6209	378
20-1/2"	5/8"			2-1/2"	.240"	15 - 6213	361
20-1/2"	1/2"			2-1/2"	.204"	15 - 6216	352
20-1/2"	1/2"			2-1/2"	.204"	15 - 6250	352
20-1/2"	29/32"			2-1/2"	.313"	15 - 6253	375
20-1/2"	5/8"			2-1/2"	.240"	15 - 6285	361
20-1/2"	5/8"			2-1/2"	.204"	15 - 6290	353
20-1/2"	5/8"			2-1/2"	.204"	15 - 6303	324

BLADES REFERENCE CHART



O.E.M. REPLACEMENT BLADES BY LENGTH

Length	Center Hole	Outside Hole	Center to Center	Width	Steel Thickness	Order No.	Page No.
20-1/2"	5/8"			3"	.240"	15 - 6441	344
20-1/2"				5-1/8"	.160"	15 - 6482	327
20-1/2"				5-1/8"	.160"	15 - 6483	327
20-1/2"	11/16"			2-1/2"	.240"	15 - 6784	346
20-1/2"	5/8"			2-1/4"	.204"	15 - 9171	409
20-1/2"	1/2"			2-1/2"	.204"	15 - 9465	324
20-9/16"	25/64"	9/32"		2-3/16"	.160"	15 - 50241	414
20-9/16"	25/64"	9/32"		2-3/16"	.160"	15 - 50245	414
20-5/8"			3-1/2"	2-1/4"	.160"	15 - 11312	371
20-5/8"				2-1/4"	.160"	15 - 12118	377
20-5/8"				2-1/4"	.150"	15 - 50106	363
20-5/8"	5/8"			2-1/4"	.182"	15 - 6230	396
20-43/64"	27/32"			2-1/4"	.160"	15 - 50160	364
20-11/16"	5/8"		2-9/16"	2-13/64"	.160"	15 - 10202	381
20-11/16"				2-1/2"	.150"	15 - 10376	377
20-11/16"	3/8"	3/8"		2-3/4"	.160"	15 - 2007	401
20-11/16"	3/8"	3/8"		2-3/4"	.160"	15 - 6110	402
20-11/16"	3/4"	9/16"		2-1/4"	.150"	15 - 6173	378
20-11/16"	3/8"			2-3/4"	.160"	15 - 6317	324
20-11/16"	5/8"			2-1/2"	.240"	15 - 6433	415
20-11/16"	5/8"			2-1/2"	.240"	15 - 6434	416
20-3/4"	5/8"			2-1/2"	.134"	15 - 1057	379
20-3/4"	15/16"			3"	.204"	15 - 11781	354
20-3/4"	15/16"			3"	.204"	15 - 11782	354
20-3/4"	15/16"			3"	.204"	15 - 11783	354
20-3/4"	15/16"			3"	.204"	15 - 11784	324
20-3/4"	15/16"			3"	.204"	15 - 12005	354
20-3/4"	1-3/4"			2-5/8"	.134"	15 - 14657	364
20-3/4"	3/8"	3/8"		2-3/4"	.160"	15 - 2006	402
20-3/4"	3/8"			2-1/4"	.150"	15 - 3348	375
20-3/4"	13/32"			2-1/4"	.134"	15 - 9228	391
20-13/16"	13/32"	13/32"		2-1/4"	.134"	15 - 3390	391
20-13/16"	13/32"			2-1/4"	.134"	15 - 6039	391
20-27/32"	7/16"		2-7/16"	2-1/4"	.015"	15 - 10928	352
20-7/8"	7/8"			2-3/4"	.187"	15 - 1087	402
20-7/8"	3/8"			2-1/4"	.150"	15 - 2051	327
20-7/8"	27/32"	13/32"		2-1/4"	.150"	15 - 2160	364
20-7/8"				3"	.125"	15 - 50125	335
20-7/8"	27/32"	13/32"		2-1/4"	.150"	15 - 6092	364
20-7/8"	13/32"			2-3/4"	.150"	15 - 6160	391
20-7/8"		13/32"		2-1/4"	.095"	15 - 6431	364
20-7/8"	27/32"			2-1/4"	.160"	15 - 6458	364
20-7/8"		5/16"		2-1/4"	.240"	15 - 824	417
20-7/8"	5/8"	17/32"		3"	.134"	15 - 849	379
20-29/32"	25/32"			4-1/8"	.095"	15 - 50153	364
20-15/16"	13/16"	3/8"		2"	.150"	15 - 6096	383
20-15/16"	7/16"	3/8"		2-9/16"	.134"	15 - 6256	410
21"	7/16"			2-5/8"	.125"	15 - 1006	410
21"				2-1/2"	.240"	15 - 10073	324

BLADE REF. CHART 2014



BLADES REFERENCE CHART

O.E.M. REPLACEMENT BLADES BY LENGTH

Length	Center Hole	Outside Hole	Center to Center	Width	Steel Thickness	Order No.	Page No.
21"	7/16"	3/8"		2-5/8"	.125"	15 - 1008	410
21"	1/2"			2-1/2"	.240"	15 - 10102	359
21"	7/16"			2-5/8"	.125"	15 - 1012	410
21"	3/8"	5/16"		2"	.150"	15 - 1017	383
21"	5/8"			2-1/2"	.204"	15 - 10174	318
21"	3/8"	3/8"		2-1/2"	.150"	15 - 1036	337
21"	3/4"			3"	.204"	15 - 10363	342
21"	5/8"			3"	.240"	15 - 10373	370
21"	3/8"			2-3/4"	.125"	15 - 10458	375
21"	3/4"			2-3/4"	.187"	15 - 1053	395
21"				2-1/2"	.150"	15 - 10635	375
21"	5/8"			2-1/2"	.204"	15 - 10720	368
21"	5"			3"	.204"	15 - 10930	398
21"	5/8"			3"	.204"	15 - 10971	370
21"	7"			2-3/4"	.160"	15 - 11594	376
21"	9/16"			2-1/2"	.020"	15 - 11663	347
21"				2-1/2"	.204"	15 - 12125	368
21"				2-3/4"	.204"	15 - 12380	376
21"	5/8"			2-1/4"	.150"	15 - 12732	332
21"	5/8"		7/16"	2-1/2"	.240"	15 - 13017	324
21"				2-1/4"	.150"	15 - 13260	354
21"	1/2"			2-1/2"	.240"	15 - 13464	360
21"				2-1/2"	.203"	15 - 14392	369
21"	5/8"			2-1/2"	.240"	15 - 2174	337
21"	5/8"			2-1/2"	.240"	15 - 3402	337
21"	1/2"			2"	.204"	15 - 3424	360
21"	5/8"			2-1/2"	.204"	15 - 3434	362
21"	13/16"	3/8"		2-1/2"	.150"	15 - 6042	383
21"		13/32"		2-3/4"	.134"	15 - 6122	375
21"				2-1/4"	.150"	15 - 6125	332
21"	27/32"	3/8"		2-1/4"	.125"	15 - 6139	383
21"	5/8"			2-1/2"	.204"	15 - 6141	339
21"	1/2"			2-1/2"	.240"	15 - 6167	359
21"	1/2"			2-1/2"	.240"	15 - 6168	360
21"	5/8"	7/32"		2-3/4"	.160"	15 - 6176	413
21"				2-1/4"	.150"	15 - 6189	332
21"				2-1/4"	.187"	15 - 6262	332
21"	5/8"			2-1/2"	.240"	15 - 6272	337
21"	13/16"	3/8"		2-1/4"	.134"	15 - 6277	402
21"	5/8"			2-1/2"	.204"	15 - 6299	324
21"	7/16"		2-7/16"	2-1/2"	.160"	15 - 6308	324
21"	1/2"			2-1/2"	.204"	15 - 6311	324
21"	1/2"			2-1/2"	.240"	15 - 6401	360
21"		5/16"		2-1/4"	.125"	15 - 6423	387
21"	17/64"	13/32"		2-5/8"	.095"	15 - 6430	364
21"		5/16"		2-1/4"	.134"	15 - 6450	387
21"				2-1/2"	.000"	15 - 6479	375
21"				5-5/8"	.150"	15 - 6484	332

BLADES REFERENCE CHART



O.E.M. REPLACEMENT BLADES BY LENGTH

Length	Center Hole	Outside Hole	Center to Center	Width	Steel Thickness	Order No.	Page No.
21"				5-5/8"	.150"	15 - 6485	332
21"	5/8"			2-1/2"	.204"	15 - 9230	324
21"	5/8"	3/8"		2-1/4"	.134"	15 - 9810	332
21"	5/8"			2"	.240"	15 - 9969	319
21"	5/8"			2-1/2"	.240"	15 - 9987	357
21-1/16"				2-1/4"	.150"	15 - 12563	332
21-1/16"	7/16"	3/8"		2-3/4"	.134"	15 - 6002	410
21-3/16"		5/16"		3"	.150"	15 - 1031	386
21-3/16"		5/16"		3"	.150"	15 - 1032	386
21-3/16"		5/16"	2-1/2"	3"	.150"	15 - 11233	386
21-3/16"				2-1/4"	.170"	15 - 12852	402
21-3/16"	13/32"	5/16"		3"	.150"	15 - 6028	383
21-3/16"	13/32"	7/16"		3"	.150"	15 - 6127	383
21-3/16"	3/4"	5/16"		3"	.204"	15 - 6237	343
21-3/16"	13/32"	5/16"		3"	.150"	15 - 6295	325
21-3/16"				2-1/4"	.134"	15 - 6476	391
21-1/4"	3/4"			2-3/4"	.204"	15 - 11475	343
21-1/4"				4-1/4"	.117"	15 - 12615	364
21-1/4"	3/8"	17/32"		2-1/2"	.204"	15 - 6078	343
21-1/4"	27/32"			2-3/4"	.134"	15 - 6144	391
21-1/4"	27/32"			2-1/4"	.150"	15 - 6162	391
21-1/4"	27/32"			2-1/4"	.150"	15 - 6166	391
21-1/4"	27/32"			2-1/2"	.150"	15 - 6460	325
21-1/4"	27/32"			2-1/4"	.187"	15 - 9897	391
21-3/8"	13/16"			2-1/2"	.203"	15 - 10074	376
21-3/8"	7"			2-3/4"	.155"	15 - 11593	376
21-3/8"	5/8"			2-1/2"	.250"	15 - 14442	344
21-3/8"	5/8"			2-1/2"	.250"	15 - 14467	344
21-27/64"	43/64"			2-1/2"	.156"	15 - 12919	376
21-15/32"	11/16"			2-1/2"	.160"	15 - 9959	376
21-1/2"	1/2"			2-1/2"	.204"	15 - 10209	318
21-1/2"	3/8"			2-1/4"	.150"	15 - 3366	327
21-1/2"	1/2"			2-1/2"	.187"	15 - 6251	411
21-1/2"	1"	7/16"		2-1/2"	.187"	15 - 6258	412
21-5/8"	3/8"		1-7/8"	2-1/4"	.135"	15 - 11868	392
21-5/8"	5/8"			2-1/4"	.160"	15 - 13129	323
21-5/8"	5/8"	3/8"		2-1/2"	.150"	15 - 6038	332
21-5/8"	3/8"			2"	.187"	15 - 6286	394
21-43/64"	5/8"			2-1/4"	.160"	15 - 11821	411
21-23/32"	25/64"		2-23/64"	2-13/64"	.160"	15 - 10204	395
21-23/32"	7/16"			2-1/4"	.150"	15 - 10929	411
21-23/32"	7/16"			2-1/4"	.150"	15 - 12649	323
21-3/4"	5/8"			2-1/2"	.150"	15 - 1044	333
21-3/4"	13/32"			3-15/16"	.134"	15 - 6138	394
21-3/4"				2-1/4"	.240"	15 - 6284	417
21-7/8"	13/32"			2-1/4"	.134"	15 - 6471	392

BLADE REF. CHART 2014



BLADES REFERENCE CHART

O.E.M. REPLACEMENT BLADES BY LENGTH

Length	Center Hole	Outside Hole	Center to Center	Width	Steel Thickness	Order No.	Page No.
21-15/16"	13/32"	13/32"		2-1/4"	.150"	15 - 2013	392
21-15/16"	5/8"	7/32"		2-3/4"	.160"	15 - 6177	413
22"	3/8"	5/16"		2"	.150"	15 - 1018	383
22"	13/32"	5/16"		2"	.187"	15 - 3407	384
22"	5/8"	3/16"		2-3/4"	.187"	15 - 3445	413
22"	5/8"	3/16"		2-3/4"	.187"	15 - 3446	413
22"	13/16"	3/8"		2"	.150"	15 - 6004	383
22"	13/32"			2-1/4"	.150"	15 - 6174	392
22"	13/16"	3/8"		2-1/4"	.125"	15 - 6212	384
22"	5/8"			2-1/4"	.204"	15 - 6228	396
22"	3/8"			2-1/2"	.187"	15 - 6229	396
22"	5/8"	3/8"		2-1/4"	.134"	15 - 6236	333
22"	5/8"	3/16"		2-3/4"	.187"	15 - 6414	325
22"		5/16"		2-1/4"	.125"	15 - 6424	387
22"		5/16"		2-1/4"	.125"	15 - 6425	388
22"				2-1/4"	.240"	15 - 9176	417
22-3/16"					.240"	15 - 50291	369
22-3/16"	3/4"			2-1/2"	.204"	15 - 6077	343
22-1/4"	3/4"			2"	.203"	15 - 10096	399
22-1/4"	15/16"			2-1/2"	.187"	15 - 14491	354
22-1/2"	5/8"			3"	.204"	15 - 11721	371
22-3/4"	15/16"			3"	.204"	15 - 11785	354
22-3/4"	15/16"			3"	.204"	15 - 11786	354
22-3/4"	15/16"			3"	.204"	15 - 11787	354
22-3/4"	15/16"			3"	.204"	15 - 11788	325
22-3/4"	15/16"			3"	.204"	15 - 12027	354
23"				2-3/4"	.150"	15 - 12242	333
23"				2-1/2"	.150"	15 - 12721	333
23"				2-1/4"	.187"	15 - 12974	333
23"	5/8"			2-1/2"	.187"	15 - 6135	411
23"	5/8"			2-1/2"	.187"	15 - 6136	411
23-1/4"				3"	.150"	15 - 12956	386
23-5/16"	5/8"			2-1/2"	.240"	15 - 12616	344
23-5/16"	5/8"			2-1/2"	.240"	15 - 13987	344
23-1/2"	5/8"			2-1/2"	.187"	15 - 6231	396
23-7/8"	1/2"			2-3/4"	.240"	15 - 6628	371
23-7/8"	1/2"			2-3/4"	.240"	15 - 6728	371
24"	5/8"			3"	.240"	15 - 10797	371
24"	5/8"			2-1/2"	.240"	15 - 6404	334
24"	5/8"			3"	.240"	15 - 6833	334
24-13/32"	5/8"			3"	.204"	15 - 6481	355
24-7/16"	1-1/8"			2-1/2"	.240"	15 - 12995	379
24-7/16"	23/32"				.160"	15 - 50162	340
24-7/16"	23/32"				.160"	15 - 50163	340
24-1/2"	5/8"			3"	.204"	15 - 10421	355
24-1/2"	15/16"			3"	.204"	15 - 11229	355
24-1/2"	15/16"			3"	.204"	15 - 11244	355
24-1/2"	15/16"			3"	.204"	15 - 11498	355
24-1/2"	15/16"			2-1/2"	.204"	15 - 11501	355

2014 BLADE REF. CHART

BLADES REFERENCE CHART



O.E.M. REPLACEMENT BLADES BY LENGTH

Length	Center Hole	Outside Hole	Center to Center	Width	Steel Thickness	Order No.	Page No.
24-1/2"	5/8"			2-1/2"	.204"	15 - 6026	334
24-1/2"	5/8"			2-1/2"	.240"	15 - 6171	362
24-1/2"	1"			2-1/2"	.204"	15 - 6210	416
24-1/2"	1"	7/16"		2-1/2"	.187"	15 - 6257	412
24-1/2"	1"	7/16"		2-1/2"	.187"	15 - 6259	412
24-1/2"	5/8"			3"	.204"	15 - 9882	355
24-1/2"	5/8"			2-1/2"	.204"	15 - 9883	325
24-9/16"	15/16"			2-1/2"	.240"	15 - 6207	379
24-3/4"	15/16"			3"	.204"	15 - 11789	355
24-3/4"	15/16"			3"	.204"	15 - 11790	355
24-3/4"	15/16"			3"	.204"	15 - 11791	355
24-3/4"	15/16"			3"	.204"	15 - 11792	325
24-3/4"	15/16"			3"	.204"	15 - 12028	355
24-3/4"	1/2"			2-1/2"	.295"	15 - 13593	371
24-3/4"	1/2"			2-1/2"	.204"	15 - 9986	411
24-15/16"	29/32"			2-1/2"	.313"	15 - 6252	376
24-15/16"	29/32"			2-1/2"	.313"	15 - 6255	376
25"	1-1/16"	35/64"		2-3/4"	.187"	15 - 1103	402
25"				3"	.250"	15 - 12643	376
25"	5/8"			2-1/2"	.240"	15 - 3329	337
25"	3/4"			2-1/2"	.240"	15 - 3362	411
25"	1/2"			2-1/2"	.240"	15 - 6402	360
25"	1/2"			2-1/2"	.240"	15 - 6403	360
25-1/16"	5/8"	7/32"		2-3/4"	.187"	15 - 6169	413
25-1/16"	5/8"	7/32"		2-3/4"	.187"	15 - 6170	413
25-3/16"	1/2"			2-1/2"	.240"	15 - 6271	412
25-7/32"	5/8"			2-1/2"	.187"	15 - 6001	412
25-11/16"	3/4"			2-3/4"	.187"	15 - 6232	396
26"	1-1/16"	35/64"		2-3/4"	.187"	15 - 1091	403
26"	1/2"			2-1/2"	.204"	15 - 6406	356
26"	1/2"			2-1/2"	.204"	15 - 6407	356
27-7/8"	7/16"	3/8"		2-3/4"	.187"	15 - 6445	328
28"	1-1/16"	35/64"		2-3/4"	.187"	15 - 1098	403
28"	1-1/16"			2-3/4"	.187"	15 - 11238	403
28"	3/4"	25/64"		2-3/4"	.180"	15 - 3323	328
28"	1-1/16"	35/64"		2-3/4"	.160"	15 - 6108	403
28"	1-1/16"			2-3/4"	.187"	15 - 6302	326
29-1/2"	11/16"			2-1/2"	.204"	15 - 6327	376
29-1/2"	11/16"			2-1/2"	.204"	15 - 6328	376
29-1/2"	11/16"			2-1/2"	.204"	15 - 6329	376
29-9/16"	5/8"	31/64"		2-3/4"	.187"	15 - 6153	365
29-5/8"				2-1/4"	.170"	15 - 12957	333
29-3/4"		31/64"		2-3/4"	.160"	15 - 2165	365
29-7/8"	1/2"			2-3/4"	.187"	15 - 6468	394
30"		21/64"		2-3/4"	.160"	15 - 1023	386
30"	7/8"			2-3/4"	.187"	15 - 1089	346
30"	1-1/16"	35/64"		2-3/4"	.187"	15 - 1092	403

BLADE REF. CHART 2014



BLADES REFERENCE CHART

O.E.M. REPLACEMENT BLADES BY LENGTH

Length	Center Hole	Outside Hole	Center to Center	Width	Steel Thickness	Order No.	Page No.
30"	3/4"	25/64"		2-3/4"	.187"	15 - 2137	328
30"				2-1/4"	.150"	15 - 2166	392
30"	3/8"	5/16"		3"	.150"	15 - 3354	384
30"	27/32"			2-3/4"	.160"	15 - 3430	392
30"	27/32"			2-1/4"	.187"	15 - 3443	392
30"				2-3/4"	.160"	15 - 6010	392
30"	27/32"			2-3/4"	.160"	15 - 6027	392
30"	1-1/16"	35/64"		2-3/4"	.187"	15 - 6029	403
30"	27/32"			2-3/4"	.150"	15 - 6215	392
30"	1-1/16"			2-3/4"	.187"	15 - 6297	326
31-3/8"	5/8"				.187"	15 - 2171	412
31-3/8"	5/8"			2-1/2"	.187"	15 - 6118	412
33"	1-1/16"	35/64"		2-3/4"	.187"	15 - 1060	403
33"	1-1/16"			2-3/4"	.187"	15 - 11239	403
33"	1-1/16"	35/64"		2-3/4"	.160"	15 - 6109	403
33"	1-1/16"			2-3/4"	.187"	15 - 6301	326
410"				2-1/4"	.187"	15 - 50062	371
430"						15 - 50290	366
630"				3"	.187"	15 - 50127	328

ENGINE HP TO MODEL NO. REFERENCE CHART



BRIGGS & STRATTON

TECUMSEH

ENGINE HP CHART 2014

Horse Power	Model No.	Bore Diameter	Horse Power	Model No.
2	60100	2.38"	1.75	SLV, VA, V17
3-2 cycle	62032	2.13"	2	AH520, H20, V20
3	80200/80300	2.38"	2.25	H22, LAV22, LCV22, LV22, V22
3 I/C	82200	2.38"	2.5	H25, LAV25, LCV25, LV25, V25
3 I/C	82300/82400	2.38"	2.75	AV520, V25
3.5 Max	90700/91700	2.56"	3	AH600, H30, LAV30, LCV30, LV30, V30, TVS75
3.5	92900	2.56"	3.25 C/I	AV600, TVS60, TVS600
3.5 Quantum	100700	2.56"	3.5	H35, LAV35, LCV35, LV35, V35, TVS90
3.5 Quantum	121700	2.69"	4	H40, HH40, HS40, LAV40, V40, VH40, TVS105, TVXL840
4-2 cycle	69700	2.36"	4.5	H45, V45
4 Max	110700	2.78"	5	H50, HH50, HS50, LAV50, V50, VH50, TVS120, TVM125
4	110900/113900	2.78"	5.5	H55, V55
4	112200	3.00"	6	H60, HH60, V60, VH60, TVM140
4 I/C Max	114700	2.78"	7	H70, HH70, HM70, V70, VA70, VH70, VM70, TVM170
4 I/C	114900	2.78"	7.75 C/I	TVS75
5 Van Guard	104700	2.56"	8	H80, HH80, HM80, V80, VH80, VM80, TVM195
5 Quantum	124700	2.69"	9 C/I	TVS90
5	130200/130900	2.56"	9.5 C/I	TVS90
5 I/C	131700/132200/132400	2.56"	10	HH100, HM100, VH100, VM100, TVM220
7	170400	3.00"	10.5 C/I	EVC105, TVS105, TVXL105
7	170700	3.00"	11 C/I	EVC120, TNT120
7 I/C	171400	3.00"	12	HH120, OH120, TVM125
8	190400/190700/191700	3.00"	13.5 C/I	TVM140
8 I/C	192700/193700/195400	3.00"	14	HH140, OH140
9 Van Guard	161400	3.00"	15	HH150
9 I/C	233400	3.00"	16	HH160, OH160
10 I/C	221400	3.44"	17.16 C/I	TVM170
10	222400	3.44"	18	OH180
10 I/C	243400	3.06"	19.41 C/I	TVM195
11	252400	3.44"	22.00 C/I	TVM220
11 I/C	253700/254400/255400	3.44"		
12 I/C	281700	3.44"		
14 Van Guard	261700	3.43"		
14 I/C	400400/400700	3.44"		
16 Van Guard	303400/303700	2.68"		
16 I/C	326430	3.56"		
16 I/C	402700/202400	3.44"		
18 I/C	422400/422700	3.44"		

KOHLER

Horse Power	Model No.	Horse Power	Model No.
4	K90, K91	16	K341, M16
5	K121, C5	17	KT17
6	K141	18	K361, M18
7	K160, K161	19	KT19
8	K181, M8	20	K532, M20
10	K241, M10	21	KT21
12	K301, M12	23	K582
12.5	CV 12.5	24	K660
14	K321, M14		



ENGINE HP TO MODEL NO. REFERENCE CHART

BRIGGS & STRATTON

2014 ENGINE HP CHART

1 0	4	7	2	8
1 or 2 Digits Indicate Pistion Displacement	3rd Digit Indicates Basic Design Series	4th Digit Indicates Crankshaft Position Carburetor Type Governor Type	5th Digit Indicates Type Of Bearing Reduction Gears and Auxiliary Drives	6th Digit Indicates Type Of Stater
6	0	0-Not Used	0-Plain Bearing	0-None
8	1	1-Horizontal Vacu-Jet	1-Flange Mount Plain Bearing	1-Rope
9	2	2-Horizontal Pulsa-Jet	2-Ball Bearing	2-Rewind
10	3	3-Horizontal Flo-Jet	3-Flange Mount Ball Bearing	3-110 Volt Elec
13	4	4-Horizontal Flo-Jet Mech.Gov.	4-Not Used	4-12 Volt Starter Generator
14	5	5-Vertical Vac-Jet	5-6-1 Gear Red.	5-12 Volt Starter
17	6	6-Not Used	6-6-1 Gear Red.	6-Alternator (1)
19	7	7-Vertical Flo-Jet	7-Not Used	7-12 Volt Starter & Alt.
20	8	8-Not Used	8-Aux. Drive Prep. to Crank	8-Vertical Pull Rewind
23	9	9-Vertical Pulsa-Jet	9-Aux. Drive Par to Crank	
24				
30				
32				
40				
42				

TECUMSEH

9	0 6	7	1 2	B
1st Digit Indicates Crankshaft Position	2nd & 3rd Digits Indicate Horse Power or 2 Cycle	4th Digit Indicates Primary Features	5th & 6th Digits Indicate Engine Variation Number	7th Digit Indicates Revision Letter
8-Vertical	00= 2 Cycle	1-Rotary Mower	00 thru 99	
9-Horizontal	02= 3 hp	2-Industrial	00 thru 99	
	03= 3.5 hp	3-Snow King	00 thru 99	
	04= 4 hp	4-Mini Bike	00 thru 99	
	05= 5 hp	5-Tractor	00 thru 99	
	06= 6 hp	6-Tiller	00 thru 99	
	07= 7 hp	7-Rider	00 thru 99	
	08= 8 hp			
	10=10 hp			
	12=12 hp			
	14=14 hp			
	16=16 hp			
	18=18 hp			

SEARS

The items below are a list of model number prefixes which identify the manufactures of Sears equipment.

103=Sarlo Power Mower	234=Beard-Poulon &/Lazy Boy	445=Melmer	663=Air Cap -- MTD
113=Emerson Electric & Shredder & Bagger	247=MTD	473=Quincy Compressor	733=Fairbanks Morse
114=Pioneer Gen-e-motor	250=J/I/ Case	498=Didier Mfg. Co.	739=Onan
128=EJ Rugg	257=Allegretti & Co. &/Paramount	500=Briggs & Stratton	745=O&R Engines
129=Mono Mfg. Co.	271=Kioritz Corp. - Echo	502=Murray	757=Brinly - Hardy Co.
131=Sears Only (Roper)	291=American Lawnmower	517=Homelite	769=Mercury Clutch Division
133=Sears Only (AYP)	328=McLane	521=E Z rake Co.	778=Comet Industries
136=Toro Mfg. Co.	355=Roper Outdoor	536=AMF-Wester International	785=Gen. Power-Magna-MTD
143=Techumseh/Lauson Power Prod.	358=Poulan	538=AMF and / or Murray	798=Speed King
147=Village Blacksmith/Div. McGraw Edison	359=Bolens Products	549=Midwest Ind.	809=AMF
160=Wisconsin Magneto	372=Zues Generator Co.	580=Generac	809=AMF
180=Lambert Corp.	378=Omark (Oregon)	582=Clinton Engine Co.	842=Haben MFG.
202=Gennon Mfg. Co.	380=Moto-Mower, Inc.	610=Ohio Steel Fabrication	854=White Farm Equip. (MTD)
219=MTD	390=King-O-Lawn	619=ARPS Corp.	900=Black and Decker
	410=John Bean Food Mac. & Chem.	636=Echo	917=Roper-AYP
	426=Parker Sweeper	639=King-O-Lawn	922=Original Tractor Cab Co.
		654=Mott	937=Sunbeam (Now Air Cap)

Example: Model #809-123456 The prefix (809) indicates that AMF manufactured this unit.

QUICK REFERENCE CHART FOR B&S



2014 B&S CHART

Engine Model Number	Air Filter		Muffler Assy.	Gaskets							Carburetion				
	Air Cleaner	Cartridge Pre-Cleaner	Muffler	Air Cleaner	Carb. to Cylinder Gasket	Carb. to Tank Gasket	Head Gasket	Base Gasket	Gasket Set	Valve Cover Gasket	Diaphragm	Float Valve	Needle Valve	Needle & Seat Kit	Carb. Overhaul Kit
60100	19-1370	19-1396 19-2788 19-1369	18-1270 18-1267	23-1492	23-1498 Note V	23-1493	23-1479	23-1401 23-3649 Note X	23-1469	23-2733	---	---	22-2888	22-1423	22-1407
80100	19-1370	---	18-1270 18-1267	23-1492	23-1498 Note V	23-1493	23-1479	23-1401 23-3649 Note X	23-1469	23-2733	---	---	22-2888	22-1423	22-1407
80200 Note A	19-1370	19-1396 19-2788 19-1369	18-1270 18-1267	23-1492	23-1498 Note V	23-1494	23-1479	23-1401 23-3649 Note X	23-1469	23-2733	22-1425	---	22-2888	22-1424	---
80200 Note B	---	19-2838	18-1267		---	---	23-1479	23-1401 23-3649 Note X	23-1469	23-2733	22-1425	---	---	---	---
80300	19-1370	19-1396 19-2788 19-1369	18-1270 18-1267	23-1492	23-1498 Note W	---	23-1479	23-1401 23-3649 Note X	23-1469	23-2733	---	22-1431	---	---	22-1415
80400	19-1370	19-1396 19-2788 19-1369	18-1267	23-1492	23-1498 Note W	---	23-1479	23-1401 23-3649 Note X	23-1469	23-2733	---	22-1431	---	---	22-1415
81200	19-1370	19-1396 19-2788 19-1369	18-1270 18-1267	23-1492	23-1498 Note V	23-1494	23-1479	23-1401 23-3649 Note X	23-1469	23-2733	22-1425	---	22-2888	22-1424	---
81300	19-1370	19-1396 19-2788 19-1369	18-1270 18-1267	23-1492	23-1498 Note W	---	23-1479	23-1401 23-3649 Note X	23-1469	23-2733	---	22-1431	---	---	22-1415
81400	19-1370	19-1396 19-2788 19-1369	18-1270 18-1267	23-1492	23-1498 Note W	---	23-1479	23-1401 23-3649 Note X	23-1469	23-2733	---	22-1431	---	---	22-1415
82200 Note C	---	19-2788 19-1369	18-1267		23-1498 Note V	23-1494	23-1479	23-1401 23-3649 Note X	23-1469	23-2733	22-1425	---	22-2888	22-1424	---
82200 Note D	---	19-2838	18-1267		---	---	23-1479	23-1401 23-3649 Note X	23-1469	23-2733	22-1425	---	---	---	---
82300	---	19-2788 19-1369	18-1267	23-3673	23-1498	---	23-1479	23-1401 23-3649 Note X	23-1469	23-2733	---	22-1431	---	---	22-1415
82400	---	19-2788 19-1369	---	23-3673	23-1498	---	23-1479	23-1401 23-3649 Note X	23-1469	23-2733	---	22-1431	---	---	22-1415
82500	19-1372												22-2888	22-1424	22-1414
82900	19-1372												22-2888	22-1424	22-1414
83400	---	19-2838	---		---	---	23-1479	23-1401 23-3649 Note X	23-1469	23-2733	---	---	---	---	---
90700	---	19-2789	18-2292 18-862		23-3672	---	23-1482	23-1401 23-3649 Note X	23-1471	23-2734	---	---	---	---	22-1415
91700	---	19-2789	18-862		23-3672	---	23-1482	23-1401 23-3649 Note X	23-1471	23-2734	---	---	---	---	---
92500 Note E	19-1371 19-6524	19-2788 19-1369	18-2292 18-862	23-3673	23-3672	---	23-1482	23-1401 23-3649 Note X	23-1471	23-2734	22-1429	---	---	22-1424 22-2891	22-1414



QUICK REFERENCE CHART FOR B&S

Ignition					Rod Assy.	Valves	Oil Seals	Piston Assy. & Rings		Rewind Starter					Engine Model Number
Breaker Assy.	Coil	Con-denser	Fly Wheel key	Ignition Kit	Rod	Exhaust Intake	Mag. PTO	Piston & Pin Assy.	Std. Chrome	Rope	Pulley	HandleGrip	Spring	StarterC lutch Assy.	Engine Model Number
31-1772	31-1780 Note Y	---	23-1435	31-1772	---	23-1510 23-1511	23-1442	23-2720	23-1453 23-1533	25-1301 Note Z	26-875	25-1330	26-1326	26-1324	60100
31-1772	31-1780 Note Y	---	23-1435	---	23-1525	23-1510 23-1511	23-1442	23-2720	23-1453 23-1533	25-1301 Note Z	26-875	25-1330	26-1326	26-1324	80100
31-1772	31-1780 Note Y	---	23-1435	---	23-1525	23-1510 23-1511	23-1442	23-2720	23-1453 23-1533	25-1301 Note Z	26-875	25-1330	26-1326	26-1324	80200 Note A
---	---	---	23-1435	---	23-1525	23-1510 23-1511	23-1442	23-2720	23-1453 23-1533	25-1301 Note Z	26-875	25-1330	26-1326	26-1324	80200 Note B
31-1772	31-1780 Note Y	---	23-1435	---	23-1525	23-1510 23-1511	23-1442	23-2720	23-1453 23-1533	25-1301 Note Z	26-875	25-1330	26-1326	26-1324	80300
31-1772	31-1780 Note Y	---	23-1435	---	23-1525	23-1510 23-1511	23-1442	23-2720	23-1453 23-1533	25-1301 Note Z	26-875	25-1330	26-1326	26-1324	80400
31-1772	31-1780 Note Y	---	23-1435	---	23-1525	23-1511	23-1442	---	23-1533	25-1301 Note Z	26-875	25-1330	26-1326	26-1324	81200
31-1772	31-1780 Note Y	---	23-1435	---	23-1525	23-1511	23-1442	---	23-1533	25-1301 Note Z	26-875	25-1330	26-1326	26-1324	81300
31-1772	31-1780 Note Y	---	23-1435	---	23-1525	23-1511	23-1442	---	23-1533	25-1301 Note Z	26-875	25-1330	26-1326	26-1324	81400
---	---	---	23-1435	---	23-1525	23-1511	23-1442	---	23-1533	25-1301 Note Z	26-875	25-1330	26-1326	26-1324	82200 Note C
---	---	---	23-1435	---	23-1525	23-1511	23-1442	---	23-1533	25-1301 Note Z	26-875	25-1330	26-1326	26-1324	82200 Note D
---	---	---	23-1435	---	23-1525	23-1511	23-1442	---	23-1533	25-1301 Note Z	26-875	25-1330	26-1326	26-1324	82300
---	---	---	23-1435	---	23-1525	23-1511	23-1442	---	23-1533	25-1301 Note Z	26-875	25-1330	26-1326	26-1324	82400
31-1772	31-1780 Note Y	---	---	---	---	23-1511	23-1442 23-1441	---	23-1461 23-1531	---	---	---	26-1326	---	82500
31-1772	31-1780 Note Y	---	---	---	---	23-1511	23-1442 23-1441	---	23-1461 23-1531	---	---	---	26-1326	---	82900
---	---	---	23-1435	---	23-1525	23-1510 23-1511	23-1442 23-1442	23-2720	23-1453 23-1533	25-1301 Note Z	26-875	25-1330	26-1326	26-1324	83400
---	---	---	23-1435	---	23-1529	23-1510 23-1511	23-1442 23-1441	23-2721	23-1461 23-1531	25-1301 Note Z	26-875	25-1330	26-1326	26-1324	90700
---	---	---	23-1435	---	23-1529	23-1510 23-1511	23-1442 23-1441	23-2721	23-1461 23-1531	25-1301 Note Z	26-875	25-1330	26-1326	26-1324	91700
31-1772	31-1780 Note Y	---	23-1435	---	23-1529	23-1510 23-1511	23-1442 23-1441	23-2721	23-1461 23-1531	25-1301 Note Z	26-875	25-1330	26-1326	26-1324	92500 Note E

2014 B&S CHART

QUICK REFERENCE CHART FOR B&S



Engine Model Number	Air Filter		Muffler Assy.	Gaskets							Carburetion				
	Air Cleaner	Cartridge Pre-Cleaner		Air Cleaner	Carb. to Cylinder Gasket	Carb. to Tank Gasket	Head Gasket	Base Gasket	Gasket Set	Valve Cover Gasket	Diaphragm	Float Valve	Needle Valve	Needle & Seat Kit	Carb. Overhaul Kit
92900 Note F	19-1371 19-6524	19-1396	18-2292 18-2295 18-862	23-3673	23-3672	---	23-1482	23-1401 23-3649 Note X	23-1471	23-2734	22-1428	---	---	22-1424 22-2891	22-1414
93500	19-1371	19-1396 19-1369	18-2292 18-2295 18-862	23-3673	23-3672	---	23-1482	23-1401 23-3649 Note X	23-1471	23-2734	22-1429	---	---	22-2891	---
93900	19-6524	---	18-2292 18-862	23-3673	23-3672	---	23-1482	23-1401 23-3649 Note X	23-1471	23-2734	22-1428	---	---	22-2891	---
94500	19-1371	---	18-862	23-3673	23-3672	---	23-1482	23-1401 23-3649 Note X	23-1471	23-2734	22-1429	---	---	22-2891	---
94900	19-1371	---	18-862	23-3673	23-3672	---	23-1482	23-1401 23-3649 Note X	23-1471	23-2734	22-1428	---	---	22-1429 22-2891	---
95500	19-1371	---	18-862	23-3673	23-3672	---	23-1482	23-1401 23-3649 Note X	23-1471	23-2734	22-1429	---	---	22-2891	---
95700 2 cycle	---	19-2789	---	---	---	---	---	---	---	---	---	---	---	---	---
95900	---	---	18-2292 18-862	23-3673	23-3672	---	23-1482	23-1401 23-3649 Note X	23-1471	23-2734	---	---	---	---	---
96500	---	---	18-2292 18-862	23-3673	23-3672	---	23-1482	23-1401 23-3649 Note X	23-1471	23-2734	22-1429	---	---	22-2891	---
96700 2 cycle	---	19-2789	---	---	---	---	---	---	---	---	---	---	---	---	---
96900	---	---	18-2292 18-862	23-3673	23-3672	---	23-1482	23-1401 23-3649 Note X	23-1471	23-2734	---	---	---	---	---
99700	---	---	---	---	---	---	---	---	---	---	---	---	---	---	---
100200	19-1376	---	---	---	---	---	23-1480	23-1402	23-1405	---	22-1425	---	---	---	---
100700	19-2841	19-2841	---	---	---	---	---	---	---	---	---	---	---	---	---
100900	19-1376	---	---	---	---	---	23-1480	23-1403	23-1470	---	22-1425	---	---	22-1424	---
104700	---	19-6602	---	---	---	---	---	---	---	---	---	---	---	---	---
110700	---	19-2789	18-2292 18-862	---	---	---	23-2732	---	23-2747	---	---	---	---	---	---
110900	19-1398	19-1396 19-2788 19-1369	18-1268 18-862	23-3673	23-7421	---	23-2732	23-1401 23-3649 Note X	23-2747	23-2734	22-1428	---	22-2888	22-1424 22-2891	22-7969
111200	19-1370	---	---	---	23-7964 Note V	23-1494	23-2732	23-1401	---	---	22-1425	---	22-2888	22-1424	---

2014

B&S CHART



QUICK REFERENCE CHART FOR B&S

Ignition					Rod Assy.	Valves	Oil Seals	Piston Assy. & Rings		Rewind Starter					Engine Model Number
Breaker Assy.	Coil	Con-denser	Fly Wheel key	Ignition Kit	Rod	Exhaust Intake	Mag. PTO	Piston & Pin Assy.	Std. Chrome	Rope	Pulley	HandleGrip	Spring	StarterC lutch Assy.	
31-1772	31-1780 Note Y	---	23-1435	---	23-1529	23-1510 23-1511	23-1442 23-1441	23-2721	23-1461 23-1531	25-1301 Note Z	26-875	25-1330	26-1326	26-1324	92900 Note F
31-1772	31-1780 Note Y	---	23-1435	---	23-1529	23-1510 23-1511	23-1442 23-1441	23-2721	23-1461 23-1531	25-1301 Note Z	26-875	25-1330	26-1326	26-1324	93500
---	31-1780	---	23-1435	---	23-1529	23-1510 23-1511	23-1442 23-1442	23-2721	23-1461 23-1531	25-1301 Note Z	26-875	25-1330	26-1326	26-1324	93900
31-1772	31-1780 Note Y	---	23-1435	---	23-1529	23-1510 23-1511	23-1442 23-1442	23-2721	23-1461 23-1531	25-1301 Note Z	26-875	25-1330	26-1326	26-1324	94500
31-1772	31-1780	---	23-1435	---	23-1529	23-1510 23-1511	23-1442 23-1441	23-2721	23-1461 23-1531	25-1301 Note Z	26-875	25-1330	26-1326	26-1324	94900
31-1772	31-1780	---	23-1435	---	23-1529	23-1510 23-1511	23-1442 23-1441	23-2721	23-1461 23-1531	25-1301 Note Z	26-852	25-2234	26-1327	---	95500
---	---	---	---	---	---	---	---	---	---	25-1301 Note Z	---	25-1315	---	---	95700 2 cycle
---	---	---	23-1435	---	23-1529	23-1510 23-1511	23-1442 23-1441	23-2721	23-1461 23-1531	25-1301 Note Z	26-875	25-1330	26-1326	26-1324	95900
---	---	---	23-1435	---	23-1529	23-1510 23-1511	23-1442 23-1441	23-2721	23-1461 23-1531	25-1301 Note Z	26-875	25-1330	26-1326	26-1324	96500
---	---	---	---	---	---	---	---	---	---	25-1301 Note Z	---	25-1315	---	---	96700 2 cycle
---	---	---	23-1435	---	23-1529	23-1510 23-1511	23-1442 23-1441	23-2721	23-1461 23-1531	25-1301 Note Z	26-875	25-1330	26-1326	26-1324	96900
---	---	---	23-1435	---	---	---	23-1442 23-1441	---	---	25-1301 Note Z	---	25-1330	---	---	99700
31-1772	---	---	---	---	23-2771	23-1508 23-1509	23-1442 23-1448	---	23-1452	25-1301 Note Z	---	---	---	---	100200
---	---	---	23-1435	---	23-6757	---	23-1442 23-1441	---	---	25-1301 Note Z	26-6673	25-1330	26-5876	---	100700
31-1772	---	---	---	---	23-2771	23-1508 23-1509	23-1442 23-1446	---	23-1452	25-1301 Note Z	---	---	---	---	100900
---	---	---	23-1435	---	---	---	---	---	---	25-1301 Note Z	---	25-1330	---	---	104700
---	---	---	23-1435	---	23-6757	23-2815 23-2816	23-1442 23-1441	23-6719	23-2477	25-1301 Note Z	26-875	25-1330	26-1326	26-1324	110700
31-1772	31-1780 (Y) 31-7287 (BB)	31-1772	23-1435	---	23-6757	23-2815 23-2816	23-1442 23-1441	23-6719	23-2477 1	25-1301 Note Z	26-875 Note CC	25-1330 Note DD	26-1326	26-1324	110900
31-1772	---	---	---	---	23-6757	23-2815 23-2816	---	---	23-2477	---	---	---	---	---	111200

2014

B&S CHART

QUICK REFERENCE CHART FOR B&S



Engine Model Number	Air Filter		Muffler Assy.	Gaskets							Carburetion				
	Air Cleaner	Cartridge Pre-Cleaner		Air Cleaner	Carb. to Cylinder Gasket	Carb. to Tank Gasket	Head Gasket	Base Gasket	Gasket Set	Valve Cover Gasket	Diaphragm	Float Valve	Needle Valve	Needle & Seat Kit	Carb. Overhaul Kit
111700	---	19-2788 19-1369	18-1268 18-862	---	---	23-1494	23-2732	23-1401 23-3649 Note X	23-2747	23-2734	---	---	---	22-1424	---
111900	19-1398	---	---	---	---	23-1494	23-2732	23-1401	23-2747	---	22-1428	---	22-2888	---	---
112200 Note G	19-1370	19-1396 19-2788 19-1369	18-1268 18-862	23-3673 23-7945 Note AA	23-7964 Note V	23-1494	23-2732	23-1401 23-3649 Note X	---	23-2734	22-1425	---	22-2888	22-1424	---
112200 Note H	---	19-2838	18-1267	---	---	23-1494	23-2732	23-1401 23-3649 Note X	---	23-2734	22-1425	---	---	---	---
112700	---	19-2789	---	---	23-7421	---	23-2732	23-1401 23-3649 Note X	23-2747	23-2734	---	---	---	---	---
112900	19-1398	19-2788 19-1369	---	---	23-7421	---	23-2732	23-1401 23-3649 Note X	23-2747	23-2734	22-1428	---	---	22-2891	---
113900 Note I	19-1398	---	18-862	---	23-7421	---	23-2732	23-1401 23-3649 Note X	23-2747	23-2734	22-1428	---	---	22-2891	---
114700	---	19-2788 19-2789 19-1369	18-1268 18-862	---	23-7421	---	23-2732	23-1401 23-3649 Note X	23-2747	23-2734	---	---	---	22-2891	---
114900	19-1398	19-2788 19-1369	18-1268 18-862	23-3673	23-7421	---	23-2732	23-1401 23-3649 Note X	23-2747	23-2734	22-1428	---	---	22-2891	22-7969
121700	---	19-2838	---	---	23-7173	---	---	23-1401 23-3649 Note X	---	---	---	---	---	---	---
121800	---	19-2838	---	---	23-7173	---	---	23-1401 23-3649 Note X	---	---	---	---	---	---	---
122700	---	19-2838	---	---	23-7173	---	---	---	---	---	---	---	---	---	---
123700	---	19-2838	---	---	23-7173	---	---	---	---	---	---	---	---	---	---
123800	---	19-2838	---	---	23-7173	---	---	---	---	---	---	---	---	---	---
124700	---	19-2838	---	---	23-7173	---	---	---	---	---	---	---	---	---	---
124800	---	19-2838	---	---	23-7173	---	---	---	---	---	---	---	---	---	---
125700	---	19-2838	---	---	---	---	---	---	---	---	---	---	---	---	---
126700	---	19-2838	---	---	---	---	---	---	---	---	---	---	---	---	---
126800	---	19-2838	---	---	---	---	---	---	---	---	---	---	---	---	---

2014 B&S CHART



QUICK REFERENCE CHART FOR B&S

Ignition					Rod Assy.	Valves	Oil Seals	Piston Assy. & Rings		Rewind Starter					Engine Model Number
Breaker Assy.	Coil	Con-denser	Fly Wheel key	Ignition Kit	Rod	Exhaust Intake	Mag. PTO	Piston & Pin Assy.	Std. Chrome	Rope	Pulley	HandleGrip	Spring	StarterC lutch Assy.	
---	---	---	23-1435	---	23-6757	23-2815 23-2816	23-1442 23-1441	23-6719	23-2447	25-1301 Note Z	26-875	25-1330	26-1326	26-1324	111700
31-1772	---	---	---	---	23-6757	23-2815 23-2816	23-1442 23-1442	---	23-2477	---	---	---	---	---	111900
31-1772	31-1780 (Y) 31-7287 (BB)	31-1772	23-1435	---	23-6757	23-2815 23-2816	23-1442 23-1441	23-6719	23-2447	25-1301 Note Z	26-875	25-1330	26-1326	26-1324	112200 Note G
---	31-7287	---	23-1435	---	23-3462	23-2815 23-2816	23-1442 23-1441	23-6719	23-2447	25-1301 Note Z	26-875	25-1330	26-1326	26-1324	112200 Note H
---	---	---	23-1435	---	23-6757	23-2815 23-2816	23-1442 23-1441	---	23-2477	25-1301 Note Z	26-875 Note C	25-1330	26-1326	26-1324	112700
---	---	---	23-1435	---	23-6757	23-2815 23-2816	23-1442 23-1441	---	23-2477	25-1301 Note Z	26-875	25-1330	26-1326	26-1324	112900
31-1772	31-1780 Note Y	---	23-1435	---	23-6757	23-2815 23-2816	23-1442 23-1441	23-6719	23-2447	25-1301 Note Z	26-875	25-1330	26-1326	26-1324	113900 Note I
---	31-7287	---	23-1435	---	23-6757	23-2815 23-2816	23-1442 23-1441	---	23-2477	25-1301 Note Z	26-875	25-1330 Note DD	26-1326 Note EE	26-1324	114700
---	31-7287	---	23-1435	---	23-6757	23-2815 23-2816	23-1442 23-1441	---	23-2477	25-1301 Note Z	26-875 Note CC	25-1330 Note DD	26-1326 Note EE	26-1324	114900
---	---	---	23-1435	---	23-6757	---	23-1442	---	---	25-1301 Note Z	26-875	25-1330	---	---	121700
---	---	---	23-1435	---	23-6757	---	23-1442	---	---	25-1301 Note Z	26-875	25-1330	---	---	121800
---	---	---	23-1435	---	23-6757	---	23-1442	---	---	25-1301 Note Z	---	25-1330	---	---	122700
---	---	---	23-1435	---	23-6757	---	23-1442	---	---	25-1301 Note Z	---	25-1330	---	---	123700
---	---	---	23-1435	---	23-6757	---	23-1442	---	---	25-1301 Note Z	---	25-1330	---	---	123800
---	---	---	23-1435	---	23-6757	---	23-1442	---	---	25-1301 Note Z	---	25-1330	---	---	124700
---	---	---	23-1435	---	23-6757	---	23-1442	---	---	25-1301 Note Z	---	25-1330	---	---	124800
---	---	---	23-1435	---	23-6757	---	23-1442	---	---	25-1301 Note FF	---	25-1330	---	---	125700
---	---	---	23-1435	---	23-6757	---	23-1442	---	---	25-1301 Note FF	---	25-1330	---	---	126700
---	---	---	23-1435	---	23-6757	---	23-1442	---	---	25-1301 Note FF	---	25-1330	---	---	126800

2014 B&S CHART

QUICK REFERENCE CHART FOR B&S



2014 B&S CHART

Engine Model Number	Air Filter		Muffler Assy.	Gaskets							Carburetion				
	Air Cleaner	Cartridge Pre-Cleaner		Air Cleaner	Carb. to Cylinder Gasket	Carb. to Tank Gasket	Head Gasket	Base Gasket	Gasket Set	Valve Cover Gasket	Diaphragm	Float Valve	Needle Valve	Needle & Seat Kit	Carb. Overhaul Kit
130200 Note J	19-1370	19-1396 19-2788 19-1369	18-1283 18-1269	23-1492 23-3673	23-1498	23-1494	23-1480	23-1402 Note X	23-1405	23-2733	22-1425	---	22-2888	22-2891	---
130200 Note K	---	19-2838	18-1269 18-892	---	---	---	23-1480	23-1402 Note X	23-1405	23-2733	22-1425	---	---	22-1424	---
130400	---	19-2788 19-1369	18-892	23-3673	23-1498	---	23-1480	23-1402 Note X	23-1405	23-2733	---	22-1431	---	---	---
130700	---	19-2789	18-892	---	---	---	23-1480	23-1403 Note X	23-1470	23-2733	---	---	---	---	---
130900	19-1375	19-1396 19-2788 19-1369	18-1269 18-892 18-1278 18-1283	23-1492 23-3673	23-3543	23-3538	23-1480	23-1403 Note X	23-1470	23-2733	22-1425	---	---	22-1424	---
131200	19-1374	19-1396 19-2788 19-1369	18-1269 18-892 18-1278 18-1283	23-1492 23-3673	23-1494	23-1494	23-1480	23-1402 Note X	23-1405	23-2733	22-1425	---	---	22-1424	---
131400	---	19-1396 19-2788 19-1369	18-892 18-1283 18-1269	23-3673	---	---	23-1480	23-1402 Note X	23-1405	23-2733	---	22-1431	---	---	---
131700	---	19-2789	18-892	---	---	---	23-1480	23-1403 Note X	23-1470	23-2733	---	---	---	---	---
131900	---	19-1396 19-2788 19-1369	18-892 18-1269	23-3673	---	---	23-1480	23-1403 Note X	23-1470	23-2733	22-1425	---	22-2888	22-1424	---
132200 Note L	---	19-2788 19-1369	18-892 18-1283	23-3673	23-1494	23-1494	23-1480	23-1402 Note X	23-1405	23-2733	22-1425	---	22-2888	22-1424	---
132200 Note M	---	19-2838	18-892 18-1283 18-1269	---	---	---	23-1480	23-1402 Note X	23-1405	23-2733	22-1425	---	---	---	---
132400	---	19-2788 19-1369	18-892 18-1283 18-1269	23-3673	---	---	23-1480	23-1402 Note X	23-1405	23-2733	---	---	---	---	---
132900	---	19-2788 19-1369	18-892 18-1269	23-3673	23-3543	23-3538	23-1480	23-1403 Note X	23-1470	23-2733	22-1425	22-1431	22-2888	22-1424	---
146400	---	19-2773	---	---	---	---	23-1483	23-1404 Note X	23-2746	23-2735	---	---	---	---	22-1416
146700	---	---	---	---	---	---	23-1483	23-1404 Note X	23-2746	23-2735	---	---	---	22-1420	22-1416
161400	---	19-6586	---	---	---	---	---	---	---	---	---	---	---	---	---
170400 Note N	19-6983	19-2773 19-1374 19-2786	18-2296 18-1283 18-1269	---	23-1478	---	23-1484	23-1404 Note X	23-1406	23-2735	---	22-1419	---	---	22-1416
170400 Note O	19-6983	19-2773 19-1374 19-2786	18-1283 18-1269	---	23-1478	---	23-1484	23-1404 Note X	23-1406	23-2735	---	22-1419	---	---	---
170700	19-1373	19-2840	18-2296 18-1283 18-1269	---	23-3547	---	23-1484	23-1404 Note X	23-1406	23-2735	---	22-1419	---	---	22-2884



QUICK REFERENCE CHART FOR B&S

Ignition					Rod Assy.	Valves	Oil Seals	Piston Assy. & Rings		Rewind Starter					Engine Model Number
Breaker Assy.	Coil	Con-denser	Fly Wheel key	Ignition Kit	Rod	Exhaust Intake	Mag. PTO	Piston & Pin Assy.	Std. Chrome	Rope	Pulley	Handle Grip	Spring	Starter Clutch Assy.	
31-1772	31-1764 (Y) 31-7288 (BB)	---	23-1435	---	23-2772	23-1508 23-1509	23-1442 23-1448	23-2721	23-1461 23-1531	25-1301 Note FF	26-876	25-1330 25-1315	26-1326	26-1324	130200 Note J
---	31-7288 Note BB	---	23-1435	---	23-2772	23-1508 23-1509	23-1442 23-1448	23-2721	23-1461 23-1531	25-1301 Note FF	26-876	25-1315	26-1326	26-1324	130200 Note K
---	---	---	23-1435	---	23-2772	23-1508 23-1509	23-1442 23-2709	23-2721	23-1461 23-1531	25-1301 Note FF	26-876	25-1315	26-1326	26-1324	130400
---	---	---	23-1435	---	---	23-1508 23-1509	23-1442 23-1446	23-2721	23-1461 23-1531	25-1304 Note GG	26-876	25-1315	26-1326	26-1324	130700
31-1772	31-1764 (Y) 31-7288 (BB)	---	23-1435	---	---	23-1508 23-1509	23-1442 23-1446	23-2721	23-1461 23-1351	25-1304 Note GG	26-876	25-1315	26-1326	26-1324	130900
31-1772	31-1764 (Y) 31-7288 (BB)	---	23-1435	---	23-2772	23-1509	23-1448	---	23-1531	25-1304 Note GG	26-876	25-1315	26-1326	26-1324	131200
31-1772	31-1764 (Y) 31-7288 (BB)	---	23-1435	---	23-2772	23-1509	23-2709	---	23-1531	25-1304 Note GG	26-876	25-1315	26-1326	26-1324	131400
---	---	---	23-1435	---	---	23-1508 23-1509	23-2709 23-1446	---	23-1461	25-1304 Note GG	26-876	25-1315	26-1326	26-1324	131700
31-1772	31-1764 (Y) 31-7288 (BB)	---	23-1435	---	---	23-1509	23-1442 23-1446	---	23-1461	25-1304 Note GG	26-876	25-1315	26-1326	26-1324	131900
---	31-7288 Note BB	---	23-1435	---	23-2772	23-1509	23-2709	---	23-1461	25-1304 Note GG	26-876	25-1315	26-1326	26-1324	132200 Note L
---	31-7288 Note BB	---	23-1435	---	23-2772	23-1509	23-2709	---	23-1461	25-1304 Note GG	26-876	25-1315	26-1326	26-1324	132200 Note M
---	31-7288 Note BB	---	23-1435	---	23-2772	23-1509	23-2709	---	23-1461	25-1304 Note GG	26-876	25-1315	26-1326	26-1324	132400
31-1772	31-1764 (Y) 31-7288 (BB)	---	23-1435	---	---	23-1509	23-1442 23-1446	---	23-1461	25-1304 Note GG	26-876	25-1315	26-1326	26-1324	132900
31-1767	---	---	23-1435	---	---	---	23-1448 23-1445	---	23-1462	25-1304 Note GG	26-876	25-1315	26-1326	26-1324	146400
31-1767	---	---	23-1435	---	---	---	23-1448 23-1445	---	23-1462	25-1304 Note GG	26-876	25-1315	26-1326	26-1324	146700
---	---	---	23-1435	---	---	---	---	---	---	25-1304 Note GG	---	25-1315	---	---	161400
31-1772	31-1778 Note Y	---	23-1435	---	---	23-2810 23-2811	23-1448 23-1445	23-6722	23-1463 23-1532	25-1304 Note GG	26-876	25-1315	26-1326	26-1324	170400 Note N
31-1772	31-1778 Note Y	---	23-1435	---	---	23-2810 23-2811	23-1448 23-1445	23-6722	23-1463 23-1532	25-1304 Note GG	26-876	25-1315	26-1326	26-1324	170400 Note O
31-1772	31-1778 Note Y	---	23-1435	---	---	23-2810 23-2811	23-1448 23-1445	23-6722	23-1463 23-1532	25-1304 Note GG	26-876	25-1315	26-1326	26-1324	170700

2014 B&S CHART

QUICK REFERENCE CHART FOR B&S



**2014
B&S CHART**

Engine Model Number	Air Filter		Muffler Assy.	Gaskets							Carburetion				
	Air Cleaner	Cartridge Pre-Cleaner		Air Cleaner	Carb. to Cylinder Gasket	Carb. to Tank Gasket	Head Gasket	Base Gasket	Gasket Set	Valve Cover Gasket	Diaphragm	Float Valve	Needle Valve	Needle & Seat Kit	Carb. Overhaul Kit
171400	---	19-2773 19-1374 19-2786	18-1283 18-1269	---	23-1478	---	23-1484	23-1404 Note X	23-1406	23-2735	---	22-1419	---	---	
185400	---	---	---	---	---	---	---	---	---	---	---	---	---	---	
190400 Note P	19-6983	19-2773 19-1374 19-2786	18-1283 18-1269	---	23-1478	---	23-1484	23-1404 Note X	23-1406	23-2735	---	22-1419	---	22-1416	
190400 Note Q	19-6983	19-2773 19-1374 19-2786	18-1283 18-1269	---	23-1478	---	23-1484	23-1404 Note X	23-1406	23-2735	---	22-1419	---	---	
190700	19-1373	19-2840	18-1283 18-1269	---	23-3547	---	23-1484	23-1404 Note X	23-1406	23-2735	---	22-1419	---	22-2884	
191700	19-1373	19-2840	18-1283 18-1269	---	23-3547	---	23-1484	23-1404 Note X	23-1406	23-2735	---	22-1419	---	22-2884	
192700	19-1373	19-2840	18-1283 18-1269	---	---	---	23-1484	23-1404 Note X	23-1406	23-2735	---	22-1419	---	22-2884	
193700	19-1373	19-2840	18-1283 18-1269	---	---	---	23-1484	23-1404 Note X	23-1406	23-2735	---	22-1419	---	---	
194400	---	19-1374 19-2786	18-1269	---	23-1478	---	23-1484	23-1404 Note X	23-1406	23-2735	---	22-1419	---	---	
194700	19-7051	---	18-1269	---	---	---	23-1484	23-1404 Note X	23-1406	23-2735	---	---	---	---	
195400 Note R	---	19-1374 19-2786	18-1283 18-1269	---	23-1478	---	23-1484	23-1404 Note X	23-1406	23-2735	---	22-1419	---	---	
195400 Note S	---	19-1374 19-2786	18-1283 18-1269	---	23-1478	---	23-1484	23-1404 Note X	23-1406	23-2735	---	22-1419	---	22-1416	
195700	19-7051	---	---	---	---	---	23-1484	23-1404 Note X	23-1406	23-2735	---	---	---	---	
196700	---	---	18-1283	---	23-6546	---	23-1484	23-1404 Note X	23-1406	23-2735	---	---	---	---	
200400	19-6983	---	18-859	---	---	---	---	---	23-2748	23-2735	---	22-1419	---	---	
220400	---	19-1374 19-2786	18-6955	---	---	---	23-2761	23-2761	---	23-2735	---	22-1419	---	22-1416	
220700	19-1397	19-2778	18-6955	---	---	---	23-2761	23-2761	23-2744	23-2735	---	22-1419	---	---	
221400	---	19-1374 19-2786	18-6955	---	---	---	23-2761	23-2761	---	23-2735	---	22-1419	---	---	
222400	---	19-1374 19-2786	---	---	23-6527	---	23-2761	---	---	23-2735	---	22-1419	---	---	



QUICK REFERENCE CHART FOR B&S

Ignition					Rod Assy.	Valves	Oil Seals	Piston Assy. & Rings		Rewind Starter					Engine Model Number
Breaker Assy.	Coil	Condenser	Fly Wheel key	Ignition Kit	Rod	Exhaust Intake	Mag. PTO	Piston & Pin Assy.	Std. Chrome	Rope	Pulley	Handle Grip	Spring	Starter Clutch Assy.	
---	---	---	23-1435	---	---	23-2811	23-1448 23-1445	---	23-1532	25-1304 Note GG	26-876	25-1315	26-1326	26-1324	171400
---	---	---	23-1435	---	---	---	---	---	---	25-1304 Note GG	---	25-1315	---	---	185400
31-1772	31-1778 Note Y	---	23-1435	---	23-2770	23-2810 23-2811	23-1448 23-1445	23-6722	23-1463 23-1532	25-1304 Note GG	26-876	25-1315	26-1326	26-1324	190400 Note P
---	---	---	23-1435	---	23-2770	23-2810 23-2811	23-1448 23-1445	23-6722	23-1463 23-1532	25-1304 Note GG	26-876	25-1315	26-1326	26-1324	190400 Note Q
31-1772	31-1778 Note Y	---	23-1435	---	---	23-2810 23-2811	23-1448 23-1445	23-6722	23-1463 23-1532	25-1304 Note GG	26-876	25-1315	26-1326	26-1324	190700
31-1772	31-1778 Note Y	---	23-1435	---	---	23-2810 23-2811	23-1448 23-1445	23-6722	23-1463 23-1532	25-1304 Note GG	26-876	25-1315	26-1326	26-1324	191700
---	---	---	23-1435	---	---	23-2810 23-2811	23-1448 23-1445	---	23-1532	25-1304 Note GG	26-876	25-1315	26-1326	26-1324	192700
---	---	---	23-1435	---	23-2770	23-2810 23-2811	23-1448 23-1445	---	23-1532	25-1304 Note FF	26-876	25-1315	26-1326	26-1324	193700
---	---	---	23-1435	---	---	23-2810 23-2811	23-1448 23-1445	---	23-1532	25-1304 Note FF	26-876	25-1315	26-1326	26-1324	194400
---	---	---	23-1435	---	---	23-2810 23-2811	23-1448 23-1445	23-6722	23-1463 23-1532	25-1304 Note FF	26-876	25-1315	26-1326	26-1324	194700
---	---	---	23-1435	---	23-2770	23-2810 23-2811	23-1448 23-1445	---	23-1532	25-1304 Note FF	26-876	25-1315	26-1326	26-1324	195400 Note R
31-1772	31-1778 Note Y	---	23-1435	---	23-2770	23-2810 23-2811	23-1448 23-1445	---	23-1532	25-1304 Note FF	26-876	25-1315	26-1326	26-1324	195400 Note S
---	---	---	23-1435	---	---	23-2810 23-2811	23-1448 23-1445	23-6722	23-1463 23-1532	25-1304 Note FF	26-876	25-1315	26-1326	26-1324	195700
---	---	---	23-1435	---	---	23-2810 23-2811	23-1448 23-1445	---	23-1532	25-1304 Note FF	26-876	25-1315	26-1326	26-1324	196700
31-1771	31-1778 Note Y	---	23-1435	---	---	---	23-1445 23-1445	---	---	25-1304 Note FF	26-876	25-1315	26-1326	26-1324	200400
31-1766	31-1778 Note Y	31-1773	23-1435	---	---	---	23-1445 23-1447	23-6725	23-1466 23-5875	25-1304 Note FF	26-876	25-1315	26-1326	26-1324	220400
31-1766	31-1778 Note Y	31-1773	23-1435	---	---	---	23-1445 23-1447	23-6725	23-1466 23-5875	25-1304 Note FF	26-876	25-1315	26-1326	26-1324	220700
31-1766	31-1778 Note Y	31-1773	23-1435	---	---	---	23-1445 23-1447	---	23-5875	25-1304 Note FF	26-876	25-1315	26-1326	26-1324	221400
31-1766	31-1778 Note Y	31-1773	23-1435	---	---	---	23-1445 23-1447	23-6725	23-1466 23-5875	25-1304 Note FF	26-876	25-1315	26-1326	26-1324	222400

2014 B&S CHART

QUICK REFERENCE CHART FOR B&S



Engine Model Number	Air Filter		Muffler Assy.	Gaskets							Carburetion				
	Air Cleaner	Cartridge Pre-Cleaner		Muffler	Air Cleaner	Carb. to Cylinder Gasket	Carb. to Tank Gasket	Head Gasket	Base Gasket	Gasket Set	Valve Cover Gasket	Diaphragm	Float Valve	Needle Valve	Needle & Seat Kit
233400 Note T	19-6983	---	18-859	---	23-6523	---	23-2753	23-6522	23-919	23-2735	---	22-1419	---	---	---
233400 Note U	---	19-1374 19-2786	18-859	---	23-6523	---	23-2753	23-6522	23-919	23-2735	---	22-1419	---	---	---
243400	19-6983	19-1374 19-2786	18-859	---	23-6523	---	23-2753	23-6522	---	23-2735	---	22-1419	---	---	---
252400	---	19-6514 19-1374 19-2786	18-6955	---	23-6527	---	23-2761	---	---	23-2735	---	22-1419	---	---	---
252700	19-1397	19-2778	18-6955	---	23-6527	---	23-2761	23-3520 23-6528 23-6529	23-2744	23-2735	---	22-1419	---	---	---
253400	---	19-6514	---	---	23-6527	---	---	---	---	23-2735	---	22-1419	---	---	---
253700	19-1397	Note II	18-6955	---	23-6527	---	23-2761	---	23-2744	23-2735	---	22-1419	---	---	---
254400	---	19-1374	18-6955	---	23-6527	---	23-2761	---	---	23-2735	---	22-1419	---	---	---
254700	---	---	---	---	23-6527	---	23-2761	---	23-2744	23-2735	---	---	---	---	---
255400	---	19-6514	---	---	23-6527	---	---	---	---	23-2735	---	22-1419	---	---	---
255700	19-1397	---	18-6955	---	23-6527	---	23-2761	23-3530 23-6528 23-6529	23-2744	23-2735	---	22-1419	---	---	22-2884
256700	19-1397	19-2778 19-5941	18-6955	---	23-6527	---	23-2761	23-3530 23-6528 23-6529	23-2744	23-2735	---	22-1419	---	---	22-2884
257700	---	---	---	---	23-6527	---	23-2761	23-3530 23-6528 23-6529	23-2744	23-2735	---	---	---	---	---
260700	---	19-6604 19-6575	---	---	---	---	---	---	---	---	---	---	---	---	---
261700	---	19-6604 19-6575	---	---	---	---	---	---	---	---	---	---	---	---	---
280700	---	19-5941 19-5939	18-6955	---	23-6527	---	23-2761	---	---	23-2735	---	22-1419	---	---	22-2884
281700	---	19-5941 19-5939	18-6955	---	23-6527	---	23-2761	---	---	23-2735	---	22-1419	---	---	22-2884
282700	---	19-7094 19-7095	---	---	23-6527	---	23-2761	---	---	23-2735	---	---	---	---	---
283700	---	19-7094 19-7095	---	---	23-6527	---	23-2761	---	---	23-2735	---	---	---	---	---

2014

B&S CHART



QUICK REFERENCE CHART FOR B&S

Ignition					Rod Assy.	Valves	Oil Seals	Piston Assy. & Rings		Rewind Starter					Engine Model Number
Breaker Assy.	Coil	Con-denser	Fly Wheel key	Ignition Kit	Rod	Exhaust Intake	Mag. PTO	Piston & Pin Assy.	Std. Chrome	Rope	Pulley	HandleGrip	Spring	StarterC lutch Assy.	
31-1771	31-1778 Note Y	31-1775	23-1435	---	---	---	23-1445 23-1445	---	---	25-1304 Note GG	26-876	25-1315	26-1326	26-1324	233400 Note T
31-1771	31-1778 Note Y	31-1775	23-1435	---	---	---	23-1445 23-1445	---	---	25-1304 Note GG	26-876	25-1315	26-1326	26-1324	233400 Note U
31-1771	31-1778 Note Y	31-1775	23-1435	---	---	---	23-1445 23-1447	---	---	25-1304 Note GG	26-876	25-1315	26-1326	26-1324	243400
31-1766	31-1778 Note Y	31-1773	23-1435	---	23-6758	---	23-1445 23-1447	23-6725	23-1466 23-5875	25-1304 Note GG	26-876	25-1315	26-1326	26-1324	252400
31-1766	31-1778 Note Y	31-1773	23-1435	---	23-6758	---	23-1445 23-1447	23-6725	23-1466 23-5875	25-1304 Note GG	26-876	25-1315	26-1326	26-1324	252700
31-1766	31-1778 Note Y	31-1773	23-1435	---	23-6758	---	23-1445 23-1447	23-6725	23-1466 23-5875	25-1304 Note GG	26-876	25-1315	26-1326	26-1324	253400
---	---	---	23-1435	---	23-6758	---	23-1445 23-1447	---	---	25-1304 Note GG	26-876	25-1315	26-1326	26-1324	253700
---	---	---	23-1435	---	23-6578	---	23-1445 23-1447	---	---	25-1304 Note GG	26-876	25-1315	26-1326	26-1324	254400
---	---	---	23-1435	---	23-6758	---	23-1445 23-1447	23-6725	23-1466 23-5875	25-1304 Note GG	26-876	---	26-1326	26-1324	254700
---	---	---	23-1435	---	23-6758	---	23-1445 23-1447	---	---	25-1304 Note GG	26-876	---	26-1326	26-1324	255400
---	---	---	23-1435	---	23-6758	---	23-1445 23-1447	23-6725	23-1466 23-5875	25-1304 Note GG	26-876	25-1315	26-1326	26-1324	255700
---	---	---	23-1435	---	23-6758	---	23-1445 23-1447	---	---	25-1304 Note GG	26-876	25-1315	26-1326	26-1324	256700
---	---	---	23-1435	---	23-6758	---	---	23-6725	23-1466 23-5875	25-1304 Note GG	26-876	25-1315	26-1326	26-1324	257700
---	---	---	23-1435	---	---	---	---	---	---	25-1304 Note GG	---	25-1315	---	---	260700
---	---	---	23-1435	---	---	---	23-1445 23-1447	---	---	25-1304 Note GG	---	25-1315	---	---	261700
---	---	---	23-1435	---	23-6758	---	23-1445 23-1447	23-6725	23-1466 23-5875	25-1304 Note GG	26-876	25-1315	26-1326	---	280700
---	---	---	23-1435	---	23-6758	---	23-1445 23-1447	---	---	25-1304 Note GG	26-876	25-1315	26-1326	---	281700
---	---	---	23-1435	---	23-6758	---	23-1445 23-1447	---	23-1466 23-5875	---	---	---	---	---	282700
---	---	---	23-1435	---	23-6758	---	23-1445 23-1447	23-6725	23-1466 23-5875	25-1304 Note GG	26-876	25-1315	26-1326	26-1324	283700

2014 B&S CHART

QUICK REFERENCE CHART FOR B&S



**2014
B&S CHART**

Engine Model Number	Air Filter		Muffler Assy.	Gaskets							Carburetion				
	Air Cleaner	Cartridge Pre-Cleaner		Air Cleaner	Carb. to Cylinder Gasket	Carb. to Tank Gasket	Head Gasket	Base Gasket	Gasket Set	Valve Cover Gasket	Diaphragm	Float Valve	Needle Valve	Needle & Seat Kit	Carb. Overhaul Kit
286700	---	19-7094 19-7095	---	---	23-6527	---	23-2761	---	---	23-2735	---	---	---	---	---
290400	---	Note HH	---	---	---	---	---	---	---	---	---	---	---	---	---
290700	---	19-2777 19-2797	---	---	---	---	---	---	---	---	---	---	---	---	---
294400	---	19-2777 19-2797	---	---	---	---	---	---	---	---	---	---	---	---	---
294700	---	19-2777 19-2797	---	---	---	---	---	---	---	---	---	---	---	---	---
300400	19-6983	---	18-859	---	23-6523	---	---	---	---	23-2735	---	22-1419	---	---	---
302400	---	---	18-859	---	23-6523	---	---	---	---	23-2735	---	22-1419	---	---	22-2885
303400	---	19-2777 19-2797	---	---	---	---	---	---	---	---	---	---	---	---	---
303700	---	19-2777 19-2797	---	---	---	---	---	---	---	---	---	---	---	---	---
320400	19-6983	---	18-859	---	23-6523	---	---	---	---	23-2735	---	22-1419	---	---	---
326400	---	19-1374 19-2786	18-859	---	23-6523	---	---	---	---	23-2735	---	22-1419	---	---	---
350400	---	19-2777 19-2797	---	---	---	---	---	---	---	---	---	---	---	---	---
350700	---	19-2777 19-2797	---	---	---	---	---	---	---	---	---	---	---	---	---
400700	---	19-2806 19-2797	---	---	23-7421 Note V	---	---	---	---	23-2735 Note V	---	22-1419	---	---	---
401400	---	19-2777 19-2797	---	---	23-7421 Note V	---	---	---	---	23-2735 Note V	---	22-1419	---	---	---
402400	---	19-2777 19-2797	---	---	23-7421 Note V	---	---	---	---	23-2735 Note V	---	22-1419	---	---	---
402700	---	19-2806 19-2797	---	---	23-7421 Note V	---	---	---	---	23-2735 Note V	---	22-1419	---	---	---
422400	---	19-2777 19-2797	---	---	23-7421 Note V	---	---	---	---	23-2735 Note V	---	22-1419	---	---	---
422700	---	19-2806 19-2797	---	---	23-7421 Note V	---	---	---	---	23-2735 Note V	---	22-1419	---	---	---



QUICK REFERENCE CHART FOR B&S

Ignition					Rod Assy.	Valves	Oil Seals	Piston Assy. & Rings		Rewind Starter					Engine Model Number
Breaker Assy.	Coil	Con-denser	Fly Wheel key	Ignition Kit	Rod	Exhaust Intake	Mag. PTO	Piston & Pin Assy.	Std. Chrome	Rope	Pulley	HandleG rip	Spring	StarterC lutch Assy.	
---	---	---	23-1435	---	23-6578	---	23-1445 23-1415	---	23-1466 23-5875	25-1304 Note GG	26-876	25-1315	26-1326	26-1324	286700
---	---	---	---	---	---	---	---	---	---	25-1304 Note FF	---	25-1315	---	---	290400
---	---	---	---	---	---	---	---	---	---	25-1304 Note FF	---	25-1315	---	---	290700
---	---	---	---	---	---	---	---	---	---	25-1304 Note FF	---	25-1315	---	---	294400
---	---	---	---	---	---	---	---	---	---	25-1304 Note FF	---	25-1315	---	---	294700
31-1771	31-1778	31-1775	23-1435	---	---	---	---	---	---	25-1304 Note FF	---	25-1315	---	---	300400
31-1771	31-1778	31-1775	23-1435	---	---	---	---	---	---	25-1304 Note FF	---	25-1315	---	26-1324	302400
---	---	---	---	---	---	---	---	---	---	25-1304 Note FF	---	25-1315	---	---	303400
---	---	---	---	---	---	---	---	---	---	25-1304 Note FF	---	25-1315	---	---	303700
31-1771	31-1778	31-1775	23-1435	---	---	---	---	---	---	25-1304 Note FF	---	25-1315	---	---	320400
---	31-1778 (Y) 31-7286 (BB)	31-1775	23-1435	---	---	---	---	---	---	25-1304 Note FF	---	25-1315	---	---	326400
---	---	---	---	---	---	---	---	---	---	25-1304 Note FF	---	25-1315	---	---	350400
---	---	---	---	---	---	---	---	---	---	25-1304 Note FF	---	25-1315	---	---	350700
---	---	---	23-1435	---	---	---	23-1445 23-1447	---	23-6725	---	---	25-1315	---	---	400700
---	---	---	23-1435	---	---	---	23-1445 23-1447	23-6725	---	---	---	---	---	---	401400
---	---	---	23-1435	---	---	---	23-1445 23-1447	23-6725	---	---	---	---	---	---	402400
---	---	---	23-1435	---	---	---	23-1445 23-1447	23-6725	---	---	---	---	---	---	402700
---	---	---	23-1435	---	---	---	23-1445 23-1447	23-6725	---	25-1304 Note FF	---	25-7327 1315	---	---	422400
---	---	---	23-1435	---	---	---	23-1445 23-1447	23-6725	---	---	---	---	---	---	422700

2014 B&S CHART

QUICK REFERENCE CHART FOR B&S



REFERENCE NOTES:









- Note A:** Type Nos. 0010-2200, 8000-8200 and above 9000.
- Note B:** Type Nos. 2201-4900 and 8901-8999
- Note C:** Type Nos. 0111-0200, 2035-2099 and 8000-8199
- Note D:** Type Nos. 0300-0400, 2135-2199, 4000-5000 and above 8200
- Note E:** Type Nos. Above 0600 and 92500
- Note F:** Type Nos. Above 0500 and 92900
- Note G:** Type Nos. 0016-0799 and 112200
- Note H:** Type Nos. Above 0800 and 112200
- Note I:** Except Type Nos. 2999-113900
- Note J:** Type Nos. Below 2300 and 5100-5199
- Note K:** Type Nos. 2900-4100 and 5200-5600
- Note L:** Type Nos. 0100-0300 and 2000-2200
- Note M:** Type Nos. 0301-0499, 2200-2299 and Above 4000
- Note N:** Type Nos. 0500-1999
- Note O:** Type Nos. Above 2000
- Note P:** Type Nos. 0010-2100
- Note Q:** Type Nos. Above 2500
- Note R:** Type Nos. 0100-0400 and 2000-2099
- Note S:** Type Nos. 0600-1999 and Above 2100
- Note T:** Type Nos. 0010-0350
- Note U:** Type Nos. Above 0500
- Note V:** Uses Two Gaskets
- Note W:** Uses One Gasket
- Note X:** Part No. 23-1401 = .015 thickness
Part No. 23-3649 = .005 thickness
- Note Y:** Point Type Only
- Note Z:** # 4 Rope = 48-1/2"
- Note AA:** Air Cleaner = Duel Element Air Filter Assembly
- Note BB:** Magneto Type
- Note CC:** Use Part No. 26-852 (Vertical Pull Starter Assembly)
- Note DD:** Use Part No. 26-2234 (Vertical Pull)
- Note EE:** Use Part No. 26-1327 (Vertical Pull)
- Note FF:** # 4 Rope = 99"
- Note GG:** # 5-1/2 Rope = 63"
- Note HH:** 19-1374, 19-2777, 19-6601 Cartridges
19-2797, 19-2786, 19-7671 Precleaners
- Note II:** 19-2778, 19-5941 Cartridges
19-2786, 19-5939 Precleaners









2014

B&S CHART



QUICK REFERENCE CHART FOR LAWNBOY

Engine Model Number	Air Filter	Gaskets	Piston Assy. & Rings		Carburetion			Oil Seal
	 Air Cleaner	 Gasket Set	 Piston & Pin Assy.	 Std. Chrome	 Float Valve	 Carburetor Kit	 Overhaul Kit	 Oil Seal
Iron Horse A	----	----	----	----	----	----	----	----
C	19-1378	23-2758	----	----	----	22-1421	----	23-2956
D	19-1379	23-2758	23-2725 23-2724	23-1464	22-2950	22-1421	----	23-2956
F	19-1380	----	23-2749	23-2954	22-2950	----	----	23-2956

Engine Model Number	Ignition				Rewind Starter			Spring Assortment
	 Points	 Condenser	 Coil	 C.D. Module	 Starter Spring	 Pinion Gear	 Spring	 Governor Kit
Iron Horse A	31-1794	31-1799	31-1806	----	----	----	----	----
C	31-7195	31-1800	31-1806	----	26-1332	26-2241	26-2240	----
D	31-1795	31-1800	31-1901	31-1899 Note A	26-1333	26-2241	26-2240	----
F	----	----	----	31-1897 31-1898 Note B	26-2463 Note C	26-2959	26-2957	----

2014 LAWNBOY CHART

REFERENCE NOTES:













Note A: For D-600 models only

Note B: Fore F engines made from '78-'82 use 31-1897, for F engines made '83 and up, use 31-1898

Note C: For F engines model 100 and 140, use 26-1333

QUICK REFERENCE CHART FOR KOHLER



Engine Model Number	Air Filter	Muffler Assy.	Gaskets				Carburetion		Valves		Rod Assy.
	 Air Cleaner  Pre-Cleaner										
			Oil Pan Gasket	Cylinder Gasket	Valve Cover	Gasket Set	Carb. Repair Kit	Carb. Overhaul Kit	Exhaust	Intake	Rod
K91 (4 HP)	19-1384 19-5934	18-2291 18-1279	23-7794	----	23-7794	----	22-2886	----	----	----	----
K141 (6 HP)	19-1384 19-5934	----	23-3533	23-2763 Note D	23-2739	23-2755	22-2886	----	23-2834	----	----
K161 (7 HP)	19-1384 19-5934	----	23-3533	23-2763 Note D	23-2739	23-2755	22-2886	----	23-2834	----	----
K181 (8 HP)	19-1385 19-2780	----	23-3533	23-2763 Note D	23-2739	23-2755	22-2886	----	23-2834	----	23-6761
K241 (10 HP)	19-1386 19-1377	18-1277	23-3534 Note A	23-2764 Note D	23-2740 23-2741 Note E	23-2755	22-2886 Note B	----	23-2833	23-2830	23-6763
K301 (12 HP)	19-1386 19-1377	18-1277	23-3534 Note A	23-2764 Note D	23-2740 23-2741 Note E	23-2755	22-2886 Note B	----	23-2833	23-2830	23-6765
K321 (14 HP)	19-1386 19-1377	18-1277	23-3534 Note A	23-2764 Note D	23-2740 23-2741 Note E	23-2755	22-2886	----	23-2833	23-2830	23-6765
K341 (16 HP)	19-1388 19-2844	----	23-3534 Note A	23-2750	23-2740 23-2741 Note E	----	22-2886 Note B	----	----	----	23-6765
K532 (20 HP)	19-1387	18-1277	23-7802	----	----	----	----	----	----	23-2830	----
K582 (23 HP)	19-1387	18-1277	23-7802	----	----	----	----	----	----	23-2830	----
KT17 (17 HP)	19-2774 19-5863	----	----	----	----	----	----	----	----	----	----
KT19 (19 HP)	19-2774 19-5863	----	----	----	----	----	----	----	----	----	----

2014 KOHLER CHART



QUICK REFERENCE CHART FOR KOHLER

Breaker Assembly	Ignition				Piston Assy. & Rings		Oil Seals		Oil Filter	Engine Model Number
	Condensers	Ignition Coil	Pionts & Condensers Kits		Piston & Pin Assy.	Std.	Flywheel	PTO	Filter	
	Battery	Battery	Battery	Magneto						
31-1823	31-1844 31-1843	31-1781 31-2975	31-6828	31-6827	23-6739 Note C	23-6794 ----	----	----	----	K91 (4 HP)
31-1823	31-1844 31-1853	31-1781 ----	31-6828	31-6827	----	----	----	----	----	K141 (6 HP)
31-1823	31-1844 31-1853	31-1781 ----	31-6828	31-6827	----	----	----	----	----	K161 (7 HP)
31-1823	31-1844 31-1853	31-1781 ----	31-6828	31-6827	23-6741 Note C	---- 23-2470	----	----	----	K181 (8 HP)
31-1823	31-1844 31-1853	31-1781 ----	31-6828	31-6827	23-6745 Note C	---- 23-2471	----	----	----	K241 (10 HP)
31-1823	31-1844 31-1853	31-1781 ----	31-6828	31-6827	23-6749 Note C	---- 23-2472	----	----	----	K301 (12 HP)
31-1823	31-1844 31-1853	31-1781 ----	31-6828	31-6827	23-6753 Note C	---- 23-2473	----	----	19-5909	K321 (14 HP)
31-1823	31-1844 31-1853	31-1781 ----	31-6828	31-6827	----	---- 23-2474	----	----	19-5909	K341 (16 HP)
31-1823	31-1844 31-1853	----	31-6828	----	----	----	----	----	19-6676 19-5909 19-7916	K532 (20 HP)
31-1823	31-1844 ----	----	31-6828	----	----	----	----	----	----	K582 (23 HP)
31-1823	31-1844 ----	----	----	----	----	----	----	----	----	KT17 (17 HP)
31-1823	31-1844 ----	----	----	----	----	----	----	----	----	KT19 (19 HP)

REFERENCE NOTES:

- Note A:** For Models with Shallow Pans
- Note B:** For Other Kits, Please refer to Catalog
- Note C:** Standard Size Assemblies, for oversize assemblies please refer to catalog
- Note D:** Metal Gaskets
- Note E:** 23-2740 use with 23-2741 and 23-2741 use with 23-2740

2014

KOHLER CHART

QUICK REFERENCE CHART FOR TECUMSEH



TECUMSEH CHART 2014









Engine Model Number	Air Filter	Gaskets			Piston Assy. & Rings		Valves		Rod Assy.
	Air Cleaner Pre-Cleaner	Head Gasket	Base Gasket	Gasket Set	Piston & Pin Assy.	Chrome	Exhaust	Intake	Rod
LAV30	19-1393	23-1489	23-3651	23-1474	----	23-1456	23-1518	23-1519	23-1528
H30	19-1382	23-1489	23-3650	23-1474	----	23-1458	23-1518	23-1519	23-1528
LAV35	19-1393	23-1489	23-3651	23-1474	----	23-1456	23-1518	23-1519	23-1528
H35	19-1382	23-1489	23-3650	23-1474	----	23-1456	23-1518	23-1519	23-1528
LAV40	19-1393	23-2760	23-3651	23-1474	----	23-1460	23-1518	23-1519	23-6767
HS40	19-1390	23-2760	23-3650	23-1474	----	23-1460	23-1518	----	23-6767
LAV50	19-1390	----	23-3651	23-1474	----	23-1467	23-1518	----	----
H50	19-1390	23-1491	23-3653	23-2757	23-6733	23-1460	23-1521	----	----
HS50	19-1390	----	23-3650	23-1474	----	23-1467	23-1518	----	23-6767
V50	19-1390	23-1491	23-3653	23-2757	23-6733	23-1460	23-1521	----	----
V60	19-1390	23-1491	23-3653	23-2757	23-6733	23-1460	23-1521	----	23-6768
VH60	19-1390	23-1491	23-3653	23-2757	23-6734	23-1460	23-1521	----	23-6768
H60	19-1390	23-1491	23-3653	23-2757	23-6733	23-1460	23-1521	----	23-6768
HH60	19-1390	23-1491	23-3653	23-2757	23-6734	23-1460	23-1521	----	23-6768
V70	19-1390	----	23-3653	23-2757	23-6735	23-1462	23-1521	----	23-6769
VH70	19-1390	----	23-3653	23-2757	----	23-1462	23-1521	----	23-6769
VM70	19-1392	----	23-3531	23-2757	----	----	23-1521	----	23-6769



QUICK REFERENCE CHART FOR TECUMSEH

2014

TECUMSEH CHART

Ignition			Rewind Starter	Carburetion			Oil Seals	Engine Model Number
Points	Condenser	Coil	Starter Spring	Diaphragm	Inlet Needle Float Valve	Carb. Repair Kit	Magento PTO	
								
31-1819	31-1852	31-1884	26-1329	22-1427	22-1430 Note B	Note D	23-1444 23-2714	LAV30
31-1819	31-1852	31-1884	26-1329	22-1427	22-1430 Note B	Note D	23-1444 23-2714	H30
31-1819	31-1852	31-1884	26-1329	22-1427	22-1430 Note B	Note D	23-1444 23-2714	LAV35
31-1819	31-1852	31-1884	26-1329	22-1427	22-1430 Note B	Note D	23-1444 23-2714	H35
31-1819	31-1852	31-1884	26-1329	----	22-1434 Note C	Note D	23-2711 23-2715	LAV40
31-1819	31-1852	31-1884	26-1329	----	22-1434 Note C	Note D	23-2711 23-2715	HS40
31-1819	31-1852	31-1884	26-1329	----	22-1434 Note C	Note D	23-2711 23-2715	LAV50
31-1819	31-1852	31-1884	26-1329	----	22-1434 Note C	Note D	23-2712 23-2716	H50
31-1819	31-1852	31-1884	26-1329	----	22-1434 Note C	Note D	23-2711 23-2715	HS50
31-1819	31-1852	31-1884	26-1329	----	22-1434 Note C	Note D	23-2712 23-2715	V50
31-1819	31-1852	31-1884	26-1329	----	22-1434 Note C	Note D	23-2712 23-2715	V60
31-1819	31-1852	31-1884	26-1329	----	22-1434 Note C	Note D	23-2712 23-2715	VH60
31-1819	31-1852	31-1884	26-1329	----	22-1434 Note C	Note D	23-2712 23-2716	H60
31-1819	31-1852	31-1884	26-1329	----	22-1434 Note C	Note D	23-2712 23-2716	HH60
31-1819	31-1852	31-1884	26-1329	----	22-1434 Note C	Note D	23-2713 23-2715	V70
31-1819	31-1852	31-1884	26-1329	----	22-1434 Note C	Note D	23-2713 23-2715	VH70
31-1819	31-1852	31-1884	26-2430	----	22-1434 Note C	Note D	23-2713 ----	VM70

QUICK REFERENCE CHART FOR TECUMSEH











TECUMSEH CHART 2014

Engine Model Number	Air Filter	Gaskets			Piston Assy. & Rings		Valves		Rod Assy.
	Air Cleaner Pre-Cleaner	Head Gasket	Base Gasket	Gasket Set	Piston & Pin Assy.	Std. Chrome	Exhaust	Intake	Rod
H70	19-1390	----	23-3653	----	23-6735	23-1462	23-1521	----	23-6769
HH70	19-1390	----	23-3653	23-2757	----	23-1462	23-1521	----	23-6769
HM70	19-2775	----	23-3531	23-2745	----	----	23-1521	----	23-6769
V80	19-1390	23-2762	23-3531	23-2745	----	23-1534	23-1521	----	23-6769
VM80	19-1390	23-6762	23-3531	23-2745	----	23-1534	23-1521	----	23-6769
V-VM80	19-1392	----	23-3531	----	----	----	23-1521	----	23-6769
H80	19-2775	23-6762	23-3531	23-2745	----	23-1534	23-1521	----	23-6769
HM80	19-2775	23-2762	23-3531	23-2745	----	23-1534	23-1521	----	23-6769
VH100	19-1386 19-1377	----	----	----	23-6736	23-6777	----	----	----
VM100	19-1392	23-2762	23-3531	23-2745	----	----	23-1521	----	23-6769
HH100	19-1386 19-1377	----	----	----	23-6736	23-6777	----	----	----
HM100	19-2775	23-2762	23-3531	23-2745	----	----	23-1521	----	23-6769
HH120	19-1386 19-1377	----	----	----	23-6732	23-6775	----	----	----
OH120	19-1386 19-1377	----	----	----	----	----	----	----	----
HH140	19-1386 19-1377	----	----	----	23-6736	23-6777	----	----	----
OH140	19-1386 19-1377	----	----	----	23-6736	23-6777	----	----	----
HH150	19-1386 19-1377	----	----	----	23-6732	23-6775	----	----	----



QUICK REFERENCE CHART FOR TECUMSEH











**2014
TECUMSEH CHART**

Ignition			Rewind Starter	Carburetion			Oil Seals	Engine Model Number
Points	Condenser	Coil	Starter Spring	Diaphragm	Inlet Needle Float Valve	Carb. Repair Kit	Magento PTO	
								
31-1819	31-1852	31-1884	26-1329	----	22-1434 Note C	Note D	23-2713 23-2716	H70
31-1819	31-1852	31-1884	26-1329	----	22-1434 Note C	Note D	23-2713 23-2716	HH70
31-1819	31-1852	31-1884	26-2430	----	22-1434 Note C	Note D	23-2713	HM70
31-1819	31-1852	31-1884	26-2430	----	22-1434 Note C	Note D	23-2713	V80
31-1819	31-1852	31-1884	26-2430	----	22-1434 Note C	Note D	23-2713	VM80
31-1819	----	31-1884	26-2430	----	22-1434 Note C	Note D	23-2713	V-VM80
31-1819	31-1852	31-1884	26-2430	----	22-1434 Note C	Note D	23-2713	H80
31-1819	31-1852	31-1884	26-2430	----	22-1434 Note C	Note D	23-2713	HM80
----	----	----	----	----	22-1434 Note C	Note D	----	VH100
31-1761 Note A	31-1852	31-1884	26-2430	----	22-1434 Note C	Note D	23-2713	VM100
----	----	----	----	----	22-1434 Note C	Note D	----	HH100
31-1761 Note A	31-1852	31-1884	26-2430	----	22-1434 Note C	Note D	23-2713	HM100
----	----	----	----	----	22-1434 Note C	Note D	----	HH120
----	----	----	----	----	----	Note D	----	OH120
----	----	----	----	----	----	Note D	----	HH140
----	----	----	----	----	----	Note D	----	OH140
----	----	----	----	----	----	Note D	----	HH150

QUICK REFERENCE CHART FOR TECUMSEH

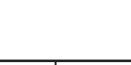

TECUMSEH CHART 2014

Engine Model Number	Air Filter		Gaskets			Piston Assy. & Rings		Valves		Rod Assy.
										
			Head Gasket	Base Gasket	Gasket Set	Piston & Pin Assy.	Chrome	Exhaust	Intake	Rod
HH160	19-1386 19-1377		----	----	----	23-6732	23-6775	----	----	----
OH160	19-1386 19-1377		----	----	----	23-6732	23-6775	----	----	----
OH180	19-1386 19-1377		----	----	----	----	----	----	----	----
ECV100	----		----	23-3651	23-1474	----	23-1460	23-1518	23-1519	23-1528
TNT100	19-1383		23-2760	23-3651	23-1474	----	23-1460	23-1518	23-1519	23-1528
TNT120	19-1383		----	23-3651	23-1474	----	23-1467	23-1518	23-1519	23-6767
TVM140	19-1390		23-1491	23-3653	23-2745	23-6733	23-1460	23-1521	----	23-6768
TVM170	19-1392		----	23-3531	----	----	----	23-1521	----	23-6769
TVM195	19-1392		----	23-3531	23-2745	----	----	23-1521	----	23-6769
TVM220	19-2829 19-5862		----	23-3531	23-2745	----	----	23-1521	----	23-6769
TVS75	19-2842		23-1489	23-3651	23-1474	----	23-1458	23-1518	23-1519	23-1528
TVS90	19-2842		23-1489	23-3651	23-1474	----	23-1456	23-1518	23-1519	23-1528
TVS105	19-2842		23-2760	23-3651	23-1474	----	23-1460	23-1518	23-1519	23-6767
TVS120	19-2842		----	23-3651	----	----	23-1467	23-1518	23-1519	23-6767



QUICK REFERENCE CHART FOR TECUMSEH

2014
TECUMSEH CHART

Ignition			Rewind Starter	Carburetion			Oil Seals	Engine Model Number
Points	Condenser	Coil	Starter Spring	Diaphragm	Inlet Needle Float Valve	Carb. Repair Kit	Magento PTO	
----	----	----	----	----	----	Note D	----	HH160
----	----	----	----	----	----	Note D	----	OH160
----	----	----	----	----	----	Note D	----	OH180
31-1761 Note A	----	----	----	----	----	Note D	23-1444 23-2714	ECV100
31-1761 Note A	31-1852	31-1884	26-1334	----	22-1434 Note C	Note D	23-1444 23-2714	TNT100
31-1761 Note A	31-1852	31-1884	26-1334	----	22-1434 Note C	Note D	23-2711 23-2715	TNT120
31-1761 Note A	31-1852	31-1884	26-1329	----	22-1434 Note C	Note D	23-2715	TVM140
31-1761 Note A	31-1852	31-1884	26-2430	----	22-1434 Note C	Note D	23-2713	TVM170
31-1761 Note A	31-1852	31-1884	26-2430	----	22-1434 Note C	Note D	23-2713	TVM195
31-1761 Note A	31-1852	31-1884	26-2430	----	22-1434 Note C	Note D	23-2713	TVM220
31-1761 Note A	31-1852	31-1884	26-1329	----	22-1434 Note C	Note D	23-1444 23-2714	TVS75
31-1761 Note A	31-1852	31-1884	26-1329	----	22-1434 Note C	Note D	23-1444 23-2714	TVS90
31-1761 Note A	31-1852	31-1884	26-1329	----	22-1434 Note C	Note D	23-2711 23-2715	TVS105
31-1761 Note A	31-1852	31-1884	----	----	22-1434 Note C	Note D	23-2711 23-2715	TVS120

REFERENCE NOTES:

- Note A:** Part No. 31-1761 is a tune-up kit for Tec., (Kit included: Points, Condenser, Spark Plug & Flyweel Key)
- Note B:** For Diaphragm models
- Note C:** For Float Models
- Note D:** Please refer to Catalog, for correct application

Order No./Page
Reference

Order No.	Page No.	Order No.	Page No.	Order No.	Page No.	Order No.	Page No.	Order No.	Page No.	Order No.	Page No.
1	39	73	41	154	43	234	65	316	39	394	203
2	39	74	41	155	43	235	56	317	39	395	203
3	39	75	41	156	43	236	56	318	39	399	203
4	39	76	41	157	43	237	56	319	39	400	49
5	34	77	41	158	43	239	65	320	39	401	49
6	40	78	41	159	43	241	65	321	39	402	49
7	38	79	41	160	43	242	62	324	39	403	203
8	41	84	40	161	43	243	56	325	39	404	49
9	40	85	40	162	43	244	66	326	39	405	203
10	41	86	40	163	43	245	74	327	39	406	203
11	41	87	40	164	44	246	74	328	133	408	49
12	43	88	40	165	44	247	74	329	39	409	203
14	42	89	40	166	44	248	74	330	39	411	203
15	49	90	40	167	44	249	74	331	39	412	49
16	44	91	40	168	44	250	74	332	39	413	49
17	44	92	40	170	42	251	74	336	160	414	49
18	44	93	40	171	42	252	74	337	161	415	203
19	44	94	40	172	42	254	171	339	146	416	49
20	41	95	40	173	42	255	88	341	118	417	203
21	43	96	40	174	42	257	78	342	118	418	203
22	45	97	40	175	42	258	78	343	118	420	49
24	43	98	40	176	42	261	78	344	118	421	203
25	43	99	40	177	42	262	78	345	92	422	88
26	44	100	40	178	42	263	78	346	122	423	434
27	44	101	40	179	42	264	78	347	118	424	434
28	44	102	40	180	42	266	78	348	118	430	106
29	44	103	40	181	530	267	85	349	119	433	100
31	666	104	40	182	530	268	84	350	119	435	666
33	40	105	40	183	532	269	78	351	119	436	291
34	40	106	40	184	42	271	99	352	123	438	291
35	40	107	40	187	530	272	99	353	123	440	177
36	40	108	40	188	531	273	96	354	123	442	134
37	40	110	40	189	532	274	96	355	124	450	666
38	40	111	40	190	41	275	96	357	123	455	81
39	40	112	40	191	41	276	96	358	124	456	81
40	40	113	40	192	41	278	96	359	122	457	81
41	39	114	40	193	41	279	97	360	123	458	81
42	40	119	41	194	41	280	101	361	121	461	80
43	40	120	41	195	41	281	101	362	118	462	83
44	40	121	41	200	45	282	101	364	117	463	83
45	40	122	41	201	45	283	101	367	137	464	83
46	40	124	41	202	45	285	97	368	117	465	81
47	40	125	41	203	45	286	99	369	117	466	81
48	40	126	41	204	45	287	96	370	117	467	83
49	40	127	41	205	45	288	96	371	116	468	83
50	40	128	41	206	45	289	97	372	116	469	82
55	38	129	41	207	45	290	97	373	116	470	82
56	38	130	41	208	45	291	171	374	116	471	82
57	38	135	41	209	45	293	144	375	116	472	82
58	38	136	41	210	45	300	92	376	116	473	82
59	38	137	41	211	45	301	93	377	116	474	82
60	38	138	41	212	45	302	118	378	116	475	82
61	38	139	41	213	45	303	118	379	116	476	82
62	38	140	41	214	45	304	125	382	143	478	88
63	38	141	39	216	45	305	125	383	203	480	82
64	38	145	43	217	45	307	89	384	203	481	131
65	38	146	43	218	45	308	88	385	203	482	666
66	38	147	43	219	85	309	88	386	203	483	132
67	44	148	43	223	56	310	179	387	203	484	133
68	44	149	43	228	62	311	39	388	203	485	84
69	44	150	43	229	62	312	39	389	203	486	84
70	44	151	43	230	62	313	39	390	203	487	133
71	41	152	43	231	65	314	39	392	203	488	84
72	41	153	43	233	65	315	179	393	203	489	84

2014
PRICING

Order No.	Page No.	Order No.	Page No.	Order No.	Page No.	Order No.	Page No.	Order No.	Page No.	Order No.	Page No.
490	84	840	117	992	316	1148	423	1275	34	1373	451
669	240	841	117	997	382	1149	422	1276	444	1374	452
670	240	844	389	1006	410	1150	423	1277	439	1375	451
673	240	845	375	1008	410	1151	423	1278	439	1376	451
675	237	848	379	1009	336	1152	431	1279	444	1377	470
714	36	849	379	1010	336	1155	432	1280	444	1378	475
715	263	851	407	1011	409	1156	433	1281	444	1379	475
717	36	852	608	1012	410	1159	432	1282	444	1380	475
718	36	853	143	1014	382	1160	431	1283	440	1381	480
719	36	854	145	1015	382	1162	428	1284	444	1382	480
720	36	855	102	1016	382	1167	430	1285	600	1383	480
721	36	856	197	1017	383	1170	201	1286	34	1384	473
722	36	858	73	1018	383	1171	201	1287	34	1385	474
723	36	859	440	1019	329	1172	201	1289	594	1386	470
724	36	860	608	1020	329	1173	432	1290	600	1387	473
725	36	862	438	1021	385	1174	433	1291	1135	1388	472
726	36	863	160	1022	385	1177	432	1294	594	1389	471
727	36	864	81	1023	386	1178	431	1295	594	1390	479
728	36	865	81	1024	386	1182	431	1296	599	1391	48
729	36	866	59	1026	386	1184	431	1298	600	1392	480
730	36	867	65	1029	385	1187	39	1300	603	1393	480
731	36	868	511	1030	340	1188	39	1301	603	1394	479
732	36	869	240	1031	386	1189	434	1302	603	1395	479
733	36	870	224	1032	386	1190	39	1303	603	1396	452
734	36	871	115	1033	358	1191	175	1304	603	1397	451
735	264	872	115	1034	385	1195	44	1305	603	1398	451
736	264	875	608	1036	337	1196	44	1306	603	1399	48
737	264	876	608	1037	385	1197	44	1308	603	1400	48
738	263	878	123	1038	385	1198	44	1309	603	1401	582
750	266	879	119	1043	331	1199	44	1310	603	1402	582
751	266	880	123	1044	333	1200	44	1311	603	1403	582
752	266	883	118	1053	395	1201	44	1312	603	1404	582
753	266	884	123	1057	379	1202	39	1313	603	1405	571
754	266	891	438	1058	372	1203	39	1317	603	1406	571
755	266	892	438	1060	403	1204	39	1318	604	1407	539
756	266	897	445	1065	360	1205	39	1320	603	1408	542
757	266	898	124	1066	345	1206	39	1321	603	1409	544
758	266	899	124	1074	356	1207	39	1324	608	1411	544
759	266	900	124	1076	398	1208	39	1325	626	1413	539
760	266	903	121	1077	381	1213	39	1326	629	1414	539
761	266	904	123	1085	393	1214	39	1327	629	1415	539
762	266	905	112	1087	402	1215	39	1329	629	1416	539
763	266	906	121	1089	346	1216	39	1330	604	1419	537
764	266	908	119	1091	403	1217	39	1333	630	1420	537
765	266	909	405	1092	403	1218	39	1334	629	1421	544
766	266	910	405	1093	393	1219	39	1337	636	1423	537
767	266	911	328	1098	403	1220	39	1338	608	1424	537
768	266	913	119	1100	345	1221	39	1339	608	1425	528
769	266	916	1221	1103	402	1224	431	1342	508	1426	528
770	266	917	1221	1108	407	1225	431	1344	636	1427	528
771	266	918	1221	1116	399	1226	186	1345	34	1428	528
772	266	921	119	1117	399	1227	186	1346	34	1429	528
773	266	944	34	1122	389	1235	430	1347	34	1430	538
774	266	946	62	1124	389	1237	430	1348	508	1431	537
776	291	951	315	1126	372	1248	424	1349	46	1434	538
777	264	952	315	1127	372	1252	424	1350	514	1435	586
813	133	953	315	1131	404	1261	266	1351	505	1437	586
814	134	954	315	1132	404	1262	285	1352	34	1439	586
820	666	955	315	1136	404	1263	285	1353	34	1440	586
824	417	965	316	1137	422	1264	131	1354	34	1441	556
825	346	977	315	1138	422	1266	131	1357	46	1442	556
827	34	978	315	1139	423	1267	438	1358	498	1444	556
828	118	979	315	1140	422	1268	439	1359	515	1445	556
829	119	980	315	1141	422	1269	439	1368	636	1447	556
830	119	981	315	1143	423	1270	34	1369	452	1448	556
833	119	988	316	1144	423	1272	34	1370	451	1449	579
837	117	990	316	1145	422	1273	439	1371	451	1452	558
838	117	991	316	1147	424	1274	443	1372	451	1453	558

2014

PRICING

Order No.	Page No.	Order No.	Page No.	Order No.	Page No.	Order No.	Page No.	Order No.	Page No.	Order No.	Page No.
1454	558	1619	1176	1936	1058	2211	174	2326	1083	2517	594
1455	560	1621	1176	1937	1058	2212	174	2327	1083	2518	595
1456	562	1627	1174	1938	1058	2213	173	2328	1083	2519	595
1458	562	1634	1175	1939	1063	2214	173	2329	1083	2523	594
1459	562	1640	1174	1940	1057	2215	173	2330	1083	2524	594
1460	562	1644	1174	1941	1057	2216	173	2331	1083	2526	594
1461	558	1646	1174	1942	1057	2218	157	2332	1083	2529	593
1462	558	1656	1174	1943	1057	2219	161	2333	1083	2530	593
1463	558	1660	1175	1944	1058	2220	428	2334	1083	2531	593
1464	560	1680	1176	1945	1073	2221	158	2335	1083	2532	593
1466	558	1686	1177	1946	1073	2222	158	2340	1084	2533	595
1469	571	1688	1177	1947	1073	2223	158	2341	1084	2534	595
1470	571	1689	1177	1948	46	2224	172	2342	1084	2535	594
1471	571	1690	1177	1949	1073	2225	162	2343	1084	2536	594
1474	574	1701	1180	1950	1073	2226	162	2344	1084	2537	595
1478	576	1704	1091	1994	663	2227	522	2345	1084	2538	595
1479	569	1705	1091	1995	663	2228	522	2346	1084	2539	595
1480	569	1706	1091	1997	664	2230	605	2347	1084	2542	589
1482	569	1707	1096	1998	664	2232	514	2348	1084	2543	589
1484	569	1709	1084	1999	663	2233	514	2349	1084	2544	589
1489	570	1720	1099	2000	407	2234	605	2400	42	2547	589
1491	570	1725	1100	2001	408	2235	514	2401	42	2548	590
1493	576	1726	1090	2006	402	2238	175	2402	42	2550	590
1494	576	1727	1128	2007	401	2239	605	2403	42	2551	590
1497	576	1728	1128	2008	315	2240	628	2404	42	2552	594
1498	576	1729	1102	2009	315	2241	608	2405	42	2553	596
1501	579	1731	1090	2012	390	2243	156	2406	42	2554	596
1502	505	1733	1102	2013	392	2268	599	2407	42	2555	590
1503	508	1736	1099	2030	358	2280	440	2409	42	2658	424
1508	567	1738	1099	2051	327	2281	443	2410	42	2661	424
1509	567	1741	1085	2078	399	2282	443	2411	42	2662	421
1510	567	1742	1085	2079	399	2283	444	2412	42	2663	421
1511	567	1743	1090	2081	399	2284	444	2413	42	2668	423
1518	568	1745	1125	2082	399	2285	442	2414	42	2669	423
1519	568	1746	1125	2083	399	2286	441	2415	42	2670	423
1522	579	1747	1125	2094	315	2288	443	2416	42	2671	422
1528	566	1749	1091	2120	375	2289	443	2417	42	2672	422
1529	566	1750	1085	2137	328	2290	443	2418	42	2673	423
1531	557	1751	1085	2147	424	2291	442	2419	42	2675	1057
1532	557	1753	1099	2148	423	2294	438	2421	630	2677	1125
1542	1194	1754	1096	2160	364	2296	438	2422	630	2681	584
1543	532	1755	1102	2162	329	2297	444	2424	630	2682	1087
1544	1191	1756	1125	2164	361	2298	445	2430	629	2683	1087
1547	487	1757	1099	2165	365	2300	443	2436	634	2690	329
1548	489	1758	1099	2166	392	2301	1083	2438	633	2695	35
1550	487	1759	1099	2169	400	2302	1083	2444	633	2699	72
1551	1191	1764	1075	2171	412	2303	1083	2445	633	2700	72
1552	1189	1769	1075	2172	334	2304	1083	2463	630	2701	74
1553	1189	1772	1075	2173	334	2305	1083	2466	557	2702	74
1555	50	1778	1075	2174	337	2306	1083	2470	561	2703	130
1556	1190	1779	1076	2175	263	2307	1083	2471	561	2709	556
1559	1127	1780	1076	2176	263	2308	1083	2472	561	2711	556
1560	1127	1781	1077	2181	263	2310	1083	2473	561	2712	556
1561	1127	1884	1078	2182	263	2311	1083	2475	558	2713	556
1562	1127	1897	1077	2183	263	2312	1083	2476	559	2715	556
1563	1108	1898	1077	2184	272	2313	1083	2479	558	2716	556
1564	1127	1905	1057	2185	272	2314	1083	2500	594	2720	563
1566	1215	1906	1057	2186	267	2315	1083	2501	595	2721	563
1567	490	1908	1057	2187	272	2316	1083	2503	595	2722	563
1568	490	1927	1078	2188	263	2317	1083	2504	591	2723	563
1570	1215	1928	1061	2189	264	2318	1083	2505	591	2732	569
1571	48	1929	1072	2190	264	2319	1083	2506	591	2733	581
1600	1174	1930	1063	2191	264	2320	1083	2507	591	2734	581
1602	1175	1931	1061	2192	264	2321	1083	2509	591	2735	581
1603	1175	1932	1057	2193	264	2322	1083	2510	591	2736	581
1604	1175	1933	1057	2193	264	2322	1083	2510	591	2736	581
1604	1175	1933	1057	2208	174	2323	1083	2512	591	2737	581
1617	1176	1934	1057	2209	174	2324	1083	2513	591	2738	581
1618	1174	1935	1057	2210	174	2325	1083	2516	594	2739	581

2014 PRICING

Order No.	Page No.	Order No.	Page No.	Order No.	Page No.	Order No.	Page No.	Order No.	Page No.	Order No.	Page No.
2740	581	2888	537	2998	97	3220	183	3378	359	3534	583
2741	581	2889	538	2999	98	3221	172	3379	359	3537	576
2743	578	2890	537	3002	1180	3222	146	3380	359	3538	576
2745	574	2892	145	3003	633	3223	172	3381	361	3539	578
2747	571	2903	172	3009	1180	3227	88	3386	377	3540	578
2749	565	2904	183	3010	633	3228	131	3387	377	3541	578
2750	570	2905	203	3011	1180	3229	130	3388	378	3542	580
2753	569	2907	142	3012	1180	3236	264	3389	378	3543	576
2754	573	2908	162	3013	1181	3239	98	3390	391	3544	580
2755	573	2909	162	3016	1180	3240	100	3392	331	3545	575
2757	574	2910	161	3017	1180	3242	161	3393	407	3546	575
2758	573	2915	263	3023	1180	3244	94	3394	409	3547	575
2759	570	2916	263	3024	633	3245	94	3395	409	3548	575
2760	570	2917	264	3025	1180	3246	94	3400	336	3550	579
2761	569	2918	263	3026	633	3247	94	3401	336	3551	579
2762	570	2919	263	3034	1181	3250	48	3402	337	3552	579
2763	570	2922	1062	3037	1180	3251	48	3403	347	3553	578
2764	570	2925	198	3041	1180	3252	48	3404	347	3554	579
2770	566	2926	284	3044	1181	3253	48	3405	408	3555	579
2772	566	2928	284	3045	1181	3254	48	3406	393	3556	580
2773	453	2929	284	3046	1180	3255	48	3407	384	3557	580
2774	473	2931	183	3048	1180	3256	48	3408	381	3644	1191
2775	479	2932	1069	3060	1181	3257	48	3421	415	3648	582
2777	452	2933	172	3061	1181	3258	48	3423	413	3649	582
2778	453	2934	172	3068	1181	3259	48	3424	360	3650	583
2779	475	2935	146	3080	1181	3260	48	3430	392	3651	583
2780	474	2936	145	3082	1180	3261	48	3434	362	3652	583
2781	481	2937	183	3105	489	3264	125	3437	363	3653	583
2782	481	2938	1068	3107	489	3265	125	3438	363	3654	51
2783	480	2939	144	3108	489	3266	123	3441	407	3655	47
2784	479	2940	147	3109	489	3267	123	3442	380	3656	50
2785	481	2941	1061	3111	486	3268	123	3443	392	3657	51
2786	452	2942	1062	3112	490	3269	89	3445	413	3658	51
2788	452	2946	85	3113	488	3270	89	3446	413	3659	51
2789	455	2947	432	3114	491	3271	89	3447	393	3661	51
2790	476	2950	538	3115	491	3274	134	3450	43	3662	50
2791	476	2953	89	3116	494	3275	118	3451	43	3663	51
2792	476	2954	560	3122	486	3276	112	3452	43	3664	51
2797	452	2955	442	3151	47	3277	115	3453	507	3667	1191
2798	478	2956	557	3152	47	3301	171	3454	507	3668	51
2799	478	2957	628	3154	47	3303	146	3455	507	3672	576
2801	499	2958	89	3156	47	3305	146	3456	507	3673	575
2803	463	2959	608	3157	47	3306	172	3457	507	3902	48
2805	461	2961	580	3158	47	3307	161	3458	507	3903	48
2806	452	2964	180	3164	47	3309	182	3459	96	3904	48
2807	462	2965	97	3168	47	3316	285	3460	96	3905	48
2808	462	2966	97	3169	47	3317	284	3461	96	3906	502
2809	462	2970	580	3172	47	3319	1071	3462	512	4013	1127
2811	567	2971	580	3173	47	3320	106	3468	409	4015	1128
2815	567	2972	581	3180	47	3322	328	3505	636	4179	1195
2816	567	2973	581	3190	47	3323	328	3509	636	4180	1195
2828	463	2974	581	3192	47	3326	328	3510	636	4181	1194
2829	478	2976	97	3196	47	3329	337	3512	655	4182	1194
2830	568	2977	97	3197	47	3332	339	3513	636	4183	1191
2833	568	2980	97	3198	47	3336	393	3515	636	4184	1195
2834	568	2983	98	3199	47	3339	361	3518	636	4186	1195
2837	568	2984	98	3200	146	3346	372	3519	636	4197	506
2838	456	2985	99	3201	144	3348	375	3520	636	4198	506
2839	478	2986	99	3202	144	3354	384	3521	636	4199	506
2840	453	2988	98	3205	88	3356	382	3524	404	4200	506
2841	455	2989	97	3207	171	3358	330	3526	404	4209	1194
2842	481	2990	102	3209	144	3361	408	3527	404	4210	1200
2843	481	2991	102	3211	146	3362	411	3528	404	4215	1134
2844	472	2992	102	3213	144	3366	327	3529	404	4216	1134
2884	539	2994	98	3215	182	3372	343	3530	582	4217	1134
2885	539	2995	98	3216	144	3373	338	3531	583	4218	1134
2886	541	2996	98	3217	134	3374	338	3532	583	4219	1134
2887	537	2997	98	3218	183	3377	359	3533	583	4220	1134

2014

PRICING

Order No.	Page No.	Order No.	Page No.	Order No.	Page No.	Order No.	Page No.	Order No.	Page No.	Order No.	Page No.
4221	1134	4803	1107	5064	212	5132	212	5215	213	5554	1227
4222	1134	4813	1108	5065	212	5133	212	5216	213	5555	1227
4223	1134	4817	1127	5066	212	5134	1228	5217	213	5556	1227
4230	1107	4818	1127	5067	212	5150	213	5218	213	5557	1227
4231	1107	4819	1127	5068	212	5151	213	5219	213	5558	1227
4232	1107	4830	1214	5069	212	5152	213	5220	213	5559	1227
4234	1107	4833	1214	5070	212	5153	213	5221	213	5560	1227
4237	1107	4860	1213	5071	212	5154	213	5222	213	5561	1227
4238	1107	4861	1213	5072	212	5155	213	5223	213	5563	1227
4239	1103	4895	1213	5073	212	5156	213	5224	213	5564	1227
4240	1125	4910	1213	5074	212	5157	213	5225	213	5565	1227
4241	1125	4911	1191	5075	212	5158	213	5226	213	5566	1223
4242	1125	4918	1189	5076	212	5159	213	5227	213	5567	1223
4245	1108	4923	1195	5077	212	5160	213	5231	258	5568	1228
4246	1128	4968	604	5078	212	5161	213	5233	257	5569	1227
4248	1108	4969	604	5079	212	5162	213	5235	254	5570	1227
4250	1103	4971	519	5080	212	5163	213	5236	254	5571	1227
4252	1103	4972	519	5081	212	5164	213	5237	242	5572	1227
4253	1103	4995	48	5082	212	5165	213	5238	242	5573	1227
4254	1103	4996	1200	5083	212	5166	213	5241	242	5574	1227
4256	1103	4998	237	5084	212	5167	213	5242	242	5575	1222
4257	1103	4999	240	5085	212	5168	213	5502	1224	5577	1227
4260	1107	5000	211	5086	212	5169	213	5503	1224	5584	1228
4265	1107	5001	211	5087	212	5170	213	5504	1225	5585	1228
4266	1107	5002	211	5088	212	5171	213	5505	1224	5589	1229
4267	1107	5003	211	5089	212	5172	213	5506	1224	5590	1229
4268	1107	5004	211	5090	212	5173	213	5508	1225	5591	1226
4269	1107	5005	211	5091	212	5174	213	5509	1225	5592	1226
4270	1107	5006	211	5092	212	5175	213	5510	1223	5593	1226
4271	1107	5007	211	5093	212	5176	213	5511	1223	5594	1226
4272	1107	5008	211	5094	212	5177	213	5512	1223	5595	1226
4273	1128	5009	211	5095	212	5178	213	5513	1223	5596	1226
4278	425	5010	211	5096	212	5179	213	5514	1224	5597	1226
4279	425	5011	211	5097	212	5180	213	5515	1224	5600	82
4280	425	5012	211	5098	212	5181	213	5517	1229	5601	82
4281	1108	5013	211	5099	212	5182	213	5518	1229	5602	82
4282	1127	5014	211	5100	212	5183	213	5519	1229	5603	82
4284	1141	5015	211	5101	212	5184	213	5520	1226	5604	1227
4287	1141	5016	211	5102	212	5185	213	5521	1225	5605	1227
4288	1141	5017	211	5103	212	5186	213	5522	1223	5606	1227
4292	1141	5018	211	5104	212	5187	213	5523	1223	5607	1227
4294	1141	5019	211	5105	212	5188	213	5524	1224	5608	1227
4297	1141	5020	211	5106	212	5189	213	5525	1224	5609	1227
4299	659	5021	211	5107	212	5190	213	5526	1225	5610	1227
4300	490	5022	211	5108	212	5191	213	5527	1224	5611	1227
4301	1195	5023	211	5109	212	5192	213	5528	1224	5612	1223
4302	1197	5024	211	5110	212	5193	213	5529	1224	5616	69
4307	1176	5025	211	5111	212	5194	213	5531	1223	5618	134
4308	1176	5026	211	5112	212	5195	213	5532	1225	5619	136
4355	1176	5027	211	5113	212	5196	213	5533	1225	5620	92
4359	1176	5028	211	5114	212	5197	213	5534	1226	5703	147
4360	1174	5029	211	5115	212	5198	213	5535	1227	5704	178
4381	1175	5030	211	5116	212	5199	213	5536	1225	5705	178
4387	1174	5031	211	5117	212	5200	213	5537	1223	5706	176
4391	1174	5050	212	5118	212	5201	213	5539	1225	5707	147
4396	1176	5051	212	5119	212	5202	213	5540	1222	5708	180
4400	425	5052	212	5120	212	5203	213	5541	1222	5711	264
4405	425	5053	212	5121	212	5204	213	5543	1222	5712	264
4413	425	5054	212	5122	212	5205	213	5544	1222	5713	147
4414	425	5055	212	5123	212	5206	213	5545	1222	5714	264
4720	1070	5056	212	5124	212	5207	213	5546	1222	5721	146
4791	48	5057	212	5125	212	5208	213	5547	1222	5722	198
4792	48	5058	212	5126	212	5209	213	5548	1227	5801	1128
4793	48	5059	212	5127	212	5210	213	5549	1222	5802	1128
4795	48	5060	212	5128	212	5211	213	5550	1227	5803	93
4796	48	5061	212	5129	212	5212	213	5551	1227	5805	65
4797	48	5062	212	5130	212	5213	213	5552	1227	5810	603
4802	1107	5063	212	5131	212	5214	213	5553	1227	5811	203

2014 PRICING

Order No.	Page No.	Order No.	Page No.	Order No.	Page No.	Order No.	Page No.	Order No.	Page No.	Order No.	Page No.
5812	137	5913	44	6008	380	6126	382	6220	332	6317	324
5820	241	5914	44	6009	379	6127	383	6221	374	6322	314
5821	241	5915	98	6010	392	6128	381	6222	372	6323	359
5823	242	5916	120	6011	374	6129	391	6223	373	6324	335
5827	1096	5917	120	6012	373	6131	363	6224	343	6326	408
5829	1198	5918	120	6013	319	6135	411	6228	396	6327	376
5831	519	5921	636	6014	338	6136	411	6229	396	6328	376
5834	493	5922	636	6017	390	6137	407	6230	396	6329	376
5837	493	5923	636	6018	389	6138	394	6231	396	6330	359
5839	1201	5924	636	6019	381	6139	383	6232	396	6401	360
5840	1201	5925	636	6020	343	6140	382	6235	332	6402	360
5841	46	5927	636	6021	393	6141	339	6236	333	6403	360
5842	46	5928	636	6024	393	6142	390	6237	343	6404	334
5845	1104	5929	636	6025	393	6143	382	6238	342	6406	356
5846	1104	5930	636	6026	334	6144	391	6239	342	6407	356
5847	433	5933	1071	6027	392	6145	390	6240	341	6408	389
5848	138	5934	473	6028	383	6146	390	6245	314	6410	322
5850	595	5935	430	6029	403	6147	342	6246	314	6414	325
5851	596	5936	591	6031	393	6150	363	6247	314	6415	321
5852	595	5939	452	6034	390	6151	363	6248	314	6420	322
5854	595	5940	478	6035	401	6153	365	6250	352	6421	323
5855	594	5941	452	6037	331	6160	391	6251	411	6422	324
5856	594	5945	122	6038	332	6161	389	6252	376	6423	387
5857	596	5947	122	6039	391	6162	391	6253	375	6424	387
5858	595	5948	120	6042	383	6166	391	6254	328	6425	388
5859	589	5949	291	6044	314	6167	359	6255	376	6426	322
5860	589	5950	291	6045	314	6168	360	6256	410	6428	363
5861	463	5951	94	6046	314	6169	413	6257	412	6430	364
5862	478	5952	94	6052	314	6170	413	6258	412	6431	364
5863	473	5955	478	6053	314	6171	362	6259	412	6432	415
5864	486	5957	425	6060	328	6172	421	6261	422	6433	415
5865	246	5959	425	6066	338	6173	378	6262	332	6434	416
5867	246	5961	267	6068	338	6174	392	6263	329	6435	370
5869	263	5962	267	6069	338	6175	349	6264	330	6436	369
5870	263	5963	267	6075	340	6176	413	6265	378	6437	329
5873	100	5964	267	6077	343	6177	413	6267	407	6438	387
5874	98	5965	267	6078	343	6178	350	6270	409	6439	387
5875	557	5966	267	6081	340	6180	334	6271	412	6440	1214
5876	629	5967	267	6082	341	6181	360	6272	337	6441	344
5879	267	5968	267	6083	344	6183	337	6275	409	6442	343
5880	267	5969	267	6084	346	6184	409	6276	422	6445	328
5881	267	5970	267	6086	345	6185	400	6277	402	6448	387
5882	267	5971	267	6087	345	6186	375	6278	358	6450	387
5883	267	5973	267	6088	345	6187	408	6279	347	6457	383
5884	267	5974	267	6092	364	6189	332	6284	417	6458	364
5885	267	5975	267	6093	365	6190	331	6285	361	6460	325
5886	267	5976	267	6096	383	6192	374	6286	394	6465	410
5887	267	5977	267	6099	394	6193	372	6290	353	6466	365
5889	1134	5978	267	6101	346	6194	319	6291	350	6467	415
5890	83	5979	267	6104	327	6195	330	6294	323	6468	394
5891	118	5980	267	6105	331	6196	330	6295	325	6470	389
5894	121	5982	267	6106	333	6197	401	6296	322	6471	392
5895	1109	5983	267	6107	421	6203	361	6297	326	6472	400
5896	47	5984	267	6108	403	6204	361	6298	322	6475	390
5897	44	5985	267	6109	403	6205	329	6299	324	6476	391
5898	1073	5986	267	6110	402	6206	373	6300	322	6477	421
5899	103	5988	290	6111	390	6207	379	6301	326	6479	375
5900	103	5989	290	6112	390	6208	377	6302	326	6480	374
5901	103	5991	272	6113	389	6209	378	6303	324	6481	355
5903	43	5997	267	6115	338	6210	416	6305	50	6482	327
5904	43	5999	198	6116	338	6212	384	6306	50	6483	327
5905	43	6000	46	6118	412	6213	361	6308	324	6484	332
5906	494	6001	412	6119	390	6214	360	6309	322	6485	332
5907	494	6002	410	6120	330	6215	392	6311	324	6488	368
5909	483	6003	382	6122	375	6216	352	6312	321	6489	366
5910	44	6004	383	6123	330	6217	351	6314	322	6491	321
5911	44	6005	382	6124	331	6218	331	6315	323	6495	329
5912	44	6006	382	6125	332	6219	330	6316	321	6496	321

2014

PRICING

Order No.	Page No.	Order No.	Page No.	Order No.	Page No.	Order No.	Page No.	Order No.	Page No.	Order No.	Page No.
6500	366	6605	467	6690	461	6768	566	6865	639	6991	481
6502	237	6606	467	6691	461	6769	566	6866	585	6992	64
6503	237	6607	272	6692	461	6772	559	6871	240	6994	642
6504	237	6608	272	6693	461	6773	558	6872	240	6997	272
6505	237	6616	505	6694	482	6774	559	6874	240	7000	642
6507	238	6617	505	6695	482	6775	562	6876	237	7002	642
6508	238	6618	505	6696	482	6777	562	6877	593	7003	642
6509	238	6619	505	6697	482	6780	606	6878	559	7004	642
6510	442	6620	505	6698	482	6781	1075	6880	93	7010	365
6511	486	6621	574	6699	482	6782	345	6881	659	7015	1060
6513	133	6622	522	6700	482	6783	586	6882	659	7016	1088
6514	454	6623	522	6701	482	6784	346	6883	660	7017	93
6515	479	6624	522	6702	482	6785	322	6884	517	7018	93
6516	473	6625	130	6703	482	6787	363	6885	175	7019	589
6517	463	6626	428	6704	482	6788	422	6886	175	7020	1070
6518	463	6627	125	6705	465	6790	343	6887	180	7021	596
6519	463	6628	371	6706	465	6793	432	6888	1069	7022	121
6521	575	6629	212	6707	462	6794	561	6889	428	7023	121
6522	582	6630	212	6708	462	6795	561	6890	182	7025	122
6523	576	6631	212	6709	99	6796	561	6891	160	7026	121
6524	451	6632	212	6710	599	6797	561	6892	160	7027	121
6525	576	6633	212	6711	45	6798	562	6893	1203	7028	122
6526	575	6634	212	6712	45	6799	561	6896	240	7029	122
6528	582	6635	212	6713	45	6800	561	6898	240	7030	122
6529	582	6636	212	6714	45	6801	562	6900	222	7031	122
6530	636	6637	212	6715	45	6802	561	6901	222	7033	122
6531	575	6638	212	6716	45	6803	561	6902	222	7036	482
6532	290	6639	212	6717	45	6804	562	6903	237	7037	482
6534	135	6640	212	6718	45	6805	561	6904	238	7038	482
6535	133	6641	212	6720	563	6806	562	6906	233	7039	482
6536	133	6642	212	6721	563	6807	562	6907	235	7040	482
6540	118	6643	213	6722	563	6813	201	6908	235	7041	482
6541	118	6644	213	6723	563	6815	45	6909	107	7042	462
6542	135	6645	213	6725	563	6816	45	6913	105	7043	462
6545	1061	6646	213	6726	563	6817	45	6914	105	7044	462
6548	46	6647	213	6727	563	6818	45	6915	105	7045	462
6549	46	6648	213	6728	371	6819	45	6916	106	7046	474
6550	46	6649	213	6732	565	6820	348	6917	103	7047	474
6551	46	6650	213	6734	565	6821	348	6918	104	7049	122
6552	46	6651	213	6736	565	6832	121	6919	103	7050	454
6553	479	6652	213	6737	374	6833	334	6926	77	7051	456
6567	463	6653	213	6738	374	6834	348	6927	77	7052	465
6568	1197	6654	213	6739	564	6835	589	6928	77	7055	1211
6569	1130	6655	213	6740	564	6836	242	6929	483	7057	1211
6571	124	6656	213	6741	564	6837	258	6930	92	7059	1211
6572	264	6657	56	6742	564	6838	233	6931	92	7067	1216
6573	133	6658	56	6743	564	6839	233	6932	591	7068	1216
6575	453	6659	475	6744	564	6840	233	6933	593	7081	518
6576	47	6660	475	6745	564	6841	233	6934	592	7083	518
6577	50	6661	1109	6746	564	6842	236	6935	592	7085	1217
6578	50	6662	1059	6747	564	6843	233	6949	235	7086	1217
6579	51	6663	1130	6748	564	6844	233	6950	233	7087	1217
6580	157	6668	1126	6749	564	6845	235	6953	125	7094	453
6581	156	6670	163	6750	564	6847	479	6954	125	7095	453
6583	476	6671	163	6751	564	6848	481	6965	515	7096	1130
6584	476	6672	163	6753	564	6849	481	6966	485	7097	1231
6585	477	6673	608	6755	564	6850	554	6968	659	7115	179
6589	66	6675	100	6756	564	6852	554	6969	242	7116	179
6593	512	6676	483	6757	566	6854	554	6970	240	7117	179
6594	118	6677	483	6758	566	6855	554	6971	576	7118	179
6595	589	6678	483	6760	358	6857	555	6972	258	7119	429
6596	1102	6680	484	6761	566	6858	555	6973	171	7124	290
6599	1097	6681	483	6762	421	6859	555	6974	171	7125	157
6600	483	6684	461	6763	566	6860	555	6975	659	7126	264
6601	455	6686	461	6764	421	6861	555	6985	485	7127	263
6602	453	6687	461	6765	566	6862	555	6986	493	7128	240
6603	453	6688	461	6766	345	6863	147	6988	486	7129	240
6604	453	6689	461	6767	566	6864	148	6989	465	7141	648

2014 PRICING

Order No.	Page No.	Order No.	Page No.	Order No.	Page No.	Order No.	Page No.	Order No.	Page No.	Order No.	Page No.
7143	123	7234	578	7434	214	7512	215	7592	216	7672	238
7144	125	7235	660	7435	214	7513	215	7593	216	7673	238
7145	124	7236	508	7436	214	7514	215	7594	216	7674	135
7146	124	7238	513	7437	214	7515	215	7595	216	7675	1064
7147	124	7239	443	7438	214	7516	215	7596	216	7678	93
7148	591	7241	135	7439	214	7517	215	7597	216	7679	491
7149	591	7245	238	7440	214	7518	215	7598	216	7680	80
7150	591	7246	582	7441	214	7519	215	7599	216	7681	80
7153	589	7247	582	7442	214	7520	215	7600	216	7684	1212
7154	182	7248	582	7443	214	7521	215	7601	216	7686	1212
7155	197	7249	175	7444	214	7522	215	7602	216	7689	1212
7156	195	7251	201	7445	214	7523	215	7603	216	7694	122
7157	264	7255	93	7446	214	7524	215	7604	216	7695	122
7158	1231	7256	1100	7447	214	7525	215	7605	216	7696	122
7159	498	7258	146	7448	214	7526	215	7606	216	7699	121
7160	485	7259	519	7449	214	7527	215	7607	216	7700	121
7162	134	7260	124	7450	214	7528	215	7608	216	7709	97
7165	481	7261	124	7451	214	7529	215	7609	216	7711	276
7166	134	7262	142	7452	214	7530	215	7610	216	7712	460
7168	580	7265	1087	7453	214	7531	215	7611	216	7713	462
7169	233	7266	1087	7454	214	7532	215	7612	216	7714	465
7171	241	7278	292	7455	214	7533	215	7613	216	7715	482
7172	515	7279	143	7466	215	7534	215	7614	216	7716	147
7173	577	7280	1062	7467	215	7535	215	7615	216	7717	60
7176	264	7281	182	7468	215	7536	215	7616	216	7720	144
7177	89	7282	182	7469	215	7537	215	7617	216	7721	528
7178	134	7283	183	7470	215	7538	215	7618	216	7722	610
7179	1061	7284	183	7471	215	7539	215	7619	216	7723	604
7180	271	7285	114	7472	215	7540	215	7620	216	7724	1057
7181	162	7286	1076	7473	215	7541	215	7621	216	7725	460
7182	264	7287	1076	7474	215	7542	215	7622	216	7726	462
7184	222	7288	1076	7475	215	7543	215	7623	216	7727	442
7185	591	7289	655	7476	215	7544	215	7624	216	7728	85
7186	591	7290	605	7477	215	7545	215	7625	216	7729	1120
7187	591	7293	519	7478	215	7546	215	7626	216	7730	510
7188	592	7294	518	7479	215	7547	215	7627	216	7731	1095
7189	592	7295	518	7480	215	7548	215	7628	216	7732	480
7190	591	7296	1217	7481	215	7549	215	7629	216	7733	42
7191	589	7297	444	7482	215	7550	215	7630	216	7735	42
7200	429	7298	500	7483	215	7551	215	7631	216	7736	42
7201	122	7299	518	7484	215	7552	215	7632	216	7737	42
7202	122	7300	444	7485	215	7553	215	7633	216	7738	42
7203	48	7301	605	7486	215	7554	215	7634	216	7739	42
7204	43	7302	656	7487	215	7555	215	7635	216	7740	42
7205	46	7307	604	7488	215	7556	215	7636	216	7741	42
7206	490	7311	590	7489	215	7557	215	7637	216	7743	42
7207	493	7312	131	7490	215	7570	216	7638	216	7744	117
7208	490	7318	647	7491	215	7571	216	7639	216	7745	117
7209	476	7319	647	7492	215	7572	216	7640	216	7746	480
7210	132	7324	648	7493	215	7573	216	7641	216	7747	157
7211	577	7327	604	7494	215	7574	216	7642	216	7761	1133
7212	179	7328	118	7495	215	7575	216	7643	216	7762	1126
7213	557	7329	83	7496	215	7576	216	7644	216	7763	1098
7214	453	7407	517	7497	215	7577	216	7645	216	7764	1098
7215	1195	7408	517	7498	215	7578	216	7646	216	7765	197
7216	1197	7410	606	7499	215	7579	216	7647	216	7766	1228
7217	1192	7411	75	7500	215	7580	216	7648	216	7767	1215
7218	1198	7417	283	7501	215	7581	216	7649	216	7768	48
7220	589	7419	476	7502	215	7582	216	7650	216	7769	48
7222	589	7420	477	7503	215	7583	216	7651	216	7770	1207
7224	589	7421	577	7504	215	7584	216	7652	216	7771	1214
7225	589	7422	591	7505	215	7585	216	7653	216	7772	1207
7227	589	7423	592	7506	215	7586	216	7654	216	7773	1214
7229	590	7429	214	7507	215	7587	216	7655	216	7775	1212
7230	590	7430	214	7508	215	7588	216	7656	216	7776	1212
7231	589	7431	214	7509	215	7589	216	7657	216	7777	1070
7232	590	7432	214	7510	215	7590	216	7658	216	7778	453
7233	515	7433	214	7511	215	7591	216	7659	216	7779	176

2014

PRICING

Order No.	Page No.	Order No.	Page No.	Order No.	Page No.	Order No.	Page No.	Order No.	Page No.	Order No.	Page No.
7780	137	7892	595	8000	513	8129	50	8226	575	8324	48
7781	577	7893	595	8001	440	8130	50	8227	529	8327	474
7782	182	7894	260	8002	440	8131	50	8228	582	8328	474
7783	515	7897	642	8003	440	8132	50	8229	577	8329	470
7785	471	7905	75	8004	445	8133	50	8230	1127	8330	480
7786	287	7906	75	8005	263	8134	50	8231	1127	8331	458
7787	91	7908	658	8006	120	8135	50	8232	1127	8332	458
7788	90	7909	658	8007	120	8136	50	8233	1127	8333	486
7789	254	7913	242	8016	1101	8137	50	8234	1127	8334	486
7790	254	7916	483	8046	537	8139	50	8235	467	8335	487
7791	254	7917	132	8047	532	8140	50	8238	487	8337	47
7793	581	7918	263	8049	567	8141	50	8239	487	8338	1092
7794	581	7919	162	8050	567	8142	50	8240	148	8340	1197
7795	580	7920	89	8051	1076	8143	50	8242	569	8341	1197
7798	579	7922	1064	8052	89	8144	50	8243	569	8342	1197
7799	579	7925	1185	8053	538	8145	50	8244	105	8343	179
7800	579	7926	491	8054	592	8146	50	8245	264	8351	131
7801	578	7927	610	8055	1177	8147	50	8247	82	8358	595
7803	583	7928	659	8058	1177	8148	50	8248	82	8364	529
7804	1063	7929	659	8061	1177	8149	50	8249	82	8365	1194
7810	429	7930	610	8062	1177	8150	50	8250	1231	8366	147
7811	123	7931	517	8069	633	8151	50	8255	537	8369	581
7812	66	7932	517	8071	633	8152	50	8259	1195	8370	246
7813	264	7933	519	8072	633	8153	50	8260	1197	8372	175
7814	1110	7934	1072	8073	592	8154	51	8261	1197	8373	264
7821	124	7935	1072	8075	241	8155	51	8262	99	8375	131
7822	124	7937	264	8076	141	8156	51	8263	99	8376	116
7823	125	7939	577	8077	132	8157	51	8264	108	8377	116
7824	124	7940	531	8080	495	8159	51	8265	91	8379	116
7825	124	7941	576	8081	1098	8160	51	8266	91	8380	529
7826	125	7942	575	8082	122	8161	51	8276	91	8385	314
7827	118	7943	575	8083	122	8187	186	8278	114	8386	505
7828	124	7944	575	8084	121	8188	186	8279	474	8389	425
7829	1095	7945	575	8086	46	8190	175	8282	443	8396	1214
7836	144	7946	575	8087	46	8191	1098	8283	494	8397	1214
7837	250	7948	531	8088	46	8192	666	8284	442	8398	1214
7838	241	7949	453	8089	46	8193	291	8285	514	8399	1214
7839	143	7950	131	8090	46	8194	119	8286	609	8400	1214
7841	465	7951	538	8091	246	8196	108	8287	1216	8401	1211
7842	38	7952	241	8092	246	8197	111	8288	610	8404	140
7846	38	7961	62	8093	277	8198	131	8289	610	8405	487
7847	38	7963	576	8098	108	8199	131	8293	70	8406	666
7848	38	7964	577	8099	90	8200	84	8294	70	8407	666
7849	38	7965	576	8101	47	8201	107	8295	162	8408	140
7850	38	7966	577	8102	47	8202	1239	8296	91	8409	140
7851	38	7967	538	8103	47	8203	1239	8297	106	8410	491
7852	38	7968	538	8104	47	8204	1239	8298	107	8411	179
7854	425	7969	538	8105	47	8205	1239	8299	106	8412	176
7855	425	7971	532	8106	47	8206	1239	8300	106	8413	569
7857	425	7972	532	8107	47	8207	89	8301	161	8414	575
7860	425	7973	534	8109	47	8208	532	8302	163	8415	63
7861	264	7974	63	8110	47	8209	532	8303	163	8416	63
7862	425	7975	63	8111	47	8210	137	8304	175	8417	60
7863	425	7976	1063	8112	47	8211	148	8305	147	8418	177
7864	658	7978	263	8113	51	8212	529	8306	146	8419	180
7867	440	7979	460	8114	47	8213	528	8308	175	8420	140
7868	591	7980	460	8115	47	8214	105	8309	88	8421	557
7869	133	7981	285	8116	47	8215	105	8310	106	8422	557
7871	1216	7982	115	8117	47	8216	105	8311	106	8425	221
7872	1216	7983	263	8119	47	8217	642	8313	161	8426	221
7876	1208	7986	284	8120	47	8218	642	8314	161	8427	221
7877	455	7991	284	8121	47	8219	642	8316	1125	8428	221
7879	454	7993	284	8122	47	8220	642	8318	139	8429	221
7880	455	7994	284	8123	47	8221	642	8319	139	8430	221
7882	517	7995	284	8124	47	8222	642	8320	198	8431	221
7883	517	7997	492	8125	47	8223	642	8321	198	8432	221
7885	180	7998	496	8126	50	8224	105	8322	137	8433	138
7886	180	7999	515	8127	50	8225	581	8323	48	8434	141

2014 PRICING

Order No.	Page No.	Order No.	Page No.	Order No.	Page No.	Order No.	Page No.	Order No.	Page No.	Order No.	Page No.
8437	132	8525	131	8608	666	8714	255	8821	567	8952	1195
8438	140	8526	518	8609	666	8716	493	8822	567	8953	586
8439	140	8527	518	8610	667	8717	250	8824	1110	8955	586
8440	140	8528	492	8611	667	8720	335	8825	556	8958	51
8441	140	8529	498	8612	48	8721	523	8826	563	8959	51
8442	238	8530	62	8618	1119	8722	523	8827	559	8960	63
8443	238	8531	1102	8620	667	8726	133	8828	1228	8961	63
8444	238	8532	658	8621	667	8731	248	8829	292	8962	99
8445	146	8533	496	8622	667	8733	248	8830	181	8963	589
8446	147	8534	498	8625	156	8735	485	8831	132	8964	590
8447	178	8535	519	8626	58	8737	517	8832	59	8965	282
8448	178	8539	121	8627	1221	8741	176	8833	72	8966	470
8450	558	8540	122	8628	1221	8746	575	8834	569	8967	197
8452	563	8541	122	8631	484	8747	238	8861	132	8968	197
8453	433	8542	118	8632	94	8749	599	8863	134	8969	1079
8454	433	8543	1087	8635	1228	8750	599	8864	109	8970	90
8455	433	8545	1102	8636	118	8751	51	8865	109	8971	136
8456	121	8546	511	8637	627	8752	428	8866	109	8972	238
8457	122	8547	291	8638	655	8753	428	8867	109	8976	1135
8458	425	8548	184	8640	435	8755	182	8869	130	8977	1134
8459	425	8549	184	8644	664	8760	250	8875	1085	8978	663
8460	425	8550	111	8645	506	8761	232	8882	591	8979	663
8461	425	8551	111	8647	201	8762	221	8883	591	8981	116
8462	222	8552	108	8648	200	8764	72	8887	241	8982	116
8463	222	8553	108	8649	200	8765	66	8888	122	8983	116
8464	223	8554	594	8651	180	8766	57	8896	121	8984	147
8465	222	8555	660	8652	180	8767	257	8897	46	8985	162
8472	94	8556	660	8653	180	8768	257	8898	93	8988	103
8473	568	8557	661	8654	144	8769	628	8899	516	8989	1240
8474	568	8558	661	8656	135	8770	89	8900	46	8990	1240
8475	568	8561	556	8657	281	8771	1076	8901	184	8991	1240
8476	148	8562	567	8658	491	8775	599	8903	461	8992	1240
8478	263	8563	77	8660	160	8776	599	8904	461	8993	1229
8479	184	8564	77	8661	137	8778	1087	8905	462	8994	139
8480	455	8565	77	8662	465	8779	1087	8906	461	8995	139
8481	456	8566	77	8664	138	8780	232	8907	461	8996	139
8482	455	8567	77	8665	94	8781	223	8910	1059	8998	140
8483	455	8568	71	8666	663	8783	145	8911	1059	8999	140
8485	142	8569	656	8668	141	8784	222	8915	120	9000	140
8487	226	8570	655	8670	141	8785	479	8917	121	9002	140
8488	135	8571	592	8671	161	8786	1074	8918	120	9003	140
8489	80	8572	661	8673	75	8789	584	8919	120	9006	138
8490	454	8573	113	8674	529	8790	559	8920	122	9007	138
8491	46	8574	113	8675	511	8791	661	8923	120	9008	138
8493	177	8575	112	8678	510	8792	563	8924	118	9009	138
8494	109	8577	109	8679	510	8793	563	8925	118	9010	1102
8495	592	8579	109	8680	436	8794	558	8926	533	9011	138
8496	591	8580	109	8682	173	8795	558	8927	102	9013	1091
8497	592	8581	109	8684	114	8796	147	8928	102	9014	247
8498	627	8582	118	8686	1208	8797	577	8929	102	9016	247
8501	667	8585	485	8687	121	8798	260	8930	102	9018	1109
8502	1126	8586	141	8688	121	8799	599	8931	102	9019	1096
8503	171	8587	285	8689	162	8800	57	8932	102	9020	1100
8504	171	8588	264	8690	162	8801	436	8934	514	9023	1097
8505	465	8589	491	8691	1084	8802	436	8935	514	9024	502
8506	74	8590	394	8692	1078	8803	242	8936	513	9025	502
8507	132	8591	533	8693	1078	8805	246	8938	1221	9026	516
8509	245	8595	506	8694	123	8808	242	8939	120	9027	1101
8510	222	8596	1058	8695	1242	8809	242	8940	1085	9028	1103
8511	222	8597	1058	8699	1242	8810	242	8941	119	9029	1101
8512	222	8598	1058	8703	1242	8811	242	8943	1071	9030	1101
8513	148	8599	1058	8704	1242	8812	246	8944	85	9031	1096
8514	119	8600	1058	8705	1242	8814	456	8945	115	9034	1090
8516	223	8601	1063	8706	143	8815	454	8946	559	9035	327
8518	660	8602	264	8707	143	8816	93	8947	563	9036	1092
8519	491	8603	92	8711	250	8818	487	8949	119	9037	1092
8521	660	8604	1087	8712	467	8819	260	8950	181	9038	1103
8522	148	8607	48	8713	491	8820	260	8951	571	9039	1103

2014

PRICING

Order No.	Page No.	Order No.	Page No.	Order No.	Page No.	Order No.	Page No.	Order No.	Page No.	Order No.	Page No.
9041	138	9143	174	9245	471	9335	424	9419	1235	9501	110
9042	1128	9145	194	9246	1239	9336	223	9420	1235	9502	144
9043	655	9146	497	9248	1058	9337	223	9421	1235	9503	1239
9044	145	9147	497	9249	1058	9338	132	9422	1235	9505	630
9045	610	9148	271	9250	523	9339	643	9424	1236	9506	464
9046	145	9150	174	9251	1087	9340	603	9425	1236	9507	608
9047	657	9151	113	9252	1090	9341	603	9426	1236	9508	291
9048	516	9153	198	9253	1090	9342	603	9427	1236	9510	163
9049	75	9154	121	9254	1090	9343	603	9428	1236	9511	163
9050	1090	9155	113	9257	246	9344	603	9429	1236	9512	158
9051	1090	9156	102	9260	112	9345	603	9430	1236	9513	175
9052	1091	9157	636	9261	571	9346	232	9431	1236	9514	285
9053	1091	9158	1059	9262	276	9347	603	9432	1236	9515	197
9054	1090	9159	174	9263	83	9348	603	9433	1236	9516	196
9055	1091	9160	136	9265	83	9349	603	9434	1236	9517	196
9057	1108	9161	599	9266	83	9350	603	9435	1236	9518	195
9062	1101	9162	658	9267	83	9351	603	9436	1236	9519	184
9063	623	9164	516	9268	172	9352	603	9437	1236	9520	184
9064	623	9166	1060	9272	661	9353	629	9438	1236	9521	184
9065	605	9167	456	9273	456	9354	629	9439	1236	9526	630
9066	485	9168	454	9274	141	9358	1078	9440	1236	9527	630
9067	485	9169	64	9275	141	9359	1097	9441	1236	9528	630
9068	656	9170	329	9276	141	9361	484	9442	1236	9530	1088
9069	1091	9171	409	9283	120	9362	627	9443	1237	9531	434
9070	1091	9172	369	9284	197	9363	627	9444	1237	9532	1088
9071	1102	9173	369	9285	196	9366	643	9446	1236	9533	478
9072	1090	9176	417	9286	195	9367	222	9447	1237	9534	629
9073	1096	9180	609	9287	196	9368	223	9448	1237	9535	592
9074	1095	9181	655	9288	196	9369	1064	9449	1133	9536	593
9076	1119	9182	655	9289	51	9370	599	9450	1133	9537	292
9077	1099	9184	173	9292	465	9371	597	9451	1133	9538	592
9078	102	9185	120	9293	1076	9372	53	9452	1113	9539	592
9086	1102	9186	120	9294	511	9373	53	9453	1115	9540	1076
9087	1100	9187	120	9295	172	9374	53	9454	1115	9541	175
9089	1129	9188	120	9296	177	9375	186	9457	1132	9542	283
9091	1125	9189	120	9297	1200	9376	269	9459	1119	9543	283
9098	1132	9190	120	9298	1201	9377	269	9460	1119	9544	279
9099	1093	9195	84	9299	642	9378	275	9463	136	9546	283
9102	1099	9199	1202	9300	642	9379	275	9464	484	9549	120
9103	1099	9200	478	9301	643	9380	484	9465	324	9550	459
9108	211	9201	119	9303	133	9381	573	9466	52	9551	1098
9109	145	9202	118	9304	456	9382	643	9467	52	9552	1098
9114	605	9204	1078	9305	1085	9383	642	9468	52	9558	533
9115	1240	9205	1080	9307	173	9385	597	9469	52	9559	107
9117	141	9206	1080	9308	173	9388	597	9470	52	9561	516
9118	639	9207	1080	9309	173	9392	597	9471	52	9562	516
9119	234	9208	1079	9311	173	9393	1120	9473	460	9563	137
9120	234	9209	1080	9312	223	9394	661	9474	1097	9564	1221
9121	270	9210	1079	9313	239	9395	643	9477	51	9565	160
9122	1228	9212	1126	9315	513	9396	83	9478	51	9566	68
9125	73	9214	1079	9316	517	9397	292	9479	51	9567	58
9126	69	9215	1126	9317	81	9400	1088	9480	236	9568	58
9127	57	9216	508	9318	81	9401	1088	9481	238	9569	60
9128	57	9217	508	9319	81	9402	1088	9482	235	9570	233
9129	57	9218	628	9320	81	9403	1088	9483	241	9571	458
9130	60	9219	628	9321	81	9404	172	9484	82	9572	133
9131	60	9220	629	9322	81	9405	596	9485	82	9573	113
9132	60	9221	629	9323	119	9406	1235	9487	349	9574	184
9133	60	9224	643	9324	118	9408	1236	9488	609	9575	184
9134	60	9226	643	9325	118	9409	1236	9489	174	9576	84
9135	66	9227	498	9326	130	9411	1235	9492	53	9577	441
9136	74	9228	391	9327	147	9412	1235	9493	592	9578	441
9137	502	9229	323	9328	135	9413	1235	9494	122	9579	1231
9138	502	9230	324	9329	177	9414	1235	9495	121	9580	1233
9139	502	9232	162	9330	1061	9415	1235	9496	76	9581	234
9140	502	9237	1088	9331	1060	9416	1235	9498	1177	9583	468
9141	174	9238	1088	9332	636	9417	1235	9499	1177	9584	464
9142	174	9244	1200	9334	1075	9418	1235	9500	121	9585	464

2014

PRICING

Order No.	Page No.	Order No.	Page No.	Order No.	Page No.	Order No.	Page No.	Order No.	Page No.	Order No.	Page No.
9586	435	9665	1066	9749	190	9838	570	9922	1210	10004	1130
9587	281	9666	1066	9750	190	9839	570	9923	1210	10005	224
9588	281	9667	1069	9752	91	9840	61	9924	1210	10006	509
9589	282	9668	1063	9753	275	9841	465	9925	1211	10007	181
9590	282	9671	101	9755	277	9842	572	9926	1211	10008	223
9591	454	9672	101	9756	277	9843	572	9927	1211	10009	235
9592	454	9673	101	9757	91	9844	286	9928	492	10010	244
9593	596	9674	101	9758	290	9846	269	9929	1211	10011	244
9594	639	9675	101	9763	112	9847	234	9930	46	10013	176
9595	639	9676	101	9764	222	9848	223	9931	46	10014	176
9596	639	9677	101	9765	222	9849	269	9932	234	10015	135
9597	639	9678	101	9767	223	9850	643	9935	234	10016	113
9599	645	9679	57	9768	223	9851	643	9937	135	10017	142
9600	288	9680	57	9769	222	9852	465	9938	404	10018	513
9601	288	9681	59	9770	277	9853	1060	9939	1132	10019	432
9602	288	9682	59	9771	276	9854	612	9940	1132	10020	595
9603	513	9683	59	9772	276	9855	61	9941	404	10021	590
9604	513	9684	62	9773	1093	9856	290	9942	404	10022	243
9605	112	9685	62	9774	1112	9861	241	9943	404	10023	243
9606	143	9686	76	9776	492	9862	247	9944	137	10024	243
9607	519	9687	75	9777	1064	9863	248	9945	222	10025	243
9608	492	9693	64	9778	585	9864	275	9947	109	10026	243
9609	492	9694	72	9780	611	9865	283	9948	51	10027	243
9611	464	9695	72	9781	611	9867	203	9949	189	10029	243
9612	99	9696	199	9782	573	9868	278	9950	189	10030	243
9613	143	9697	223	9783	573	9871	596	9951	135	10031	243
9614	459	9698	223	9784	572	9872	594	9952	84	10032	244
9615	459	9700	518	9785	570	9873	595	9953	461	10033	244
9616	459	9701	139	9786	570	9874	176	9954	489	10034	244
9617	610	9702	139	9787	291	9875	99	9955	488	10035	243
9618	123	9704	1104	9788	1089	9876	567	9956	488	10036	244
9619	123	9705	1104	9790	489	9877	567	9957	491	10037	247
9620	123	9706	1104	9792	232	9878	567	9958	491	10038	247
9621	123	9707	1104	9793	276	9879	567	9959	376	10039	248
9622	1063	9708	281	9794	276	9880	567	9960	636	10040	248
9623	1060	9709	142	9795	479	9881	122	9961	639	10041	248
9625	660	9710	647	9796	612	9882	355	9962	1229	10042	239
9627	488	9711	120	9797	612	9883	325	9964	224	10043	255
9630	1217	9712	238	9798	612	9884	321	9965	585	10044	255
9631	1217	9713	239	9799	612	9885	321	9966	120	10045	256
9633	1216	9714	239	9800	617	9886	422	9967	319	10046	256
9634	1216	9715	239	9801	618	9888	120	9968	319	10047	256
9635	1217	9716	173	9802	617	9890	595	9969	319	10048	256
9636	1216	9717	173	9803	108	9891	271	9970	321	10049	256
9637	1209	9718	158	9804	108	9892	130	9971	534	10050	256
9638	1209	9719	138	9805	292	9895	274	9972	159	10051	258
9640	1210	9720	1077	9806	291	9896	389	9973	1097	10052	226
9641	1210	9721	199	9807	51	9897	391	9974	612	10053	533
9642	1210	9722	199	9809	110	9898	109	9975	618	10054	533
9643	1210	9728	468	9810	332	9899	109	9976	617	10055	537
9644	1208	9730	592	9811	584	9900	235	9977	616	10060	639
9645	1208	9731	572	9812	618	9901	235	9979	620	10061	639
9648	1214	9732	573	9813	618	9903	236	9980	620	10062	639
9649	1214	9733	1070	9814	619	9904	477	9981	620	10063	639
9650	515	9734	590	9815	429	9905	1109	9982	1129	10064	142
9652	516	9735	590	9820	567	9906	182	9983	1129	10066	390
9653	473	9736	590	9821	567	9907	330	9985	623	10067	638
9654	1063	9737	590	9822	567	9908	172	9986	411	10068	638
9655	1060	9738	590	9826	567	9909	490	9987	357	10069	638
9656	1064	9739	590	9827	567	9910	164	9988	349	10070	638
9657	1064	9741	425	9829	568	9911	164	9989	474	10071	351
9658	1066	9742	1070	9830	568	9912	164	9990	620	10072	323
9659	1066	9743	425	9831	568	9913	164	9992	142	10073	324
9660	1066	9744	120	9832	566	9914	643	9993	593	10074	376
9661	1068	9745	145	9833	566	9917	1209	9994	238	10075	111
9662	1068	9746	145	9834	566	9918	1209	9995	238	10076	224
9663	1066	9747	137	9835	1093	9919	1209	9997	617	10077	224
9664	1066	9748	477	9837	566	9921	1210	9998	624	10078	223

2014

PRICING

Order No.	Page No.	Order No.	Page No.	Order No.	Page No.	Order No.	Page No.	Order No.	Page No.	Order No.	Page No.
10079	278	10156	37	10249	352	10353	190	10460	1093	10538	1142
10080	459	10157	37	10250	105	10354	160	10461	111	10540	1142
10081	175	10158	263	10251	247	10355	160	10462	1077	10541	1142
10082	117	10159	263	10252	248	10356	160	10463	536	10542	1143
10083	117	10160	278	10253	248	10357	160	10464	611	10543	1143
10084	628	10161	278	10254	245	10358	160	10465	609	10544	1143
10085	628	10162	115	10255	245	10359	160	10466	623	10545	1143
10086	539	10164	283	10256	245	10361	341	10467	584	10546	1143
10087	106	10165	1133	10257	247	10362	342	10468	658	10547	49
10089	233	10166	1133	10260	236	10363	342	10469	624	10548	49
10090	241	10167	248	10261	236	10364	620	10470	611	10549	49
10091	500	10168	278	10262	617	10365	256	10471	584	10550	1141
10093	399	10169	93	10263	455	10369	237	10472	611	10551	49
10094	399	10172	318	10264	134	10370	596	10473	604	10552	49
10095	399	10173	318	10265	134	10371	369	10474	534	10553	49
10096	399	10174	318	10267	50	10372	370	10475	536	10554	1141
10098	119	10175	318	10268	50	10373	370	10476	534	10555	49
10100	236	10176	595	10269	485	10376	377	10477	461	10556	49
10101	125	10180	364	10271	441	10377	329	10478	511	10557	1141
10102	359	10181	454	10272	441	10379	623	10479	534	10559	177
10103	544	10183	475	10273	535	10383	342	10480	578	10560	177
10104	453	10184	456	10275	604	10384	610	10481	578	10561	615
10105	454	10185	282	10284	373	10385	622	10482	578	10562	629
10106	114	10186	282	10286	110	10387	258	10483	578	10563	228
10107	114	10187	596	10288	110	10388	230	10484	512	10564	1140
10110	114	10188	596	10289	122	10389	80	10485	230	10571	1165
10111	114	10189	197	10290	122	10390	80	10486	230	10572	1171
10112	114	10190	599	10291	373	10392	51	10487	1140	10574	1171
10114	114	10191	83	10292	374	10393	51	10488	1140	10575	1165
10115	114	10192	639	10293	1078	10394	51	10489	1140	10595	1157
10118	59	10193	121	10294	1079	10395	51	10490	1140	10596	1157
10119	71	10194	156	10295	1080	10396	269	10491	1140	10597	1157
10120	72	10195	395	10296	1079	10397	276	10492	1140	10599	1157
10121	72	10198	381	10297	1080	10398	465	10493	1140	10601	1157
10122	68	10199	381	10298	667	10402	255	10494	1140	10602	1159
10123	68	10201	381	10299	603	10403	255	10496	1140	10603	1157
10124	68	10202	381	10301	104	10404	255	10497	1140	10604	1157
10125	37	10203	395	10302	465	10405	255	10498	1140	10605	1159
10126	36	10204	395	10303	135	10407	255	10499	1140	10606	1159
10127	120	10206	658	10304	456	10408	1097	10500	1140	10609	1165
10128	36	10207	35	10305	465	10409	255	10501	1140	10610	1157
10129	36	10208	35	10306	223	10410	255	10503	1140	10611	1161
10130	36	10209	318	10307	156	10411	255	10504	1140	10612	1161
10131	36	10210	258	10310	179	10412	286	10505	1140	10613	1157
10132	36	10211	535	10311	490	10413	287	10506	1140	10620	122
10133	36	10212	472	10312	84	10414	288	10507	1140	10621	1140
10134	36	10213	474	10313	465	10415	91	10508	1140	10622	1140
10135	36	10214	120	10315	636	10417	287	10509	1140	10623	250
10136	36	10219	67	10317	255	10418	287	10510	1140	10624	250
10137	36	10220	67	10318	256	10419	349	10511	1140	10625	250
10138	37	10222	59	10319	256	10420	348	10514	1140	10626	250
10139	37	10223	67	10320	260	10421	355	10515	1140	10627	250
10140	37	10224	67	10321	260	10422	500	10516	1140	10628	250
10141	37	10225	107	10322	260	10423	500	10517	1140	10629	250
10142	37	10226	279	10323	260	10424	500	10518	1142	10630	230
10143	37	10227	279	10324	611	10425	1241	10520	1142	10631	314
10144	37	10228	178	10325	610	10427	596	10522	1142	10633	314
10145	37	10231	644	10326	595	10428	118	10524	1142	10634	373
10146	37	10232	224	10328	1126	10429	125	10525	1142	10635	375
10147	37	10233	627	10343	1093	10430	119	10527	1142	10636	341
10148	37	10234	596	10344	1093	10431	1123	10528	1142	10638	644
10149	37	10237	540	10345	1093	10432	1123	10529	1142	10639	644
10150	37	10238	429	10346	1126	10434	230	10530	1143	10640	1123
10151	37	10239	429	10347	500	10435	230	10532	1143	10647	126
10152	37	10240	148	10348	500	10436	230	10534	1143	10648	1123
10153	37	10241	614	10349	500	10437	230	10535	1142	10649	126
10154	37	10243	314	10351	500	10454	455	10536	1142	10650	126
10155	37	10244	314	10352	500	10458	375	10537	1142	10651	126

2014 PRICING

Order No.	Page No.	Order No.	Page No.	Order No.	Page No.	Order No.	Page No.	Order No.	Page No.	Order No.	Page No.
10652	126	10725	126	10806	615	10885	247	10982	621	11142	179
10653	126	10726	126	10809	119	10886	247	10983	626	11144	280
10654	126	10728	126	10810	90	10887	247	10986	1177	11145	550
10655	50	10730	122	10811	90	10891	70	10987	1177	11147	549
10656	126	10731	127	10812	90	10892	114	10988	597	11148	550
10657	127	10732	127	10813	90	10893	250	10989	597	11150	549
10658	126	10733	127	10814	243	10894	250	10990	597	11151	549
10659	126	10735	127	10815	244	10895	1064	10991	597	11155	546
10660	126	10736	127	10816	109	10896	1141	10992	597	11157	549
10661	126	10737	279	10817	69	10898	596	10993	597	11163	546
10662	421	10738	280	10818	1125	10901	228	10994	597	11164	545
10664	1140	10739	406	10819	1175	10906	512	10995	597	11165	545
10665	148	10741	279	10820	284	10908	181	10997	597	11166	549
10666	50	10742	110	10821	241	10909	1126	10998	597	11168	549
10667	334	10743	248	10822	241	10910	239	10999	596	11170	546
10668	1130	10744	249	10823	260	10911	239	11014	185	11175	545
10669	1130	10745	249	10824	260	10912	239	11016	512	11176	545
10670	506	10746	258	10825	260	10913	239	11017	237	11177	545
10671	126	10748	64	10828	1152	10914	255	11018	1063	11178	545
10672	281	10749	231	10830	226	10915	110	11019	236	11179	545
10673	1079	10750	230	10831	235	10916	1150	11021	103	11180	331
10674	613	10751	231	10832	239	10919	1106	11022	628	11181	638
10675	1132	10752	458	10833	235	10928	352	11023	122	11182	638
10676	1133	10753	458	10834	229	10929	411	11024	254	11183	638
10677	1072	10754	558	10835	229	10930	398	11025	254	11184	638
10678	460	10755	558	10836	1152	10931	541	11026	254	11185	638
10679	460	10756	118	10837	1152	10932	540	11027	254	11186	638
10680	462	10757	159	10838	1152	10933	540	11028	254	11187	638
10681	464	10758	103	10840	1152	10934	528	11029	239	11189	638
10682	647	10759	485	10841	330	10935	540	11030	239	11190	638
10683	615	10760	127	10843	46	10936	541	11031	174	11192	638
10684	61	10761	127	10844	251	10937	541	11032	260	11193	638
10685	61	10764	287	10845	251	10938	540	11033	359	11194	638
10686	70	10768	288	10846	251	10939	540	11034	224	11195	638
10687	61	10769	288	10847	251	10940	536	11037	194	11196	638
10688	61	10770	556	10848	252	10941	536	11038	647	11198	638
10689	67	10771	1071	10849	252	10942	536	11039	178	11199	638
10690	63	10772	1071	10850	252	10943	536	11040	180	11200	638
10691	63	10773	290	10851	251	10944	536	11041	180	11201	638
10692	63	10774	290	10852	251	10945	536	11042	458	11202	638
10693	63	10775	290	10855	74	10946	536	11055	1143	11203	638
10694	64	10777	506	10856	529	10947	542	11056	1211	11204	638
10695	64	10778	488	10857	532	10948	542	11057	1209	11205	464
10696	67	10779	487	10858	609	10949	260	11059	122	11206	194
10697	64	10780	335	10859	1071	10950	595	11060	136	11207	279
10699	505	10781	228	10860	608	10951	58	11061	110	11208	288
10700	116	10782	228	10861	252	10952	315	11062	110	11209	289
10701	73	10783	228	10862	92	10953	315	11063	110	11211	289
10702	73	10784	228	10863	535	10954	315	11070	170	11212	289
10703	73	10785	190	10864	584	10955	315	11071	164	11213	289
10704	73	10786	591	10865	599	10957	429	11072	165	11214	289
10706	594	10788	591	10866	534	10959	125	11073	166	11215	289
10707	596	10789	110	10867	609	10960	276	11074	170	11216	289
10708	476	10790	148	10868	609	10961	460	11075	167	11217	110
10709	612	10791	1064	10869	529	10962	421	11076	178	11218	1069
10710	1062	10792	1064	10870	529	10963	493	11077	569	11219	1069
10711	112	10793	1069	10871	605	10964	38	11078	596	11220	593
10712	421	10794	1069	10872	190	10965	38	11079	613	11221	120
10714	104	10795	124	10873	535	10966	38	11123	577	11222	1113
10715	103	10796	1213	10875	535	10967	38	11129	224	11223	243
10716	245	10797	371	10876	535	10968	335	11130	224	11224	353
10717	248	10798	1106	10877	612	10969	38	11132	236	11225	244
10718	348	10799	1106	10879	460	10970	122	11133	167	11226	244
10719	351	10800	1106	10880	464	10971	370	11135	236	11228	286
10720	368	10802	1106	10881	464	10972	369	11137	237	11229	355
10722	49	10803	1106	10882	464	10973	369	11139	353	11230	464
10723	1060	10804	1106	10883	483	10975	621	11140	540	11231	349
10724	105	10805	1142	10884	247	10976	621	11141	122	11232	386

2014

PRICING

Order No.	Page No.	Order No.	Page No.	Order No.	Page No.	Order No.	Page No.	Order No.	Page No.	Order No.	Page No.
11233	386	11463	1114	11547	451	11632	269	11720	139	11813	498
11234	391	11464	286	11548	85	11633	269	11721	371	11814	1097
11237	167	11465	1107	11549	505	11634	270	11722	602	11815	275
11238	403	11468	243	11550	50	11635	270	11723	602	11816	506
11239	403	11469	354	11551	50	11636	1115	11724	602	11819	104
11240	349	11470	1065	11552	50	11637	1115	11725	602	11820	228
11241	351	11471	122	11553	50	11638	1115	11726	602	11821	411
11242	352	11472	655	11554	50	11639	1115	11727	602	11822	1059
11243	348	11473	478	11555	390	11640	64	11728	602	11825	167
11244	355	11474	177	11556	370	11641	492	11729	602	11826	640
11248	353	11475	343	11557	370	11642	492	11730	602	11828	169
11249	353	11476	340	11558	378	11643	335	11731	602	11829	169
11250	342	11477	342	11562	159	11644	335	11732	602	11830	640
11267	351	11478	341	11563	119	11645	335	11733	602	11831	640
11269	348	11479	341	11564	341	11646	358	11734	602	11832	640
11271	511	11480	341	11565	178	11647	347	11737	602	11833	144
11273	511	11481	1140	11566	179	11648	597	11738	602	11834	146
11274	193	11482	236	11571	596	11649	597	11739	602	11835	134
11278	193	11483	236	11578	1076	11650	597	11740	602	11838	532
11279	349	11487	614	11579	1217	11651	597	11741	602	11839	532
11282	564	11488	614	11580	494	11652	597	11742	602	11840	227
11283	559	11489	614	11581	1218	11653	597	11743	602	11841	468
11285	564	11490	614	11582	1218	11654	597	11744	602	11842	459
11286	559	11491	374	11583	1218	11655	597	11745	602	11843	227
11288	564	11493	349	11584	1216	11656	597	11746	602	11844	227
11290	559	11494	349	11585	1218	11657	286	11747	602	11845	227
11293	564	11495	351	11586	1218	11658	275	11748	602	11846	227
11296	559	11496	353	11587	494	11659	493	11750	644	11847	227
11298	564	11498	355	11588	1215	11660	236	11751	644	11848	234
11301	564	11500	348	11589	1129	11661	237	11752	644	11849	227
11302	559	11501	355	11590	185	11662	347	11753	645	11850	227
11304	594	11502	244	11591	185	11663	347	11757	644	11852	1134
11305	594	11503	243	11592	185	11664	168	11759	1130	11853	242
11306	594	11504	247	11593	376	11665	1144	11769	350	11856	370
11307	591	11505	471	11594	376	11666	1144	11770	350	11857	166
11308	591	11506	341	11595	373	11669	1144	11771	350	11858	167
11309	592	11507	341	11596	373	11670	1144	11772	322	11859	165
11310	339	11508	90	11598	1132	11671	1144	11773	350	11860	1206
11311	339	11509	122	11599	1132	11673	1144	11774	350	11861	224
11312	371	11510	51	11600	1132	11674	1144	11775	350	11862	224
11314	377	11511	71	11601	1117	11676	1144	11776	322	11863	224
11316	396	11512	71	11602	1117	11677	257	11777	352	11864	224
11317	396	11513	71	11603	1117	11679	1144	11778	352	11865	468
11321	1092	11514	71	11606	1117	11680	1144	11779	352	11867	224
11322	559	11515	71	11607	1117	11681	1144	11780	323	11868	392
11330	604	11516	61	11608	1117	11682	1144	11781	354	11870	369
11349	499	11517	71	11609	1117	11684	1144	11782	354	11932	1057
11357	499	11518	61	11610	1117	11686	1144	11783	354	11933	1057
11358	498	11519	59	11611	1117	11687	1144	11784	324	11934	1057
11435	586	11520	61	11612	1117	11688	1144	11785	354	11935	1057
11444	167	11521	64	11613	1117	11689	1144	11786	354	11940	1057
11445	169	11522	110	11614	1117	11690	1144	11787	354	11941	1057
11446	278	11523	597	11616	1117	11691	1144	11788	325	11942	1057
11447	279	11524	1142	11617	1119	11693	1144	11789	355	11943	1057
11449	280	11525	1140	11618	1117	11695	1144	11790	355	11954	159
11450	351	11526	1143	11619	1117	11696	1144	11791	355	11956	100
11451	352	11528	1143	11620	1117	11697	1144	11792	325	11957	1120
11452	192	11529	1144	11621	1117	11698	1144	11793	462	11958	533
11453	1114	11530	1140	11622	1117	11705	1145	11795	454	11959	533
11454	1114	11533	1143	11623	1117	11706	1089	11800	661	11960	534
11455	1114	11534	1143	11624	1117	11707	1089	11801	661	11961	187
11456	1114	11536	1143	11625	1117	11708	1145	11805	340	11962	187
11457	1114	11538	1143	11626	1117	11709	1145	11806	493	11963	187
11458	1113	11539	1143	11627	1117	11710	1089	11807	493	11964	193
11459	1114	11540	1143	11628	1117	11711	273	11809	121	11967	546
11460	1114	11541	1143	11629	1117	11712	1145	11810	369	11968	546
11461	1114	11543	1140	11630	1117	11717	1145	11811	230	11969	549
11462	1114	11545	1142	11631	1117	11719	342	11812	586	11970	546

2014 PRICING

Order No.	Page No.	Order No.	Page No.	Order No.	Page No.	Order No.	Page No.	Order No.	Page No.	Order No.	Page No.
11971	546	12066	196	12141	636	12217	1141	12299	278	12390	1124
11972	549	12067	256	12142	636	12218	58	12300	275	12392	1124
11973	546	12068	256	12143	636	12219	195	12301	275	12395	466
11974	547	12069	256	12144	636	12220	1078	12302	275	12398	225
11975	546	12070	257	12145	636	12221	623	12304	533	12399	240
11982	640	12071	257	12146	636	12222	53	12305	494	12401	240
11983	640	12072	257	12147	636	12223	1129	12306	494	12402	466
11984	640	12073	257	12148	636	12224	1112	12307	185	12403	168
11987	640	12074	515	12149	636	12225	1112	12308	185	12404	1123
11988	640	12075	67	12150	636	12226	1112	12309	164	12405	247
11989	557	12077	230	12151	636	12227	165	12310	120	12406	1114
11990	557	12078	231	12152	636	12228	165	12312	596	12407	1114
11991	557	12079	623	12153	636	12230	165	12313	496	12408	1113
11992	1120	12080	452	12154	636	12231	165	12314	572	12409	1113
11993	1120	12081	492	12155	636	12233	255	12317	275	12410	73
11994	1120	12082	1077	12156	636	12234	597	12318	251	12411	277
11996	182	12083	1077	12157	636	12236	188	12319	252	12412	1142
11997	227	12084	514	12160	638	12237	245	12320	252	12413	252
11998	1094	12085	255	12161	638	12238	244	12321	253	12414	252
11999	1095	12087	614	12163	638	12239	243	12322	253	12415	252
12000	1094	12091	1067	12164	638	12240	331	12323	253	12416	253
12001	459	12092	94	12165	638	12241	192	12327	1059	12417	252
12002	350	12093	94	12166	638	12242	333	12329	622	12419	279
12003	350	12094	248	12167	638	12243	460	12330	622	12422	648
12004	352	12095	248	12168	638	12244	120	12331	1157	12423	225
12005	354	12096	248	12174	638	12245	107	12332	1157	12424	169
12008	1094	12097	249	12175	638	12246	260	12333	1157	12425	246
12009	1094	12098	249	12176	638	12247	165	12334	1157	12426	245
12010	1095	12099	249	12177	638	12248	256	12335	1157	12427	279
12011	1094	12100	249	12178	638	12249	256	12336	1157	12428	271
12014	1094	12101	636	12179	638	12250	211	12337	1157	12429	235
12015	104	12102	636	12180	638	12251	347	12338	1159	12430	616
12016	181	12103	636	12181	638	12254	615	12341	1159	12431	594
12017	179	12104	636	12182	638	12255	1112	12342	1161	12432	613
12018	104	12105	636	12183	638	12256	247	12343	1161	12433	1171
12019	624	12106	249	12184	637	12257	1239	12344	1161	12437	1119
12020	52	12107	249	12185	637	12258	1239	12345	1161	12438	1119
12021	52	12108	249	12186	637	12259	585	12346	1161	12440	509
12022	1109	12109	249	12187	637	12260	585	12347	1161	12442	244
12024	492	12110	585	12188	637	12261	168	12348	1165	12443	244
12027	354	12111	585	12189	637	12262	168	12349	1157	12448	195
12028	355	12112	585	12190	637	12263	538	12349	1157	12450	174
12029	1174	12114	168	12191	637	12264	251	12352	1161	12452	244
12035	1174	12115	1081	12192	637	12266	1210	12353	1169	12454	169
12036	1177	12116	1081	12193	637	12267	1210	12355	1171	12455	1171
12038	1174	12118	377	12194	637	12268	179	12356	1171	12456	270
12039	1174	12119	136	12194	637	12271	271	12357	1171	12459	192
12042	1174	12120	483	12195	637	12272	452	12358	1171	12460	1130
12043	577	12121	323	12196	637	12272	452	12361	148	12461	230
12044	1177	12122	365	12197	637	12273	408	12362	408	12462	239
12045	1177	12122	365	12198	637	12274	621	12368	622	12463	82
12046	1176	12123	366	12199	637	12275	273	12370	225	12466	80
12049	254	12124	367	12200	637	12276	273	12371	256	12467	80
12050	613	12125	368	12201	637	12277	273	12373	231	12468	80
12051	228	12126	89	12202	637	12279	615	12374	484	12470	1195
12052	224	12127	513	12203	637	12280	435	12375	347	12471	1197
12053	58	12128	1069	12204	637	12281	616	12376	596	12472	277
12054	599	12129	609	12205	637	12282	454	12377	485	12473	278
12055	514	12130	619	12206	637	12283	454	12377	485	12474	278
12056	514	12131	636	12207	637	12286	225	12378	271	12475	322
12057	604	12132	636	12208	637	12287	51	12379	196	12477	92
12058	1128	12133	636	12209	637	12288	51	12380	376	12478	120
12059	1128	12134	636	12210	637	12289	469	12381	592	12479	454
12060	107	12135	636	12211	637	12290	1145	12382	235	12480	224
12061	270	12136	636	12212	637	12291	1145	12383	191	12481	614
12062	506	12137	636	12213	637	12293	540	12384	641	12482	1140
12064	596	12138	636	12214	637	12296	438	12385	271	12483	1140
12065	614	12139	636	12215	637	12297	278	12386	1124	12484	98
		12140	636	12216	1141	12298	278	12387	1124	12485	487
								12388	1124		

2014

PRICING

Order No.	Page No.	Order No.	Page No.	Order No.	Page No.	Order No.	Page No.	Order No.	Page No.	Order No.	Page No.
12486	490	12573	495	12676	472	12773	1201	12886	456	12991	641
12488	1140	12578	1113	12678	231	12774	1201	12887	488	12995	379
12489	234	12579	1113	12679	522	12775	486	12888	488	12996	1201
12491	192	12580	426	12682	273	12778	191	12891	281	12997	509
12492	1110	12581	426	12684	1120	12780	1062	12892	224	12998	1201
12493	443	12582	1176	12685	1060	12783	245	12893	342	12999	107
12494	613	12583	1176	12686	229	12784	479	12894	453	13000	107
12495	193	12584	1176	12687	241	12786	466	12895	455	13001	188
12497	489	12585	1176	12688	252	12787	466	12898	231	13003	190
12498	647	12586	1176	12689	251	12790	234	12899	165	13004	190
12499	76	12587	1176	12690	251	12791	234	12901	292	13005	190
12500	76	12588	1176	12691	253	12792	1071	12909	342	13006	190
12501	76	12589	1176	12692	253	12793	275	12910	193	13007	191
12502	76	12590	1176	12693	252	12794	1129	12913	114	13009	200
12503	76	12591	1176	12694	253	12795	122	12914	633	13013	275
12504	76	12592	1176	12695	252	12797	466	12916	259	13014	58
12505	75	12593	572	12696	279	12799	245	12918	637	13015	1208
12506	75	12594	640	12697	615	12800	1111	12919	376	13016	323
12507	77	12595	640	12701	621	12801	460	12920	373	13017	324
12508	75	12596	640	12702	621	12802	1080	12923	168	13018	593
12509	76	12597	1125	12703	667	12803	1130	12925	198	13020	593
12512	525	12598	519	12704	1133	12804	1130	12926	195	13021	593
12513	270	12605	518	12705	1133	12805	258	12929	1109	13022	593
12515	496	12609	227	12706	187	12806	189	12930	286	13023	333
12516	488	12610	234	12707	609	12807	189	12933	534	13029	188
12517	168	12612	195	12708	228	12808	189	12934	449	13031	641
12519	1133	12613	281	12709	619	12809	342	12935	449	13032	100
12520	487	12614	1090	12710	619	12810	281	12936	448	13033	100
12521	525	12615	364	12712	286	12812	162	12938	448	13035	231
12522	525	12616	344	12713	467	12813	533	12939	448	13036	231
12524	120	12619	497	12714	335	12814	232	12940	448	13037	610
12528	1145	12620	270	12715	275	12815	1209	12941	448	13038	509
12529	525	12621	165	12716	494	12819	580	12942	448	13039	596
12530	525	12622	178	12717	1216	12820	637	12943	448	13040	1115
12531	526	12624	1065	12718	257	12821	373	12944	449	13041	1110
12533	525	12627	556	12719	257	12823	1109	12945	448	13042	1228
12535	187	12628	1209	12720	1141	12824	256	12946	448	13043	1228
12538	1171	12629	1208	12721	333	12829	435	12947	448	13047	225
12541	605	12630	1208	12722	271	12833	192	12948	449	13048	225
12542	598	12631	1209	12723	184	12835	168	12949	450	13049	455
12543	598	12632	1209	12724	198	12839	1061	12950	450	13050	226
12544	598	12633	178	12725	661	12847	520	12951	450	13051	633
12545	598	12635	122	12726	627	12848	611	12952	450	13052	226
12546	598	12641	245	12727	106	12850	228	12953	449	13053	226
12547	598	12642	509	12728	428	12852	402	12954	613	13054	225
12548	598	12643	376	12729	258	12853	282	12956	386	13055	1181
12549	598	12644	270	12730	258	12854	282	12957	333	13056	1180
12550	598	12648	104	12731	1211	12855	282	12958	1133	13057	226
12551	598	12649	323	12732	332	12856	145	12960	449	13058	226
12552	598	12650	592	12733	370	12857	146	12961	449	13059	226
12553	598	12651	132	12734	185	12858	1109	12963	382	13060	1115
12554	598	12653	229	12748	1216	12859	667	12964	455	13061	1115
12555	598	12654	626	12749	160	12860	667	12965	73	13063	1202
12557	1117	12655	626	12751	244	12861	450	12966	187	13064	1152
12558	598	12656	626	12752	1059	12862	450	12967	188	13066	1152
12559	232	12657	626	12756	176	12863	450	12968	456	13074	1152
12560	232	12658	169	12757	1065	12864	450	12969	70	13076	1152
12561	494	12659	189	12758	466	12865	496	12972	189	13080	1159
12562	375	12660	189	12759	232	12867	258	12973	188	13082	1159
12563	332	12661	270	12760	232	12868	357	12974	333	13083	1161
12564	181	12667	233	12762	1065	12871	188	12975	1098	13084	1159
12565	181	12668	190	12764	122	12873	227	12977	167	13085	1159
12566	515	12670	533	12765	122	12877	455	12980	164	13086	1159
12567	515	12671	122	12766	122	12878	534	12981	167	13088	226
12568	1132	12672	259	12767	122	12879	122	12982	506	13089	186
12570	495	12673	453	12768	227	12883	188	12983	244	13090	186
12571	495	12674	472	12769	227	12884	273	12984	595	13091	192
12572	495	12675	281	12770	234	12885	1209	12985	456	13092	136

2014 PRICING

Order No.	Page No.	Order No.	Page No.	Order No.	Page No.	Order No.	Page No.	Order No.	Page No.	Order No.	Page No.
13094	1125	13181	1142	13270	543	13358	524	13438	1123	13531	516
13095	1216	13184	1152	13271	543	13359	146	13439	1123	13532	609
13096	613	13185	1202	13272	543	13360	182	13440	158	13533	633
13097	1202	13186	1171	13273	543	13361	367	13441	158	13536	520
13098	605	13187	1161	13274	543	13362	595	13442	229	13537	533
13100	610	13188	1161	13275	543	13363	516	13443	229	13540	191
13101	610	13189	1161	13276	543	13365	1202	13444	229	13541	239
13103	542	13190	1161	13278	1069	13366	243	13448	509	13544	1148
13104	1151	13191	1161	13279	104	13367	367	13449	425	13545	1148
13105	1151	13192	547	13280	104	13368	1088	13451	174	13546	1148
13106	1065	13193	547	13281	104	13369	506	13453	1121	13548	68
13108	246	13194	547	13284	221	13370	506	13454	247	13549	578
13109	246	13195	547	13285	548	13371	92	13455	533	13551	237
13110	246	13196	548	13286	548	13372	92	13456	244	13553	495
13114	613	13197	548	13287	548	13373	595	13457	174	13554	170
13115	496	13198	548	13288	233	13374	1113	13459	1121	13555	1086
13116	511	13199	548	13290	572	13375	646	13460	1121	13556	1086
13117	257	13200	548	13291	1196	13377	646	13461	1121	13557	1086
13118	251	13201	548	13292	1196	13379	615	13463	359	13558	1086
13119	490	13202	547	13293	1196	13380	70	13464	360	13559	1086
13120	1171	13203	547	13294	1196	13381	464	13467	136	13560	625
13127	277	13204	547	13296	158	13382	463	13468	136	13561	625
13128	542	13205	547	13300	641	13383	475	13469	166	13562	625
13129	323	13206	548	13301	234	13384	475	13470	159	13566	550
13130	191	13207	547	13302	1149	13385	193	13473	615	13567	233
13131	188	13208	180	13303	1149	13386	535	13474	229	13569	258
13132	488	13210	571	13304	1149	13389	463	13475	229	13570	258
13133	488	13211	573	13305	1149	13390	463	13476	229	13571	259
13135	488	13215	340	13306	1149	13391	1196	13477	229	13572	259
13136	489	13216	1089	13307	1149	13394	493	13481	400	13573	259
13137	575	13217	231	13309	1149	13397	1221	13482	401	13580	625
13138	489	13219	244	13310	1149	13398	101	13485	1191	13581	633
13140	1089	13220	195	13311	1149	13399	101	13488	1202	13582	625
13141	551	13221	1089	13312	1149	13400	111	13489	1196	13583	491
13142	551	13222	1112	13313	1149	13401	111	13490	1196	13584	633
13143	551	13223	1171	13314	1149	13402	114	13491	102	13585	1177
13146	550	13224	575	13315	1149	13403	100	13492	102	13586	1212
13147	550	13225	181	13316	1149	13404	163	13493	1131	13587	622
13148	550	13228	512	13317	1149	13405	163	13494	1131	13588	1217
13149	550	13229	145	13318	1149	13406	163	13495	103	13589	1149
13150	550	13230	1189	13320	1149	13407	163	13498	368	13591	625
13151	551	13231	541	13321	1149	13408	259	13499	228	13592	226
13152	551	13232	233	13322	1149	13409	273	13500	368	13593	371
13153	551	13234	193	13323	1149	13411	1131	13501	228	13597	646
13154	551	13237	483	13324	1149	13412	1131	13502	274	13598	646
13155	551	13239	331	13326	1149	13413	274	13504	178	13599	646
13157	231	13240	178	13327	1149	13414	132	13505	221	13600	646
13158	232	13241	225	13328	1149	13415	1196	13506	221	13601	646
13159	493	13242	226	13329	1149	13416	69	13507	221	13602	646
13160	495	13243	226	13330	1149	13417	277	13508	221	13603	646
13161	1101	13245	120	13332	69	13418	132	13509	221	13604	194
13162	1101	13247	258	13333	365	13419	344	13510	569	13605	183
13163	1101	13248	1065	13334	365	13420	1202	13513	571	13609	622
13164	1101	13250	578	13335	366	13421	115	13514	570	13610	622
13165	118	13251	225	13336	620	13422	115	13515	570	13612	625
13166	486	13252	622	13337	115	13423	274	13516	570	13613	531
13167	1223	13254	245	13338	620	13424	274	13517	578	13614	287
13168	1224	13255	245	13341	524	13425	274	13518	578	13615	287
13169	1225	13256	245	13342	524	13426	274	13519	578	13616	1208
13170	1225	13257	257	13343	524	13427	274	13520	578	13617	1212
13171	520	13259	135	13344	524	13429	1131	13521	574	13618	1212
13172	611	13260	354	13345	524	13430	69	13522	570	13620	200
13173	499	13262	1202	13346	524	13431	70	13524	198	13621	200
13175	269	13263	1196	13349	1062	13432	100	13525	569	13622	270
13176	660	13264	69	13350	68	13433	89	13526	572	13623	370
13177	328	13265	542	13351	1119	13434	293	13528	624	13624	361
13178	269	13266	543	13355	609	13436	69	13529	625	13625	442
13179	269	13267	542	13357	496	13437	70	13530	516	13626	616

2014

PRICING

Order No.	Page No.	Order No.	Page No.	Order No.	Page No.	Order No.	Page No.	Order No.	Page No.	Order No.	Page No.
13627	226	14120	237	14258	495	14392	369	14624	59	50109	406
13628	626	14121	199	14268	1067	14394	1232	14626	1092	50111	365
13629	449	14122	199	14272	541	14395	1232	14628	505	50113	363
13631	195	14127	644	14276	1177	14396	1232	14629	505	50121	414
13634	1121	14129	259	14277	520	14397	1231	14635	1142	50122	414
13635	1121	14130	259	14278	520	14415	596	14636	592	50123	379
13636	1121	14132	199	14279	136	14421	1104	14637	592	50125	335
13638	1196	14133	143	14282	200	14422	457	14638	245	50127	328
13639	293	14139	1135	14283	200	14423	457	14642	1131	50139	406
13640	460	14143	1110	14285	426	14424	102	14643	623	50140	395
13641	457	14144	1110	14286	426	14427	1061	14648	477	50141	367
13643	621	14145	1110	14287	644	14429	1111	14650	1241	50142	340
13644	457	14146	570	14289	457	14431	477	14651	1241	50143	340
13650	584	14153	1140	14291	1067	14437	159	14652	1062	50144	340
13652	496	14154	1140	14292	509	14440	428	14653	1200	50145	339
13653	235	14155	1087	14293	1122	14442	344	14654	1200	50146	339
13657	71	14158	457	14294	1122	14446	103	14655	535	50147	377
13659	1111	14159	1135	14295	1122	14449	441	14656	624	50148	377
13660	1111	14163	486	14297	1096	14450	441	14657	364	50150	405
13662	119	14164	1134	14299	584	14451	441	14663	505	50153	364
13664	159	14165	245	14302	111	14454	1062	14664	505	50160	364
13665	159	14166	257	14306	69	14456	442	14665	505	50162	340
13903	501	14167	246	14308	592	14457	435	14666	505	50163	340
13973	165	14168	194	14315	1077	14459	331	14672	1062	50166	435
13974	194	14172	405	14316	166	14460	1077	14675	505	50167	73
13975	416	14173	93	14318	259	14461	1135	14676	505	50173	426
13976	416	14174	93	14319	259	14464	477	14995	501	50174	426
13977	416	14176	1232	14322	148	14467	344	15904	508	50180	130
13986	344	14177	1232	14323	1065	14473	106	15905	508	50181	130
13987	344	14178	1232	14324	57	14475	374	16000	499	50183	130
13988	81	14179	1233	14325	57	14481	378	16245	314	50185	130
13989	81	14180	1233	14326	280	14482	378	16246	314	50187	130
13990	81	14181	1233	14327	169	14483	378	16247	314	50188	130
13998	526	14182	1233	14328	187	14488	378	16248	314	50189	130
14000	251	14183	1233	14329	187	14491	354	17090	636	50190	130
14002	120	14184	1231	14331	1067	14492	591	17141	648	50191	130
14009	164	14185	1231	14333	586	14495	164	17327	604	50201	383
14023	68	14188	479	14334	586	14500	645	18199	131	50202	383
14029	1079	14189	166	14335	586	14501	645	18387	501	50203	431
14035	103	14196	1098	14336	586	14511	620	19088	1129	50204	431
14036	192	14204	68	14338	1150	14512	225	30048	647	50205	436
14040	69	14206	457	14340	624	14513	225	30054	647	50206	432
14041	1078	14207	466	14341	73	14540	328	30055	647	50208	432
14042	241	14209	246	14342	1122	14542	119	30101	642	50209	432
14045	166	14211	1111	14343	1149	14548	572	30112	647	50212	171
14050	434	14212	1129	14344	123	14551	620	30113	647	50213	171
14059	141	14213	1111	14345	124	14556	119	30127	642	50215	72
14060	141	14215	235	14346	110	14557	145	30128	644	50216	72
14071	426	14217	246	14347	123	14559	594	30129	645	50221	107
14076	368	14220	1072	14348	1199	14560	596	30130	645	50222	107
14077	368	14221	161	14353	166	14561	1075	30131	645	50223	430
14078	368	14222	1072	14359	228	14577	645	30169	659	50224	430
14083	1199	14226	199	14362	1135	14580	429	50007	405	50225	430
14085	495	14229	166	14363	249	14581	429	50022	381	50226	430
14089	457	14230	191	14364	457	14593	257	50026	405	50227	436
14090	280	14233	119	14365	241	14594	441	50027	405	50237	1072
14091	280	14235	1149	14367	644	14607	1105	50030	406	50238	1072
14095	378	14237	232	14368	641	14608	1105	50031	367	50239	1072
14096	377	14240	280	14369	641	14609	1105	50034	346	50241	414
14099	457	14241	279	14373	641	14610	1105	50060	346	50242	458
14108	1132	14242	280	14374	641	14611	1105	50061	405	50243	458
14110	551	14243	230	14375	641	14612	1105	50062	371	50245	414
14111	550	14246	1067	14376	641	14613	1105	50063	371	50246	406
14112	550	14247	1068	14377	641	14614	1105	50071	406	50247	405
14114	1212	14248	1065	14378	616	14620	70	50098	363	50252	330
14116	225	14252	191	14383	1202	14621	58	50101	363	50253	330
14117	225	14255	280	14390	231	14622	71	50102	363	50254	389
14118	234	14257	520	14391	368	14623	68	50106	363	50255	389

2014 PRICING

Order No.	Page No.	Order No.	Page No.	Order No.	Page No.	Order No.	Page No.	Order No.	Page No.
50256	186	3288306S1	472						
50257	186	4109806S	617						
50261	292	4109808S	618						
50287	367	4508301S	472						
50288	315	4508302S	472						
50289	367	4509809S	617						
50290	366	4509810S	618						
50291	369	4588302S1	472						
50292	365	4708301S	473						
50293	365	4708303S	471						
50294	368	4715003S	1075						
50295	406	4788301S1	473						
50296	406	4788303S1	471						
50297	366	4809804S	618						
94195	1241	5205002S1	483						
94196	1241	5205002S	483						
231847S	471	5208301S	473						
235116S	470	5209811S	616						
237421S	470	5209812S	619						
277233S	483	5209813S	616						
1205001S1	483								
1205001S	483								
1208305S	467								
1208308S	467								
1208310S	467								
1208312S	467								
1209821S	618								
1209822S	617								
1288305S1	467								
1288310S1	467								
1408301S1	469								
1408301S	469								
1408302S	469								
1708307S	469								
1708312S	469								
1788303S1	471								
1788307S1	469								
1888301S1	470								
2008304S	469								
2008306S	469								
2088306S1	469								
2405013S1	497								
2405013S	497								
2408302S	471								
2408303S	470								
2408305S	470								
2488303S1	470								
2505007S1	496								
2505007S	496								
2505021S1	497								
2505021S	497								
2505022S1	498								
2505022S	498								
2508301S	468								
2508302S	468								
2508303S	468								
2508304S	468								
2509807S	619								
2509811S	616								
2575701S	541								
2575702S	541								
2588303S1	470								
3208303S	471								
3208305S	471								
3208306S	472								
3208308S	472								
3209804S	619								
3288303S1	471								

2014

PRICING

INDEX

A	B (Cont.)
AV Mounts.....	1217
Accumate Pro.....	1095
Adaptors (Blade).....	428-433
Adaptors Accessories.....	428-433
Adjusters (Height).....	163
Aftermarket Cross Reference.....	1358-1395
Air Filters (Chain saw).....	485-495
Air Filters (Foam).....	451-482
Air Filters (Paper).....	451-482
Air Hose.....	1102
Air Lifts.....	419
Alcohol Fuel Tester.....	1111
Allen Set Screw Assortment.....	41
Antenna.....	1124
Arbor Bolts.....	647
Armatures (Magneto).....	1075-1078
Assortment (Plastic Box).....	1240
Assortments.....	33-54
ATV Spark Plugs.....	597
ATV Tires.....	126
B	C
Bags (Grasscatcher).....	663-664
Ball Joints.....	174
Bars (Chain saw).....	1147-1172
Base Gaskets.....	582-584
Batlock.....	1081
Batteries.....	1057
Battery Cable.....	1057-1058
Battery Terminals.....	1058
Battery Charger (Optimate).....	1094
Battery Corrosion Protector.....	1113
Bearings (Edger).....	129-135
Bearings (High Speed).....	129-135
Bearings (Kit).....	137-141
Bearings (Spindle).....	129-135
Bearings (Wheel).....	129-135
Bearings, Bushings.....	129-154
Belt Cross Reference.....	1407-1423
Belt Dressing.....	1113
Belt Measurer.....	211
Belt Rack.....	211
Belt Quick Cross Reference.....	206-210
Belts (Aramid).....	214-216
Belts (O.E.M. Replacement).....	221-241
Belts (Premium).....	211-213
Bin Boxes (White).....	1239
Blade (Cut off saw).....	1127
Blade (Edger Quick Reference Chart).....	1426
Blade (Edger).....	421-424
Blade (O.E.M. Repl. Quick Reference Chart).....	298-313
Blade (O.E.M.).....	327-418
Blade (Superlift).....	314
Blade (Thatcher).....	314
Blade (Universal).....	314-316
Blade Adapter Accessories.....	428-436
Blade Adapters.....	428-436
Blade Balancer.....	1089
Blade Bolt Assortment.....	39
Blade Bolts.....	433-436
Blade Clutch.....	428
Blade Grinder.....	1087
Blade Hubs.....	428-436
Blade Reducer Assortment.....	44
Blade Universal (Mulcher).....	314-316
Blade Universal Quick Reference Chart.....	298-313
Blade Washer Assortment.....	39
Blade Washers.....	433-436
Blades (Poly).....	648
Blower (Pipe).....	661
Bolt/Screw Assortments (Chain saw).....	48
Bolts (Arbor).....	647
Bolts (Blade).....	433-436
Bolts (Wheel).....	178-181
Brake Assembly (Disc).....	84
Brake Band.....	84
Brake Cable.....	69-70
Brake Drum.....	91
Brake Pedal Pad.....	162
Brake Pucks.....	84
Breaker (Chain).....	1102
Brister's Clutch Lube System.....	80
Brushcutter Blades.....	648-649
BugsBGone.....	1112
Bumper Sticker.....	1242
Bushings (Blade).....	436
Bushings (Snowblowers).....	1222
Cables (Battery).....	1057-1058
Cables (Brake).....	69-70
Cables (Drive).....	67-70
Cables (Steering).....	72
Cables (Throttle).....	56-66
Cables (Transmission).....	71-72
Cables (Winch).....	72
Caps (Gas).....	512-518
Caps (Oil).....	512-518
Caps (Rotary).....	1242
Carburetion.....	527-551
Carburetion Assortment (Chain saw).....	47
Carburetor Bowl.....	533
Carburetor Gaskets.....	575-581
Carburetor Kit Application Chart.....	1396-1406
Carburetor Overhaul Kits.....	555
Centrifugal Clutch.....	80
Chain (Roller).....	203
Chain (Saw).....	1137-1146
Chain (Sharpener).....	1103
Chain (Tires).....	1227
Chain Breaker.....	1102
Chain Files.....	1127
Chain Link Assortment.....	49
Chain Links.....	203
Chain Repair Tool.....	1108
Chain Saw (Diaphragms).....	1189-1206
Chain Saw (Gaskets).....	1189-1206
Chain Saw (Needles).....	1189-1206
Chain Saw Accessories.....	1205-1219
Chain Saw Air Filters.....	485-495
Chain Saw Bars.....	1147-1172
Chain Saw Carburetion.....	1183-1204
Chain Saw Carburetor Kits.....	1191-1198
Chain Saw Chain.....	1137-1146
Chain Saw Fuel Filter.....	500-502
Chain Saw Springs.....	1179-1182
Chain Saw Sprockets.....	1173-1178
Chain Saw Tensioners.....	1214
Charts (Chain saw).....	574
Chrome Rings.....	557
Clamps (Fuel Line).....	507-508
Clips (Conduit).....	74
Clutch (Blade).....	428
Clutch (Brister's Lube System).....	80
Clutch (Centrifugal).....	80
Clutch (PTO).....	164-170
Clutch Collar.....	83
Clutch Key.....	80
Clutch Pedal Pad.....	162
Clutch Sprockets.....	82
Clutches (Electric).....	164-170

INDEX

C (Cont.)		G	
Coil Condenser Tester.....	1092	Gas Cans.....	1120-1122
Coils.....	1075-1078	Gas Caps.....	512-518
Compression Gauge.....	1092	Gas Caps (Locking).....	514
Conduit.....	74	Gasket (Carburetor).....	575-581
Connecting Rod Assembly.....	566	Gasket (Head).....	569-570
Control (Throttle Accessories).....	74-75	Gasket (Miscellaneous).....	569-584
Control (Throttle).....	55-78	Gasket (Valve Cover).....	581
Cotter Pin Assortment.....	41	Gasket Sets.....	571-574
Crankshaft Holder Wrench.....	1101	Gaskets (Base).....	585-584
Crankshaft Straightener.....	1084	Gear Box Assembly.....	1231
Cutting Heads (Trimmer).....	639-646	GoCart Accessories.....	79-86
Cylinder Hone.....	1091	Governor Spring Assortment.....	36
Cylinder Reamer.....	1091	Governor Springs.....	530-532
Cylinders/Piston Assembly.....	563-565	Grass Bags.....	663-664
D		Grease Fitting Assortments.....	44
Deck Accessories.....	156-201	Grease Gun.....	1109
Diaphragms.....	528-529	Grinder (Dust Collector).....	1087-1089
Diaphragms (Chain saw).....	1189	Grinders.....	1087-1089
Disc Brake Assembly.....	84	Grinding Wheels.....	1087-1089
Display Assortments.....	34-54	H	
Dressing Brick.....	1003	Hair Pin Cotter Assortment.....	44
Dressing Wheel.....	1107	Handle Bracket.....	161
Drive Cables (Trimmer).....	75-77	Handles (Lawnmower).....	601-606
Drive Kit (Starter).....	621-622	Handles (Starter).....	603-606
Drive Parts.....	87-94	Handles (Trimmers).....	655
Drive Shafts.....	89	Head Gaskets.....	569-570
Dust Mask.....	1120	Headphone.....	1124
E		Head Springs (Trimmer).....	659
EClip Assortment.....	41	Heads (Cutting) Trimmer.....	639-646
Economy Blade Balancer Display.....	34	Height Wheel Adjusters.....	163
Edger Bearings.....	130-136	Hex Head Screws.....	52
Edger Blade Quick Reference Chart.....	1426	High Speed Bearings.....	130-136
Edger Blades.....	421-424	Hitch Pins.....	666
Edger Shafts.....	424	Hood latch.....	161
Electric Clutches.....	164-170	Hose Clamps.....	507-508
Electric Starters.....	612-620	Hub Cap Covers.....	101
Electronic Ignition.....	1075-1080	Hubs (Blades).....	428-433
Engine Compression Tester.....	1092	Hubs (Wheel).....	117
Engine Gasket Sets (Chain saw).....	1190-1197	HV Sealant.....	1110
Engine HP to Model No. Ref. Guide.....	1446-1147	Hydrostatic (Pumps).....	94
Engine Oil.....	1132-1133	I	
Engine Parts.....	552-587	Idler Assortment.....	36
Exhaust Gaskets (Chain saw).....	577-581	Idler Display.....	36
EZ Lift Rider Ramps.....	1109	Idlers.....	262-296
F		Ignition (Chain saw).....	1070
Fibre Spacer (Washers).....	434	Ignition (Small Engine).....	1056-1081
Files (Chain).....	1127	Ignition (Transistorized).....	1074
Filing Guides.....	1108	Ignition Switches.....	1059-1063
Filters (Chain saws).....	485-495	Ignition Tester.....	1096
Filters (Small engines).....	451-482	Impact Driver.....	1102
Finger Blades.....	347	Inner Wire.....	74
Flail Blades.....	335	Intake Gasket (Chain saw).....	575-579
Flex Pipe (For Blowers).....	661	Internal Engine Parts.....	555-586
Flywheel Keys.....	586	J	
Flywheel Knockers.....	1099	Jackshafts.....	82
Flywheel Pullers.....	1099	K	
Flywheel Tools.....	1099	Key Clutch.....	82
Foam Air Filters.....	448-482	Key Stock.....	82
Fuel Additives.....	1129-1131	Keys (Flywheel).....	586
Fuel Bowl Assembly.....	508	Keys (Ignition Switch).....	1059-1063
Fuel Filters (Chain saw).....	500-502	Keys (Woodruff).....	40
Fuel Filters (Lawnmower).....	448-482	Kill Switch.....	85
Fuel Line Accessories.....	504-520	Kits (Bearings).....	134-141
Fuel Line Clamps.....	507-508	Kits (Carburetor).....	1191-1198
Fuel Line and Fitting Assortment.....	34	Kits (Overhaul).....	555
Fuel Pump Kit.....	529	Kits (Tuneup).....	554
Fuses.....	1073-1074	Kwik Loader Trimmer Head.....	640-641

INDEX

S (Cont.)	T (Cont.)
Spark Plug Accessories599-600	Trimmer Line and Accessories.....637-661
Spark Plug Gauge1096	Trimmer Shields665
Spark Plug Quick Reference.....1424-1425	Tru Flow.....466
Spark Plugs589-598	Tubes.....123-125
Spark Plugs (ATV).....597	TuneUp Kits555
Speakers.....1124	
Spindle Assemblies184-201	U
Spindle Bearing130-136	Universal Blades297-316
Spindle Shafts182-186	Universal Blades Quick Reference Chart1428-1429
Spring Assortment (Universal).....42	Universal Snowblower Shoe1228-1229
Springs (Chain saw)1179-1182	
Springs (Governor).....530-532	V
Springs (Small Engine)171-173	Valve Cover Gasket.....581
Springs (Steering Lever)171	Valve Stem.....117
Springs (Tine).....314	Valve Tools1090-1092
Springs (Transmission Lever).....171	Valve, Exhaust.....567
Springs (Trimmer).....659	Valve, Intake.....567
Springs (Universal).....42	Voltage Regulators1078-1080
Sprockets (Chain saws).....1173-1178	
Starter Accessories607-634	W
Starter Drive Kit612	Washers (Blade).....433-436
Starter Handle603-606	Washers (Fibre Spacers).....434
Starter Rope602-603	Wedges (Plastic).....1125
Starters (Electric).....612-620	Weed Clipper Blades425-426
Steel Pulley Assortments.....36	Wheel (Bolts).....178-181
Steel Pulleys.....266	Wheel Bearing Assortment.....39
Steel Wheels96-100	Wheel Bearings129-135
Steering Cable.....72	Wheel and Deck Accessories.....155-201
Steering Segments180	Wheelbarrow Wheel Assembly115
Steering Wheels83	Wheels (Deck).....103-107
Sticker (Bumper).....1242	Wheels (Grinding)1087-1089
Straps (Tiedown).....1125	Wheels (Plastic)101-107
String Trimmer Line and Accessories637-661	Wheels (Steel).....96-100
Superlift Blades314-316	Wheels (Steering).....83
Switch (Kill).....85	White Bin Boxes1239
Switch (Stop)1070	Winch Cable72
Switch (Toggle).....1070	Wingnut Assortment41
	Wire (Electrical).....1058
T	Wire Connectors.....1059
TShirts (Rotary).....1242	Wire Wheel.....1087
TWrenches.....1134	Woodruff Key Assortment.....40
Tensioners (Chain saw).....1214	
Throttle Accessories74-75	Y
Throttle Controls.....56-78	Yoke Spacers143-148
Throttle Controls (Trimmer)75-77	Yokes.....156-157
Throttle Lever55-78	
Tie Down Straps1125	
Tiller Parts666-667	
Tiller Tines666-667	
Tine Pin Assortment44	
Tine Springs314	
Tire Chains1227	
Tire Gauge.....1097	
Tire Pumps1098	
Tire Sealer1098	
Tires (ATV)126-127	
Tires, Tubes.....96-127	
Toggle Switch1070	
Tools.....1082-1115	
Transistorized Ignition1074	
Trimmer Line (Diamond Cut).....636-638	
Trimmer Line (Green Quad).....637	
Trimmer Line (Green QuadTex)637	
Trimmer Line (Red)636	
Trimmer Line (Vortex).....638	
Trimmer Line Cut Lengths.....638-639	
Trimmer Line Cutter.....637	

For Parts Call 606-678-9623 or 606-561-4983



The most complete line of outdoor power equipment parts you'll find anywhere!

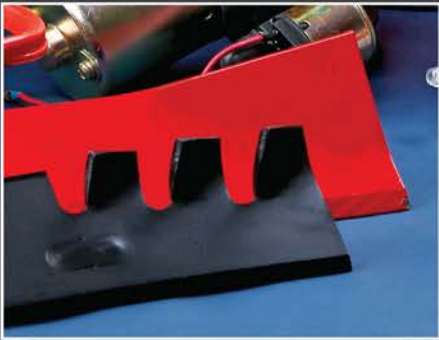

Serving the outdoor power equipment industry since 1957.

www.mymowerparts.com